

**In accordance with the requirements of Report and Order:
FCC 47 CFR Part 2 (2.1093) ; RSS102 issue 5;
IEEE 1528 :2013**

SAR TEST REPORT

For

Product Name: Tablet Computer

Brand Name : acer

Marketing name:B3-A40

Model No.: A7001

Series Model: N/A

Test Report Number: C170412S01-SF

Issued for

Acer Incorporated

8F, 88, Sec 1, Xintai 5th Rd. Xizhi, New Taipei City 221 Taiwan, R.O.C

Issued by

Compliance Certification Services Inc.

Kun shan Laboratory

**No.10 Weiye Rd., Innovation park, Eco&Tec,
Development Zone, Kunshan City, Jiangsu, China**

TEL: 86-512-57355888

FAX: 86-512-57370818



Note: This report shall not be reproduced except in full, without the written approval of Compliance Certification Services Inc. This document may be altered or revised by Compliance Certification Services Inc. personnel only, and shall be noted in the revision section of the document. The client should not use it to claim product endorsement by A2LA or any government agencies. The test results in the report only apply to the tested sample.

Revision History

Revision	REPORT NO.	Date	Page Revised	Contents
Original	C170412S01-SF	April 25, 2017	N/A	N/A
01	C170412S01-SF	May 12, 2017	All Report	Add test data with haopeng Battery.
02	C170412S01-SF	May 16, 2017	All Report	<ol style="list-style-type: none">1、 Update Bluetooth Conducted output power table and ISED SAR evaluation.2、 Update SAR test exclusion Thresholds table.3、 Delete the SAR evaluation for the front surface.

TABLE OF CONTENTS

1. CERTIFICATE OF COMPLIANCE (SAR EVALUATION)	4
2. EUT DESCRIPTION	5
2.1 STATEMENT OF COMPLIANCE.....	6
3. REQUIREMENTS FOR COMPLIANCE TESTING DEFINED BY THE FCC	7
4. TEST METHODOLOGY	7
5. TEST CONFIGURATION	7
6. DOSIMETRIC ASSESSMENT SETUP	8
6.1 MEASUREMENT SYSTEM DIAGRAM.....	9
6.2 SYSTEM COMPONENTS.....	10
7. EVALUATION PROCEDURES	13
8. MEASUREMENT UNCERTAINTY	17
9. EXPOSURE LIMIT	21
10. EUT ARRANGEMENT	22
10.1 BODY WORN TEST.....	22
11. MEASUREMENT RESULTS	23
11.1 TEST LIQUIDS CONFIRMATION	23
11.2 LIQUID MEASUREMENT RESULTS	24
11.3 SYSTEM PERFORMANCE CHECK	25
11.4 EUT TUNE-UP PROCEDURES AND TEST MODE.....	28
11.5 SAR TEST CONFIGURATIONS.....	33
11.6 BODY TEST EXCLUSION THRESHOLDS	34
11.7 EUT SETUP PHOTOS	36
11.8 BODY SAR TEST CONFIGURATION.....	36
11.9 REPEATED SAR MEASUREMENT	40
11.10 SAR HANDSETS MULTI XMITER ASSESSMENT.....	41
12. EUT PHOTO	42
13. EQUIPMENT LIST & CALIBRATION STATUS	47
14. FACILITIES	48
15. REFERENCES	48
Appendix A: Plots of Performance Check	49
Appendix B: Plots of SAR Test Result	59
Appendix C: DASYS Calibration Certificate	59

1. CERTIFICATE OF COMPLIANCE (SAR EVALUATION)

Product Name:	Tablet Computer
Brand Name:	acer
Model Name.:	A7001
Series Model:	N/A
Device Category:	PROTABLE DEVICES
Exposure Category:	GENERAL POPULATION/UNCONTROLLED EXPOSURE
Date of Test:	April 18, 2017 & April 19, 2017 & May 12, 2017 & May 16, 2017
Applicant:	Acer Incorporated 8F, 88, Sec 1, Xintai 5th Rd. Xizhi, New Taipei City 221 Taiwan, R.O.C
Manufacturer:	Acer Incorporated 8F, 88, Sec 1, Xintai 5th Rd. Xizhi, New Taipei City 221 Taiwan, R.O.C
Application Type:	Certification

APPLICABLE STANDARDS AND TEST PROCEDURES

STANDARDS AND TEST PROCEDURES	TEST RESULT
ANSI/IEEE C95.1-1992 RSS102 issue 5	No non-compliance noted

Deviation from Applicable Standard

None

The device was tested by Compliance Certification Services Inc. in accordance with the measurement methods and procedures specified in KDB 865664; RSS102 issue 5 The test results in this report apply only to the tested sample of the stated device/equipment. Other similar device/equipment will not necessarily produce the same results due to production tolerance and measurement uncertainties.

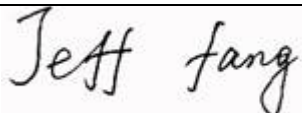
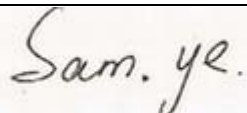
Approved by:	Tested by:
	
Jeff.fang RF Manager Compliance Certification Services Inc.	Sam.ye Test Engineer Compliance Certification Services Inc.

2. EUT DESCRIPTION

Product Name:	Tablet Computer	
Brand Name:	acer	
Marketing name:	B3-A40	
Model Name.:	A7001	
Series Model:	N/A	
Model Discrepancy:	N/A	
FCC ID:	HLZA7001	
ISED No.:	1754F-A7001	
Software version	Acer_AV0N0_B3-A40_RV00RC00_WW_GEN1	
Hardware version	A10L2_MB_V2.1	
Power reduction:	NO	
DTM Description:	N/A	
Device Category:	Production unit	
Frequency Range:	WLAN 2.4GHz Band: 2412 MHz ~ 2462 MHz WLAN 5.2GHz Band: 5180 MHz ~ 5240 MHz WLAN 5.3GHz Band: 5240 MHz ~ 5320 MHz WLAN 5.5GHz Band: 5470 MHz ~ 5700 MHz WLAN 5.8GHz Band: 5745 MHz ~ 5825 MHz Bluetooth: 2402 MHz ~ 2480 MHz	
Modulation Technique:	IEEE 802.11a: OFDM IEEE 802.11n5G HT20 MHz Mode: OFDM IEEE 802.11n5G HT40 MHz Mode: OFDM IEEE 802.11ac HT80 MHz Mode: OFDM IEEE 802.11b: DSSS (CCK, DQPSK, DBPSK) IEEE 802.11g/n: OFDM (QPSK, BPSK, 16-QAM, 64-QAM) Bluetooth 3.0: GFSK + $\pi/4$ DQPSK+8DPSK Bluetooth 4.1 : GFSK	
Bluetooth specification:	V2.1+EDR, 3.0+HS, v4.1+HS compliant	
Accessories:	Battery(rating): Brand Name: TCL Model Name:PR-279594N Capacitance: 6100 mAh; Rated Voltage: 3.7V	Battery(rating): Brand Name: haopeng Model Name:HPP279594AB Capacitance: 6100 mAh; Rated Voltage: 3.7V
Antenna Specification:	WIFI/ Bluetooth: FPC antenna	
Operating Mode:	Maximum continuous output	

2.1 STATEMENT OF COMPLIANCE

The maximum results of Specific Absorption Rate (SAR) found during testing for **Tablet Computer, A7001**, are as follows.

Equipment Class	Frequency Band	Highest SAR Summary
		Body 1g SAR (W/kg)
DTS	2.4GHz WLAN	1.118
NII	5.2GHz WLAN	--
	5.3GHz WLAN	1.173
	5.5GHz WLAN	1.198
	5.8GHz WLAN	1.179
DSSS(BT)	2.4GHz	0.179

exposure limits (1.6 W/kg) specified in FCC 47 CFR part 2 (2.1093) and ANSI/IEEE C95.1-1992, and had been tested in accordance with the measurement methods and procedures specified in IEEE 1528-2013.

3. REQUIREMENTS FOR COMPLIANCE TESTING DEFINED BY THE FCC

The order requires routine SAR evaluation prior to equipment authorization of portable transmitter devices, including portable telephones. For consumer products, the applicable limit is 1.6 W/Kg for an uncontrolled environment and 8.0 W/Kg for an occupational/controlled environment as recommended by the FCC 47 CFR Part 2 (2.1093); RSS102 issue 5.

4. TEST METHODOLOGY

The Specific Absorption Rate (SAR) testing specification, method and procedure for this device is in accordance with the following standards:

- FCC 47 CFR Part 2 (2.1093)
- RSS102 issue 5
- IEEE 1528: 2013
- KDB 248227 D01v02r02 802.11 Wi-Fi SAR
- KDB 447498 D01v06 General RF Exposure Guidance
- KDB 865664 D01v01r04 Measurement 100 MHz to 6 GHz
- KDB 865664 D02v01r02 RF Exposure Reporting
- KDB 616217 D04 v01r02 SAR for laptop and tablets

5. TEST CONFIGURATION

During WLAN SAR testing EUT is configured with the WLAN continuous TX tool, and the transmission duty factor was monitored on the spectrum analyzer with zero-span setting

For WLAN SAR testing, WLAN engineering test software installed on the EUT can provide continuous transmitting RF signal.

Duty cycle Form

Band	Mode	Duty cycle(100%)
2.4GHz	Bluetooth	100
	802.11b	100
	802.11g	100
	802.11n 20MHz	100
	802.11n 40MHz	100
5GHz	802.11a	100
	802.11 20MHz	100
	802.11 40MHz	100

6. DOSIMETRIC ASSESSMENT SETUP

These measurements were performed with the automated near-field scanning system DASY 5 from ATTENNESSA. The system is based on a high precision robot (working range greater than 0.9 m), which positions the probes with a positional repeatability of better than ± 0.02 mm. Special E- and H-field probes have been developed for measurements close to material discontinuity, the sensors of which are directly loaded with a Schottky diode and connected via highly resistive lines to the data acquisition unit. The SAR measurements were conducted with the E-field PROBE EX3DV4 (manufactured by SPEAG), designed in the classical triangular configuration and optimized for dosimetric evaluation. The probe has been calibrated according to the procedure described in [7] with accuracy of better than $\pm 10\%$. The spherical isotropy was evaluated with the procedure described in [8] and found to be better than ± 0.25 dB. The phantom used was the SAM Twin Phantom as described in FCC supplement C, IEEE P1528.

The following table gives the recipes for tissue simulating liquids.

Ingredients (% by weight)	Frequency (MHz)									
	450		835		915		1900		2450	
Tissue Type	Head	Body	Head	Body	Head	Body	Head	Body	Head	Body
Water	38.56	51.16	41.45	52.4	41.05	56.0	54.9	40.4	62.7	73.2
Salt (NaCl)	3.95	1.49	1.45	1.4	1.35	0.76	0.18	0.5	0.5	0.04
Sugar	56.32	46.78	56.0	45.0	56.5	41.76	0.0	58.0	0.0	0.0
HEC	0.98	0.52	1.0	1.0	1.0	1.21	0.0	1.0	0.0	0.0
Bactericide	0.19	0.05	0.1	0.1	0.1	0.27	0.0	0.1	0.0	0.0
Triton X-100	0.0	0.0	0.0	0.0	0.0	0.0	0.0	0.0	36.8	0.0
DGBE	0.0	0.0	0.0	0.0	0.0	0.0	44.92	0.0	0.0	26.7
Dielectric Constant	43.42	58.0	42.54	56.1	42.0	56.8	39.9	54.0	39.8	52.5
Conductivity (S/m)	0.85	0.83	0.91	0.95	1.0	1.07	1.42	1.45	1.88	1.78

6.1 MEASUREMENT SYSTEM DIAGRAM

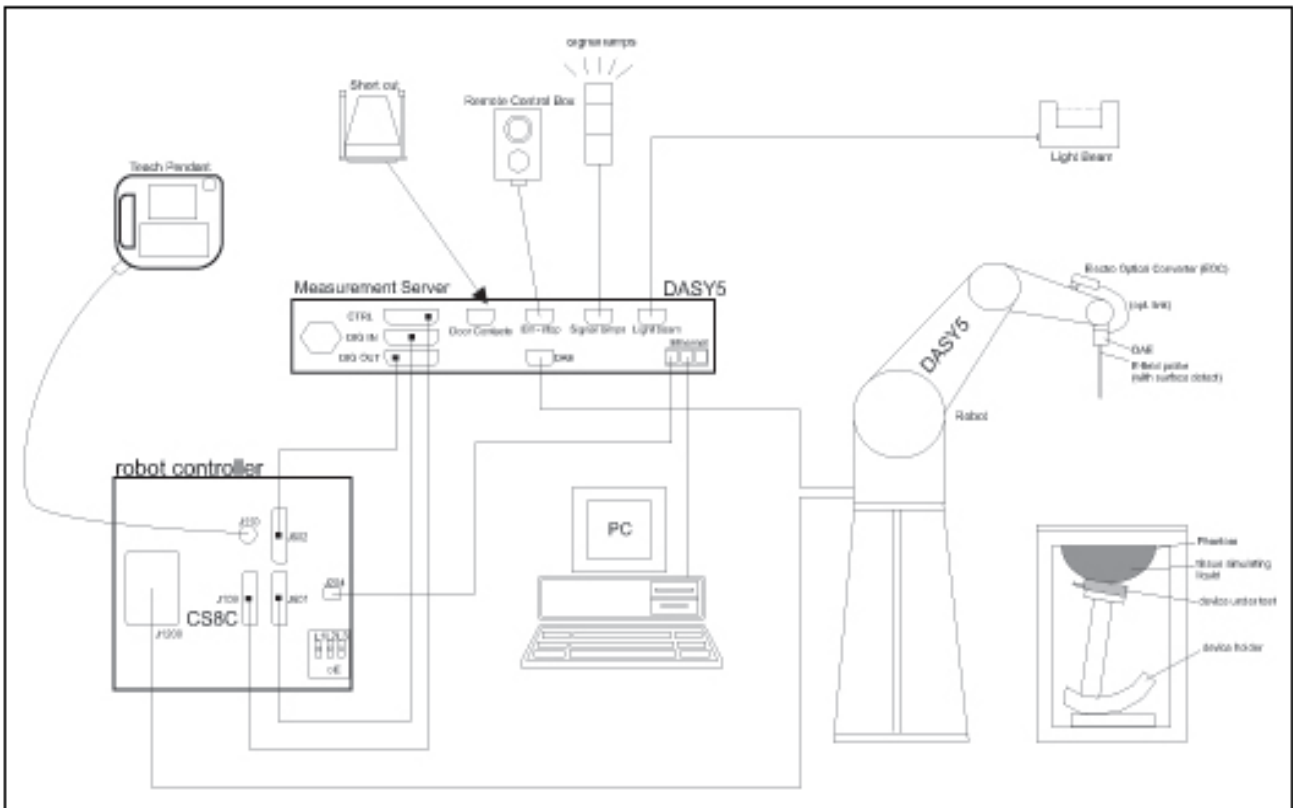

The DASYS system for performing compliance tests consists of the following items:

- A standard high precision 6-axis robot (Stäubli RX family) with controller, teach pendant and software. An arm extension for accommodating the data acquisition electronics (DAE).
- A dosimetric probe, i.e., an isotropic E-field probe optimized and calibrated for usage in tissue simulating liquid. The probe is equipped with an optical surface detector system.
- A data acquisition electronics (DAE) which performs the signal amplification, signal multiplexing, AD-conversion, offset measurements, mechanical surface detection, collision detection, etc. The unit is battery powered with standard or rechargeable batteries. The signal is optically transmitted to the EOC.
- The Electro-optical converter (EOC) performs the conversion between optical and electrical of the signals for the digital communication to the DAE and for the analog signal from the optical surface detection. The EOC is connected to the measurement server.
- The function of the measurement server is to perform the time critical tasks such as signal filtering, control of the robot operation and fast movement interrupts.
- A probe alignment unit which improves the (absolute) accuracy of the probe positioning.
- A computer operating Windows 7.
- DASYS software.
- Remote control with teach pendant and additional circuitry for robot safety such as warning lamps, etc.
- The SAM twin phantom enabling testing left-hand and right-hand usage.
- The device holder for handheld mobile phones.
- Tissue simulating liquid mixed according to the given recipes.
- Validation dipole kits allowing validating the proper functioning of the system.

6.2 SYSTEM COMPONENTS



The DASY5 measurement server is based on a PC/104 CPU board with a 400MHz intel ULV celeron, 128MB chip-disk and 128 MB RAM. The necessary circuits for communication with either the DAE4(or DAE3) electronic box as well as the 16-bit AD-converter system for optical detection and digital I/O interface are contained on the DASY5 I/O-board, which is directly connected to the PC/104 bus of the CPU board.

The measurement server performs all real-time data evaluation for field measurements and surface detection, controls robot movements and handles safety operation.



The PC-operating system cannot interfere with these time critical processes. All connections are supervised by a watchdog, and disconnection of any of the cables to the measurement server will automatically disarm the robot and disable all program-controlled robot movements. Furthermore, the measurement server is equipped with two expansion slots which are reserved for future applications. Please note that the expansion slots do not have a standardized pinout and therefore only the expansion cards provided by SPEAG can be inserted. Expansion cards from any other supplier could seriously damage the measurement server. Calibration: No calibration required.

Data Acquisition Electronics (DAE)

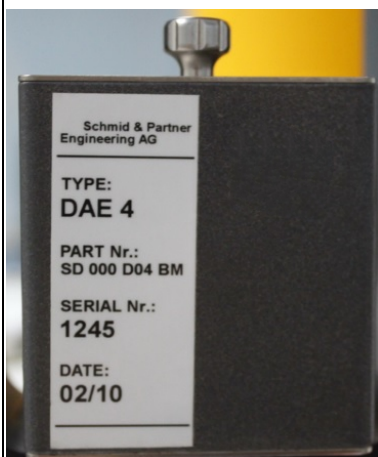

The data acquisition electronics (DAE4) consists of a highly sensitive electrometer grade preamplifier with auto-zeroing, a channel and gain-switching multiplexer, a fast 16 bit AD converter and a command decoder and control logic unit. Transmission to the measurement server is accomplished through an optical downlink for data and status information as well as an optical uplink for commands and the clock. The mechanical probe mounting device includes two different sensor systems for frontal and sideways probe contacts. They are used for mechanical surface detection and probe collision detection. The input impedance of the DAE4 box is 200MOhm; the inputs are symmetrical and floating. Common mode rejection is above 80 dB.

EX3DV4 Isotropic E-Field Probe for Dosimetric Measurements



Construction: Symmetrical design with triangular core
 Built-in shielding against static charges
 PEEK enclosure material (resistant to organic solvents, e.g., DGBE)

Calibration: Basic Broad Band Calibration in air: 10-3000 MHz.
 Conversion Factors (CF) for HSL 900 and HSL 1800
 CF-Calibration for other liquids and frequencies upon request.

Frequency: 10 MHz to > 6 GHz; Linearity: ± 0.2 dB (30 MHz to 3 GHz)

Directivity: ± 0.3 dB in HSL (rotation around probe axis)
 ± 0.5 dB in HSL (rotation normal to probe axis)

Dynamic Range: 10 μ W/g to > 100 mW/g; Linearity: ± 0.2 dB
 (noise: typically < 1 μ W/g)

Dimensions: Overall length: 337 mm (Tip: 9 mm)
 Tip diameter: 2.5 mm (Body: 10 mm)
 Distance from probe tip to dipole centers:
 1 mm

Application: High precision dosimetric measurements in any exposure scenario (e.g., very strong gradient fields). Only probe which enables compliance testing for frequencies up to 6 GHz with precision of better 30%.



Interior of probe

SAM Twin Phantom

Construction:

The shell corresponds to the specifications of the Specific Anthropomorphic Mannequin (SAM) phantom defined in IEEE 1528-200X, CENELEC 50360 and IEC 62209. It enables the dosimetric evaluation of left and right hand phone usage as well as body mounted usage at the flat phantom region. A cover prevents evaporation of the liquid. Reference markings on the phantom allow the complete setup of all predefined phantom positions and measurement grids by manually teaching three points with the robot.



Shell Thickness: 2 ±0.2 mm

Filling Volume: Approx. 25 liters

Dimensions: Height: 850mm; Length: 1000mm; Width: 750mm

SAM Phantom (ELI4 v4.0)

Description Construction:

Phantom for compliance testing of handheld and body-mounted wireless devices in the frequency range of 30 MHz to 6 GHz. ELI4 is fully compatible with the latest draft of the standard IEC 62209 Part II and all known tissue simulating liquids. ELI4 has been optimized regarding its performance and can be integrated into our standard phantom tables. A cover prevents evaporation of the liquid. Reference markings on the phantom allow installation of the complete setup, including all predefined phantom positions and measurement grids, by teaching three points. The phantom is supported by software version DASY4/DASY5.5 and higher and is compatible with all SPEAG dosimetric probes and dipoles



Shell Thickness: 2.0 ± 0.2 mm (sagging: <1%)

Filling Volume: Approx. 25 liters

Dimensions: Major ellipse axis: 600 mm

Minor axis: 400 mm 500mm

Device Holder for SAM Twin Phantom

Construction: In combination with the Twin SAM Phantom, the Mounting Device (made from POM) enables the rotation of the mounted transmitter in spherical coordinates, whereby the rotation point is the ear opening. The devices can be easily and accurately positioned according to IEC, IEEE, CENELEC, FCC or other specifications. The device holder can be locked at different phantom locations (left head, right head, and flat phantom).



System Validation Kits for SAM Twin Phantom

Construction: Symmetrical dipole with 1/4 balun Enables measurement of feedpoint impedance with NWA Matched for use near flat phantoms filled with brain simulating solutions Includes distance holder and tripod adaptor.

Frequency: 900, 1800, 2450, 5800 MHz

ReTune loss: > 20 dB at specified validation position

Power capability: > 100 W (f < 1GHz); > 40 W (f > 1GHz)

Dimensions:

- D835V2: dipole length: 161 mm; overall height: 340 mm
- D1800V2: dipole length: 72.5 mm; overall height: 300 mm
- D1900V2: dipole length: 67.7 mm; overall height: 300 mm
- D2450V2: dipole length: 51.5 mm; overall height: 290 mm
- D5GHzV2: dipole length: 20.6 mm; overall height: 300mm



System Validation Kits for ELI4 phantom

Construction: Symmetrical dipole with 1/4 balun Enables measurement of feedpoint impedance with NWA Matched for use near flat phantoms filled with brain simulating solutions Includes distance holder and tripod adaptor.

Frequency: 900, 1800, 2450, 5800 MHz

ReTune loss: > 20 dB at specified validation position

Power capability: > 100 W (f < 1GHz); > 40 W (f > 1GHz)

Dimensions:

- D835V2: dipole length: 161 mm; overall height: 340 mm
- D1800V2: dipole length: 72.5 mm; overall height: 300 mm
- D1900V2: dipole length: 67.7 mm; overall height: 300 mm
- D2450V2: dipole length: 51.5 mm; overall height: 290 mm
- D5GHzV2: dipole length: 20.6 mm; overall height: 300 mm



7. EVALUATION PROCEDURES

DATA EVALUATION

The DASY 5 post processing software automatically executes the following procedures to calculate the field units from the microvolt readings at the probe connector. The parameters used in the evaluation are stored in the configuration modules of the software:

Probe parameters:	- Sensitivity	$Norm_i, a_{i0}, a_{i1}, a_{i2}$
	- Conversion factor	$ConvF_i$
	- Diode compression point	dcp_i
Device parameters:	- Frequency	f
	- Crest factor	cf
Media parameters:	- Conductivity	σ
	- Density	ρ

These parameters must be set correctly in the software. They can be found in the component documents or be imported into the software from the configuration files issued for the DASY 5 components. In the direct measuring mode of the multi-meter option, the parameters of the actual system setup are used. In the scan visualization and export modes, the parameters stored in the corresponding document files are used.

The first step of the evaluation is a linearization of the filtered input signal to account for the compression characteristics of the detector diode. The compensation depends on the input signal, the diode type and the DC-transmission factor from the diode to the evaluation electronics. If the exciting field is pulsed, the crest factor of the signal must be known to correctly compensate for peak power. The formula for each channel can be given as:

$$V_i = U_i + U_i^2 \cdot \frac{cf}{dcp_i}$$

with	V_i	= Compensated signal of channel i (i = x, y, z)
	U_i	= Input signal of channel i (i = x, y, z)
	cf	= Crest factor of exciting field (DASY 5 parameter)
	dcp_i	= Diode compression point (DASY 5 parameter)

From the compensated input signals the primary field data for each channel can be evaluated:

E-field probes:
$$E_i = \sqrt{\frac{V_i}{Norm_i \cdot ConvF}}$$

H-field probes:
$$H_i = \sqrt{V_i} \cdot \frac{a_{i10} + a_{i11}f + a_{i12}f^2}{f}$$

with	V_i	= Compensated signal of channel i (i = x, y, z)
	$Norm_i$	= Sensor sensitivity of channel i (i = x, y, z) $\mu V / (V/m)^2$ for E0field Probes
	$ConvF$	= Sensitivity enhancement in solution
	a_{ij}	= Sensor sensitivity factors for H-field probes
	f	= Carrier frequency (GHz)
	E_i	= Electric field strength of channel i in V/m
	H_i	= Magnetic field strength of channel i in A/m

The RSS value of the field components gives the total field strength (Hermitian magnitude):

$$E_{tot} = \sqrt{E_x^2 + E_y^2 + E_z^2}$$

The primary field data are used to calculate the derived field units.

$$SAR = E_{tot}^2 \cdot \frac{\sigma}{\rho \cdot 1000}$$

- with SAR = local specific absorption rate in mW/g
 E_{tot} = total field strength in V/m
 σ = conductivity in [mho/m] or [Siemens/m]
 ρ = equivalent tissue density in g/cm³

Note that the density is normally set to 1 (or 1.06), to account for actual brain density rather than the density of the simulation liquid.

The power flow density is calculated assuming the excitation field as a free space field.

$$P_{pwe} = \frac{E_{tot}^2}{3770} \quad \text{or} \quad P_{pwe} = H_{tot}^2 \cdot 37.7$$

- with P_{pwe} = Equivalent power density of a plane wave in mW/cm²
 E_{tot} = total electric field strength in V/m
 H_{tot} = total magnetic field strength in A/m

SAR EVALUATION PROCEDURES

The procedure for assessing the peak spatial-average SAR value consists of the following steps:

- **Power Reference Measurement**

The reference and drift jobs are useful jobs for monitoring the power drift of the device under test in the batch process. Both jobs measure the field at a specified reference position, at a selectable distance from the phantom surface. The reference position can be either the selected section's grid reference point or a user point in this section. The reference job projects the selected point onto the phantom surface, orients the probe perpendicularly to the surface, and approaches the surface using the selected detection method.

- **Area Scan**

The area scan is used as a fast scan in two dimensions to find the area of high field values, before doing a finer measurement around the hot spot. The sophisticated interpolation routines implemented in DASY 5 software can find the maximum locations even in relatively coarse grids. The scan area is defined by an editable grid. This grid is anchored at the grid reference point of the selected section in the phantom. When the area scan's property sheet is brought-up, grid was at to 15 mm by 15 mm and can be edited by a user.

- **Zoom Scan**

Zoom scans are used to assess the peak spatial SAR values within a cubic averaging volume containing 1 g and 10 g of simulated tissue. The default zoom scan measures 5 x 5 x 7 points within a cube whose base faces are centered around the maximum found in a preceding area scan job within the same procedure. If the preceding Area Scan job indicates more than one maximum, the number of Zoom Scans has to be enlarged accordingly (The default number inserted is 1).

- **Power Drift measurement**

The drift job measures the field at the same location as the most recent reference job within the same procedure, and with the same settings. The drift measurement gives the field difference in dB from the reading conducted within the last reference measurement. Several drift measurements are possible for one reference measurement. This allows a user to monitor the power drift of the device under test within a batch process. In the properties of the Drift job, the user can specify a limit for the drift and have DASY 5 software stop the measurements if this limit is exceeded.

- **Z-Scan**

The Z Scan job measures points along a vertical straight line. The line runs along the Z-axis of a one-dimensional grid. A user can anchor the grid to the current probe location. As with any other grids, the local Z-axis of the anchor location establishes the Z-axis of the grid.

SPATIAL PEAK SAR EVALUATION

The procedure for spatial peak SAR evaluation has been implemented according to the IEEE1529 standard. It can be conducted for 1 g and 10 g.

The DASY 5 system allows evaluations that combine measured data and robot positions, such as:

- maximum search
- extrapolation
- boundary correction
- peak search for averaged SAR

During a maximum search, global and local maximum searches are automatically performed in 2-D after each Area Scan measurement with at least 6 measurement points. It is based on the evaluation of the local SAR gradient calculated by the Quadratic Shepard's method. The algorithm will find the global maximum and all local maxima within -2 dB of the global maxima for all SAR distributions.

Extrapolation

Extrapolation routines are used to obtain SAR values between the lowest measurement points and the inner phantom surface. The extrapolation distance is determined by the surface detection distance and the probe sensor offset. Several measurements at different distances are necessary for the extrapolation.

Extrapolation routines require at least 10 measurement points in 3-D space. They are used in the Cube Scan to obtain SAR values between the lowest measurement points and the inner phantom surface. The routine uses the modified Quadratic Shepard's method for extrapolation. For a grid using 5x5x7 measurement points with 5mm resolution amounting to 343 measurement points, the uncertainty of the extrapolation routines is less than 1% for 1 g and 10 g cubes.

Boundary effect

For measurements in the immediate vicinity of a phantom surface, the field coupling effects between the probe and the boundary influence the probe characteristics. Boundary effect errors of different dosimetric probe types have been analyzed by measurements and using a numerical probe model. As expected, both methods showed an enhanced sensitivity in the immediate vicinity of the boundary. The effect strongly depends on the probe dimensions and disappears with increasing distance from the boundary. The sensitivity can be approximately given as:

$$S \approx S_o + S_b \exp\left(-\frac{z}{a}\right) \cos\left(\pi \frac{z}{\lambda}\right)$$

Since the decay of the boundary effect dominates for small probes ($a \ll \lambda$), the cos-term can be omitted. Factors S_b (parameter Alpha in the DASY 5 software) and a (parameter Delta in the DASY 5 software) are assessed during probe calibration and used for numerical compensation of the boundary effect. Several simulations and measurements have confirmed that the compensation is valid for different field and boundary configurations.

This simple compensation procedure can largely reduce the probe uncertainty near boundaries. It works well as long as:

- the boundary curvature is small
- the probe axis is angled less than 30° to the boundary normal
- the distance between probe and boundary is larger than 25% of the probe diameter
- the probe is symmetric (all sensors have the same offset from the probe tip)

Since all of these requirements are fulfilled in a DASY 5 system, the correction of the probe boundary effect in the vicinity of the phantom surface is performed in a fully automated manner via the measurement data extraction during post processing.

8. MEASUREMENT UNCERTAINTY

Measurement uncertainty for 30 MHz to 3 GHz averaged over 1 gram

Uncertainty Component	Uncertainty	Prob.	Div.	$C_i(1g)$	Std. Unc. (1-g)	V_i or V_{eff}
Measurement System						
Probe Calibration ($k=1$)	6.00	Normal	1	1	6.00	∞
Probe Isotropy	4.70	Rectangular	$\sqrt{3}$	0.7	1.90	∞
Modulation Response	2.40	Rectangular	$\sqrt{3}$	1	1.39	∞
Hemispherical Isotropy	9.60	Rectangular	$\sqrt{3}$	0.7	3.88	∞
Boundary Effect	2.00	Rectangular	$\sqrt{3}$	1	1.15	∞
Linearity	4.70	Rectangular	$\sqrt{3}$	1	2.71	∞
System Detection Limit	1.00	Rectangular	$\sqrt{3}$	1	0.58	∞
Readout Electronics	0.30	Normal	1	1	0.30	∞
Response Time	0.80	Rectangular	$\sqrt{3}$	1	0.46	∞
Integration Time	2.60	Rectangular	$\sqrt{3}$	1	1.50	∞
RF Ambient Noise	3.00	Rectangular	$\sqrt{3}$	1	1.73	∞
RF Ambient Reflections	3.00	Rectangular	$\sqrt{3}$	1	1.73	∞
Probe Positioner	0.40	Rectangular	$\sqrt{3}$	1	0.23	∞
Probe Positioning	2.90	Rectangular	$\sqrt{3}$	1	1.67	∞
Max. SAR Evaluation	2.00	Rectangular	$\sqrt{3}$	1	1.15	∞
Test sample Related						
Test sample Positioning	2.9	Normal	1	1	2.9	145
Device Holder Uncertainty	3.6	Normal	1	1	3.6	5
Power drift	5	Rectangular	$\sqrt{3}$	1	2.89	∞
Power Scaling	0	Rectangular	$\sqrt{3}$	1	0.00	∞
Phantom and Tissue Parameters						
Phantom Uncertainty	6.1	Rectangular	$\sqrt{3}$	1	3.52	∞
SAR correction	1.9	Rectangular	$\sqrt{3}$	1	1.10	∞
Liquid Conductivity (target)	5	Rectangular	$\sqrt{3}$	0.64	1.85	∞
Liquid Conductivity (meas)	2.21	Rectangular	$\sqrt{3}$	0.78	1.00	∞
Liquid Permittivity (target)	5	Rectangular	$\sqrt{3}$	0.6	1.73	∞
Liquid Permittivity (meas)	-3.49	Rectangular	$\sqrt{3}$	0.26	-0.52	∞
Temp. unc. - Conductivity	3.4	Rectangular	$\sqrt{3}$	0.78	1.53	∞
Temp. unc. - Permittivity	0.4	Rectangular	$\sqrt{3}$	0.23	0.05	∞
Combined Std. Uncertainty		RSS			11.48	361
Expanded STD Uncertainty		$k=2$			22. 95%	
Expanded STD Uncertainty		$k=2$			1. 79dB	

Measurement uncertainty for 3 GHz to 6 GHz averaged over 1 gram

Uncertainty Component	Uncertainty	Prob.	Div.	$C_i(1g)$	Std. Unc. (1-g)	V_i or V_{eff}
Measurement System						
Probe Calibration ($k=1$)	6.55	Normal	1	1	6.55	∞
Probe Isotropy	4.70	Rectangular	$\sqrt{3}$	0.7	1.90	∞
Modulation Response	2.40	Rectangular	$\sqrt{3}$	1	1.39	∞
Hemispherical Isotropy	9.60	Rectangular	$\sqrt{3}$	0.7	3.88	∞
Boundary Effect	2.00	Rectangular	$\sqrt{3}$	1	1.15	∞
Linearity	4.70	Rectangular	$\sqrt{3}$	1	2.71	∞
System Detection Limit	1.00	Rectangular	$\sqrt{3}$	1	0.58	∞
Readout Electronics	0.30	Normal	1	1	0.30	∞
Response Time	0.80	Rectangular	$\sqrt{3}$	1	0.46	∞
Integration Time	2.60	Rectangular	$\sqrt{3}$	1	1.50	∞
RF Ambient Noise	3.00	Rectangular	$\sqrt{3}$	1	1.73	∞
RF Ambient Reflections	3.00	Rectangular	$\sqrt{3}$	1	1.73	∞
Probe Positioner	0.80	Rectangular	$\sqrt{3}$	1	0.46	∞
Probe Positioning	6.70	Rectangular	$\sqrt{3}$	1	3.87	∞
Max. SAR Evaluation	4.00	Rectangular	$\sqrt{3}$	1	2.31	∞
Test sample Related						
Test sample Positioning	2.9	Normal	1	1	2.9	145
Device Holder Uncertainty	3.6	Normal	1	1	3.6	5
Power drift	5	Rectangular	$\sqrt{3}$	1	2.89	∞
Power Scaling	0	Rectangular	$\sqrt{3}$	1	0.00	∞
Phantom and Tissue Parameters						
Phantom Uncertainty	6.6	Rectangular	$\sqrt{3}$	1	3.81	∞
SAR correction	1.9	Rectangular	$\sqrt{3}$	1	1.10	∞
Liquid Conductivity (target)	5	Rectangular	$\sqrt{3}$	0.64	1.85	∞
Liquid Conductivity (meas)	-3.83	Rectangular	$\sqrt{3}$	0.78	-1.72	∞
Liquid Permittivity (target)	5	Rectangular	$\sqrt{3}$	0.6	1.73	∞
Liquid Permittivity (meas)	-3.92	Rectangular	$\sqrt{3}$	0.26	-0.59	∞
Temp. unc. - Conductivity	3.4	Rectangular	$\sqrt{3}$	0.78	1.53	∞
Temp. unc. - Permittivity	0.4	Rectangular	$\sqrt{3}$	0.23	0.05	∞
Combined Std. Uncertainty		RSS			12.61	748
Expanded STD Uncertainty		$k=2$			25. 23%	
Expanded STD Uncertainty		$k=2$			1. 95dB	

Measurement uncertainty for 30 MHz to 3 GHz averaged over 1 gram

Uncertainty Component	Uncertainty	Prob.	Div.	$C_i(1g)$	Std. Unc. (1-g)	V_i or V_{eff}
Measurement System						
Probe Calibration ($k=1$)	6.00	Normal	1	1	6.0	∞
Axial Isotropy	4.70	Rectangular	$\sqrt{3}$	0.7	1.9	∞
Hemispherical Isotropy	9.60	Rectangular	$\sqrt{3}$	0.7	3.9	∞
Boundary Effect	1.00	Rectangular	$\sqrt{3}$	1	0.6	∞
Linearity	4.70	Rectangular	$\sqrt{3}$	1	2.7	∞
System Detection Limit	1.00	Rectangular	$\sqrt{3}$	1	0.6	∞
Readout Electronics	0.30	Normal	1	1	0.3	∞
Response Time	0.80	Rectangular	$\sqrt{3}$	0	0.0	∞
Integration Time	2.60	Rectangular	$\sqrt{3}$	0	0.0	∞
RF Ambient Noise	3.00	Rectangular	$\sqrt{3}$	1	1.7	∞
RF Ambient Reflections	3.00	Rectangular	$\sqrt{3}$	1	1.7	∞
Probe Positioner	0.40	Rectangular	$\sqrt{3}$	1	0.2	∞
Probe Positioning	2.90	Rectangular	$\sqrt{3}$	1	1.7	∞
Max. SAR Evaluation	1.00	Rectangular	$\sqrt{3}$	1	0.6	∞
System validation source (dipole)						
Deviation of experimental dipole from numerical dipole	5	Normal	1	1	5.0	∞
Dipole axis to liquid distance	2	Rectangular	$\sqrt{3}$	1	1.2	∞
Input power and SAR drift	4.7	Rectangular	$\sqrt{3}$	1	2.7	∞
Phantom and Tissue Parameters						
Phantom Uncertainty	4	Rectangular	$\sqrt{3}$	1	2.3	∞
SAR correction	1.9	Rectangular	1	1	1.9	∞
Liquid Conductivity (meas)	2.21	Rectangular	1	0.78	1.72	∞
Liquid Permittivity (meas)	-3.49	Rectangular	1	0.23	-0.80	∞
Temp. unc. - Conductivity	1.7	Rectangular	$\sqrt{3}$	0.78	0.77	∞
Temp. unc. - Permittivity	0.3	Rectangular	$\sqrt{3}$	0.23	0.04	∞
Combined Std. Uncertainty		RSS			10.9	361
Expanded STD Uncertainty		$k=2$			21.80%	
Expanded STD Uncertainty		$k=2$			1.71dB	

Measurement uncertainty for 3G to 6 GHz averaged over 1 gram

Uncertainty Component	Uncertainty	Prob.	Div.	$C_i(1g)$	Std. Unc. (1-g)	V_i or V_{eff}
Measurement System						
Probe Calibration ($k=1$)	6.00	Normal	1	1	6.0	∞
Axial Isotropy	4.70	Rectangular	$\sqrt{3}$	0.7	1.9	∞
Hemispherical Isotropy	9.60	Rectangular	$\sqrt{3}$	0.7	3.9	∞
Boundary Effect	1.00	Rectangular	$\sqrt{3}$	1	0.6	∞
Linearity	4.70	Rectangular	$\sqrt{3}$	1	2.7	∞
System Detection Limit	1.00	Rectangular	$\sqrt{3}$	1	0.6	∞
Readout Electronics	0.30	Normal	1	1	0.3	∞
Response Time	0.80	Rectangular	$\sqrt{3}$	1	0.5	∞
Integration Time	2.60	Rectangular	$\sqrt{3}$	1	1.5	∞
RF Ambient Noise	3.00	Rectangular	$\sqrt{3}$	1	1.7	∞
RF Ambient Reflections	3.00	Rectangular	$\sqrt{3}$	1	1.7	∞
Probe Positioner	0.40	Rectangular	$\sqrt{3}$	1	0.2	∞
Probe Positioning	2.90	Rectangular	$\sqrt{3}$	1	1.7	∞
Max. SAR Evaluation	1.00	Rectangular	$\sqrt{3}$	1	0.6	∞
System validation source (dipole)						
Deviation of experimental dipole from numerical dipole	5	Normal	1	1	5.0	∞
Dipole axis to liquid distance	2	Rectangular	$\sqrt{3}$	1	1.2	∞
Input power and SAR drift	4.7	Rectangular	$\sqrt{3}$	1	2.7	∞
Phantom and Tissue Parameters						
Phantom Uncertainty	4	Rectangular	$\sqrt{3}$	1	2.3	∞
SAR correction	1.9	Rectangular	1	1	1.9	∞
Liquid Conductivity (meas)	-3.83	Rectangular	1	0.78	-2.99	∞
Liquid Permittivity (meas)	-3.92	Rectangular	1	0.23	-0.90	∞
Temp. unc. - Conductivity	1.7	Rectangular	$\sqrt{3}$	0.78	0.77	∞
Temp. unc. - Permittivity	0.3	Rectangular	$\sqrt{3}$	0.23	0.04	∞
Combined Std. Uncertainty		RSS			11.3	361
Expanded STD Uncertainty		$k=2$			22.57%	
Expanded STD Uncertainty		$k=2$			1.77dB	

9. EXPOSURE LIMIT

(A). Limits for Occupational/Controlled Exposure (W/kg)

Whole-Body	Partial-Body	Hands, Wrists, Feet and Ankles
0.4	8.0	20.0

(B). Limits for General Population/Uncontrolled Exposure (W/kg)

Whole-Body	Partial-Body	Hands, Wrists, Feet and Ankles
0.08	1.6	4.0

Note: Whole-Body SAR is averaged over the entire body, partial-body SAR is averaged over any 1gram of tissue defined as a tissue volume in the shape of a cube. SAR for hands, wrists, feet and ankles is averaged over any 10 grams of tissue defined as a tissue volume in the shape of a cube.

Population/Uncontrolled Environments are defined as locations where there is the exposure of individuals who have no knowledge or control of their exposure.

Occupational/Controlled Environments are defined as locations where there is exposure that may be incurred by people who are aware of the potential for exposure, (i.e. as a result of employment or occupation).

NOTE
GENERAL POPULATION/UNCONTROLLED EXPOSURE
PARTIAL BODY LIMIT
1.6 W/kg

10. EUT ARRANGEMENT

Please refer to IEEE1528 illustration below.

10.1 BODY WORN TEST

This EUT was tested in four different positions. They are front side, rear side, Edge 1 and Edge 4 of tablet. In these positions, the surface of EUT is touching phantom with 0 mm.

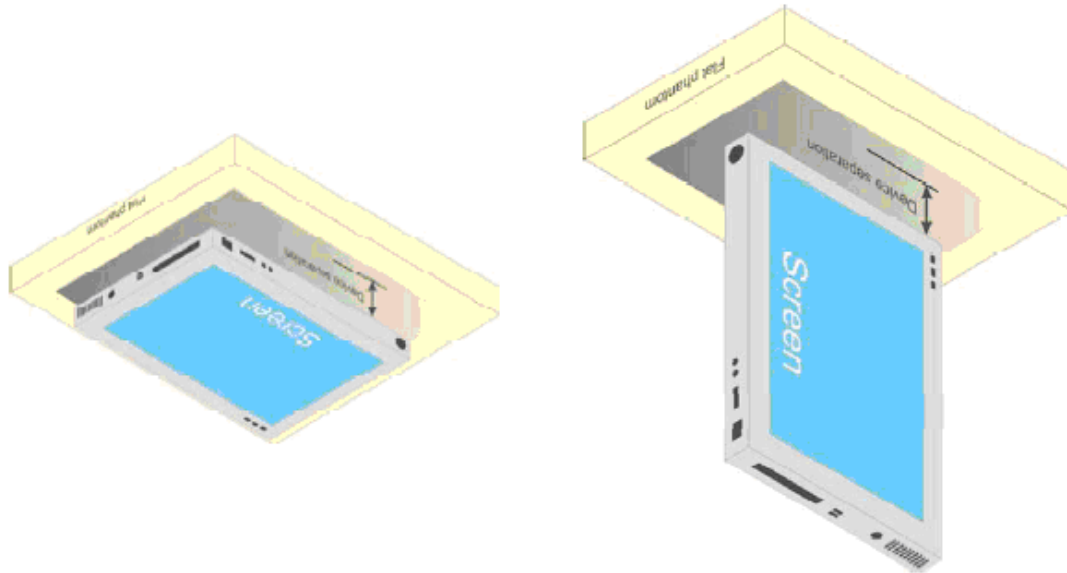

Fig Illustration for Lap-touching Position

11. MEASUREMENT RESULTS

11.1 TEST LIQUIDS CONFIRMATION

SIMULATED TISSUE LIQUID PARAMETER CONFIRMATION

The dielectric parameters were checked prior to assessment using the HP85070C dielectric probe kit. The dielectric parameters measured are reported in each correspondent section.

IEEE SCC-34/SC-2 P1528 RECOMMENDED TISSUE DIELECTRIC PARAMETERS

The head tissue dielectric parameters recommended by the IEEE SCC-34/SC-2 in P1528 have been incorporated in the following table. These head parameters are derived from planar layer models simulating the highest expected SAR for the dielectric properties and tissue thickness variations in a human head. Other head and body tissue parameters that have not been specified in P1528 are derived from the tissue dielectric parameters computed from the 4-Cole-Cole equations and extrapolated according to the head parameters specified in P1528

Target Frequency (MHz)	Head		Body	
	ϵ_r	σ (S/m)	ϵ_r	σ (S/m)
150	52.3	0.76	61.9	0.80
300	45.3	0.87	58.2	0.92
450	43.5	0.87	56.7	0.94
835	41.5	0.90	55.2	0.97
900	41.5	0.97	55.0	1.05
915	41.5	0.98	55.0	1.06
1450	40.5	1.20	54.0	1.30
1610	40.3	1.29	53.8	1.40
1800-2000	40.0	1.40	53.3	1.52
2450	39.2	1.80	52.7	1.95
3000	38.5	2.40	52.0	2.73
5800	45.3	5.27	48.2	6.00

(ϵ_r = relative permittivity, σ = conductivity and $\rho = 1000 \text{ kg/m}^3$)

11.2 LIQUID MEASUREMENT RESULTS

The following table show the measuring results for simulating liquid:

Liquid Type	Liquid Temp. (°C)	Parameters	Target	Measured	Deviation (%)	Limited (%)	Measured Date
Body2412	21.5	Permittivity(ϵ)	52.75	51.28	-2.79	± 5	2017-4-18
		Conductivity(σ)	1.90	1.88	-1.15	± 5	
Body2437	21.5	Permittivity(ϵ)	52.72	51.20	-2.87	± 5	2017-4-18
		Conductivity(σ)	1.93	1.91	-1.24	± 5	
Body2462	21.5	Permittivity(ϵ)	52.68	51.12	-2.97	± 5	2017-4-18
		Conductivity(σ)	1.97	1.94	-1.37	± 5	
Body5290	21.5	Permittivity(ϵ)	48.91	48.45	-0.93	± 5	2017-4-19
		Conductivity(σ)	5.45	5.37	-1.55	± 5	
Body5510	21.5	Permittivity(ϵ)	48.60	48.20	-0.84	± 5	2017-4-19
		Conductivity(σ)	5.69	5.48	-3.83	± 5	
Body5550	21.5	Permittivity(ϵ)	48.55	47.74	-1.66	± 5	2017-4-19
		Conductivity(σ)	5.74	5.70	-0.64	± 5	
Body5670	21.5	Permittivity(ϵ)	48.38	47.67	-1.46	± 5	2017-4-19
		Conductivity(σ)	5.86	5.90	0.57	± 5	
Body5755	21.5	Permittivity(ϵ)	48.26	47.32	-1.96	± 5	2017-4-19
		Conductivity(σ)	5.95	5.80	-2.50	± 5	
Body5795	21.5	Permittivity(ϵ)	48.21	47.78	-0.88	± 5	2017-4-19
		Conductivity(σ)	5.99	6.11	1.92	± 5	

Liquid Type	Liquid Temp. (°C)	Parameters	Target	Measured	Deviation (%)	Limited (%)	Measured Date
Body2462	21.5	Permittivity(ϵ)	52.68	51.65	-1.97	± 5	2017-5-12
		Conductivity(σ)	1.97	1.96	-0.15	± 5	
Body5670	21.5	Permittivity(ϵ)	48.38	46.48	-3.92	± 5	2017-5-12
		Conductivity(σ)	5.86	6.04	2.99	± 5	

Liquid Type	Liquid Temp. (°C)	Parameters	Target	Measured	Deviation (%)	Limited (%)	Measured Date
Body2402	21.5	Permittivity(ϵ)	52.76	51.16	-3.04	± 5	2017-5-16
		Conductivity(σ)	1.89	1.93	2.21	± 5	
Body2440	21.5	Permittivity(ϵ)	52.71	51.12	-3.03	± 5	2017-5-16
		Conductivity(σ)	1.94	1.96	1.24	± 5	
Body2480	21.5	Permittivity(ϵ)	52.66	50.83	-3.49	± 5	2017-5-16
		Conductivity(σ)	1.99	2.02	1.50	± 5	

11.3 SYSTEM PERFORMANCE CHECK

The system performance check is performed prior to any usage of the system in order to guarantee reproducible results. The system performance check verifies that the system operates within its specifications of $\pm 10\%$. The system performance check results are tabulated below. And also the corresponding SAR plot is attached as well in the SAR plots files.

System check is performed regularly on all frequency bands where tests are performed with the DASY5 system .

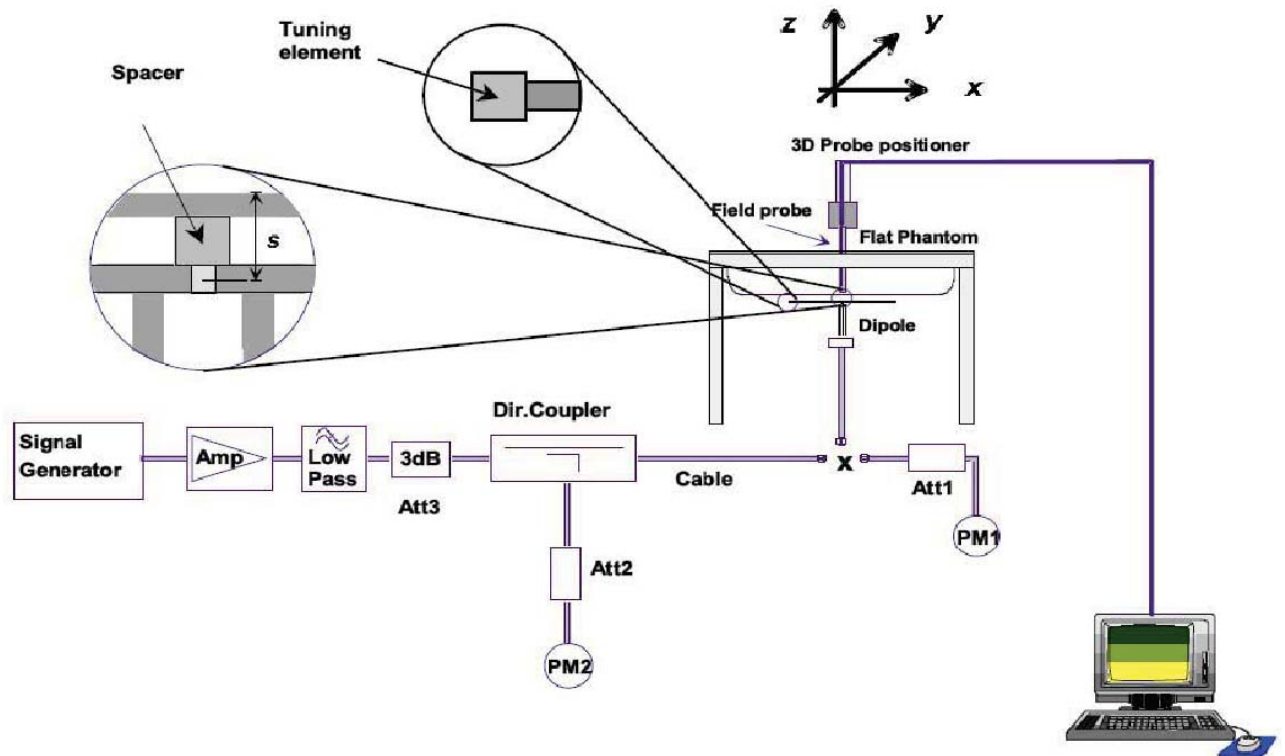

SYSTEM PERFORMANCE CHECK MEASUREMENT CONDITIONS

- The measurements were performed in the flat section of the SAM twin phantom filled with head and body simulating liquid of the following parameters.
- The DASY5 system with an E-field probe EX3DV4 SN: 3798 was used for the measurements.
- The dipole was mounted on the small tripod so that the dipole feed point was positioned below the center marking of the flat phantom section and the dipole was oriented parallel to the body axis (the long side of the phantom). The standard measuring distance was 15 mm (below 1 GHz) and 10 mm (above 1 GHz) from dipole center to the simulating liquid surface.
- The coarse grid with a grid spacing of 10mm was aligned with the dipole.
- Special 7x7x7 fine cube was chosen for cube integration (dx= 5 mm, dy= 5 mm, dz= 5 mm).
- Distance between probe sensors and phantom surface was set to 2 mm.
- The dipole input power was $250\text{mW} \pm 3\%$.
- The results are normalized to 1 W input power.

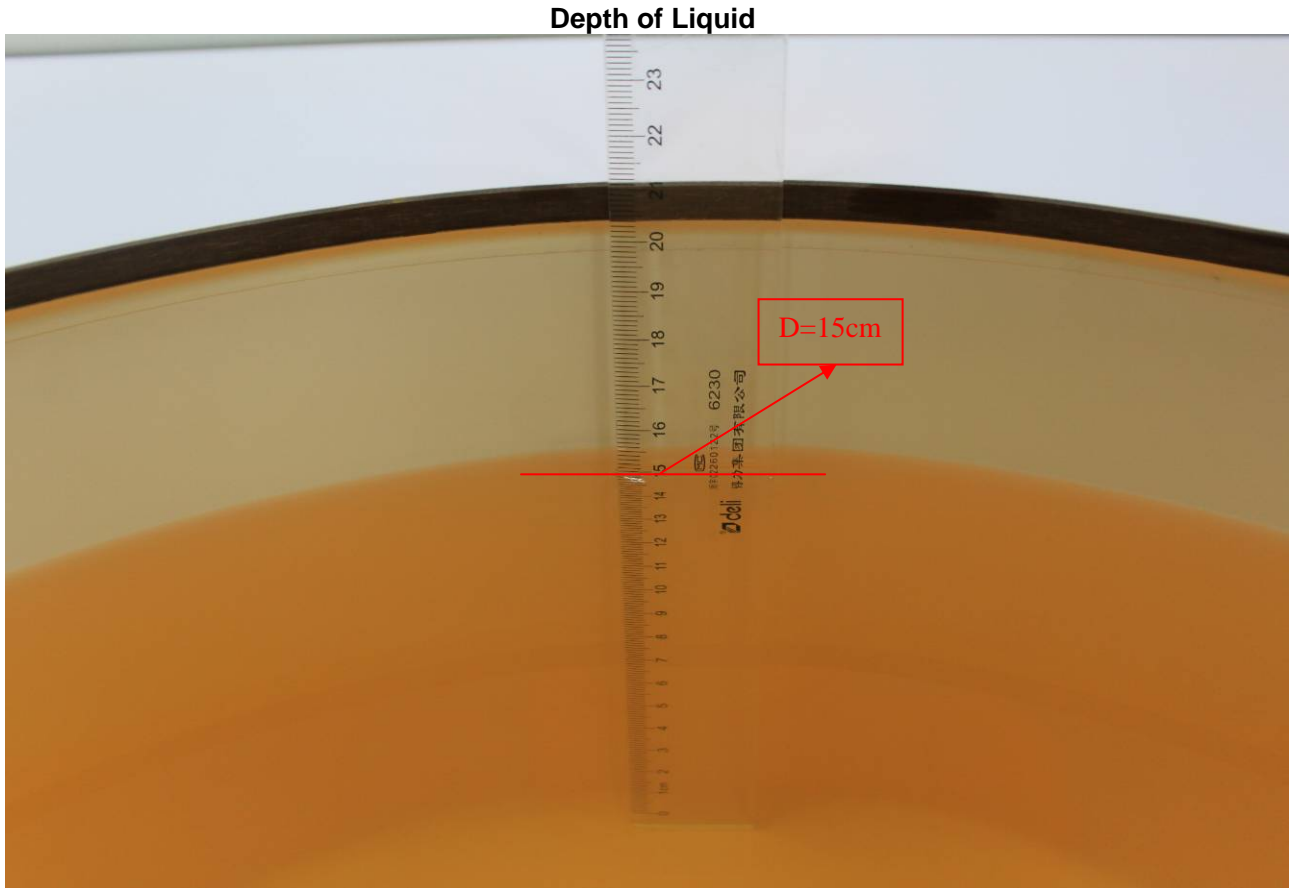

- Note: For SAR testing, the depth is 15cm shown above

SYSTEM PERFORMANCE CHECK RESULTS

Liquid Type	Ambient Temp. (°C)	Liquid Temp. (°C)	Input Power (W)	Measured SAR _{1g} (W/Kg)	1W Target SAR _{1g} (W/Kg)	1W Normalized SAR _{1g} (W/Kg)	Deviation (%)	Limited (%)	Date
Body2450	22	21.5	0.25	12.90	51.50	51.60	0.19	± 10	2017-4-18
Body5200	22	21.5	0.1	7.37	74.50	73.7	-1.07	± 10	2017-4-19
Body5300	22	21.5	0.1	7.62	77.20	76.2	-1.30	± 10	2017-4-19
Body5500	22	21.5	0.1	7.78	81.10	77.8	-4.07	± 10	2017-4-19
Body5600	22	21.5	0.1	7.79	79.80	77.9	-2.38	± 10	2017-4-19
Body5800	22	21.5	0.1	7.82	77.20	78.2	1.30	± 10	2017-4-19

Liquid Type	Ambient Temp. (°C)	Liquid Temp. (°C)	Input Power (W)	Measured SAR _{1g} (W/Kg)	1W Target SAR _{1g} (W/Kg)	1W Normalized SAR _{1g} (W/Kg)	Deviation (%)	Limited (%)	Date
Body2450	22	21.5	0.25	12.50	51.50	50.00	-2.91	± 10	2017-5-12
Body5600	22	21.5	0.1	7.96	79.80	79.6	-0.25	± 10	2017-5-12

Liquid Type	Ambient Temp. (°C)	Liquid Temp. (°C)	Input Power (W)	Measured SAR _{1g} (W/Kg)	1W Target SAR _{1g} (W/Kg)	1W Normalized SAR _{1g} (W/Kg)	Deviation (%)	Limited (%)	Date
Body2450	22	21.5	0.25	12.60	51.50	50.40	-2.14	± 10	2017-5-16

11.4 EUT TUNE-UP PROCEDURES AND TEST MODE

Conducted output power(dBm):

General Note:

- 1 Power must be measured at each transmit antenna port according to the DSSS and OFDM transmission configurations in each standalone and aggregated frequency band.
- 2 Power measurement is required for the transmission mode configuration with the highest maximum output power specified for production units.
 - 1) When the same highest maximum output power specification applies to multiple transmission modes, the largest channel bandwidth configuration with the lowest order modulation and lowest data rate is measured.
 - 2) When the same highest maximum output power is specified for multiple largest channel bandwidth configurations with the same lowest order modulation or lowest order modulation and lowest data rate, power measurement is required for all equivalent 802.11 configurations with the same maximum output power.
- 3 For each transmission mode configuration, power must be measured for the highest and lowest channels; and at the mid-band channel(s) when there are at least 3 channels. For configurations with multiple mid-band channels, due to an even number of channels, both channels should be measured.
- 4 Apply the default power measurement procedures to measure maximum output power for each standalone and aggregated frequency band.
 - a) The maximum output power of band gap channels is limited to the lowest maximum output power certified for the adjacent bands regardless of whether band aggregation is applied for SAR testing.
 - b) The measured maximum output power results are used to reduce the number of channels that need testing.

WLAN 2.4G

Mode	Channel	Frequency (MHZ)	Target power(dBm)	Turn up tolerance (dBm)	Maximum Turn up power (dBm)	Average power (dBm)
802.11 b	1	2412	14.5	±1	15.5	15.20
	6	2437	14.5	±1	15.5	15.50
	11	2462	14.5	±1	15.5	15.10
802.11 g	1	2412	13	±1	14	13.70
	6	2437	13	±1	14	14.00
	11	2462	13	±1	14	13.80
802.11 n 20MHz	1	2412	12.5	±1	13.5	13.30
	6	2437	12.5	±1	13.5	12.90
	11	2462	12.5	±1	13.5	13.00
802.11 n 40MHz	3	2422	12.5	±1	13.5	12.80
	6	2437	12.5	±1	13.5	13.20
	9	2452	12.5	±1	13.5	13.40

WLAN 5G U-NII-1

Mode	Channel	Frequency (MHZ)	Target power(dBm)	Turn up tolerance (dBm)	Maximum Turn up power (dBm)	Average Power (dBm)
802.11 a	36	5180	14	±1	15	14.40
	44	5220	14	±1	15	14.60
	48	5240	14	±1	15	14.40
802.11 n 20MHz	36	5180	14	±1	15	14.50
	44	5220	14	±1	15	14.50
	48	5240	14	±1	15	14.50
802.11 n 40MHz	38	5190	14	±1	15	14.70
	46	5230	14	±1	15	14.50
802.11 ac80	42	5210	14	±1	15	14.90

WLAN 5G U-NII-2A

Mode	Channel	Frequency (MHZ)	Target power(dBm)	Turn up tolerance (dBm)	Maximum Turn up power (dBm)	Average Power (dBm)
802.11 a	52	5260	14	±1	15	14.10
	56	5280	14	±1	15	14.20
	64	5320	14	±1	15	14.20
802.11 n 20MHz	52	5260	14	±1	15	14.60
	56	5280	14	±1	15	14.20
	64	5320	14	±1	15	14.20
802.11 n 40MHz	54	5270	14	±1	15	14.30
	62	5310	14	±1	15	14.20
802.11 ac80	58	5290	14	±1	15	14.80

WLAN 5G U-NII-2C

Mode	Channel	Frequency (MHZ)	Target power(dBm)	Turn up tolerance (dBm)	Maximum Turn up power (dBm)	Average Power (dBm)
802.11 a	100	5500	14	±1	15	14.40
	116	5580	14	±1	15	14.50
	140	5700	14	±1	15	14.00
802.11 n 20MHz	100	5500	14	±1	15	14.50
	116	5580	14	±1	15	14.50
	140	5700	14	±1	15	14.40
802.11 n 40MHz	102	5510	14	±1	15	14.60
	110	5550	14	±1	15	14.90
	134	5670	14	±1	15	14.30
802.11 ac80	106	5530	12	±1	13	12.20
	122	5610	12	±1	13	12.60
	138	5690	12	±1	13	12.40

WLAN 5G U-NII-3

Mode	Channel	Frequency	Target power(dBm)	Turn up tolerance (dBm)	Maximum Turn up power (dBm)	Average power (dBm)
802.11 a	149	5745	13	±1	14	13.50
	157	5785	13	±1	14	13.70
	165	5825	13	±1	14	13.30
802.11 n 20MHz	149	5745	13	±1	14	13.70
	157	5785	13	±1	14	13.60
	165	5825	13	±1	14	13.20
802.11 n 40MHz	151	5755	13	±1	14	14.00
	159	5795	13	±1	14	13.70
802.11 ac80	155	5775	12	±1	13	12.50

Bluetooth 3.0+EDR Conducted output power(dBm):

Channel	Frequency	Average power(dBm)		
		Date Rate		
		1Mbps	2Mbps	3Mbps
CH00	2402 MHz	2.4	1.6	1.7
CH39	2441 MHz	2.0	1.7	1.2
CH78	2480 MHz	2.2	1.6	1.5

BLE Conducted output power (dBm):

Channel	Frequency	Average power (dBm)
		Date Rate
CH00	2402 MHz	2.3
CH20	2440 MHz	2.7
CH39	2480 MHz	2.4

Note:The product Max antenna gain is 3.20 dBi, So the highest EIRP result is 6.20 dBm

According to KDB447498 D01:The 1-g and 10-g SAR test exclusion thresholds for 100 MHz to 6 GHz at *test separation distances* ≤ 50 mm are determined by:

$[(\text{max. power of channel, including tune-up tolerance, mW})/(\text{min. test separation distance, mm})] \cdot \sqrt{f(\text{GHz})} \leq 3.0$ for 1-g SAR and ≤ 7.5 for 10-g extremity SAR, where

- $f(\text{GHz})$ is the RF channel transmit frequency in GHz
- Power and distance are rounded to the nearest mW and mm before calculation²⁵
- The result is rounded to one decimal place for comparison
- 3.0 and 7.5 are referred to as the numeric thresholds in the step 2 below
- If the test separation distance (antenna-user) is < 5mm, 5mm is used for excluded SAR calculation

	Wireless Interface	Bluetooth
	Tune-up Maximum power (dBm)	3
	Tune-up Maximum rated power (mW)	1.995
Body	Antenna to user (mm)	5
	Frequency(GHz)	2440
	SAR exclusion threshold	0.623

Per KDB 447498 D01 exclusion thresholds is 0.623< 3, Bluetooth RF exposure evaluation is not required.

According to RSS102-2015 :

SAR evaluation for this device was performed with a separation distance of 5 mm. Observing the SAR evaluation exemption limit table (Table 1, see below) found in § 2.5.1 of RSS102:2015 , it was determined that the SAR exemption limit for this device is 4 mW for 2.4GHz transmission and 1 mW for 5 GHz transmission. No Wi-Fi mode qualified for test exemption as all power levels were above the stated thresholds. On the contrary, Bluetooth, with a frequency of 2440 MHz and a maximum output power of 4.169 mW (6.20 dBm, tune-up tolerance accounted for), is higher than the exemption threshold and therefore exempt from SAR evaluation for either the intended user or bystanders. So Bluetooth RF exposure evaluation is required

Table 1: SAR evaluation – Exemption limits for routine evaluation based on frequency and separation distance

Frequency (MHz)	Exemption Limits (mW)				
	At separation distance of ≤5 mm	At separation distance of 10 mm	At separation distance of 15 mm	At separation distance of 20 mm	At separation distance of 25 mm
≤300	71 mW	101 mW	132 mW	162 mW	193 mW
450	52 mW	70 mW	88 mW	106 mW	123 mW
835	17 mW	30 mW	42 mW	55 mW	67 mW
1900	7 mW	10 mW	18 mW	34 mW	60 mW
2450	4 mW	7 mW	15 mW	30 mW	52 mW
3500	2 mW	6 mW	16 mW	32 mW	55 mW
5800	1 mW	6 mW	15 mW	27 mW	41 mW

Frequency (MHz)	Exemption Limits (mW)				
	At separation distance of 30 mm	At separation distance of 35 mm	At separation distance of 40 mm	At separation distance of 45 mm	At separation distance of ≥50 mm
≤300	223 mW	254 mW	284 mW	315 mW	345 mW
450	141 mW	159 mW	177 mW	195 mW	213 mW
835	80 mW	92 mW	105 mW	117 mW	130 mW
1900	99 mW	153 mW	225 mW	316 mW	431 mW
2450	83 mW	123 mW	173 mW	235 mW	309 mW
3500	86 mW	124 mW	170 mW	225 mW	290 mW
5800	56 mW	71 mW	85 mW	97 mW	106 mW

11.5 SAR TEST CONFIGURATIONS

Antenna position

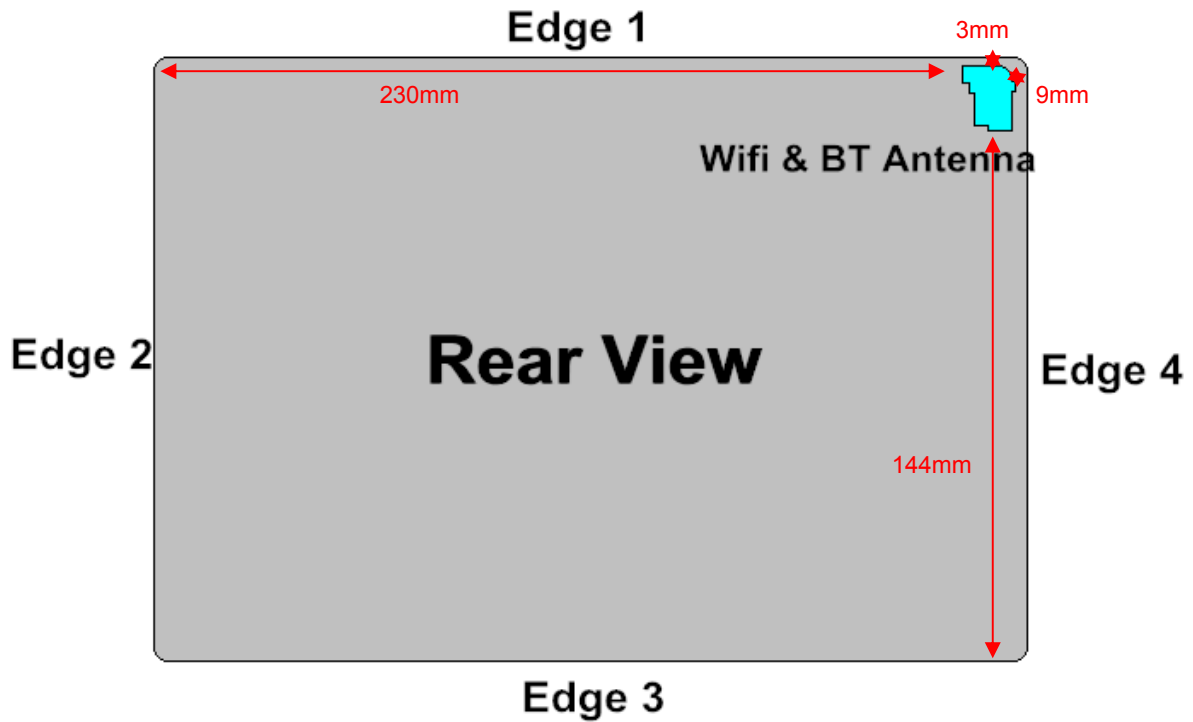

Device dimensions (H x W): 260 x 168 mm

Antennas	Wireless Interface
Bluetooth & WLAN Antenna	WLAN 2.4GHz WLAN 5.2GHz WLAN 5.3GHz WLAN 5.5GHz WLAN 5.8GHz Bluetooth

Test Mode

IEEE 802.11	Data transmission mode(802.11b,Bluetooth GFSK, 802.11n40; 802.11ac80)
-------------	---

11.6 BODY TEST EXCLUSION THRESHOLDS

The following SAR test exclusion Thresholds based on KDB 447498 D01 General RF Exposure Guidance v06) 4.3.1)

Exposure Position	Wireless Interface	WLAN	WLAN
		802.11 2.4GHz	802.11 5GHz
Exposure Position	Maximum power	15.5	15
	Maximum rated power(mW)	35.48	31.62
Rear view	Antenna to user (mm)	2	2
	SAR exclusion threshold	3.83<35.48 for distance <50mm	2.49<31.62 for distance <50mm
	SAR testing required	Yes	Yes
Edge1	Antenna to user (mm)	3	3
	SAR exclusion threshold	5.75<35.48 for distance <50mm	3.74<31.62 for distance <50mm
	SAR testing required	Yes	Yes
Edge2	Antenna to user (mm)	230	230
	SAR exclusion threshold	N/A	N/A
	SAR testing required	No	No
Edge3	Antenna to user (mm)	144	144
	SAR exclusion threshold	1036>35.48 for distance >50mm	1002.28>31.62 for distance >50mm
	SAR testing required	No	No
Edge4	Antenna to user (mm)	9	9
	SAR exclusion threshold	17.25<35.48 for distance <50mm	11.21<35.48 for distance <50mm
	SAR testing required	Yes	Yes

Note:

- Maximum power is the source-based time-average power and represents the maximum RF output power among production units
- Per KDB 447498 D01, for larger devices, the test separation distance of adjacent edge configuration is determined by the closest separation between the antenna and the user.
- Per KDB 447498 D01, standalone SAR test exclusion threshold is applied; If the distance of the antenna to the user is < 5mm, 5mm is used to determine SAR exclusion threshold
- Per KDB 447498 D01, the 1-g and 10-g SAR test exclusion thresholds for 100 MHz to 6 GHz at test separation distances ≤ 50 mm are determined by:

$$[(max. power of channel, including tune-up tolerance, mW)/(min. test separation distance, mm)] \cdot [\sqrt{f(GHz)}] \leq 3.0$$
 for 1-g SAR and ≤ 7.5 for 10-g extremity SAR
 f(GHz) is the RF channel transmit frequency in GHz
 Power and distance are rounded to the nearest mW and mm before calculation
 The result is rounded to one decimal place for comparison
 For < 50 mm distance, we just calculate mW of the exclusion threshold value (3.0) to do compare.
 This formula is $[3.0] / [\sqrt{f(GHz)}] \cdot [(min. test separation distance, mm)] =$ exclusion threshold of mW.
- Per KDB 447498 D01, at 100 MHz to 6 GHz and for test separation distances > 50 mm, the SAR test exclusion threshold is determined according to the following
 - [Threshold at 50 mm in step 1) + (test separation distance - 50 mm)·(f(MHz)/150)] mW, at 100 MHz to 1500 MHz
 - [Threshold at 50 mm in step 1) + (test separation distance - 50 mm)·10] mW at > 1500 MHz and ≤ 6 GHz
- When the minimum test separation distance is < 5 mm, a distance of 5 mm according to 5) in section 4.1 is applied to determine SAR test exclusion.

The following SAR test exclusion Thresholds based on RSS102 issue5 2.5.1



Exposure Position	Wireless Interface	WLAN	WLAN	Bluetooth
		802.11 2.4GHz	802.11 5GHz	2.4GHz
	Maximum power	15.5	15	6.2
	Maximum rated power(mW)	35.48	31.62	4.169
Rear view	Antenna to user (mm)	2	2	2
	SAR exclusion threshold	4	1	4
	SAR testing required	Yes	Yes	Yes
Edge1	Antenna to user (mm)	3	3	3
	SAR exclusion threshold	4	1	4
	SAR testing required	Yes	Yes	Yes
Edge2	Antenna to user (mm)	230	230	230
	SAR exclusion threshold	N/A	N/A	N/A
	SAR testing required	No	No	No
Edge3	Antenna to user (mm)	144	144	144
	SAR exclusion threshold	309	106	309
	SAR testing required	No	No	No
Edge4	Antenna to user (mm)	9	9	9
	SAR exclusion threshold	7	6	7
	SAR testing required	Yes	Yes	No

Note:

SAR evaluation is required if the separation distance between the user and/or bystander and the antenna and/or radiating element of the device is less than or equal to 20 cm, except when the device operates at or below the applicable output power level (adjusted for tune-up tolerance) for the specified separation distance defined in Table 1.

11.7 EUT SETUP PHOTOS

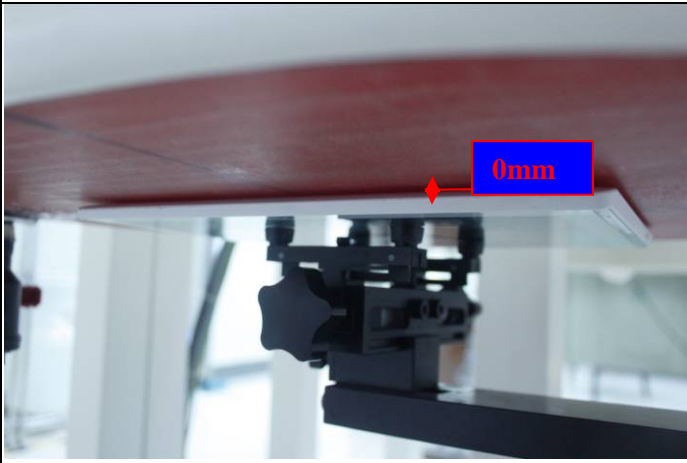
11.8 BODY SAR TEST CONFIGURATION

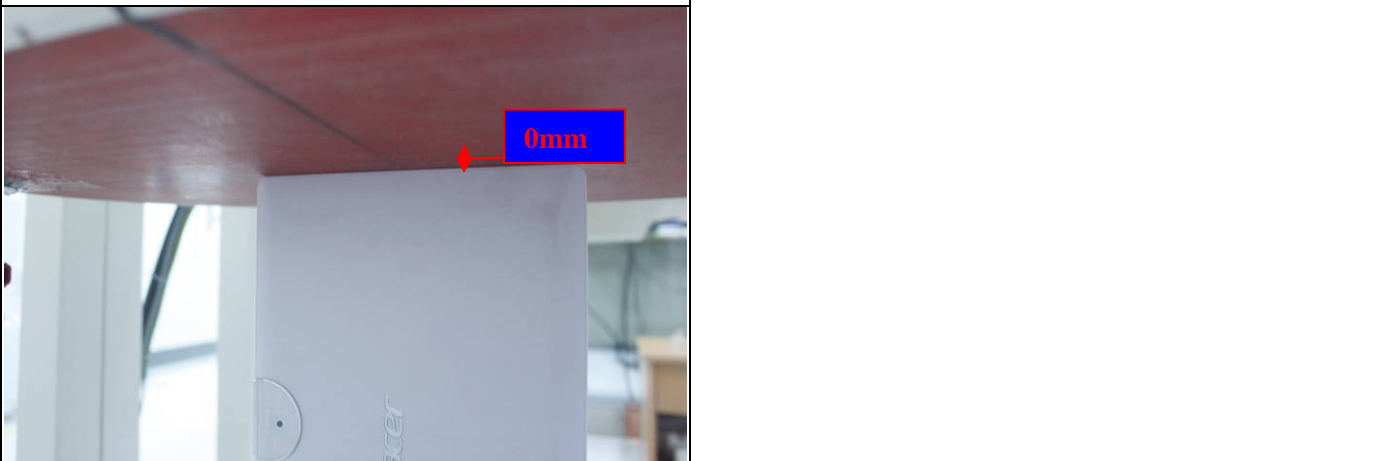
Rear in body position	Edge1 in body position
 A photograph showing the rear of a device in a body SAR test configuration. A red double-headed arrow indicates a 0mm gap between the device and the red wooden table surface. A blue box with '0mm' in red text is positioned above the arrow.	 A photograph showing the Edge1 of a device in a body SAR test configuration. A red double-headed arrow indicates a 0mm gap between the device and the red wooden table surface. A blue box with '0mm' in red text is positioned above the arrow.
<u>EUT Setup Configuration 1</u>	<u>EUT Setup Configuration 2</u>
Edge4 in body position	
 A photograph showing the Edge4 of a device in a body SAR test configuration. A red double-headed arrow indicates a 0mm gap between the device and the red wooden table surface. A blue box with '0mm' in red text is positioned above the arrow.	
<u>EUT Setup Configuration 3</u>	

**SAR Results for Body Test Records
2.4GHz(TCL Battery)**

Band	Mode	Test Position	Dist. (mm)	Freq. (MHZ)	max Power (dBm)	Tune-Up Limit (dBm)	Scaling Factor	Power Drift (dB)	Duty Cycle Factor	SAR1g (mW/g)	Scaled SAR1g (mW/g)
WLAN 2.4GHz	802.11b	Rear	0	2412	15.20	15.5	1.072	0.03	1	0.998	1.069
		Rear	0	2437	15.50	15.5	1.000	0.13	1	1.00	1.000
		Rear	0	2462	15.10	15.5	1.096	-0.10	1	1.02	1.118
		Edge1	0	2437	15.50	15.5	1.000	0.14	1	0.200	0.200
		Edge4	0	2437	15.50	15.5	1.000	0.07	1	0.183	0.183

2.4GHz(haopeng Battery-worst case)

Band	Mode	Test Position	Dist. (mm)	Freq. (MHZ)	max Power (dBm)	Tune-Up Limit (dBm)	Scaling Factor	Power Drift (dB)	Duty Cycle Factor	SAR1g (mW/g)	Scaled SAR1g (mW/g)
WLAN 2.4GHz	802.11b	Rear	0	2462	15.10	15.5	1.096	0.01	1	0.941	1.032

Remark: SAR is not required for the following 2.4 GHz OFDM conditions.

- 1) When KDB Publication 447498 SAR test exclusion applies to the OFDM configuration.
- 2) When the highest reported SAR for DSSS is adjusted by the ratio of OFDM to DSSS specified maximum output power and the adjusted SAR is ≤ 1.2 W/kg.
The highest reported SAR for DSSS is adjusted by the ratio of OFDM to DSSS specified maximum output power and the adjusted SAR is > 1.2 W/kg. So 2.4 GHz OFDM mode is require.
- 3) SAR for subsequent highest measured maximum output power channels in the subsequent test configuration is required only when the reported SAR of the preceding higher maximum output power channel(s) in the subsequent test configuration is > 1.2 W/kg or until all required channels are tested.

BLE(TCL Battery)

Band	Mode	Test Position	Dist. (mm)	Freq. (MHZ)	max Power (dBm)	Tune-Up Limit (dBm)	Scaling Factor	Power Drift (dB)	Duty Cycle Factor	SAR1g (mW/g)	Scaled SAR1g (mW/g)
2.4GHz	BT GFSK	Rear	0	2402	2.3	3	1.175	0.11	1	0.113	0.133
		Rear	0	2440	2.7	3	1.072	0.10	1	0.140	0.150
		Rear	0	2480	2.4	3	1.148	0.05	1	0.156	0.179
		Edge1	0	2440	2.7	3	1.072	0.03	1	0.037	0.040

BLE(haopeng Battery-worst case)

Band	Mode	Test Position	Dist. (mm)	Freq. (MHZ)	max Power (dBm)	Tune-Up Limit (dBm)	Scaling Factor	Power Drift (dB)	Duty Cycle Factor	SAR1g (mW/g)	Scaled SAR1g (mW/g)
2.4GHz	BT GFSK	Rear	0	2480	2.4	3	1.148	0.05	1	0.141	0.162

5GHz(TCL Battery)

Band	Mode	Test Position	Dist. (mm)	Freq. (MHZ)	max Power (dBm)	Tune-Up Limit (dBm)	Scaling Factor	Power Drift (dB)	Duty Cycle Factor	SAR1g (mW/g)	Scaled SAR1g (mW/g)
U-NII-2A	WLAN 5GHz ac80	Rear	0	5290	14.80	15	1.047	-0.03	1	1.12	1.173
		Edge1	0	5290	14.80	15	1.047	0.04	1	0.997	1.044
		Edge4	0	5290	14.80	15	1.047	0.10	1	0.333	0.349
U-NII-2C	WLAN 5GHz n40	Rear	0	5510	14.60	15	1.096	0.06	1	1.05	1.151
		Rear	0	5550	14.90	15	1.023	0.03	1	1.14	1.167
		Rear	0	5670	14.30	15	1.175	0.05	1	1.02	1.198
		Edge1	0	5550	14.90	15	1.023	0.06	1	0.715	0.732
		Edge4	0	5550	14.90	15	1.023	0.04	1	0.523	0.535
U-NII-3	WLAN 5GHz n40	Rear	0	5755	14.00	14	1.000	0.09	1	0.991	0.991
		Rear	0	5795	13.70	14	1.072	0.06	1	1.10	1.179
		Edge1	0	5755	14.00	14	1.000	0.16	1	0.458	0.458
		Edge4	0	5755	14.00	14	1.000	-0.03	1	0.483	0.483

5GHz (haopeng Battery-worst case)

Band	Mode	Test Position	Dist. (mm)	Freq. (MHZ)	max Power (dBm)	Tune-Up Limit (dBm)	Scaling Factor	Power Drift (dB)	Duty Cycle Factor	SAR1g (mW/g)	Scaled SAR1g (mW/g)
U-NII-2C	WLAN 5GHz n40	Rear	0	5670	14.30	15	1.175	0.05	1	0.933	1.096

Remark: For devices that operate in both U-NII-1 and U-NII-2A bands using the same transmitter and antenna(s), SAR test reduction is determined according to the following

1) When the same maximum output power is specified for both bands, begin SAR measurement in U-NII-2A band by applying the OFDM SAR requirements. If the highest reported SAR for a test configuration is ≤ 1.2 W/kg, SAR is not required for U-NII-1 band for that configuration (802.11 mode and exposure condition); otherwise, each band is tested independently for SAR.

2) When different maximum output power is specified for the bands, begin SAR measurement in the band with higher specified maximum output power. The highest reported SAR for the tested configuration is adjusted by the ratio of lower to higher specified maximum output power for the two bands. When the adjusted SAR is ≤ 1.2 W/kg, SAR is not required for the band with lower maximum output power in that test configuration; otherwise, each band is tested independently for SAR.

The highest reported SAR for is adjusted by the ratio of U-NII-1 to U-NII-2A specified maximum output power and the adjusted SAR is ≤ 1.2 W/kg . So U-NII-1 mode is not require.

Repeated SAR Test Records

Band	Mode	Test Position	Dist. (mm)	Freq. (MHZ)	max Power (dBm)	Tune-Up Limit (dBm)	Scaling Factor	Power Drift (dB)	Duty Cycle Factor	SAR1g (mW/g)	Scaled SAR1g (mW/g)
WLAN 2.4GHz	802.11b	Rear	0	2462	15.10	15.5	1.000	0.05	1	1.01	1.107
WLAN 5Ghz ac80	U-NII-2A	Rear	0	5290	14.80	15	1.047	0.03	1	1.09	1.141
WLAN 5Ghz n40	U-NII-2C	Rear	0	5550	14.90	15	1.023	0.01	1	1.11	1.136
WLAN 5Ghz n40	U-NII-3	Rear	0	5795	13.70	14	1.072	0.07	1	1.09	1.168

11.9 REPEATED SAR MEASUREMENT

Band	Mode	Test Position	Dist. (mm)	Freq. (MHZ)	Original Measured SAR1g (mW/g)	1st Repeated SAR1g (mW/g)	Ratio	Original Measured SAR1g (mW/g)	2nd Repeated SAR1g (mW/g)	Ratio
WLAN 2.4GHz	802.11b	Rear	0	2462	1.02	1.01	1.010	--	--	--
WLAN 5Ghz ac80	U-NII-2A	Rear	0	5290	1.12	1.09	1.028	--	--	--
WLAN 5Ghz n40	U-NII-2C	Rear	0	5550	1.14	1.11	1.027	--	--	--
WLAN 5Ghz n40	U-NII-3	Rear	0	5795	1.10	1.09	1.009	--	--	--

Note:

1. Per KDB 865664 D01v01,for each frequency band, repeated SAR measurement is required only when the measured SAR is $\geq 0.8W/Kg$

Per KDB 865664 D01v01,if the ratio of largest to smallest SAR for the original and first repeated measurement is ≤ 1.2 and the measured SAR $< 1.45W/Kg$,only one repeated measurement is required.

2. Perform a second repeated measurement only if the ratio of largest to smallest SAR for the original and first repeated measurements is > 1.20 or when the original or repeated measurement is $\geq 1.45 W/kg$

3. The ratio is the difference in percentage between original and repeated measured SAR.

11.10 SAR HANDSETS MULTI XMITER ASSESSMENT

No.	Applicable Simultaneous Transmission Combination
1	N/A

Note:

1. WLAN and BT share the same antenna, and cannot transmit simultaneously.

12. EUT PHOTO



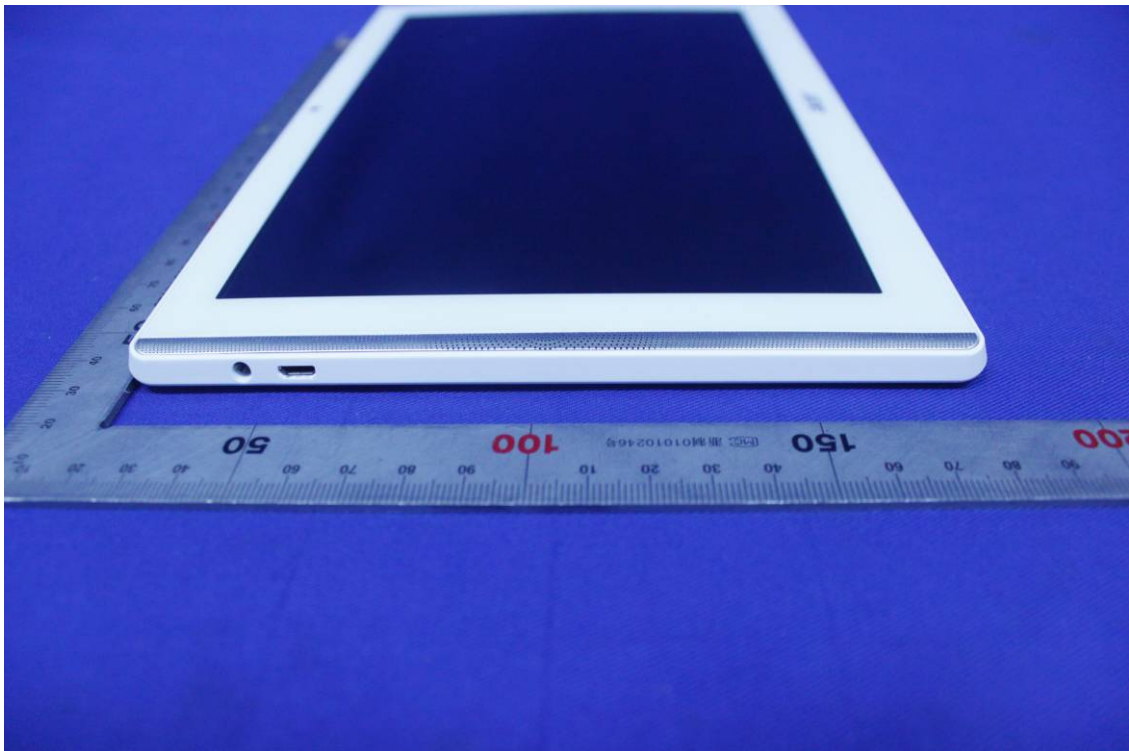
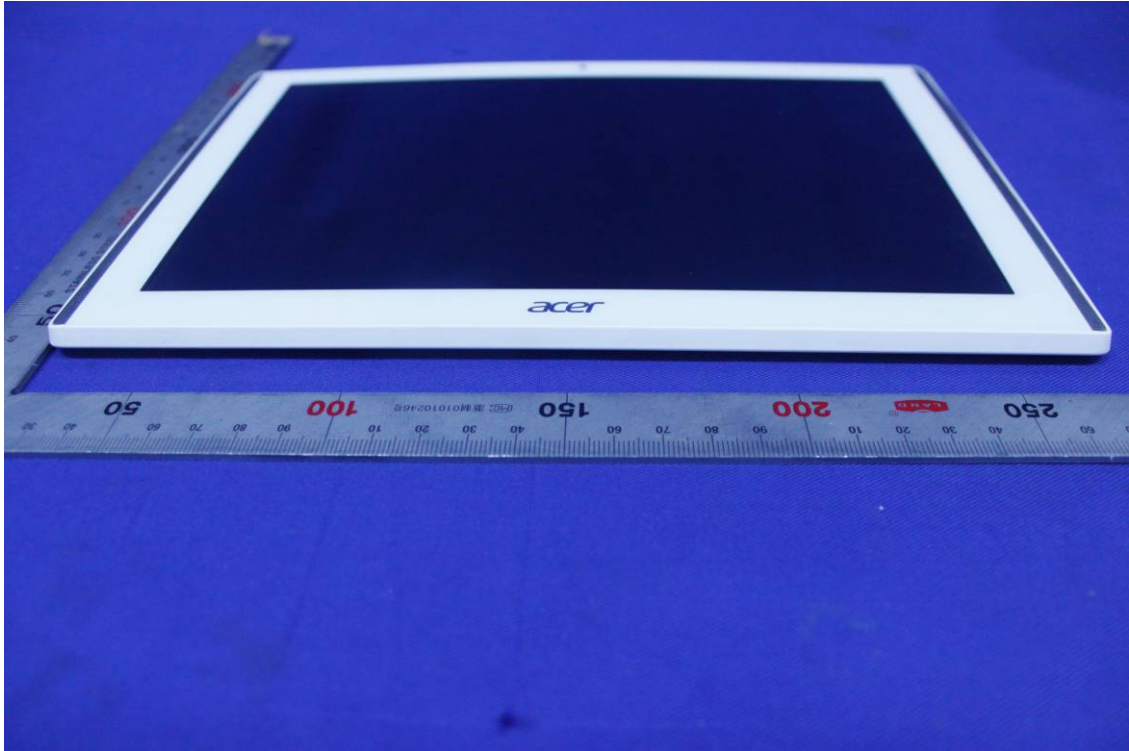

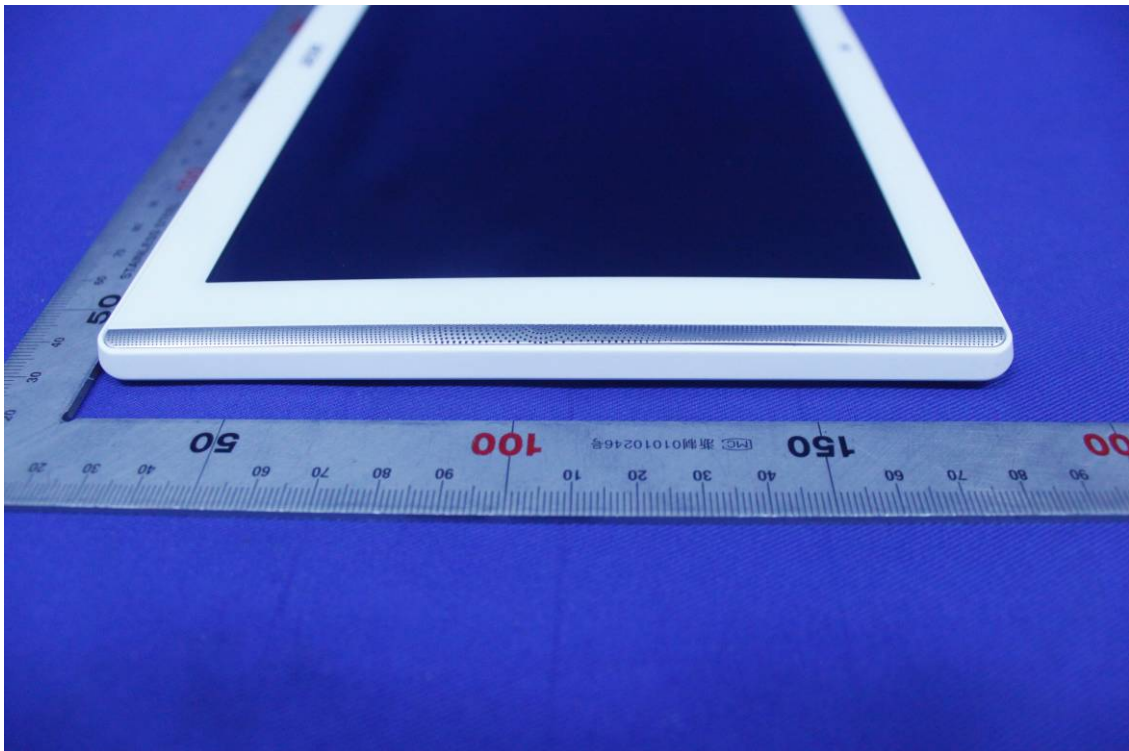
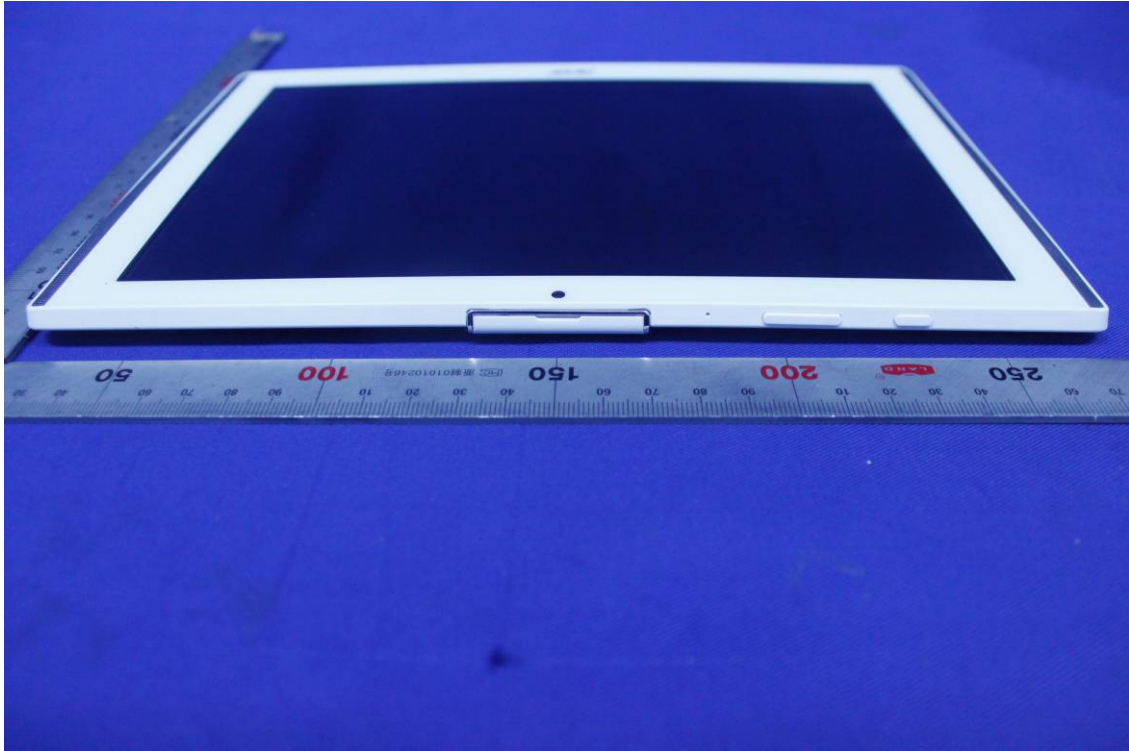

TCL Battery

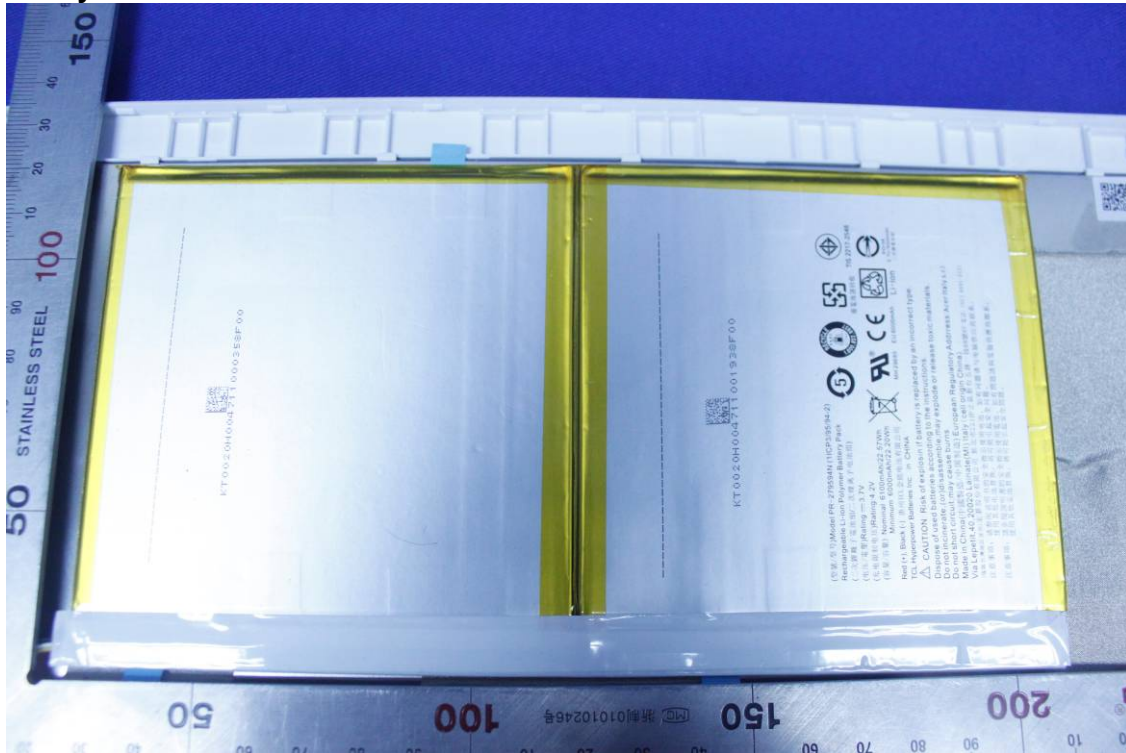

haopeng Battery

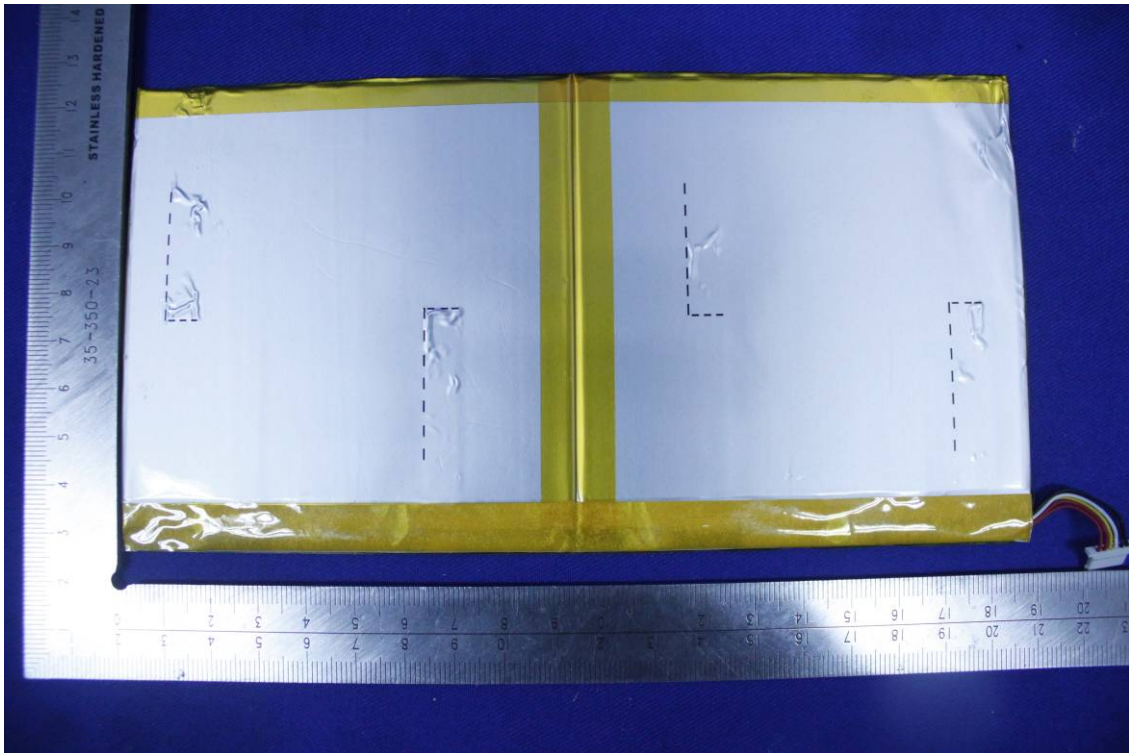

13. EQUIPMENT LIST & CALIBRATION STATUS

Name of Equipment	Manufacturer	Type/Model	Serial Number	Last Calibration	Calibration Due
P C	HP	Core(rm)3.16G	CZCO48171H	N/A	N/A
Signal Generator	Agilent	E8257C	US37101915	2/28/2017	02/27/2018
S-Parameter Network Analyzer	Agilent	E5071B	MY42301382	02/28/2017	02/27/2018
Power Meter	Anritsu	ML2495A	1445010	02/28/2017	02/27/2018
Peak & Average sensor	Anritsu	MA2411B	1339220	02/28/2017	02/27/2018
E-field PROBE	SPEAG	EX3DV4	3798	07/27/2016	07/26/2017
DAE	SPEAG	DEA4	1245	07/26/2016	07/25/2017
DIPOLE 2450MHZ ANTENNA	SPEAG	D2450V2	817	05/31/2016	05/28/2019
DIPOLE 5GHZ ANTENNA	SPEAG	D5GHzV2	1095	05/25/2016	05/22/2019
DUMMY PROBE	SPEAG	DP_2	SPDP2001AA	N/A	N/A
SAM PHANTOM (ELI4 v4.0)	SPEAG	QDOVA001BB	1102	N/A	N/A
Twin SAM Phantom	SPEAG	QD000P40CD	1609	N/A	N/A
ROBOT	SPEAG	TX60	F10/5E6AA1/A101	N/A	N/A
ROBOT KRC	SPEAG	CS8C	F10/5E6AA1/C101	N/A	N/A
LIQUID CALIBRATION KIT	ANTENNESSA	41/05 OCP9	00425167	N/A	N/A

14. FACILITIES

All measurement facilities used to collect the measurement data are located at

No.10, Weiye Rd., Innovation Park, Eco & Tec. Development Part, Kunshan City, Jiangsu Province, China.

15. REFERENCES

- [1] Federal Communications Commission, "Report and order: Guidelines for evaluating the environmental effects of radiofrequency radiation", Tech. Rep. FCC 96-326, FCC, Washington, D.C. 20554, 1996.
- [2] David L. Means Kwok Chan, Robert F. Cleveland, "Evaluating compliance with FCC guidelines for human exposure to radiofrequency electromagnetic fields", Tech. Rep., Federal Communication Commission, Office of Engineering & Technology, Washington, DC, 1997.
- [3] Thomas Schmid, Oliver Egger, and Niels Kuster, "Automated E-field scanning system for dosimetric assessments", IEEE Transactions on Microwave Theory and Techniques, vol. 44, pp. 105{113, Jan. 1996.
- [4] Niels Kuster, Ralph Kastle, and Thomas Schmid, "Dosimetric evaluation of mobile communications equipment with known precision", IEEE Transactions on Communications, vol. E80-B, no. 5, pp. 645{652, May 1997.
- [5] CENELEC, "Considerations for evaluating of human exposure to electromagnetic fields (EMFs) from mobile telecommunication equipment (MTE) in the frequency range 30MHz – 6GHz", Tech. Rep., CENELEC, European Committee for Electrotechnical Standardization, Brussels, 1997.
- [6] ANSI, ANSI/IEEE C95.1-1999: IEEE Standard for Safety Levels with Respect to Human Exposure to Radio Frequency Electromagnetic Fields, 3 kHz to 300 GHz, The Institute of Electrical and Electronics Engineers, Inc., New York, NY 10017, 1992.
- [7] Katja Pokovic, Thomas Schmid, and Niels Kuster, "Robust setup for precise calibration of E-field probes in tissue simulating liquids at mobile communications frequencies", in ICECOM '97, Dubrovnik, October 15{17, 1997, pp. 120{124.
- [8] Katja Pokovic, Thomas Schmid, and Niels Kuster, "E-field probe with improved isotropy in brain simulating liquids", in Proceedings of the ELMAR, Zadar, Croatia, 23{25 June, 1996, pp. 172{175.
- [9] Volker Hombach, Klaus Meier, Michael Burkhardt, Eberhard Kuhn, and Niels Kuster, "The dependence of EM energy absorption upon human head modeling at 900 MHz", IEEE Transactions on Microwave Theory and Techniques, vol. 44, no. 10, pp. 1865{1873, Oct. 1996.
- [10] Klaus Meier, Ralf Kastle, Volker Hombach, Roger Tay, and Niels Kuster, "The dependence of EM energy absorption upon human head modeling at 1800 MHz", IEEE Transactions on Microwave Theory and Techniques, Oct. 1997, in press.
- [11] W. Gander, Computermathematik, Birkhaeuser, Basel, 1992.
- [12] W. H. Press, S. A. Teukolsky, W. T. Vetterling, and B. P. Flannery, Numerical Recipes in C, The Art of Scientific Computing, Second Edition, Cambridge University Press, 1992. Dosimetric Evaluation of Sample device, month 1998 9
- [13] NIS81 NAMAS, "The treatment of uncertainty in EMC measurement", Tech. Rep., NAMAS Executive, National Physical Laboratory, Teddington, Middlesex, England, 1994.
- [14] Barry N. Taylor and Christ E. Kuyatt, "Guidelines for evaluating and expressing the uncertainty of NIST measurement results", Tech. Rep., National Institute of Standards and Technology, 1994. Dosimetric Evaluation of Sample device, month 1998 10

APPENDIX A: PLOTS OF PERFORMANCE CHECK

The plots are showing as followings.

Test Laboratory: Compliance Certification Services Inc.

Date: 4/18/2017

System Performance Check-Body D2450

DUT: Dipole 2450 MHz D2450V2; Type: D24500V2; Serial: 817

Communication System: UID 0, CW; Communication System Band: D2450 (2450.0 MHz); Frequency: 2450 MHz; Duty Cycle: 1:1

Medium parameters used: $f = 2450$ MHz; $\sigma = 1.925$ S/m; $\epsilon_r = 51.168$; $\rho = 1000$ kg/m³

Room Ambient Temperature: 22°C; Liquid Temperature: 21.5°C

Phantom section: Flat Section

Measurement Standard: DASYS (IEEE/IEC/ANSI C63.19-2007)

DASY Configuration:

- Probe: EX3DV4 - SN3798; ConvF(7.07, 7.07, 7.07); Calibrated: 7/27/2016;
- Sensor-Surface: 2mm (Mechanical Surface Detection)
- Electronics: DAE4 Sn1245; Calibrated: 7/26/2016
- Phantom: ELI v4.0; Type: QDOVA001BB; Serial: TP:xxxx
- DASYS52 52.8.8(1222);
- SEMCAD X Version 14.6.10 (7331)

System Performance Check at Frequencies above 1 GHz/d=10mm, Pin=250 mW, dist=2.0mm (EX-Probe)/Area Scan (8x9x1): Measurement grid: dx=12mm, dy=12mm

Maximum value of SAR (measured) = 13.7 W/kg

System Performance Check at Frequencies above 1 GHz/d=10mm, Pin=250 mW, dist=2.0mm (EX-Probe)/Zoom Scan (7x7x7) (7x7x7)/Cube 0: Measurement grid: dx=5mm, dy=5mm, dz=5mm

Reference Value = 98.25 V/m; Power Drift = -0.12 dB

Peak SAR (extrapolated) = 24.5 W/kg

SAR(1 g) = 12.9 W/kg; SAR(10 g) = 6.19 W/kg

Maximum value of SAR (measured) = 18.4 W/kg

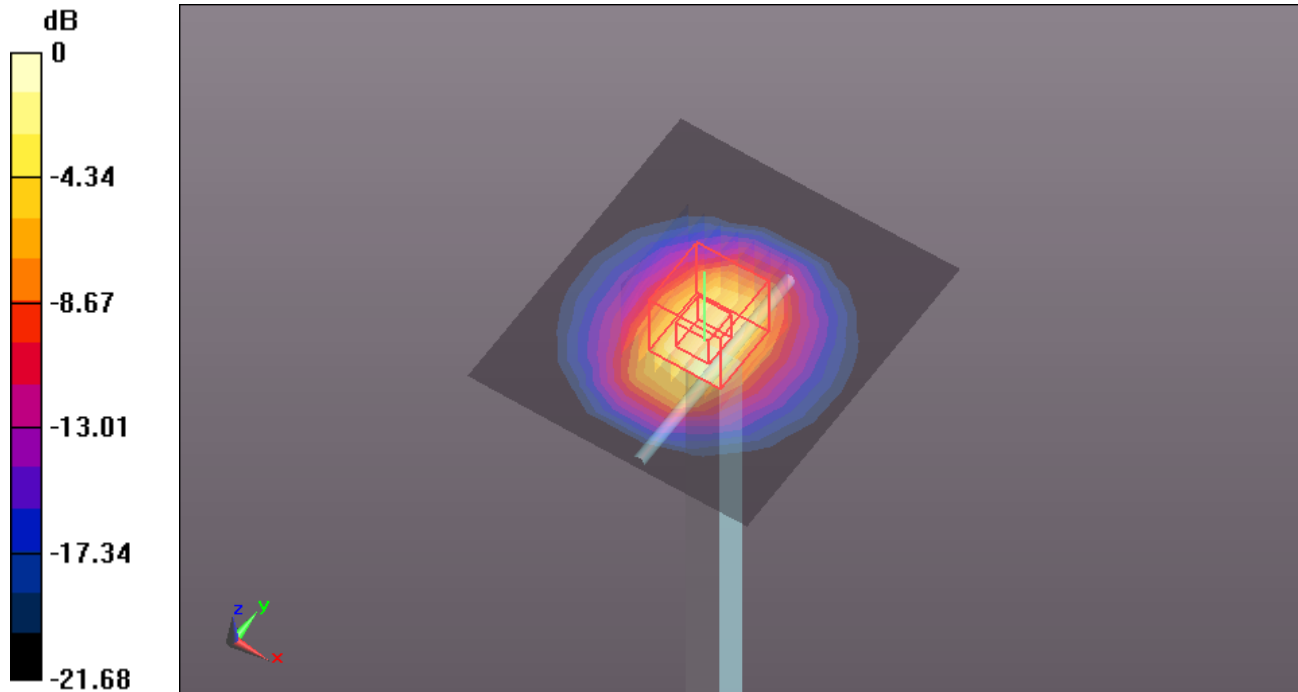

0 dB = 18.4 W/kg = 12.65 dBW/kg

Test Laboratory: Compliance Certification Services Inc.

Date: 4/19/2017

System Performance Check-Body D5200

DUT: Dipole D5GHzV2; Type: D5GHzV2; Serial: 1095

Communication System: UID 0, CW (0); Communication System Band: D5GHz (5000.0 - 6000.0 MHz);
Frequency: 5200 MHz; Duty Cycle: 1:1

Medium parameters used: $f = 5200$ MHz; $\sigma = 5.233$ S/m; $\epsilon_r = 48.75$; $\rho = 1000$ kg/m³

Room Ambient Temperature: 22°C; Liquid Temperature: 21.5°C

Phantom section: Flat Section

Measurement Standard: DASYS (IEEE/IEC/ANSI C63.19-2007)

DASY Configuration:

- Probe: EX3DV4 - SN3798; ConvF(4.77, 4.77, 4.77); Calibrated: 7/27/2016;
- Sensor-Surface: 1.4mm (Mechanical Surface Detection)
- Electronics: DAE4 Sn1245; Calibrated: 7/26/2016
- Phantom: ELI v4.0; Type: QDOVA001BB; Serial: TP:xxxx
- DASYS 52.8.8(1222);
- SEMCAD X Version 14.6.10 (7331)

System Performance Check with D5GHzV2 Dipole (graded grid)/d=10mm, Pin=100mW, f=5200 MHz/Area Scan (10x10x1):

Measurement grid: dx=10mm, dy=10mm

Maximum value of SAR (measured) = 13.2 W/kg

System Performance Check with D5GHzV2 Dipole (graded grid)/d=10mm, Pin=100mW, f=5200 MHz/Zoom Scan (4x4x1.4mm, graded), dist=1.4mm (8x8x7)/Cube 0:

Measurement grid: dx=4mm, dy=4mm, dz=1.4mm

Reference Value = 67.98 V/m; Power Drift = -0.04 dB

Peak SAR (extrapolated) = 28.6 W/kg

SAR(1 g) = 7.37 W/kg; SAR(10 g) = 2.28 W/kg

Maximum value of SAR (measured) = 17.0 W/kg

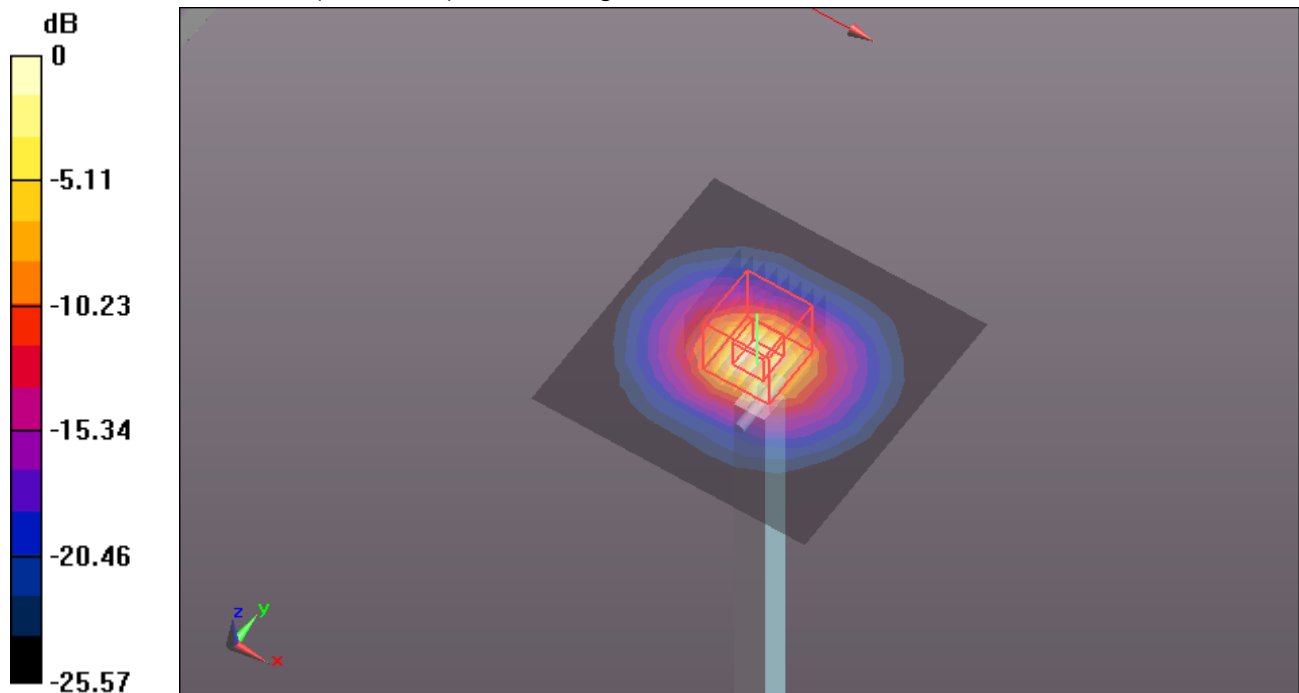

0 dB = 17.0 W/kg = 12.30 dBW/kg

Test Laboratory: Compliance Certification Services Inc.

Date: 4/19/2017

System Performance Check-Body D5300

DUT: Dipole D5GHzV2; Type: D5GHzV2; Serial: 1095

Communication System: UID 0, CW (0); Communication System Band: D5GHz (5000.0 - 6000.0 MHz); Frequency: 5300 MHz; Duty Cycle: 1:1

Medium parameters used: $f = 5300$ MHz; $\sigma = 5.387$ S/m; $\epsilon_r = 48.486$; $\rho = 1000$ kg/m³

Room Ambient Temperature: 22°C; Liquid Temperature: 21.5°C

Phantom section: Flat Section

Measurement Standard: DASYS (IEEE/IEC/ANSI C63.19-2007)

DASY Configuration:

- Probe: EX3DV4 - SN3798; ConvF(4.6, 4.6, 4.6); Calibrated: 7/27/2016;
- Sensor-Surface: 1.4mm (Mechanical Surface Detection)
- Electronics: DAE4 Sn1245; Calibrated: 7/26/2016
- Phantom: ELI v4.0; Type: QDOVA001BB; Serial: TP:xxxx
- DASYS 52.8.8(1222);
- SEMCAD X Version 14.6.10 (7331)

System Performance Check with D5GHzV2 Dipole (graded grid)/d=10mm, Pin=100mW, f=5300 MHz/Area Scan (9x10x1): Measurement grid: dx=10mm, dy=10mm

Maximum value of SAR (measured) = 14.3 W/kg

System Performance Check with D5GHzV2 Dipole (graded grid)/d=10mm, Pin=100mW, f=5300 MHz/Zoom Scan (4x4x1.4mm, graded), dist=1.4mm (8x8x7)/Cube 0: Measurement grid: dx=4mm, dy=4mm, dz=1.4mm

Reference Value = 65.78 V/m; Power Drift = -0.02 dB

Peak SAR (extrapolated) = 29.0 W/kg

Peak SAR (extrapolated) = 29.0 W/kg

SAR(1 g) = 7.62 W/kg; SAR(10 g) = 2.34 W/kg

Maximum value of SAR (measured) = 16.4 W/kg

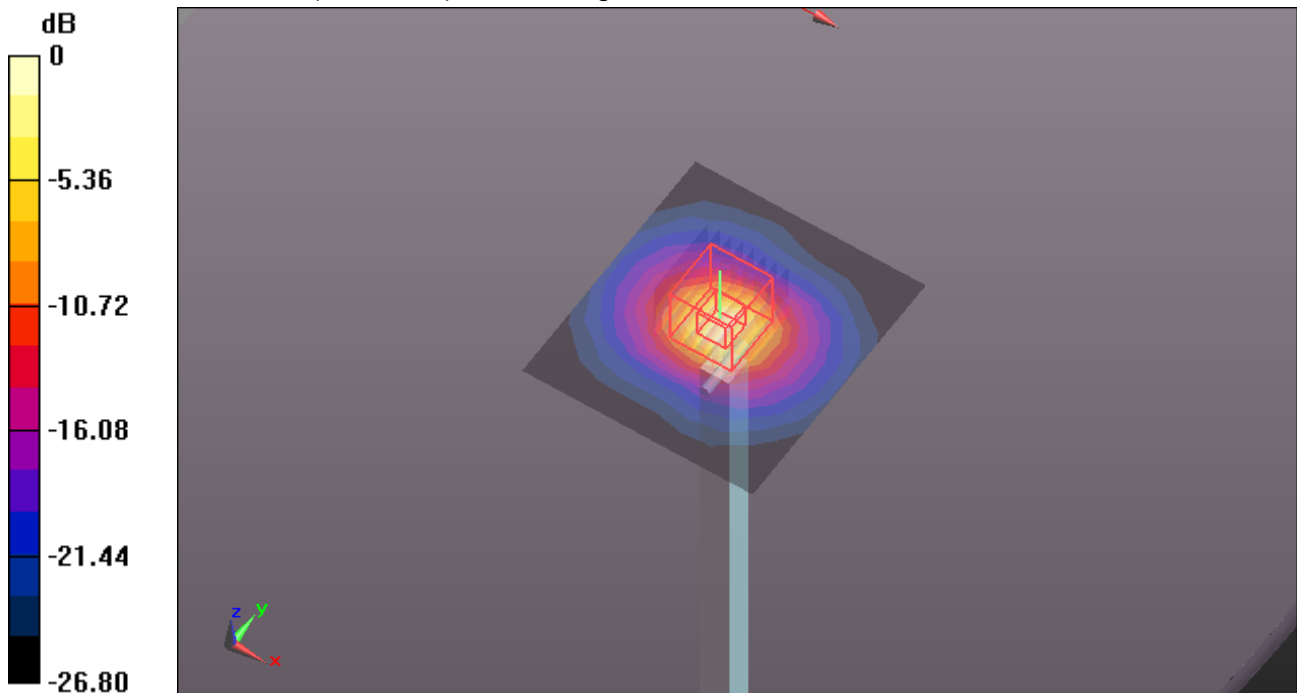

0 dB = 16.4 W/kg = 12.15 dBW/kg

Test Laboratory: Compliance Certification Services Inc.

Date: 4/19/2017

System Performance Check-Body D5500

DUT: Dipole D5GHzV2; Type: D5GHzV2; Serial: 1095

Communication System: UID 0, CW (0); Communication System Band: D5GHz (5000.0 - 6000.0 MHz);
Frequency: 5500 MHz; Duty Cycle: 1:1

Medium parameters used: $f = 5500$ MHz; $\sigma = 5.501$ S/m; $\epsilon_r = 48.292$; $\rho = 1000$ kg/m³

Room Ambient Temperature: 22°C; Liquid Temperature: 21.5°C

Phantom section: Flat Section

Measurement Standard: DASYS (IEEE/IEC/ANSI C63.19-2007)

DASY Configuration:

- Probe: EX3DV4 - SN3798; ConvF(4.23, 4.23, 4.23); Calibrated: 7/27/2016;
- Sensor-Surface: 1.4mm (Mechanical Surface Detection)
- Electronics: DAE4 Sn1245; Calibrated: 7/26/2016
- Phantom: ELI v4.0; Type: QDOVA001BB; Serial: TP:xxxx
- DASYS 52.8.8(1222);
- SEMCAD X Version 14.6.10 (7331)

System Performance Check with D5GHzV2 Dipole (graded grid)/d=10mm, Pin=100mW, f=5500 MHz/Area Scan (9x10x1): Measurement grid: dx=10mm, dy=10mm

Maximum value of SAR (measured) = 15.1 W/kg

System Performance Check with D5GHzV2 Dipole (graded grid)/d=10mm, Pin=100mW, f=5500 MHz/Zoom Scan (4x4x1.4mm, graded), dist=1.4mm (8x8x7)/Cube 0: Measurement grid: dx=4mm, dy=4mm, dz=1.4mm

Reference Value = 65.25 V/m; Power Drift = 0.01 dB

Peak SAR (extrapolated) = 32.9 W/kg

Peak SAR (extrapolated) = 32.9 W/kg

SAR(1 g) = 7.78 W/kg; SAR(10 g) = 2.39 W/kg

Maximum value of SAR (measured) = 18.1 W/kg

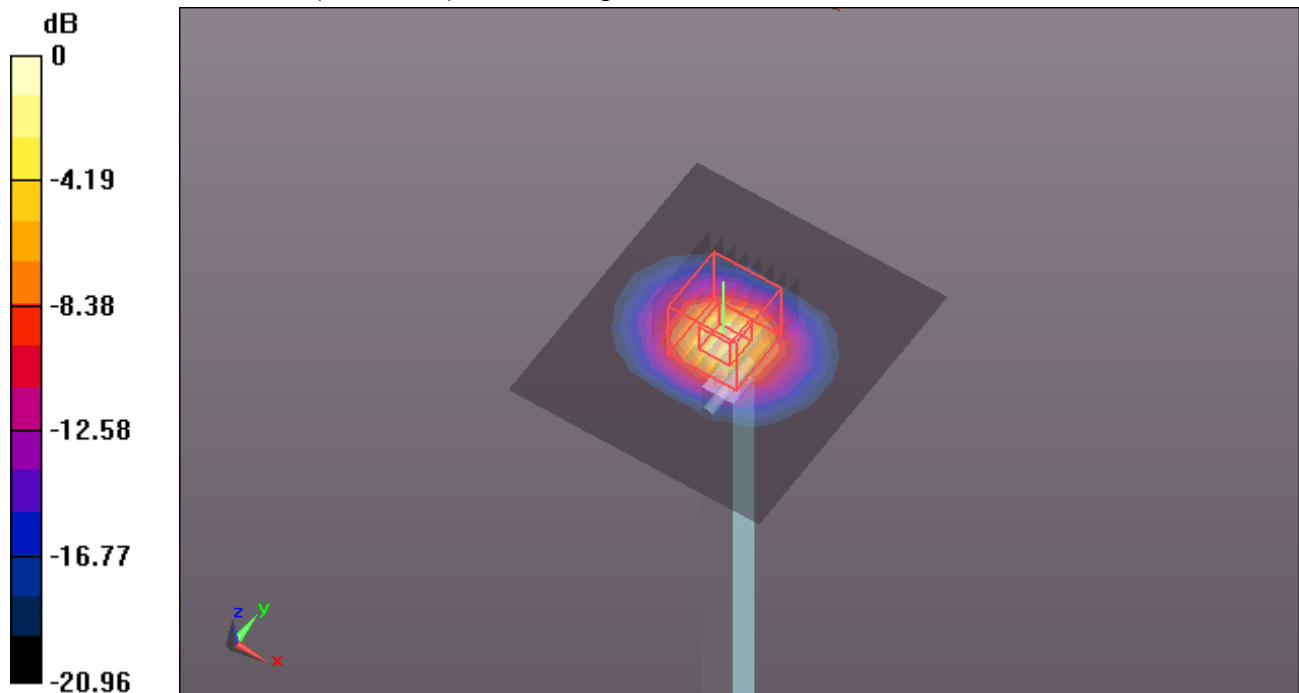

0 dB = 18.1 W/kg = 12.58 dBW/kg

Test Laboratory: Compliance Certification Services Inc.

Date: 4/19/2017

System Performance Check-Body D5600

DUT: Dipole D5GHzV2; Type: D5GHzV2; Serial: 1095

Communication System: UID 0, CW (0); Communication System Band: D5GHz (5000.0 - 6000.0 MHz); Frequency: 5600 MHz; Duty Cycle: 1:1

Medium parameters used: $f = 5600$ MHz; $\sigma = 5.736$ S/m; $\epsilon_r = 48.176$; $\rho = 1000$ kg/m³

Room Ambient Temperature: 22°C; Liquid Temperature: 21.5°C

Phantom section: Flat Section

Measurement Standard: DASYS (IEEE/IEC/ANSI C63.19-2007)

DASY Configuration:

- Probe: EX3DV4 - SN3798; ConvF(4.18, 4.18, 4.18); Calibrated: 7/27/2016;
- Sensor-Surface: 1.4mm (Mechanical Surface Detection)
- Electronics: DAE4 Sn1245; Calibrated: 7/26/2016
- Phantom: ELI v4.0; Type: QDOVA001BB; Serial: TP:xxxx
- DASY52 52.8.8(1222);
- SEMCAD X Version 14.6.10 (7331)

System Performance Check with D5GHzV2 Dipole (graded grid)/d=10mm, Pin=100mW, f=5600 MHz/Area Scan (9x10x1): Measurement grid: dx=10mm, dy=10mm

Maximum value of SAR (measured) = 15.6 W/kg

System Performance Check with D5GHzV2 Dipole (graded grid)/d=10mm, Pin=100mW, f=5600 MHz/Zoom Scan (4x4x1.4mm, graded), dist=1.4mm (8x8x7)/Cube 0: Measurement grid: dx=4mm, dy=4mm, dz=1.4mm

Reference Value = 65.80 V/m; Power Drift = 0.10 dB

Peak SAR (extrapolated) = 35.0 W/kg

Peak SAR (extrapolated) = 35.0 W/kg

SAR(1 g) = 7.79 W/kg; SAR(10 g) = 2.34 W/kg

Maximum value of SAR (measured) = 19.1 W/kg

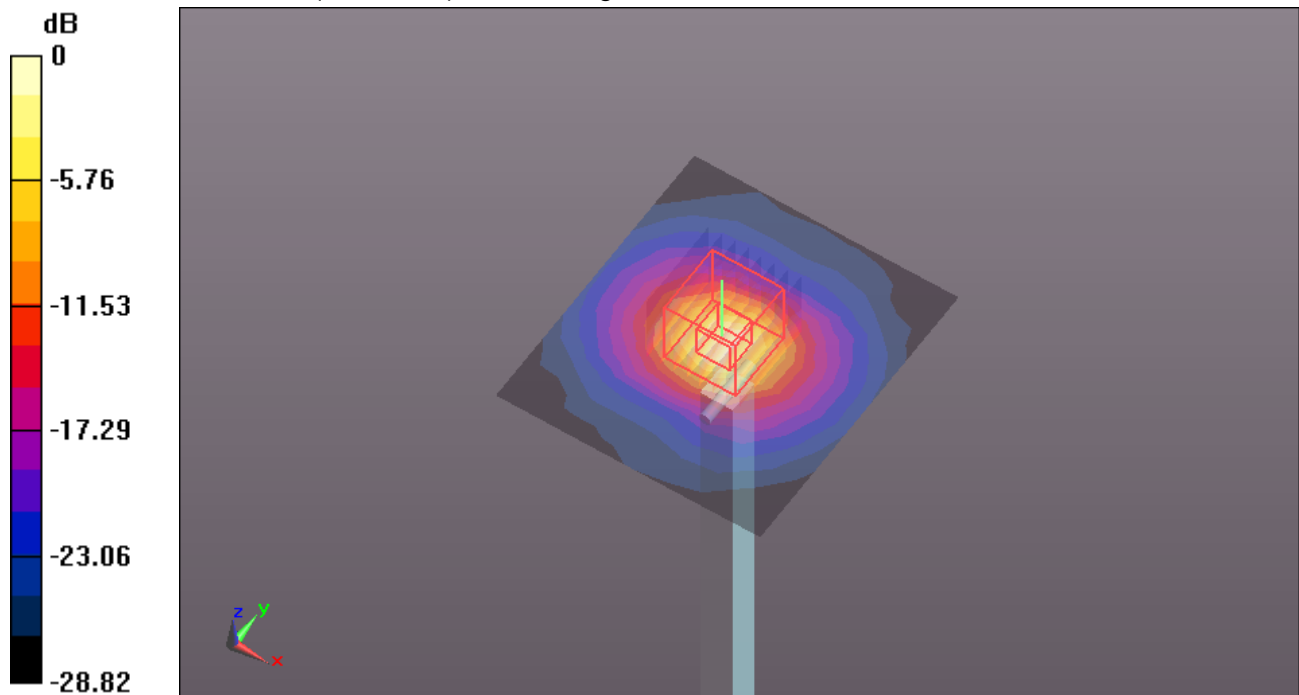

0 dB = 19.1 W/kg = 12.81 dBW/kg

Test Laboratory: Compliance Certification Services Inc.

Date: 4/19/2017

System Performance Check-Body D5800

DUT: Dipole D5GHzV2; Type: D5GHzV2; Serial: 1095

Communication System: UID 0, CW (0); Communication System Band: D5GHz (5000.0 - 6000.0 MHz);
Frequency: 5800 MHz; Duty Cycle: 1:1

Medium parameters used: $f = 5800$ MHz; $\sigma = 6.117$ S/m; $\epsilon_r = 47.901$; $\rho = 1000$ kg/m³

Room Ambient Temperature: 22°C; Liquid Temperature: 21.5°C

Phantom section: Flat Section

Measurement Standard: DASYS (IEEE/IEC/ANSI C63.19-2007)

DASY Configuration:

- Probe: EX3DV4 - SN3798; ConvF(4.34, 4.34, 4.34); Calibrated: 7/27/2016;
- Sensor-Surface: 1.4mm (Mechanical Surface Detection)
- Electronics: DAE4 Sn1245; Calibrated: 7/26/2016
- Phantom: ELI v4.0; Type: QDOVA001BB; Serial: TP:xxxx
- DASYS 52.8.8(1222);
- SEMCAD X Version 14.6.10 (7331)

System Performance Check with D5GHzV2 Dipole (graded grid)/d=10mm, Pin=100mW, f=5800 MHz/Area Scan (9x10x1): Measurement grid: dx=10mm, dy=10mm

Maximum value of SAR (measured) = 15.3 W/kg

System Performance Check with D5GHzV2 Dipole (graded grid)/d=10mm, Pin=100mW, f=5800 MHz/Zoom Scan (4x4x1.4mm, graded), dist=1.4mm (8x8x7)/Cube 0: Measurement grid: dx=4mm, dy=4mm, dz=1.4mm

Reference Value = 63.10 V/m; Power Drift = 0.08 dB

Peak SAR (extrapolated) = 34.2 W/kg

Peak SAR (extrapolated) = 34.2 W/kg

SAR(1 g) = 7.82 W/kg; SAR(10 g) = 2.39 W/kg

Maximum value of SAR (measured) = 18.4 W/kg

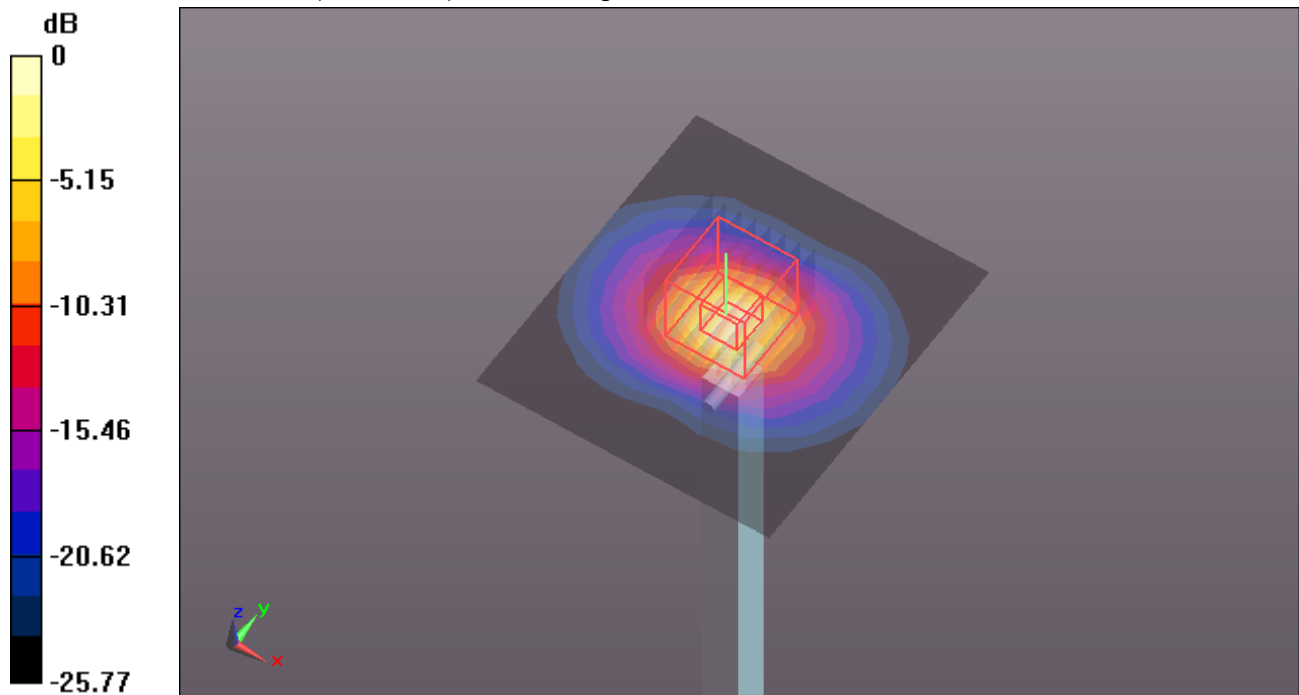

0 dB = 18.4 W/kg = 12.65 dBW/kg

Test Laboratory: Compliance Certification Services Inc.

Date: 5/12/2017

System Performance Check-Body D2450

DUT: Dipole 2450 MHz D2450V2; Type: D24500V2; Serial: 817

Communication System: UID 0, CW; Communication System Band: D2450 (2450.0 MHz); Frequency: 2450 MHz; Duty Cycle: 1:1

Medium parameters used: $f = 2450$ MHz; $\sigma = 1.951$ S/m; $\epsilon_r = 51.705$; $\rho = 1000$ kg/m³

Room Ambient Temperature: 22°C; Liquid Temperature: 21.5°C

Phantom section: Flat Section

Measurement Standard: DASY5 (IEEE/IEC/ANSI C63.19-2007)

DASY Configuration:

- Probe: EX3DV4 - SN3798; ConvF(7.07, 7.07, 7.07); Calibrated: 7/27/2016;
- Sensor-Surface: 2mm (Mechanical Surface Detection)
- Electronics: DAE4 Sn1245; Calibrated: 7/26/2016
- Phantom: ELI v4.0; Type: QDOVA001BB; Serial: TP:xxxx
- DASY52 52.8.8(1222);
- SEMCAD X Version 14.6.10 (7331)

System Performance Check at Frequencies above 1 GHz/Pin=250 mW, dist=10mm (EX-Probe)/Area Scan (9x10x1): Measurement grid: dx=12mm, dy=12mm

Maximum value of SAR (measured) = 16.9 W/kg

System Performance Check at Frequencies above 1 GHz/Pin=250 mW, dist=10mm (EX-Probe)/Zoom Scan (7x7x7) (7x7x7)/Cube 0: Measurement grid: dx=5mm, dy=5mm, dz=5mm

Reference Value = 98.29 V/m; Power Drift = -0.01 dB

Peak SAR (extrapolated) = 25.9 W/kg

SAR(1 g) = 12.5 W/kg; SAR(10 g) = 5.76 W/kg

Maximum value of SAR (measured) = 19.2 W/kg

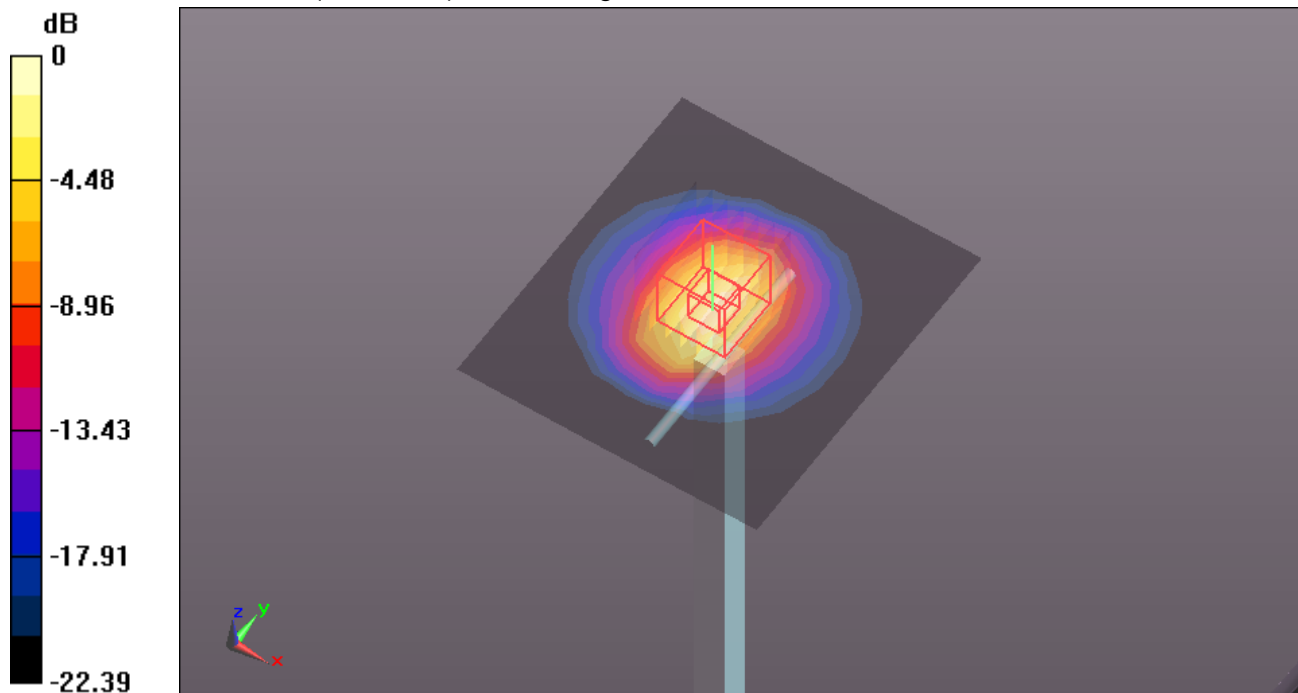

0 dB = 19.2 W/kg = 12.83 dBW/kg

Test Laboratory: Compliance Certification Services Inc.

Date: 5/12/2017

System Performance Check-Body D5600

DUT: Dipole D5GHzV2; Type: D5GHzV2; Serial: 1095

Communication System: UID 0, CW (0); Communication System Band: D5GHz (5000.0 - 6000.0 MHz);
Frequency: 5600 MHz; Duty Cycle: 1:1

Medium parameters used: $f = 5600$ MHz; $\sigma = 5.925$ S/m; $\epsilon_r = 46.639$; $\rho = 1000$ kg/m³

Room Ambient Temperature: 22°C; Liquid Temperature: 21.5°C

Phantom section: Flat Section

Measurement Standard: DASYS (IEEE/IEC/ANSI C63.19-2007)

DASY Configuration:

- Probe: EX3DV4 - SN3798; ConvF(4.18, 4.18, 4.18); Calibrated: 7/27/2016;
- Sensor-Surface: 1.4mm (Mechanical Surface Detection)
- Electronics: DAE4 Sn1245; Calibrated: 7/26/2016
- Phantom: ELI v4.0; Type: QDOVA001BB; Serial: TP:xxxx
- DASYS 52.8.8(1222);
- SEMCAD X Version 14.6.10 (7331)

System Performance Check with D5GHzV2 Dipole (graded grid)/d=10mm, Pin=100mW, f=5600 MHz/Area Scan (9x10x1): Measurement grid: dx=10mm, dy=10mm

Maximum value of SAR (measured) = 18.2 W/kg

System Performance Check with D5GHzV2 Dipole (graded grid)/d=10mm, Pin=100mW, f=5600 MHz/Zoom Scan (4x4x1.4mm, graded), dist=1.4mm (8x8x7)/Cube 0: Measurement grid: dx=4mm, dy=4mm, dz=1.4mm

Reference Value = 65.00 V/m; Power Drift = 0.11 dB

Peak SAR (extrapolated) = 37.8 W/kg

Peak SAR (extrapolated) = 37.8 W/kg

SAR(1 g) = 7.96 W/kg; SAR(10 g) = 2.21 W/kg

Maximum value of SAR (measured) = 20.6 W/kg

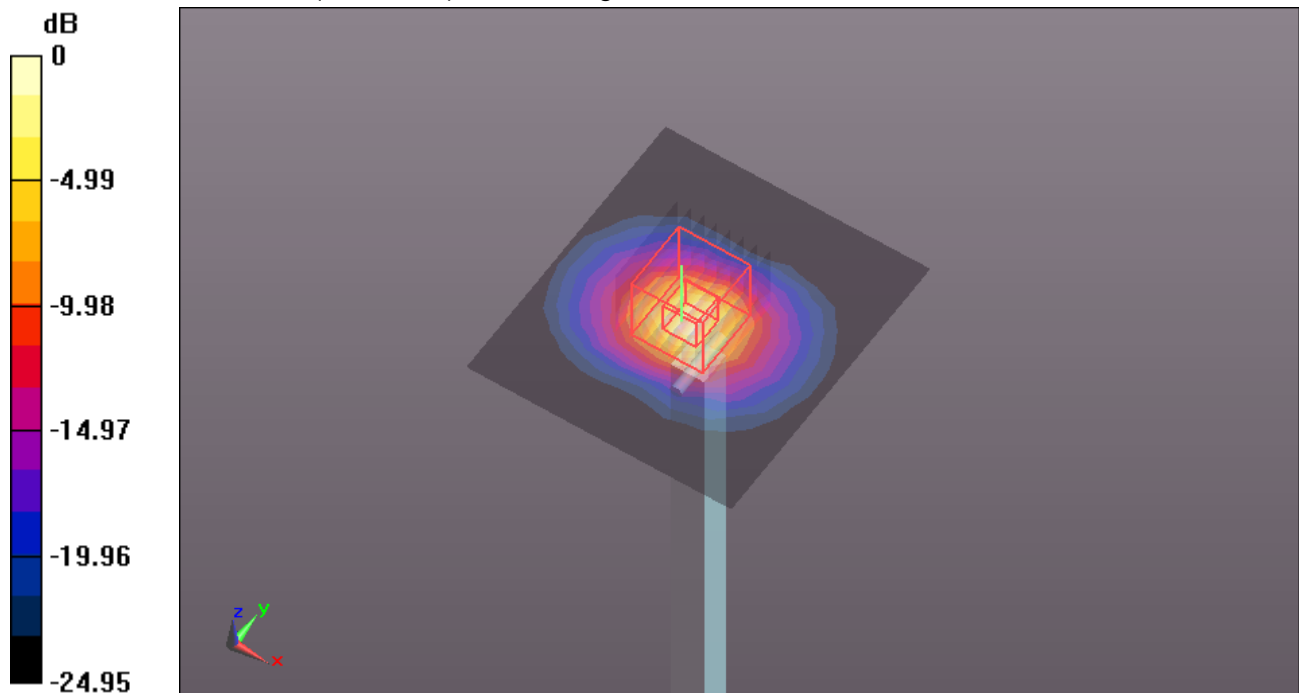

0 dB = 20.6 W/kg = 13.14 dBW/kg

Test Laboratory: Compliance Certification Services Inc.

Date: 5/16/2017

System Performance Check-Body D2450

DUT: Dipole 2450 MHz D2450V2; Type: D24500V2; Serial: 817

Communication System: UID 0, CW; Communication System Band: D2450 (2450.0 MHz); Frequency: 2450 MHz; Duty Cycle: 1:1

Medium parameters used: $f = 2450$ MHz; $\sigma = 1.969$ S/m; $\epsilon_r = 51.052$; $\rho = 1000$ kg/m³

Room Ambient Temperature: 22°C; Liquid Temperature: 21.5°C

Phantom section: Flat Section

Measurement Standard: DASYS (IEEE/IEC/ANSI C63.19-2007)

DASY Configuration:

- Probe: EX3DV4 - SN3798; ConvF(7.07, 7.07, 7.07); Calibrated: 7/27/2016;
- Sensor-Surface: 2mm (Mechanical Surface Detection)
- Electronics: DAE4 Sn1245; Calibrated: 7/26/2016
- Phantom: ELI v4.0; Type: QDOVA001BB; Serial: TP:xxxx
- DASYS 52.8.8(1222);
- SEMCAD X Version 14.6.10 (7331)

System Performance Check at Frequencies above 1 GHz/Pin=250 mW, dist=10mm (EX-Probe)/Area Scan (9x10x1): Measurement grid: dx=12mm, dy=12mm

Maximum value of SAR (measured) = 17.0 W/kg

System Performance Check at Frequencies above 1 GHz/Pin=250 mW, dist=10mm (EX-Probe)/Zoom Scan (7x7x7) (7x7x7)/Cube 0: Measurement grid: dx=5mm, dy=5mm, dz=5mm

Reference Value = 98.29 V/m; Power Drift = -0.01 dB

Peak SAR (extrapolated) = 26.1 W/kg

SAR(1 g) = 12.6 W/kg; SAR(10 g) = 6.12 W/kg

Maximum value of SAR (measured) = 19.4 W/kg

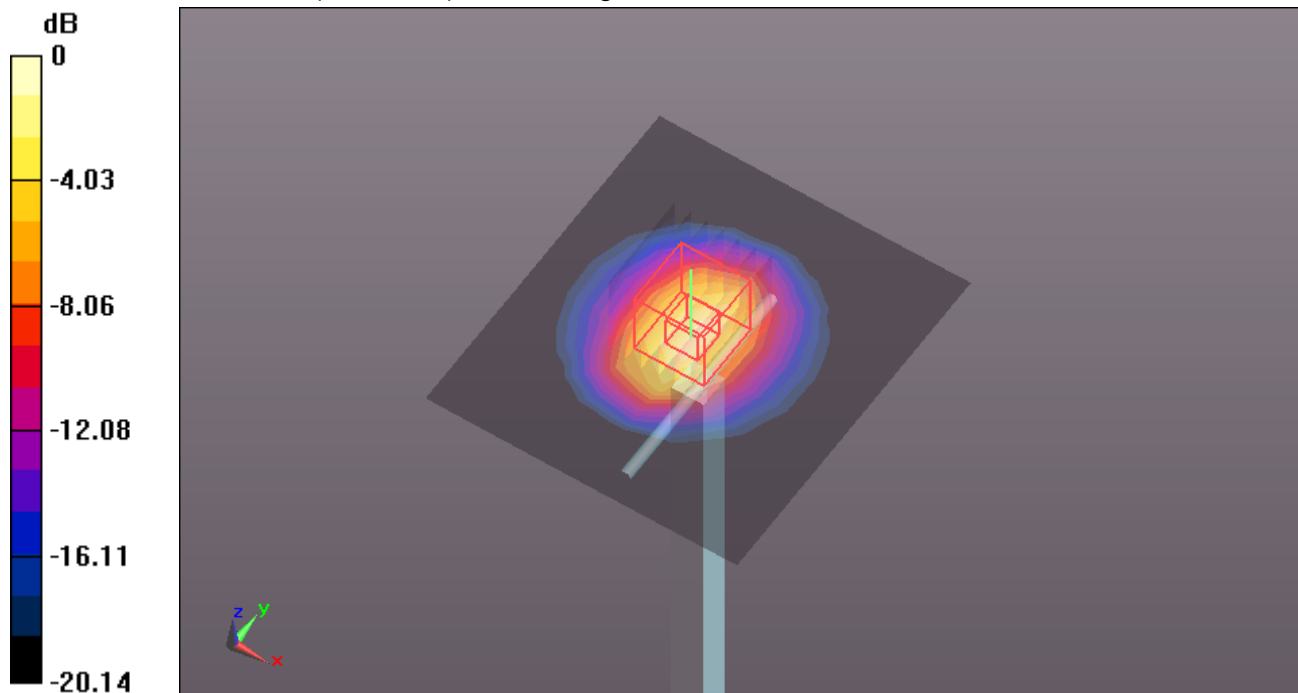

0 dB = 19.4 W/kg = 12.88 dBW/kg

APPENDIX B: PLOTS OF SAR TEST RESULT

The DASY Calibration Certificates are showing in the file named Appendix B Plots of SAR Test Result .

APPENDIX C: DASY CALIBRATION CERTIFICATE

The plots are showing in the file named Appendix C: DASY Calibration Certificate

END REPORT