

**FCC 47 CFR PART 15 SUBPART C &  
INDUSTRY CANADA RSS-247**

**TEST REPORT**

**For**

**Tablet Computer**

**Model: A6003**

**Trade Name: acer**

*Issued to*

**Acer Incorporated**

**8F, 88, Sec 1, Xintai 5th Rd. Xizhi, New Taipei City 221 Taiwan, R.O.C**

*Issued by*

**Compliance Certification Services Inc.**

**No.11, Wugong 6th Rd., Wugu Dist.,**

**New Taipei City 24891, Taiwan. (R.O.C.)**

**<http://www.ccsrf.com>**

**[service@ccsrf.com](mailto:service@ccsrf.com)**

**Issued Date: June 2, 2016**



**Testing Laboratory  
1309**

---

**Note:** This report shall not be reproduced except in full, without the written approval of Compliance Certification Services Inc. This document may be altered or revised by Compliance Certification Services Inc. personnel only, and shall be noted in the revision section of the document.

**Revision History**

Rev.	Issue Date	Revisions	Effect Page	Revised By
00	June 2, 2016	Initial Issue	ALL	Kelly Cheng

## TABLE OF CONTENTS

<b>1. TEST RESULT CERTIFICATION.....</b>	<b>4</b>
<b>2. EUT DESCRIPTION.....</b>	<b>5</b>
<b>3. TEST METHODOLOGY.....</b>	<b>6</b>
3.1 EUT CONFIGURATION .....	6
3.2 EUT EXERCISE .....	6
3.3 GENERAL TEST PROCEDURES .....	6
3.4 FCC PART 15.205 RESTRICTED BANDS OF OPERATIONS.....	7
3.5 DESCRIPTION OF TEST MODES .....	8
<b>4. INSTRUMENT CALIBRATION.....</b>	<b>9</b>
4.1 MEASURING INSTRUMENT CALIBRATION .....	9
4.2 MEASUREMENT EQUIPMENT USED .....	9
4.3 MEASUREMENT UNCERTAINTY .....	10
<b>5. FACILITIES AND ACCREDITATIONS.....</b>	<b>11</b>
5.1 FACILITIES.....	11
5.2 EQUIPMENT .....	11
5.3 TABLE OF ACCREDITATIONS AND LISTINGS.....	12
<b>6. SETUP OF EQUIPMENT UNDER TEST.....</b>	<b>13</b>
6.1 SETUP CONFIGURATION OF EUT .....	13
6.2 SUPPORT EQUIPMENT .....	13
<b>7. FCC PART 15.247 REQUIREMENTS &amp; RSS 247 REQUIREMENTS.....</b>	<b>14</b>
7.1 99% BANDWIDTH.....	14
7.2 20 DB BANDWIDTH .....	19
7.3 PEAK POWER .....	24
7.4 AVERAGE POWER.....	25
7.5 BAND EDGES MEASUREMENT.....	26
7.6 FREQUENCY SEPARATION .....	44
7.7 NUMBER OF HOPPING FREQUENCY .....	50
7.8 TIME OF OCCUPANCY (DWELL TIME).....	52
7.9 RADIATED EMISSIONS.....	54
7.10 POWERLINE CONDUCTED EMISSIONS.....	72
<b>APPENDIX I PHOTOGRAPHS OF TEST SETUP.....</b>	<b>75</b>

## 1. TEST RESULT CERTIFICATION

**Applicant:** Acer Incorporated  
8F, 88, Sec 1, Xintai 5th Rd. Xizhi, New Taipei City 221  
Taiwan, R.O.C

**Manufacturer:** Acer Incorporated  
8F, 88, Sec 1, Xintai 5th Rd. Xizhi, New Taipei City 221  
Taiwan, R.O.C

**Equipment Under Test:** Tablet Computer

**Model Number:** A6003

**Trade Name:** acer

**Date of Test:** May 31 ~ June 2, 2016

APPLICABLE STANDARDS	
STANDARD	TEST RESULT
FCC 47 CFR Part 15 Subpart C Industry Canada RSS-247 Issue 1	No non-compliance noted

### We hereby certify that:

The above equipment was tested by Compliance Certification Services Inc. The test data, data evaluation, test procedures, and equipment configurations shown in this report were made in accordance with the procedures given in ANSI C63.10: 2013 and the energy emitted by the sample EUT tested as described in this report is in compliance with the requirements set forth in the above standards. The test results of this report relate only to the tested sample EUT identified in this report.

Approved by:

Tested by:

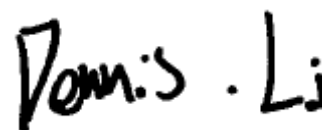

---

Miller Lee  
Manager  
Compliance Certification Services Inc.

---

Dennis Li  
Engineer  
Compliance Certification Services Inc.

## 2. EUT DESCRIPTION

<b>Product</b>	Tablet Computer
<b>Model Number</b>	A6003
<b>Trade Name</b>	acer
<b>Received Date</b>	May 13, 2016
<b>Power Supply</b>	1.VDC from Power Adapter 2. Power from Battery 3. Powered from host device via USB
<b>Frequency Range</b>	2402 ~ 2480 MHz
<b>Transmit Power</b>	0.42 dBm
<b>Modulation Technique</b>	GFSK for 1Mbps; $\pi/4$ -DQPSK for 2Mbps; 8DPSK for 3Mbps
<b>Number of Channels</b>	79 Channels
<b>Antenna Specification</b>	Model: A10L FPC Antenna / Gain: 2.66dBi

**Remark:**

1. The sample selected for test was engineering sample that approximated to production product and was provided by manufacturer.
2. This submittal(s) (test report) is intended for FCC: **HLZA6003** & ISED No. : **1754F-A6003** filing to comply with FCC Part 15C, Section 15.207, 15.209 and IC RSS-247 & RSS-GEN.
3. Keypast List :

Components	Vendor	Model Name or Key Spec.
EMMC(FLASH)	Hynix	H26M52103FMR (16GB)
CPU	MTK	MT8163V/B (64-bit Quad Cortex A53)
DDR3L	Hynix	H5TC4G63AFR-PBA (1GB / 256*16)
M/B	Sun & lynn	A10L_V1.1 (94V-0)
10.1" LCD Panel	Kingdisplay	KD101N37-40NA-A10
Battery	TCL	PR-279594N (1ICP3/95/94-2) 3.7V, 6100mAh / 22.57Wh
Front Camera module	microkore	W05P4021 V2 (GC2355)
Rear Camera module	microkore	W05P4021 V2 (OV5670)
Speaker left	Haosheng	XHB160903B08-08-B-RH (8Ω)
Speaker right	Haosheng	XHB160903B08-07-B-RH (8Ω)
Adapter	Delta	ADP-10HW A I/P: 100-240Vac~, 0.4A, 50-60Hz O/P: 5.35Vdc, 2.0A
	Lite-On	PA-1100-25 I/P: 100-240Vac~, 0.3A, 50/60Hz O/P: 5.2Vdc, 2.0A
RF Module	MTK	MT6625LN/BT, WIFI

### **3. TEST METHODOLOGY**

The tests documented in this report were performed in accordance with ANSI C63.10: 2013 and FCC CFR 47 2.1046, 2.1047, 2.1049, 2.1051, 2.1053, 2.1055, 2.1057, 15.207, 15.209, 15.247, DA00-705 and KDB 558074 D01 DTS Meas Guidance v03r05.

The tests documented in this report were performed in accordance with IC RSS-247, IC RSS-Gen and ANSI C63.10:2013.

This submittal(s) (test report) is intended for IC Certification with Industry Canada RSS-247.

#### **3.1 EUT CONFIGURATION**

The EUT configuration for testing is installed on RF field strength measurement to meet the Commissions requirement and operating in a manner that intends to maximize its emission characteristics in a continuous normal application.

#### **3.2 EUT EXERCISE**

The EUT was operated in the engineering mode to fix the TX frequency that was for the purpose of the measurements.

According to its specifications, the EUT must comply with the requirements of the Section 15.207, 15.209 and 15.247 under the FCC Rules Part 15 Subpart C.

The tests documented in this report were performed in accordance with IC RSS-247, IC RSS-Gen, IC RSS-102, and ANSI C63.10: 2013.

#### **3.3 GENERAL TEST PROCEDURES**

##### **Conducted Emissions**

According to the requirements in ANSI C63.10: 2013 Conducted emissions from the EUT measured in the frequency range between 0.15 MHz and 30MHz using CISPR Quasi-peak and average detector modes.

##### **Radiated Emissions**

The EUT is placed on a turn table, which is 1.5 m above ground plane. The turntable shall rotate 360 degrees to determine the position of maximum emission level. EUT is set 3m away from the receiving antenna, which varied from 1m to 4m to find out the highest emission. And also, each emission was to be maximized by changing the polarization of receiving antenna both horizontal and vertical. In order to find out the maximum emissions, exploratory radiated emission measurements were made according to the requirements in ANSI C63.10: 2013.

### 3.4 FCC PART 15.205 RESTRICTED BANDS OF OPERATIONS

(a) Except as shown in paragraph (d) of this section, only spurious emissions are permitted in any of the frequency bands listed below:

MHz	MHz	MHz	GHz
0.090 - 0.110	16.42 - 16.423	399.9 - 410	4.5 - 5.15
<sup>1</sup> 0.495 - 0.505	16.69475 - 16.69525	608 - 614	5.35 - 5.46
2.1735 - 2.1905	16.80425 - 16.80475	960 - 1240	7.25 - 7.75
4.125 - 4.128	25.5 - 25.67	1300 - 1427	8.025 - 8.5
4.17725 - 4.17775	37.5 - 38.25	1435 - 1626.5	9.0 - 9.2
4.20725 - 4.20775	73 - 74.6	1645.5 - 1646.5	9.3 - 9.5
6.215 - 6.218	74.8 - 75.2	1660 - 1710	10.6 - 12.7
6.26775 - 6.26825	108 - 121.94	1718.8 - 1722.2	13.25 - 13.4
6.31175 - 6.31225	123 - 138	2200 - 2300	14.47 - 14.5
8.291 - 8.294	149.9 - 150.05	2310 - 2390	15.35 - 16.2
8.362 - 8.366	156.52475 -	2483.5 - 2500	17.7 - 21.4
8.37625 - 8.38675	156.52525	2655 - 2900	22.01 - 23.12
8.41425 - 8.41475	156.7 - 156.9	3260 - 3267	23.6 - 24.0
12.29 - 12.293	162.0125 - 167.17	3332 - 3339	31.2 - 31.8
12.51975 - 12.52025	167.72 - 173.2	3345.8 - 3358	36.43 - 36.5
12.57675 - 12.57725	240 - 285	3600 - 4400	( <sup>2</sup> )
13.36 - 13.41	322 - 335.4		

<sup>1</sup> Until February 1, 1999, this restricted band shall be 0.490-0.510 MHz.

<sup>2</sup> Above 38.6

(b) Except as provided in paragraphs (d) and (e), the field strength of emissions appearing within these frequency bands shall not exceed the limits shown in Section 15.209. At frequencies equal to or less than 1000 MHz, compliance with the limits in Section 15.209 shall be demonstrated using measurement instrumentation employing a CISPR quasi-peak detector. Above 1000 MHz, compliance with the emission limits in Section 15.209 shall be demonstrated based on the average value of the measured emissions. The provisions in Section 15.35 apply to these measurements.

### 3.5 DESCRIPTION OF TEST MODES

The EUT (model: A6003) comes with two types of power adapter (model: PA-1100-25 / ADP-10HW A) for sale. After the preliminary test, the power adapter ADP-10HW A was found to emit the worst emissions and therefore had been tested under operating condition.

Software used to control the EUT for staying in continuous transmitting and receiving mode was programmed.

After verification, all tests carried out are with the worst-case test modes as shown below except radiated spurious emission below 1GHz and power line conducted emissions below 30MHz, which worst case was in normal link mode and receiving radiated spurious emission above 1GHz, which worst case was in CH Mid mode only.

Channel Low (2402MHz), Mid (2441MHz) and High (2480MHz) with 1Mbps data rate was chosen for full testing.

During the preliminary test, GFSK,  $\pi/4$ -QPSK & 8DPSK with DH1 were pre-tested and found that 8DPSK emits the highest output power. Then the tests were carried on with DH1 compare to DH3 & DH5 and found that 8DPSK with DH5 emit the highest output power, and therefore had been tested under operating condition.

Following channels were selected for the radiated emission testing only as listed below:

Tested Channel	Modulation Type	Packet Type	Date Rate
Low, Mid, High	GFSK	DH 5	1
Low, Mid, High	8DPSK	DH 5	3

The field strength of spurious emission was measured in the following position: EUT stand-up position (Z axis), lie-down position (X, Y axis). The worst emission was found in lie-down position (X axis) and the worst case was recorded.



## 4. INSTRUMENT CALIBRATION

### 4.1 MEASURING INSTRUMENT CALIBRATION

The measuring equipment, which was utilized in performing the tests documented herein, has been calibrated in accordance with the manufacturer's recommendations for utilizing calibration equipment, which is traceable to recognized national standards.

### 4.2 MEASUREMENT EQUIPMENT USED

#### Equipment Used for Emissions Measurement

*Remark: Each piece of equipment is scheduled for calibration once a year and Loop Antenna is scheduled for calibration once three years.*

Conducted Emissions Test Site					
Name of Equipment	Manufacturer	Model	Serial Number	Calibration Date	Calibration Due
DC Power Supplies	GW Instek	SPS-3610	GPE880163	01/19/2016	01/18/2017
Power Meter	Anritsu	ML2495A	1012009	07/08/2015	07/07/2016
Power Sensor	Anritsu	MA2411B	917072	07/08/2015	07/07/2016
Signal Analyzer	R&S	FSV 40	101073	07/20/2015	07/19/2016
Spectrum Analyzer	Agilent	E4446A	US42510268	02/15/2016	02/14/2017
Thermostatic/Hrgrosatic Chamber	TAICHY	MHG-150LF	930619	10/08/2015	10/07/2016
Vector Signal Generator	R&S	SMU 200A	102239	03/10/2016	03/09/2017
AC Power Source	EXTECH	6205	1140845	N.C.R	N.C.R

Wugu 966 Chamber A					
Name of Equipment	Manufacturer	Model	Serial Number	Calibration Date	Calibration Due
Bilog Antenna	Sunol Sciences	JB3	A030105	08/06/2015	08/05/2016
EMI Test Receiver	R&S	ESCI	100064	06/05/2015	06/03/2016
Horn Antenna	EMCO	3117	55165	02/24/2016	02/23/2017
Horn Antenna	EMCO	3116	26370	01/15/2016	01/14/2017
K Type Cable	Huber+Suhner	SUCOFLEX 102	29406/2	01/12/2016	01/11/2017
K Type Cable	Huber+Suhner	SUCOFLEX 102	22470/2	01/12/2016	01/11/2017
Pre-Amplifier	MITEQ	AMF-6F-260400-40-8P	985646	01/14/2016	01/13/2017
Pre-Amplifier	EMCI	EMC 012635	980151	06/05/2015	06/04/2016
Pre-Amplifier	EMCI	EM330	N/A	06/05/2015	06/04/2016
Spectrum Analyzer	Agilent	E4446A	US42510252	12/08/2015	12/07/2016
Antenna Tower	CCS	CC-A-1F	N/A	N.C.R	N.C.R
Controller	CCS	CC-C-1F	N/A	N.C.R	N.C.R
Turn Table	CCS	CC-T-1F	N/A	N.C.R	N.C.R
Software	EZ-EMC (CCS-3A1RE)				

Conducted Emission Room # B					
Name of Equipment	Manufacturer	Model	Serial Number	Calibration Date	Calibration Due
Capacitive Voltage Probe	FCC	F-CVP-1	100185	03/09/2016	03/08/2017
EMI Test Receiver	R&S	ESCI	101073	09/09/2015	09/08/2016
LISN	SCHWARZBECK	NSLK 8127	8127-541	11/23/2015	11/22/2016
LISN	R&S	ENV216	101054	05/11/2016	05/10/2017
Test S/W	CCS-3A1-CE				

### 4.3 MEASUREMENT UNCERTAINTY

PARAMETER	UNCERTAINTY
Powerline Conducted Emission	+/- 1.2575
3M Semi Anechoic Chamber / 30M~200M	+/- 4.0138
3M Semi Anechoic Chamber / 200M~1000M	+/- 3.9483
3M Semi Anechoic Chamber / 1G~8G	+/- 2.5975
3M Semi Anechoic Chamber / 8G~18G	+/- 2.6112
3M Semi Anechoic Chamber / 18G~26G	+/- 2.7389
3M Semi Anechoic Chamber / 26G~40G	+/- 2.9683

**Remark:** This uncertainty represents an expanded uncertainty expressed at approximately the 95% confidence level using a coverage factor of  $k=2$ .

## 5. FACILITIES AND ACCREDITATIONS

### 5.1 FACILITIES

All measurement facilities used to collect the measurement data are located at

- No.199, Chunghsen Road, Hsintien City, Taipei Hsien, Taiwan, R.O.C.  
Tel: 886-2-2217-0894 / Fax: 886-2-2217-1029
- No.11, Wugong 6th Rd., Wugu Dist., New Taipei City 24891, Taiwan. (R.O.C.)  
Tel: 886-2-2299-9720 / Fax: 886-2-2298-4045
- No.81-1, Lane 210, Bade 2nd Rd., Lujhu Township, Taoyuan County 33841, TAIWAN,  
R.O.C.  
Tel: 886-3-324-0332 / Fax: 886-3-324-5235

The sites are constructed in conformance with the requirements of ANSI C63.7, ANSI C63.10: 2013 and CISPR Publication 22.

### 5.2 EQUIPMENT



Radiated emissions are measured with one or more of the following types of linearly polarized antennas: tuned dipole, biconical, log periodic, bi-log, ridged waveguide, horn and/or Loop. Spectrum analyzers with pre-selectors and quasi-peak detectors are used to perform radiated measurements.

Conducted emissions are measured with Line Impedance Stabilization Networks and EMI Test Receivers.

Calibrated wideband preamplifiers, coaxial cables, and coaxial attenuators are also used for making measurements.

All receiving equipment conforms to CISPR Publication 16-1, "Radio Interference Measuring Apparatus and Measurement Methods."

### 5.3 TABLE OF ACCREDITATIONS AND LISTINGS

Country	Agency	Scope of Accreditation	Logo
USA	FCC	3M Semi Anechoic Chamber (FCC MRA: TW1039) to perform FCC Part 15 measurements	 FCC MRA: TW1039
Taiwan	TAF	LP0002, RTTE01, FCC Method-47 CFR Part 15 Subpart C, D, E, RSS-247, RSS-310 IDA TS SRD, AS/NZS 4268, AS/NZS 4771, TS 12.1 & 12.2, ETSI EN 300 440-1, ETSI EN 300 440-2, ETSI EN 300 328, ETSI EN 300 220-1, ETSI EN 300 220-2, ETSI EN 301 893, ETSI EN 301 489-1/3/7/17 FCC OET Bulletin 65 + Supplement C, EN 50360, EN 50361, EN 50371, RSS 102, EN 50383, EN 50385, EN 50392, IEC 62209, CNS 14958-1, CNS 14959 FCC Method -47 CFR Part 15 Subpart B IEC / EN 61000-3-2, IEC / EN 61000-3-3, IEC / EN 61000-4-2/3/4/5/6/8/11	
Canada	Industry Canada	3M Semi Anechoic Chamber (IC 2324G-1 / IC 2324G-2) to perform	 IC 2324G-1 IC 2324G-2

*\* No part of this report may be used to claim or imply product endorsement by A2LA or any agency of the US Government.*

## 6. SETUP OF EQUIPMENT UNDER TEST

### 6.1 SETUP CONFIGURATION OF EUT

See test photographs attached in Appendix I for the actual connections between EUT and support equipment.

### 6.2 SUPPORT EQUIPMENT

No.	Device Type	Brand	Model	Series No.	FCC ID	Data Cable	Power Cord
	N/A						

**Remark:**

1. *All the equipment/cables were placed in the worst-case configuration to maximize the emission during the test.*
2. *Grounding was established in accordance with the manufacturer's requirements and conditions for the intended use.*

## 7. FCC PART 15.247 REQUIREMENTS & RSS 247 REQUIREMENTS

### 7.1 99% BANDWIDTH

#### Test Configuration

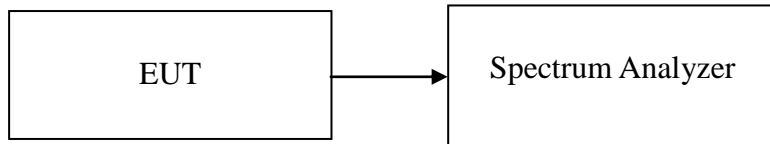

#### TEST PROCEDURE

The resolution bandwidth shall be set to as close to 1% of the selected span as is possible without being below 1%. The video bandwidth shall be set to 3 times the resolution bandwidth. Video averaging is not permitted. Where practical, a sampling detector shall be used since a peak or, peak hold.

#### TEST RESULTS

*No non-compliance noted.*

#### Test Data

##### For GFSK

Channel	Frequency (MHz)	99% Bandwidth (MHz)
Low	2402	0.9030
Mid	2441	0.9030
High	2480	0.9030

##### For 8DPSK

Channel	Frequency (MHz)	99% Bandwidth (MHz)
Low	2402	1.1722
Mid	2441	1.1766
High	2480	1.1809

**Test Plot**

**For GFSK / DH5**

**99% Bandwidth (CH Low)**

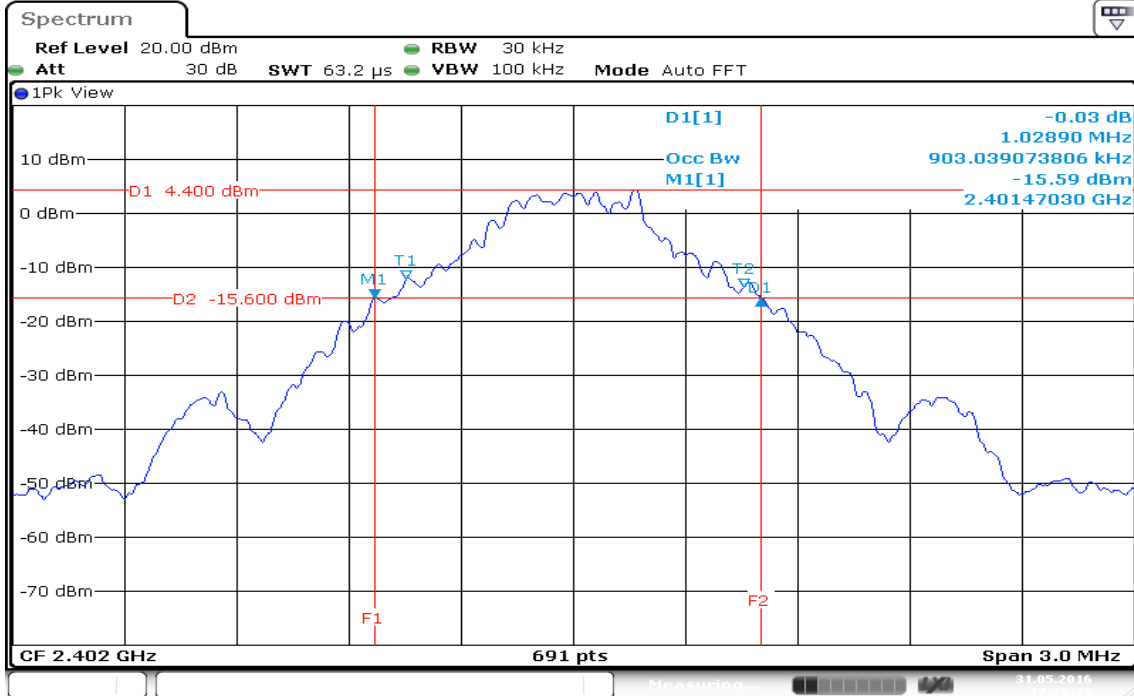

**99% Bandwidth (CH Mid)**

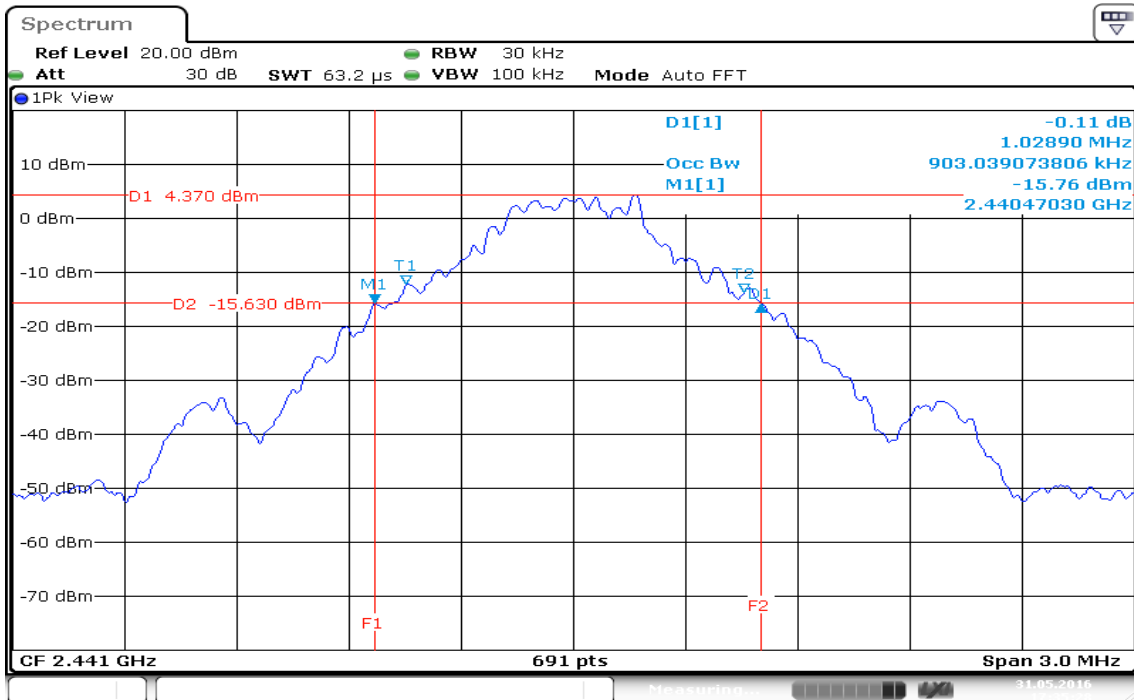

### 99% Bandwidth (CH High)

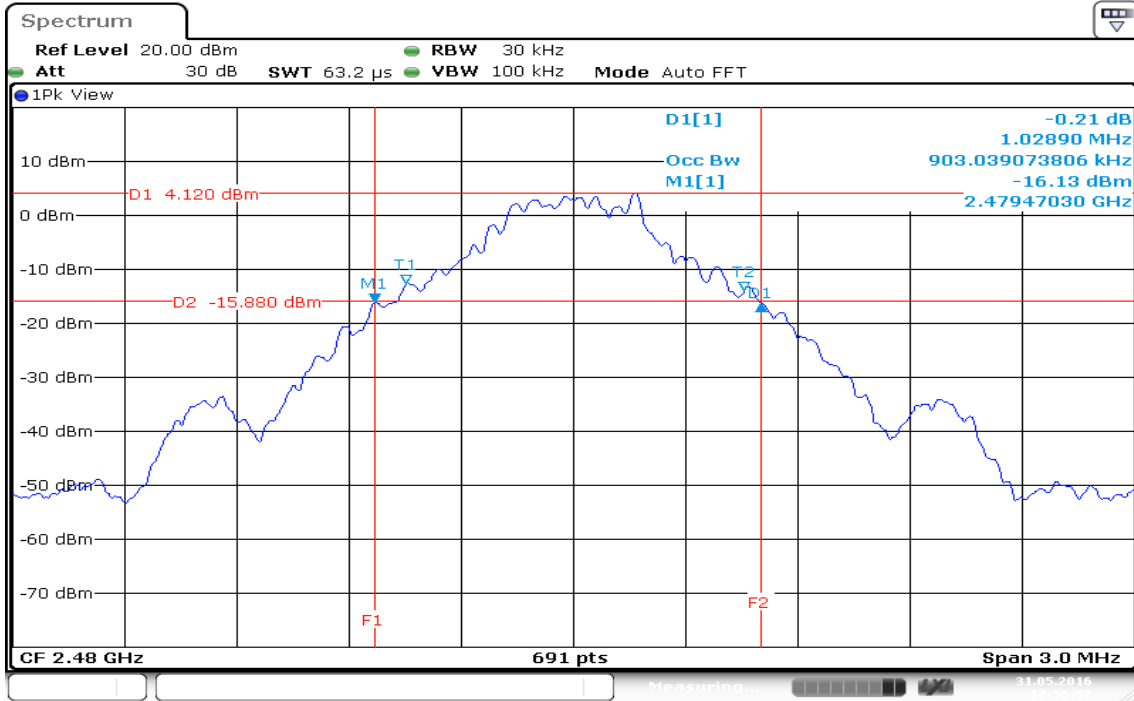

Date: 31.MAY.2016 17:56:57



**For 8DPSK / DH5**

**99% Bandwidth (CH Low)**

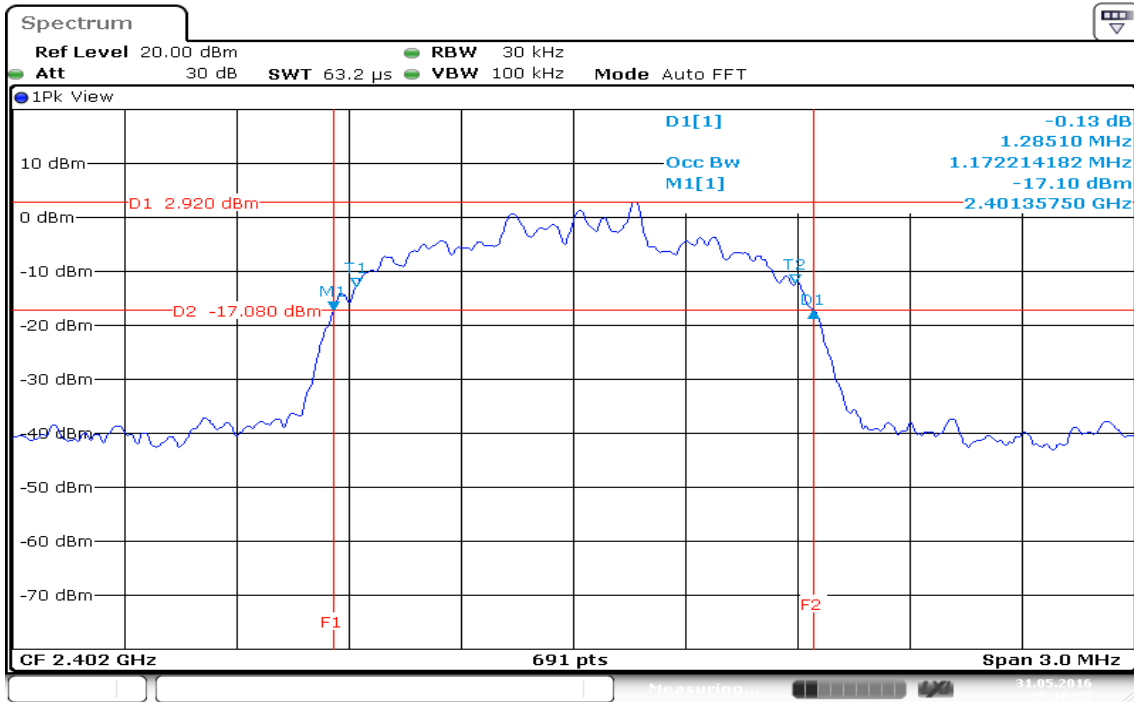

**99% Bandwidth (CH Mid)**

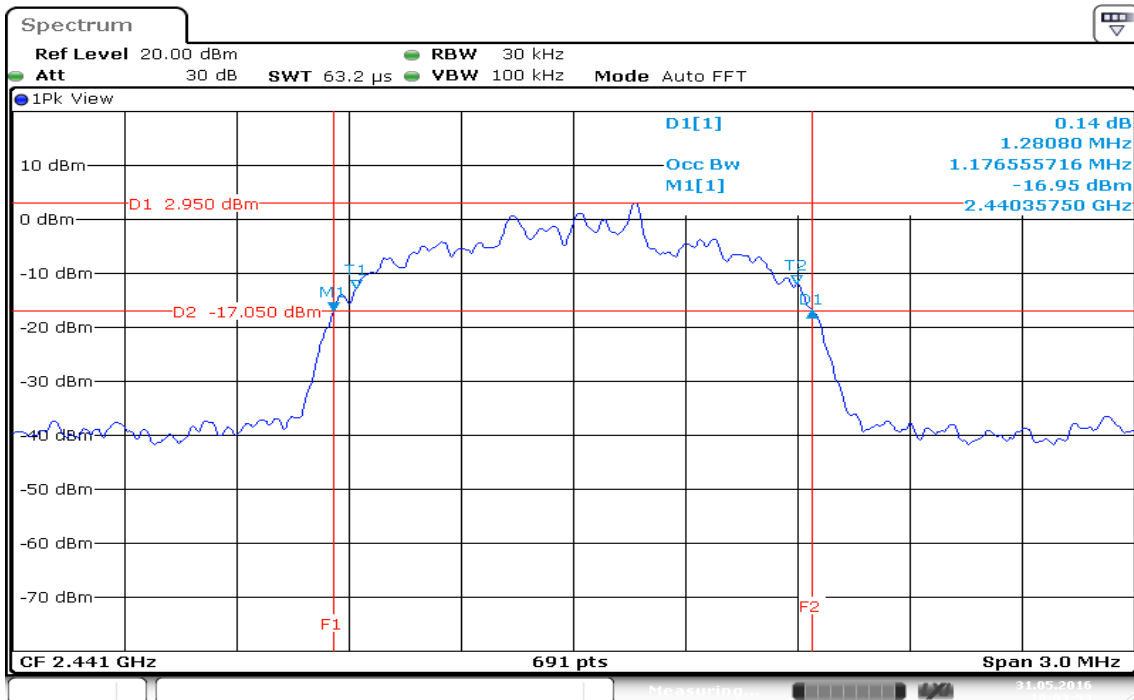

### 99% Bandwidth (CH High)

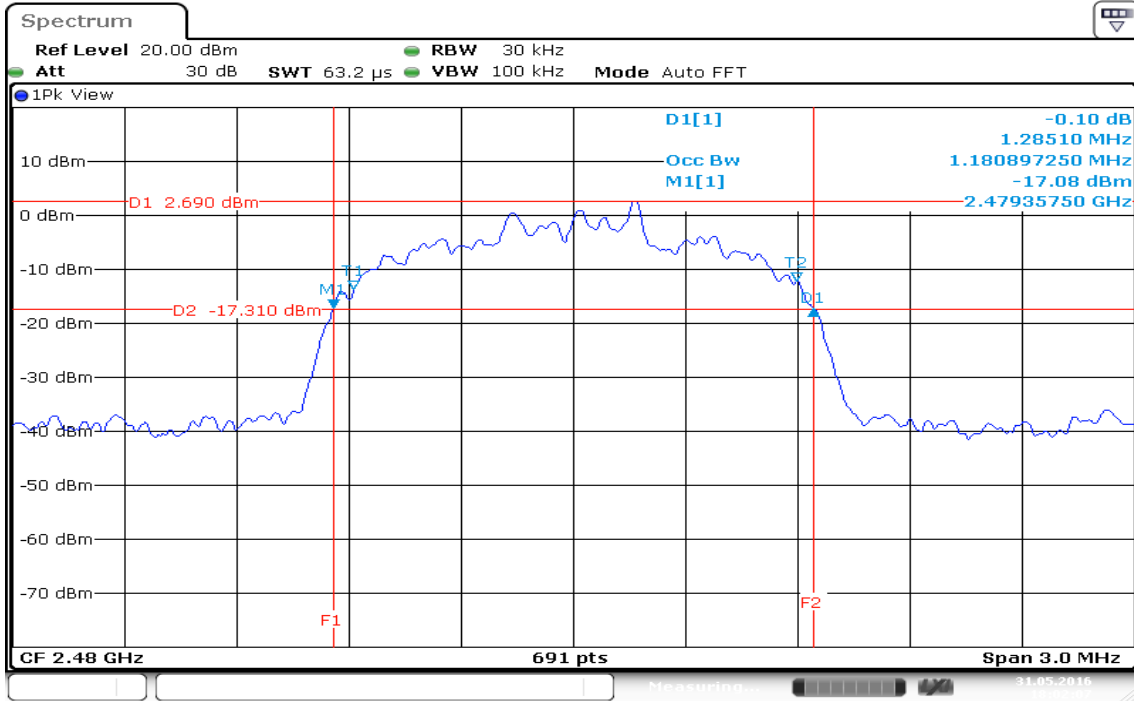

Date: 31.MAY.2016 18:02:07

## 7.2 20 dB Bandwidth

### LIMIT

None; for reporting purposes only.

### Test Configuration

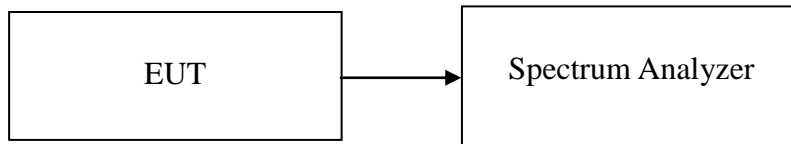

### TEST PROCEDURE

1. Place the EUT on the table and set it in the transmitting mode.
2. Remove the antenna from the EUT and then connect a low loss RF cable from the antenna port to the spectrum analyzer.
3. Set the spectrum analyzer as RBW=30 kHz, VBW = 100 kHz, Sweep = 3.2 ms.
4. Mark the peak frequency and 20dB (upper and lower) frequency.
5. Repeat until all the rest channels are investigated.

### TEST RESULTS

*No non-compliance noted.*

#### Test Data

##### **For GFSK / DH5**

Channel	Frequency (MHz)	20dB Bandwidth (MHz)
Low	2402	1.0289
Mid	2441	1.0289
High	2480	1.0289

##### **For 8DPSK / DH5**

Channel	Frequency (MHz)	20dB Bandwidth (MHz)
Low	2402	1.2851
Mid	2441	1.2808
High	2480	1.2851

**Test Plot**

**For GFSK / DH5**

**20dB Bandwidth (CH Low)**

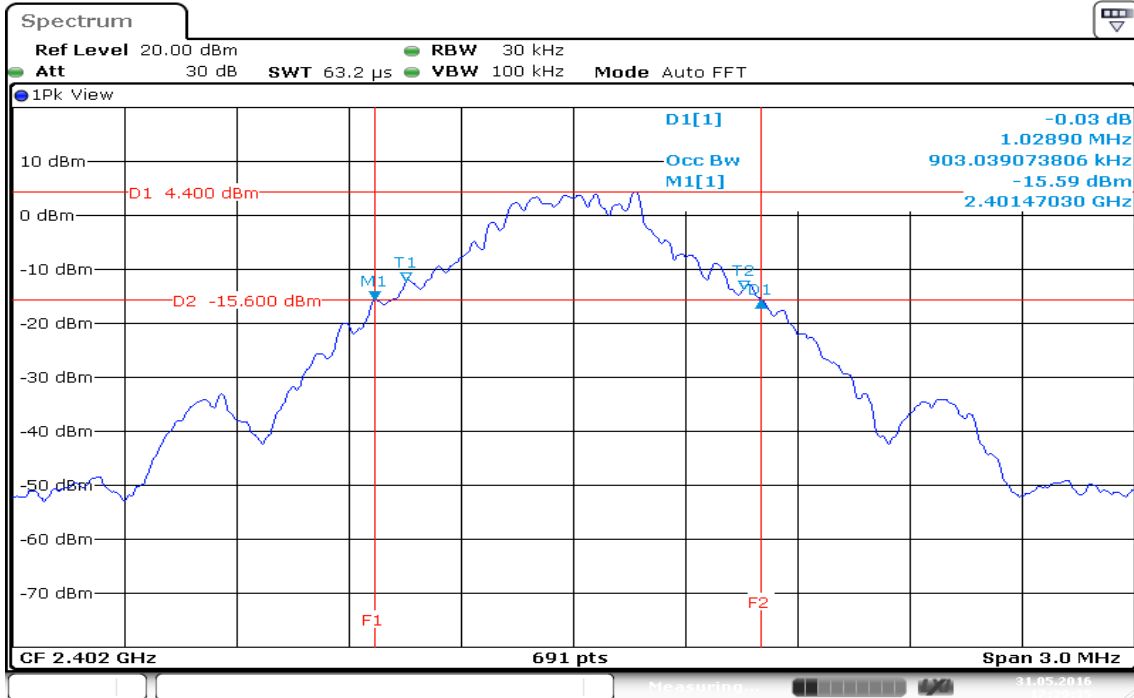

**20dB Bandwidth (CH Mid)**

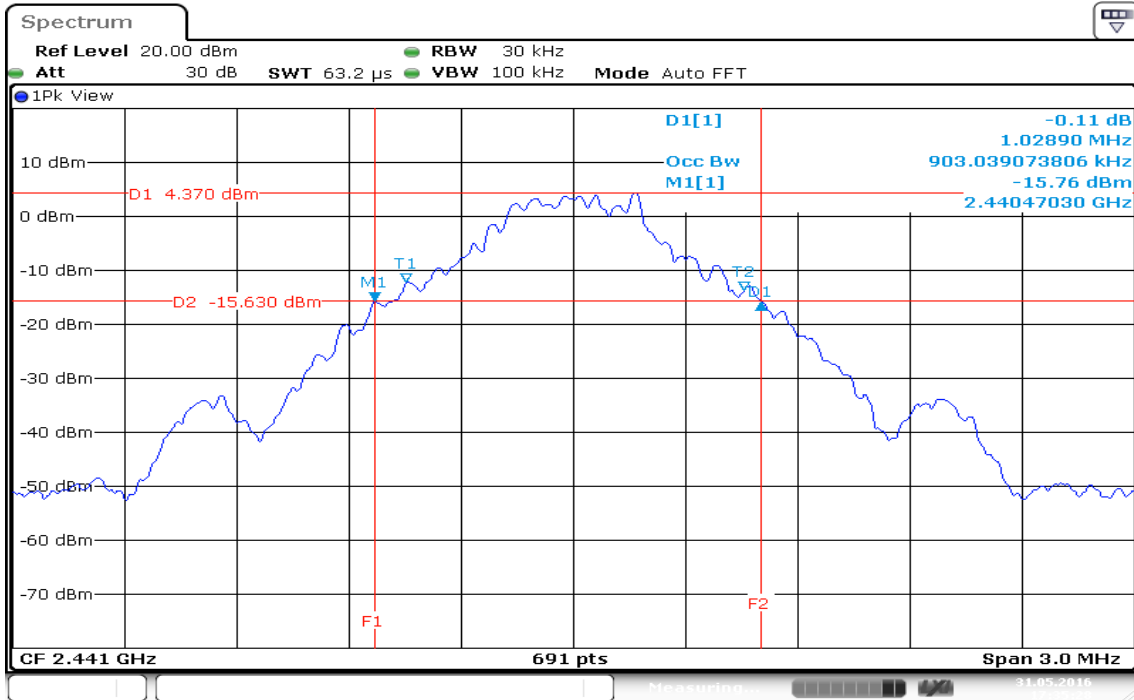

### 20dB Bandwidth (CH High)

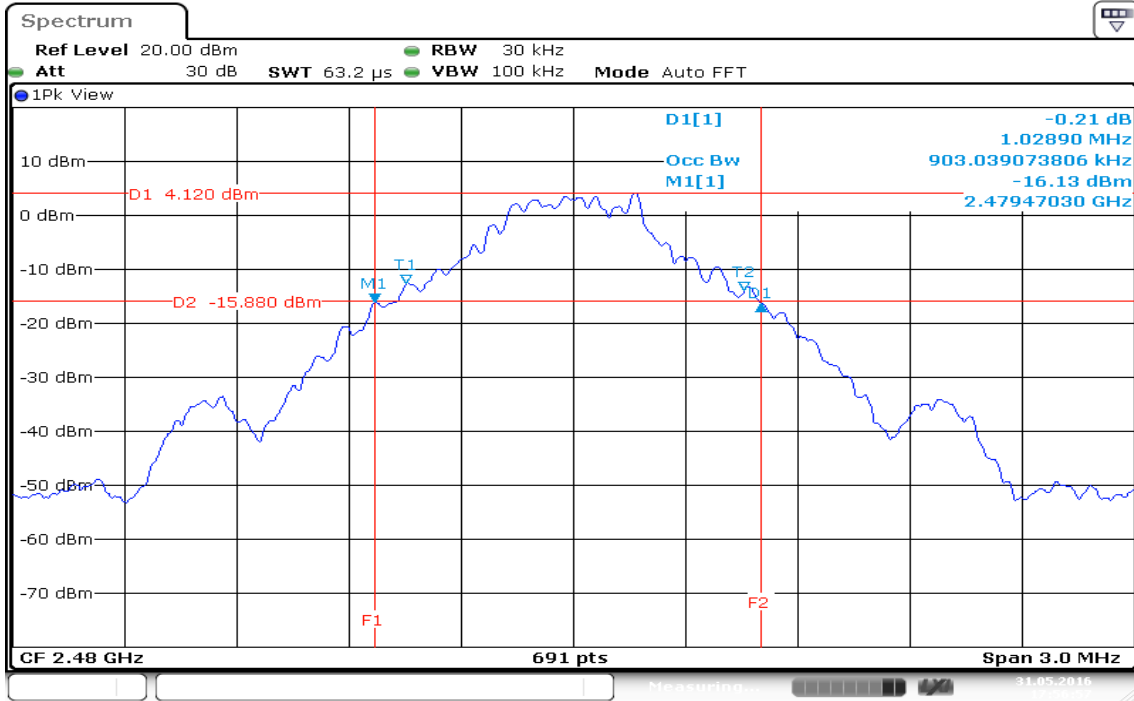

**For 8DPSK / DH5**

**20dB Bandwidth (CH Low)**

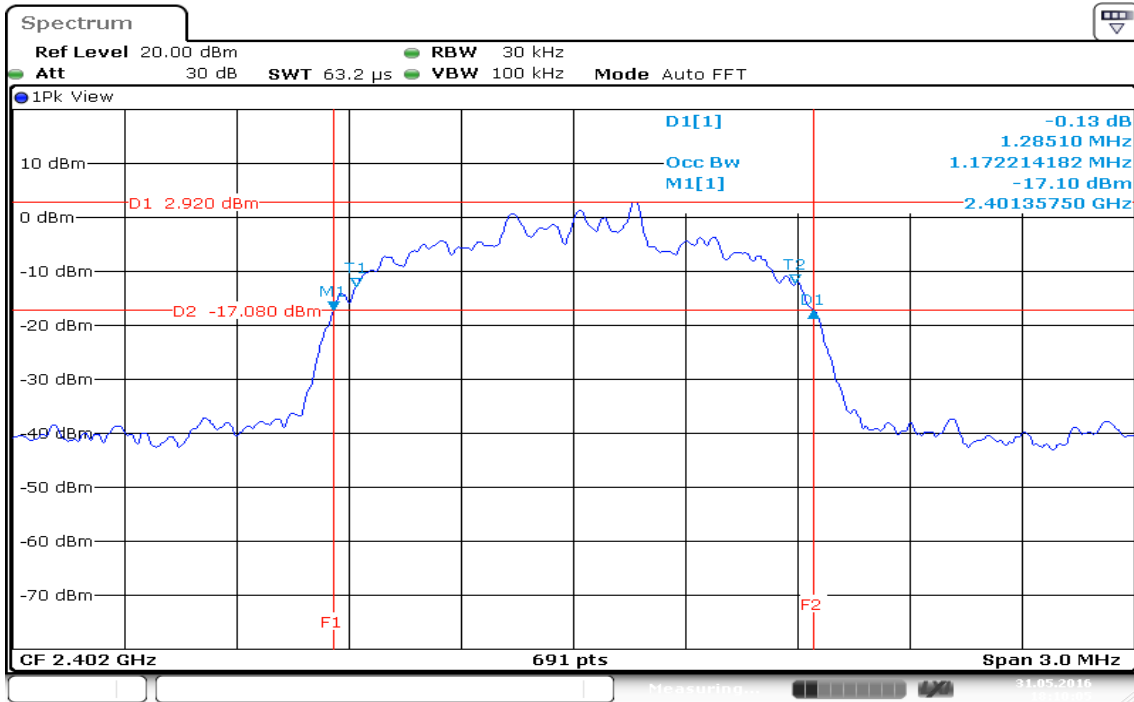

**20dB Bandwidth (CH Mid)**

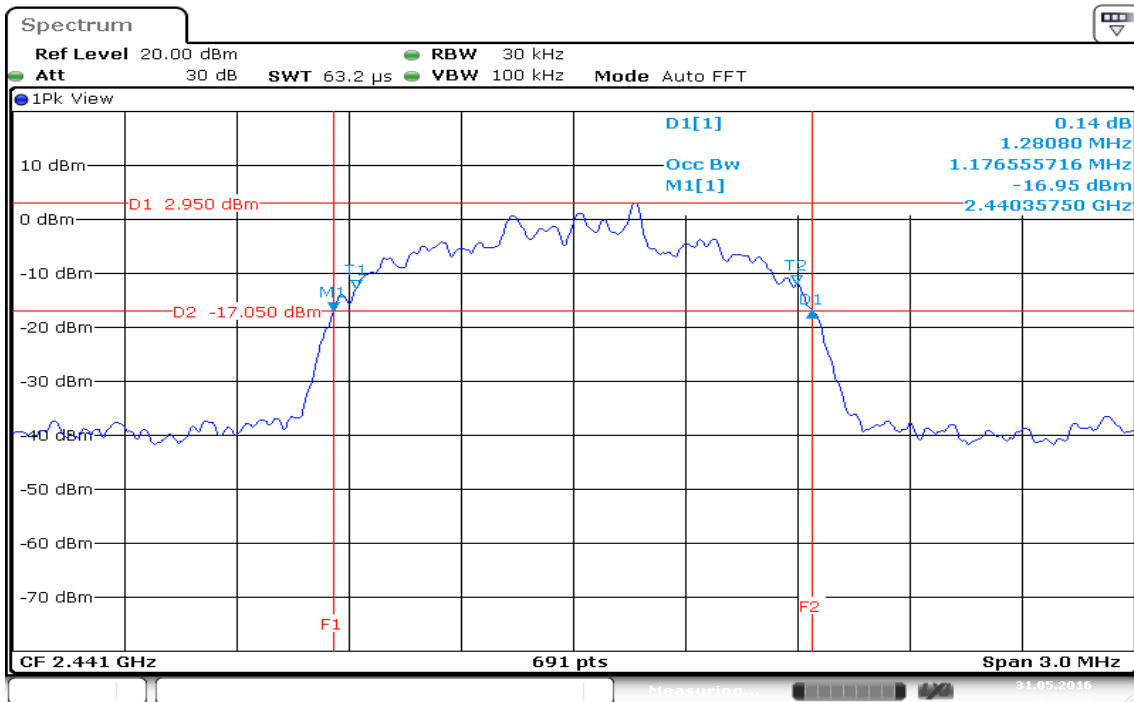

### 20dB Bandwidth (CH High)

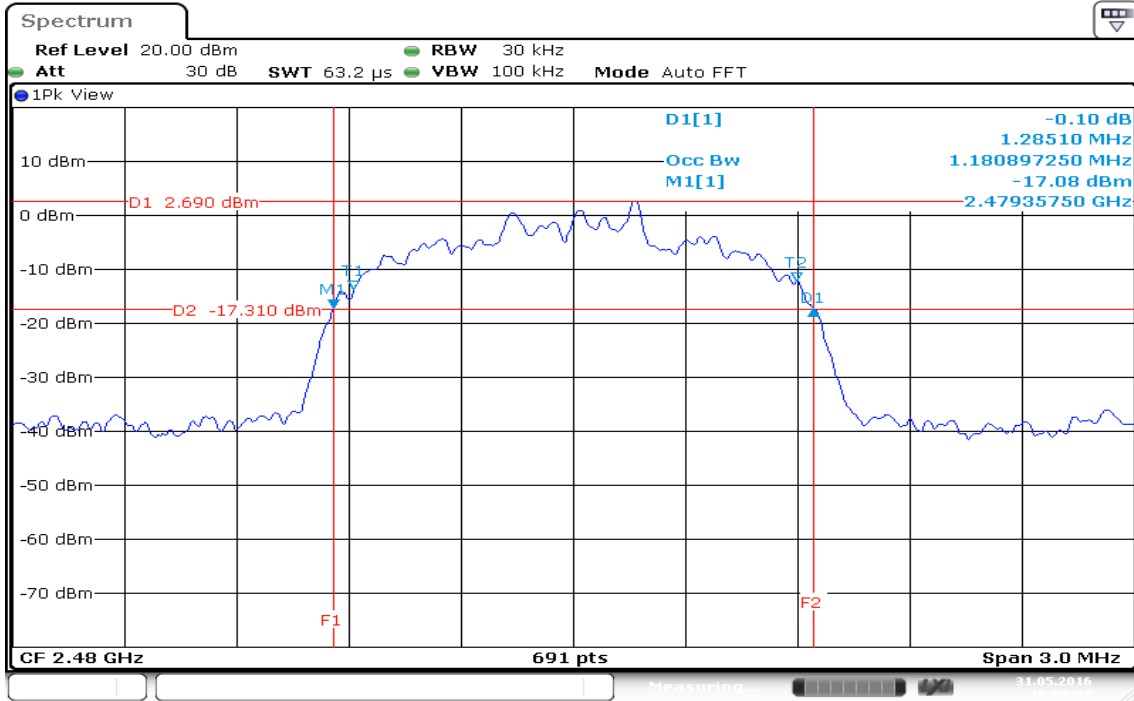

Date: 31.MAY.2016 18:02:07

### 7.3 PEAK POWER

#### LIMIT

The maximum peak output power of the intentional radiator shall not exceed the following:

1. According to §15.247(a)(1) & RSS-247, Frequency hopping systems shall have hopping channel carrier frequencies separated by a minimum of 25 kHz or the 20 dB bandwidth of the hopping channel, whichever is greater. Alternatively, frequency hopping systems operating in the 2400-2483.5 MHz band may have hopping channel carrier frequencies that are separated by 25 kHz or two-thirds of the 20 dB bandwidth of the hopping channel, whichever is greater, provided the systems operate with an output power no greater than 125 mW.
2. According to §15.247(b)(3) & RSS 247, for systems using digital modulation in the bands of 902-928 MHz, 2400-2483.5 MHz, and 5725-5850 MHz: 1 Watt.

#### Test Configuration

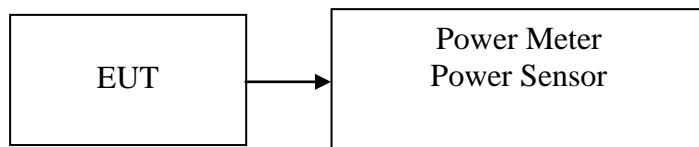

#### TEST PROCEDURE

The transmitter output is connected to the Power Meter. The Power Meter is set to the peak power detection.

#### TEST RESULTS

*No non-compliance noted.*

#### Test Data

##### For GFSK / DH5

Channel	Frequency (MHz)	Output Power (dBm)	Output Power (W)	Limit (W)	Result
Low	2402	*0.42	0.0011	0.125	PASS
Mid	2441	0.37	0.0011		PASS
High	2480	0.18	0.0010		PASS

##### For 8DPSK / DH5

Channel	Frequency (MHz)	Output Power (dBm)	Output Power (W)	Limit (W)	Result
Low	2402	0.38	0.0011	0.125	PASS
Mid	2441	0.31	0.0011		PASS
High	2480	0.11	0.0010		PASS



## 7.4 AVERAGE POWER

### LIMIT

None; for reporting purposes only.

### Test Configuration

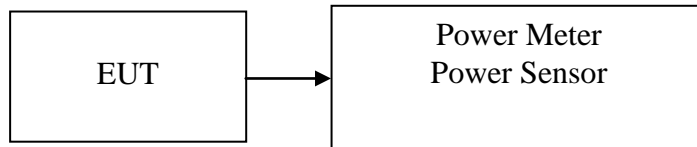

### TEST PROCEDURE

The transmitter output is connected to the Power Meter. The Power Meter is set to the average power detection.

### TEST RESULTS

*No non-compliance noted.*

#### Test Data

##### For GFSK / DH5

Channel	Frequency (MHz)	Output Power (dBm)	Output Power (W)
Low	2402	0.30	0.0011
Mid	2441	0.22	0.0011
High	2480	0.01	0.0010

##### For 8DPSK / DH5

Channel	Frequency (MHz)	Output Power (dBm)	Output Power (W)
Low	2402	-2.15	0.0006
Mid	2441	-2.23	0.0006
High	2480	-2.45	0.0006

## 7.5 BAND EDGES MEASUREMENT

### LIMIT

According to §15.247(d) & RSS-247, in any 100 kHz bandwidth outside the frequency bands in which the spread spectrum intentional radiator is operating, the radio frequency power that is produced by the intentional radiator shall be at least 20 dB below that in the 100 kHz bandwidth within the band that contains the highest level of the desired power, based on either an RF conducted or a radiated measurement, provided the transmitter demonstrates compliance with the peak conducted power limits. In addition, radiated emissions which fall in the restricted bands, as defined in §15.205(a), must also comply with the radiated emission limits specified in 15.209(a) (see Section 15.205(c)).

### Test Configuration

#### For Radiated

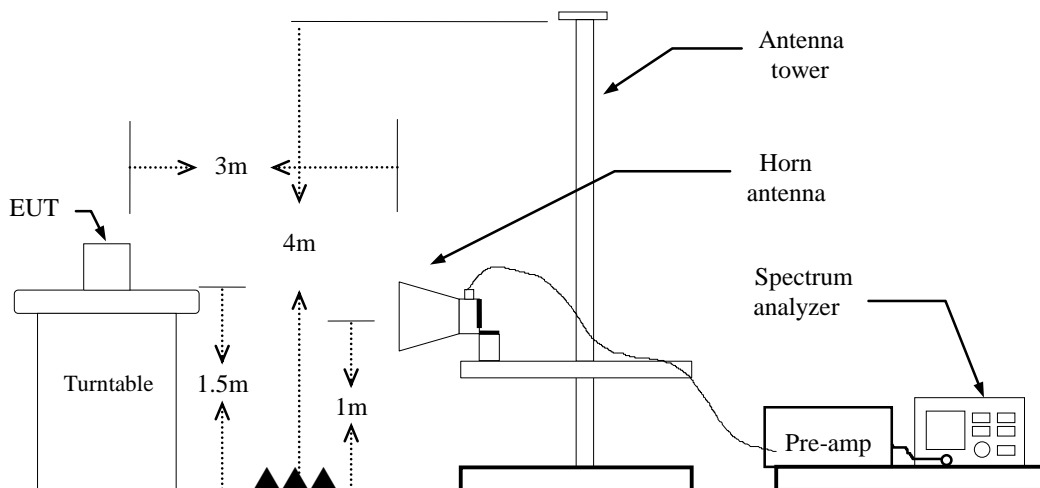

## **TEST PROCEDURE**

### **For Radiated**

1. The EUT is placed on a turntable, which is 1.5m above the ground plane.
2. The turntable shall be rotated for 360 degrees to determine the position of maximum emission level.
3. EUT is set 3m away from the receiving antenna, which is varied from 1m to 4m to find out the highest emission.
4. Set the spectrum analyzer in the following setting in order to capture the lower and upper band-edges of the emission:
  - (a) PEAK: RBW=1MHz / VBW=3MHz / Sweep=AUTO
  - (b) AVERAGE: RBW=1MHz,  
if duty cycle  $\geq 98\%$ , VBW=10Hz.  
if duty cycle  $< 98\%$  VBW=1/T.  
**BT** = 78%, VBW= 360Hz  
**EDR** = 78%, VBW= 360Hz
5. Repeat the procedures until all the PEAK and AVERAGE versus POLARIZATION are measured.
6. Result = Spectrum Reading + cable loss(spectrum to Amp) - Amp Gain + Cable loss(Amp to receive Ant)+ Receive Ant
7. We measured at both hopping and non-hopping mode, recorded worst at non-hopping mode.

### **For Un-restricted Band Emissions**

The peak output power procedure is used to measure the fundamental emission power to demonstrate compliance to requirements, then the peak conducted output power measured within any 100 kHz outside the authorized frequency band shall be attenuated by at least 20 dB relative to the maximum measured in-band peak PSD level.

## **TEST RESULTS**

Refer to attach spectrum analyzer data chart.

For GFSK / DH5

Band Edges (CH Low)

Detector mode: Peak

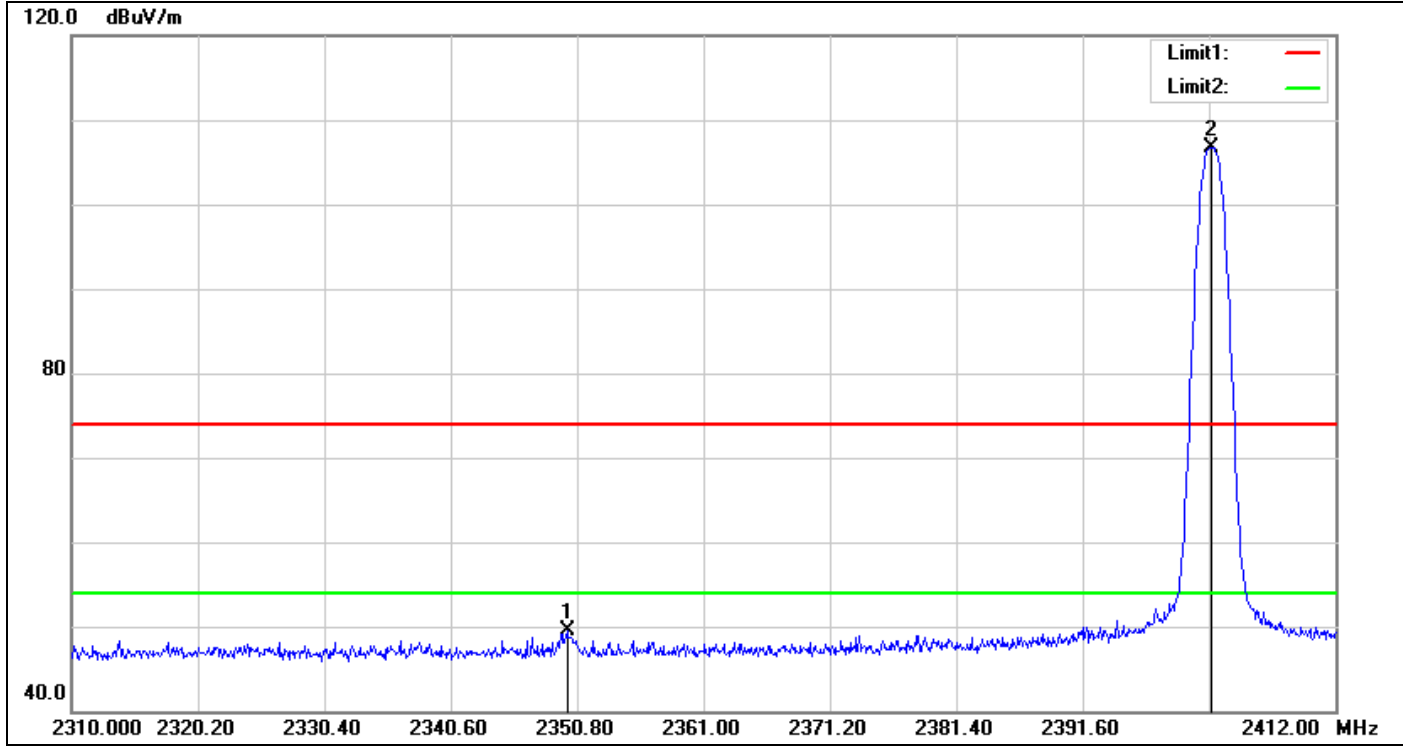

No.	Frequency (MHz)	Reading (dBuV)	Correct Factor(dB/m)	Result (dBuV/m)	Limit (dBuV/m)	Margin (dB)	Remark
1	2349.984	52.24	-2.80	49.44	74.00	-24.56	peak
2	2402.004	109.11	-2.41	106.70	74.00	32.70	peak

**Detector mode: Average**

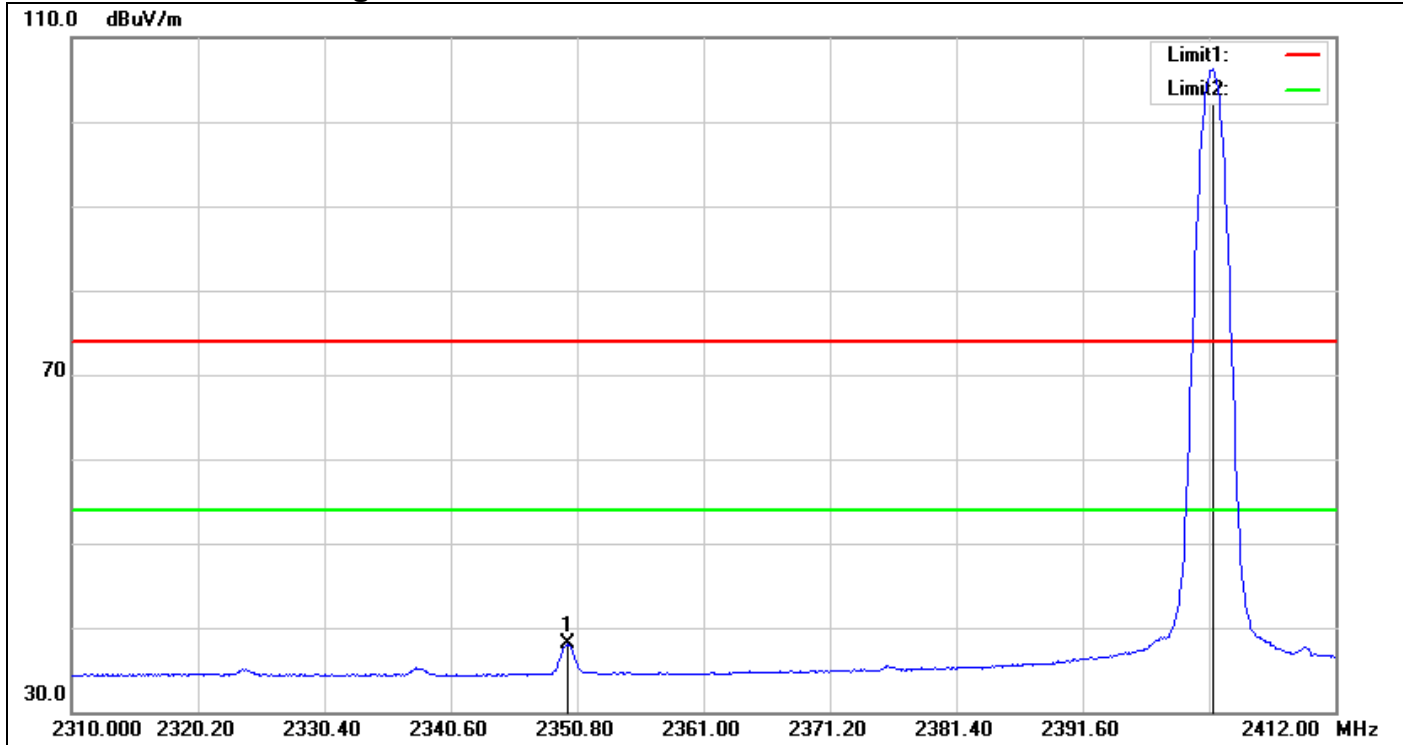

No.	Frequency (MHz)	Reading (dBuV)	Correct Factor(dB/m)	Result (dBuV/m)	Limit (dBuV/m)	Margin (dB)	Remark
1	2349.984	40.83	-2.80	38.03	54.00	-15.97	AVG
2	2402.106	108.61	-2.41	106.20	54.00	52.20	AVG

### Band Edges (CH Mid)

Detector mode: Peak

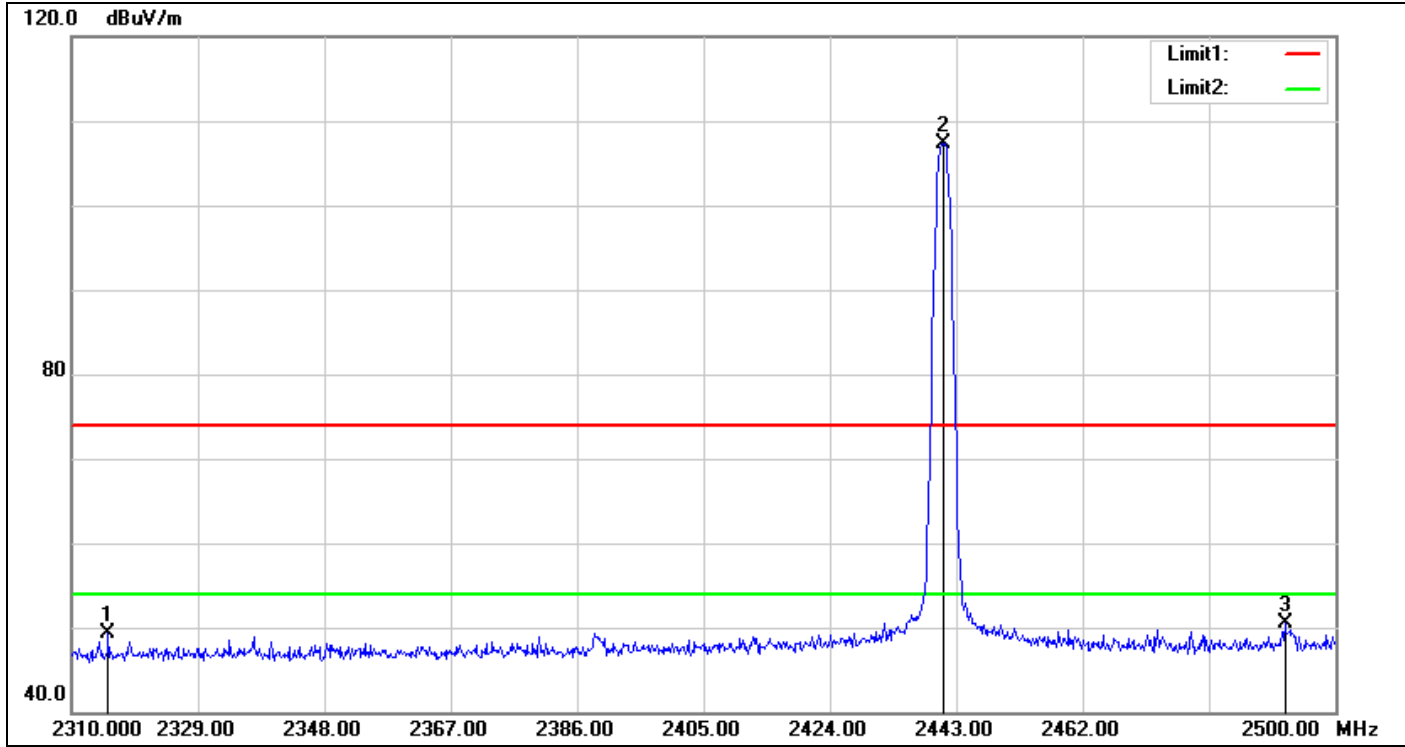

No.	Frequency (MHz)	Reading (dBuV)	Correct Factor(dB/m)	Result (dBuV/m)	Limit (dBuV/m)	Margin (dB)	Remark
1	2315.510	52.32	-2.98	49.34	74.00	-24.66	peak
2	2441.100	109.48	-2.20	107.28	74.00	33.28	peak
3	2492.400	52.33	-1.91	50.42	74.00	-23.58	peak

**Detector mode: Average**

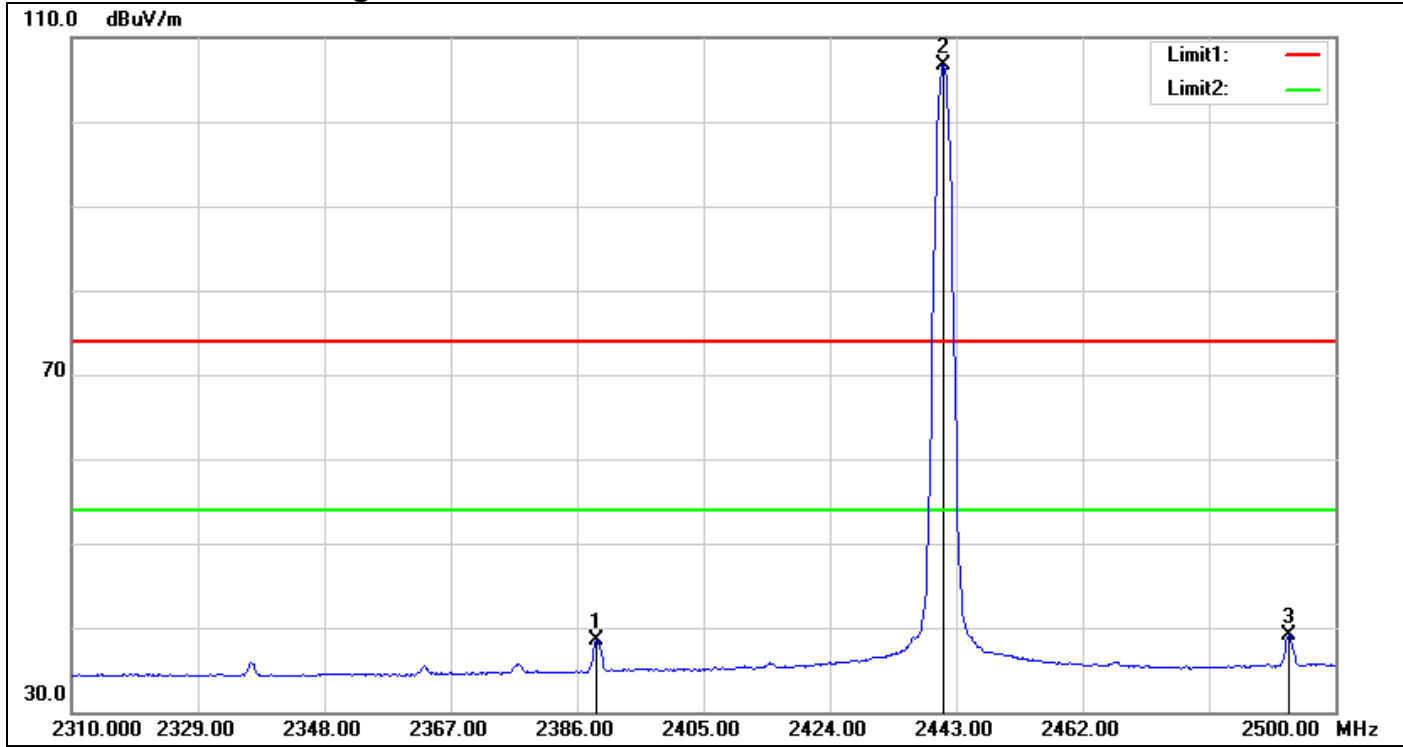

No.	Frequency (MHz)	Reading (dBuV)	Correct Factor(dB/m)	Result (dBuV/m)	Limit (dBuV/m)	Margin (dB)	Remark
1	2388.850	41.09	-2.50	38.59	54.00	-15.41	AVG
2	2441.100	108.95	-2.20	106.75	54.00	52.75	AVG
3	2492.970	40.96	-1.91	39.05	54.00	-14.95	AVG

## Band Edges (CH High)

Detector mode: Peak

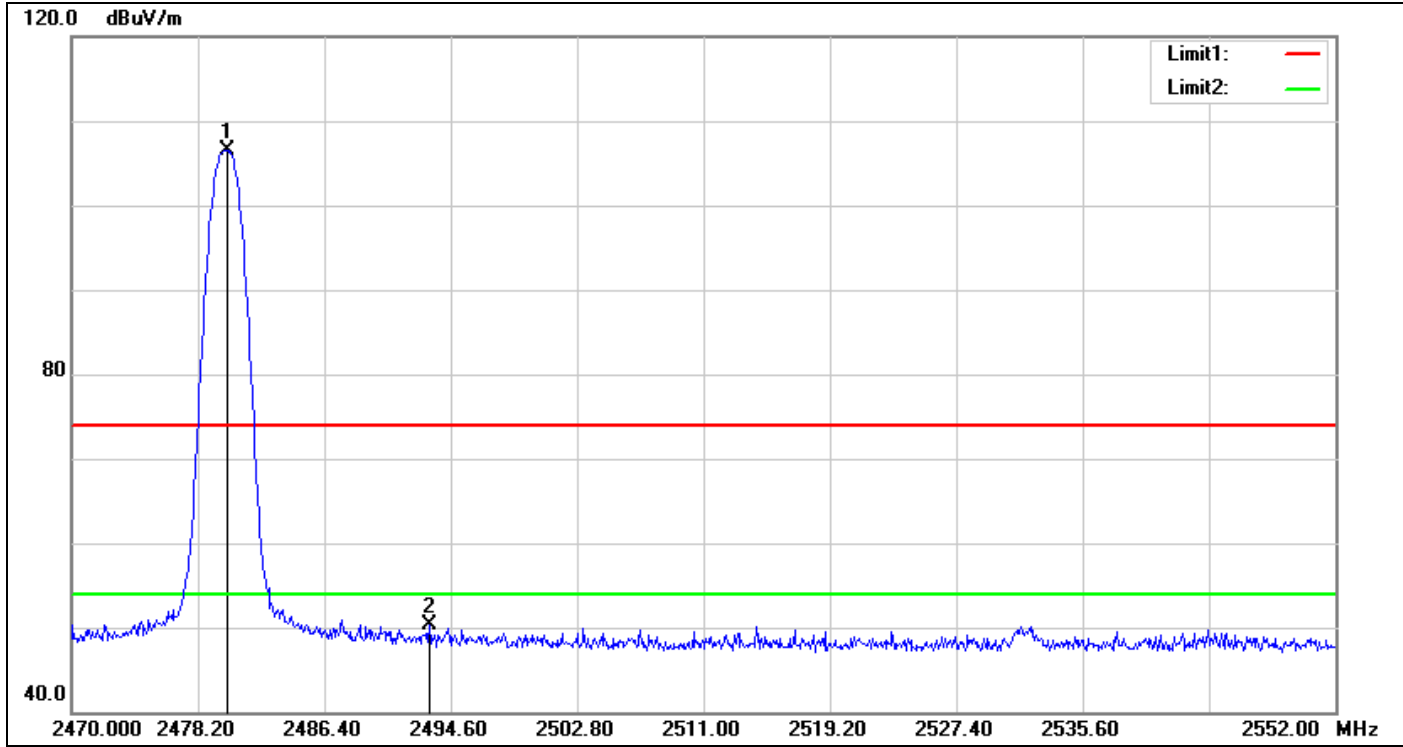

No.	Frequency (MHz)	Reading (dBuV)	Correct Factor(dB/m)	Result (dBuV/m)	Limit (dBuV/m)	Margin (dB)	Remark
1	2480.086	108.46	-2.03	106.43	74.00	32.43	peak
2	2493.206	52.14	-1.91	50.23	74.00	-23.77	peak



**Detector mode: Average**

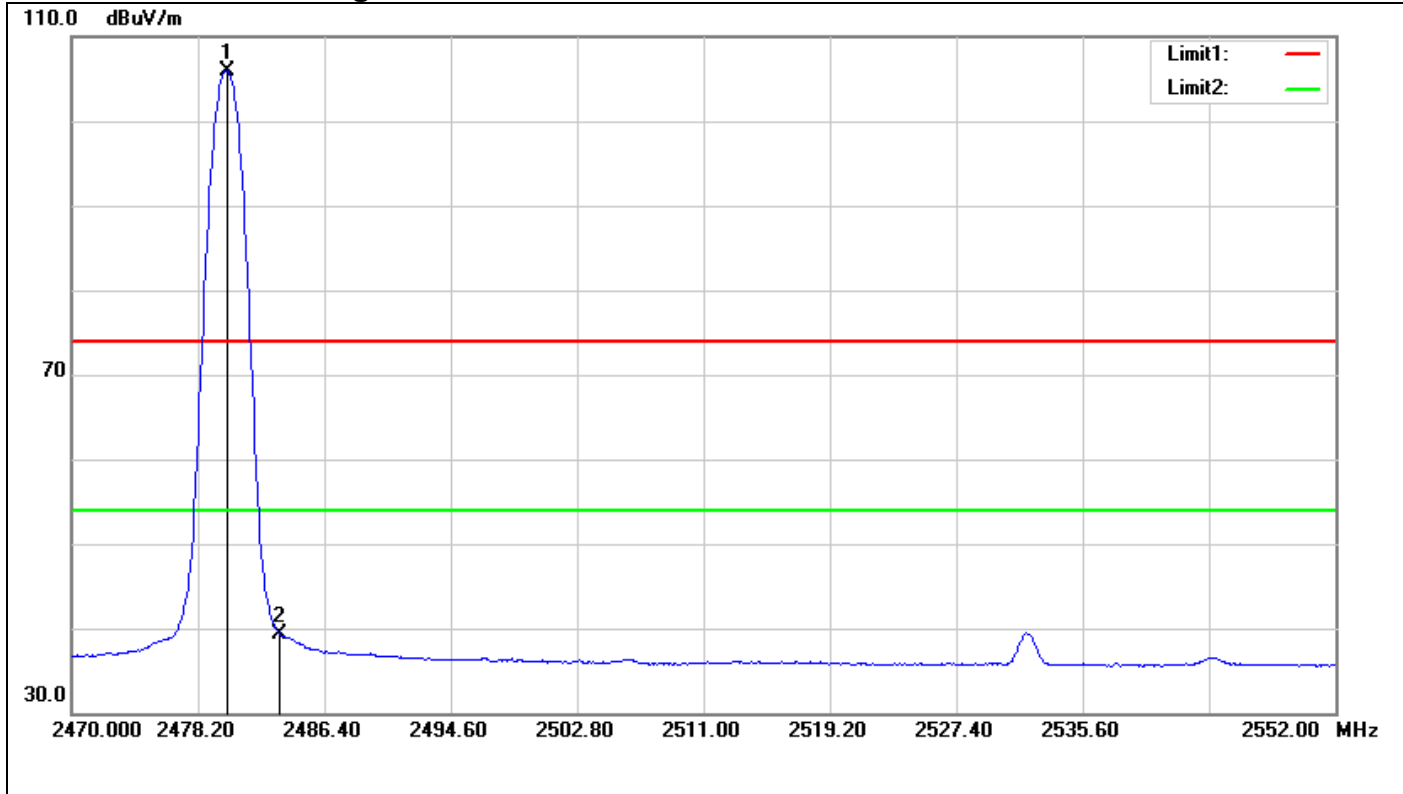

No.	Frequency (MHz)	Reading (dBuV)	Correct Factor(dB/m)	Result (dBuV/m)	Limit (dBuV/m)	Margin (dB)	Remark
1	2480.086	107.97	-2.03	105.94	54.00	51.94	AVG
2	2483.500	41.34	-1.99	39.35	54.00	-14.65	AVG

**For 8DPSK  
Band Edges (CH Low)**

Detector mode: Peak

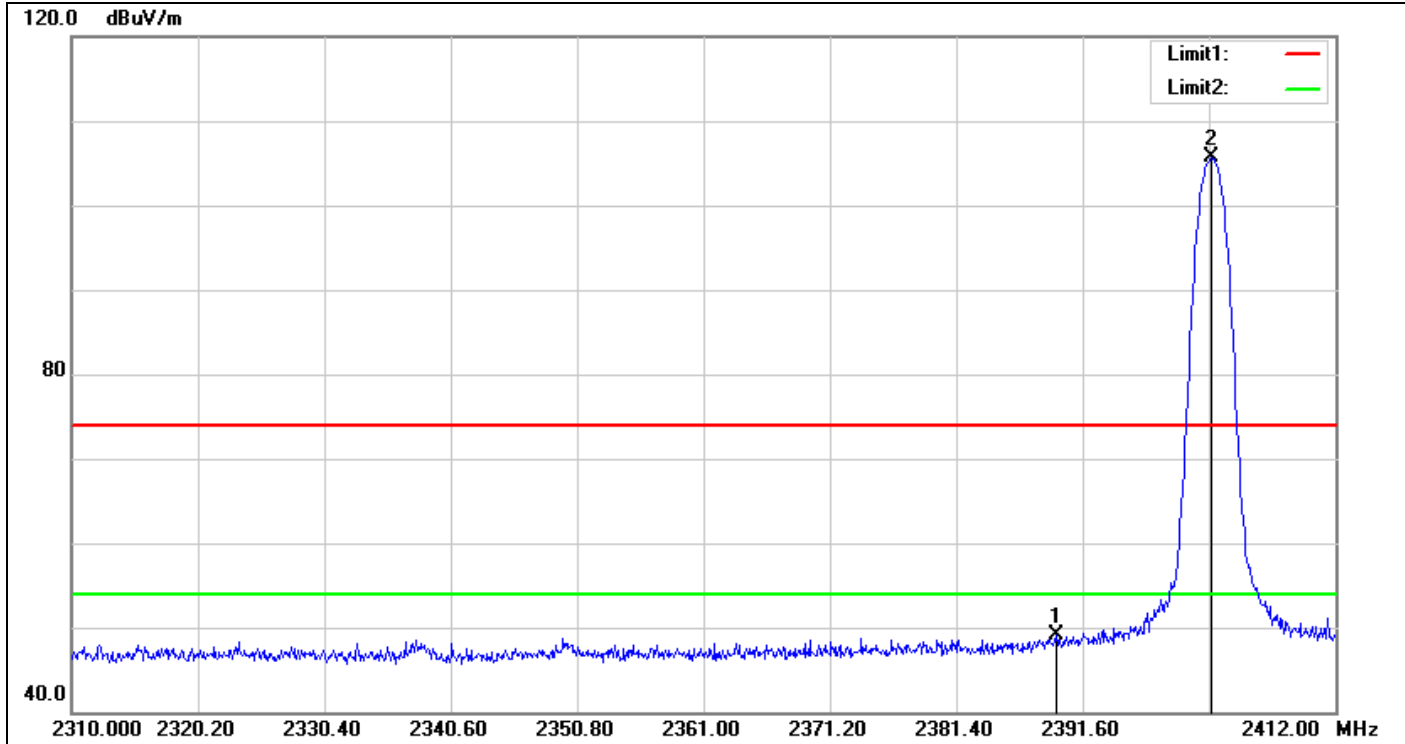

No.	Frequency (MHz)	Reading (dBuV)	Correct Factor(dB/m)	Result (dBuV/m)	Limit (dBuV/m)	Margin (dB)	Remark
1	2389.458	51.66	-2.49	49.17	74.00	-24.83	peak
2	2402.004	108.09	-2.41	105.68	74.00	31.68	peak

**Detector mode: Average**

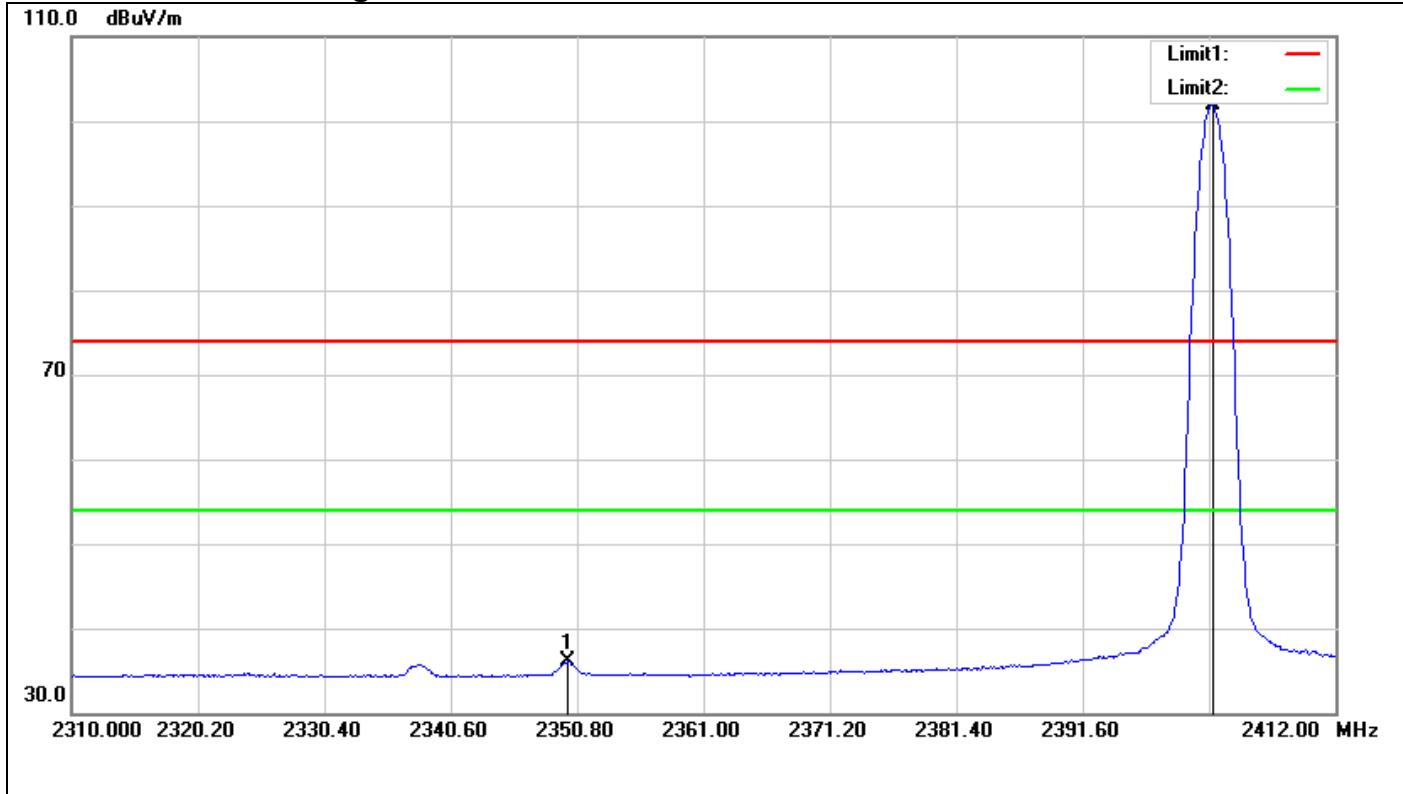

No.	Frequency (MHz)	Reading (dBuV)	Correct Factor(dB/m)	Result (dBuV/m)	Limit (dBuV/m)	Margin (dB)	Remark
1	2349.984	38.85	-2.80	36.05	54.00	-17.95	AVG
2	2402.106	104.26	-2.41	101.85	54.00	47.85	AVG

### Band Edges (CH Mid)

Detector mode: Peak

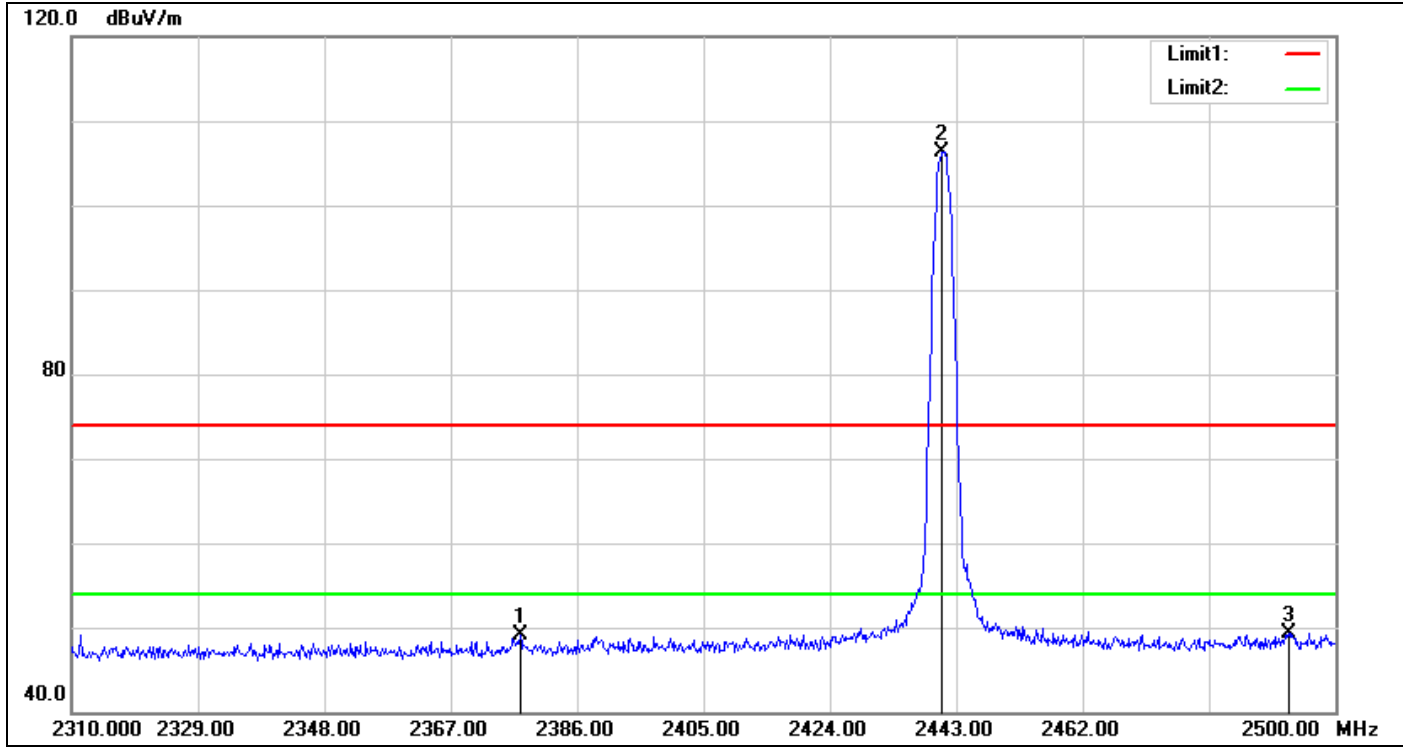

No.	Frequency (MHz)	Reading (dBuV)	Correct Factor(dB/m)	Result (dBuV/m)	Limit (dBuV/m)	Margin (dB)	Remark
1	2377.450	51.69	-2.60	49.09	74.00	-24.91	peak
2	2440.910	108.60	-2.21	106.39	74.00	32.39	peak
3	2492.970	51.30	-1.91	49.39	74.00	-24.61	peak

**Detector mode: Average**

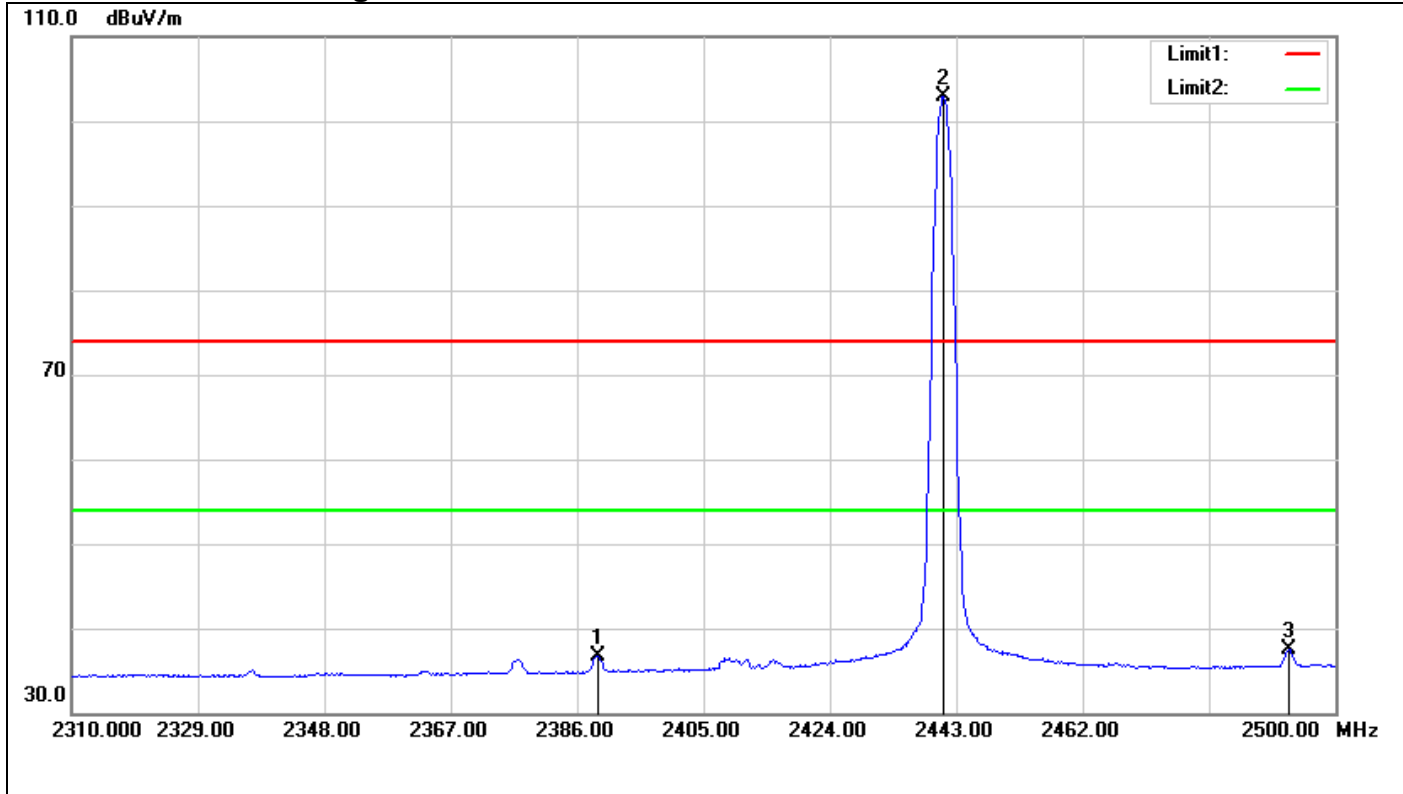

No.	Frequency (MHz)	Reading (dBuV)	Correct Factor(dB/m)	Result (dBuV/m)	Limit (dBuV/m)	Margin (dB)	Remark
1	2389.040	39.27	-2.50	36.77	54.00	-17.23	AVG
2	2441.100	105.08	-2.20	102.88	54.00	48.88	AVG
3	2492.970	39.40	-1.91	37.49	54.00	-16.51	AVG

### Band Edges (CH High)

Detector mode: Peak

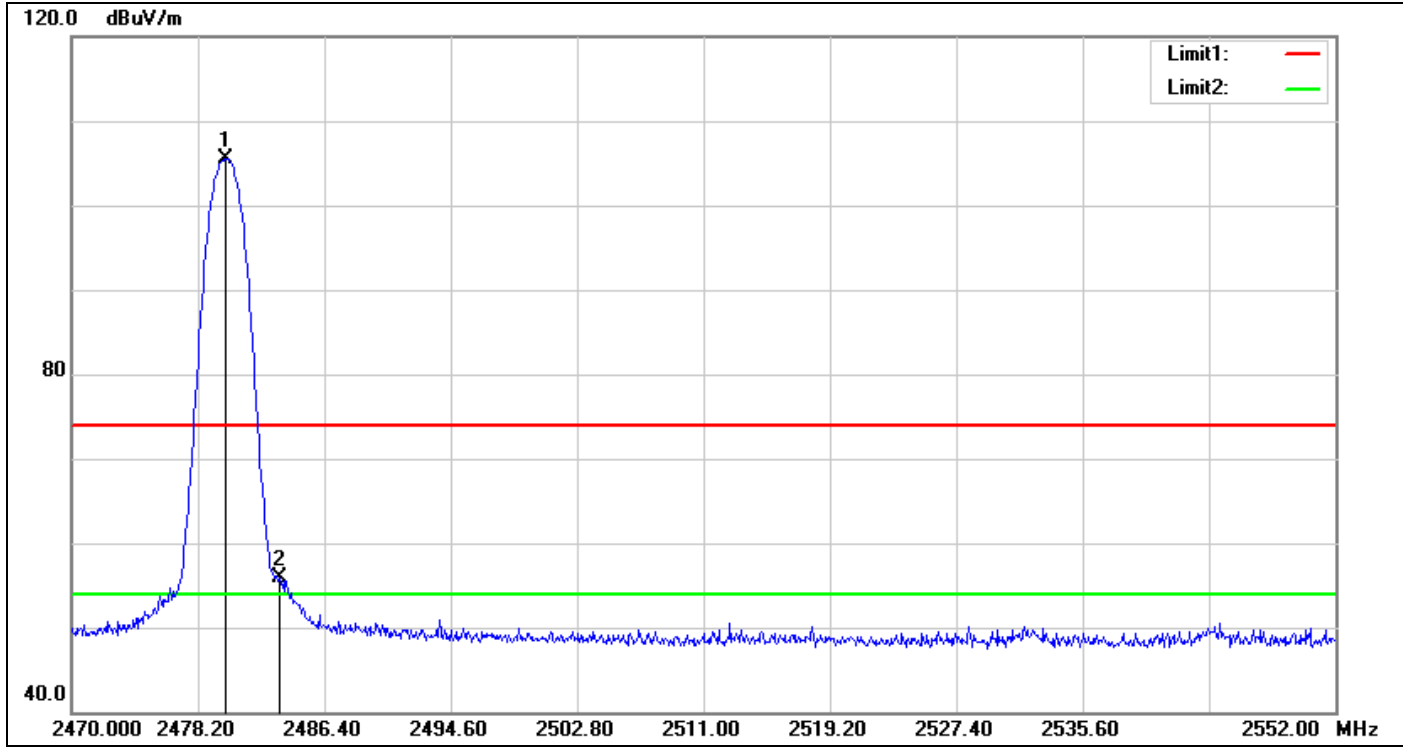

No.	Frequency (MHz)	Reading (dBuV)	Correct Factor(dB/m)	Result (dBuV/m)	Limit (dBuV/m)	Margin (dB)	Remark
1	2480.004	107.58	-2.03	105.55	74.00	31.55	peak
2	2483.500	57.84	-1.99	55.85	74.00	-18.15	peak

**Detector mode: Average**

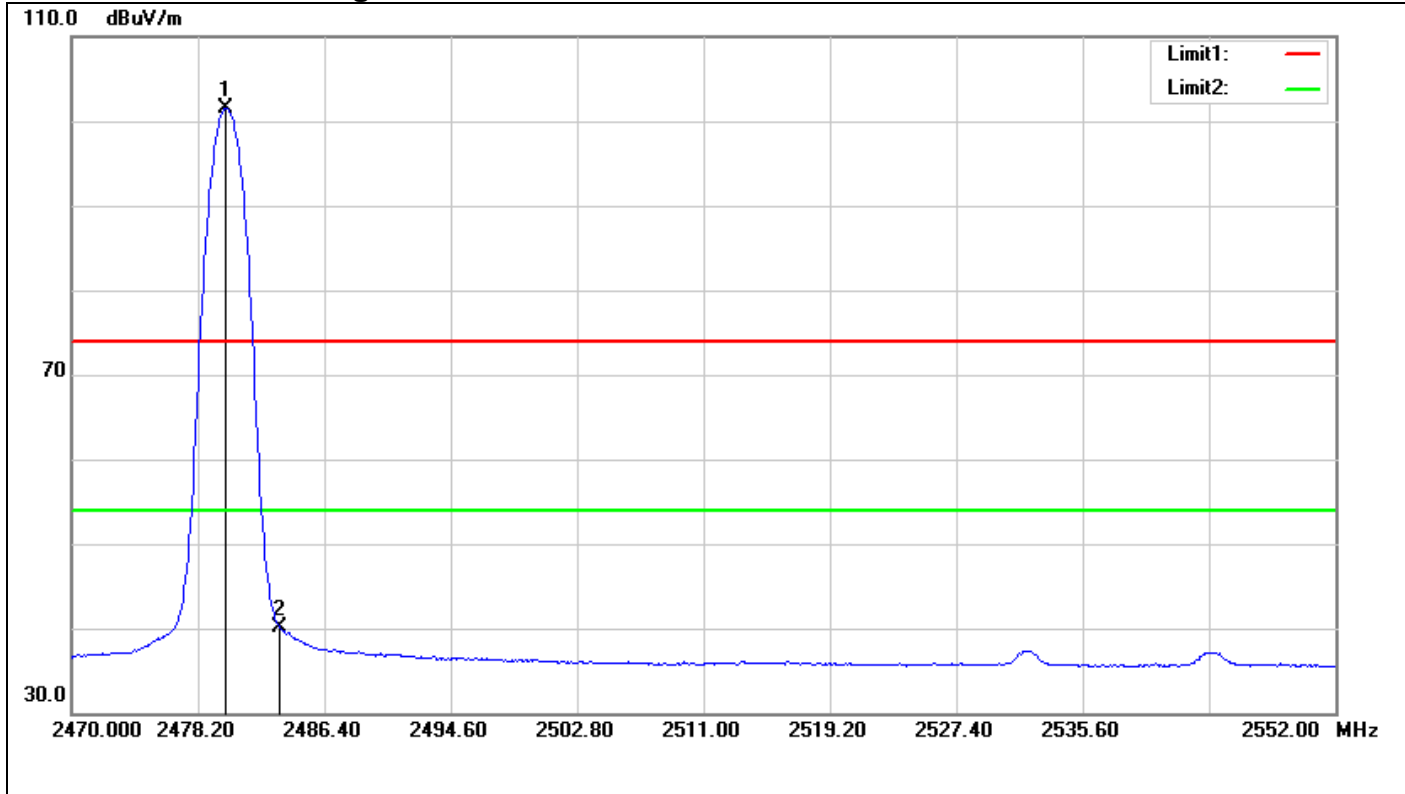

No.	Frequency (MHz)	Reading (dBuV)	Correct Factor(dB/m)	Result (dBuV/m)	Limit (dBuV/m)	Margin (dB)	Remark
1	2480.004	103.53	-2.03	101.50	54.00	47.50	AVG
2	2483.500	42.01	-1.99	40.02	54.00	-13.98	AVG

**Test Plot**

**For GFSK**

**Un-restricted Band Emissions / CH Low**

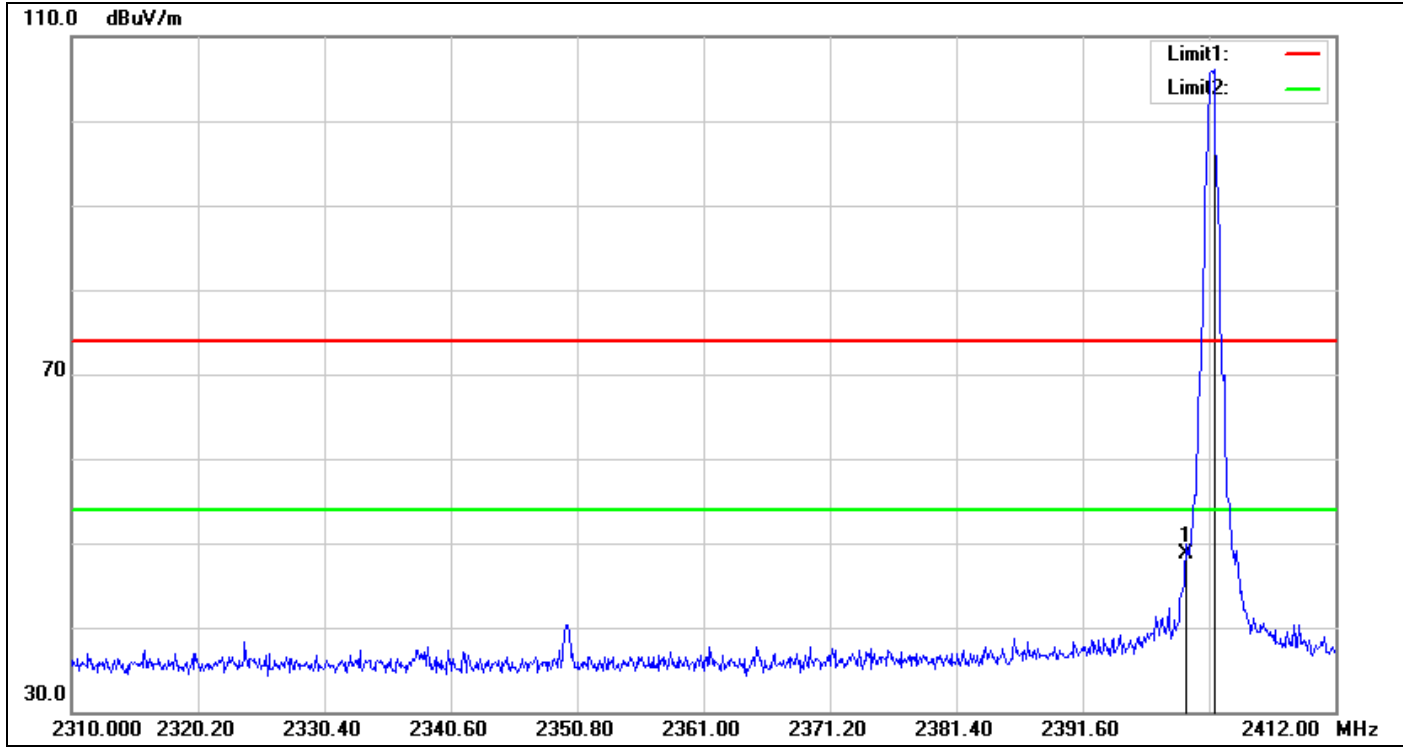

No.	Frequency (MHz)	Reading (dBuV)	Correct Factor(dB/m)	Result (dBuV/m)	Limit (dBuV/m)	Margin (dB)	Remark
1	2400.000	51.16	-2.41	48.75	74.00	-25.25	peak
2	2402.208	108.41	-2.41	106.00	74.00	32.00	peak

**Note: Spurious emission levels that exceed the level of 20 dB below the applicable limit.**



### Un-restricted Band Emissions / CH High

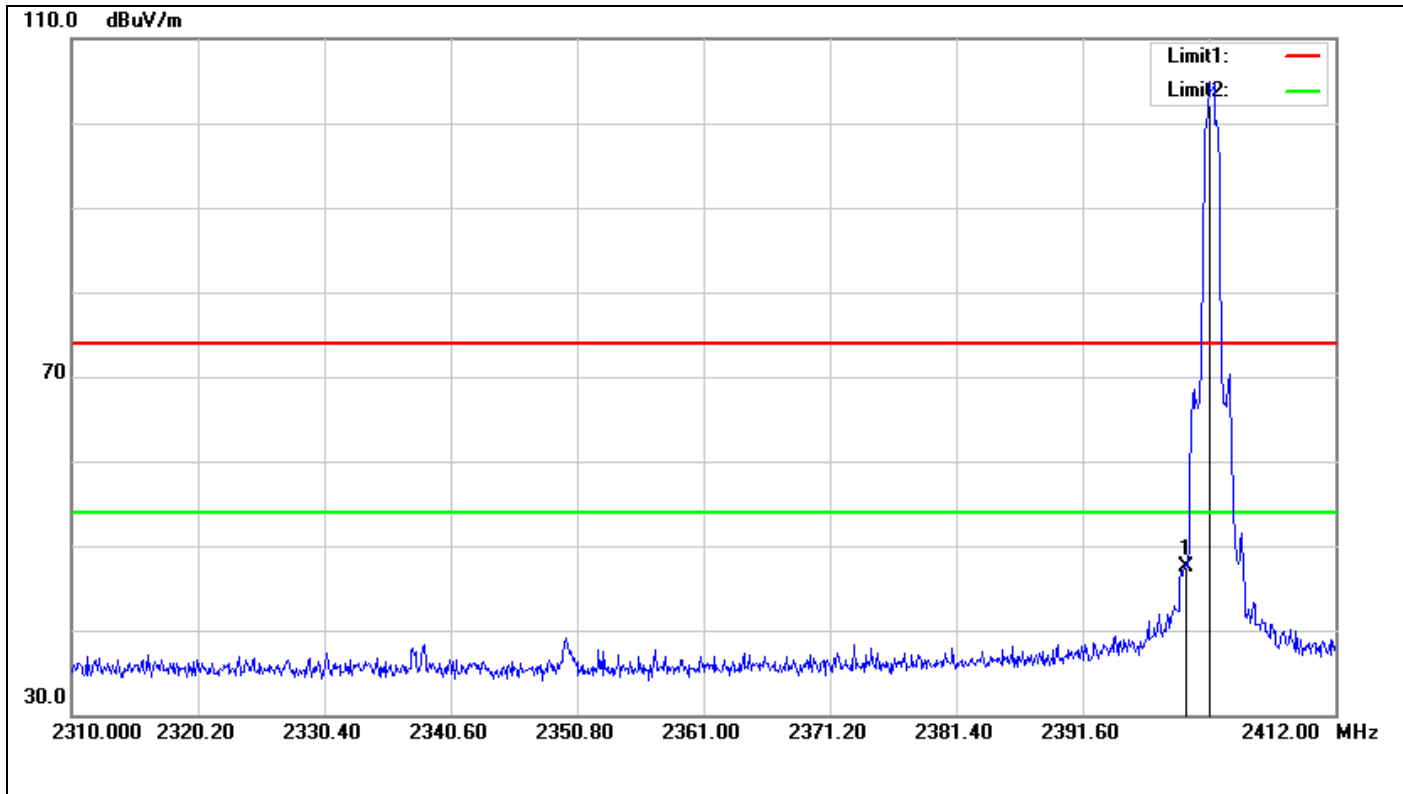

No.	Frequency (MHz)	Reading (dBuV)	Correct Factor (dB/m)	Result (dBuV/m)	Limit (dBuV/m)	Margin (dB)	Remark
1	2400.000	49.96	-2.41	47.55	74.00	-26.45	peak
2	2401.800	107.41	-2.41	105.00	74.00	31.00	peak

**Note: Spurious emission levels that exceed the level of 20 dB below the applicable limit.**

**For 8DPSK**

**Un-restricted Band Emissions / CH Low**

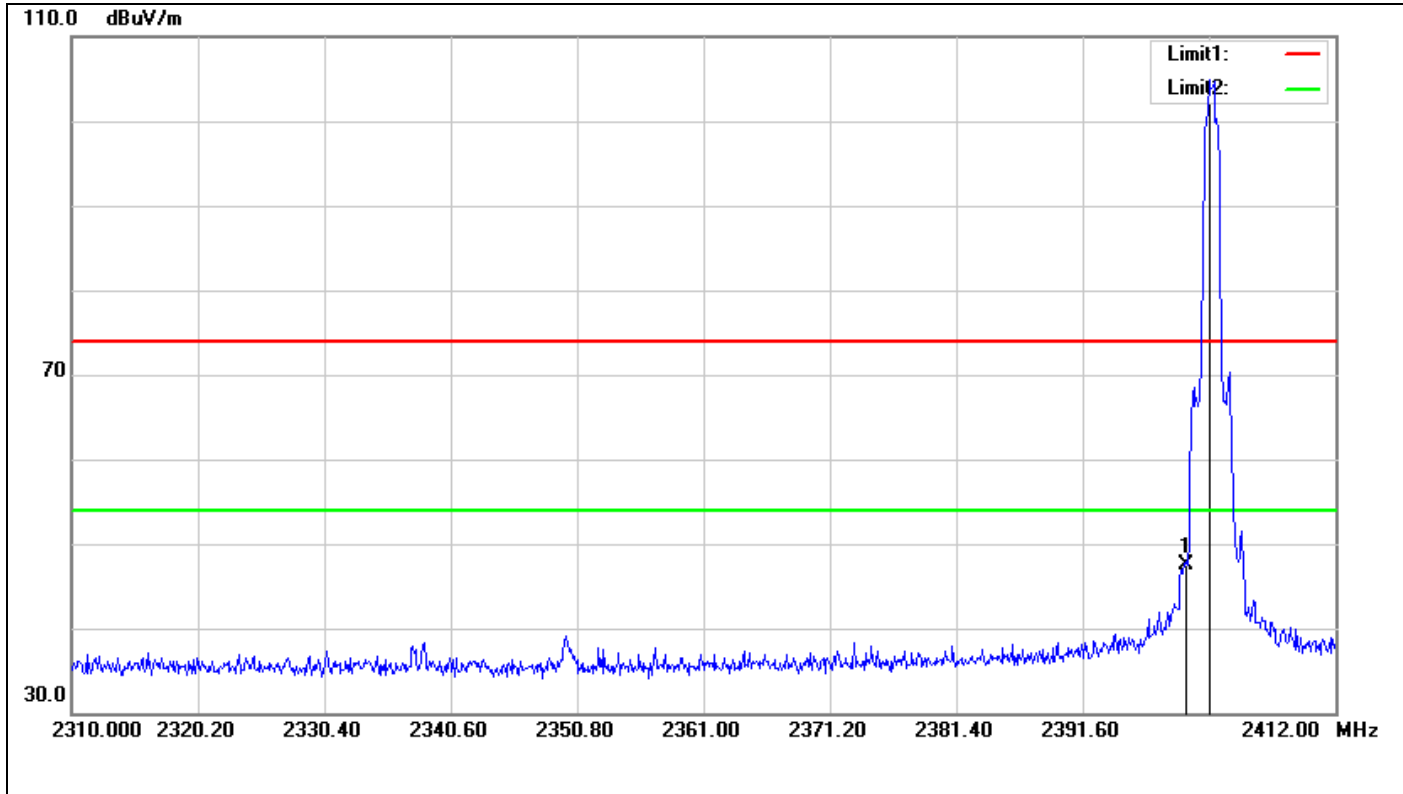

No.	Frequency (MHz)	Reading (dBuV)	Correct Factor(dB/m)	Result (dBuV/m)	Limit (dBuV/m)	Margin (dB)	Remark
1	2400.000	49.96	-2.41	47.55	74.00	-26.45	peak
2	2401.800	107.41	-2.41	105.00	74.00	31.00	peak

**Note: Spurious emission levels that exceed the level of 20 dB below the applicable limit.**

### Un-restricted Band Emissions / CH High

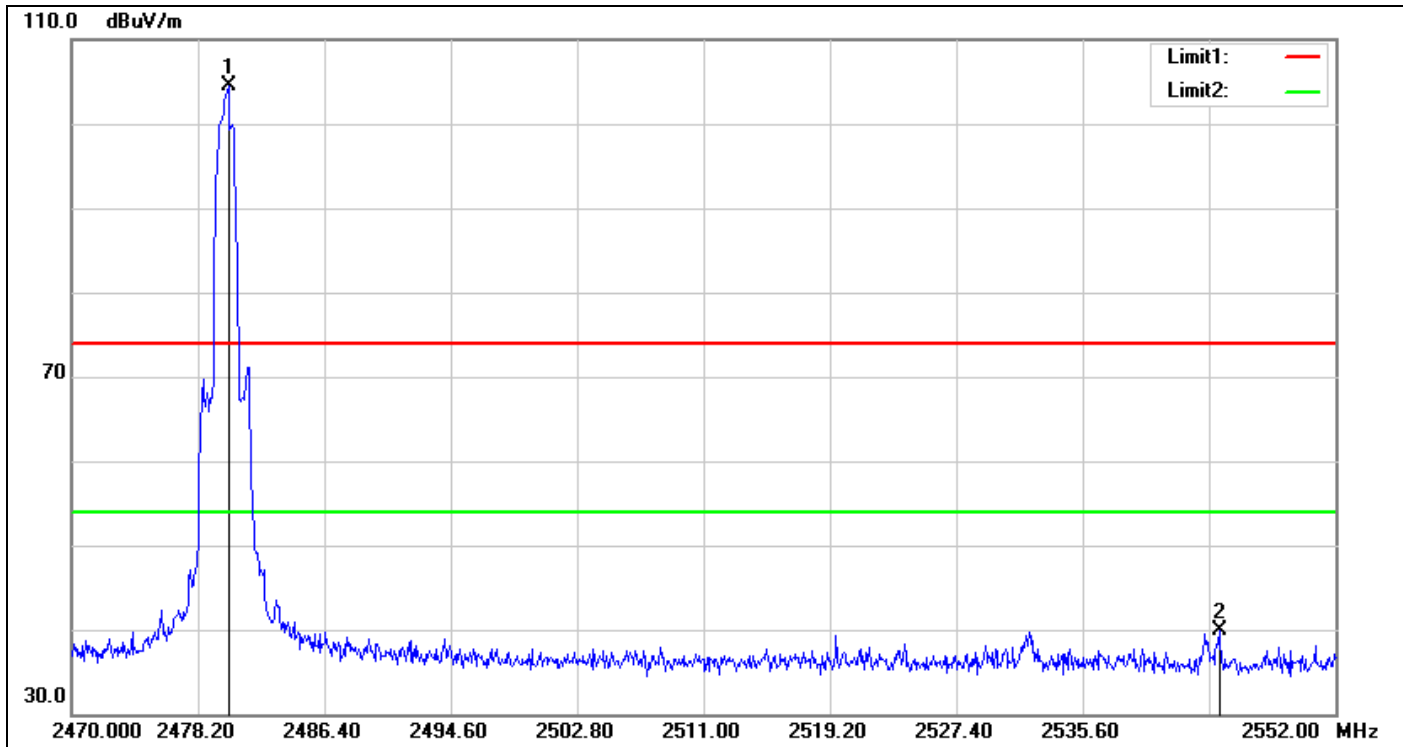

No.	Frequency (MHz)	Reading (dBuV)	Correct Factor(dB/m)	Result (dBuV/m)	Limit (dBuV/m)	Margin (dB)	Remark
1	2480.168	106.56	-2.03	104.53	74.00	30.53	peak
2	2544.456	41.69	-1.75	39.94	74.00	-34.06	peak

**Note: Spurious emission levels that exceed the level of 20 dB below the applicable limit.**

## 7.6 FREQUENCY SEPARATION

### LIMIT

According to §15.247(a)(1) & RSS-247, Frequency hopping systems shall have hopping channel carrier frequencies separated by a minimum of 25 kHz or the 20 dB bandwidth of the hopping channel, whichever is greater. Alternatively, frequency hopping systems operating in the 2400-2483.5 MHz band may have hopping channel carrier frequencies that are separated by 25 kHz or two-thirds of the 20 dB bandwidth of the hopping channel, whichever is greater, provided the systems operate with an output power no greater than 125 mW.

### Test Configuration

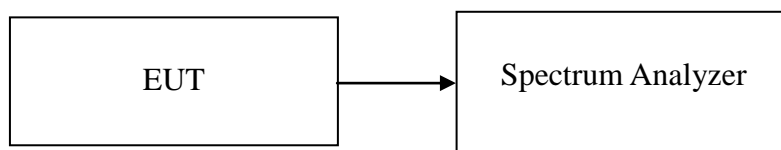

### TEST PROCEDURE

1. Place the EUT on the table and set it in transmitting mode.
2. Remove the antenna from the EUT and then connect a low loss RF cable from the antenna port to the spectrum analyzer.
3. Set center frequency of spectrum analyzer = middle of hopping channel.
4. Set the spectrum analyzer as RBW = 30kHz, VBW = 100kHz, Sweep = 3.2 ms.
5. Max hold, mark 3 peaks of hopping channel and record the 3 peaks frequency.

**TEST RESULTS***No non-compliance noted***Test Data****For GFSK**

Channel	Channel Separation (MHz)	two-thirds of the 20 dB bandwidth (MHz)	Channel Separation Limit	Result
Low	1.0029	0.6686	> two-thirds of the 20 dB bandwidth	Pass
Mid	1.0029	0.6686	> two-thirds of the 20 dB bandwidth	Pass
High	1.0029	0.6686	> two-thirds of the 20 dB bandwidth	Pass

**For 8DPSK**

Channel	Channel Separation (MHz)	two-thirds of the 20 dB bandwidth (MHz)	Channel Separation Limit	Result
Low	1.0029	0.6686	> two-thirds of the 20 dB bandwidth	Pass
Mid	1.0029	0.6686	> two-thirds of the 20 dB bandwidth	Pass
High	1.0029	0.6686	> two-thirds of the 20 dB bandwidth	Pass

**Test Plot**

**For GFSK / DH5**

**Measurement of Channel Separation / (CH Low)**

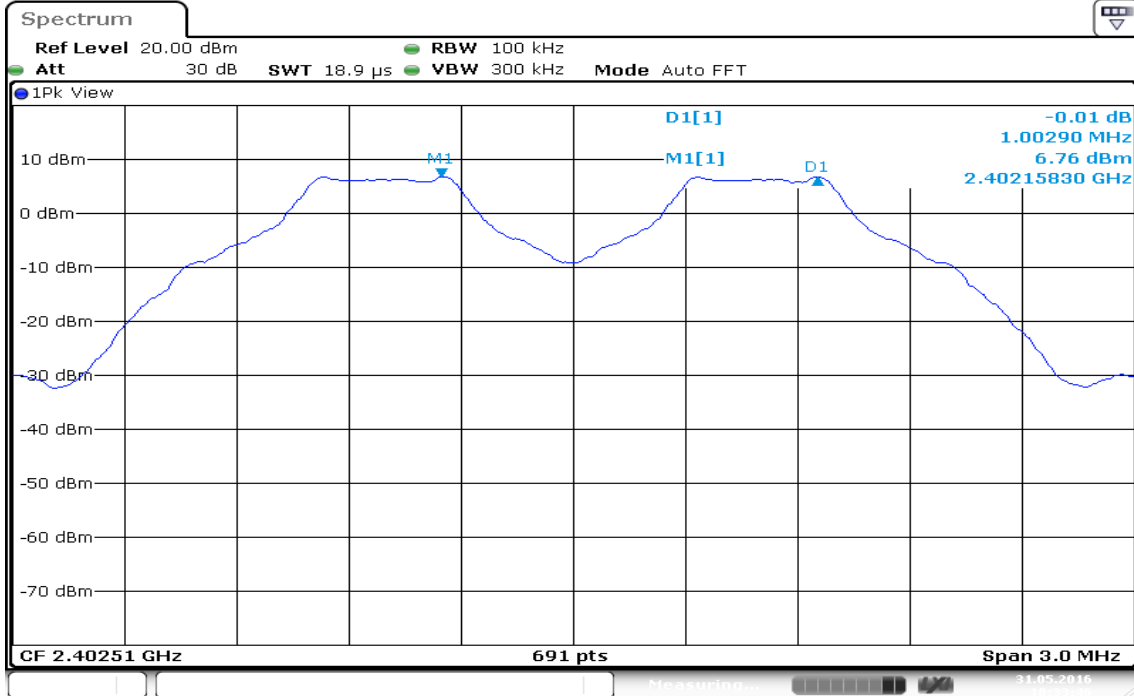

Date: 31.MAY.2016 18:33:47

**Measurement of Channel Separation / (CH Mid)**

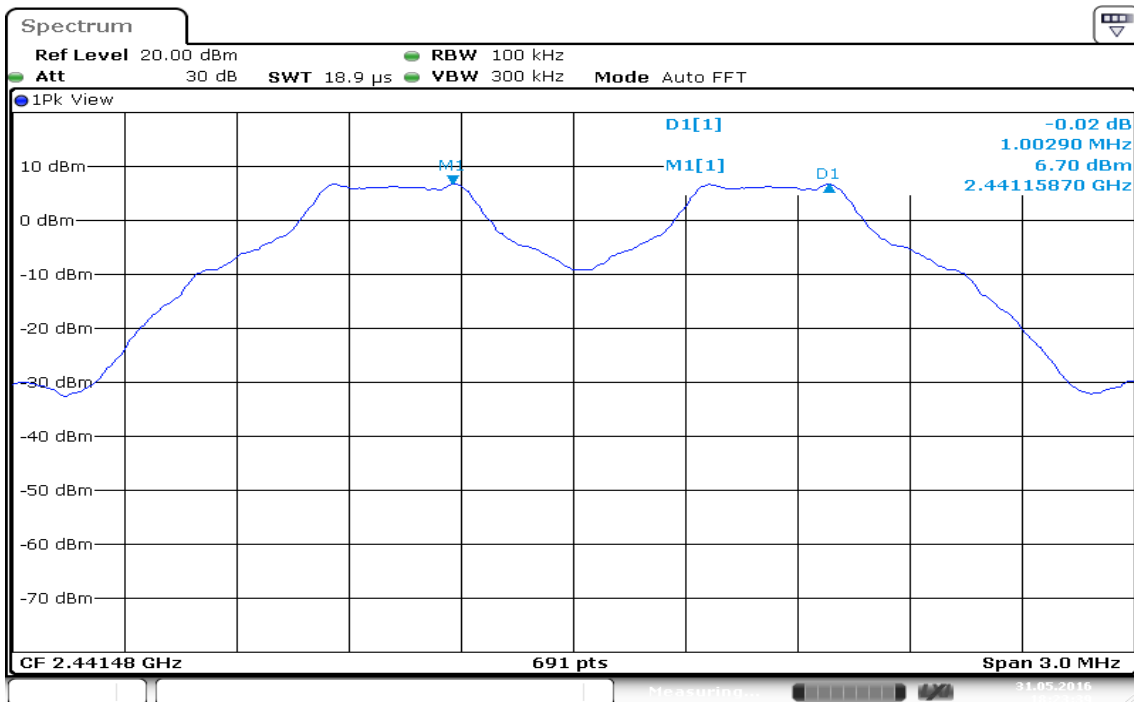

Date: 31.MAY.2016 18:23:39

### Measurement of Channel Separation / (CH High)

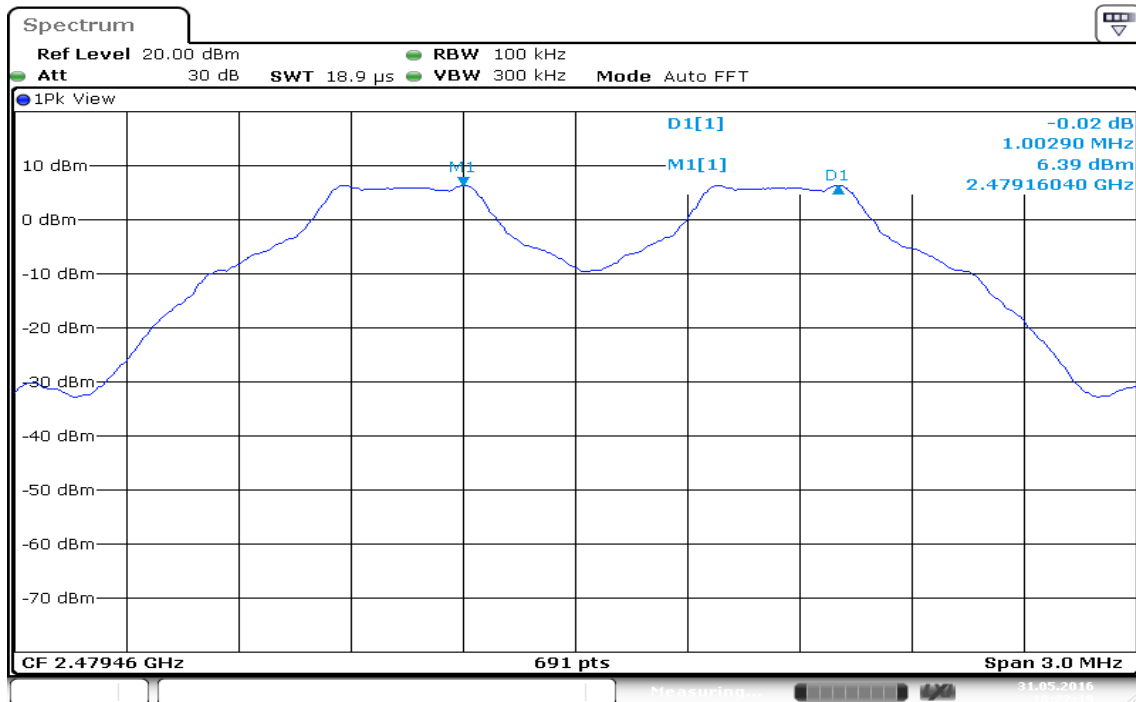

Date: 31.MAY.2016 18:22:19

**For 8DPSK / DH5**

**Measurement of Channel Separation / (CH Low)**

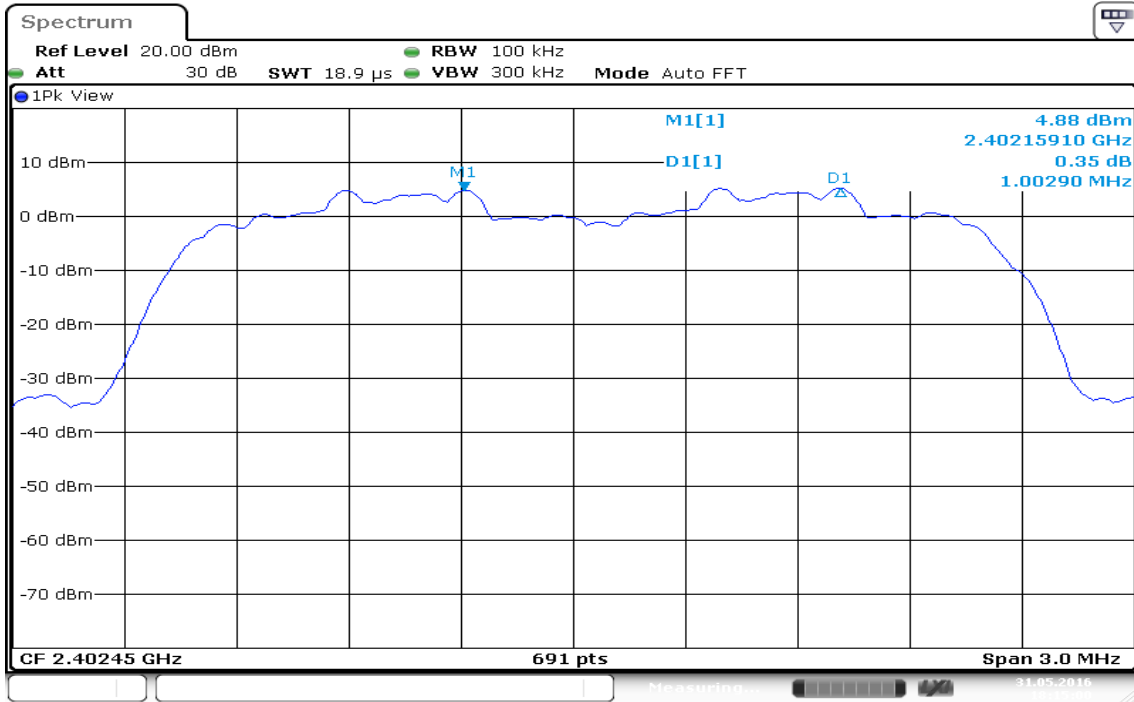

**Measurement of Channel Separation / (CH Mid)**

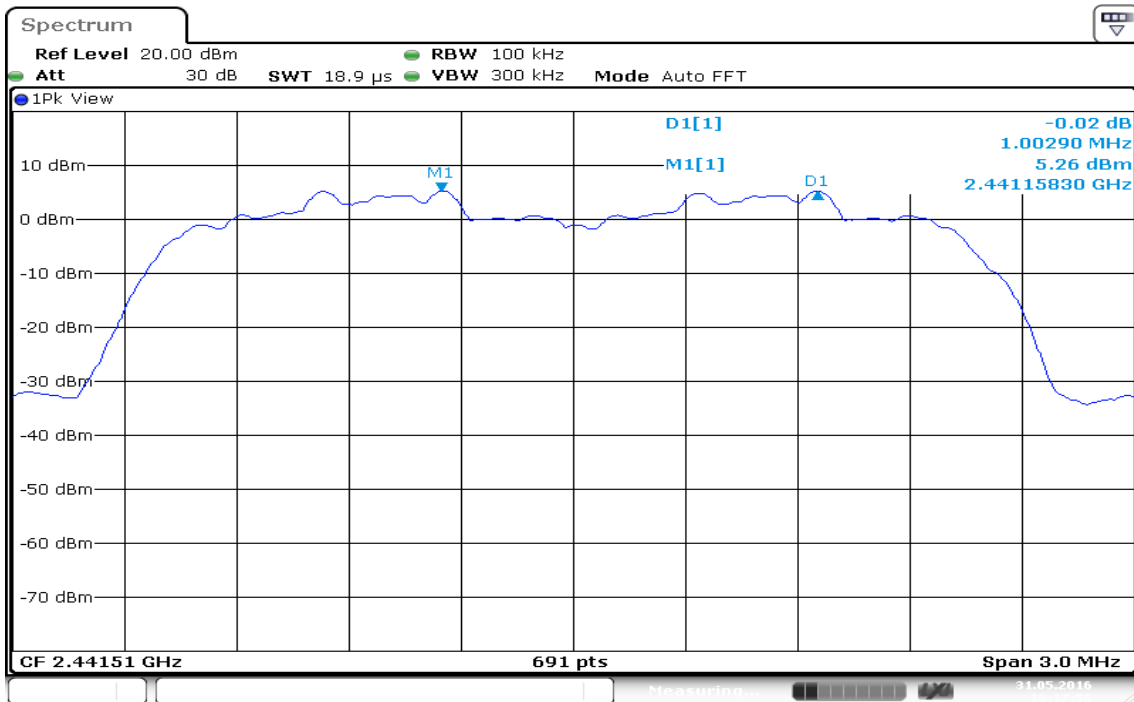



### Measurement of Channel Separation / (CH High)

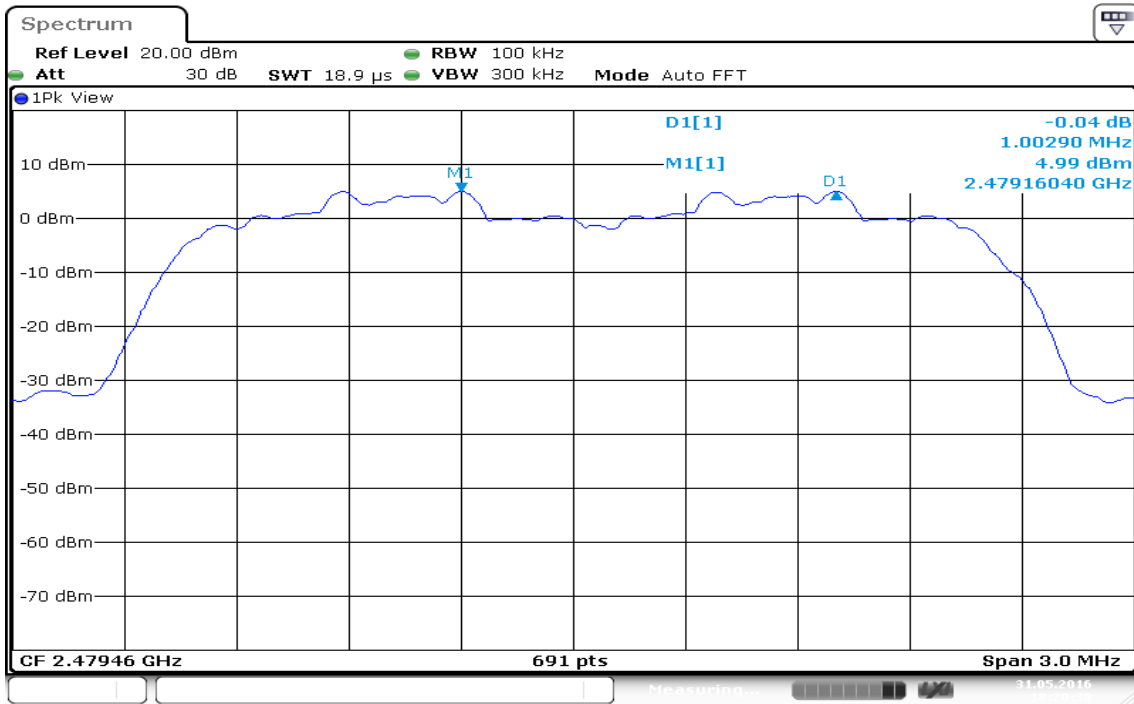

Date: 31.MAY.2016 18:20:38

## 7.7 NUMBER OF HOPPING FREQUENCY

### LIMIT

According to §15.247(a)(1)(ii), Frequency hopping systems operating in the 2400MHz-2483.5 MHz bands shall use at least 75 hopping frequencies.

According to §15.247(a)(1)(iii) & RSS-247, Frequency hopping systems operating in the 2400MHz-2483.5 MHz bands shall use at least 15 hopping frequencies.

### Test Configuration

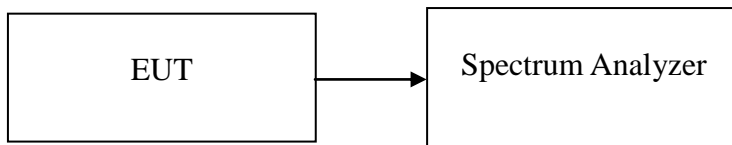

### TEST PROCEDURE

1. Place the EUT on the table and set it in transmitting mode.
2. Remove the antenna from the EUT and then connect a low loss RF cable from the antenna port to the spectrum analyzer.
3. Set spectrum analyzer Start=2400MHz, Stop = 2430.5MHz, Sweep = auto  
Start=2430.5MHz, Stop = 2460.5MHz, Sweep = auto and Start=2460.5MHz, Stop = 2485.5MHz, Sweep = auto.
4. Set the spectrum analyzer as RBW, VBW=510kHz.
5. Max hold, view and count how many channel in the band.

### TEST RESULTS

*No non-compliance noted*

#### Test Data

Result (No. of CH)	Limit (No. of CH)	Result
79	>15	PASS

**Test Plot**

**For GFSK**

**Channel Number**

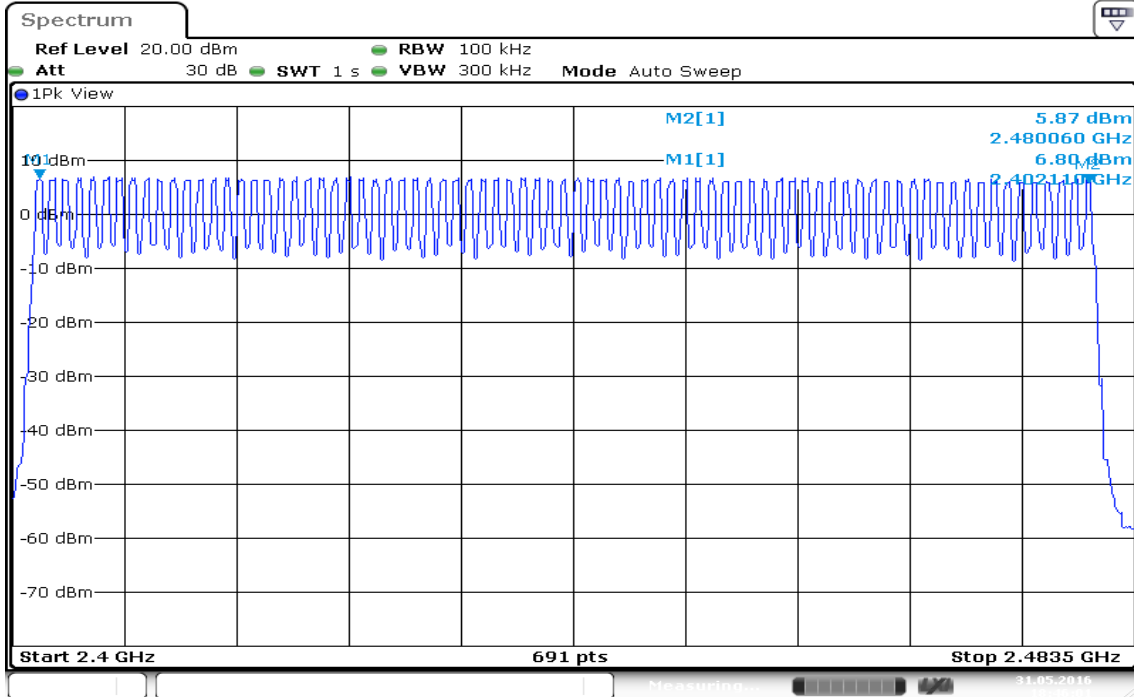

Date: 31.MAY.2016 18:46:01

**For 8DPSK**

**Channel Number**

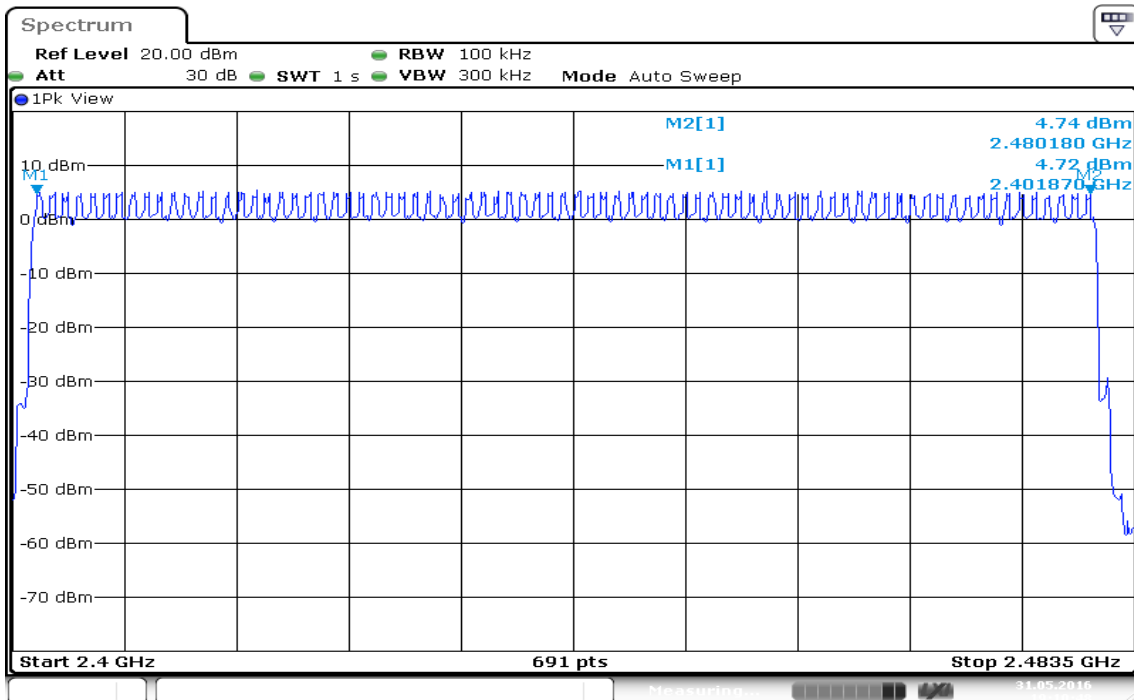

Date: 31.MAY.2016 19:10:48

## 7.8 TIME OF OCCUPANCY (DWELL TIME)

### LIMIT

According to §15.247(a)(1)(iii), Frequency hopping systems operating in the 2400MHz-2483.5 MHz bands. The average time of occupancy on any channels shall not greater than 0.4 s within a period 0.4 s multiplied by the number of hopping channels employed.

According to RSS-247, the average time of occupancy on any channel shall not be greater than 0.4 seconds within a period of 0.4 seconds multiplied by the number of hopping channels employed. Transmissions on particular hopping frequencies may be avoided or suppressed provided that a minimum of 15 hopping channels are used.

### Test Configuration

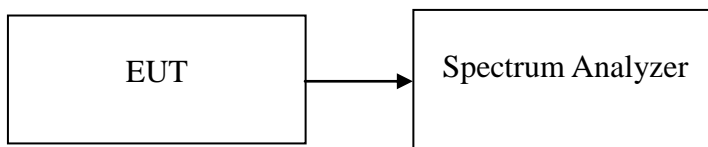

### TEST PROCEDURE

1. Place the EUT on the table and set it in transmitting mode.
2. Remove the antenna from the EUT and then connect a low loss RF cable from the antenna port to the spectrum analyzer.
3. Set center frequency of spectrum analyzer = operating frequency.
4. Set the spectrum analyzer as RBW, VBW=1MHz, Sweep = 1 ms.
5. Repeat above procedures until all frequency measured were complete.

### TEST RESULTS

*No non-compliance noted*

**Test Data**

Time of Occupancy (Dwell Time)						
Mode	Frequency (MHz)	Pulse Time Per Hopping (ms)	Number of pulse in	Dwell Time IN	Dwell Time Limits (s)	Result
			(0.4 * N sec)	(0.4 * N sec)		
BR-1Mbps	2402	2.942	106.67	0.3138	0.4	Pass
EDR-3Mbps	2402	2.942	106.67	0.3138	0.4	
AFH: DH5	2402	2.942	53.33	0.1569	0.4	

Non-AFH: DH5 Packet permit maximum  $1600 / 79 / 6 = 3.37$  hops per second in each channel (5 time slots RX, 1 time slot TX). So, the dwell time is the time duration of the pulse times  $3.37 * 0.4 * 79 = 106.6$

AFH: DH5 Packet permit maximum  $800 / 20 / 6 = 6.666$  hops per second in each channel (5 time slots RX, 1 time slot TX). So, the dwell time is the time duration of the pulse times  $6.666 * 0.4 * 20 = 53.33$

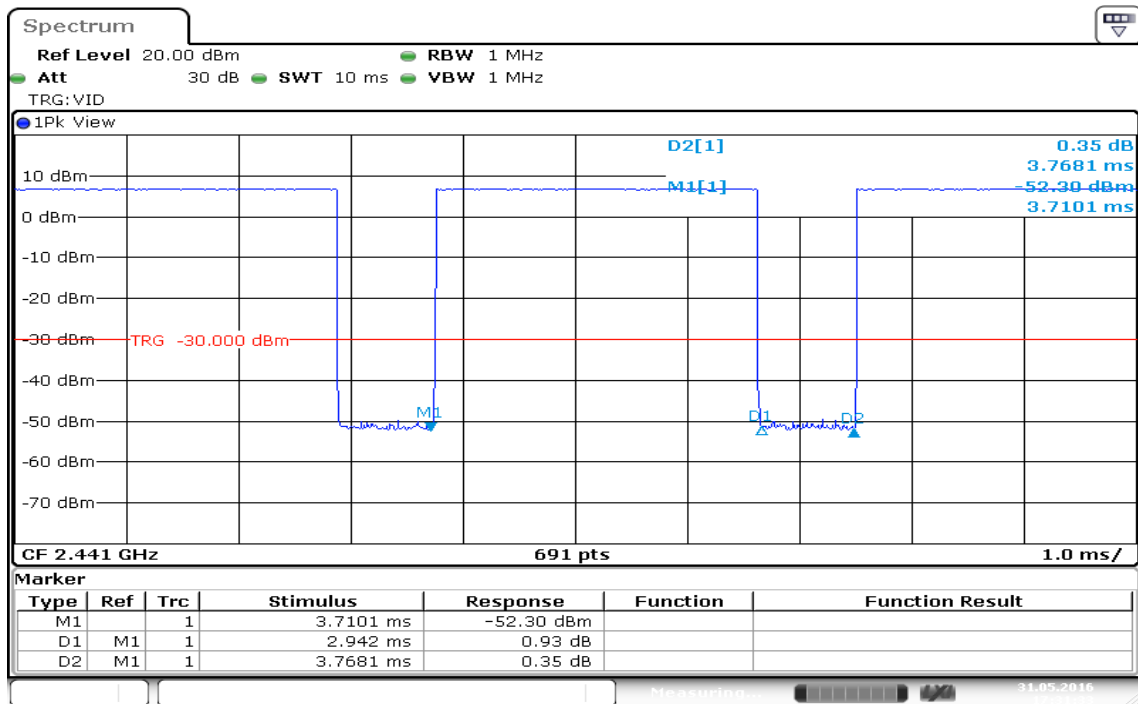

Date: 31.MAY.2016 17:31:34

## 7.9 RADIATED EMISSIONS

### LIMIT

All spurious emissions shall comply with the limits of §15.209(a) and RSS-Gen Table 2 & Table 5.

### RSS-Gen Table 2 & Table 5: General Field Strength Limits for Transmitters and Receivers at Frequencies Above 30 MHz <sup>(Note)</sup>

Frequency (MHz)	Field Strength microvolts/m at 3 metres (watts, e.i.r.p.)	
	Transmitters	Receivers
30-88	100 (3 nW)	100 (3 nW)
88-216	150 (6.8 nW)	150 (6.8 nW)
216-960	200 (12 nW)	200 (12 nW)
Above 960	500 (75 nW)	500 (75 nW)

**Note:** \*Measurements for compliance with limits in the above table may be performed at distances other than 3 metres, in accordance with Section 7.2.7.

Transmitting devices are not permitted in Table 1 bands or, unless stated otherwise, in TV bands (54-72 MHz, 76-88 MHz, 174-216 MHz, 470-608 MHz and 614-806 MHz).

### RSS-Gen Table 6: General Field Strength Limits for Transmitters at Frequencies Below 30 MHz (Transmit)

Frequency	Field Strength (microvolts/m)	Magnetic H-Field (microamperes/m)	Measurement Distance (metres)
9-490 kHz	2,400/F (F in kHz)	2,400/377F (F in kHz)	3000
490-1,705 kHz	24,000/F (F in kHz)	24,000/377F (F in kHz)	30
1.705-30 MHz	30	N/A	30

**Note:** The emission limits for the bands 9-90 kHz and 110-490 kHz are based on measurements employing an average detector.

**Test Configuration**

**9kHz ~ 30MHz**

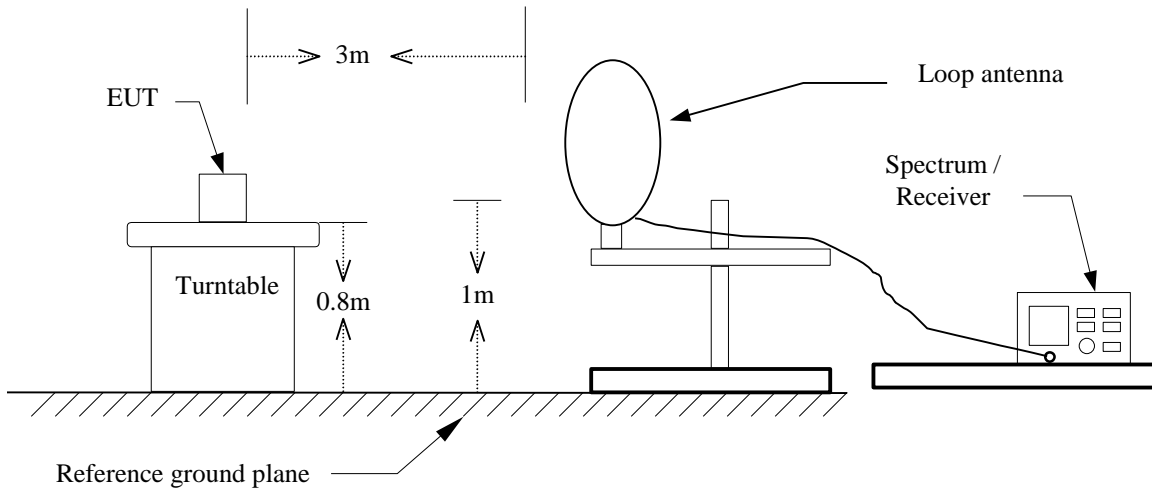

**30MHz ~ 1GHz**

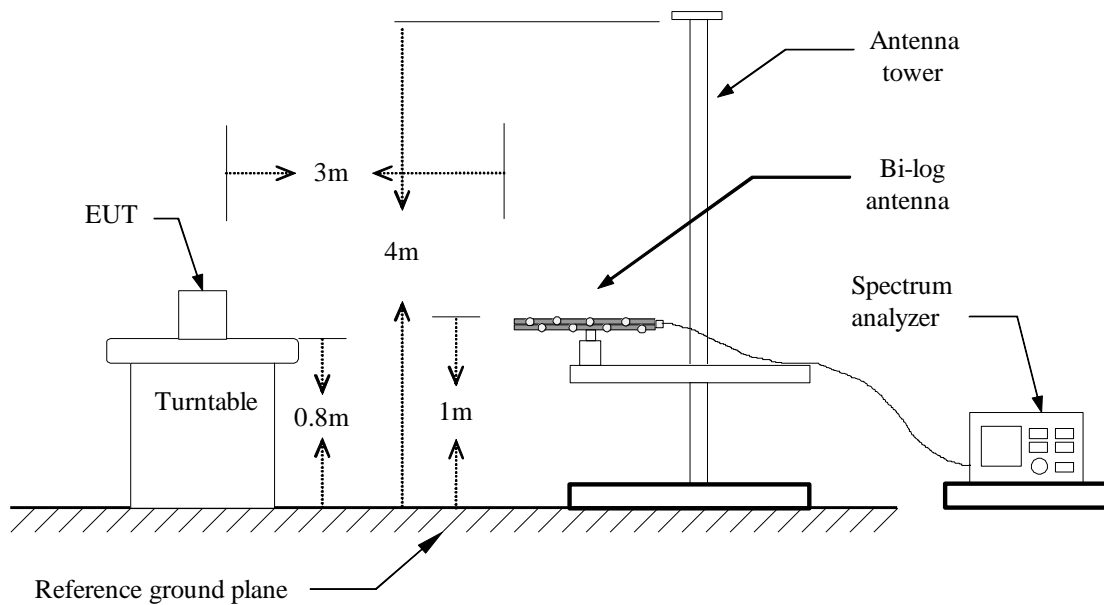

**Above 1 GHz**

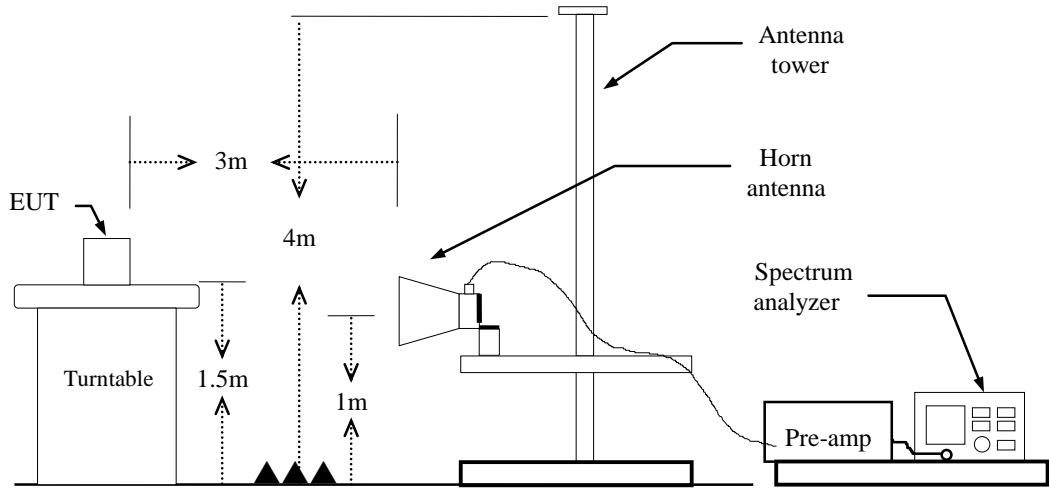



## **TEST PROCEDURE**

1. The EUT is placed on a turntable, Above 1 GHz is 1.5m high and below 1 GHz is 0.8m high above ground plane.
2. The turntable shall be rotated for 360 degrees to determine the position of maximum emission level.
3. EUT is set 3m away from the receiving antenna, which is varied from 1m to 4m to find out the highest emissions.
4. Maximum procedure was performed on the six highest emissions to ensure EUT compliance.
5. And also, each emission was to be maximized by changing the polarization of receiving antenna both horizontal and vertical.
6. Set the spectrum analyzer in the following setting as:

Below 1GHz:

RBW=100kHz / VBW=300kHz / Sweep=AUTO

Above 1GHz:

(a) PEAK: RBW=1MHz / VBW=3MHz / Sweep=AUTO

(b) AVERAGE: RBW=1MHz,  
if duty cycle  $\geq$  98%, VBW=10Hz.  
if duty cycle < 98% VBW=1/T.

**BT:** = 78%, VBW= 360Hz

**EDR** = 78%, VBW= 360Hz

7. Repeat above procedures until the measurements for all frequencies are complete.
8. Result = Spectrum Reading + cable loss(spectrum to Amp) - Amp Gain + Cable loss(Amp to receive Ant)+ Receive Ant

**Note:** We checked every harmonics frequencies from Fundamental frequencies with reduced VBW, and we mark a point to prove pass or not if we find any emission. For this case, there are no emissions hidden in the noise floor.

## TEST RESULTS

### Below 1GHz

**Operation Mode:** Normal Link      **Test Date:** June 2, 2016  
**Temperature:** 27°C      **Tested by:** Dennis Li  
**Humidity:** 53% RH      **Polarity:** Ver.

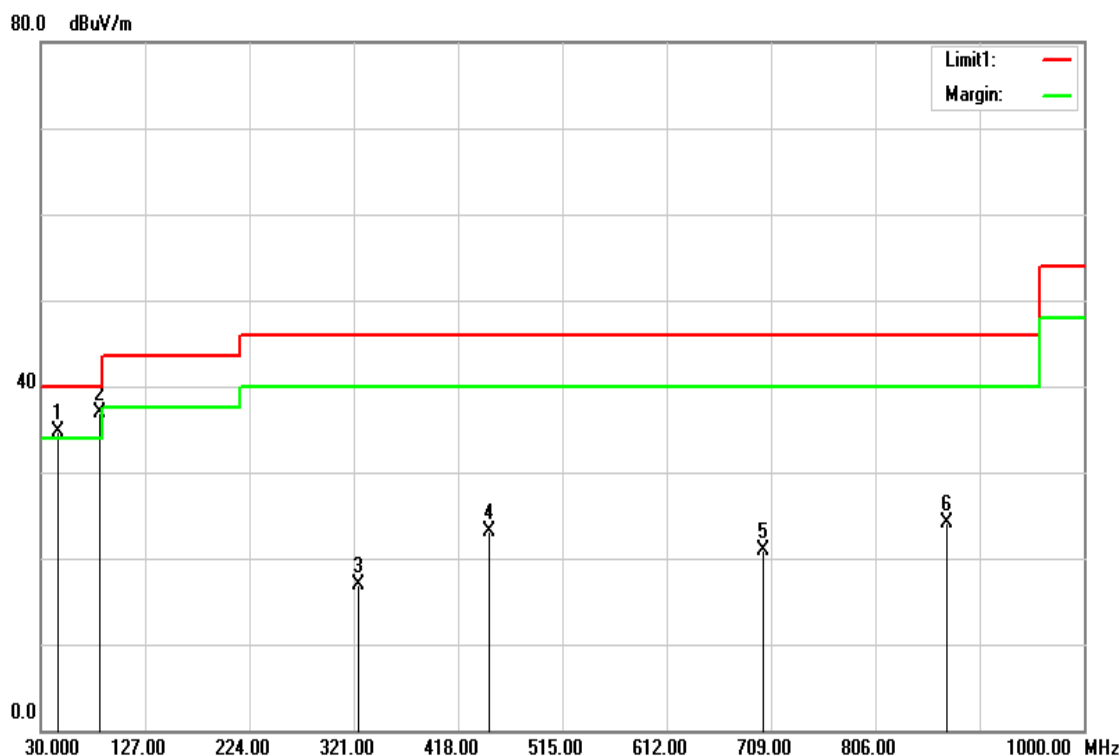

Frequency (MHz)	Reading (dBuV)	Correction Factor (dB/m)	Result (dBuV/m)	Limit (dBuV/m)	Margin (dB)	Remark	Ant.Pol. (H/V)
46.4900	53.77	-19.06	34.71	40.00	-5.29	peak	V
85.2900	58.29	-21.38	36.91	40.00	-3.09	peak	V
324.8800	30.40	-13.57	16.83	46.00	-29.17	peak	V
447.1000	33.41	-10.28	23.13	46.00	-22.87	peak	V
701.2400	27.00	-6.04	20.96	46.00	-25.04	peak	V
872.9300	27.57	-3.51	24.06	46.00	-21.94	peak	V

**Remark:**

1. No emission found between lowest internal used/generated frequency to 30MHz (9kHz~30MHz)
2. Radiated emissions measured in frequency range from 30 MHz to 1000MHz were made with an instrument using peak/quasi-peak detector mode.
3. Quasi-peak test would be performed if the peak result were greater than the quasi-peak limit or as required by the applicant.
4. Measurements above show only up to 6 maximum emissions noted, or would be lesser, with " N/A " remark, if no specific emissions from the EUT are recorded (ie: margin>20dB from the applicable limit) and considered that's already beyond the background noise floor.
5. Margin (dB) = Remark result (dBuV/m) – Quasi-peak limit (dBuV/m).

**Operation Mode:** Normal Link      **Test Date:** June 2, 2016  
**Temperature:** 27°C      **Tested by:** Dennis Li  
**Humidity:** 53% RH      **Polarity:** Hor.

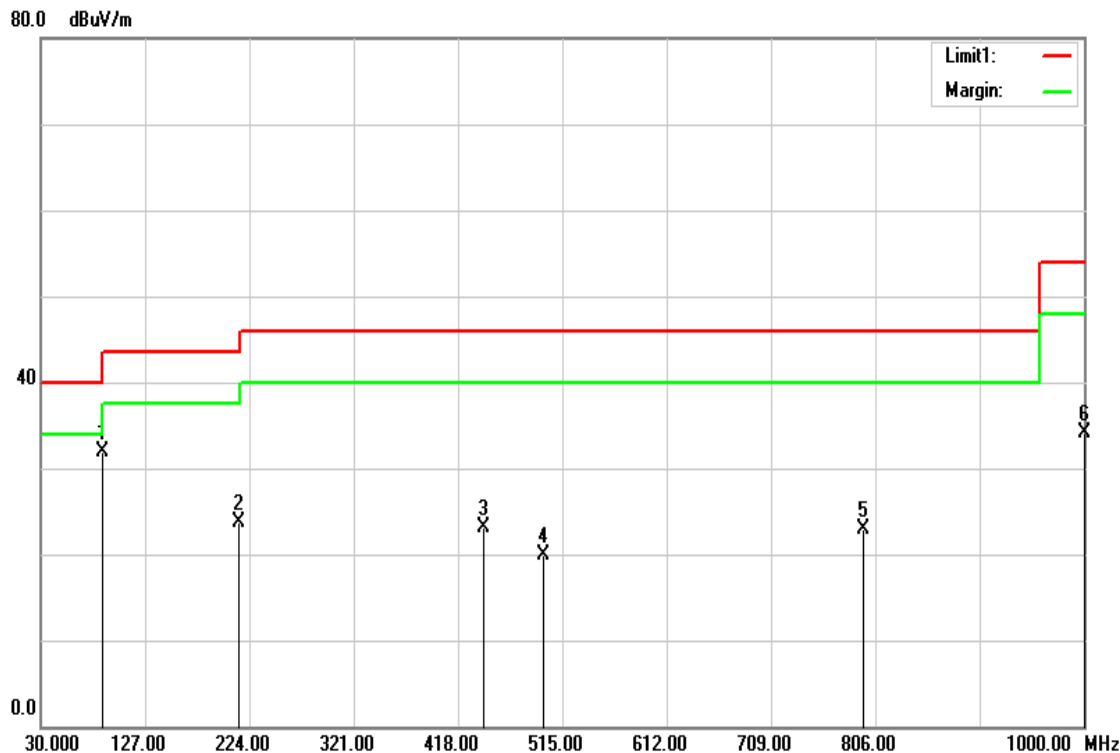

Frequency (MHz)	Reading (dBuV)	Correction Factor (dB/m)	Result (dBuV/m)	Limit (dBuV/m)	Margin (dB)	Remark	Ant.Pol. (H/V)
87.2300	53.42	-21.43	31.99	40.00	-8.01	peak	H
214.3000	40.29	-16.56	23.73	43.50	-19.77	peak	H
442.2500	33.54	-10.42	23.12	46.00	-22.88	peak	H
497.5400	29.28	-9.29	19.99	46.00	-26.01	peak	H
795.3300	27.50	-4.54	22.96	46.00	-23.04	peak	H
1000.0000	35.68	-1.58	34.10	54.00	-19.90	peak	H

**Remark:**

1. No emission found between lowest internal used/generated frequency to 30MHz (9kHz~30MHz)
2. Radiated emissions measured in frequency range from 30 MHz to 1000MHz were made with an instrument using peak/quasi-peak detector mode.
3. Quasi-peak test would be performed if the peak result were greater than the quasi-peak limit or as required by the applicant.
4. Measurements above show only up to 6 maximum emissions noted, or would be lesser, with " N/A " remark, if no specific emissions from the EUT are recorded (ie: margin>20dB from the applicable limit) and considered that's already beyond the background noise floor.
5. Margin (dB) = Remark result (dBuV/m) – Quasi-peak limit (dBuV/m).

**Above 1 GHz**

**TX / GFSK / DH5 / CH Low**

**Polarity: Vertical**

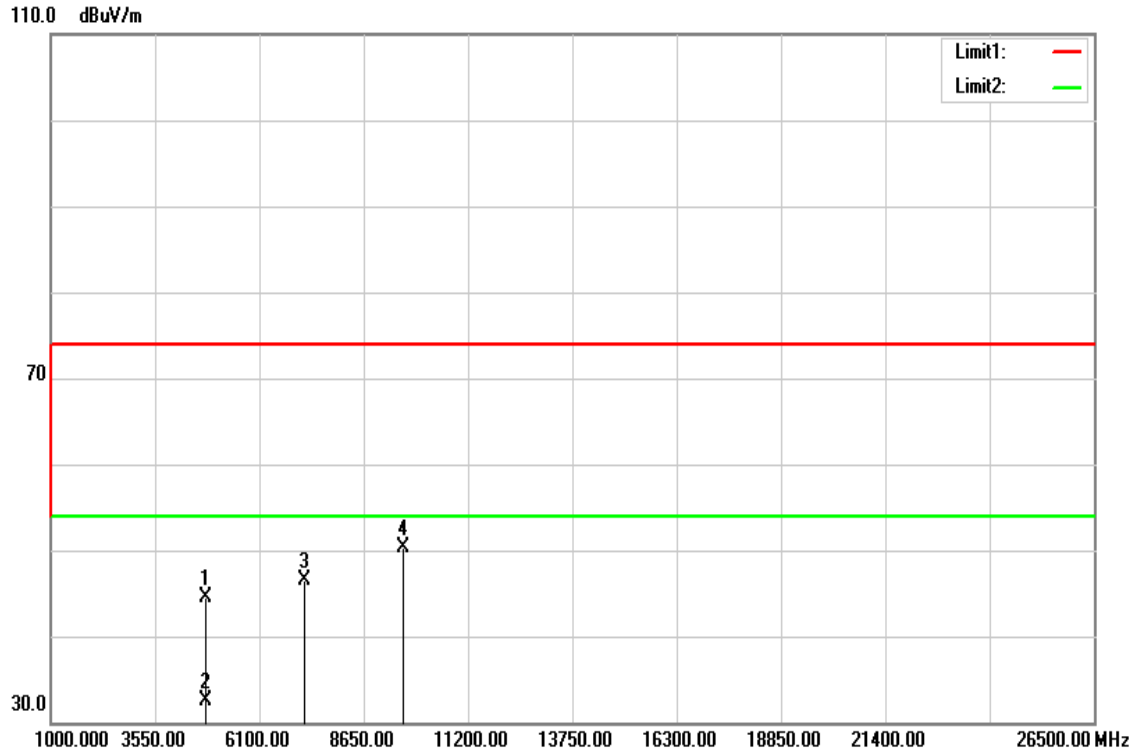

**Polarity: Horizontal**

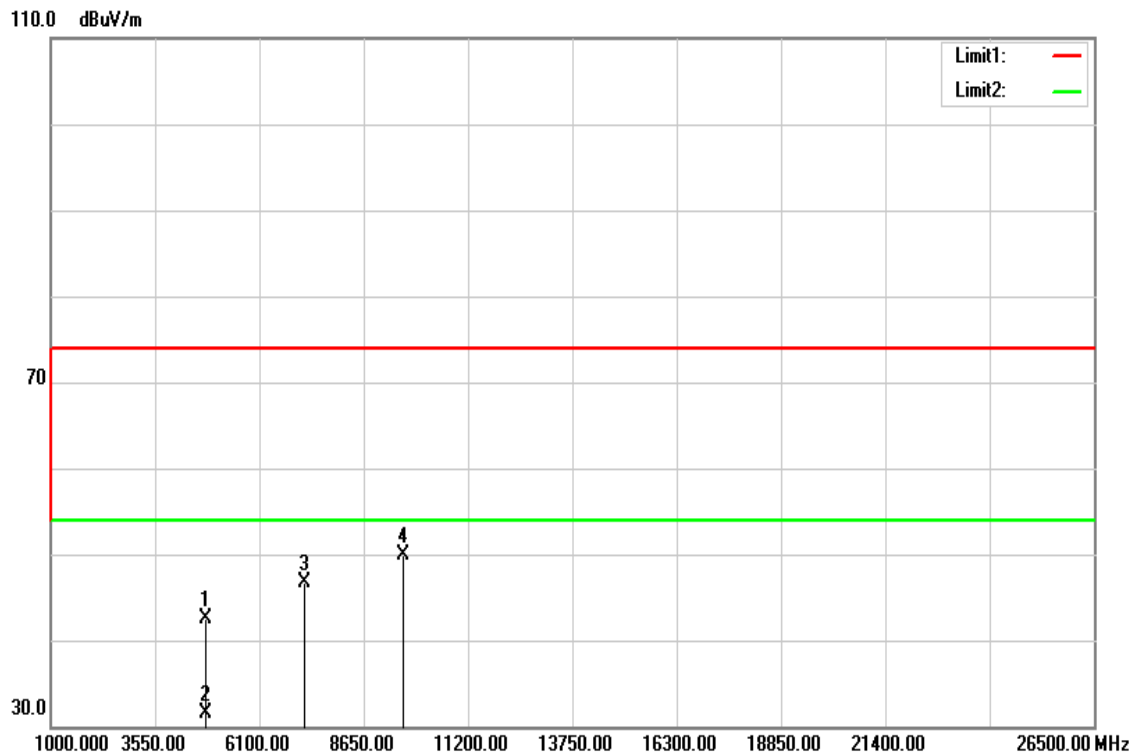

**Above 1 GHz**

**Operation Mode:** TX / GFSK / DH5 / CH Low

**Test Date:** June 1, 2016

**Temperature:** 27°C

**Tested by:** Dennis Li

**Humidity:** 53 % RH

**Polarity:** Ver. / Hor.

Frequency (MHz)	Reading (dBuV)	Correction (dB/m)	Result (dBuV/m)	Limit (dBuV/m)	Margin (dB)	Remark	Ant.Pol. (H/V)
4804.000	39.51	5.04	44.55	74.00	-29.45	peak	V
4804.000	27.52	5.04	32.56	54.00	-21.44	AVG	V
7206.000	33.95	12.62	46.57	74.00	-27.43	peak	V
9608.000	32.67	17.60	50.27	74.00	-23.73	peak	V
N/A							
4804.000	37.39	5.04	42.43	74.00	-31.57	peak	H
4804.000	26.42	5.04	31.46	54.00	-22.54	AVG	H
7206.000	34.07	12.62	46.69	74.00	-27.31	peak	H
9608.000	32.23	17.60	49.83	74.00	-24.17	peak	H
N/A							

**Remark:**

1. *Measuring frequencies from 1 GHz to the 10th harmonic of highest fundamental frequency.*
2. *Radiated emissions measured in frequency above 1000MHz were made with an instrument using peak/average detector mode.*
3. *Average test would be performed if the peak result were greater than the average limit .*
4. *Data of measurement within this frequency range shown “ --- ” in the table above means the reading of emissions are attenuated more than 20dB below the permissible limits or the field strength is too small to be measured.*
5. *Measurements above show only up to 6 maximum emissions noted, or would be lesser, with “ N/A ” remark, if no specific emissions from the EUT are recorded (ie: margin>20dB from the applicable limit) and considered that's already beyond the background noise floor.*
6. *Margin (dB) = Remark result (dBuV/m) – Average limit (dBuV/m).*

**TX / GFSK / DH5 / CH Mid**

**Polarity: Vertical**

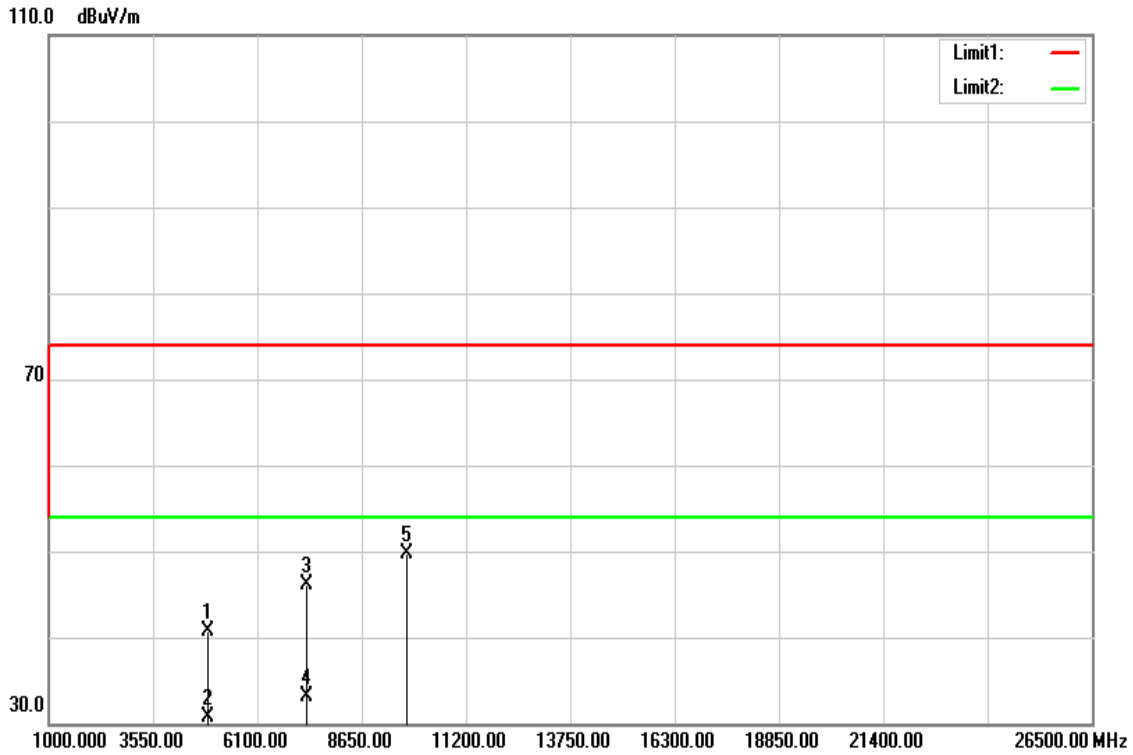

**Polarity: Horizontal**

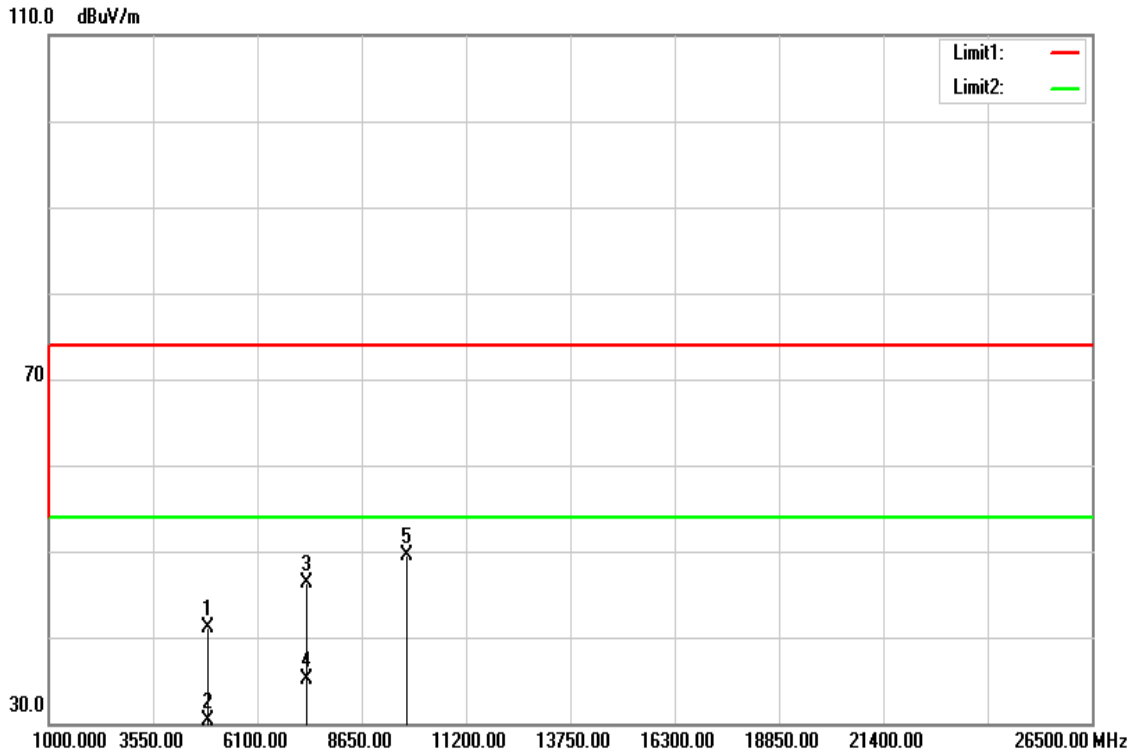

**Operation Mode:** TX / GFSK / DH5 / CH Mid

**Test Date:** June 1, 2016

**Temperature:** 26°C

**Tested by:** Dennis Li

**Humidity:** 50 % RH

**Polarity:** Ver. / Hor.

Frequency (MHz)	Reading (dBuV)	Correction (dB/m)	Result (dBuV/m)	Limit (dBuV/m)	Margin (dB)	Remark	Ant.Pol. (H/V)
4880.000	35.35	5.25	40.60	74.00	-33.40	peak	V
4880.000	25.39	5.25	30.64	54.00	-23.36	AVG	V
7320.000	33.18	12.97	46.15	74.00	-27.85	peak	V
7320.000	20.17	12.97	33.14	54.00	-20.86	AVG	V
9760.000	32.11	17.60	49.71	74.00	-24.29	peak	V
N/A							
4880.000	35.77	5.25	41.02	74.00	-32.98	peak	H
4880.000	24.98	5.25	30.23	54.00	-23.77	AVG	H
7320.000	33.33	12.97	46.30	74.00	-27.70	peak	H
7320.000	22.14	12.97	35.11	54.00	-18.89	AVG	H
9760.000	31.87	17.60	49.47	74.00	-24.53	peak	H
N/A							

**Remark:**

1. *Measuring frequencies from 1 GHz to the 10th harmonic of highest fundamental frequency.*
2. *Radiated emissions measured in frequency above 1000MHz were made with an instrument using peak/average detector mode.*
3. *Average test would be performed if the peak result were greater than the average limit.*
4. *Data of measurement within this frequency range shown “ --- ” in the table above means the reading of emissions are attenuated more than 20dB below the permissible limits or the field strength is too small to be measured.*
5. *Measurements above show only up to 6 maximum emissions noted, or would be lesser, with “ N/A ” remark, if no specific emissions from the EUT are recorded (ie: margin>20dB from the applicable limit) and considered that's already beyond the background noise floor.*
6. *Margin (dB) = Remark result (dBuV/m) – Average limit (dBuV/m).*

**TX / GFSK / DH5 / CH High**

**Polarity: Vertical**

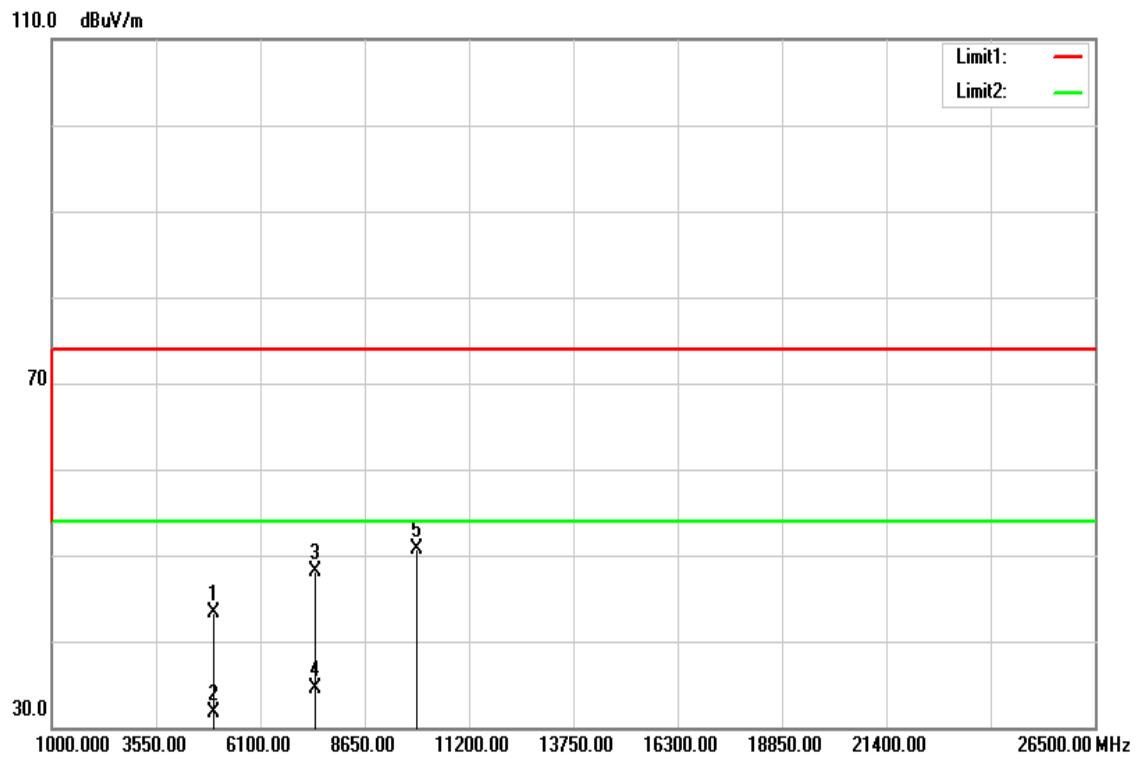

**Polarity: Horizontal**

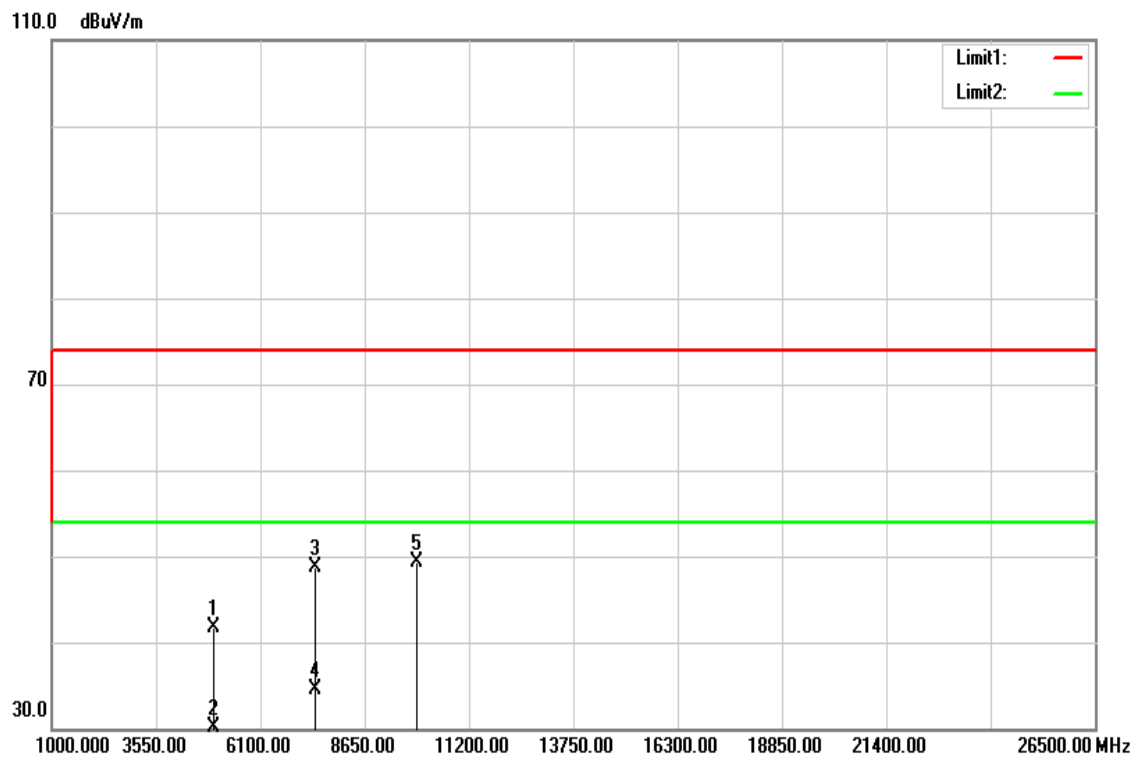



**Operation Mode:** TX / GFSK / DH5 / CH High  
**Temperature:** 26°C  
**Humidity:** 50 % RH

**Test Date:** June 1, 2016  
**Tested by:** Dennis Li  
**Polarity:** Ver. / Hor.

Frequency (MHz)	Reading (dBuV)	Correction (dB/m)	Result (dBuV/m)	Limit (dBuV/m)	Margin (dB)	Remark	Ant.Pol. (H/V)
4960.000	37.79	5.46	43.25	74.00	-30.75	peak	V
4960.000	26.18	5.46	31.64	54.00	-22.36	AVG	V
7440.000	34.73	13.33	48.06	74.00	-25.94	peak	V
7440.000	21.12	13.33	34.45	54.00	-19.55	AVG	V
9920.000	33.18	17.60	50.78	74.00	-23.22	peak	V
N/A							
4960.000	36.31	5.46	41.77	74.00	-32.23	peak	H
4960.000	24.66	5.46	30.12	54.00	-23.88	AVG	H
7440.000	35.35	13.33	48.68	74.00	-25.32	peak	H
7440.000	21.12	13.33	34.45	54.00	-19.55	AVG	H
9920.000	31.75	17.60	49.35	74.00	-24.65	peak	H
N/A							

**Remark:**

1. Measuring frequencies from 1 GHz to the 10th harmonic of highest fundamental frequency.
2. Radiated emissions measured in frequency above 1000MHz were made with an instrument using peak/average detector mode.
3. Average test would be performed if the peak result were greater than the average limit.
4. Data of measurement within this frequency range shown “ --- ” in the table above means the reading of emissions are attenuated more than 20dB below the permissible limits or the field strength is too small to be measured.
5. Measurements above show only up to 6 maximum emissions noted, or would be lesser, with “ N/A ” remark, if no specific emissions from the EUT are recorded (ie: margin>20dB from the applicable limit) and considered that's already beyond the background noise floor.
6. Margin (dB) = Remark result (dBuV/m) – Average limit (dBuV/m).

**TX / 8DPSK / DH5 / CH Low**

**Polarity: Vertical**

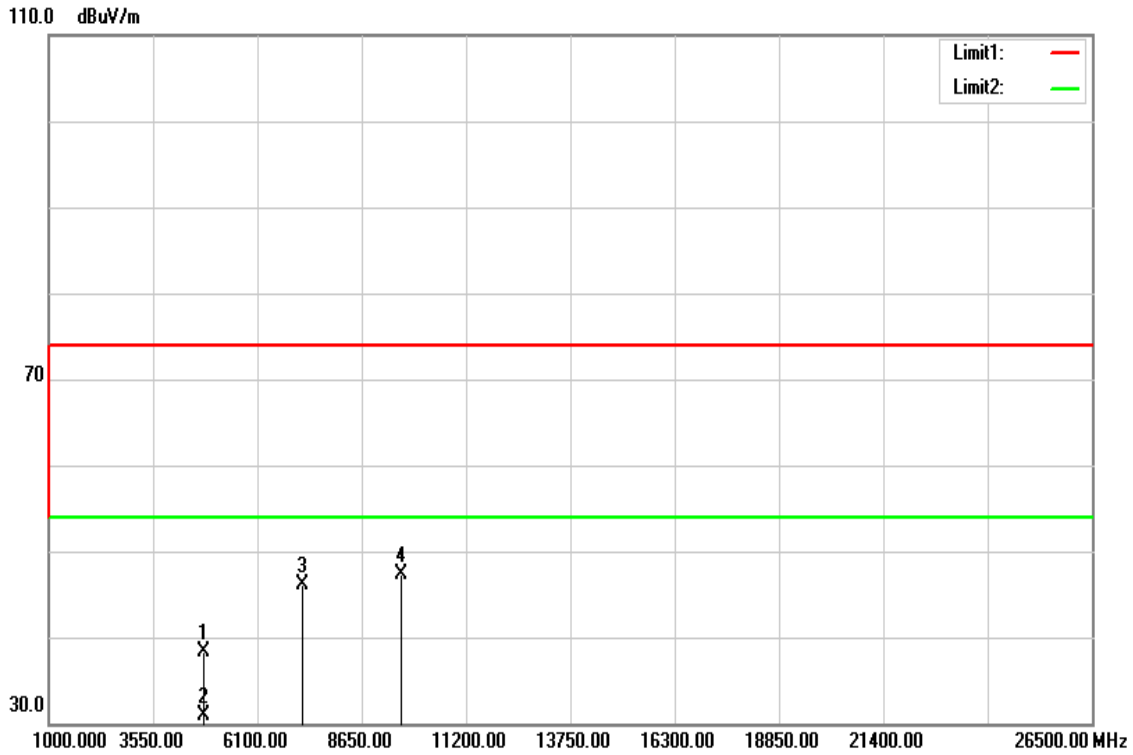

**Polarity: Horizontal**

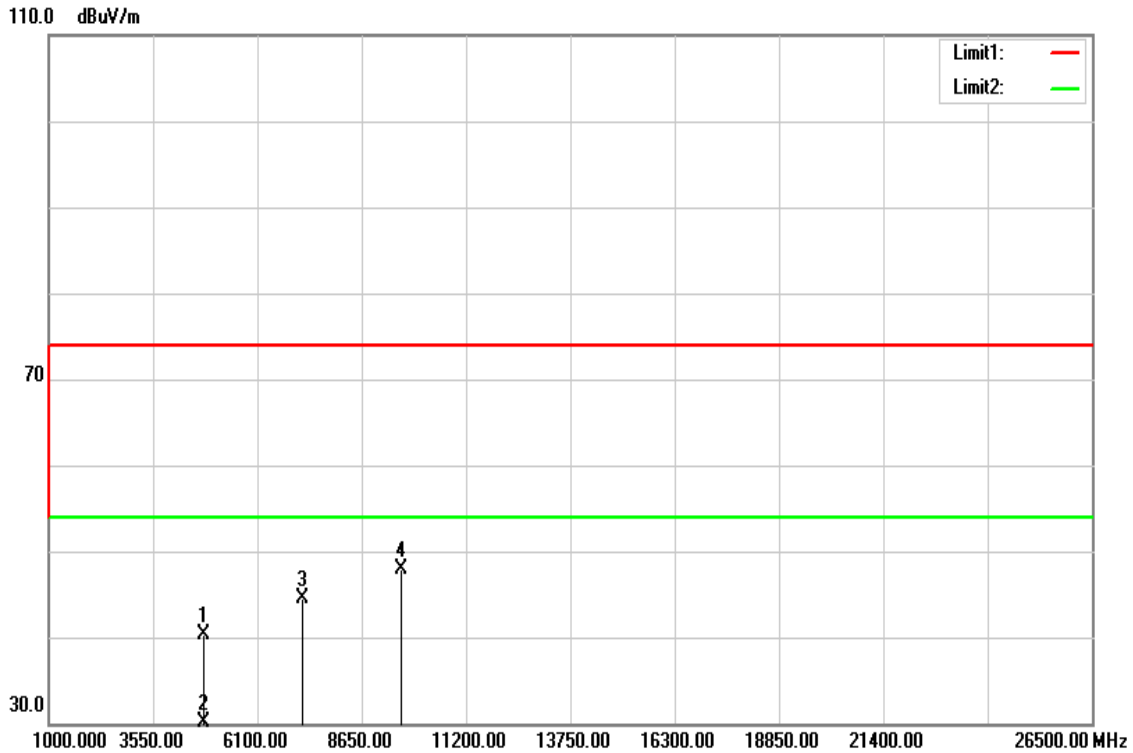

**Operation Mode:** TX / 8DPSK / DH5 / CH Low  
**Temperature:** 26°C  
**Humidity:** 50 % RH

**Test Date:** June 1, 2016  
**Tested by:** Dennis Li  
**Polarity:** Ver. / Hor.

Frequency (MHz)	Reading (dBuV)	Correction (dB/m)	Result (dBuV/m)	Limit (dBuV/m)	Margin (dB)	Remark	Ant.Pol. (H/V)
4804.000	33.35	5.04	38.39	74.00	-35.61	peak	V
4804.000	25.81	5.04	30.85	54.00	-23.15	AVG	V
7206.000	33.40	12.62	46.02	74.00	-27.98	peak	V
9608.000	29.72	17.60	47.32	74.00	-26.68	peak	V
N/A							
4804.000	35.16	5.04	40.20	74.00	-33.80	peak	H
4804.000	25.10	5.04	30.14	54.00	-23.86	AVG	H
7206.000	31.80	12.62	44.42	74.00	-29.58	peak	H
9608.000	30.35	17.60	47.95	74.00	-26.05	peak	H
N/A							

**Remark:**

1. Measuring frequencies from 1 GHz to the 10th harmonic of highest fundamental frequency.
2. Radiated emissions measured in frequency above 1000MHz were made with an instrument using peak/average detector mode.
3. Average test would be performed if the peak result were greater than the average limit.
4. Data of measurement within this frequency range shown “ --- ” in the table above means the reading of emissions are attenuated more than 20dB below the permissible limits or the field strength is too small to be measured.
5. Measurements above show only up to 6 maximum emissions noted, or would be lesser, with “ N/A ” remark, if no specific emissions from the EUT are recorded (ie: margin>20dB from the applicable limit) and considered that's already beyond the background noise floor.
6. Margin (dB) = Remark result (dBuV/m) – Average limit (dBuV/m).

**TX / 8DPSK / DH5 / CH Mid**

**Polarity: Vertical**

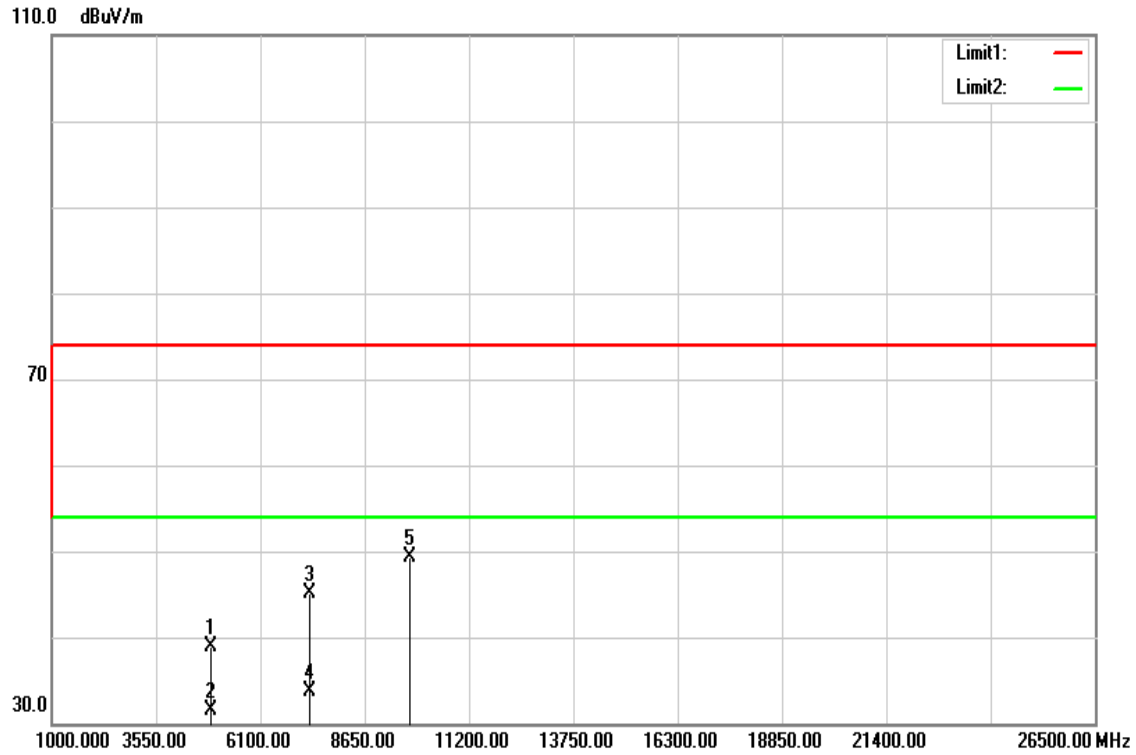

**Polarity: Horizontal**

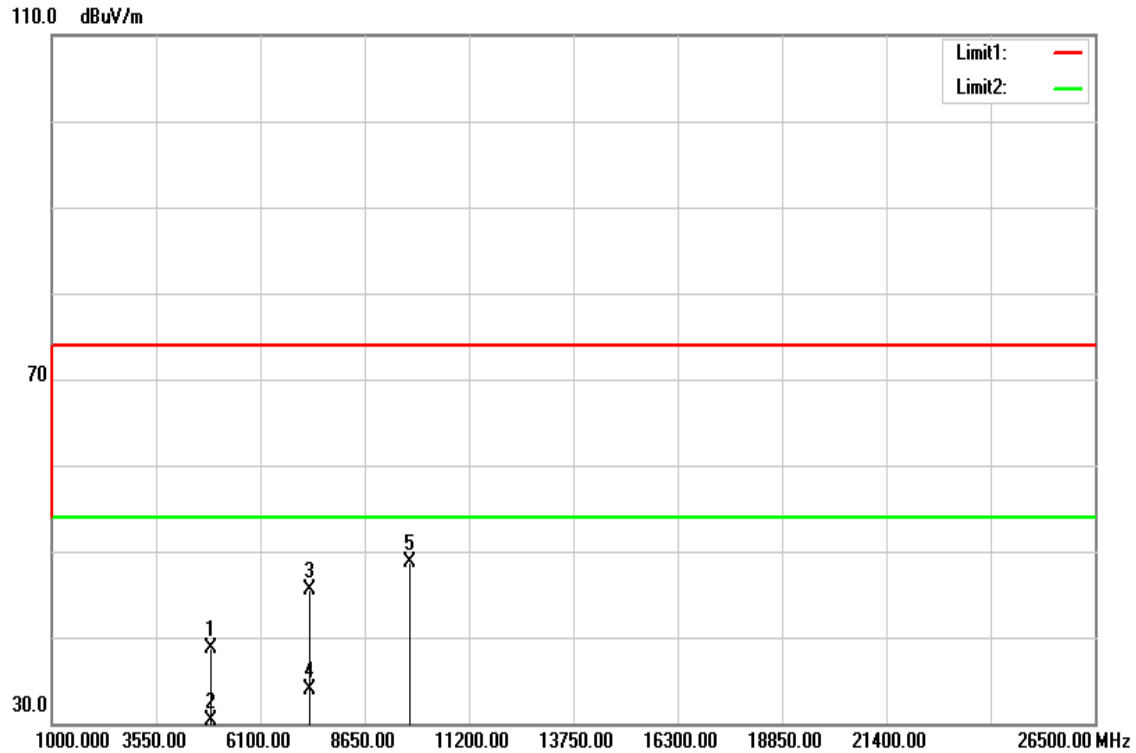

**Operation Mode:** TX / 8DPSK / DH5 / CH Mid  
**Temperature:** 26°C  
**Humidity:** 50 % RH

**Test Date:** June 1, 2016  
**Tested by:** Dennis Li  
**Polarity:** Ver. / Hor.

Frequency (MHz)	Reading (dBuV)	Correction (dB/m)	Result (dBuV/m)	Limit (dBuV/m)	Margin (dB)	Remark	Ant.Pol. (H/V)
4880.000	33.61	5.25	38.86	74.00	-35.14	peak	V
4880.000	26.20	5.25	31.45	54.00	-22.55	AVG	V
7320.000	32.16	12.97	45.13	74.00	-28.87	peak	V
7320.000	20.78	12.97	33.75	54.00	-20.25	AVG	V
9760.000	31.70	17.60	49.30	74.00	-24.70	peak	V
N/A							
4880.000	33.43	5.25	38.68	74.00	-35.32	peak	H
4880.000	25.00	5.25	30.25	54.00	-23.75	AVG	H
7320.000	32.53	12.97	45.50	74.00	-28.50	peak	H
7320.000	20.99	12.97	33.96	54.00	-20.04	AVG	H
9760.000	31.03	17.60	48.63	74.00	-25.37	peak	H
N/A							

**Remark:**

1. Measuring frequencies from 1 GHz to the 10th harmonic of highest fundamental frequency.
2. Radiated emissions measured in frequency above 1000MHz were made with an instrument using peak/average detector mode.
3. Average test would be performed if the peak result were greater than the average limit.
4. Data of measurement within this frequency range shown “ --- ” in the table above means the reading of emissions are attenuated more than 20dB below the permissible limits or the field strength is too small to be measured.
5. Measurements above show only up to 6 maximum emissions noted, or would be lesser, with “ N/A ” remark, if no specific emissions from the EUT are recorded (ie: margin>20dB from the applicable limit) and considered that's already beyond the background noise floor.
6. Margin (dB) = Remark result (dBuV/m) – Average limit (dBuV/m).

**TX / 8DPSK / DH5 / CH High**

**Polarity: Vertical**

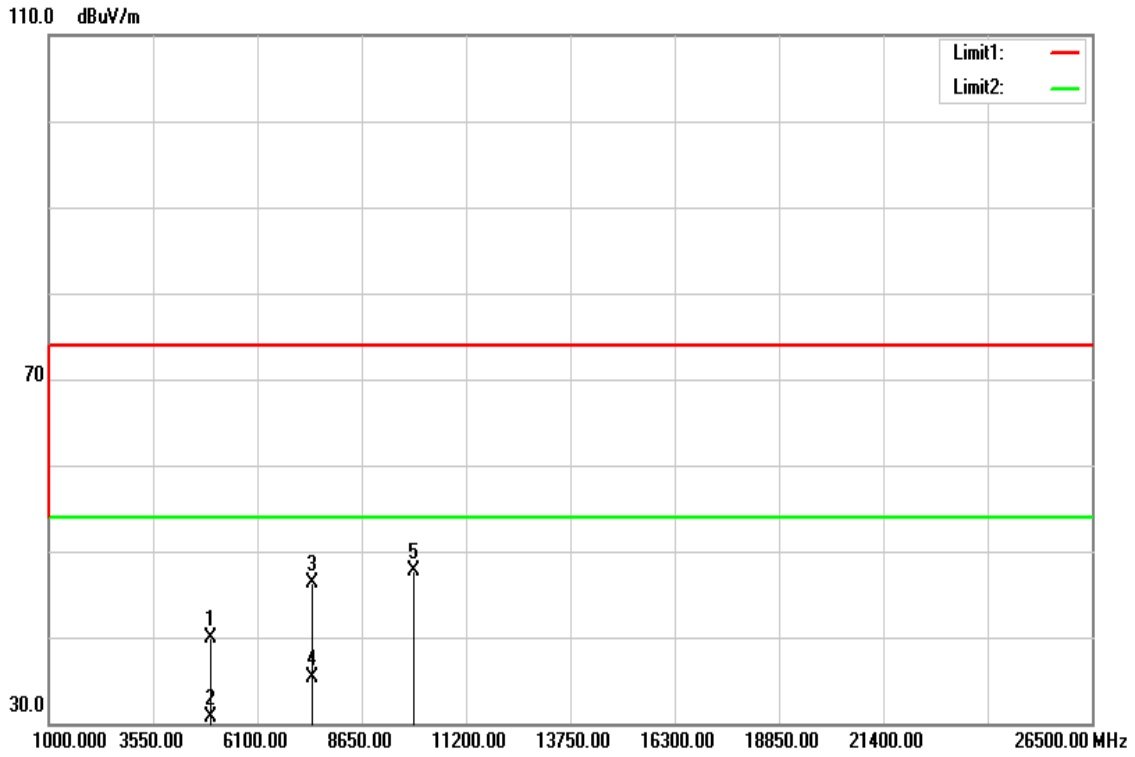

**Polarity: Horizontal**

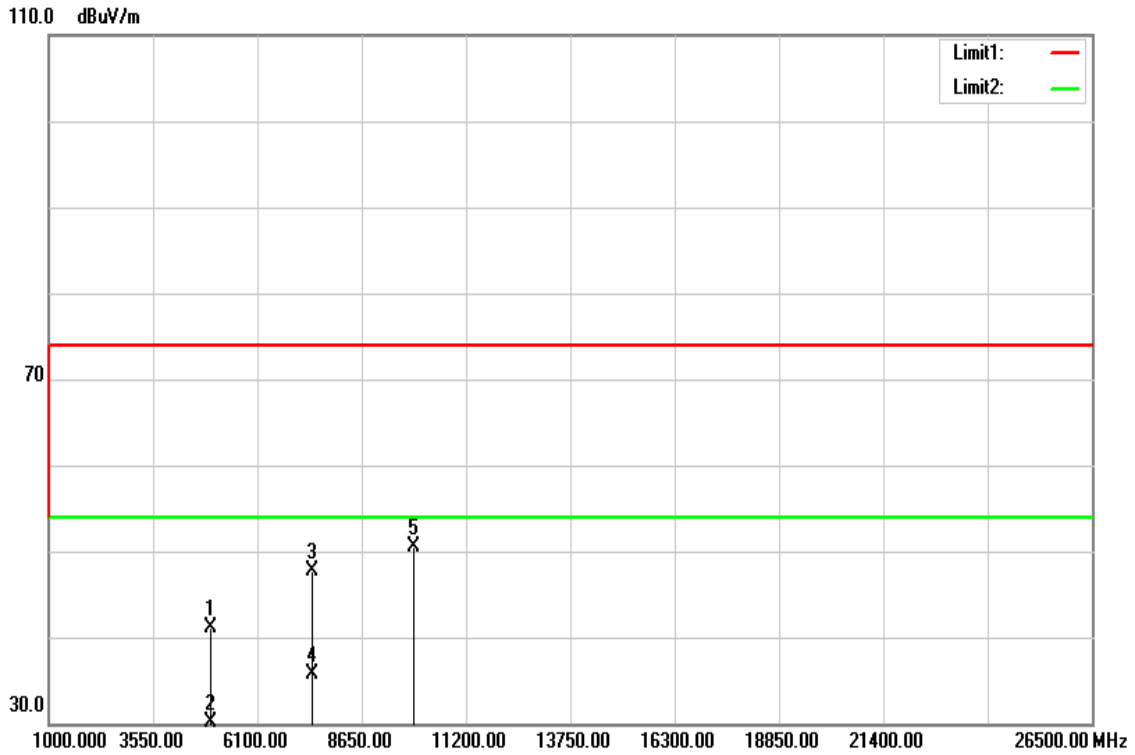

**Operation Mode:** TX / 8DPSK / DH5 / CH High      **Test Date:** June 1, 2016  
**Temperature:** 26°C      **Tested by:** Dennis Li  
**Humidity:** 50 % RH      **Polarity:** Ver. / Hor.

Frequency (MHz)	Reading (dBuV)	Correction (dB/m)	Result (dBuV/m)	Limit (dBuV/m)	Margin (dB)	Remark	Ant.Pol. (H/V)
4960.000	34.52	5.46	39.98	74.00	-34.02	peak	V
4960.000	25.28	5.46	30.74	54.00	-23.26	AVG	V
7440.000	33.02	13.33	46.35	74.00	-27.65	peak	V
7440.000	22.06	13.33	35.39	54.00	-18.61	AVG	V
9920.000	30.20	17.60	47.80	74.00	-26.20	peak	V
N/A							
4960.000	35.63	5.46	41.09	74.00	-32.91	peak	H
4960.000	24.74	5.46	30.20	54.00	-23.80	AVG	H
7440.000	34.41	13.33	47.74	74.00	-26.26	peak	H
7440.000	22.32	13.33	35.65	54.00	-18.35	AVG	H
9920.000	32.91	17.60	50.51	74.00	-23.49	peak	H
N/A							

**Remark:**

1. *Measuring frequencies from 1 GHz to the 10th harmonic of highest fundamental frequency.*
2. *Radiated emissions measured in frequency above 1000MHz were made with an instrument using peak/average detector mode.*
3. *Average test would be performed if the peak result were greater than the average limit.*
4. *Data of measurement within this frequency range shown “ --- ” in the table above means the reading of emissions are attenuated more than 20dB below the permissible limits or the field strength is too small to be measured.*
5. *Measurements above show only up to 6 maximum emissions noted, or would be lesser, with “ N/A ” remark, if no specific emissions from the EUT are recorded (ie: margin>20dB from the applicable limit) and considered that's already beyond the background noise floor.*
6. *Margin (dB) = Remark result (dBuV/m) – Average limit (dBuV/m).*

## 7.10 POWERLINE CONDUCTED EMISSIONS

### LIMIT

According to §15.207(a) & RSS-Gen §7.2.4, except as shown in paragraphs (b) and (c) of this section, for an intentional radiator that is designed to be connected to the public utility (AC) power line, the radio frequency voltage that is conducted back onto the AC power line on any frequency or frequencies within the band 150 kHz to 30 MHz shall not exceed the limits in the following table, as measured using a 50  $\mu$ H/50 ohms line impedance stabilization network (LISN). Compliance with the provisions of this paragraph shall be based on the measurement of the radio frequency voltage between each power line and ground at the power terminal. The lower limit applies at the boundary between the frequency ranges.

Frequency Range (MHz)	Limits (dB $\mu$ V)	
	Quasi-peak	Average
0.15 to 0.50	66 to 56*	56 to 46*
0.50 to 5	56	46
5 to 30	60	50

\* Decreases with the logarithm of the frequency.

### Test Configuration

See test photographs attached in Appendix II for the actual connections between EUT and support equipment.

### TEST PROCEDURE

1. The EUT was placed on a table, which is 0.8m above ground plane.
2. Maximum procedure was performed on the six highest emissions to ensure EUT compliance.
3. Repeat above procedures until all frequency measured were complete.



**TEST RESULTS**

The initial step in collecting conducted data is a spectrum analyzer peak scan of the measurement range. Significant peaks are then marked as shown on the following data page, and these signals are then quasi-peaked.

**Test Data**

**Operation Mode:** Normal Link                      **Test Date:** June 2, 2016  
**Temperature:** 24°C                                      **Tested by:** Dennis Li  
**Humidity:** 50% RH

Freq. (MHz)	QP Reading (dBuV)	AV Reading (dBuV)	Corr. factor (dB/m)	QP Result (dBuV/m)	AV Result (dBuV/m)	QP Limit (dBuV)	AV Limit (dBuV)	QP Margin (dB)	AV Margin (dB)	Note
0.1539	39.96	27.77	9.81	49.77	37.58	65.78	55.79	-16.01	-18.21	L1
0.1780	39.87	26.78	9.82	49.69	36.60	64.57	54.58	-14.88	-17.98	L1
0.1860	40.78	28.17	9.82	50.60	37.99	64.21	54.21	-13.61	-16.22	L1
0.2060	36.88	24.11	9.83	46.71	33.94	63.36	53.37	-16.65	-19.43	L1
0.2940	29.82	19.59	9.82	39.64	29.41	60.41	50.41	-20.77	-21.00	L1
0.3780	26.44	15.54	9.81	36.25	25.35	58.32	48.32	-22.07	-22.97	L1
0.5460	22.82	11.76	9.81	32.63	21.57	56.00	46.00	-23.37	-24.43	L1
14.3220	25.29	16.49	10.25	35.54	26.74	60.00	50.00	-24.46	-23.26	L1
0.1700	44.26	31.49	9.89	54.15	41.38	64.96	54.96	-10.81	-13.58	L2
0.1980	43.34	29.91	9.90	53.24	39.81	63.69	53.69	-10.45	-13.88	L2
0.2220	38.31	24.96	9.90	48.21	34.86	62.74	52.74	-14.53	-17.88	L2
0.2580	35.65	22.41	9.89	45.54	32.30	61.50	51.50	-15.96	-19.20	L2
0.4780	29.09	16.17	9.87	38.96	26.04	56.37	46.37	-17.41	-20.33	L2
0.5940	26.78	11.67	9.87	36.65	21.54	56.00	46.00	-19.35	-24.46	L2
14.8260	22.76	15.64	10.57	33.33	26.21	60.00	50.00	-26.67	-23.79	L2

**Remark:**

1. Measuring frequencies from 0.15 MHz to 30MHz.
2. The emissions measured in frequency range from 0.15 MHz to 30MHz were made with an instrument using Quasi-peak detector and average detector.
3. The IF bandwidth of SPA between 0.15MHz to 30MHz was 10kHz; the IF bandwidth of Test Receiver between 0.15MHz to 30MHz was 9kHz;
4. L1 = Line One (Live Line) / L2 = Line Two (Neutral Line)

### Test Plots

#### Conducted emissions (Line 1)

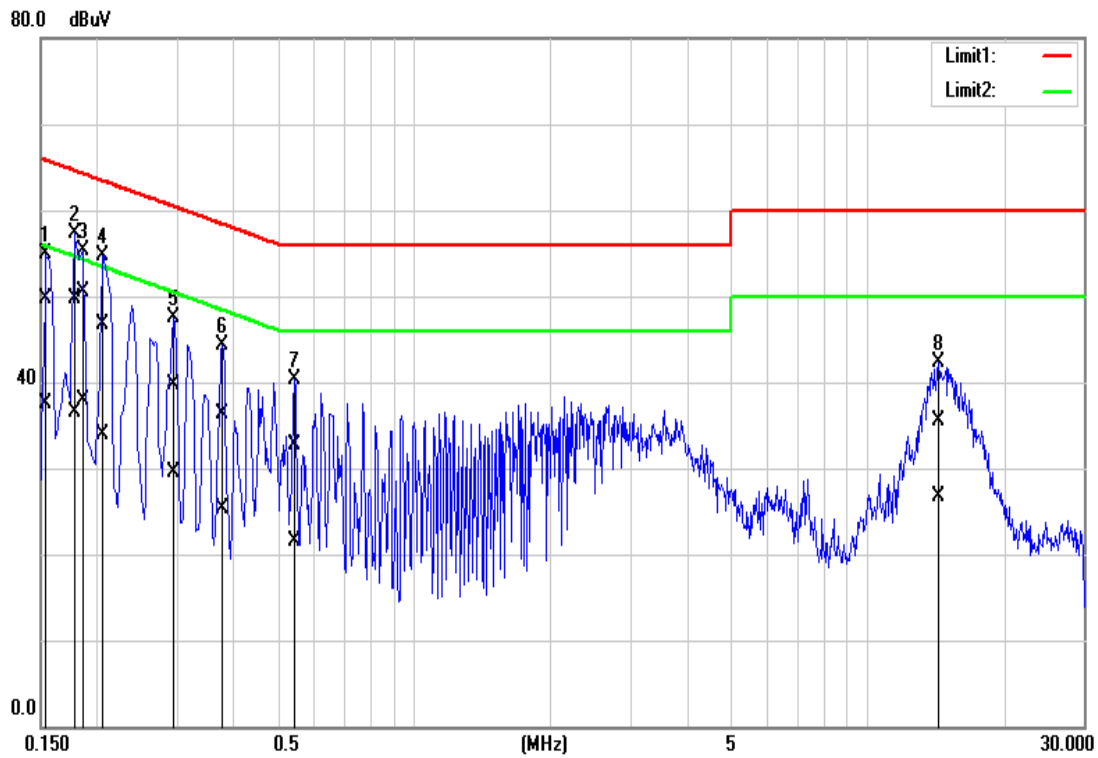

#### Conducted emissions (Line 2)

