

**FCC 47 CFR PART 15 SUBPART C &
INDUSTRY CANADA RSS-247**

TEST REPORT

For

Tablet Computer

Model: A6003

Trade Name: acer

Issued to

**Acer Incorporated
8F, 88, Sec 1, Xintai 5th Rd. Xizhi, New Taipei City 221 Taiwan, R.O.C**

Issued by

**Compliance Certification Services Inc.
No.11, Wugong 6th Rd., Wugu Dist.,
New Taipei City 24891, Taiwan. (R.O.C.)
<http://www.ccsrf.com>
service@ccsrf.com
Issued Date: June 2, 2016**



Testing Laboratory
1309

Note: This report shall not be reproduced except in full, without the written approval of Compliance Certification Services Inc. This document may be altered or revised by Compliance Certification Services Inc. personnel only, and shall be noted in the revision section of the document.

Revision History

Rev.	Issue Date	Revisions	Effect Page	Revised By
00	June 2, 2016	Initial Issue	ALL	Kelly Cheng

TABLE OF CONTENTS

1. TEST RESULT CERTIFICATION.....	4
2. EUT DESCRIPTION.....	5
3. TEST METHODOLOGY.....	7
3.1 EUT CONFIGURATION	7
3.2 EUT EXERCISE	7
3.3 GENERAL TEST PROCEDURES	7
3.4 FCC PART 15.205 RESTRICTED BANDS OF OPERATIONS.....	8
3.5 DESCRIPTION OF TEST MODES	9
4. INSTRUMENT CALIBRATION.....	10
4.1 MEASURING INSTRUMENT CALIBRATION	10
4.2 MEASUREMENT EQUIPMENT USED	10
4.3 MEASUREMENT UNCERTAINTY	11
5. FACILITIES AND ACCREDITATIONS.....	12
5.1 FACILITIES.....	12
5.2 EQUIPMENT	12
5.3 LABORATORY ACCREDITATIONS AND LISTING	12
5.4 TABLE OF ACCREDITATIONS AND LISTINGS.....	13
6. SETUP OF EQUIPMENT UNDER TEST.....	14
6.1 SETUP CONFIGURATION OF EUT	14
6.2 SUPPORT EQUIPMENT	14
7. FCC PART 15.247 REQUIREMENTS & RSS-247 REQUIREMENTS	15
7.1 99% BANDWIDTH.....	15
7.2 6DB BANDWIDTH.....	25
7.3 PEAK POWER	35
7.4 AVERAGE POWER.....	37
7.5 BAND EDGES MEASUREMENT	39
7.6 PEAK POWER SPECTRAL DENSITY.....	73
7.7 RADIATED EMISSIONS.....	83
7.8 POWERLINE CONDUCTED EMISSIONS.....	113
APPENDIX II PHOTOGRAPHS OF TEST SETUP	116

1. TEST RESULT CERTIFICATION

Applicant: Acer Incorporated
 8F, 88, Sec 1, Xintai 5th Rd. Xizhi, New Taipei City 221
 Taiwan, R.O.C

Manufacturer: Acer Incorporated
 8F, 88, Sec 1, Xintai 5th Rd. Xizhi, New Taipei City 221
 Taiwan, R.O.C

Equipment Under Test: Tablet Computer

Model Number: A6003

Trade Name: acer

Date of Test: May 31 ~ June 2, 2016

APPLICABLE STANDARDS	
STANDARD	TEST RESULT
FCC 47 CFR Part 15 Subpart C Industry Canada RSS-247 Issue 1	No non-compliance noted

We hereby certify that:

The above equipment was tested by Compliance Certification Services Inc. The test data, data evaluation, test procedures, and equipment configurations shown in this report were made in accordance with the procedures given in ANSI C63.10: 2013 and the energy emitted by the sample EUT tested as described in this report is in compliance with the requirements of FCC Rules Part 15.207, 15.209, 15.247 and Industry Canada RSS-247.

The test results of this report relate only to the tested sample EUT identified in this report.

Approved by:

Tested by:



Miller Lee
 Manager
 Compliance Certification Services Inc.

Dennis Li
 Engineer
 Compliance Certification Services Inc.

2. EUT DESCRIPTION

Product	Tablet Computer			
Model Number	A6003			
Trade Name	acer			
Model Discrepancy	N/A			
Received Date	May 13, 2016			
Power supply	1.VDC from Power Adapter 2. Power from Battery 3. Powered from host device via USB			
Frequency Range	2412 ~ 2462 MHz			
Transmit Power	Mode	Frequency Range	Output Power (dBm)	Output Power (W)
	IEEE 802.11b	2412 - 2462	18.26	0.0670
	IEEE 802.11g	2412 - 2462	21.12	0.1294
	IEEE 802.11n HT 20 MHz	2412 - 2462	20.50	0.1122
	IEEE 802.11n HT 40 MHz	2422 - 2452	20.63	0.1156
Number of Channels	IEEE 802.11b/g mode: 11 Channels IEEE 802.11n HT 20 MHz mode: 11 Channels IEEE 802.11n HT 40 MHz mode: 7 Channels			
Antenna Specification	Model: A10L FPC Antenna / Gain: 2.66dBi			

Remark:

1. The sample selected for test was engineering sample that approximated to production product and was provided by manufacturer.
2. This submittal(s) (test report) is intended for FCC ID: **HLZA6003** & ISED No. : **1754F-A6003** filing to comply with FCC Part 15C, Section 15.207, 15.209 and IC RSS-247 & RSS-GEN.

3. Keypart List :

Components	Vendor	Model Name or Key Spec.
EMMC(FLASH)	Hynix	H26M52103FMR (16GB)
CPU	MTK	MT8163V/B (64-bit Quad Cortex A53)
DDR3L	Hynix	H5TC4G63AFR-PBA (1GB / 256*16)
M/B	Sun & lynn	A10L_V1.1 (94V-0)
10.1" LCD Panel	Kingdisplay	KD101N37-40NA-A10
Battery	TCL	PR-279594N (1ICP3/95/94-2) 3.7V, 6100mAh / 22.57Wh
Front Camera module	microkore	W05P4021 V2 (GC2355)
Rear Camera module	microkore	W05P4021 V2 (OV5670)
Speaker left	Haosheng	XHB160903B08-08-B-RH (8Ω)
Speaker right	Haosheng	XHB160903B08-07-B-RH (8Ω)
Adapter	Delta	ADP-10HW A I/P: 100-240Vac~, 0.4A, 50-60Hz O/P: 5.35Vdc, 2.0A
	Lite-On	PA-1100-25 I/P: 100-240Vac~, 0.3A, 50/60Hz O/P: 5.2Vdc, 2.0A
RF Module	MTK	MT6625LN/BT, WIFI

3. TEST METHODOLOGY

The tests documented in this report were performed in accordance with ANSI C63.10: 2013 and FCC CFR 47 Part 15.207, 15.209, 15.247, KDB 558074 D01 DTS Meas Guidance v03r05

The tests documented in this report were performed in accordance with IC RSS-247, IC RSS-Gen and ANSI C63.10:2013.

This submittal(s) (test report) is intended for IC Certification with Industry Canada RSS-247.

3.1 EUT CONFIGURATION

The EUT configuration for testing is installed on RF field strength measurement to meet the Commissions requirement and operating in a manner that intends to maximize its emission characteristics in a continuous normal application.

3.2 EUT EXERCISE

The EUT was operated in the engineering mode to fix the TX frequency that was for the purpose of the measurements.

According to its specifications, the EUT must comply with the requirements of the Section 15.207, 15.209 and 15.247 under the FCC Rules Part 15 Subpart C.

The tests documented in this report were performed in accordance with IC RSS-247, IC RSS-Gen, IC RSS-102, and ANSI C63.10: 2013.

3.3 GENERAL TEST PROCEDURES

Conducted Emissions

According to the requirements in ANSI C63.10: 2013 Conducted emissions from the EUT measured in the frequency range between 0.15 MHz and 30MHz using CISPR Quasi-peak and average detector modes.

Radiated Emissions

The EUT is placed on a turn table, which is 1.5 m above ground plane. The turntable shall rotate 360 degrees to determine the position of maximum emission level. EUT is set 3m away from the receiving antenna, which varied from 1m to 4m to find out the highest emission. And also, each emission was to be maximized by changing the polarization of receiving antenna both horizontal and vertical. In order to find out the maximum emissions, exploratory radiated emission measurements were made according to the requirements in ANSI C63.10: 2013.

3.4 FCC PART 15.205 RESTRICTED BANDS OF OPERATIONS

(a) Except as shown in paragraph (d) of this section, only spurious emissions are permitted in any of the frequency bands listed below:

MHz	MHz	MHz	GHz
0.090 - 0.110	16.42 - 16.423	399.9 - 410	4.5 - 5.15
¹ 0.495 - 0.505	16.69475 - 16.69525	608 - 614	5.35 - 5.46
2.1735 - 2.1905	16.80425 - 16.80475	960 - 1240	7.25 - 7.75
4.125 - 4.128	25.5 - 25.67	1300 - 1427	8.025 - 8.5
4.17725 - 4.17775	37.5 - 38.25	1435 - 1626.5	9.0 - 9.2
4.20725 - 4.20775	73 - 74.6	1645.5 - 1646.5	9.3 - 9.5
6.215 - 6.218	74.8 - 75.2	1660 - 1710	10.6 - 12.7
6.26775 - 6.26825	108 - 121.94	1718.8 - 1722.2	13.25 - 13.4
6.31175 - 6.31225	123 - 138	2200 - 2300	14.47 - 14.5
8.291 - 8.294	149.9 - 150.05	2310 - 2390	15.35 - 16.2
8.362 - 8.366	156.52475 -	2483.5 - 2500	17.7 - 21.4
8.37625 - 8.38675	156.52525	2655 - 2900	22.01 - 23.12
8.41425 - 8.41475	156.7 - 156.9	3260 - 3267	23.6 - 24.0
12.29 - 12.293	162.0125 - 167.17	3332 - 3339	31.2 - 31.8
12.51975 - 12.52025	167.72 - 173.2	3345.8 - 3358	36.43 - 36.5
12.57675 - 12.57725	240 - 285	3600 - 4400	(²)
13.36 - 13.41	322 - 335.4		

¹ Until February 1, 1999, this restricted band shall be 0.490-0.510 MHz.

² Above 38.6

(b) Except as provided in paragraphs (d) and (e), the field strength of emissions appearing within these frequency bands shall not exceed the limits shown in Section 15.209. At frequencies equal to or less than 1000 MHz, compliance with the limits in Section 15.209 shall be demonstrated using measurement instrumentation employing a CISPR quasi-peak detector. Above 1000 MHz, compliance with the emission limits in Section 15.209 shall be demonstrated based on the average value of the measured emissions. The provisions in Section 15.35 apply to these measurements.

3.5 DESCRIPTION OF TEST MODES

The EUT (model: A6003) comes with two types of power adapter (model: PA-1100-25 / ADP-10HW A) for sale. After the preliminary test, the power adapter ADP-10HW A was found to emit the worst emissions and therefore had been tested under operating condition.

Software used to control the EUT for staying in continuous transmitting and receiving mode was programmed.

After verification, all tests carried out are with the worst-case test modes as shown below except radiated spurious emission below 1GHz and power line conducted emissions below 30MHz, which worst case was in normal link mode and receiving radiated spurious emission above 1GHz, which worst case was in CH Mid mode only.

IEEE 802.11b mode:

Channel Low (2412MHz), Channel Mid (2437MHz) and Channel High (2462MHz) with 1Mbps data rate were chosen for full testing.

IEEE 802.11g mode:

Channel Low (2412MHz), Channel Mid (2437MHz) and Channel High (2462MHz) with 6Mbps data rate were chosen for full testing.

IEEE 802.11n HT 20 MHz mode:

Channel Low (2412MHz), Channel Mid (2437MHz) and Channel High (2462MHz) with 6.5Mbps data rate were chosen for full testing.

IEEE 802.11n HT 40 MHz mode:

Channel Low (2422MHz), Channel Mid (2437MHz) and Channel High (2452MHz) with 13.5Mbps data rate were chosen for full testing.

The field strength of spurious emission was measured in the following position: EUT stand-up position (Z axis), lie-down position (X, Y axis). The worst emission was found in lie-down position (X axis) and the worst case was recorded.

4. INSTRUMENT CALIBRATION

4.1 MEASURING INSTRUMENT CALIBRATION

The measuring equipment, which was utilized in performing the tests documented herein, has been calibrated in accordance with the manufacturer's recommendations for utilizing calibration equipment, which is traceable to recognized national standards.

4.2 MEASUREMENT EQUIPMENT USED

Equipment Used for Emissions Measurement

Remark: Each piece of equipment is scheduled for calibration once a year and Loop Antenna is scheduled for calibration once three years.

Conducted Emissions Test Site					
Name of Equipment	Manufacturer	Model	Serial Number	Calibration Date	Calibration Due
DC Power Supplies	GW Instek	SPS-3610	GPE880163	01/19/2016	01/18/2017
Power Meter	Anritsu	ML2495A	1012009	07/08/2015	07/07/2016
Power Sensor	Anritsu	MA2411B	917072	07/08/2015	07/07/2016
Signal Analyzer	R&S	FSV 40	101073	07/20/2015	07/19/2016
Spectrum Analyzer	Agilent	E4446A	US42510268	02/15/2016	02/14/2017
Thermostatic/Hrgrosatic Chamber	TAICHY	MHG-150LF	930619	10/08/2015	10/07/2016
Vector Signal Generator	R&S	SMU 200A	102239	03/10/2016	03/09/2017
AC Power Source	EXTECH	6205	1140845	N.C.R	N.C.R

Wugu 966 Chamber A					
Name of Equipment	Manufacturer	Model	Serial Number	Calibration Date	Calibration Due
Bilog Antenna	Sunol Sciences	JB3	A030105	08/06/2015	08/05/2016
EMI Test Receiver	R&S	ESCI	100064	06/05/2015	06/04/2016
Horn Antenna	EMCO	3117	55165	02/24/2016	02/23/2017
Horn Antenna	EMCO	3116	26370	01/15/2016	01/14/2017
K Type Cable	Huber+Suhner	SUCOFLEX 102	29406/2	01/12/2016	01/11/2017
K Type Cable	Huber+Suhner	SUCOFLEX 102	22470/2	01/12/2016	01/11/2017
Pre-Amplifier	MITEQ	AMF-6F-260400-40-8P	985646	01/14/2016	01/13/2017
Pre-Amplifier	EMCI	EMC 012635	980151	06/05/2015	06/04/2016
Pre-Amplifier	EMCI	EM330	N/A	06/05/2015	06/04/2016
Spectrum Analyzer	Agilent	E4446A	US42510252	12/08/2015	12/07/2016
Antenna Tower	CCS	CC-A-1F	N/A	N.C.R	N.C.R
Controller	CCS	CC-C-1F	N/A	N.C.R	N.C.R
Turn Table	CCS	CC-T-1F	N/A	N.C.R	N.C.R
Software	EZ-EMC (CCS-3A1RE)				

Conducted Emission Room # B					
Name of Equipment	Manufacturer	Model	Serial Number	Calibration Date	Calibration Due
Capacitive Voltage Probe	FCC	F-CVP-1	100185	03/09/2016	03/08/2017
EMI Test Receiver	R&S	ESCI	101073	09/09/2015	09/08/2016
LISN	SCHWARZBECK	NSLK 8127	8127-541	11/23/2015	11/22/2016
LISN	R&S	ENV216	101054	05/11/2016	05/10/2017
Test S/W	CCS-3A1-CE				

4.3 MEASUREMENT UNCERTAINTY

PARAMETER	UNCERTAINTY
Powerline Conducted Emission	+/- 1.2575
3M Semi Anechoic Chamber / 30M~200M	+/- 4.0138
3M Semi Anechoic Chamber / 200M~1000M	+/- 3.9483
3M Semi Anechoic Chamber / 1G~8G	+/- 2.5975
3M Semi Anechoic Chamber / 8G~18G	+/- 2.6112
3M Semi Anechoic Chamber / 18G~26G	+/- 2.7389
3M Semi Anechoic Chamber / 26G~40G	+/- 2.9683

Remark: This uncertainty represents an expanded uncertainty expressed at approximately the 95% confidence level using a coverage factor of $k=2$.

5. FACILITIES AND ACCREDITATIONS

5.1 FACILITIES

All measurement facilities used to collect the measurement data are located at

- No.199, Chungsen Road, Hsintien City, Taipei Hsien, Taiwan, R.O.C.
Tel: 886-2-2217-0894 / Fax: 886-2-2217-1029
- No.11, Wugong 6th Rd., Wugu Dist., New Taipei City 24891, Taiwan. (R.O.C.)
Tel: 886-2-2299-9720 / Fax: 886-2-2298-4045
- No.81-1, Lane 210, Bade 2nd Rd., Lujhu Township, Taoyuan County 33841, TAIWAN, R.O.C.
Tel: 886-3-324-0332 / Fax: 886-3-324-5235

The sites are constructed in conformance with the requirements of ANSI C63.7, ANSI C63.10: 2013 and CISPR Publication 22.

5.2 EQUIPMENT

Radiated emissions are measured with one or more of the following types of linearly polarized antennas: tuned dipole, biconical, log periodic, bi-log, ridged waveguide, horn and/or Loop. Spectrum analyzers with pre-selectors and quasi-peak detectors are used to perform radiated measurements.

Conducted emissions are measured with Line Impedance Stabilization Networks and EMI Test Receivers.



Calibrated wideband preamplifiers, coaxial cables, and coaxial attenuators are also used for making measurements.

All receiving equipment conforms to CISPR Publication 16-1, "Radio Interference Measuring Apparatus and Measurement Methods."

5.3 LABORATORY ACCREDITATIONS AND LISTING

The test facilities used to perform radiated and conducted emissions tests are accredited by American Association for Laboratory Accreditation Program for the specific scope accreditation under Lab Code: 0824-01 to perform Electromagnetic Interference tests according to FCC Part 15 and CISPR 22 requirements. In addition, the test facilities are listed with Industry Canada, Certification and Engineering Bureau, IC 2324G-1 for 3M Semi Anechoic Chamber A, 2324G-2 for 3M Semi Anechoic Chamber B.

5.4 TABLE OF ACCREDITATIONS AND LISTINGS

Country	Agency	Scope of Accreditation	Logo
USA	FCC	3M Semi Anechoic Chamber (FCC MRA: TW1039) to perform FCC Part 15 measurements	 FCC MRA: TW1039
Taiwan	TAF	LP0002, RTTE01, FCC Method-47 CFR Part 15 Subpart C, D, E, RSS-210, RSS-310 IDA TS SRD, AS/NZS 4268, AS/NZS 4771, TS 12.1 & 12.2, ETSI EN 300 440-1, ETSI EN 300 440-2, ETSI EN 300 328, ETSI EN 300 220-1, ETSI EN 300 220-2, ETSI EN 301 893, ETSI EN 301 489-1/3/7/17 FCC OET Bulletin 65 + Supplement C, EN 50360, EN 50361, EN 50371, RSS 102, EN 50383, EN 50385, EN 50392, IEC 62209, CNS 14958-1, CNS 14959 FCC Method -47 CFR Part 15 Subpart B IEC / EN 61000-3-2, IEC / EN 61000-3-3, IEC / EN 61000-4-2/3/4/5/6/8/11	
Canada	Industry Canada	3M Semi Anechoic Chamber (IC 2324G-1 / IC 2324G-2) to perform	 IC 2324G-1 IC 2324G-2

* No part of this report may be used to claim or imply product endorsement by A2LA or any agency of the US Government.

6. SETUP OF EQUIPMENT UNDER TEST

6.1 SETUP CONFIGURATION OF EUT

See test photographs attached in Appendix II for the actual connections between EUT and support equipment.

6.2 SUPPORT EQUIPMENT

No	Equipment	Brand	Model	Series No.	FCC ID	Data Cable	Power Cord
	N/A						

Remark:

- 1. All the equipment/cables were placed in the worst-case configuration to maximize the emission during the test.*
- 2. Grounding was established in accordance with the manufacturer's requirements and conditions for the intended use.*

7. FCC PART 15.247 REQUIREMENTS & RSS-247 REQUIREMENTS

7.1 99% BANDWIDTH

Test Configuration

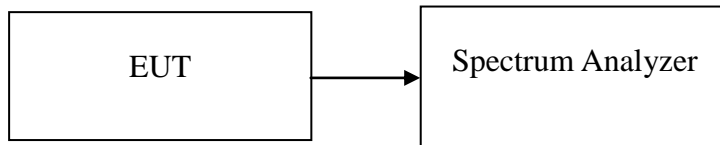

TEST PROCEDURE

The resolution bandwidth shall be set to as close to 1% of the selected span as is possible without being below 1%. The video bandwidth shall be set to 3 times the resolution bandwidth. Video averaging is not permitted. Where practical, a sampling detector shall be used since a peak or, peak hold.

Test Data**IEEE 802.11b mode**

Channel	Frequency (MHz)	99% Bandwidth (MHz)
Low	2412	13.0246
Mid	2437	12.4602
High	2462	12.5036

IEEE 802.11g mode

Channel	Frequency (MHz)	99% Bandwidth (MHz)
Low	2412	16.4544
Mid	2437	16.3675
High	2462	16.4109

IEEE 802.11n HT 20 MHz mode

Channel	Frequency (MHz)	99% Bandwidth (MHz)
Low	2412	17.6700
Mid	2437	17.5832
High	2462	17.6700

IEEE 802.11n HT 40 MHz mode

Channel	Frequency (MHz)	99% Bandwidth (MHz)
Low	2422	36.1215
Mid	2437	35.8900
High	2452	36.1215

Test Plot

**IEEE 802.11b mode
99% Bandwidth (CH Low)**

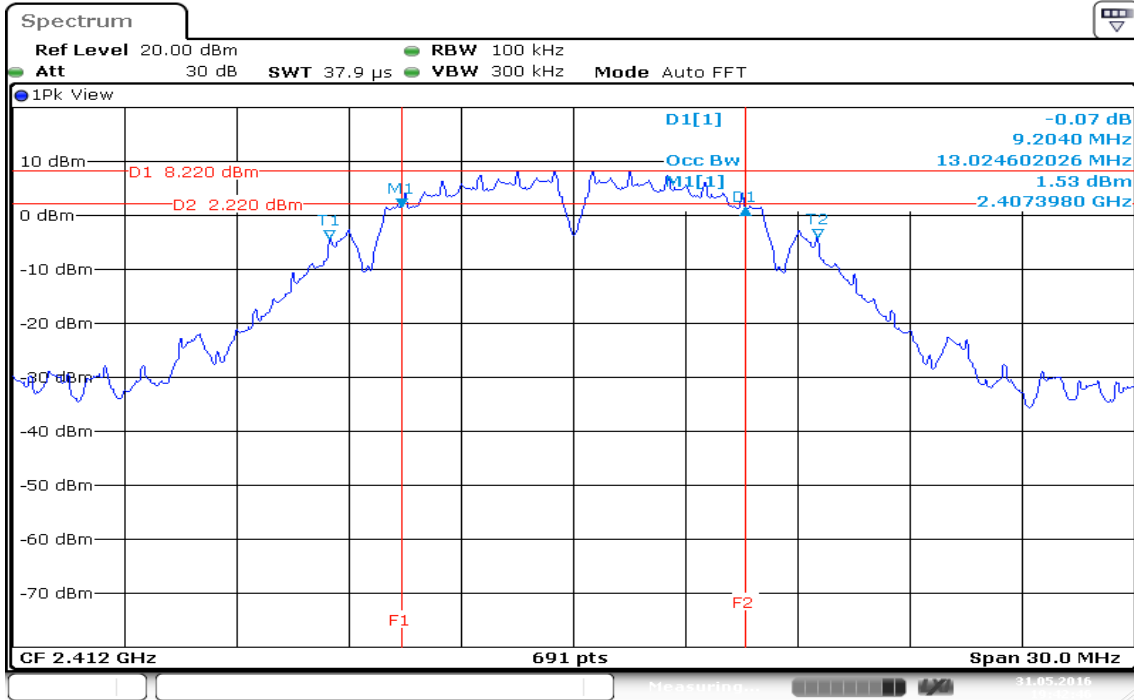

99% Bandwidth (CH Mid)

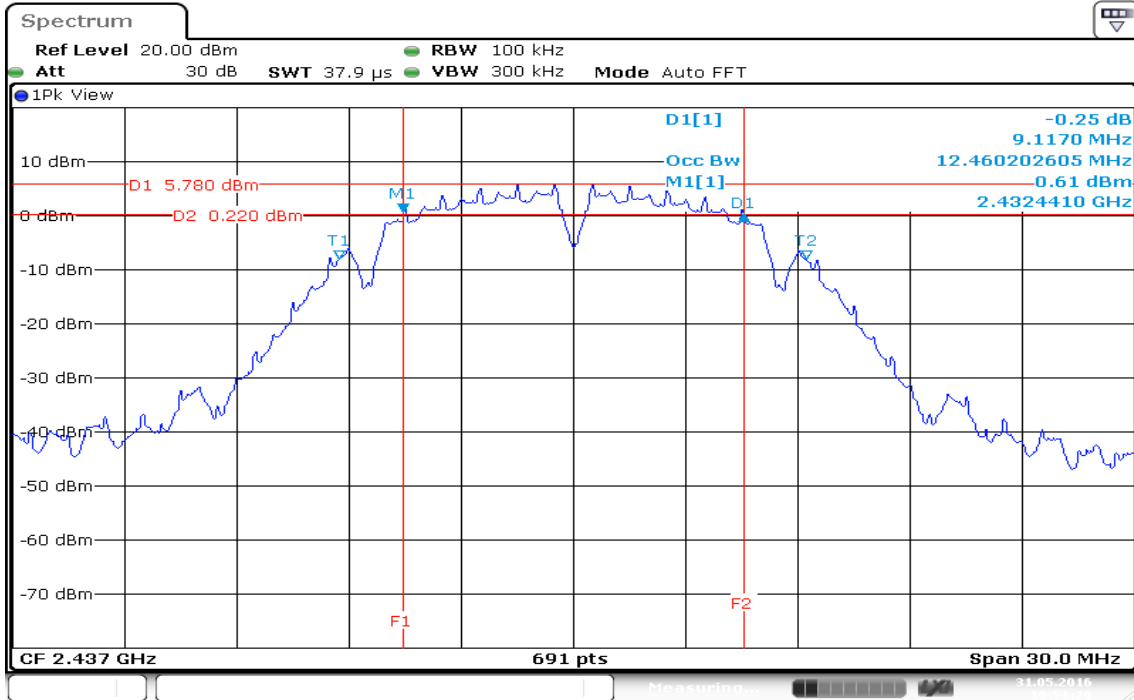

99% Bandwidth (CH High)

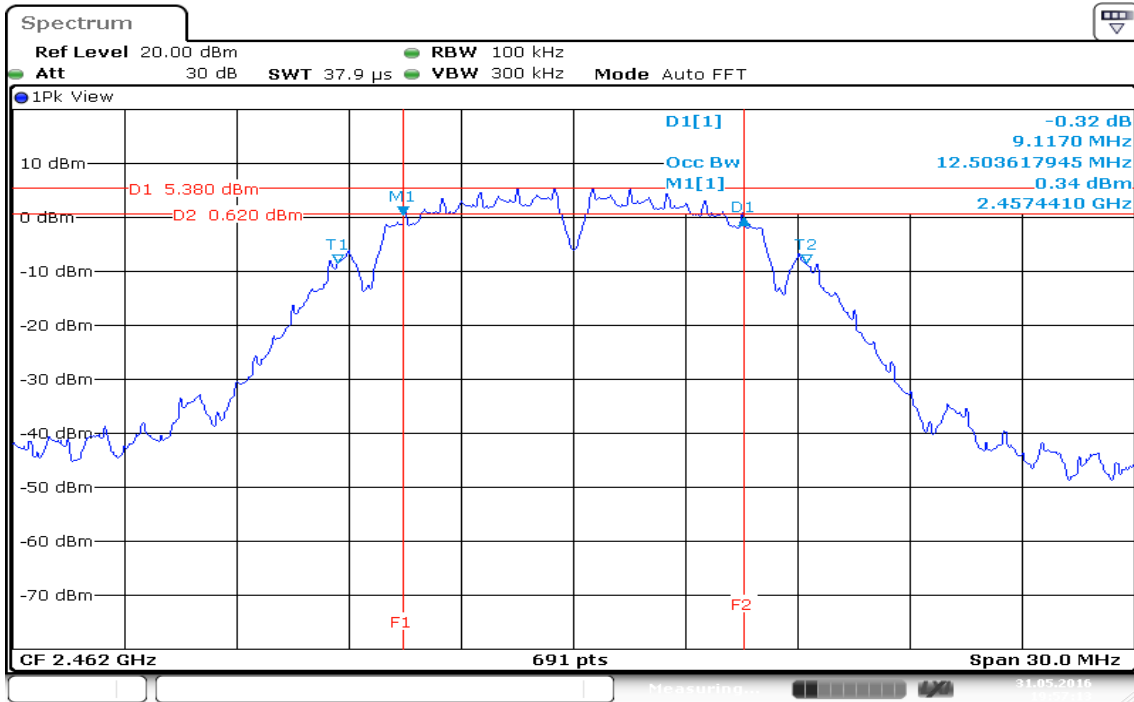

Date: 31.MAY.2016 19:57:14

**IEEE 802.11g mode
99% Bandwidth (CH Low)**

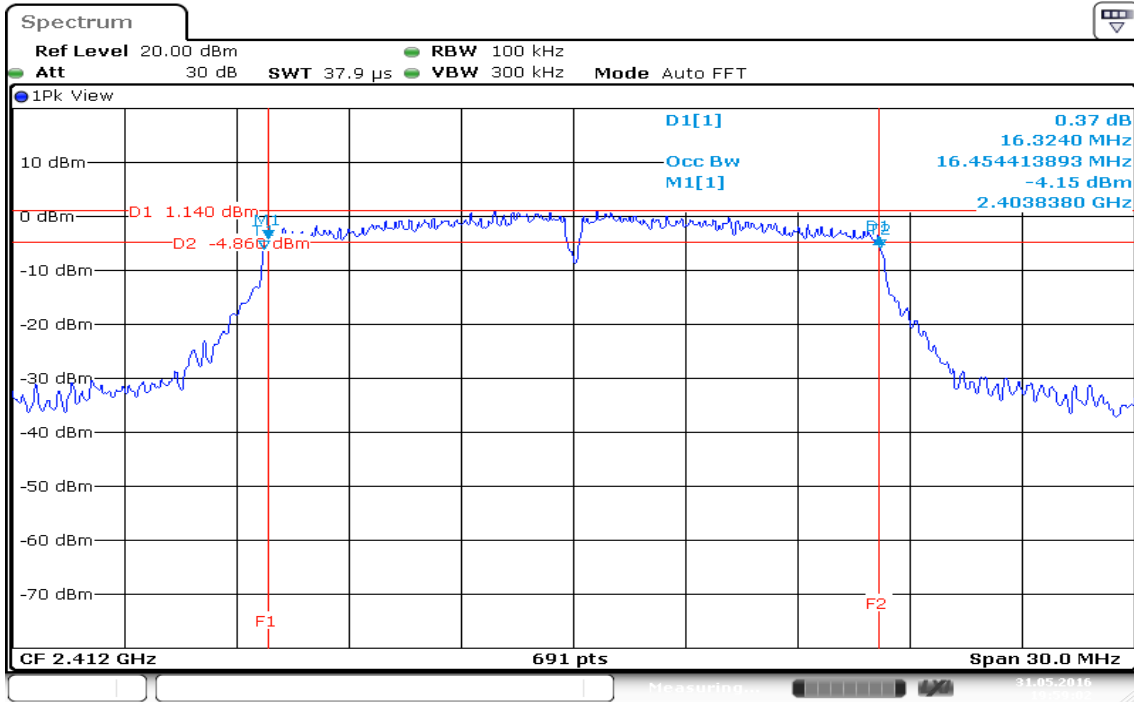

99% Bandwidth (CH Mid)

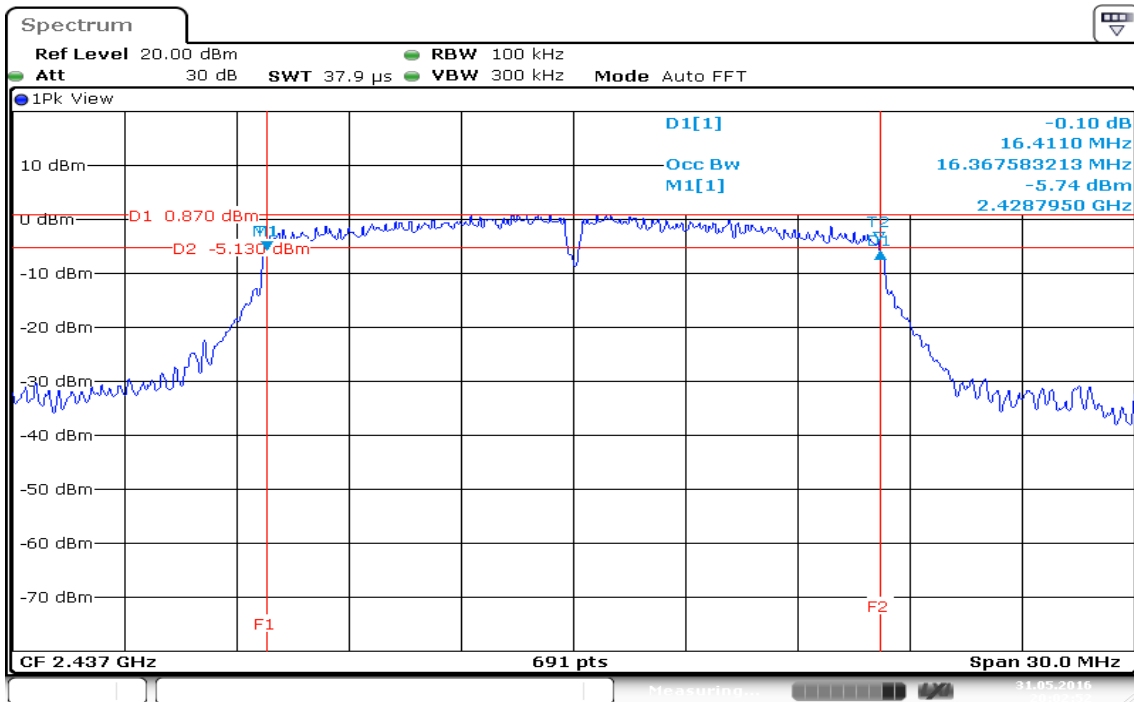

99% Bandwidth (CH High)

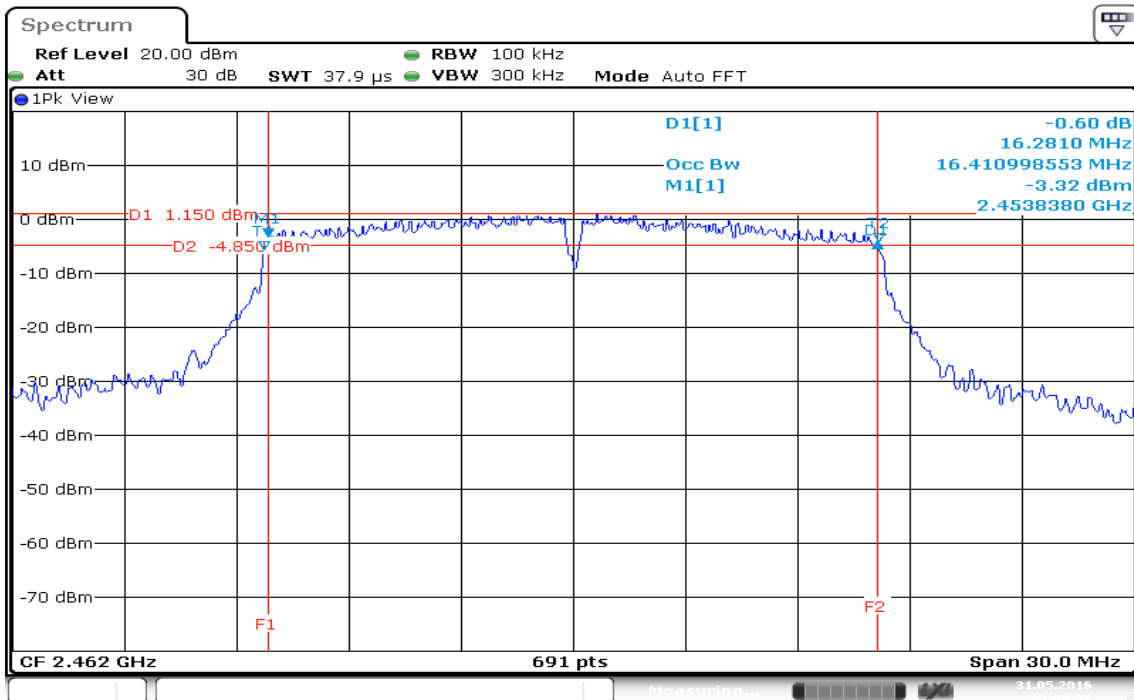

Date: 31.MAY.2016 20:04:31

IEEE 802.11n HT 20 MHz mode

99% Bandwidth (CH Low)

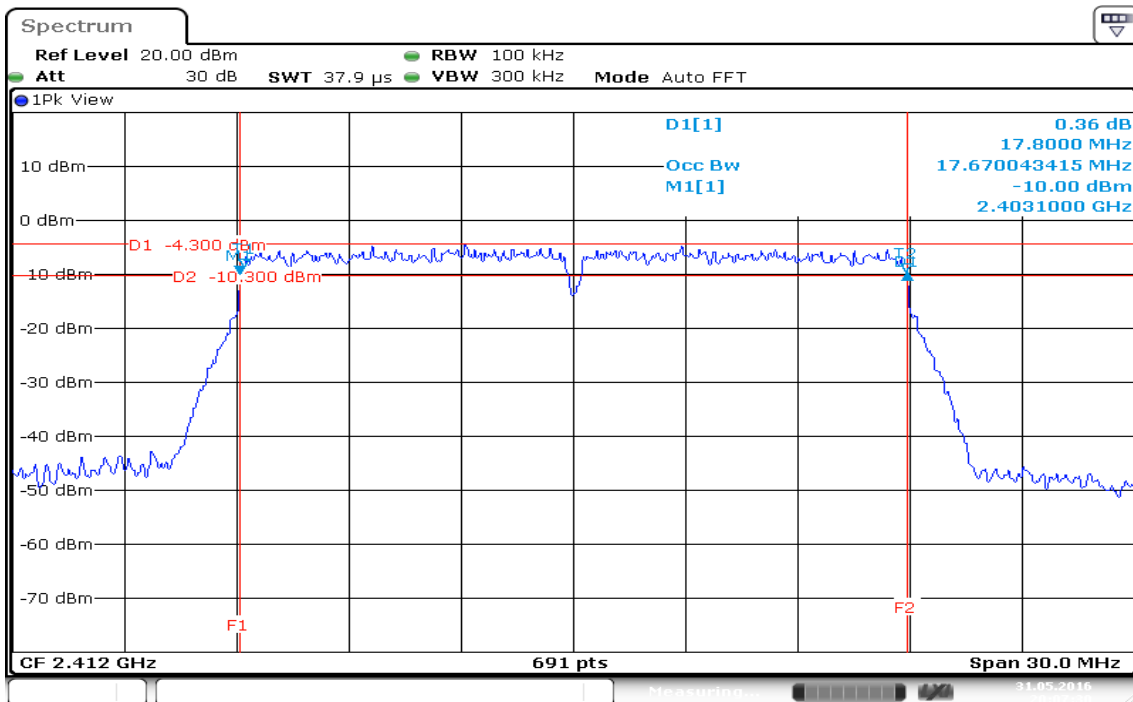

99% Bandwidth (CH Mid)

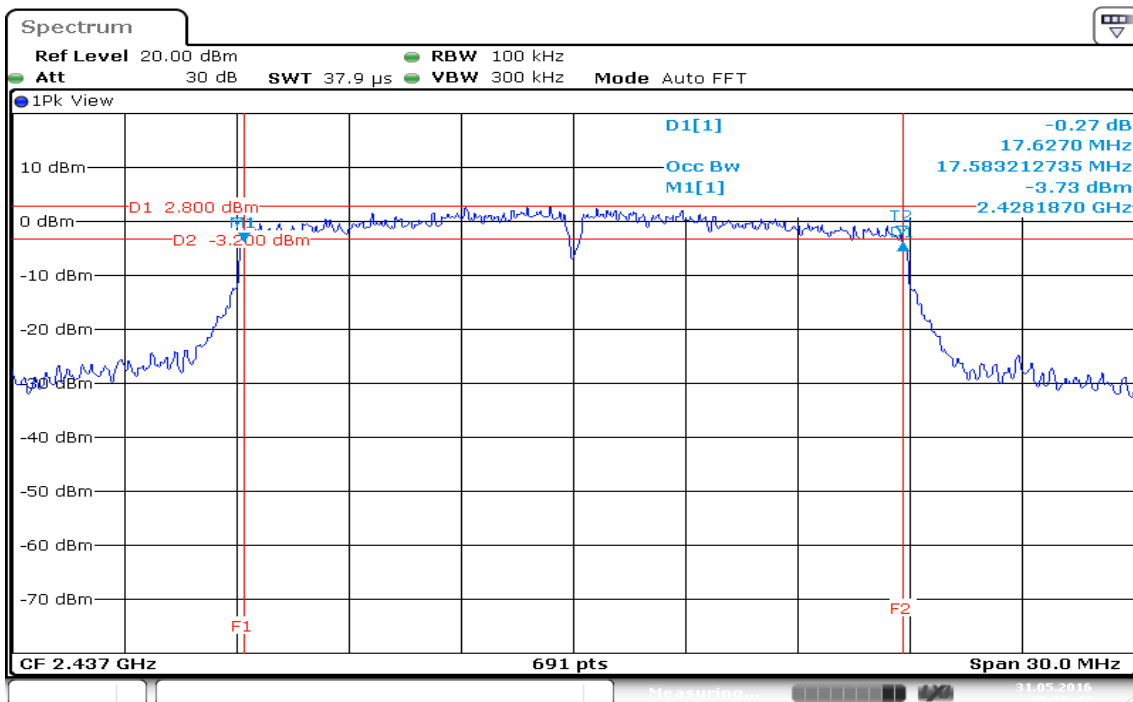

99% Bandwidth (CH High)

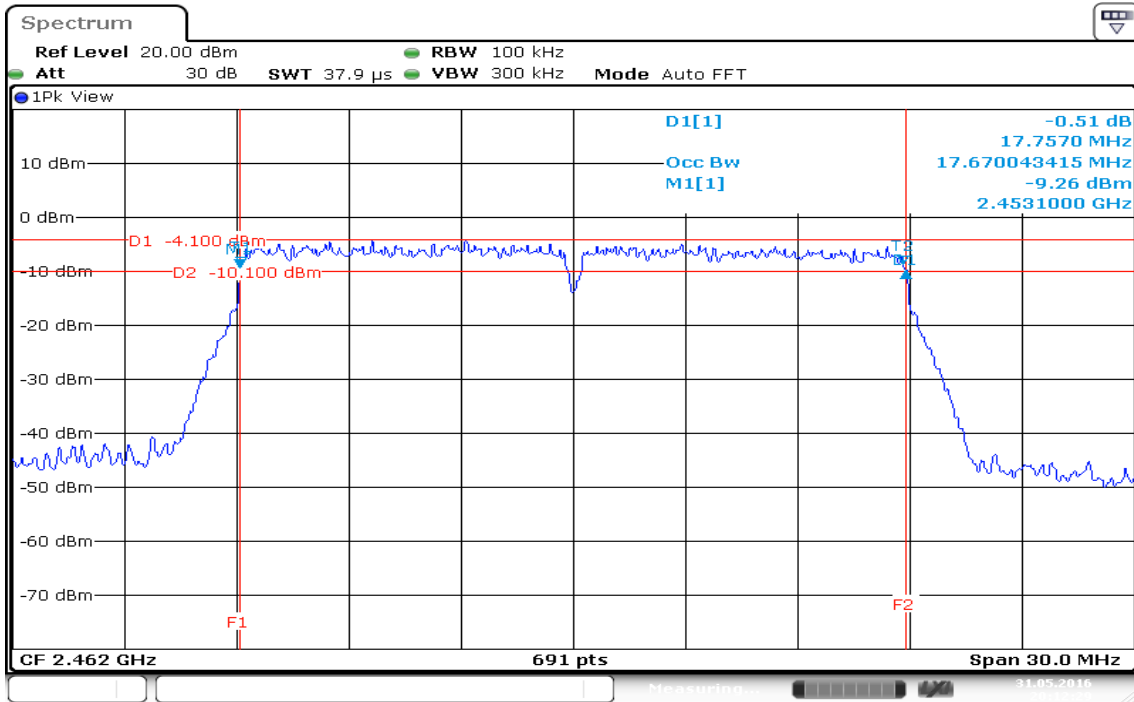

Date: 31.MAY.2016 20:12:29

IEEE 802.11n HT 40 MHz mode

99% Bandwidth (CH Low)

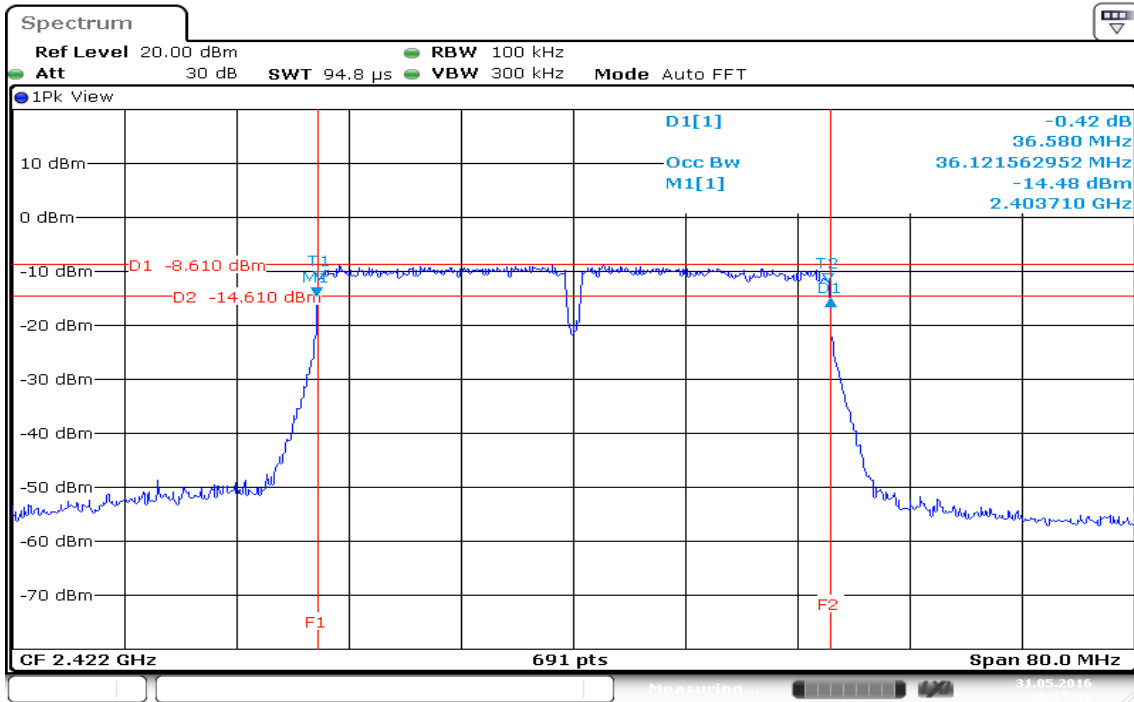

99% Bandwidth (CH Mid)

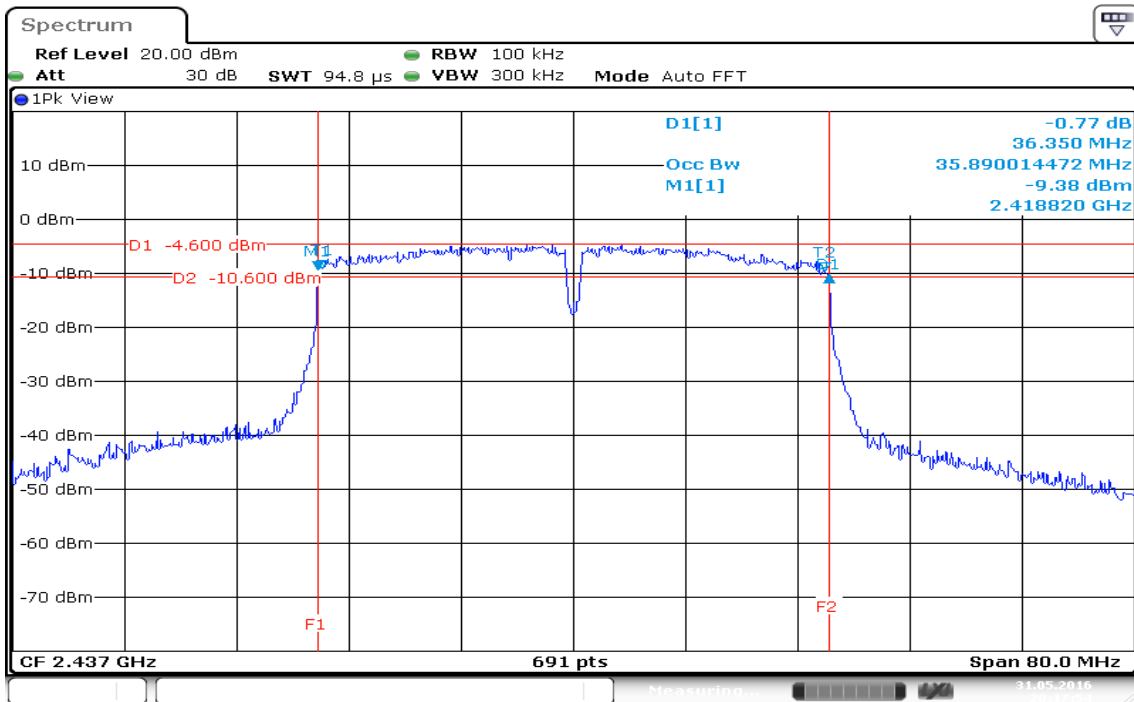

99% Bandwidth (CH High)

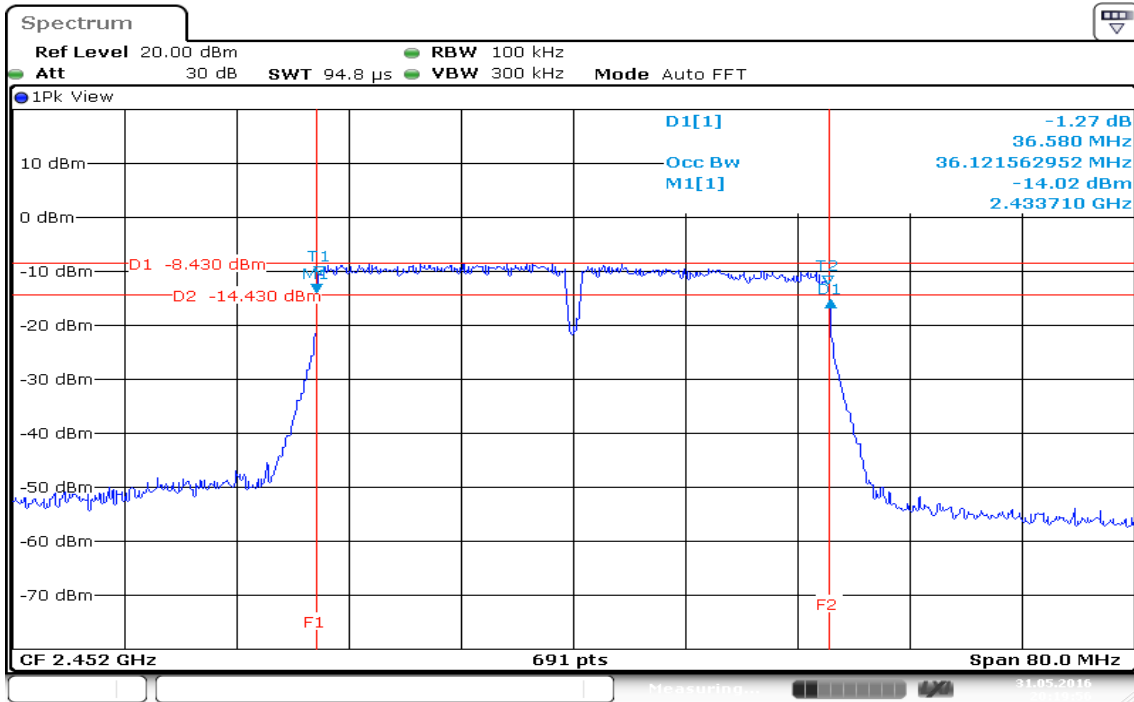

Date: 31.MAY.2016 20:19:57

7.2 6DB BANDWIDTH

LIMIT

According to §15.247(a)(2) & RSS-247, systems using digital modulation techniques may operate in the 902 - 928 MHz, 2400 - 2483.5 MHz, and 5725 - 5850 MHz bands. The minimum 6dB bandwidth shall be at least 500 kHz.

Test Configuration

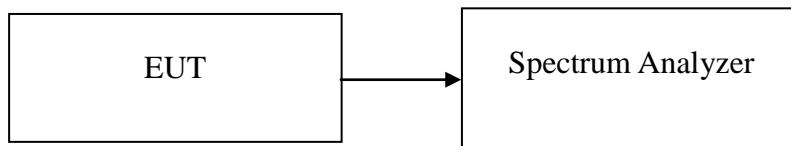

TEST PROCEDURE

1. Place the EUT on the table and set it in the transmitting mode.
2. Remove the antenna from the EUT and then connect a low loss RF cable from the antenna port to the spectrum analyzer.
3. Set the spectrum analyzer as RBW = 100 kHz, VBW= 300kHz, Span = 50 MHz, Sweep = auto.
4. Mark the peak frequency and –6dB (upper and lower) frequency.
5. Repeat until all the rest channels are investigated.

TEST RESULTS

No non-compliance noted

Test Data
IEEE 802.11b mode

Channel	Frequency (MHz)	6dB Bandwidth (MHz)	Limit (kHz)	Result
Low	2412	9.2040	>500	PASS
Mid	2437	9.1170		PASS
High	2462	9.1170		PASS

IEEE 802.11g mode

Channel	Frequency (MHz)	6dB Bandwidth (MHz)	Limit (kHz)	Result
Low	2412	16.3240	>500	PASS
Mid	2437	16.4110		PASS
High	2462	16.2810		PASS

IEEE 802.11n HT 20 MHz mode

Channel	Frequency (MHz)	6dB Bandwidth (MHz)	Limit (kHz)	Result
Low	2412	17.8000	>500	PASS
Mid	2437	17.6270		PASS
High	2462	17.7570		PASS

IEEE 802.11n HT 40 MHz mode

Channel	Frequency (MHz)	6dB Bandwidth (MHz)	Limit (kHz)	Result
Low	2422	36.580	>500	PASS
Mid	2437	36.350		PASS
High	2452	36.580		PASS

Test Plot

IEEE 802.11b mode

6dB Bandwidth (CH Low)

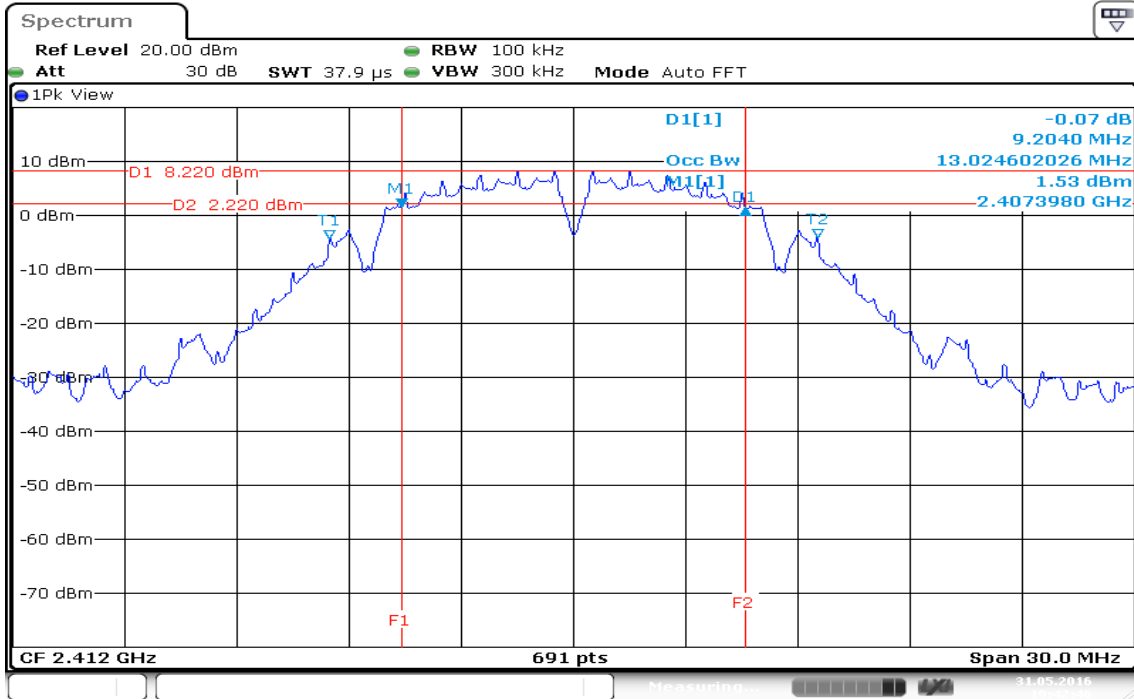

6dB Bandwidth (CH Mid)

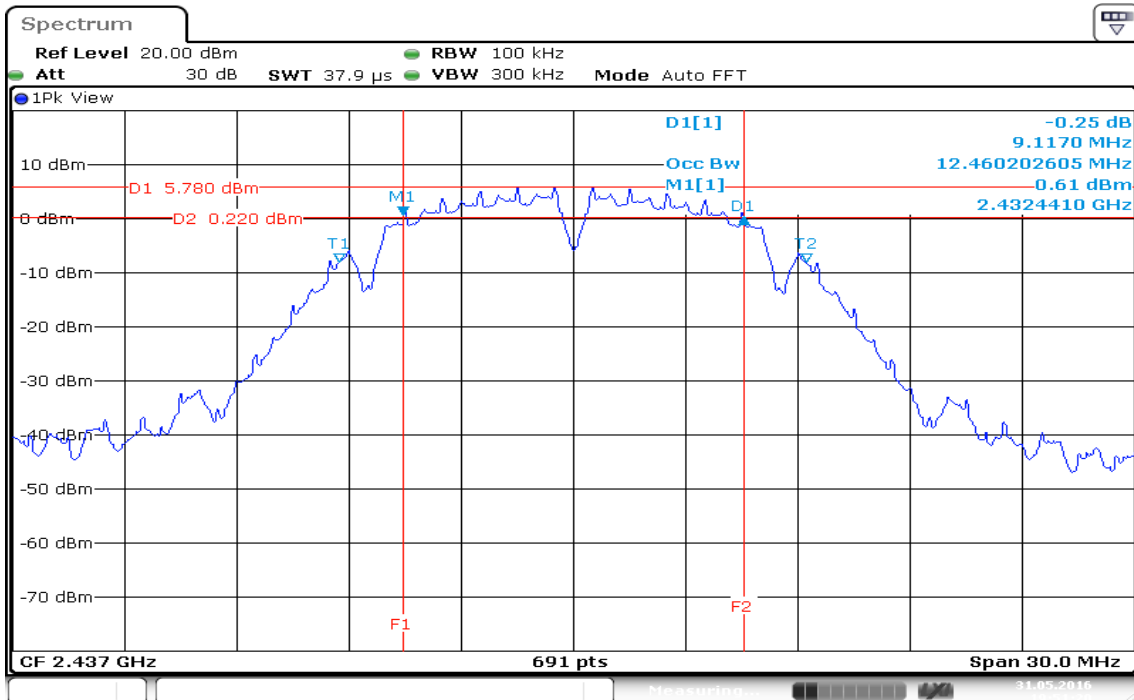

6dB Bandwidth (CH High)

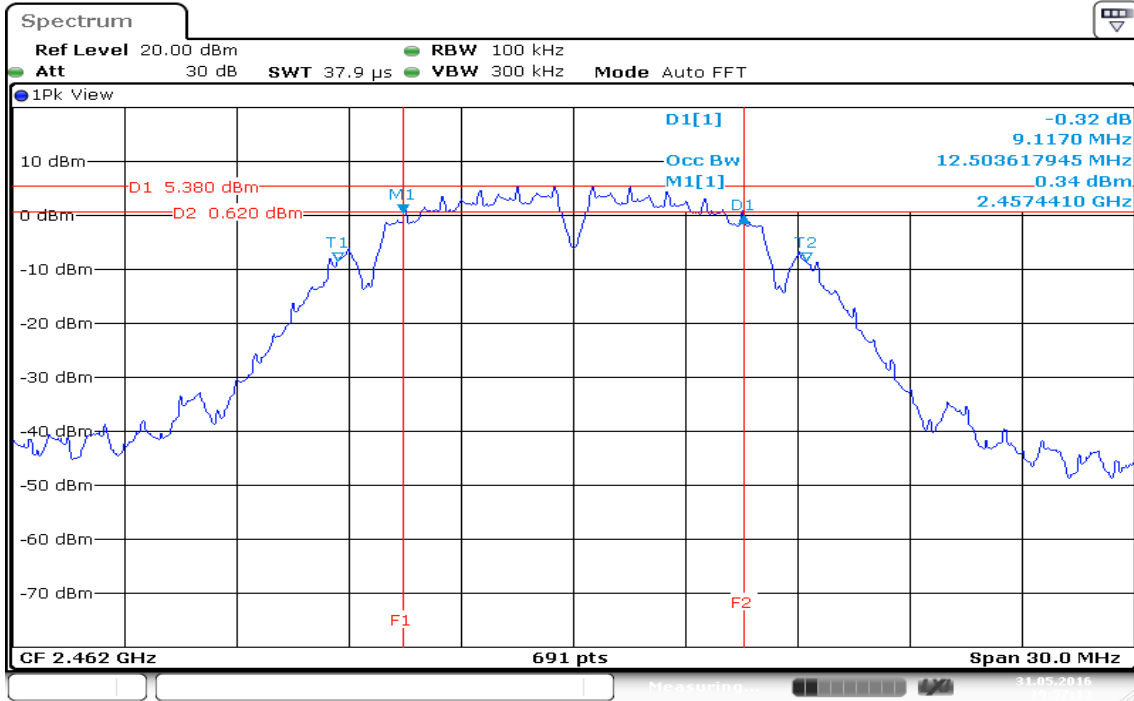

IEEE 802.11g mode

6dB Bandwidth (CH Low)

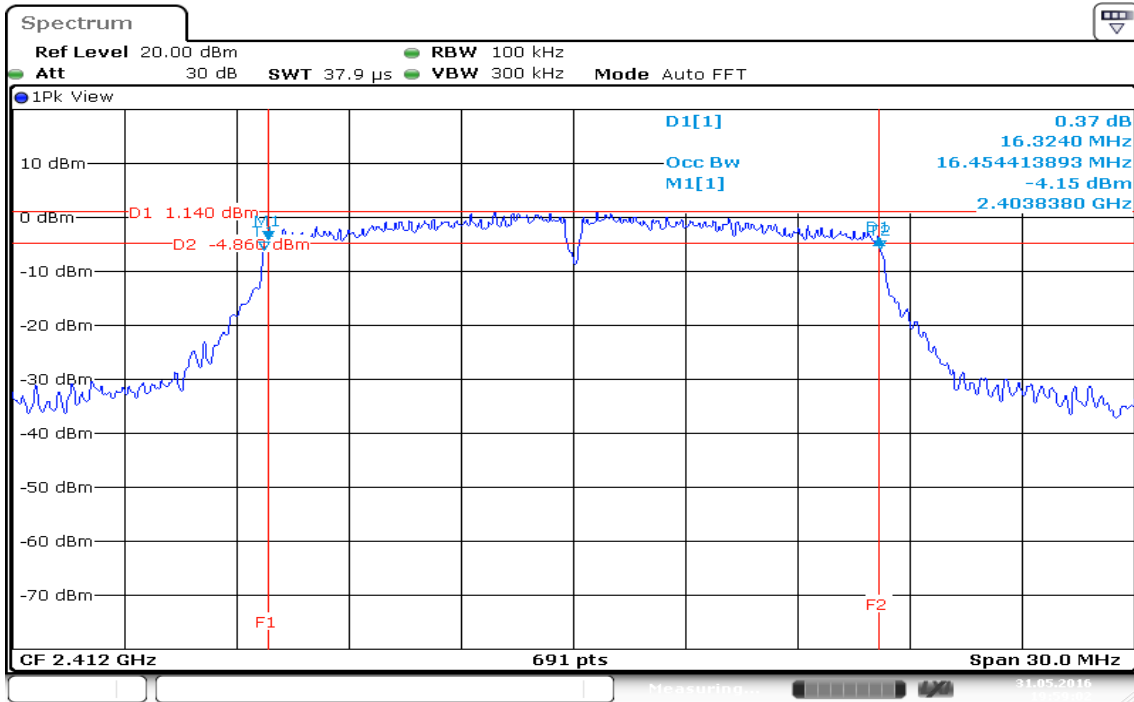

6dB Bandwidth (CH Mid)

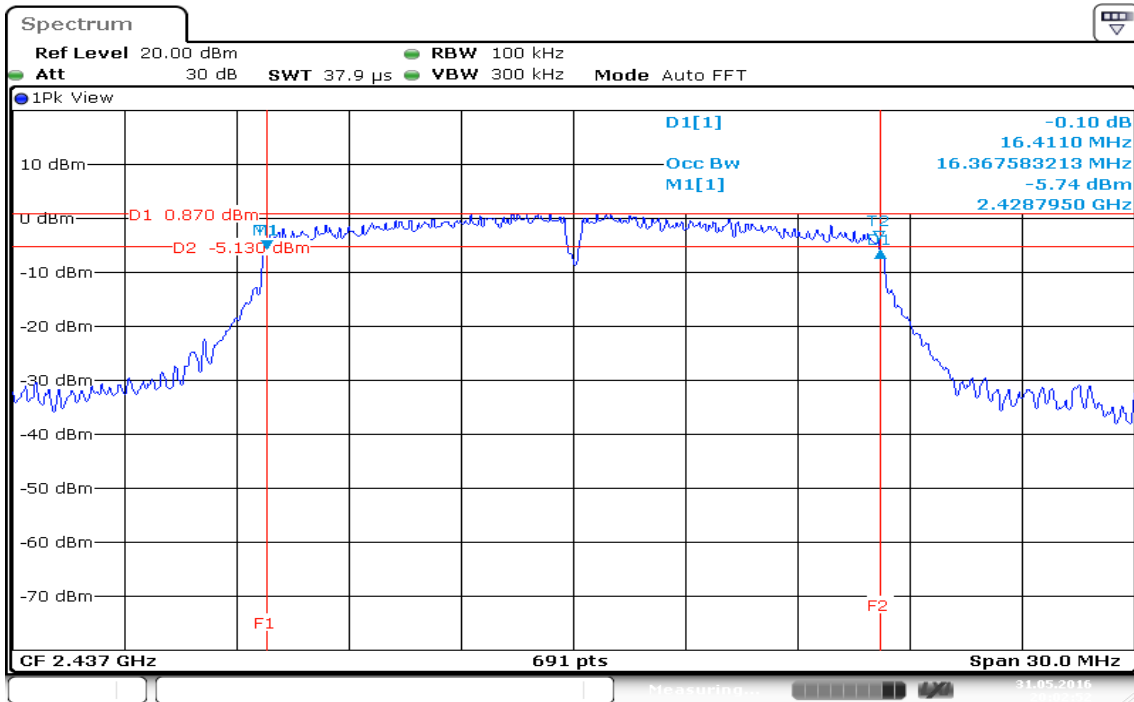

6dB Bandwidth (CH High)

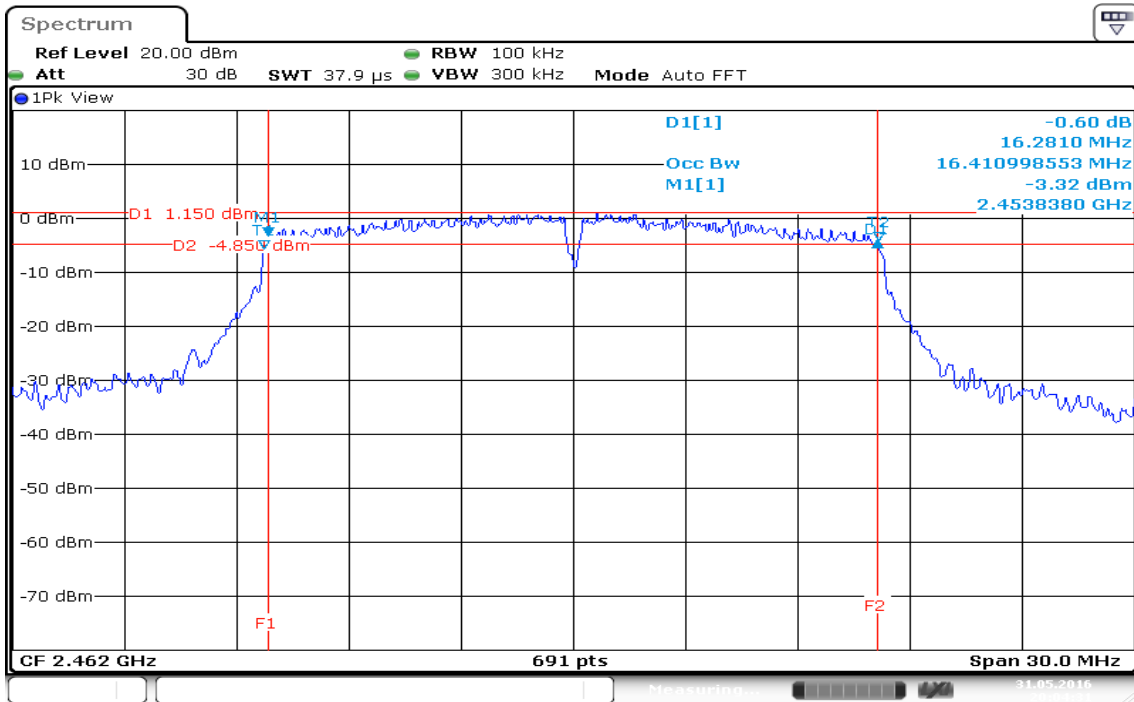

Date: 31.MAY.2016 20:04:31

IEEE 802.11n HT 20 MHz mode

6dB Bandwidth (CH Low)

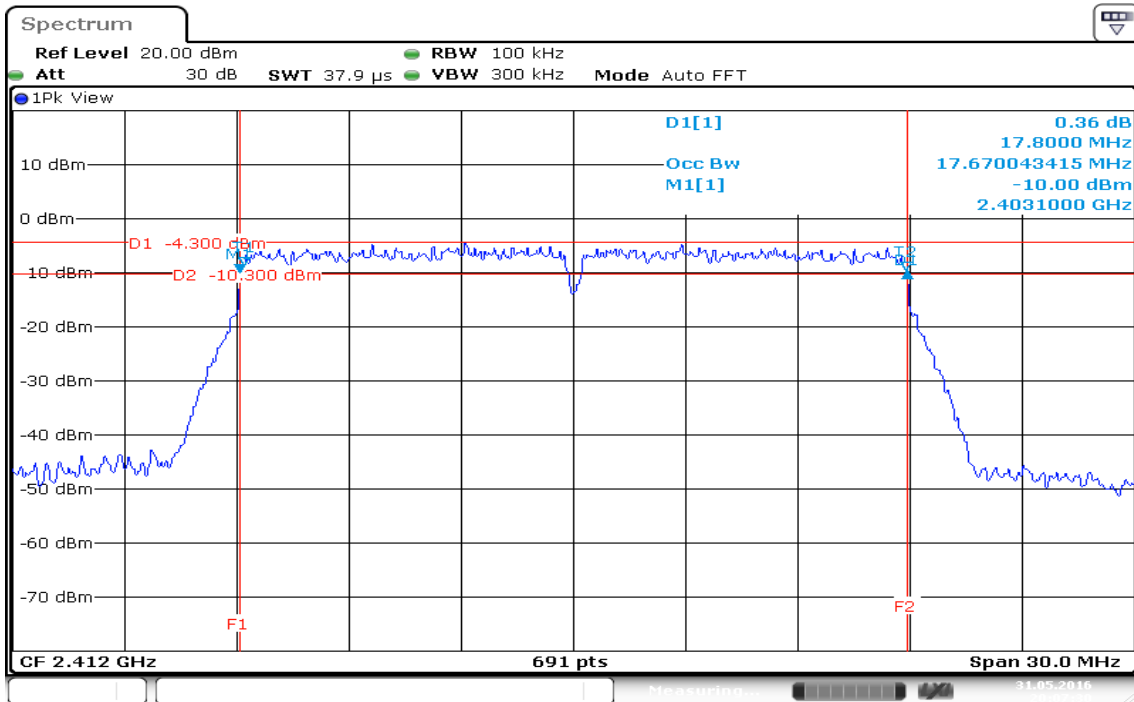

Date: 31.MAY.2016 20:07:30

6dB Bandwidth (CH Mid)

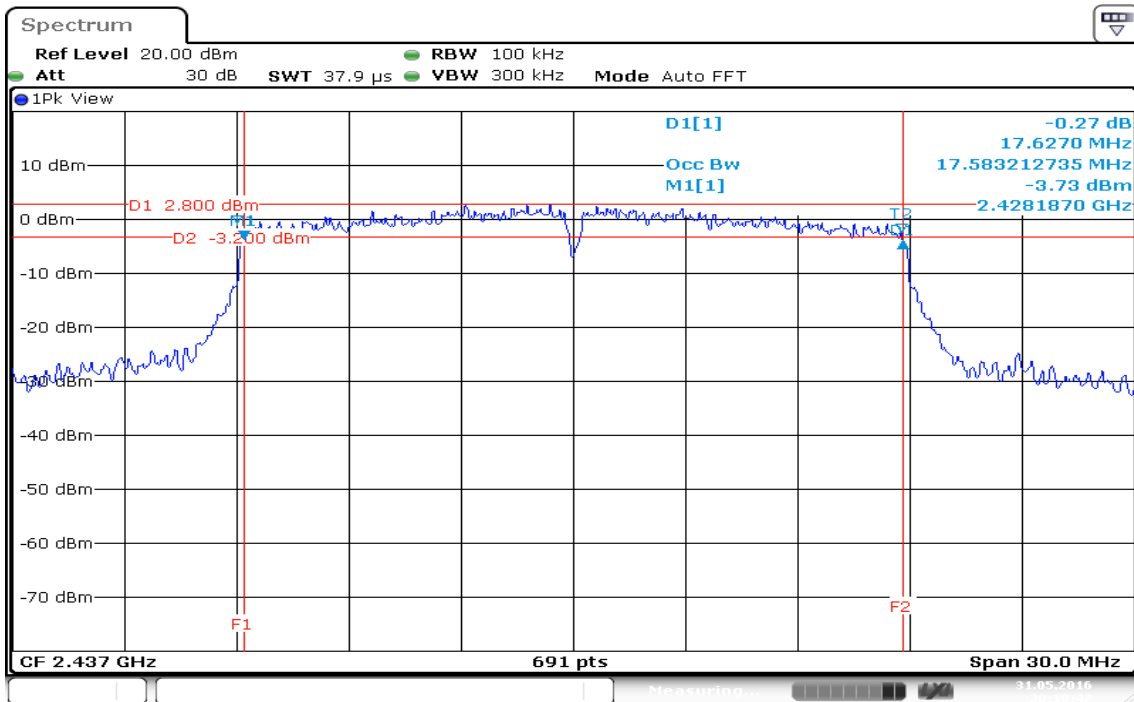

Date: 31.MAY.2016 20:10:42

6dB Bandwidth (CH High)

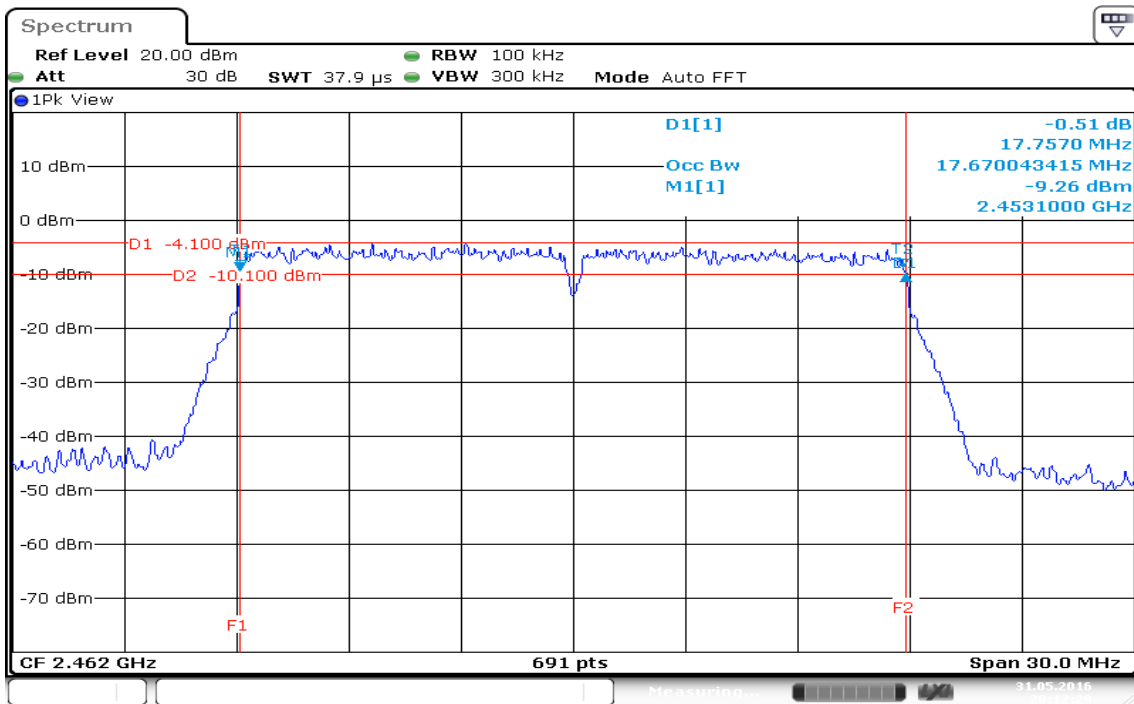

Date: 31.MAY.2016 20:12:29

IEEE 802.11n HT 40 MHz mode

6dB Bandwidth (CH Low)

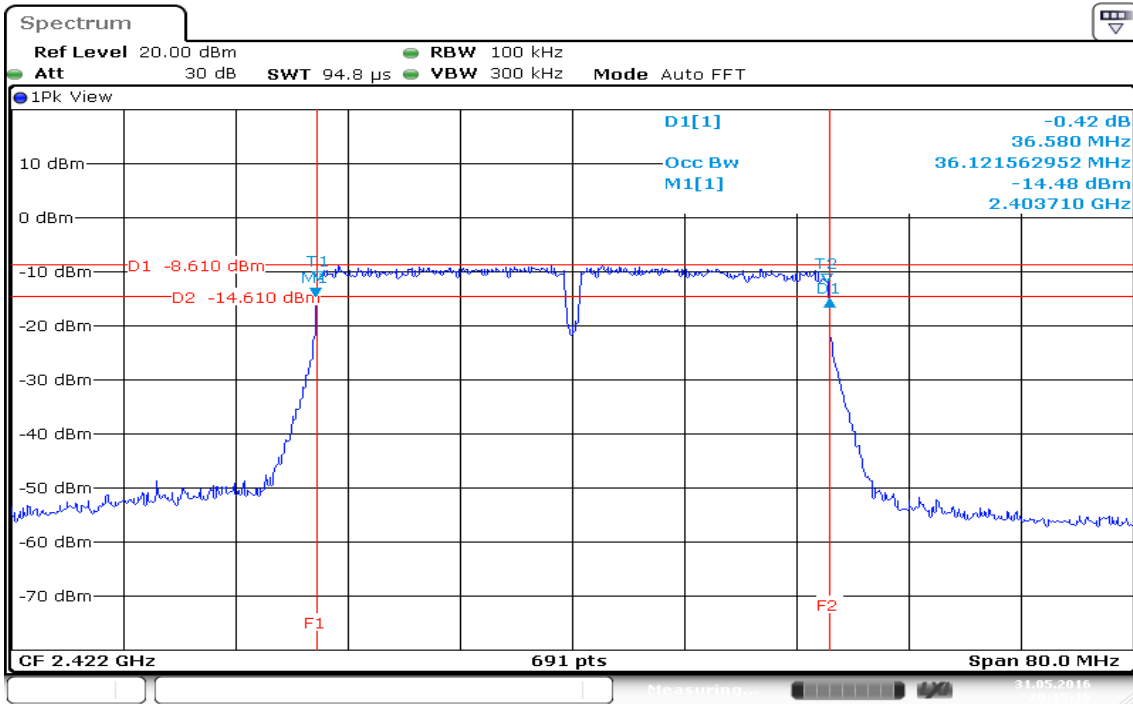

6dB Bandwidth (CH Mid)

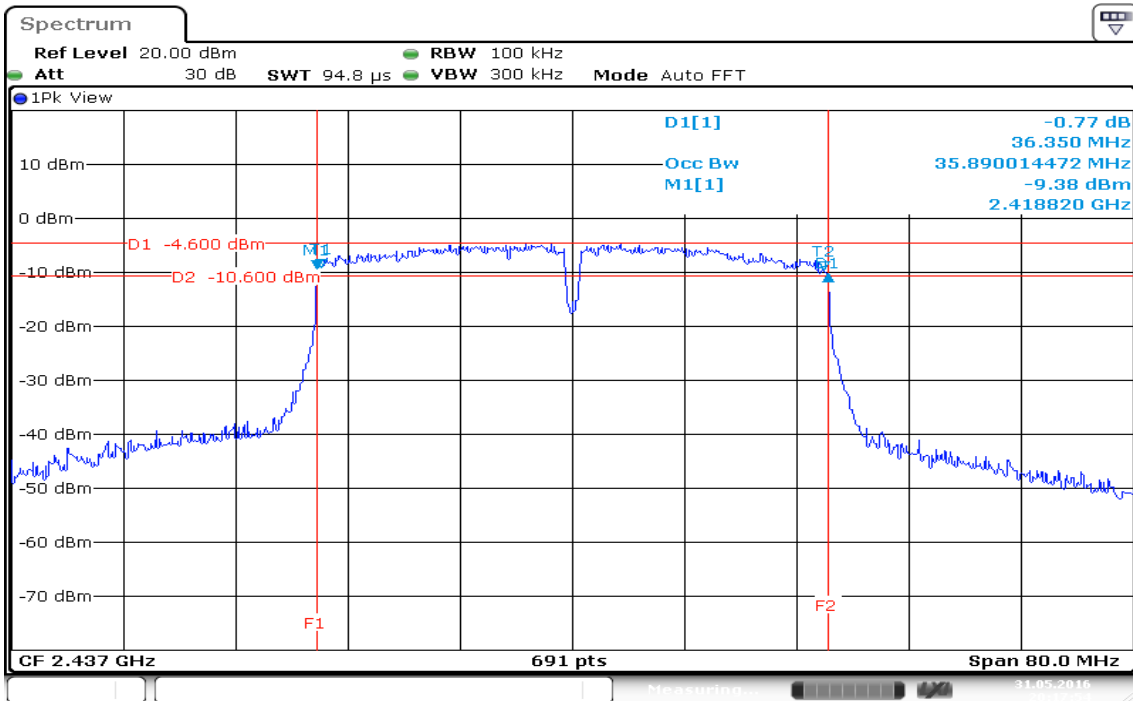

6dB Bandwidth (CH High)

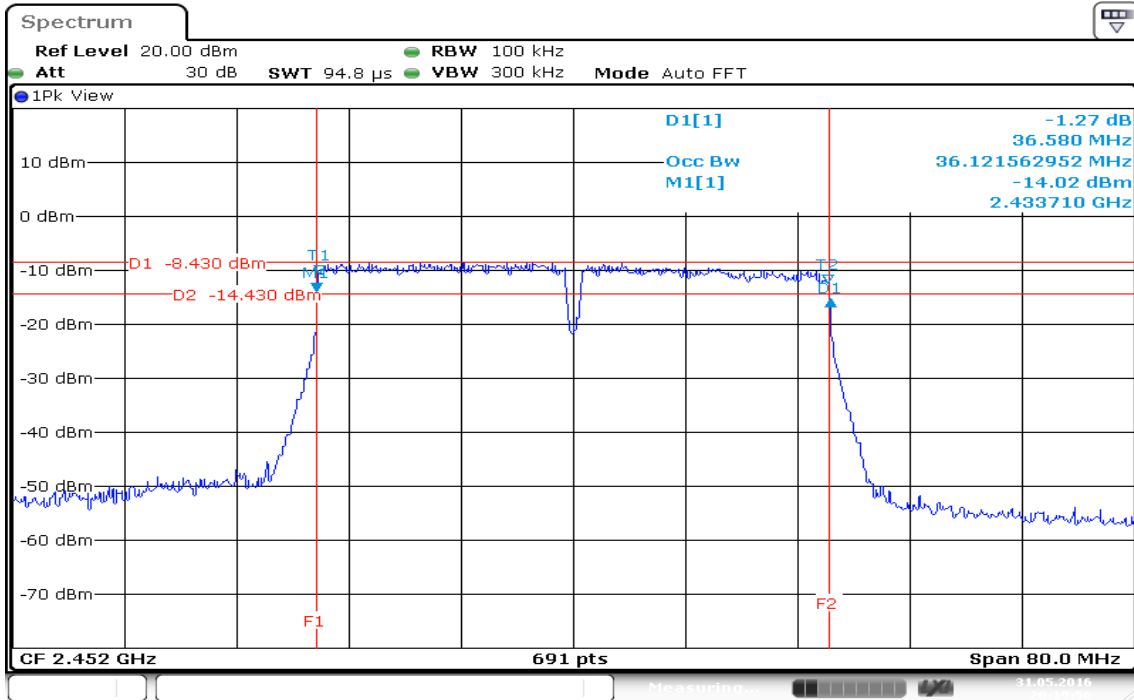

Date: 31.MAY.2016 20:19:57

7.3 PEAK POWER

LIMIT

The maximum peak output power of the intentional radiator shall not exceed the following:

1. According to §15.247(b)(3), for systems using digital modulation in the bands of 902-928 MHz, 2400-2483.5 MHz, and 5725-5850 MHz: 1 Watt.
2. According to §15.247(b)(4), the conducted output power limit specified in paragraph (b) of this section is based on the use of antennas with directional gains that do not exceed 6 dBi. Except as shown in paragraph (c) of this section, if transmitting antennas of directional gain greater than 6 dBi are used, the conducted output power from the intentional radiator shall be reduced below the stated values in paragraphs (b)(1), (b)(2), and (b)(3) of this section, as appropriate, by the amount in dB that the directional gain of the antenna exceeds 6 dBi.
3. According to RSS-247, for systems employing digital modulation techniques operating in the bands 902-928 MHz, 2400-2483.5 MHz and 5725-5850 MHz, the maximum peak conducted output power shall not exceed 1 W.

Test Configuration

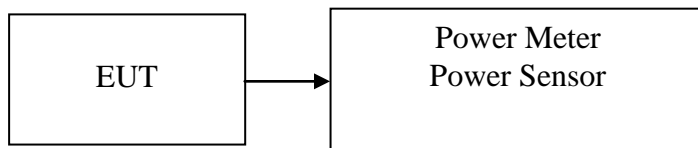

TEST PROCEDURE

The transmitter output is connected to the Power Meter. The Power Meter is set to the peak power detection.

TEST RESULTS

No non-compliance noted

Test Data

IEEE 802.11b mode

Channel	Frequency (MHz)	Output Power (dBm)	Output Power (W)	Limit (dBm)	Result
Low	2412	*18.26	0.0670	30	PASS
Mid	2437	17.96	0.0625		PASS
High	2462	17.88	0.0614		PASS

IEEE 802.11g mode

Channel	Frequency (MHz)	Output Power (dBm)	Output Power (W)	Limit (dBm)	Result
Low	2412	20.72	0.1180	30	PASS
Mid	2437	20.71	0.1178		PASS
High	2462	*21.12	0.1294		PASS

IEEE 802.11n HT 20 MHz mode

Channel	Frequency (MHz)	Output Power (dBm)	Output Power (W)	Limit (dBm)	Result
Low	2412	18.93	0.0782	30	PASS
Mid	2437	*20.50	0.1122		PASS
High	2462	18.66	0.0735		PASS

IEEE 802.11n HT 40 MHz mode

Channel	Frequency (MHz)	Output Power (dBm)	Output Power (W)	Limit (dBm)	Result
Low	2422	17.45	0.0556	30	PASS
Mid	2437	*20.63	0.1156		PASS
High	2452	17.43	0.0553		PASS

7.4 AVERAGE POWER

LIMIT

None; for reporting purposes only.

Test Configuration

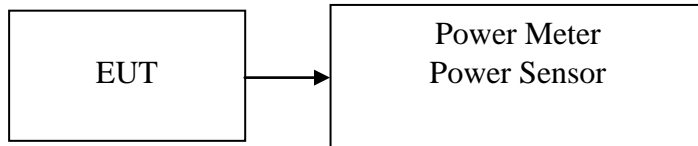

TEST PROCEDURE

The transmitter output is connected to the Power Meter. The Power Meter is set to the peak power detection.

TEST RESULTS

No non-compliance noted

Test Data**Test mode: IEEE 802.11b mode**

Channel	Frequency (MHz)	Output Power (dBm)	Output Power (W)
Low	2412	15.48	0.0353
Mid	2437	15.21	0.0332
High	2462	15.11	0.0324

Test mode: IEEE 802.11g mode

Channel	Frequency (MHz)	Output Power (dBm)	Output Power (W)
Low	2412	13.28	0.0213
Mid	2437	13.80	0.0240
High	2462	13.40	0.0219

Test mode: IEEE 802.11n HT 20 MHz mode

Channel	Frequency (MHz)	Output Power (dBm)	Output Power (W)
Low	2412	11.05	0.0127
Mid	2437	13.31	0.0214
High	2462	10.12	0.0103

Test mode: IEEE 802.11n HT 40 MHz mode

Channel	Frequency (MHz)	Output Power (dBm)	Output Power (W)
Low	2422	8.91	0.0078
Mid	2437	12.51	0.0178
High	2452	9.23	0.0084

7.5 BAND EDGES MEASUREMENT

LIMIT

According to §15.247(d) & RSS-247, in any 100 kHz bandwidth outside the frequency bands in which the spread spectrum intentional radiator is operating, the radio frequency power that is produced by the intentional radiator shall be at least 20 dB below that in the 100 kHz bandwidth within the band that contains the highest level of the desired power, based on either an RF conducted or a radiated measurement, provided the transmitter demonstrates compliance with the peak conducted power limits. In addition, radiated emissions which fall in the restricted bands, as defined in §15.205(a), must also comply with the radiated emission limits specified in 15.209(a) (see Section 15.205(c)).

Test Configuration

For Radiated

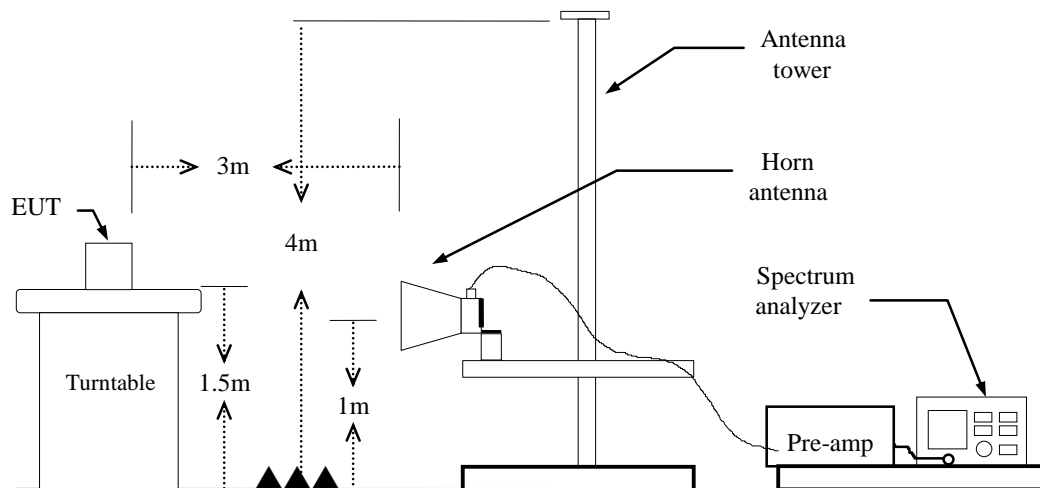

TEST PROCEDURE

For Radiated

1. The EUT is placed on a turntable, which is 1.5m above the ground plane.
2. The turntable shall be rotated for 360 degrees to determine the position of maximum emission level.
3. EUT is set 3m away from the receiving antenna, which is varied from 1m to 4m to find out the highest emission.
4. Set the spectrum analyzer in the following setting in order to capture the lower and upper band-edges of the emission:
 - (a) PEAK: RBW=1MHz / VBW=3MHz / Sweep=AUTO
 - (b) AVERAGE: RBW=1MHz,
if duty cycle $\geq 98\%$, VBW=10Hz.
if duty cycle $< 98\%$ VBW=1/T.
IEEE 802.11b mode: $\geq 98\%$, VBW=10Hz
IEEE 802.11g mode: $\geq 98\%$, VBW=10Hz
IEEE 802.11n HT 20 MHz mode: $\geq 98\%$, VBW=10Hz
IEEE 802.11n HT 40 MHz mode: $\geq 98\%$, VBW=10Hz
5. Repeat the procedures until all the PEAK and AVERAGE versus POLARIZATION are measured.
6. Result = Spectrum Reading + cable loss(spectrum to Amp) - Amp Gain + Cable loss(Amp to receive Ant)+ Receive Ant

For Un-restricted Band Emissions

The peak output power procedure is used to measure the fundamental emission power to demonstrate compliance to requirements, then the peak conducted output power measured within any 100 kHz outside the authorized frequency band shall be attenuated by at least 20 dB relative to the maximum measured in-band peak PSD level.

TEST RESULTS

Refer to attach spectrum analyzer data chart.

Band Edges

IEEE 802.11b Mode / CH Low

Detector mode: Peak

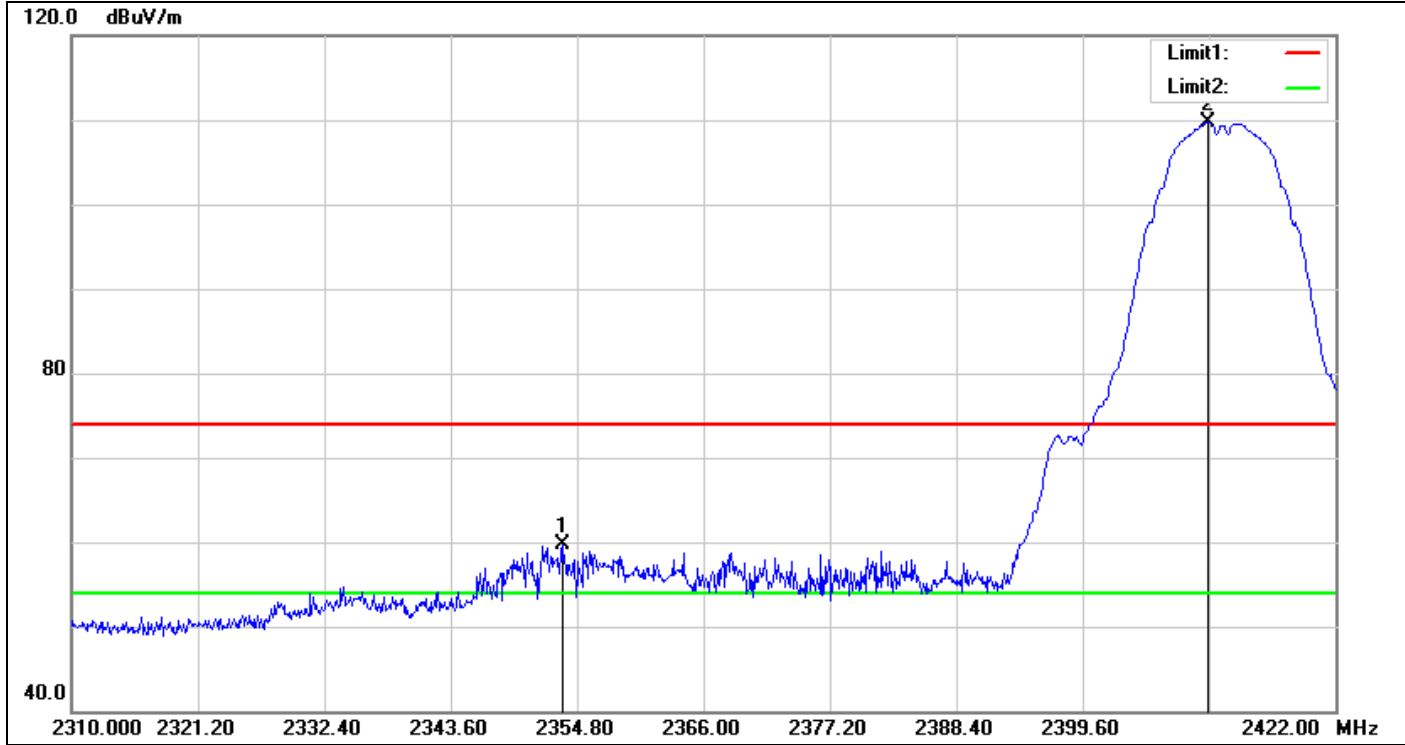

No.	Frequency (MHz)	Reading (dBuV)	Correct Factor(dB/m)	Result (dBuV/m)	Limit (dBuV/m)	Margin (dB)	Remark
1	2353.456	62.41	-2.80	59.61	74.00	-14.39	peak
2	2410.688	112.11	-2.43	109.68	74.00	35.68	peak

Detector mode: Average

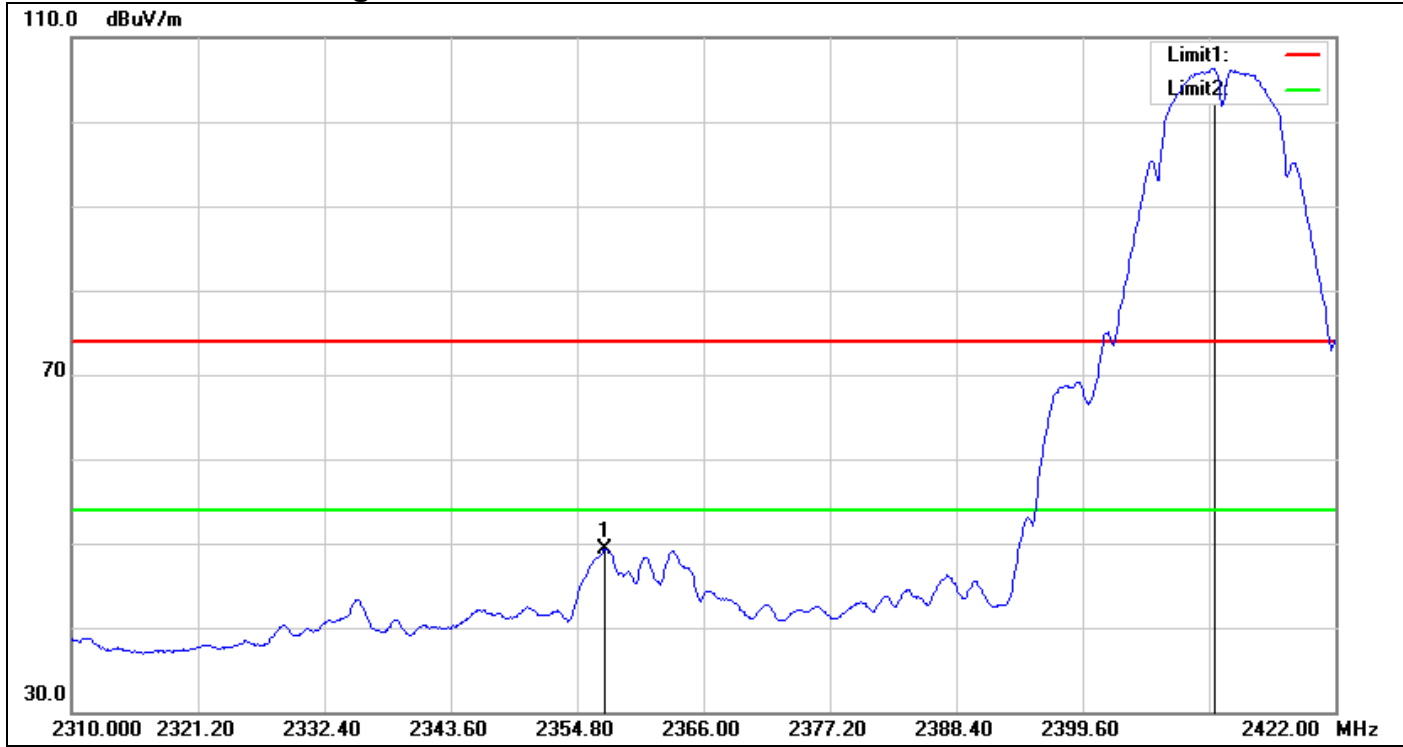

No.	Frequency (MHz)	Reading (dBuV)	Correct Factor(dB/m)	Result (dBuV/m)	Limit (dBuV/m)	Margin (dB)	Remark
1	2357.264	52.19	-2.81	49.38	54.00	-4.62	AVG
2	2411.248	108.80	-2.42	106.38	54.00	52.38	AVG

Band Edges

IEEE 802.11b Mode / CH Mid

Detector mode: Peak

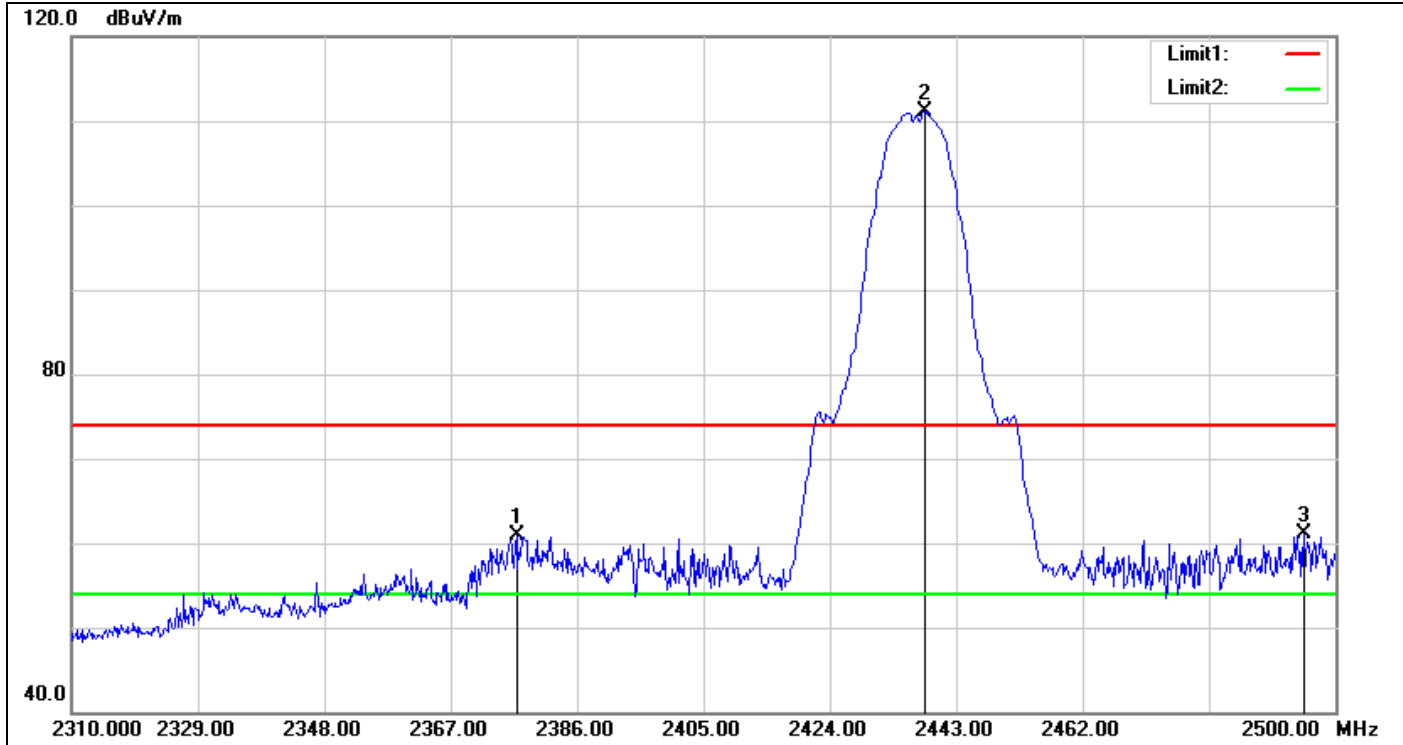

No.	Frequency (MHz)	Reading (dBuV)	Correct Factor(dB/m)	Result (dBuV/m)	Limit (dBuV/m)	Margin (dB)	Remark
1	2376.880	63.51	-2.60	60.91	74.00	-13.09	peak
2	2438.250	113.28	-2.23	111.05	74.00	37.05	peak
3	2495.250	63.02	-1.89	61.13	74.00	-12.87	peak

Detector mode: Average

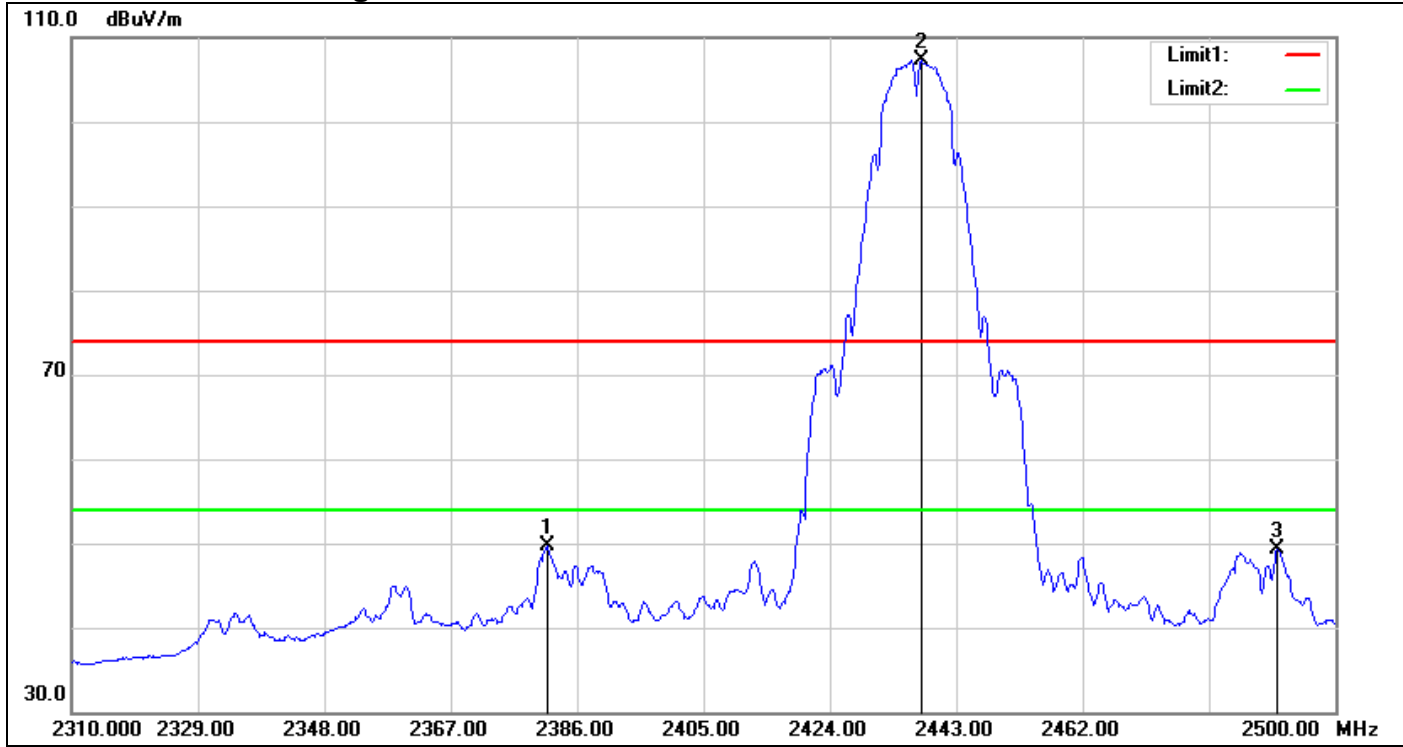

No.	Frequency (MHz)	Reading (dBuV)	Correct Factor(dB/m)	Result (dBuV/m)	Limit (dBuV/m)	Margin (dB)	Remark
1	2381.440	52.33	-2.57	49.76	54.00	-4.24	AVG
2	2437.680	109.48	-2.23	107.25	54.00	53.25	AVG
3	2491.260	51.20	-1.92	49.28	54.00	-4.72	AVG

Band Edges

IEEE 802.11b Mode / CH High

Detector mode: Peak

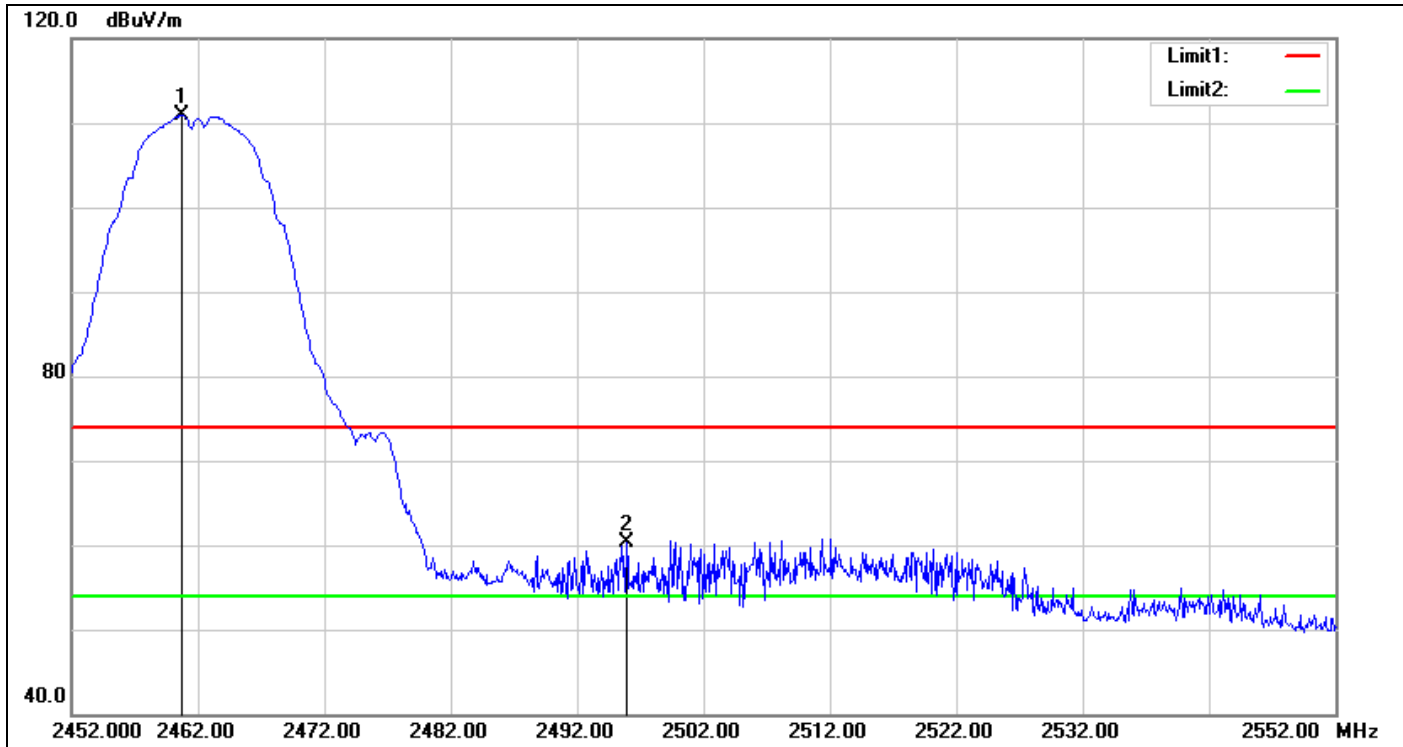

No.	Frequency (MHz)	Reading (dBuV)	Correct Factor(dB/m)	Result (dBuV/m)	Limit (dBuV/m)	Margin (dB)	Remark
1	2460.700	112.94	-2.10	110.84	74.00	36.84	peak
2	2495.900	62.11	-1.89	60.22	74.00	-13.78	peak

Detector mode: Average



No.	Frequency (MHz)	Reading (dBuV)	Correct Factor(dB/m)	Result (dBuV/m)	Limit (dBuV/m)	Margin (dB)	Remark
1	2461.300	109.20	-2.10	107.10	54.00	53.10	AVG
2	2486.900	50.11	-1.96	48.15	54.00	-5.85	AVG

Band Edges

IEEE 802.11g Mode / CH Low

Detector mode: Peak

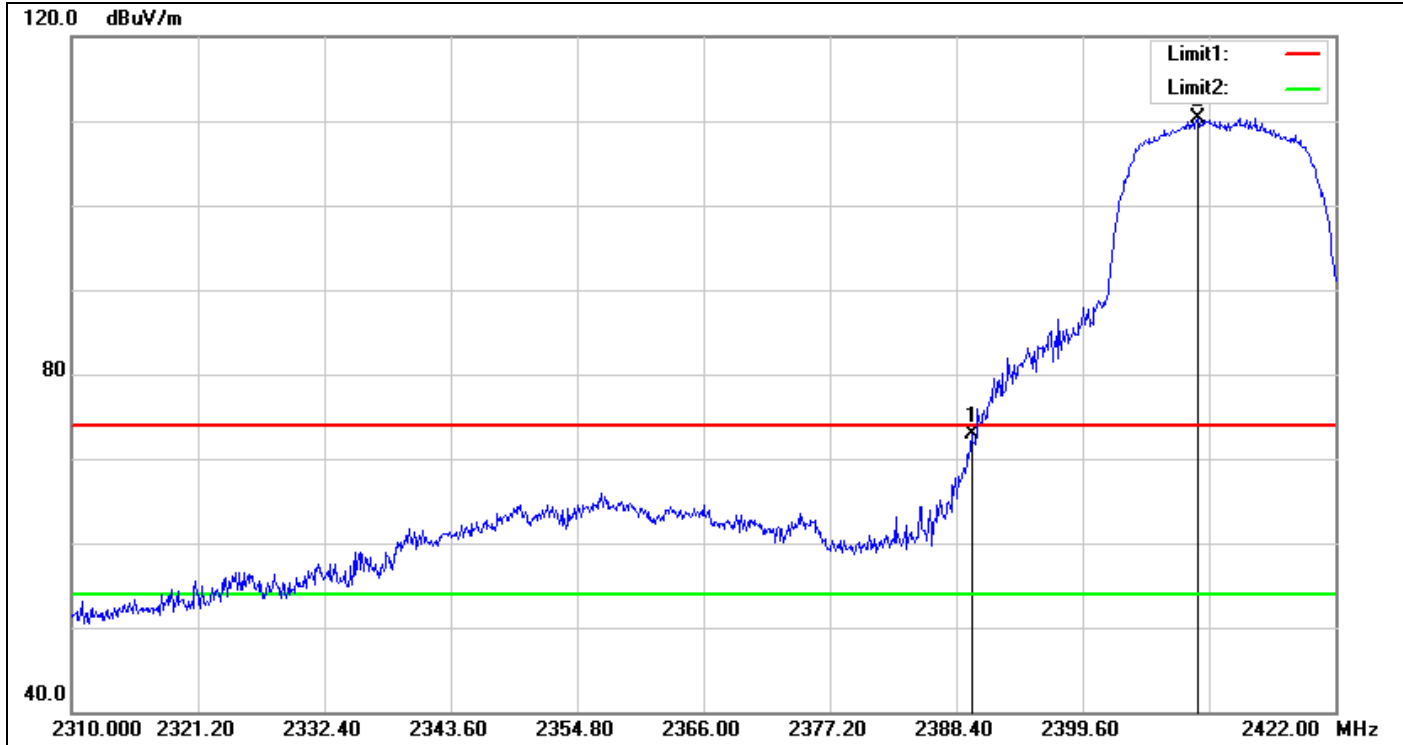

No.	Frequency (MHz)	Reading (dBuV)	Correct Factor(dB/m)	Result (dBuV/m)	Limit (dBuV/m)	Margin (dB)	Remark
1	2389.744	75.43	-2.49	72.94	74.00	-1.06	peak
2	2409.792	112.78	-2.43	110.35	74.00	36.35	peak

Detector mode: Average

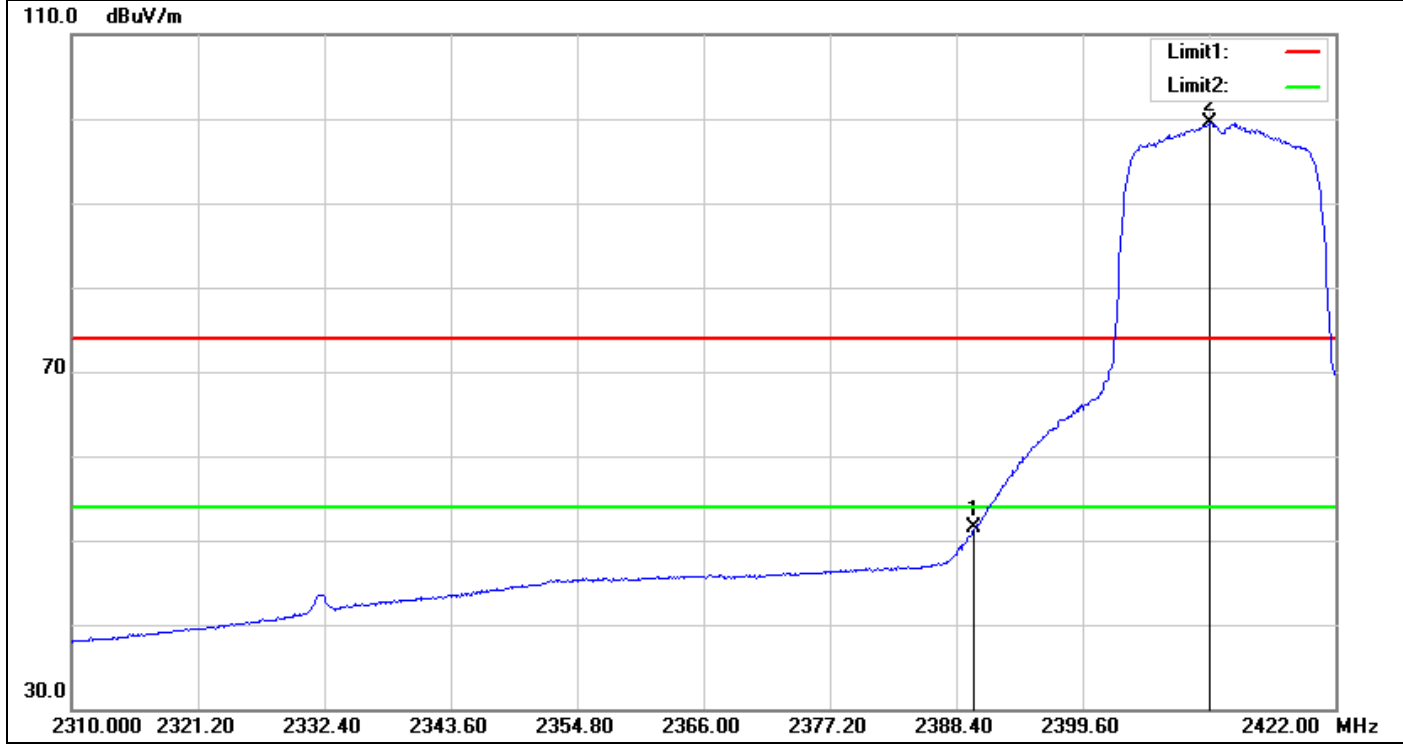

No.	Frequency (MHz)	Reading (dBuV)	Correct Factor(dB/m)	Result (dBuV/m)	Limit (dBuV/m)	Margin (dB)	Remark
1	2390.000	53.93	-2.49	51.44	54.00	-2.56	AVG
2	2410.800	101.95	-2.42	99.53	54.00	45.53	AVG

Band Edges

IEEE 802.11g Mode / CH Mid

Detector mode: Peak

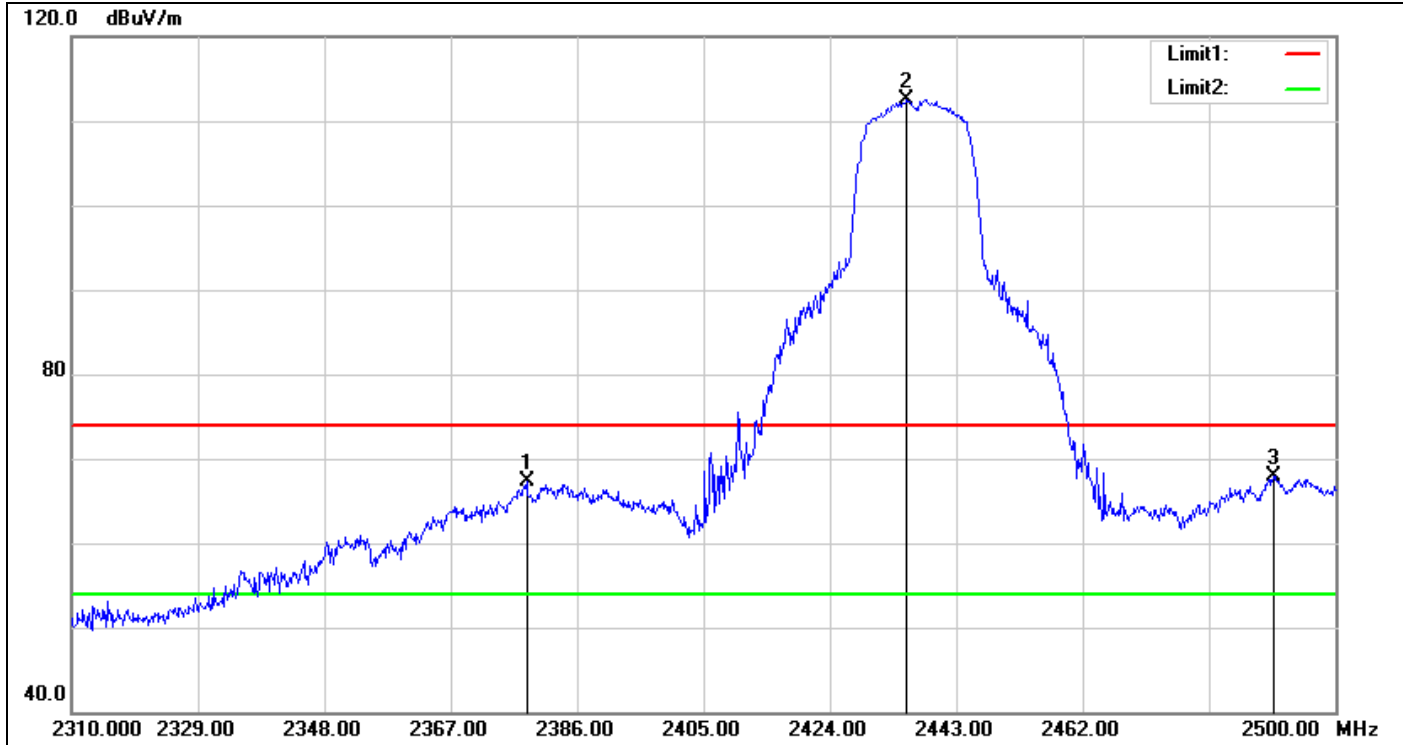

No.	Frequency (MHz)	Reading (dBuV)	Correct Factor(dB/m)	Result (dBuV/m)	Limit (dBuV/m)	Margin (dB)	Remark
1	2378.400	69.82	-2.59	67.23	74.00	-6.77	peak
2	2435.590	114.77	-2.24	112.53	74.00	38.53	peak
3	2490.690	69.84	-1.93	67.91	74.00	-6.09	peak

Detector mode: Average

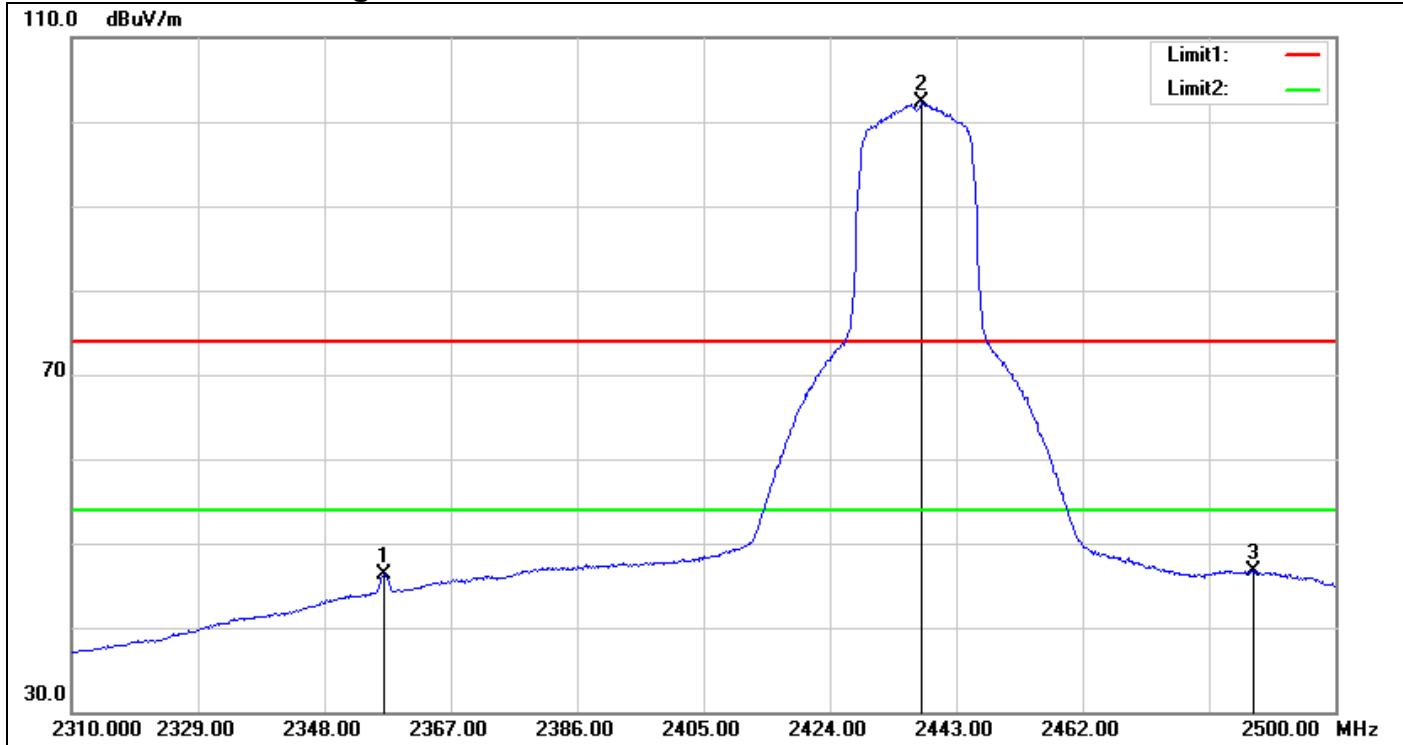

No.	Frequency (MHz)	Reading (dBuV)	Correct Factor(dB/m)	Result (dBuV/m)	Limit (dBuV/m)	Margin (dB)	Remark
1	2356.930	49.14	-2.81	46.33	54.00	-7.67	AVG
2	2437.870	104.52	-2.23	102.29	54.00	48.29	AVG
3	2487.650	48.69	-1.95	46.74	54.00	-7.26	AVG

Band Edges

IEEE 802.11g Mode / CH High

Detector mode: Peak

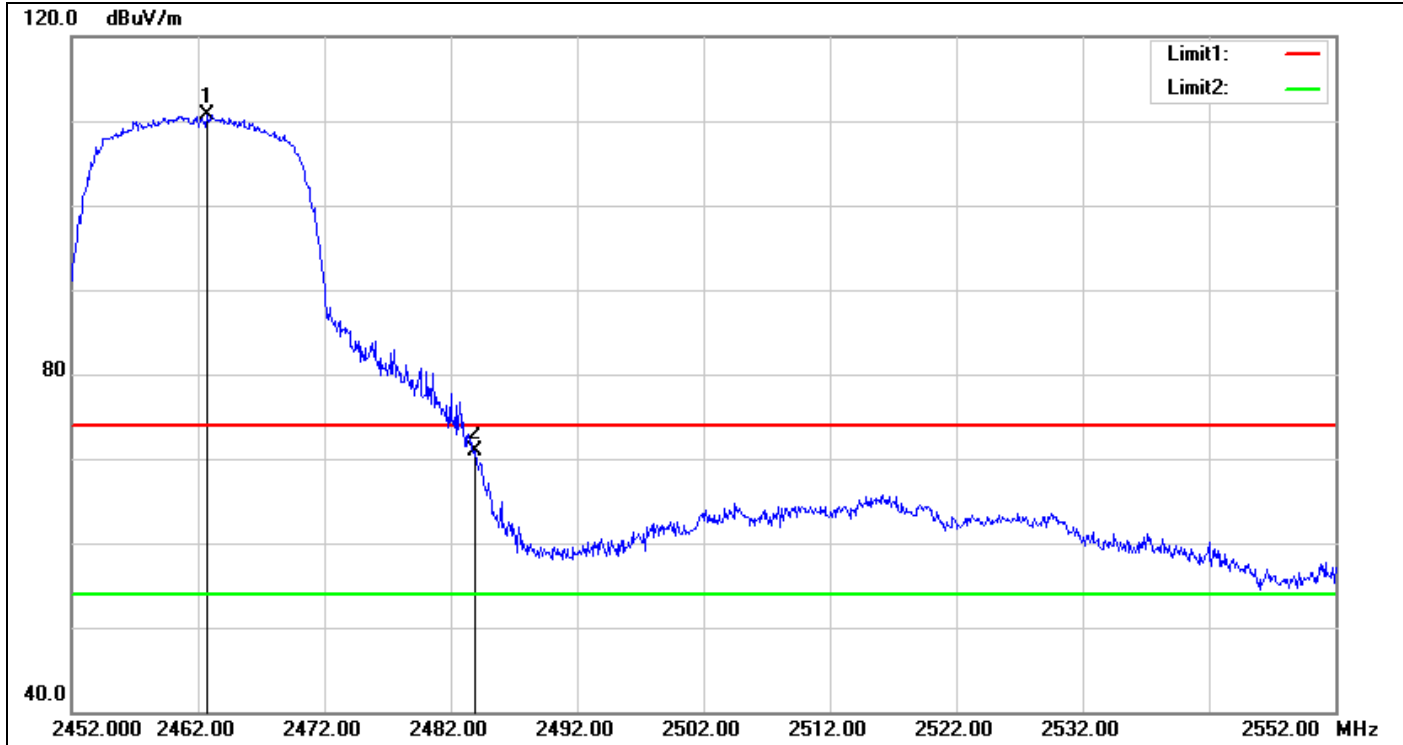

No.	Frequency (MHz)	Reading (dBuV)	Correct Factor(dB/m)	Result (dBuV/m)	Limit (dBuV/m)	Margin (dB)	Remark
1	2462.700	112.78	-2.09	110.69	74.00	36.69	peak
2	2483.900	72.87	-1.99	70.88	74.00	-3.12	peak

Detector mode: Average

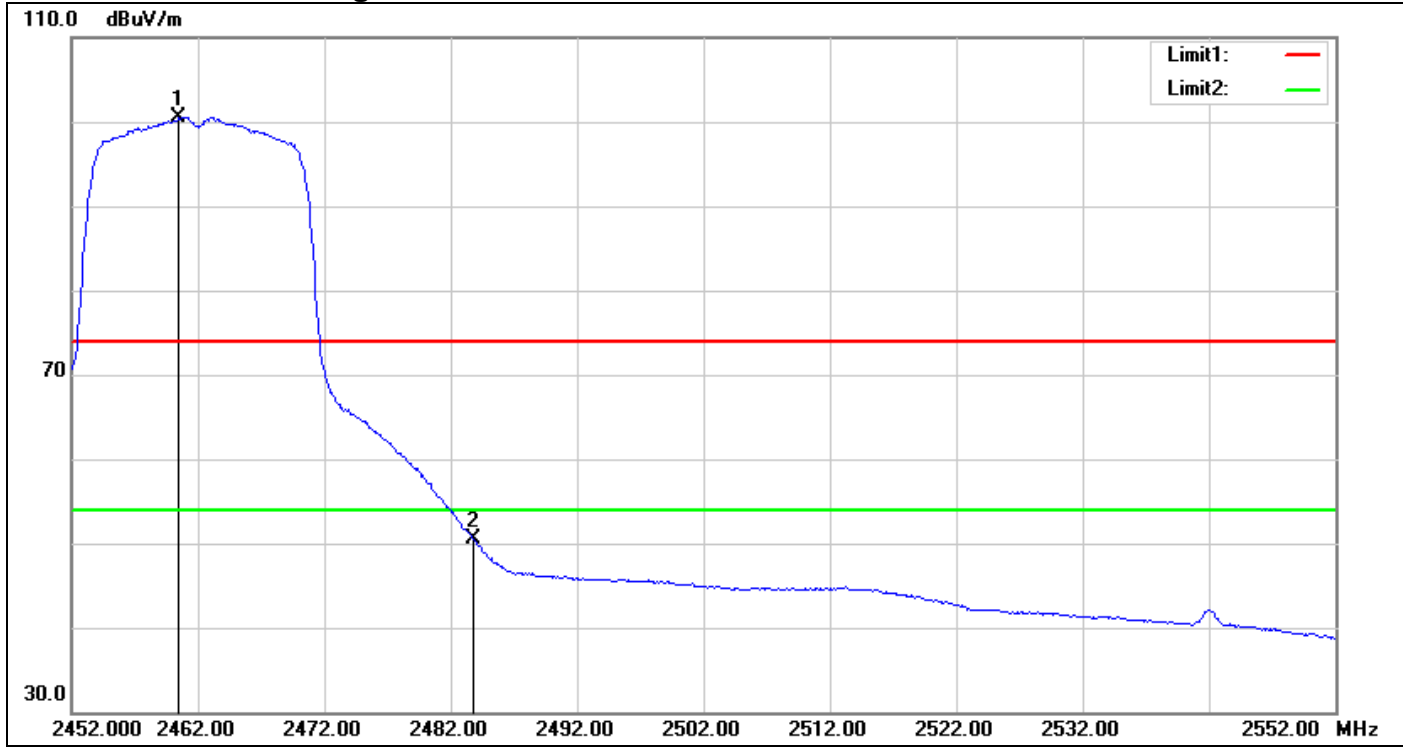

No.	Frequency (MHz)	Reading (dBuV)	Correct Factor(dB/m)	Result (dBuV/m)	Limit (dBuV/m)	Margin (dB)	Remark
1	2460.500	102.61	-2.10	100.51	54.00	46.51	AVG
2	2483.800	52.55	-1.99	50.56	54.00	-3.44	AVG

Band Edges

IEEE 802.11n HT 20 MHz Channel Mode / CH Low

Detector mode: Peak

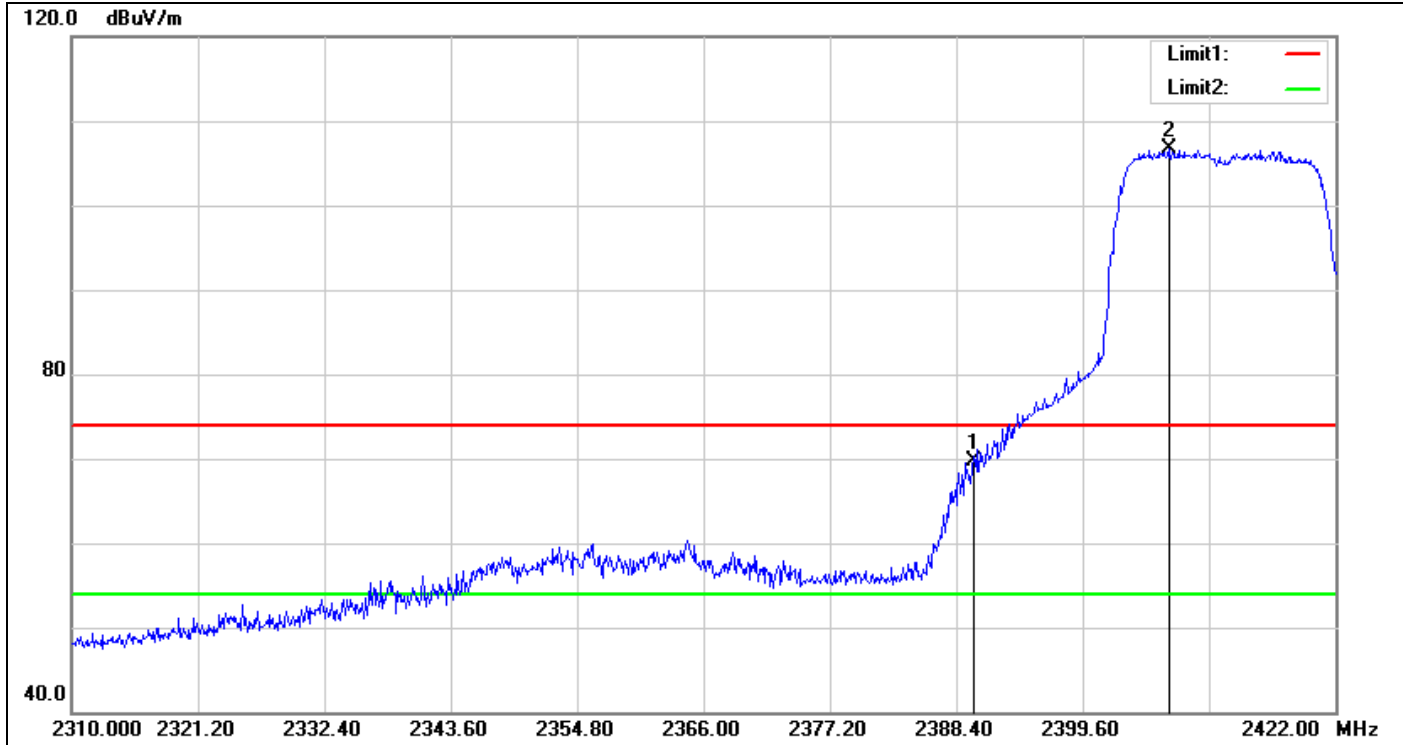

No.	Frequency (MHz)	Reading (dBuV)	Correct Factor(dB/m)	Result (dBuV/m)	Limit (dBuV/m)	Margin (dB)	Remark
1	2390.000	72.19	-2.49	69.70	74.00	-4.30	peak
2	2407.216	109.15	-2.42	106.73	74.00	32.73	peak

Detector mode: Average

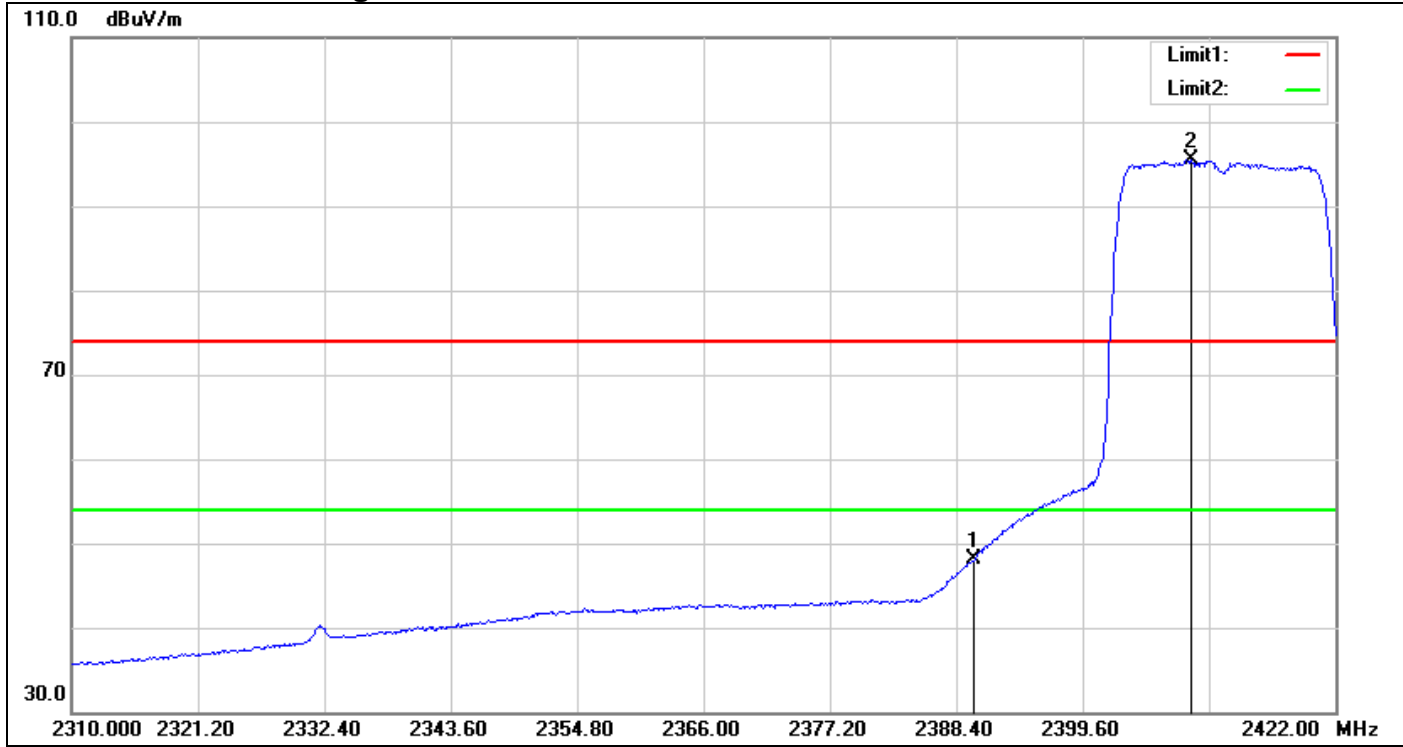

No.	Frequency (MHz)	Reading (dBuV)	Correct Factor(dB/m)	Result (dBuV/m)	Limit (dBuV/m)	Margin (dB)	Remark
1	2390.000	50.68	-2.49	48.19	54.00	-5.81	AVG
2	2409.232	97.85	-2.43	95.42	54.00	41.42	AVG

Band Edges

IEEE 802.11n HT 20 MHz Channel Mode / CH Mid

Detector mode: Peak

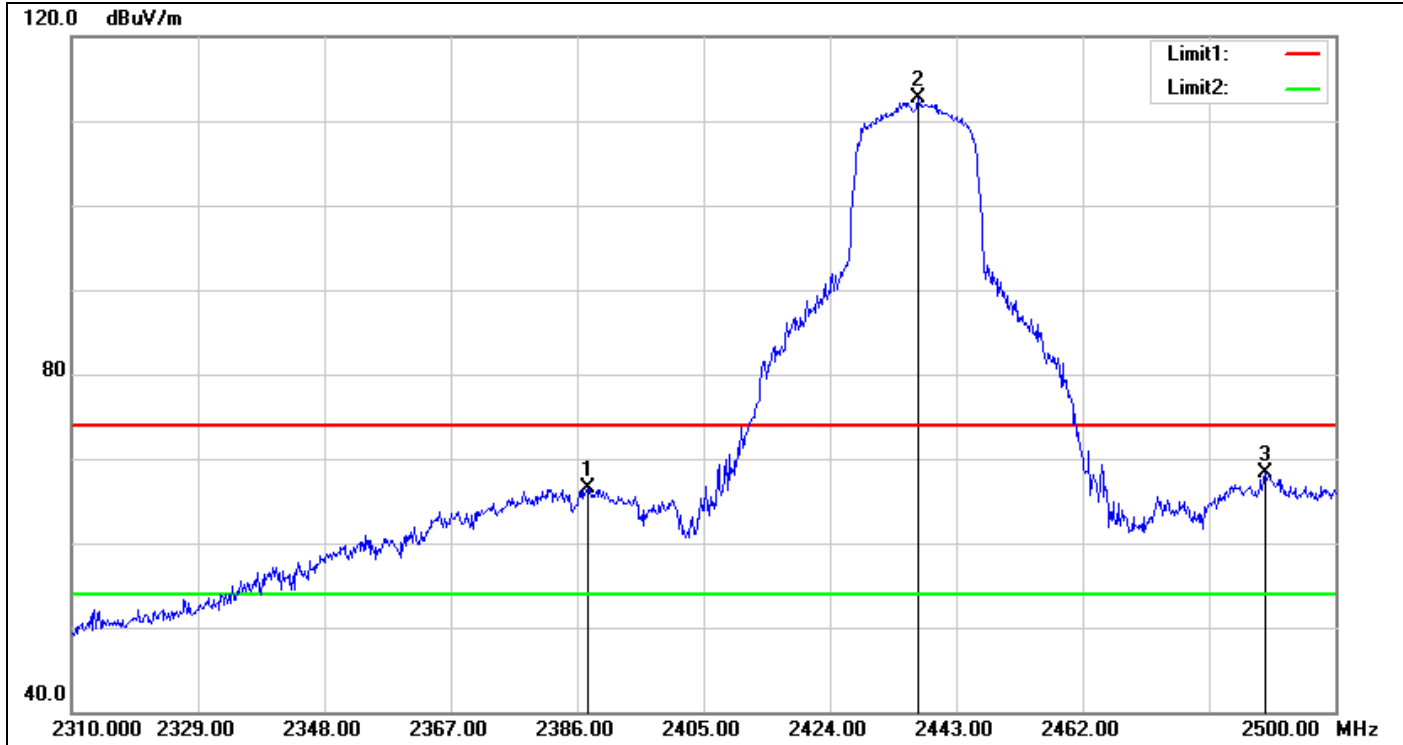

No.	Frequency (MHz)	Reading (dBuV)	Correct Factor(dB/m)	Result (dBuV/m)	Limit (dBuV/m)	Margin (dB)	Remark
1	2387.520	69.04	-2.51	66.53	74.00	-7.47	peak
2	2437.300	115.00	-2.23	112.77	74.00	38.77	peak
3	2489.550	70.23	-1.93	68.30	74.00	-5.70	peak

Detector mode: Average

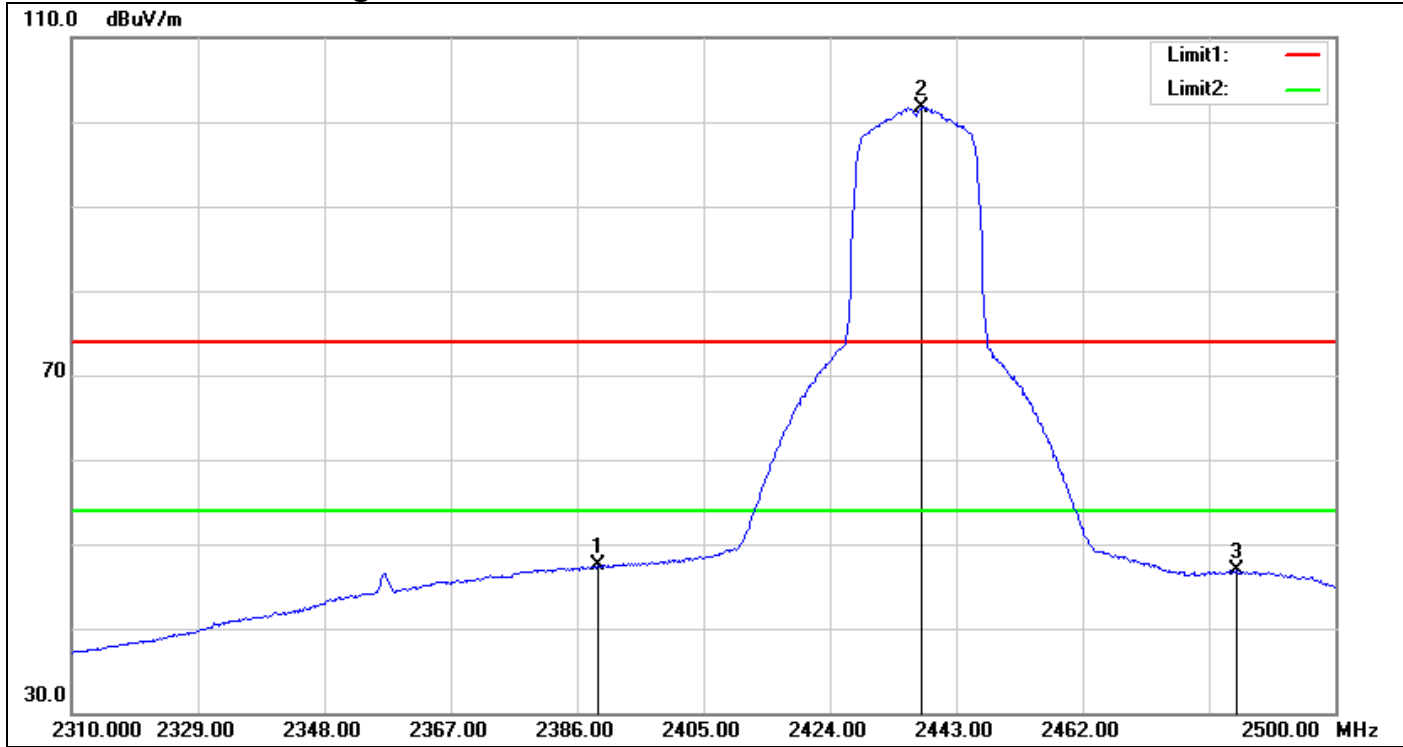

No.	Frequency (MHz)	Reading (dBuV)	Correct Factor(dB/m)	Result (dBuV/m)	Limit (dBuV/m)	Margin (dB)	Remark
1	2389.230	50.05	-2.50	47.55	54.00	-6.45	AVG
2	2437.870	103.97	-2.23	101.74	54.00	47.74	AVG
3	2485.180	48.79	-1.98	46.81	54.00	-7.19	AVG

Band Edges

IEEE 802.11n HT 20 MHz Channel Mode / CH High

Detector mode: Peak

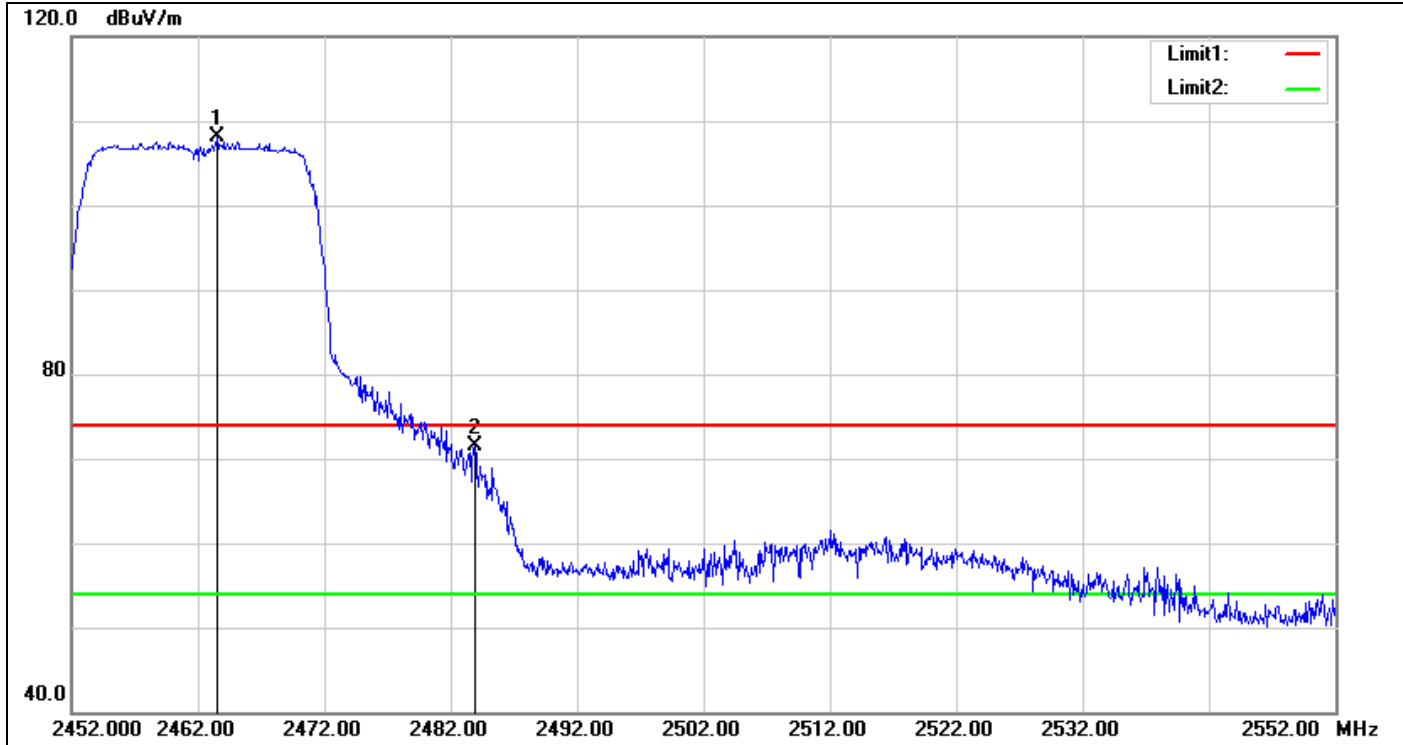

No.	Frequency (MHz)	Reading (dBuV)	Correct Factor(dB/m)	Result (dBuV/m)	Limit (dBuV/m)	Margin (dB)	Remark
1	2463.500	110.17	-2.09	108.08	74.00	34.08	peak
2	2483.900	73.48	-1.99	71.49	74.00	-2.51	peak

Detector mode: Average

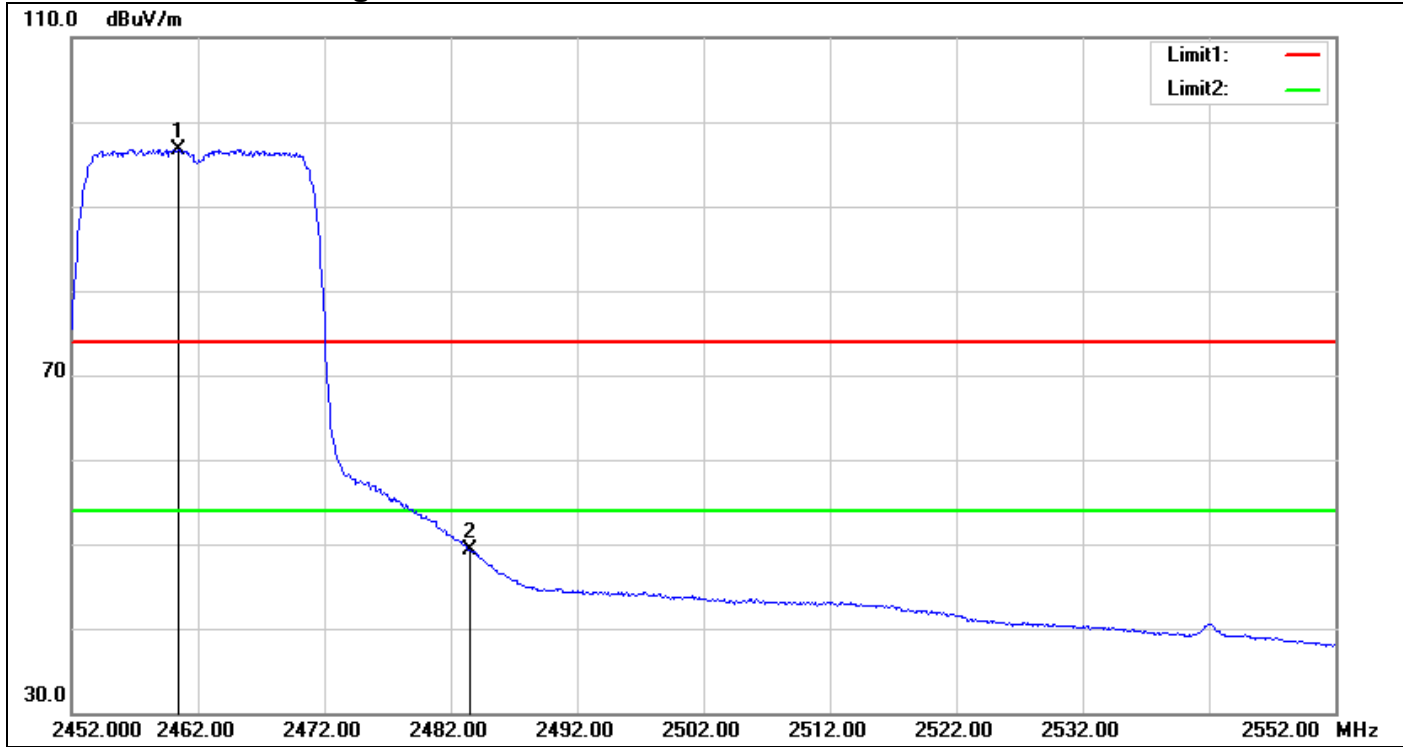

No.	Frequency (MHz)	Reading (dBuV)	Correct Factor(dB/m)	Result (dBuV/m)	Limit (dBuV/m)	Margin (dB)	Remark
1	2460.500	98.90	-2.10	96.80	54.00	42.80	AVG
2	2483.500	51.23	-1.99	49.24	54.00	-4.76	AVG

Band Edges

IEEE 802.11n HT 40 MHz Channel Mode / CH Low

Detector mode: Peak

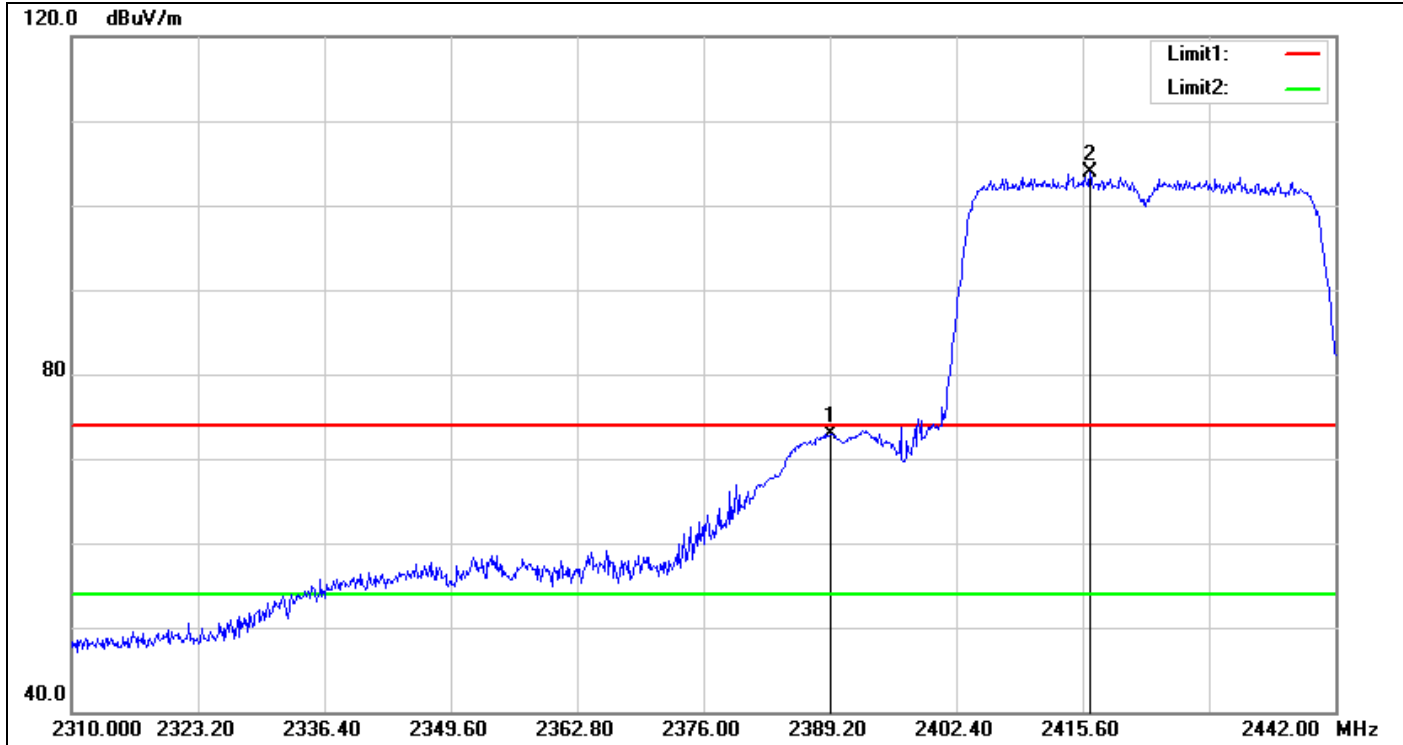

No.	Frequency (MHz)	Reading (dBuV)	Correct Factor(dB/m)	Result (dBuV/m)	Limit (dBuV/m)	Margin (dB)	Remark
1	2389.200	75.42	-2.50	72.92	74.00	-1.08	peak
2	2416.392	106.27	-2.38	103.89	74.00	29.89	peak

Detector mode: Average

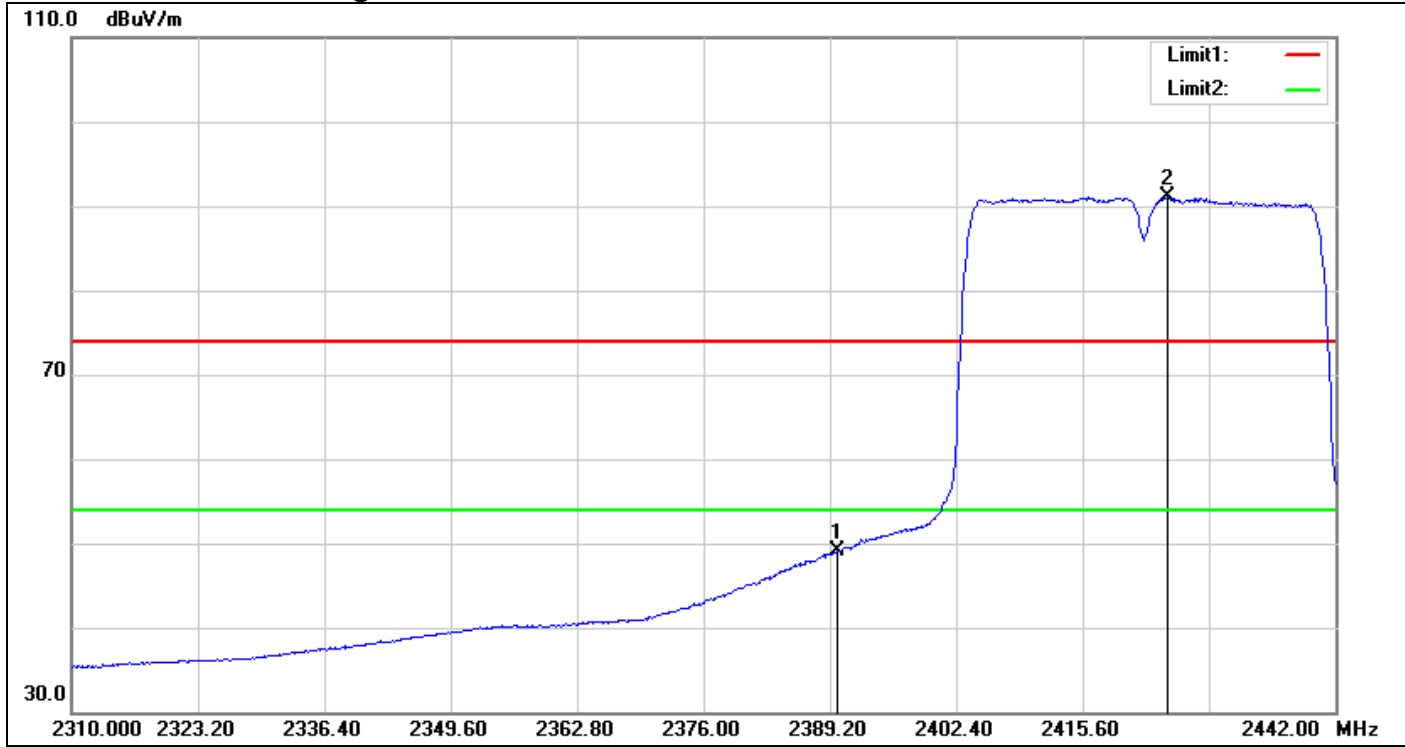

No.	Frequency (MHz)	Reading (dBuV)	Correct Factor(dB/m)	Result (dBuV/m)	Limit (dBuV/m)	Margin (dB)	Remark
1	2390.000	51.55	-2.49	49.06	54.00	-4.94	AVG
2	2424.444	93.44	-2.33	91.11	54.00	37.11	AVG

Band Edges

IEEE 802.11n HT 40 MHz Channel Mode / CH Mid

Detector mode: Peak

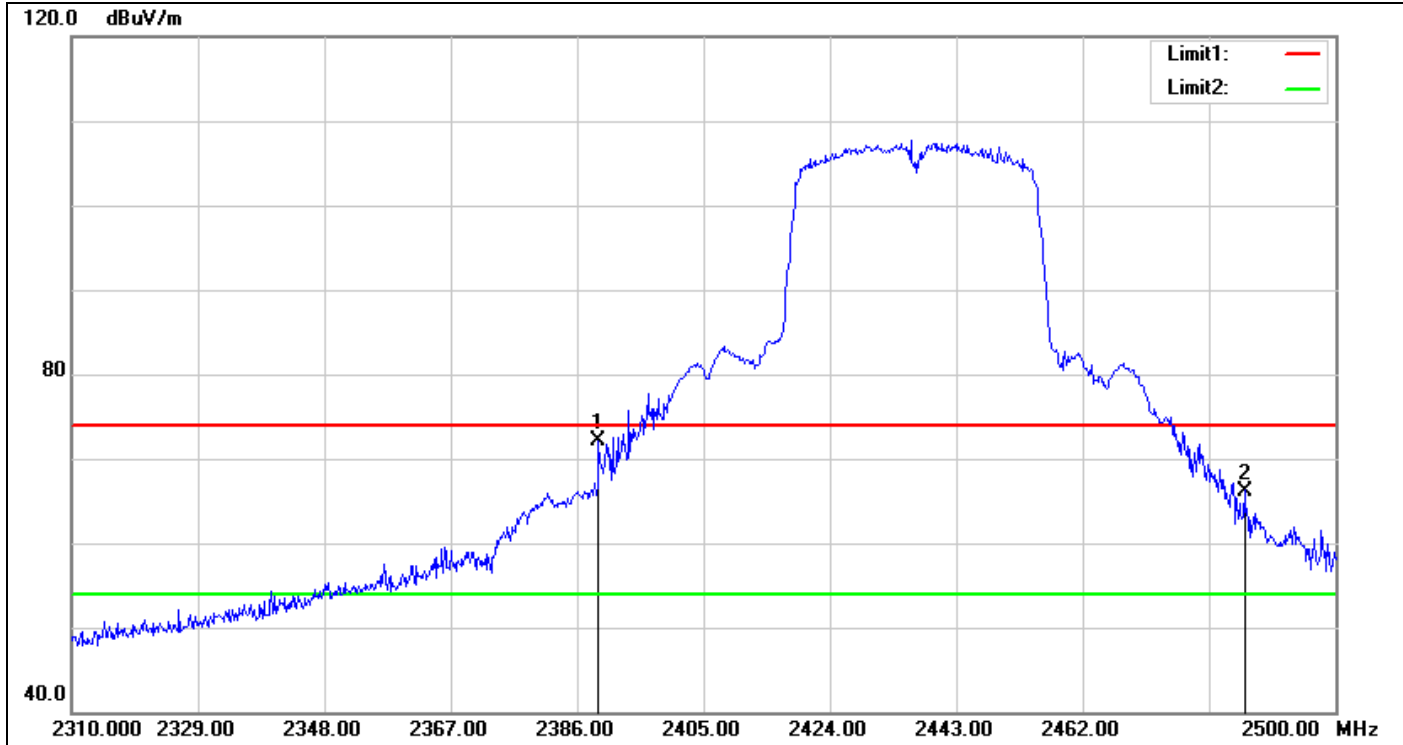

No.	Frequency (MHz)	Reading (dBuV)	Correct Factor(dB/m)	Result (dBuV/m)	Limit (dBuV/m)	Margin (dB)	Remark
1	2389.230	74.52	-2.50	72.02	74.00	-1.98	peak
2	2486.320	68.17	-1.97	66.20	74.00	-7.80	peak

Detector mode: Average

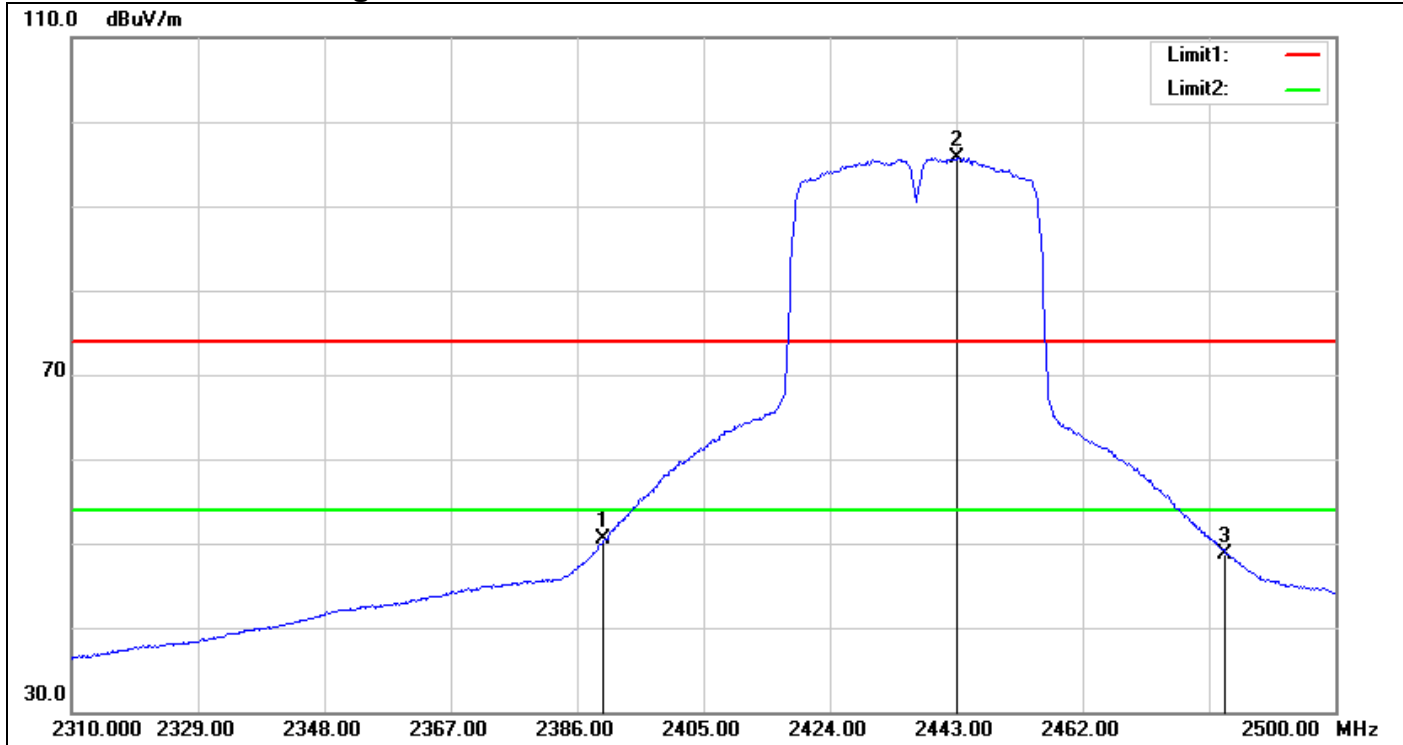

No.	Frequency (MHz)	Reading (dBuV)	Correct Factor (dB/m)	Result (dBuV/m)	Limit (dBuV/m)	Margin (dB)	Remark
1	2390.000	53.08	-2.49	50.59	54.00	-3.41	AVG
2	2443.190	97.87	-2.19	95.68	54.00	41.68	AVG
3	2483.500	50.74	-1.99	48.75	54.00	-5.25	AVG

Band Edges

IEEE 802.11n HT 40 MHz Channel Mode / CH High

Detector mode: Peak

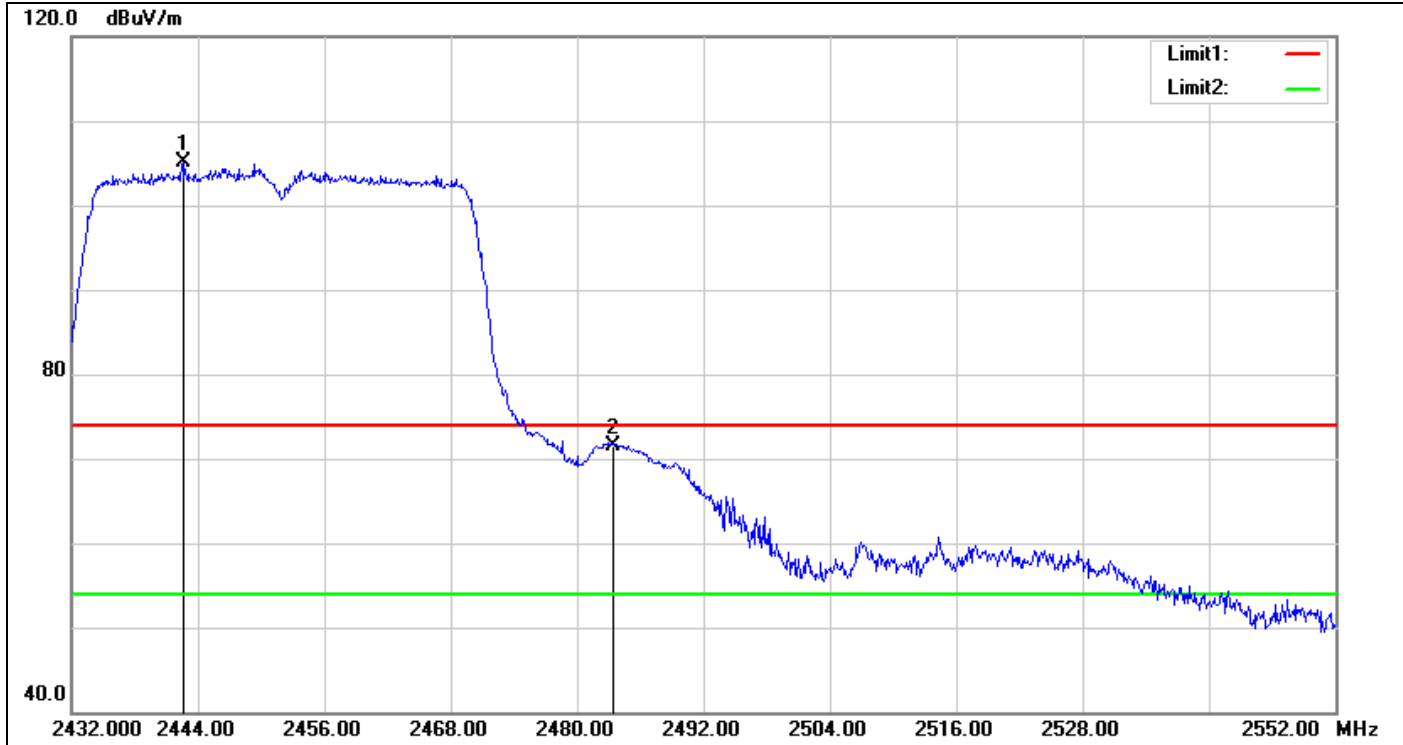

No.	Frequency (MHz)	Reading (dBuV)	Correct Factor(dB/m)	Result (dBuV/m)	Limit (dBuV/m)	Margin (dB)	Remark
1	2442.560	107.26	-2.19	105.07	74.00	31.07	peak
2	2483.500	73.51	-1.99	71.52	74.00	-2.48	peak

Detector mode: Average

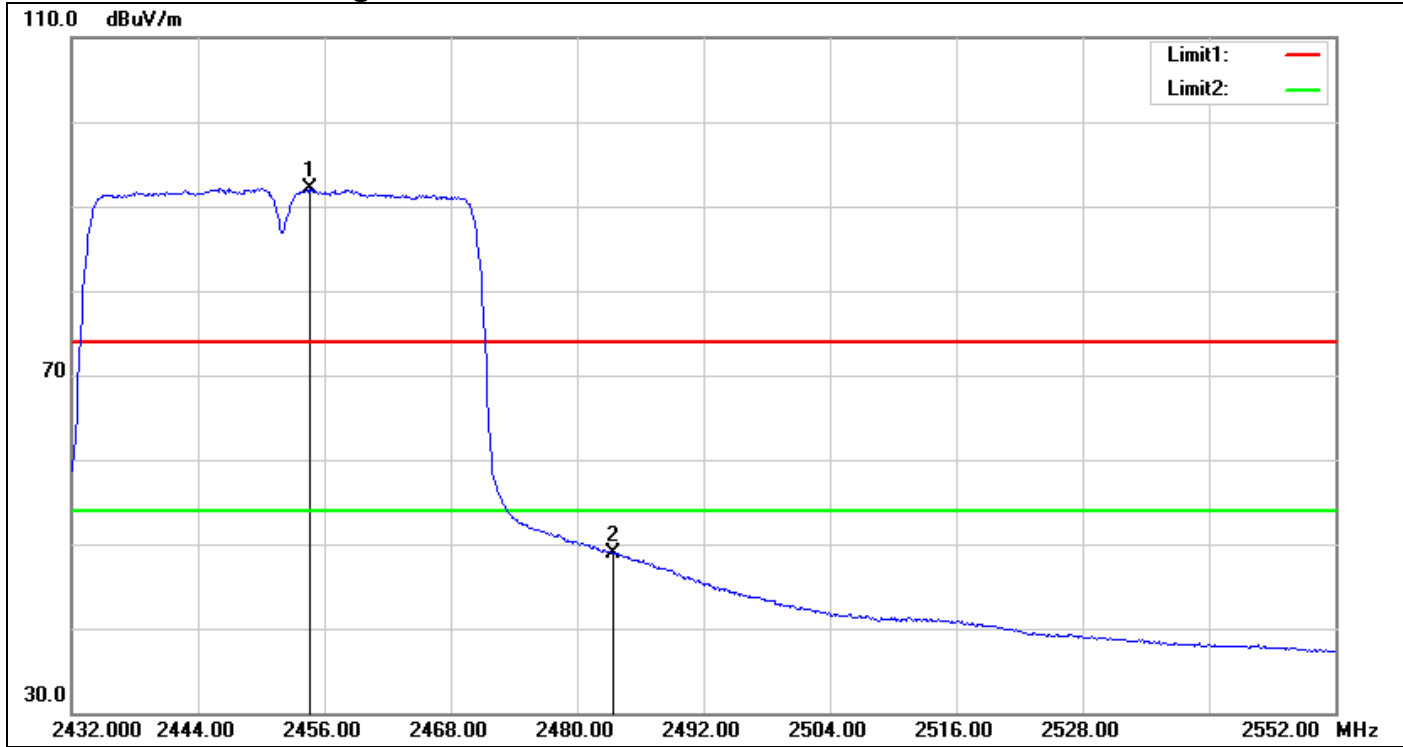

No.	Frequency (MHz)	Reading (dBuV)	Correct Factor(dB/m)	Result (dBuV/m)	Limit (dBuV/m)	Margin (dB)	Remark
1	2454.560	94.19	-2.12	92.07	54.00	38.07	AVG
2	2483.500	50.88	-1.99	48.89	54.00	-5.11	AVG

Test Plot

Un-restricted Band Emissions (IEEE 802.11b mode / CH Low)

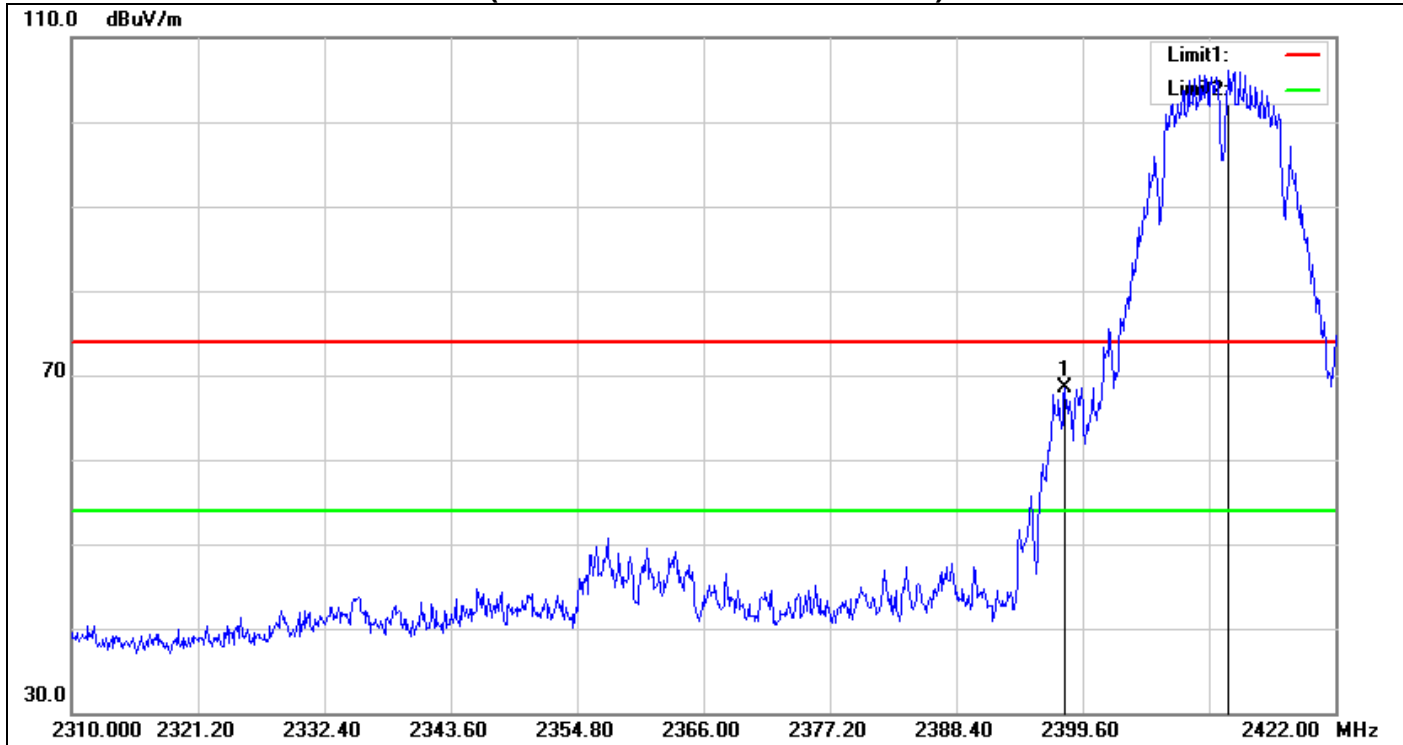

No.	Frequency (MHz)	Reading (dBuV)	Correct Factor(dB/m)	Result (dBuV/m)	Limit (dBuV/m)	Margin (dB)	Remark
1	2398.032	71.03	-2.43	68.60	74.00	-5.40	peak
2	2412.480	108.47	-2.41	106.06	74.00	32.06	peak

Note: Spurious emission levels that exceed the level of 20 dB below the applicable limit.

Un-restricted Band Emissions (IEEE 802.11b mode / CH High)

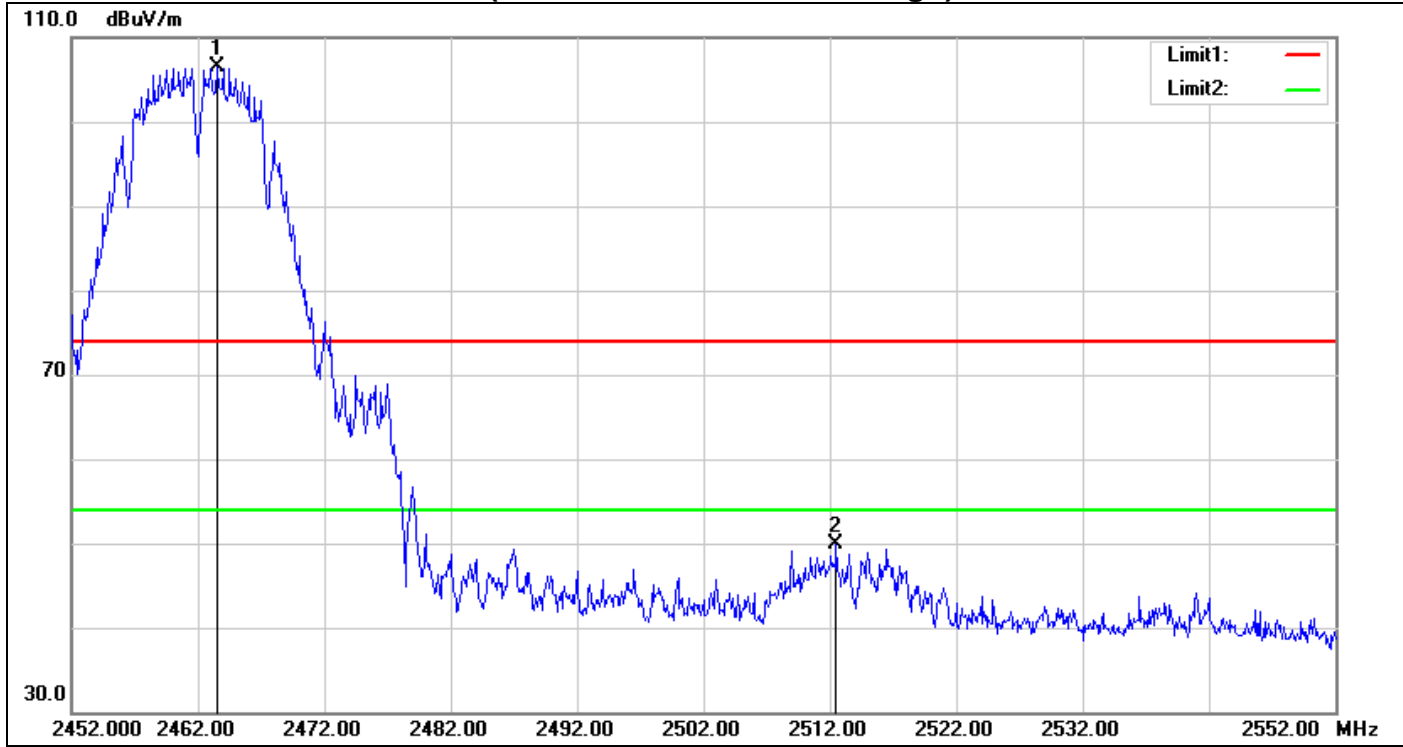

No.	Frequency (MHz)	Reading (dBuV)	Correct Factor(dB/m)	Result (dBuV/m)	Limit (dBuV/m)	Margin (dB)	Remark
1	2463.500	108.51	-2.09	106.42	74.00	32.42	peak
2	2512.500	51.73	-1.83	49.90	74.00	-24.10	peak

Note: Spurious emission levels that exceed the level of 20 dB below the applicable limit.

Un-restricted Band Emissions (IEEE 802.11g mode / CH Low)

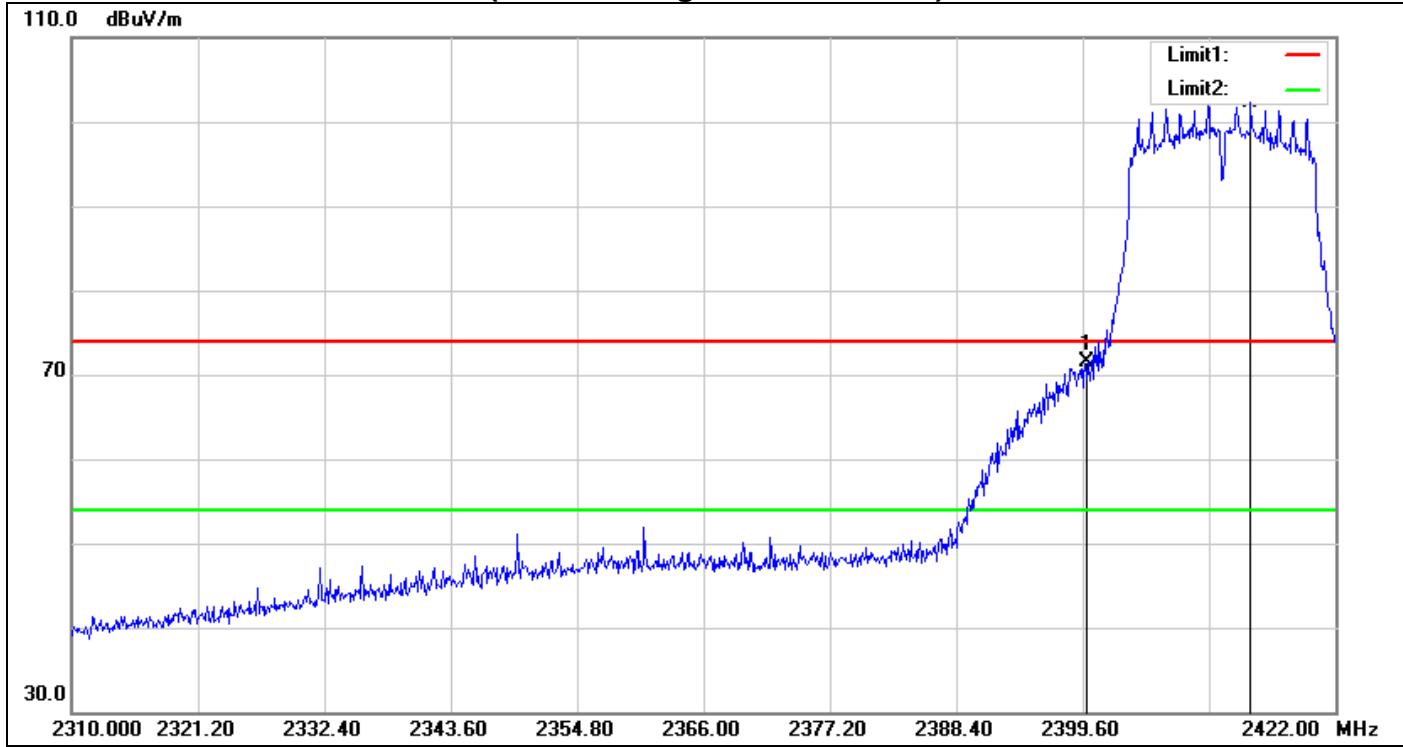

No.	Frequency (MHz)	Reading (dBuV)	Correct Factor(dB/m)	Result (dBuV/m)	Limit (dBuV/m)	Margin (dB)	Remark
1	2400.000	73.84	-2.41	71.43	74.00	-2.57	peak
2	2414.496	104.65	-2.40	102.25	74.00	28.25	peak

Note: Spurious emission levels that exceed the level of 20 dB below the applicable limit.

Un-restricted Band Emissions (IEEE 802.11g mode / CH High)

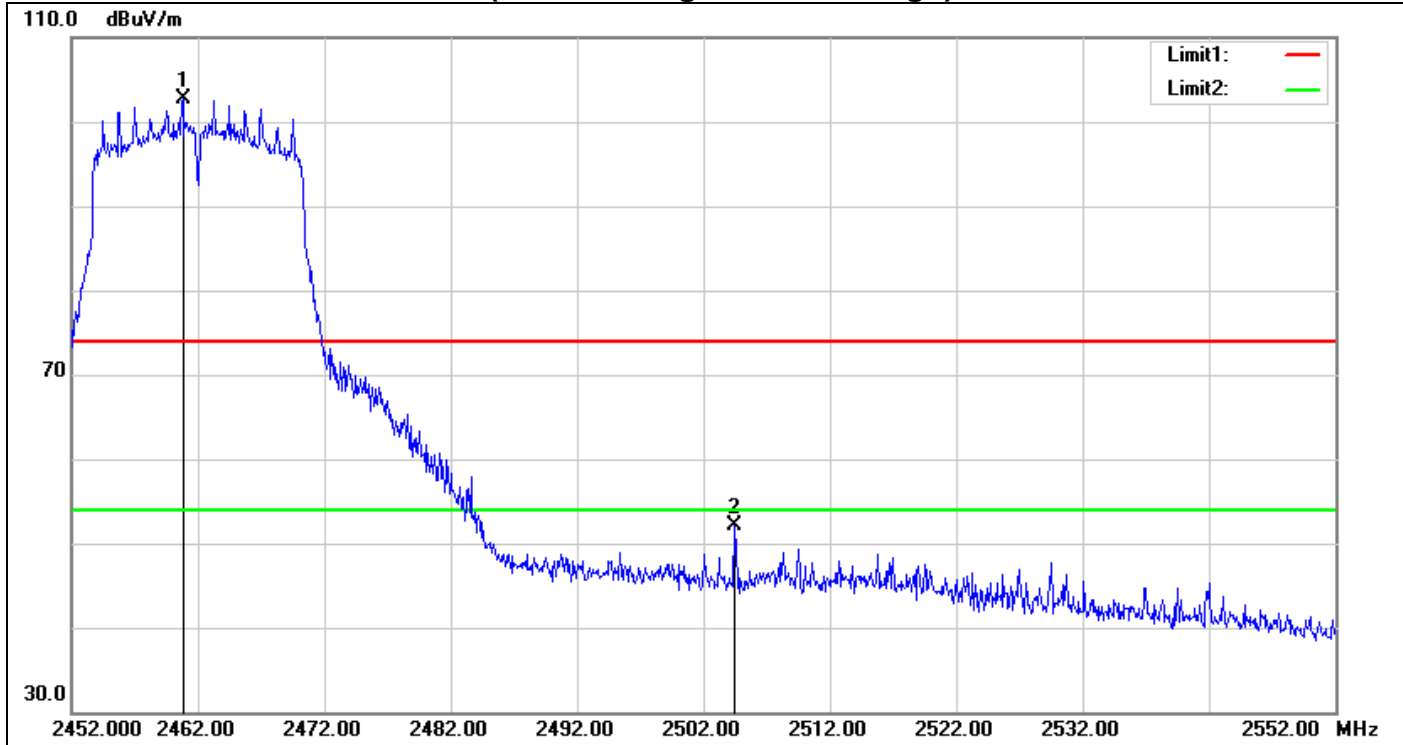

No.	Frequency (MHz)	Reading (dBuV)	Correct Factor(dB/m)	Result (dBuV/m)	Limit (dBuV/m)	Margin (dB)	Remark
1	2460.800	104.72	-2.10	102.62	74.00	28.62	peak
2	2504.400	53.92	-1.85	52.07	74.00	-21.93	peak

Note: Spurious emission levels that exceed the level of 20 dB below the applicable limit.

Un-restricted Band Emissions (IEEE 802.11n HT 20 MHz mode / CH Low)

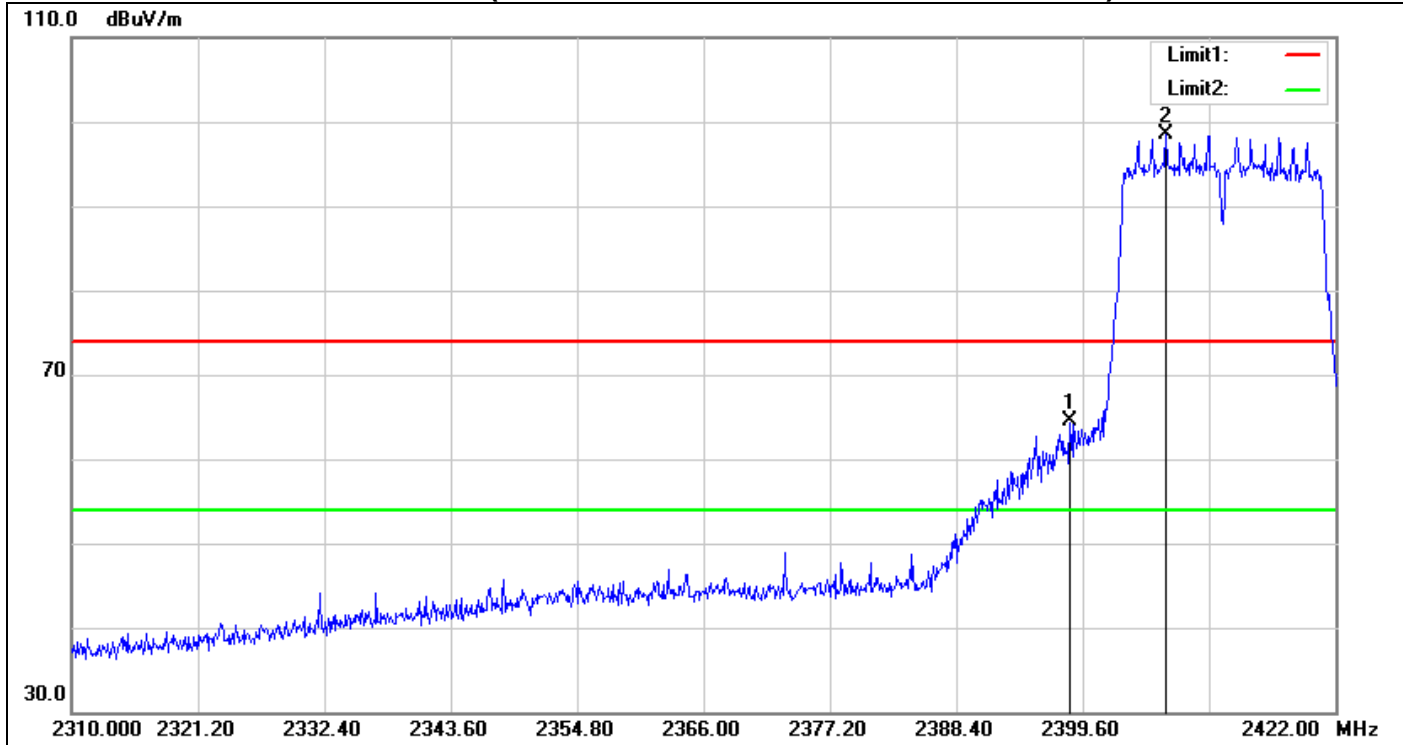

No.	Frequency (MHz)	Reading (dBuV)	Correct Factor(dB/m)	Result (dBuV/m)	Limit (dBuV/m)	Margin (dB)	Remark
1	2398.480	66.82	-2.42	64.40	74.00	-9.60	peak
2	2406.992	100.90	-2.42	98.48	74.00	24.48	peak

Note: Spurious emission levels that exceed the level of 20 dB below the applicable limit.

Un-restricted Band Emissions (IEEE 802.11n HT 20 MHz mode / CH High)

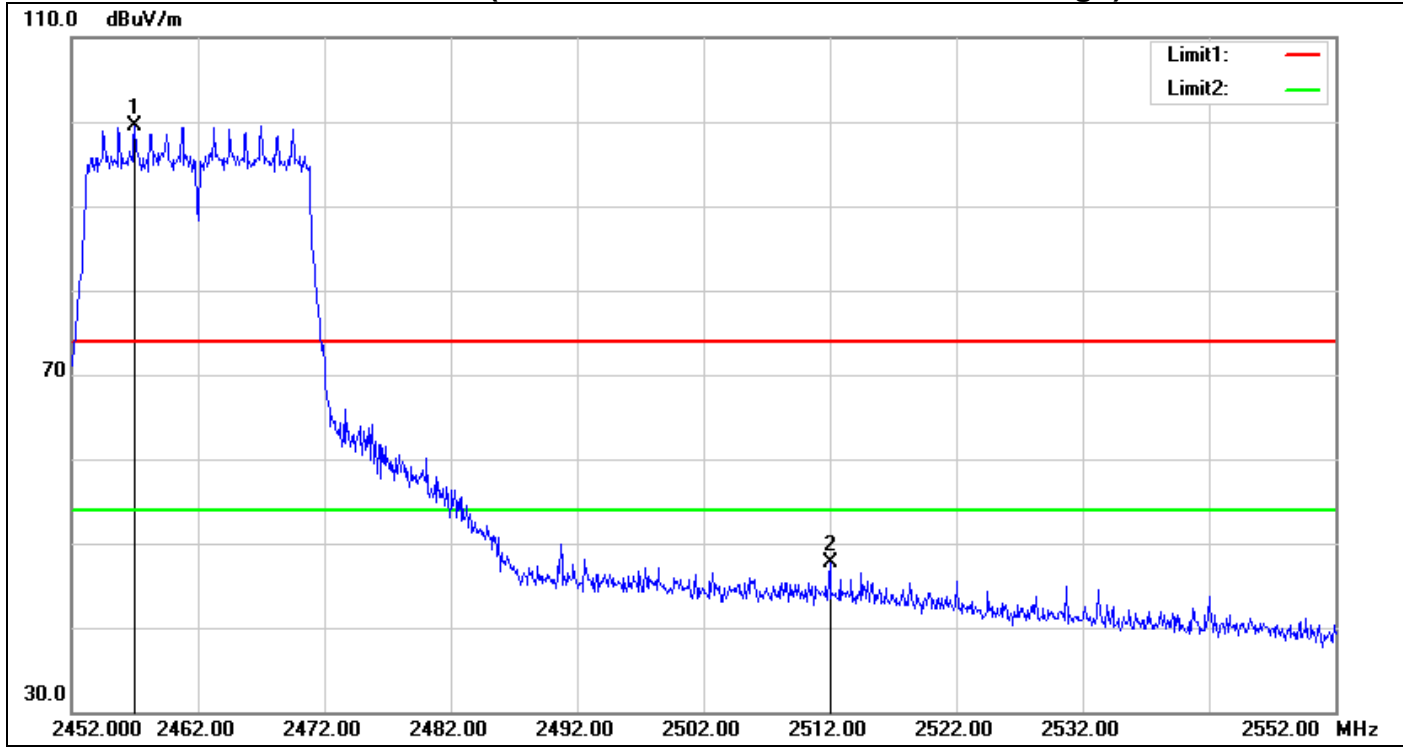

No.	Frequency (MHz)	Reading (dBuV)	Correct Factor(dB/m)	Result (dBuV/m)	Limit (dBuV/m)	Margin (dB)	Remark
1	2457.000	101.64	-2.11	99.53	74.00	25.53	peak
2	2512.000	49.51	-1.83	47.68	74.00	-26.32	peak

Note: Spurious emission levels that exceed the level of 20 dB below the applicable limit.

Un-restricted Band Emissions (IEEE 802.11n HT 40 MHz mode / CH Low)

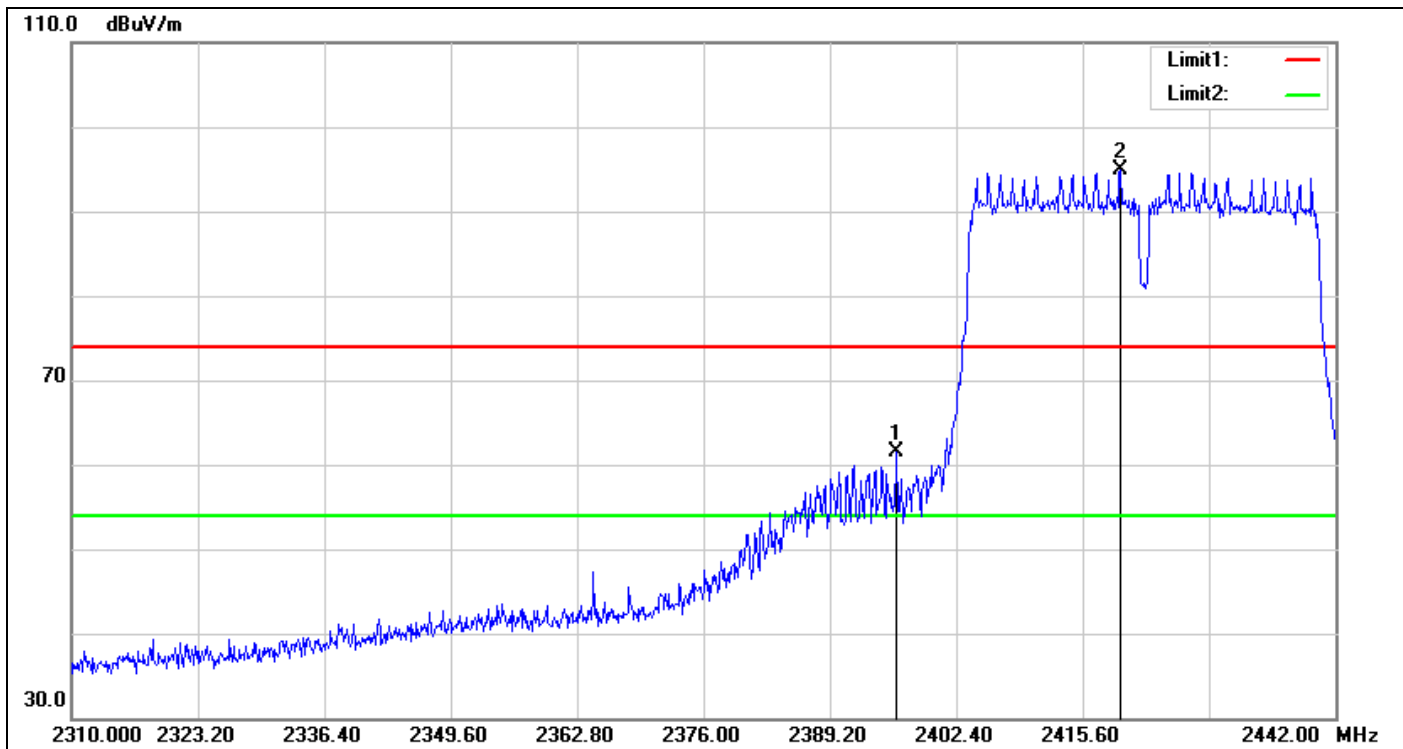

No.	Frequency (MHz)	Reading (dBuV)	Correct Factor(dB/m)	Result (dBuV/m)	Limit (dBuV/m)	Margin (dB)	Remark
1	2396.196	63.99	-2.44	61.55	74.00	-12.45	peak
2	2419.560	97.17	-2.36	94.81	74.00	20.81	peak

Note: Spurious emission levels that exceed the level of 20 dB below the applicable limit.

Un-restricted Band Emissions (IEEE 802.11n HT 40 MHz mode / CH High)

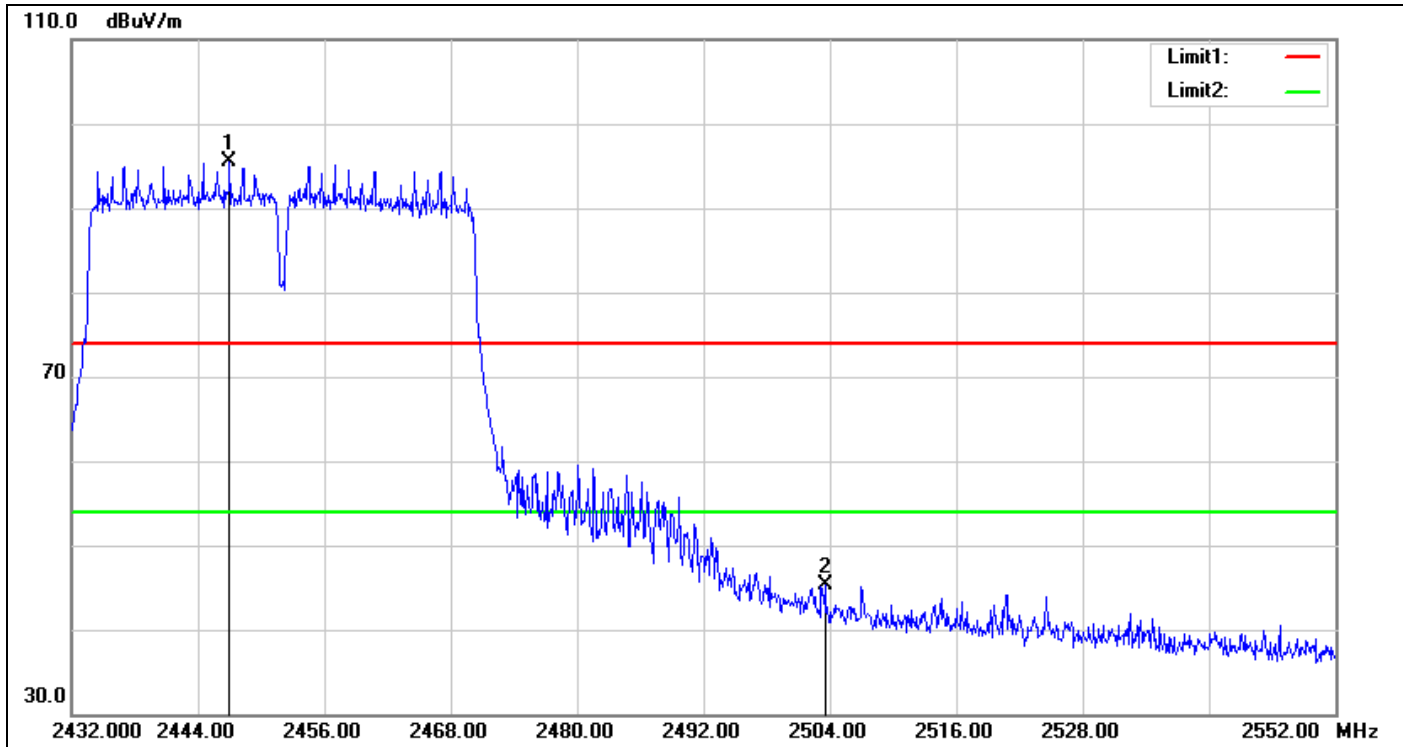

No.	Frequency (MHz)	Reading (dBuV)	Correct Factor(dB/m)	Result (dBuV/m)	Limit (dBuV/m)	Margin (dB)	Remark
1	2447.000	97.65	-2.16	95.49	74.00	21.49	peak
2	2503.520	47.08	-1.85	45.23	74.00	-28.77	peak

Note: Spurious emission levels that exceed the level of 20 dB below the applicable limit.

7.6 PEAK POWER SPECTRAL DENSITY

LIMIT

1. According to §15.247(e) & RSS-247, for digitally modulated systems, the power spectral density conducted from the intentional radiator to the antenna shall not be greater than 8 dBm in any 3 kHz band during any time interval of continuous transmission.
2. According to §15.247(f) & RSS-247, the digital modulation operation of the hybrid system, with the frequency hopping turned off, shall comply with the power density requirements of paragraph (d) of this section.

Test Configuration

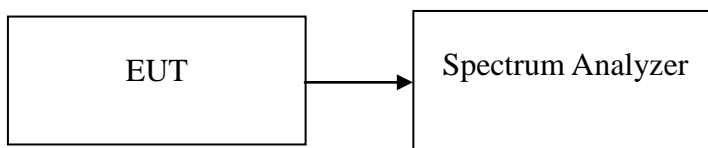

TEST PROCEDURE

1. Place the EUT on the table and set it in transmitting mode. Remove the antenna from the EUT and then connect a low loss RF cable from the antenna port to the spectrum analyzer.
2. Set the spectrum analyzer as RBW = 3 kHz, VBW = 30 kHz, Span = 1.5MHz, Sweep time = 100 s
3. Record the max reading.
4. Repeat the above procedure until the measurements for all frequencies are completed.

TEST RESULTS

No non-compliance noted

Test Data

IEEE 802.11b mode

Channel	Frequency (MHz)	PPSD (dBm)	Limit (dBm)	Result
Low	2412	-11.88	8.00	PASS
Mid	2437	-11.91		PASS
High	2462	-11.86		PASS

IEEE 802.11g mode

Channel	Frequency (MHz)	PPSD (dBm)	Limit (dBm)	Result
Low	2412	-12.77	8.00	PASS
Mid	2437	-12.36		PASS
High	2462	-12.05		PASS

IEEE 802.11n HT 20 MHz mode

Channel	Frequency (MHz)	PPSD (dBm)	Limit (dBm)	Result
Low	2412	-16.77	8.00	PASS
Mid	2437	-12.41		PASS
High	2462	-17.20		PASS

IEEE 802.11n HT 40 MHz mode

Channel	Frequency (MHz)	PPSD (dBm)	Limit (dBm)	Result
Low	2422	-17.50	8.00	PASS
Mid	2437	-15.37		PASS
High	2452	-19.61		PASS

Test Plot

IEEE 802.11b mode

PPSD (CH Low)

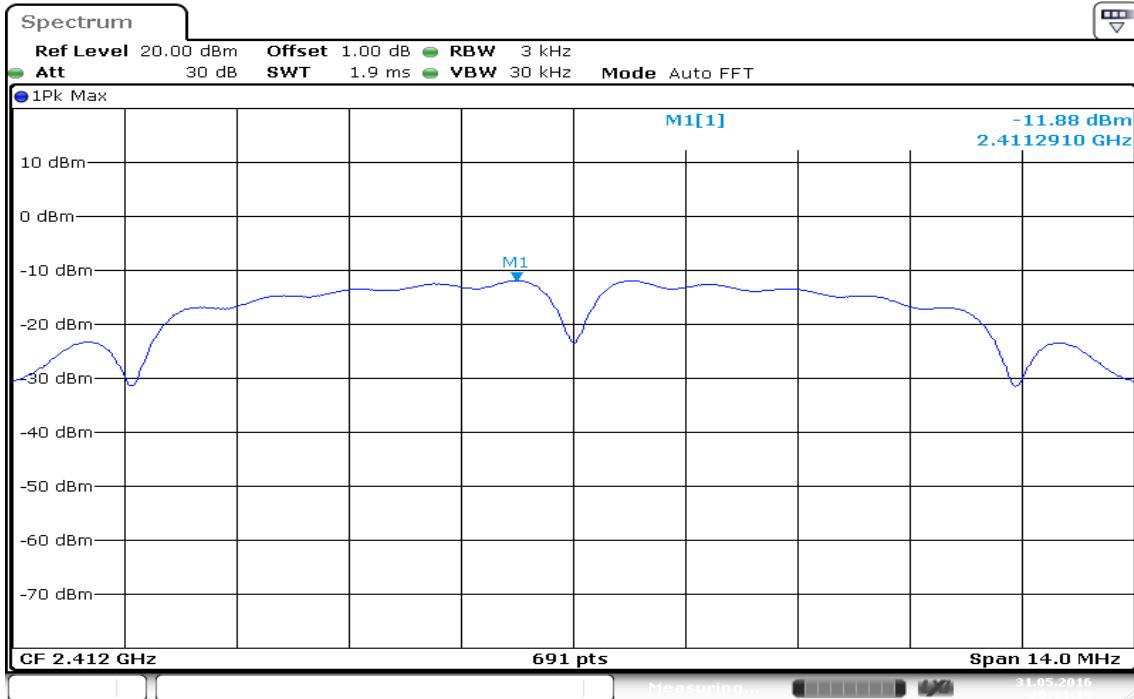

Date: 31.MAY.2016 20:33:15

PPSD (CH Mid)

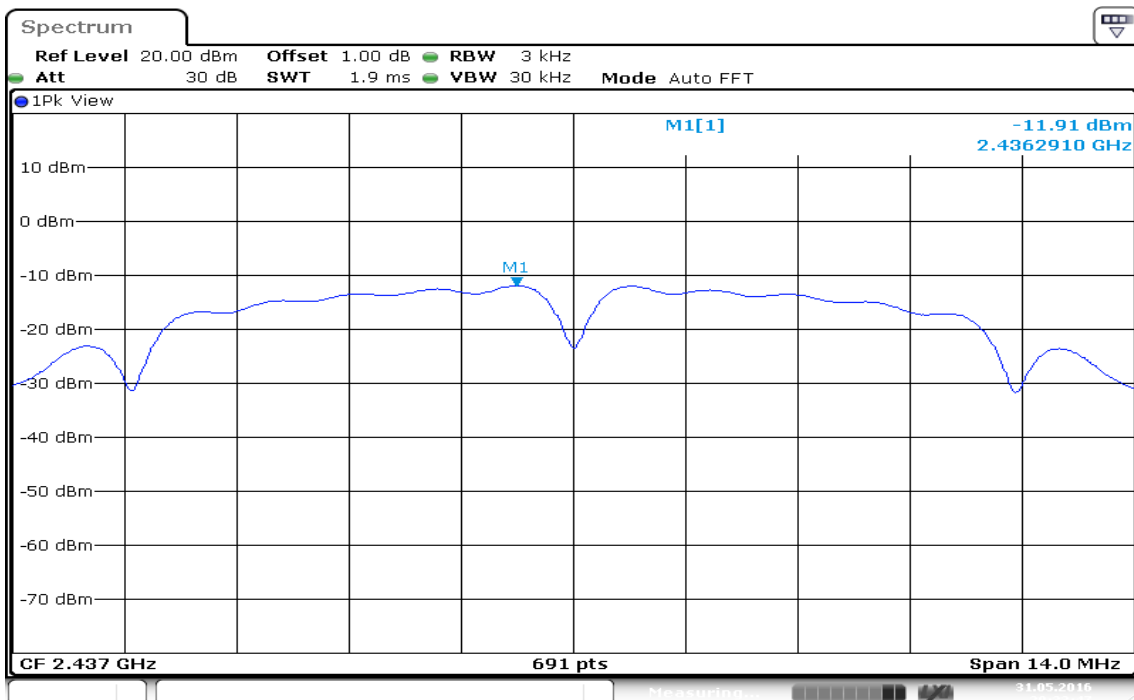

Date: 31.MAY.2016 20:33:47

PPSD (CH High)

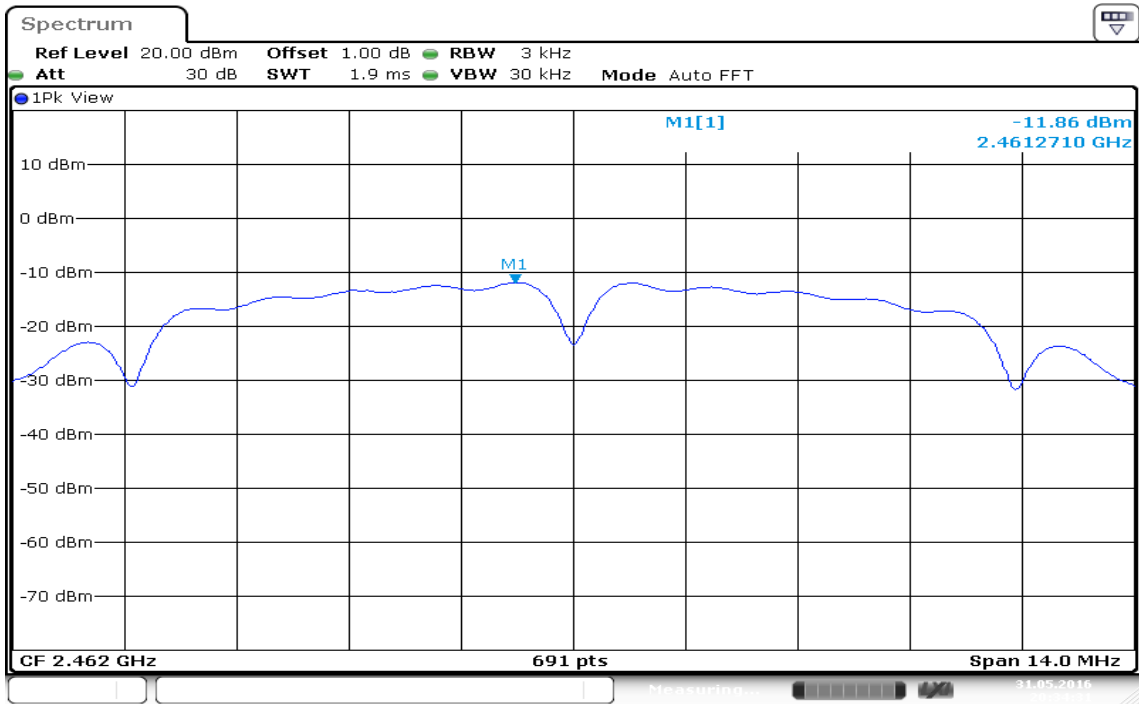

Date: 31.MAY.2016 20:34:32

IEEE 802.11g mode

PPSD (CH Low)

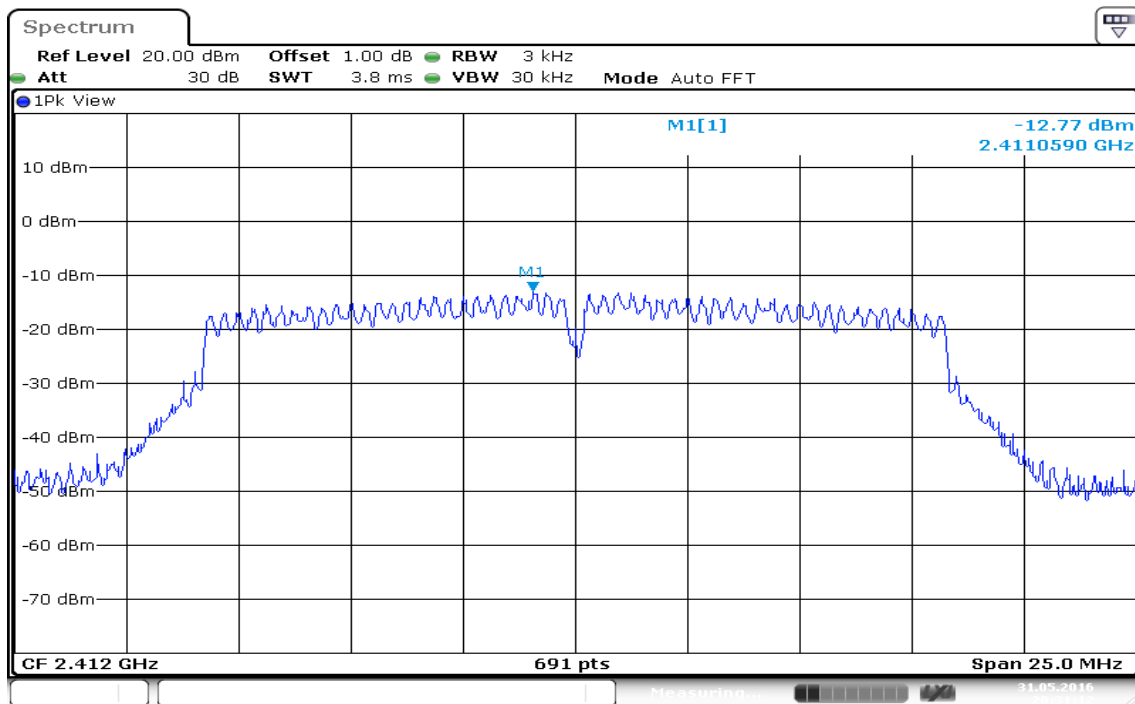

PPSD (CH Mid)

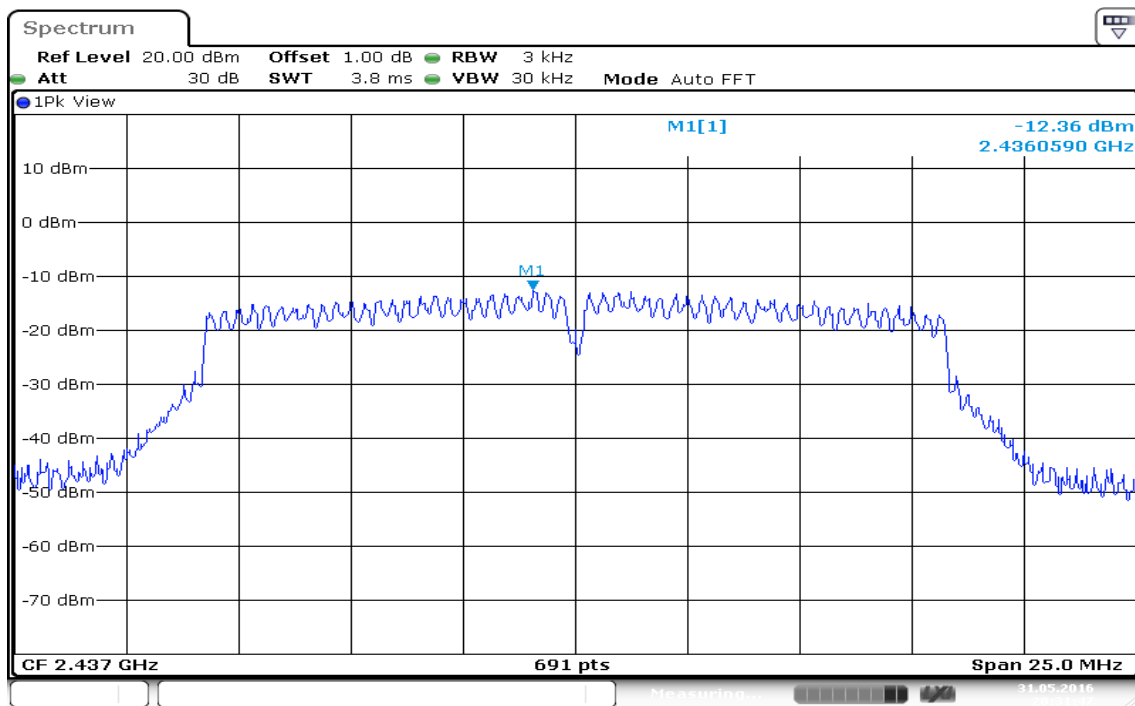

PPSD (CH High)

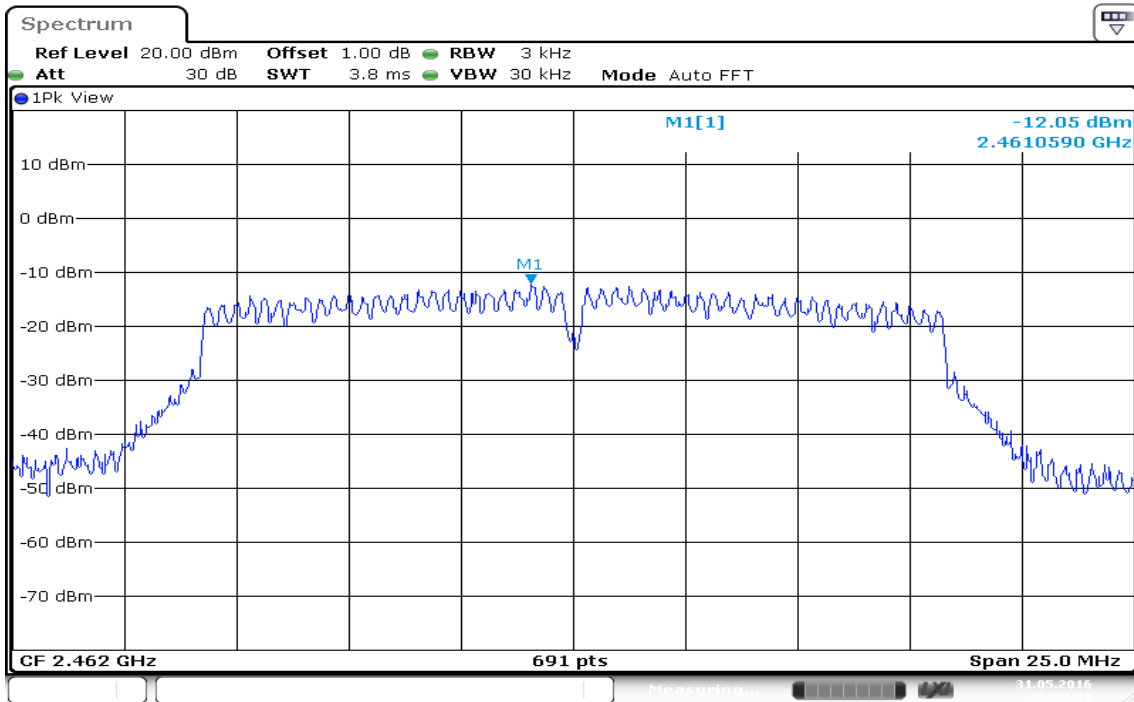

Date: 31.MAY.2016 20:32:24

IEEE 802.11n HT 20 MHz mode

PPSD (CH Low)

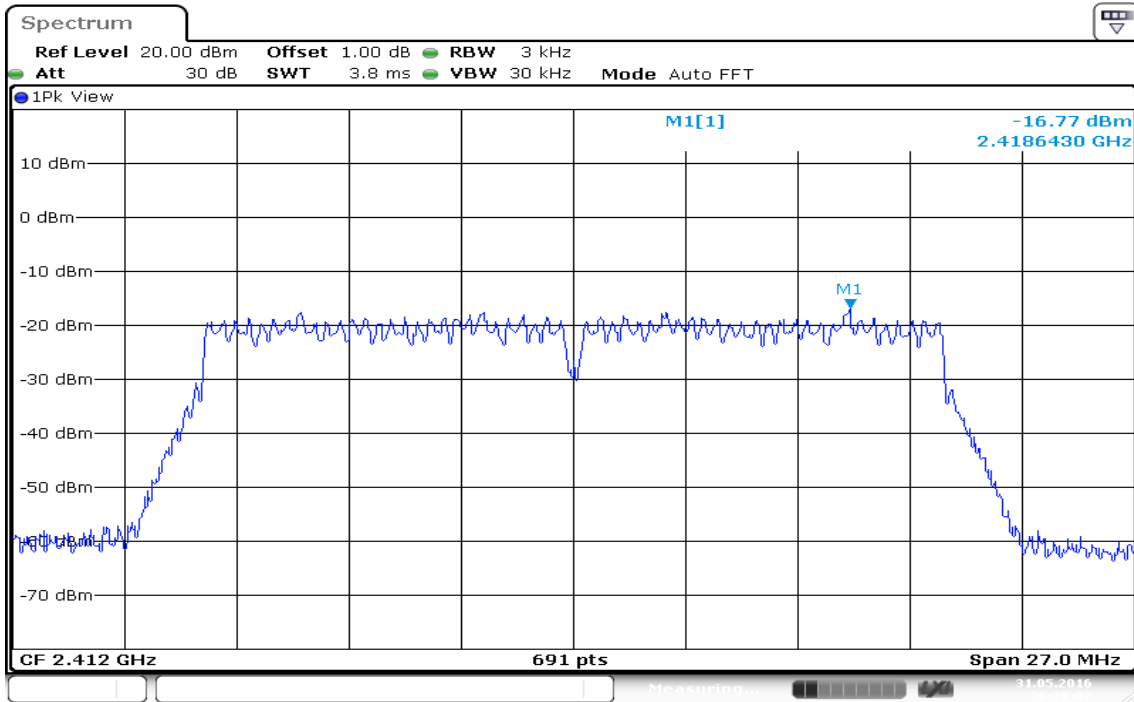

Date: 31.MAY.2016 20:29:02

PPSD (CH Mid)

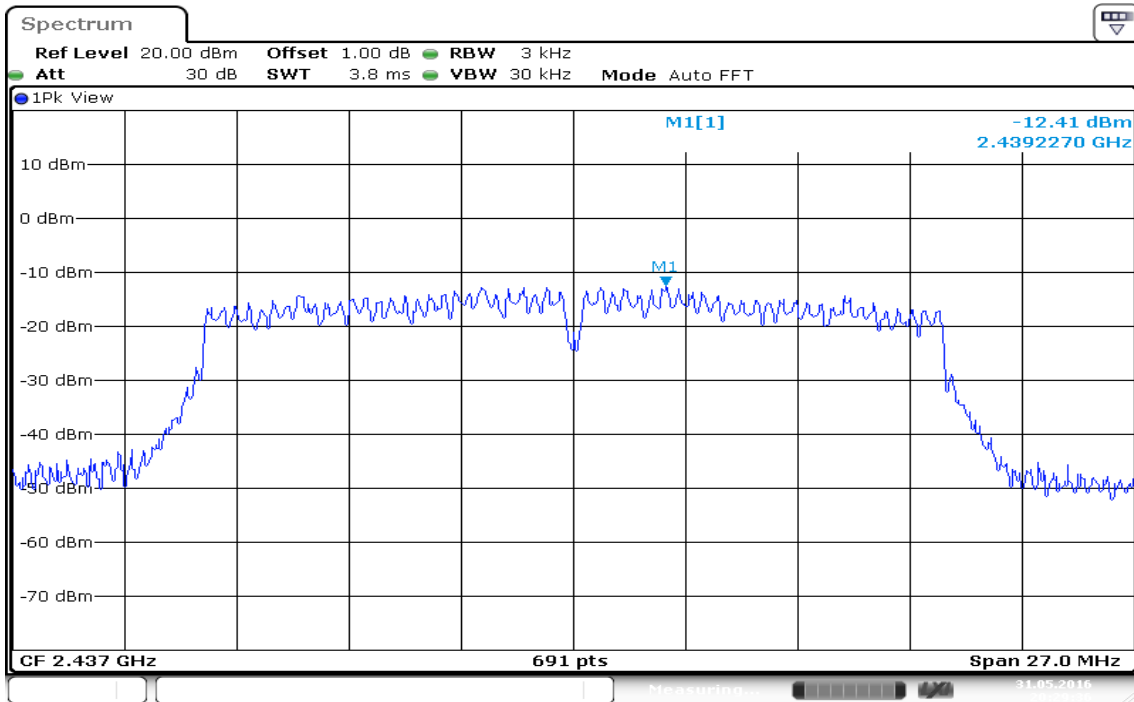

Date: 31.MAY.2016 20:29:36

PPSD (CH High)

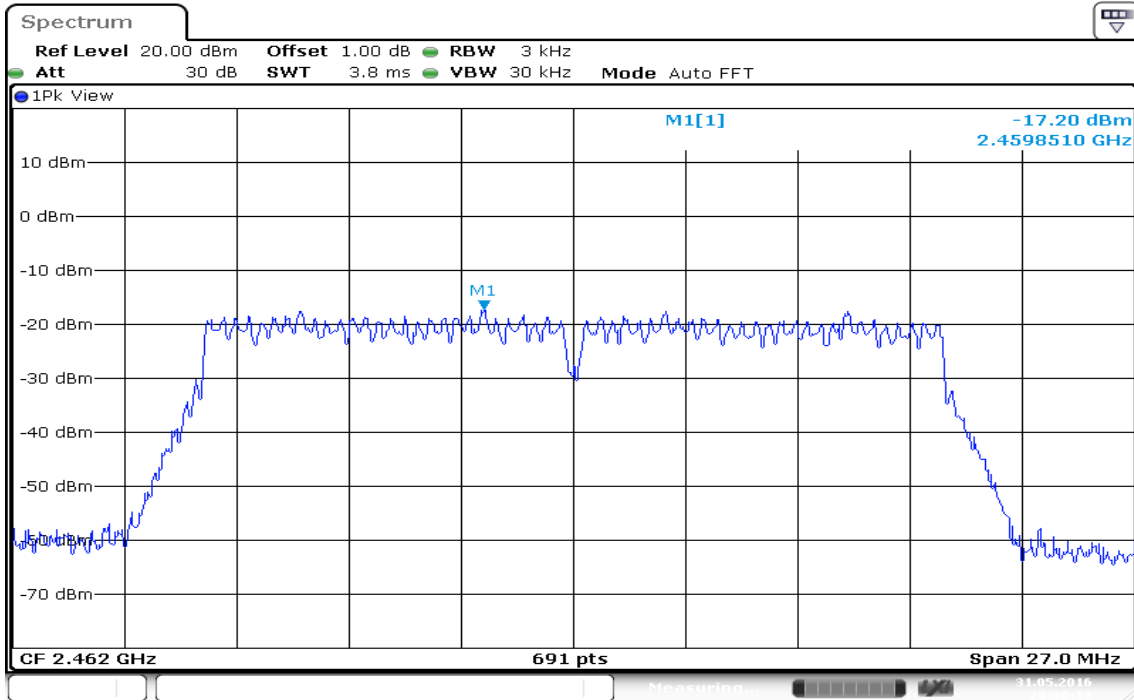

Date: 31.MAY.2016 20:30:12

IEEE 802.11n HT 40 MHz mode

PPSD (CH Low)

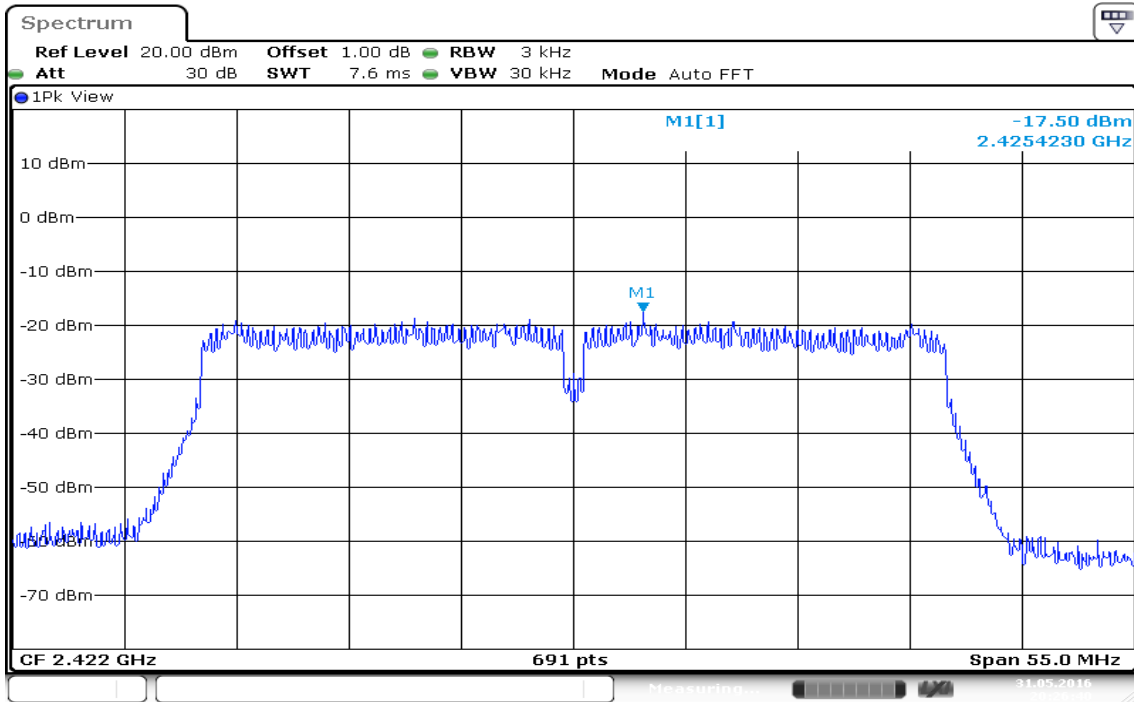

PPSD (CH Mid)

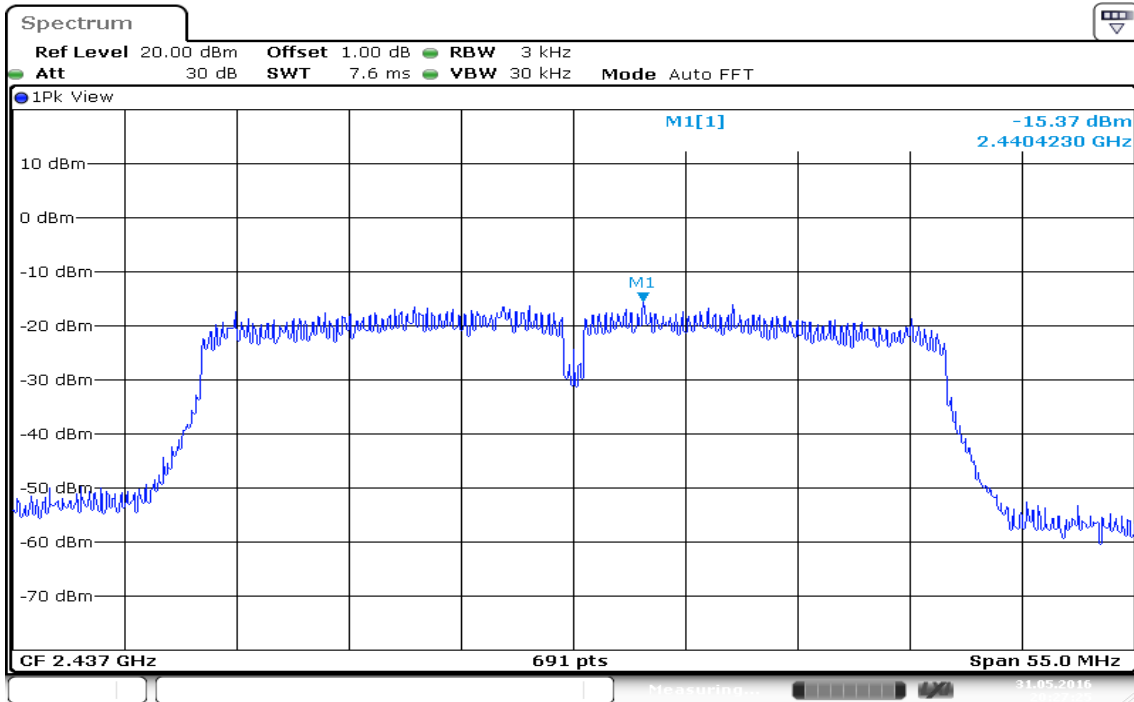

PPSD (CH High)

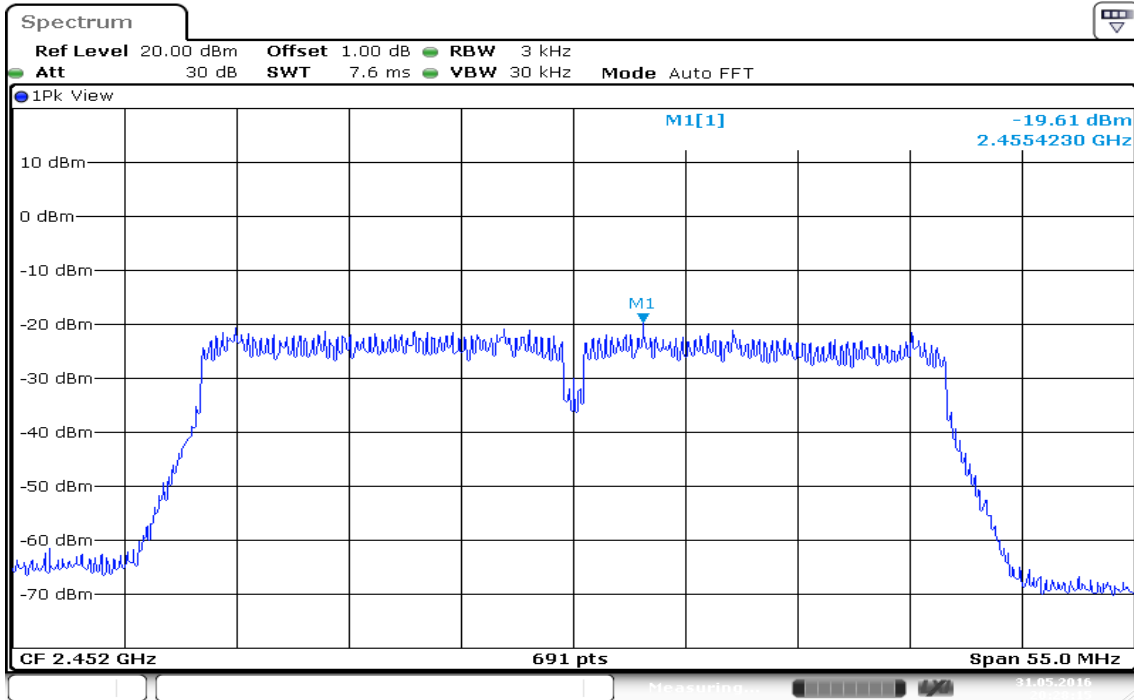

Date: 31.MAY.2016 20:28:15

7.7 RADIATED EMISSIONS

LIMIT

All spurious emissions shall comply with the limits of §15.209(a) and RSS-Gen Table 2 & Table 5.

RSS-Gen Table 2 & Table 5: General Field Strength Limits for Transmitters and Receivers at Frequencies Above 30 MHz ^(Note)

Frequency (MHz)	Field Strength microvolts/m at 3 metres (watts, e.i.r.p.)	
	Transmitters	Receivers
30-88	100 (3 nW)	100 (3 nW)
88-216	150 (6.8 nW)	150 (6.8 nW)
216-960	200 (12 nW)	200 (12 nW)
Above 960	500 (75 nW)	500 (75 nW)

Note: *Measurements for compliance with limits in the above table may be performed at distances other than 3 metres, in accordance with Section 7.2.7.

Transmitting devices are not permitted in Table 1 bands or, unless stated otherwise, in TV bands (54-72 MHz, 76-88 MHz, 174-216 MHz, 470-608 MHz and 614-806 MHz).

RSS-Gen Table 6: General Field Strength Limits for Transmitters at Frequencies Below 30 MHz (Transmit)

Frequency	Field Strength (microvolts/m)	Magnetic H-Field (microamperes/m)	Measurement Distance (metres)
9-490 kHz	2,400/F (F in kHz)	2,400/377F (F in kHz)	3000
490-1,705 kHz	24,000/F (F in kHz)	24,000/377F (F in kHz)	30
1.705-30 MHz	30	N/A	30

Note: The emission limits for the bands 9-90 kHz and 110-490 kHz are based on measurements employing an average detector.

Test Configuration

9kHz ~ 30MHz

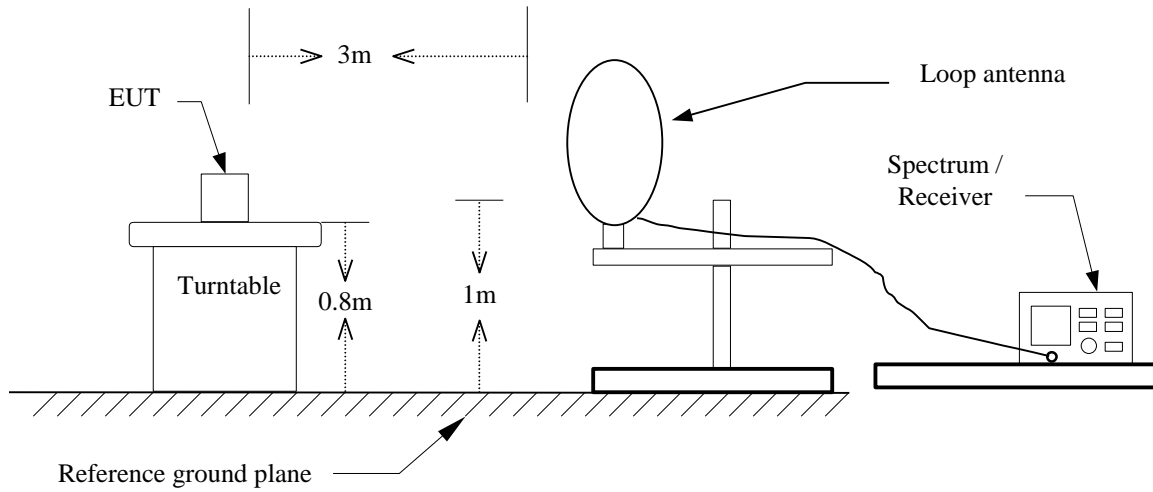

30MHz ~ 1GHz

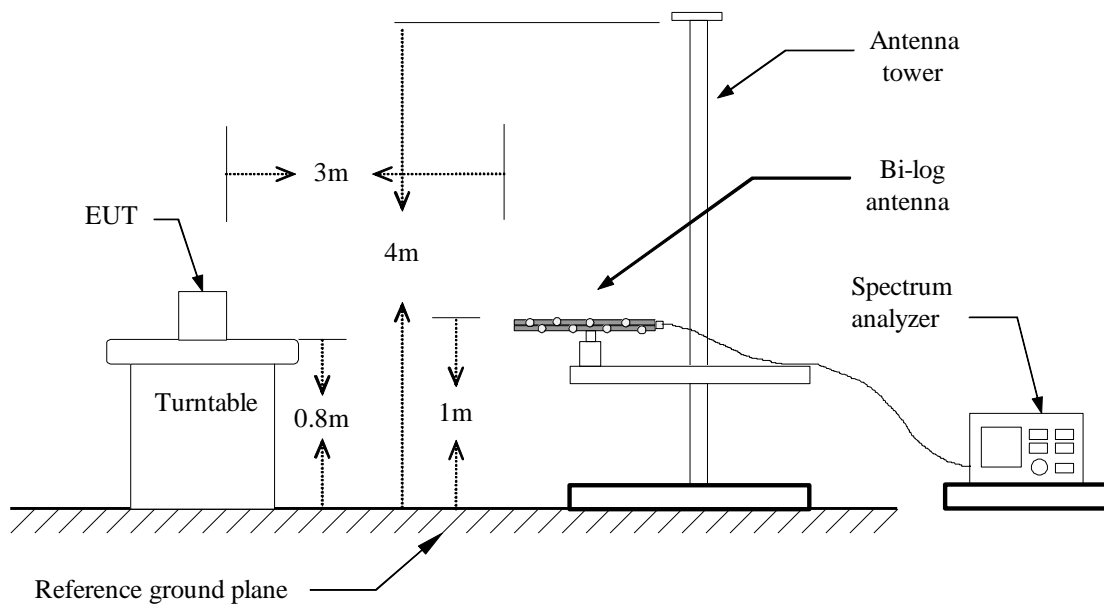

Above 1 GHz

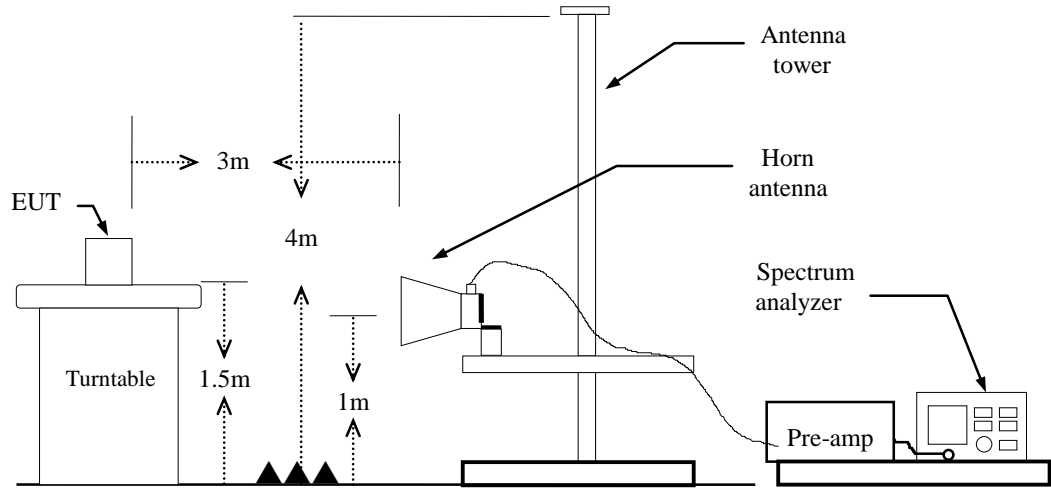

TEST PROCEDURE

1. The EUT is placed on a turntable, Above 1 GHz is 1.5m high and below 1 GHz is 0.8m high above ground plane.
2. The turntable shall be rotated for 360 degrees to determine the position of maximum emission level.
3. EUT is set 3m away from the receiving antenna, which is varied from 1m to 4m to find out the highest emissions.
4. Maximum procedure was performed on the six highest emissions to ensure EUT compliance.
5. And also, each emission was to be maximized by changing the polarization of receiving antenna both horizontal and vertical.
6. Set the spectrum analyzer in the following setting as:

Below 1GHz:

RBW=100kHz / VBW=300kHz / Sweep=AUTO

Above 1GHz:

(a) PEAK: RBW=1MHz / VBW=3MHz / Sweep=AUTO

(b) AVERAGE: RBW=1MHz,

if duty cycle $\geq 98\%$, VBW=10Hz.

if duty cycle $< 98\%$ VBW=1/T.

IEEE 802.11b mode: $\geq 98\%$, VBW=10Hz

IEEE 802.11g mode: $\geq 98\%$, VBW=10Hz

IEEE 802.11n HT 20 MHz mode: $\geq 98\%$, VBW=10Hz

IEEE 802.11n HT 40 MHz mode: $\geq 98\%$, VBW=10Hz

7. Repeat above procedures until the measurements for all frequencies are complete.
8. Result = Spectrum Reading + cable loss(spectrum to Amp) - Amp Gain + Cable loss(Amp to receive Ant)+ Receive Ant

Note: We checked every harmonics frequencies from Fundamental frequencies with reduced VBW, and we mark a point to prove pass or not if we find any emission. For this case, there are no emissions hidden in the noise floor.

Below 1GHz

Operation Mode: Normal Link

Test Date: June 2, 2016

Temperature: 27°C

Tested by: Dennis Li

Humidity: 53% RH

Polarity: Ver.

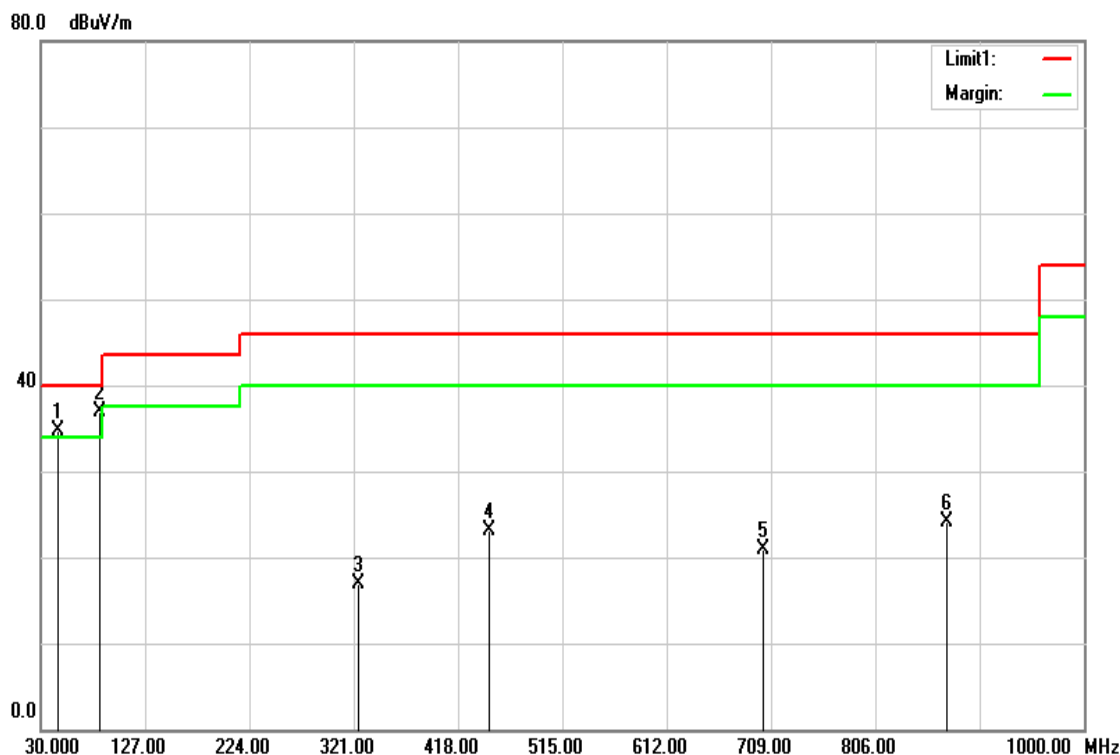

Frequency (MHz)	Reading (dBuV)	Correction Factor (dB/m)	Result (dBuV/m)	Limit (dBuV/m)	Margin (dB)	Remark	Ant. Pol. (H/V)
46.4900	53.77	-19.06	34.71	40.00	-5.29	peak	V
85.2900	58.29	-21.38	36.91	40.00	-3.09	peak	V
324.8800	30.40	-13.57	16.83	46.00	-29.17	peak	V
447.1000	33.41	-10.28	23.13	46.00	-22.87	peak	V
701.2400	27.00	-6.04	20.96	46.00	-25.04	peak	V
872.9300	27.57	-3.51	24.06	46.00	-21.94	peak	V

Remark:

1. Measuring frequencies from 30 MHz to the 1GHz.
2. Radiated emissions measured in frequency range from 30 MHz to 1000MHz were made with an instrument using peak/quasi-peak detector mode.
3. Quasi-peak test would be performed if the peak result were greater than the quasi-peak limit or as required by the applicant.
4. Measurements above show only up to 6 maximum emissions noted, or would be lesser, with " N/A " remark, if no specific emissions from the EUT are recorded (ie: margin>20dB from the applicable limit) and considered that's already beyond the background noise floor.
5. Margin (dB) = Result (dBuV/m) – Limit (dBuV/m).

Operation Mode: Normal Link

Test Date: June 2, 2016

Temperature: 27°C

Tested by: Dennis Li

Humidity: 53% RH

Polarity: Hor.

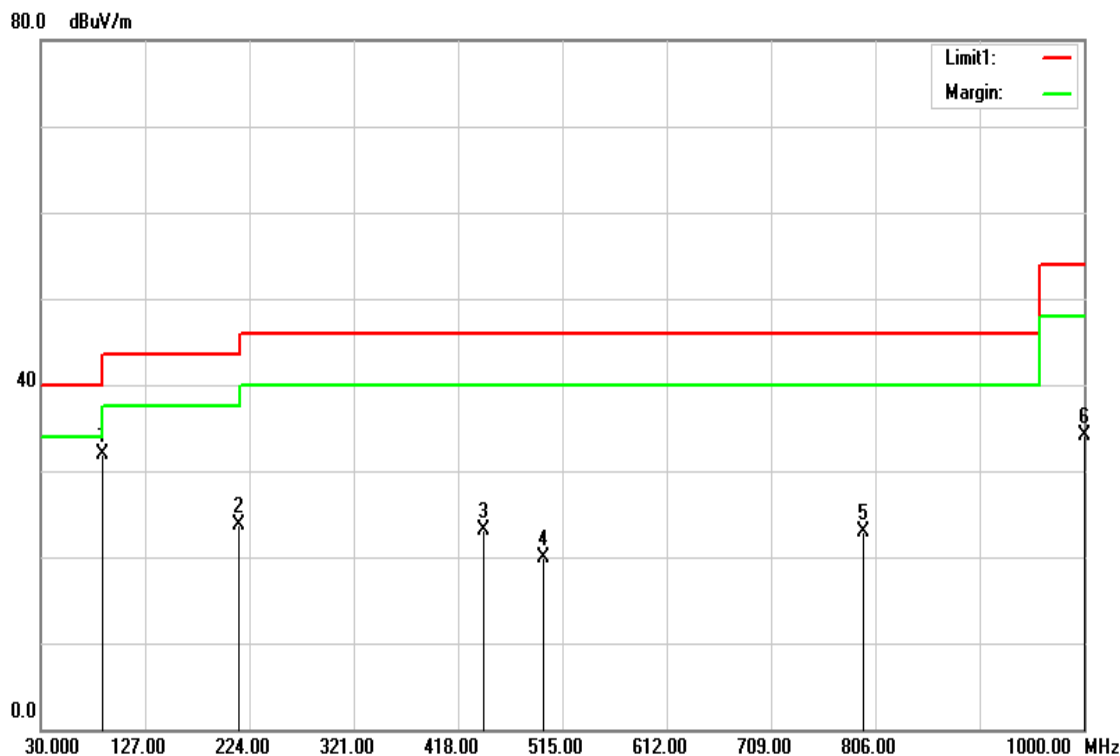

Frequency (MHz)	Reading (dBuV)	Correction Factor (dB/m)	Result (dBuV/m)	Limit (dBuV/m)	Margin (dB)	Remark	Ant. Pol. (H/V)
87.2300	53.42	-21.43	31.99	40.00	-8.01	peak	H
214.3000	40.29	-16.56	23.73	43.50	-19.77	peak	H
442.2500	33.54	-10.42	23.12	46.00	-22.88	peak	H
497.5400	29.28	-9.29	19.99	46.00	-26.01	peak	H
795.3300	27.50	-4.54	22.96	46.00	-23.04	peak	H
1000.0000	35.68	-1.58	34.10	54.00	-19.90	peak	H

Remark:

1. Measuring frequencies from 30 MHz to the 1GHz.
2. Radiated emissions measured in frequency range from 30 MHz to 1000MHz were made with an instrument using peak/quasi-peak detector mode.
3. Quasi-peak test would be performed if the peak result were greater than the quasi-peak limit or as required by the applicant.
4. Measurements above show only up to 6 maximum emissions noted, or would be lesser, with " N/A " remark, if no specific emissions from the EUT are recorded (ie: margin>20dB from the applicable limit) and considered that's already beyond the background noise floor.
5. Margin (dB) = Result (dBuV/m) – Limit (dBuV/m).

Above 1 GHz

TX / IEEE 802.11b / CH Low

Polarity: Vertical

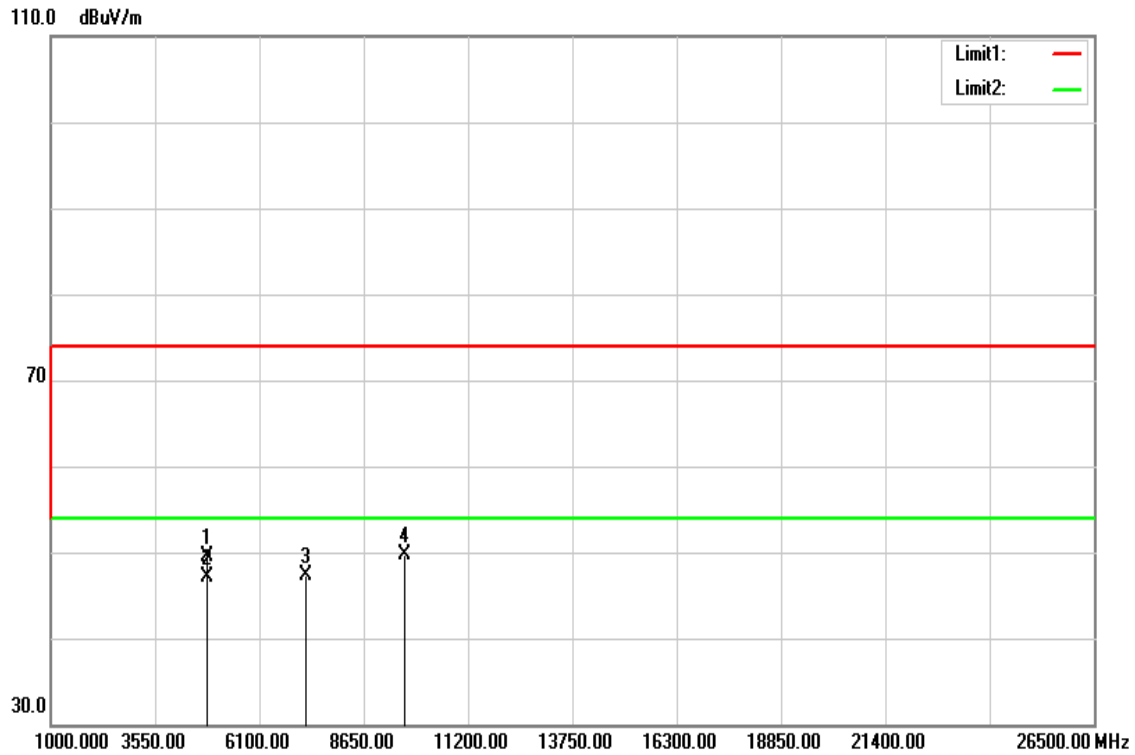

Polarity: Horizontal

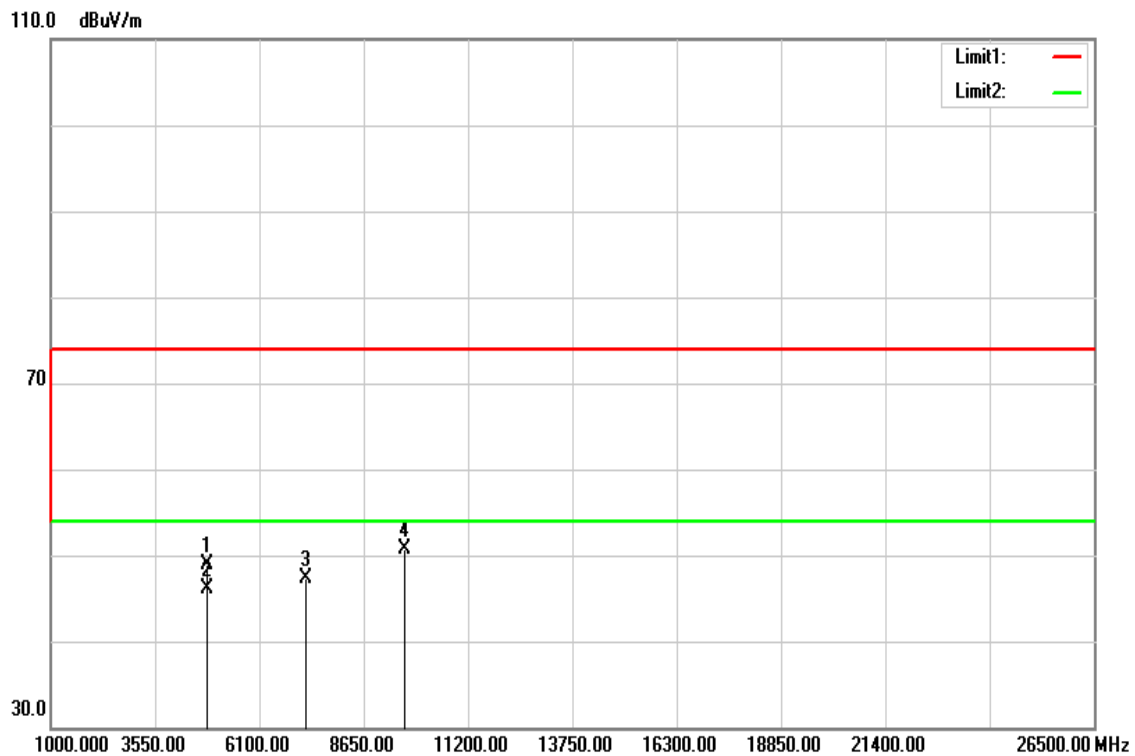

Above 1 GHz

Operation Mode: TX / IEEE 802.11b / CH Low

Test Date: June 1, 2016

Temperature: 27°C

Tested by: Jason Lu

Humidity: 53% RH

Polarity: Ver. / Hor.

Frequency (MHz)	Reading (dBuV)	Correction Factor (dB/m)	Result (dBuV/m)	Limit (dBuV/m)	Margin (dB)	Remark	Ant. Pol. (H/V)
4827.000	44.31	5.11	49.42	74.00	-24.58	peak	V
4827.000	41.94	5.11	47.05	54.00	-6.95	AVG	V
7236.000	34.69	12.71	47.40	74.00	-26.60	peak	V
9648.000	32.20	17.60	49.80	74.00	-24.20	peak	V
N/A							
4827.000	43.75	5.11	48.86	74.00	-25.14	peak	H
4827.000	40.94	5.11	46.05	54.00	-7.95	AVG	H
7236.000	34.69	12.71	47.40	74.00	-26.60	peak	H
9648.000	33.07	17.60	50.67	74.00	-23.33	peak	H
N/A							

Remark:

1. *Measuring frequencies from 1 GHz to the 10th harmonic of highest fundamental frequency.*
2. *Radiated emissions measured in frequency above 1000MHz were made with an instrument using peak/average detector mode.*
3. *Average test would be performed if the peak result were greater than the average limit or as required by the applicant.*
4. *Data of measurement within this frequency range shown " --- " in the table above means the reading of emissions are attenuated more than 20dB below the permissible limits or the field strength is too small to be measured.*
5. *Measurements above show only up to 6 maximum emissions noted, or would be lesser, with " N/A " remark, if no specific emissions from the EUT are recorded (ie: margin>20dB from the applicable limit) and considered that's already beyond the background noise floor.*
6. *Margin (dB) = Remark result (dBuV/m) – Average limit (dBuV/m).*

TX / IEEE 802.11b / CH Mid

Polarity: Vertical

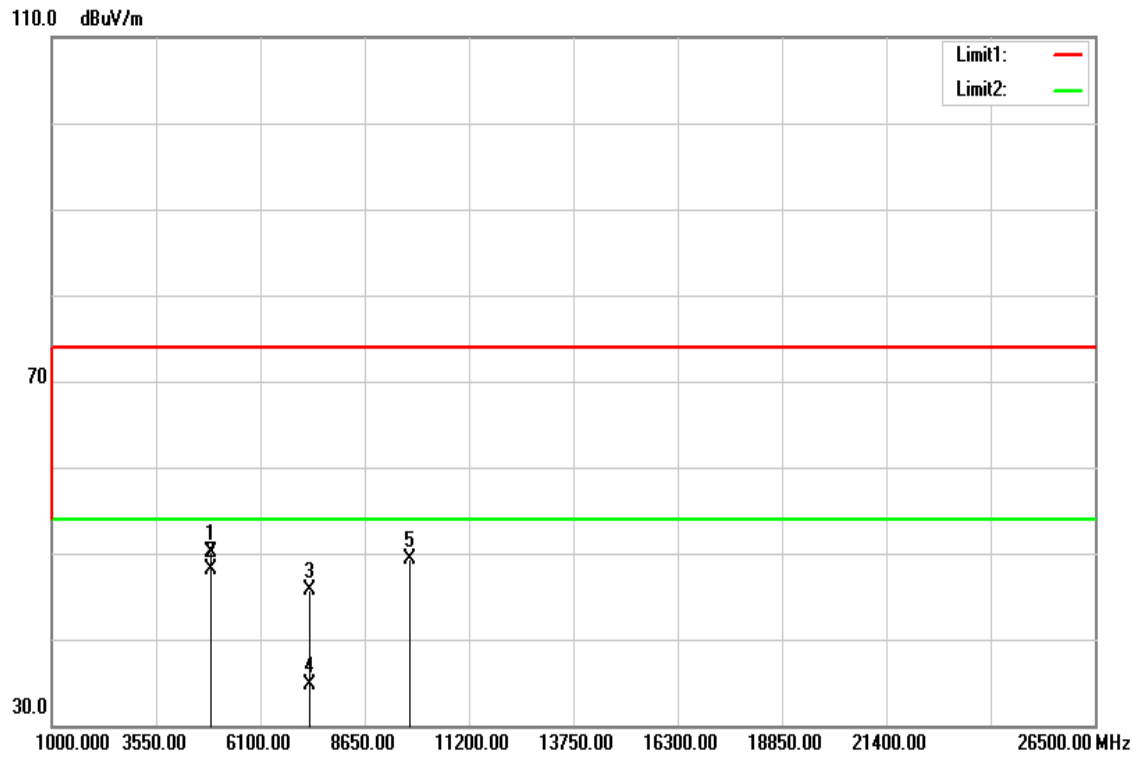

Polarity: Horizontal

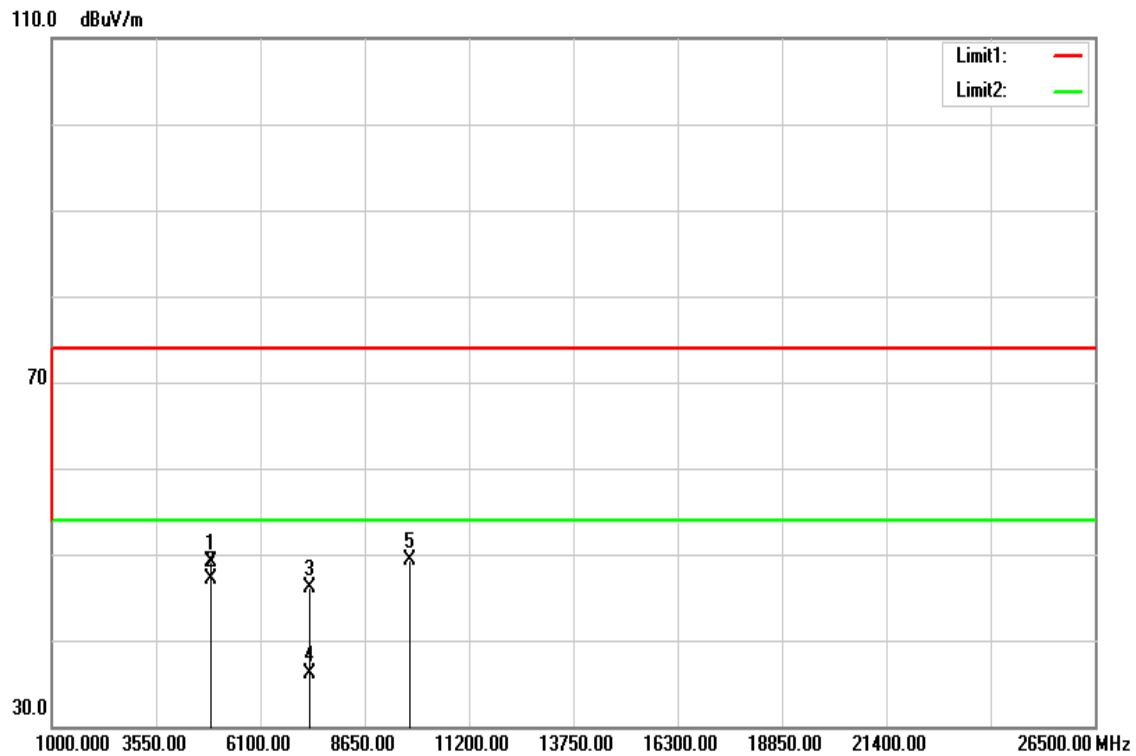

Operation Mode: TX / IEEE 802.11b / CH Mid

Test Date: June 1, 2016

Temperature: 27°C

Tested by: Dennis Li

Humidity: 53% RH

Polarity: Ver. / Hor.

Frequency (MHz)	Reading (dBuV)	Correction Factor (dB/m)	Result (dBuV/m)	Limit (dBuV/m)	Margin (dB)	Remark	Ant. Pol. (H/V)
4876.000	44.84	5.24	50.08	74.00	-23.92	peak	V
4876.000	42.85	5.24	48.09	54.00	-5.91	AVG	V
7311.000	32.69	12.94	45.63	74.00	-28.37	peak	V
7311.000	21.72	12.94	34.66	54.00	-19.34	AVG	V
9748.000	31.80	17.60	49.40	74.00	-24.60	peak	V
N/A							
4876.000	43.91	5.24	49.15	74.00	-24.85	peak	H
4876.000	41.88	5.24	47.12	54.00	-6.88	AVG	H
7311.000	33.11	12.94	46.05	74.00	-27.95	peak	H
7311.000	23.07	12.94	36.01	54.00	-17.99	AVG	H
9748.000	31.60	17.60	49.20	74.00	-24.80	peak	H
N/A							

Remark:

1. Measuring frequencies from 1 GHz to the 10th harmonic of highest fundamental frequency.
2. Radiated emissions measured in frequency above 1000MHz were made with an instrument using peak/average detector mode.
3. Average test would be performed if the peak result were greater than the average limit or as required by the applicant.
4. Data of measurement within this frequency range shown " --- " in the table above means the reading of emissions are attenuated more than 20dB below the permissible limits or the field strength is too small to be measured.
5. Measurements above show only up to 6 maximum emissions noted, or would be lesser, with " N/A " remark, if no specific emissions from the EUT are recorded (ie: margin>20dB from the applicable limit) and considered that's already beyond the background noise floor.
6. Margin (dB) = Remark result (dBuV/m) – Average limit (dBuV/m).

TX / IEEE 802.11b / CH High

Polarity: Vertical

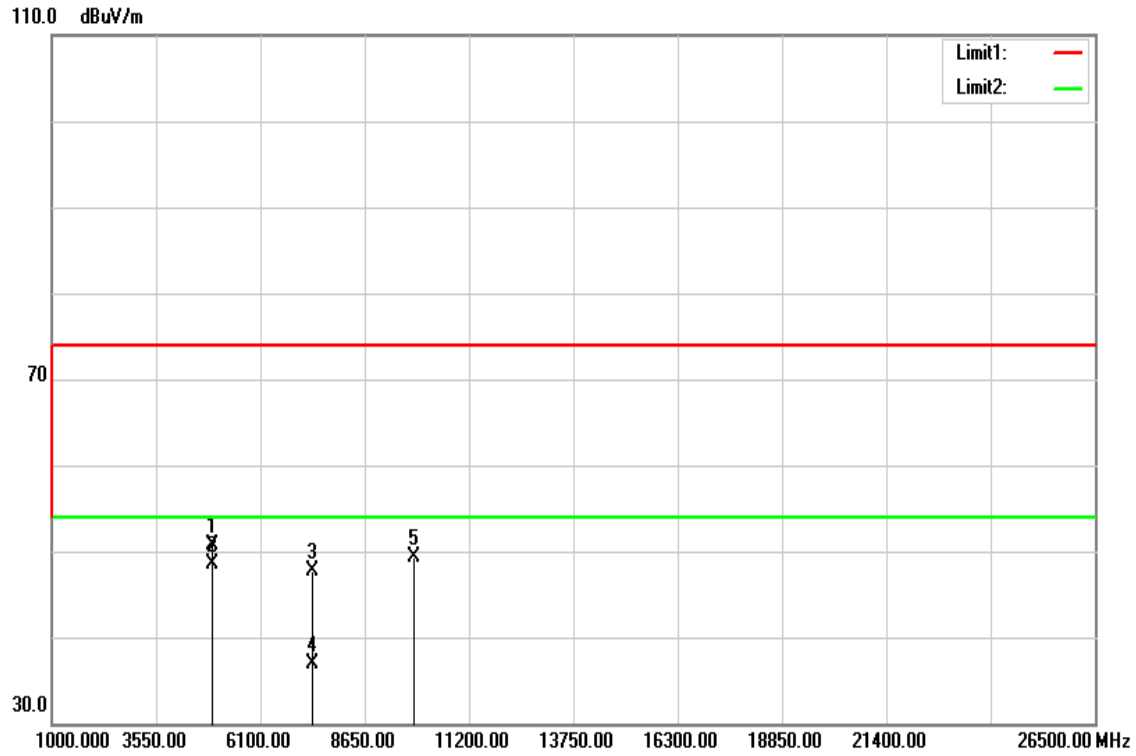

Polarity: Horizontal

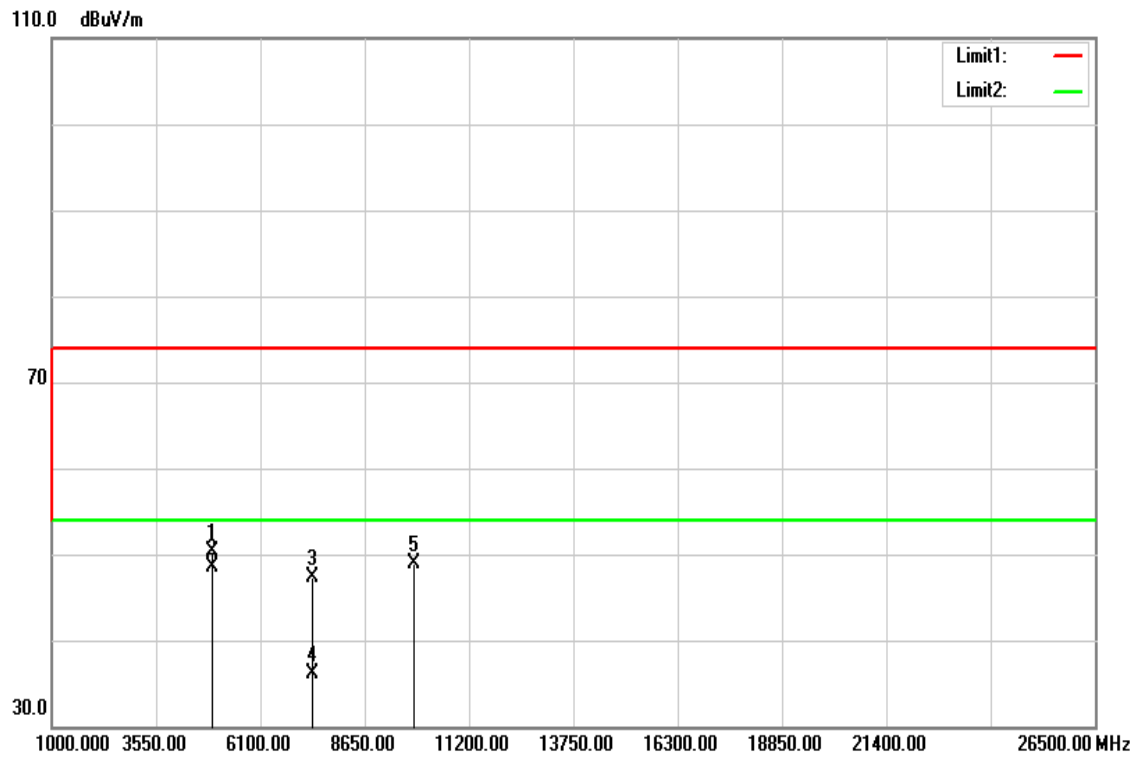

Operation Mode: TX / IEEE 802.11b / CH High

Test Date: June 1, 2016

Temperature: 27°C

Tested by: Dennis Li

Humidity: 53% RH

Polarity: Ver. / Hor.

Frequency (MHz)	Reading (dBuV)	Correction Factor (dB/m)	Result (dBuV/m)	Limit (dBuV/m)	Margin (dB)	Remark	Ant. Pol. (H/V)
4925.000	45.30	5.37	50.67	74.00	-23.33	peak	V
4925.000	43.09	5.37	48.46	54.00	-5.54	AVG	V
7386.000	34.56	13.17	47.73	74.00	-26.27	peak	V
7386.000	23.71	13.17	36.88	54.00	-17.12	AVG	V
9848.000	31.74	17.60	49.34	74.00	-24.66	peak	V
N/A							
4925.000	44.96	5.37	50.33	74.00	-23.67	peak	H
4925.000	43.17	5.37	48.54	54.00	-5.46	AVG	H
7386.000	34.21	13.17	47.38	74.00	-26.62	peak	H
7386.000	22.95	13.17	36.12	54.00	-17.88	AVG	H
9848.000	31.35	17.60	48.95	74.00	-25.05	peak	H
N/A							

Remark:

1. Measuring frequencies from 1 GHz to the 10th harmonic of highest fundamental frequency.
2. Radiated emissions measured in frequency above 1000MHz were made with an instrument using peak/average detector mode.
3. Average test would be performed if the peak result were greater than the average limit or as required by the applicant.
4. Data of measurement within this frequency range shown " --- " in the table above means the reading of emissions are attenuated more than 20dB below the permissible limits or the field strength is too small to be measured.
5. Measurements above show only up to 6 maximum emissions noted, or would be lesser, with " N/A " remark, if no specific emissions from the EUT are recorded (ie: margin>20dB from the applicable limit) and considered that's already beyond the background noise floor.
6. Margin (dB) = Remark result (dBuV/m) – Average limit (dBuV/m).

TX / IEEE 802.11g / CH Low

Polarity: Vertical

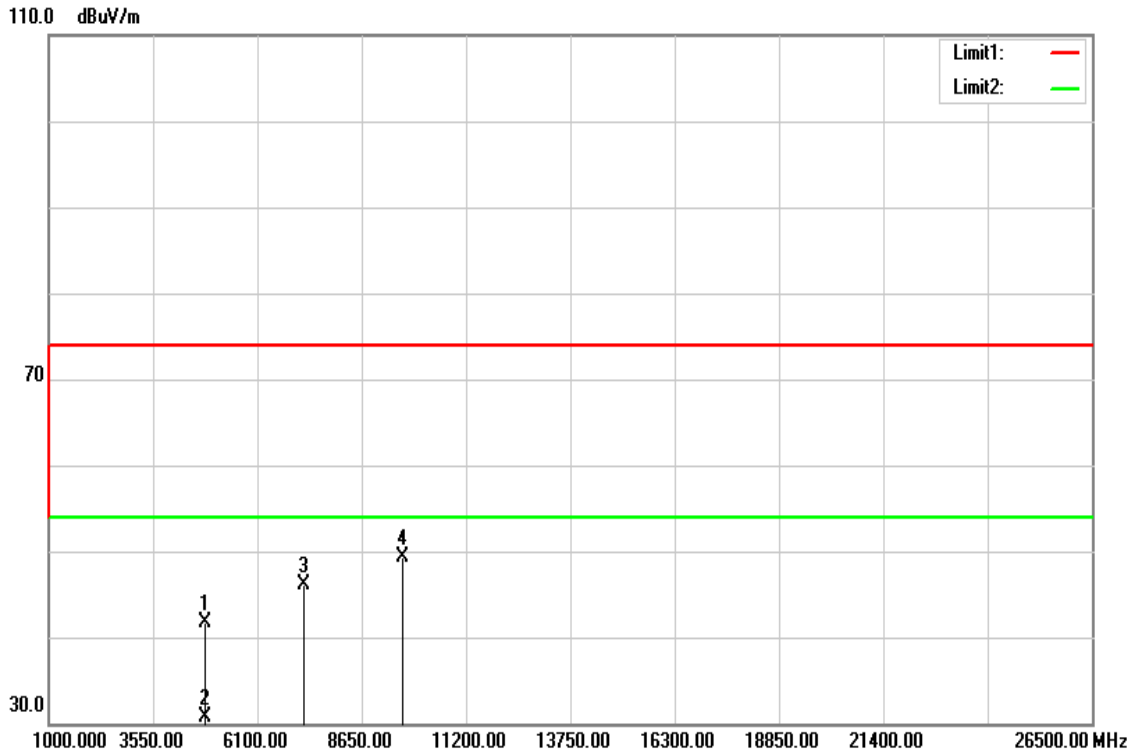

Polarity: Horizontal

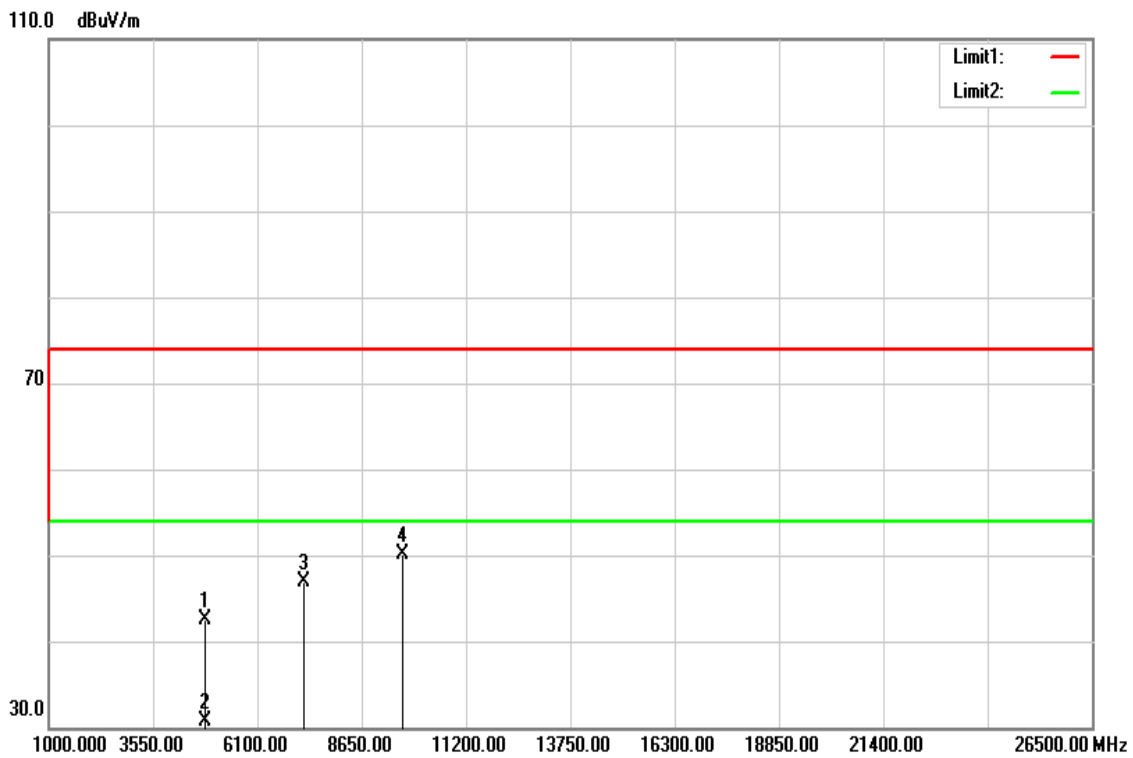

Operation Mode: TX / IEEE 802.11g / CH Low

Test Date: June 1, 2016

Temperature: 27°C

Tested by: Dennis Li

Humidity: 53% RH

Polarity: Ver. / Hor.

Frequency (MHz)	Reading (dBuV)	Correction Factor (dB/m)	Result (dBuV/m)	Limit (dBuV/m)	Margin (dB)	Remark	Ant. Pol. (H/V)
4824.000	36.51	5.10	41.61	74.00	-32.39	peak	V
4824.000	25.64	5.10	30.74	54.00	-23.26	AVG	V
7236.000	33.45	12.71	46.16	74.00	-27.84	peak	V
9648.000	31.70	17.60	49.30	74.00	-24.70	peak	V
N/A							
4824.000	37.48	5.10	42.58	74.00	-31.42	peak	H
4824.000	25.68	5.10	30.78	54.00	-23.22	AVG	H
7236.000	34.19	12.71	46.90	74.00	-27.10	peak	H
9648.000	32.53	17.60	50.13	74.00	-23.87	peak	H
N/A							

Remark:

1. Measuring frequencies from 1 GHz to the 10th harmonic of highest fundamental frequency.
2. Radiated emissions measured in frequency above 1000MHz were made with an instrument using peak/average detector mode.
3. Average test would be performed if the peak result were greater than the average limit or as required by the applicant.
4. Data of measurement within this frequency range shown " --- " in the table above means the reading of emissions are attenuated more than 20dB below the permissible limits or the field strength is too small to be measured.
5. Measurements above show only up to 6 maximum emissions noted, or would be lesser, with " N/A " remark, if no specific emissions from the EUT are recorded (ie: margin>20dB from the applicable limit) and considered that's already beyond the background noise floor.
6. Margin (dB) = Remark result (dBuV/m) – Average limit (dBuV/m).

TX / IEEE 802.11g / CH Mid

Polarity: Vertical

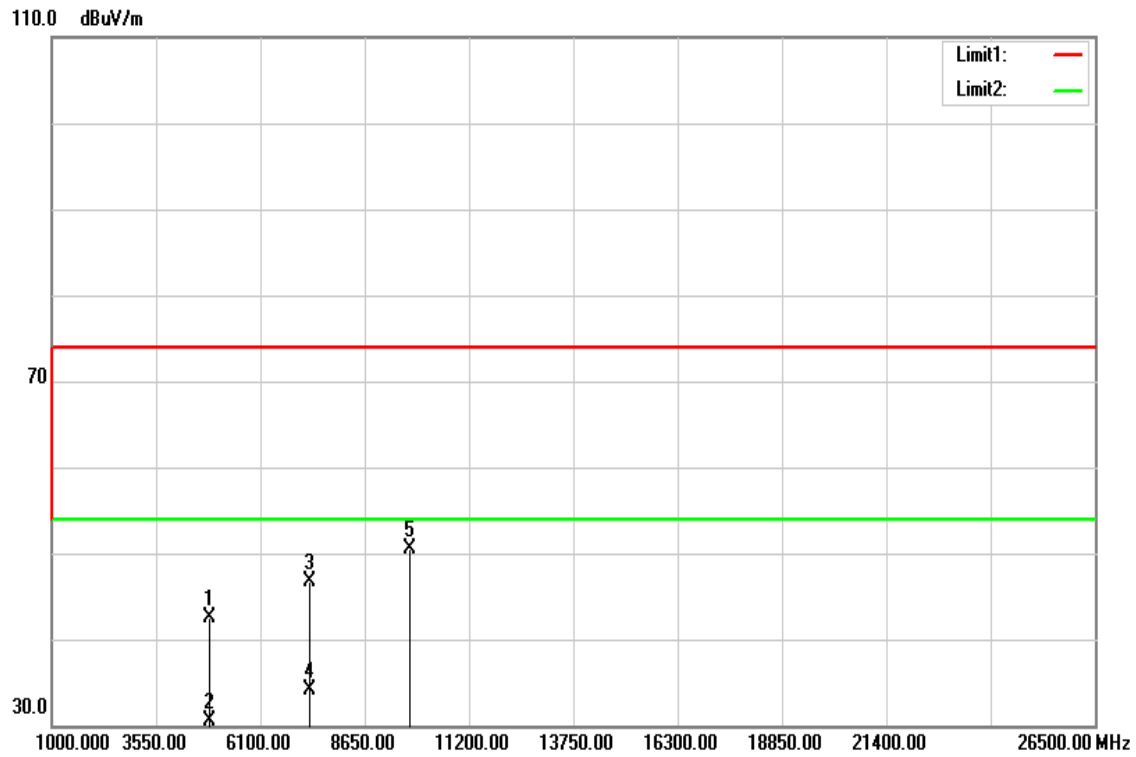

Polarity: Horizontal

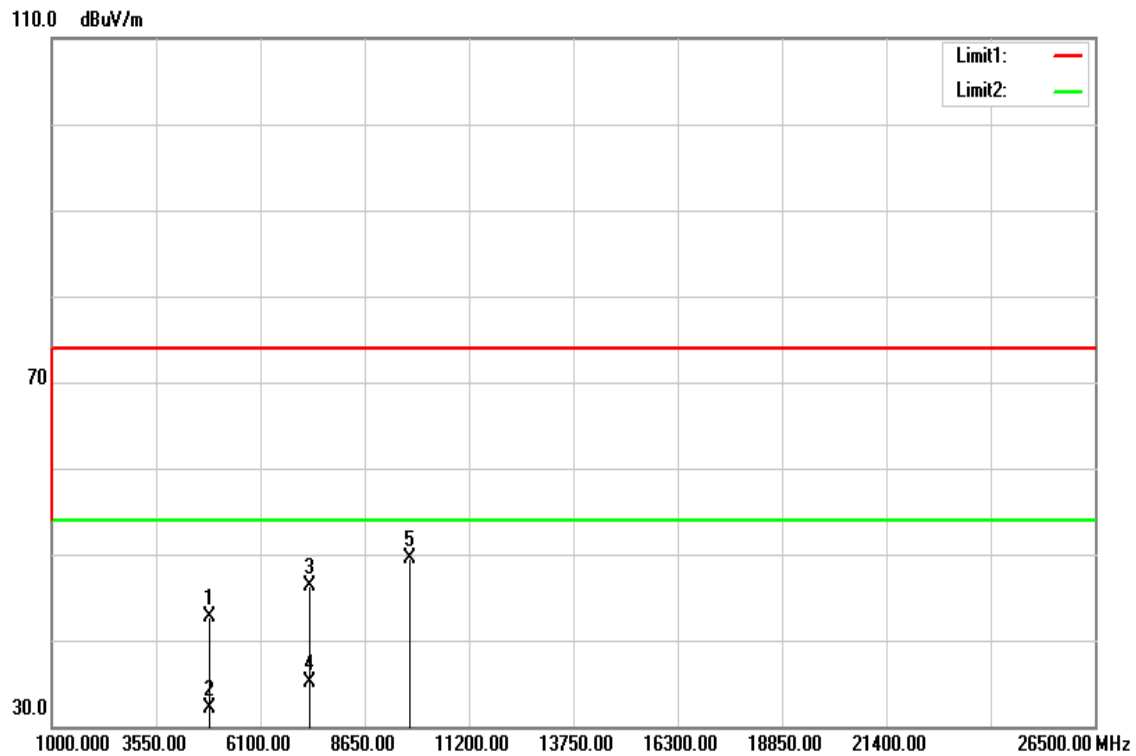

Operation Mode: TX / IEEE 802.11g / CH Mid

Test Date: June 1, 2016

Temperature: 27°C

Tested by: Dennis Li

Humidity: 53% RH

Polarity: Ver. / Hor.

Frequency (MHz)	Reading (dBuV)	Correction Factor (dB/m)	Result (dBuV/m)	Limit (dBuV/m)	Margin (dB)	Remark	Ant. Pol. (H/V)
4874.000	37.31	5.23	42.54	74.00	-31.46	peak	V
4874.000	25.33	5.23	30.56	54.00	-23.44	AVG	V
7311.000	33.86	12.94	46.80	74.00	-27.20	peak	V
7311.000	21.19	12.94	34.13	54.00	-19.87	AVG	V
9748.000	32.81	17.60	50.41	74.00	-23.59	peak	V
N/A							
4874.000	37.54	5.23	42.77	74.00	-31.23	peak	H
4874.000	26.92	5.23	32.15	54.00	-21.85	AVG	H
7311.000	33.34	12.94	46.28	74.00	-27.72	peak	H
7311.000	22.23	12.94	35.17	54.00	-18.83	AVG	H
9748.000	31.89	17.60	49.49	74.00	-24.51	peak	H
N/A							

Remark:

1. Measuring frequencies from 1 GHz to the 10th harmonic of highest fundamental frequency.
2. Radiated emissions measured in frequency above 1000MHz were made with an instrument using peak/average detector mode.
3. Average test would be performed if the peak result were greater than the average limit or as required by the applicant.
4. Data of measurement within this frequency range shown " --- " in the table above means the reading of emissions are attenuated more than 20dB below the permissible limits or the field strength is too small to be measured.
5. Measurements above show only up to 6 maximum emissions noted, or would be lesser, with " N/A " remark, if no specific emissions from the EUT are recorded (ie: margin>20dB from the applicable limit) and considered that's already beyond the background noise floor.
6. Margin (dB) = Remark result (dBuV/m) – Average limit (dBuV/m).

TX / IEEE 802.11g / CH High

Polarity: Vertical

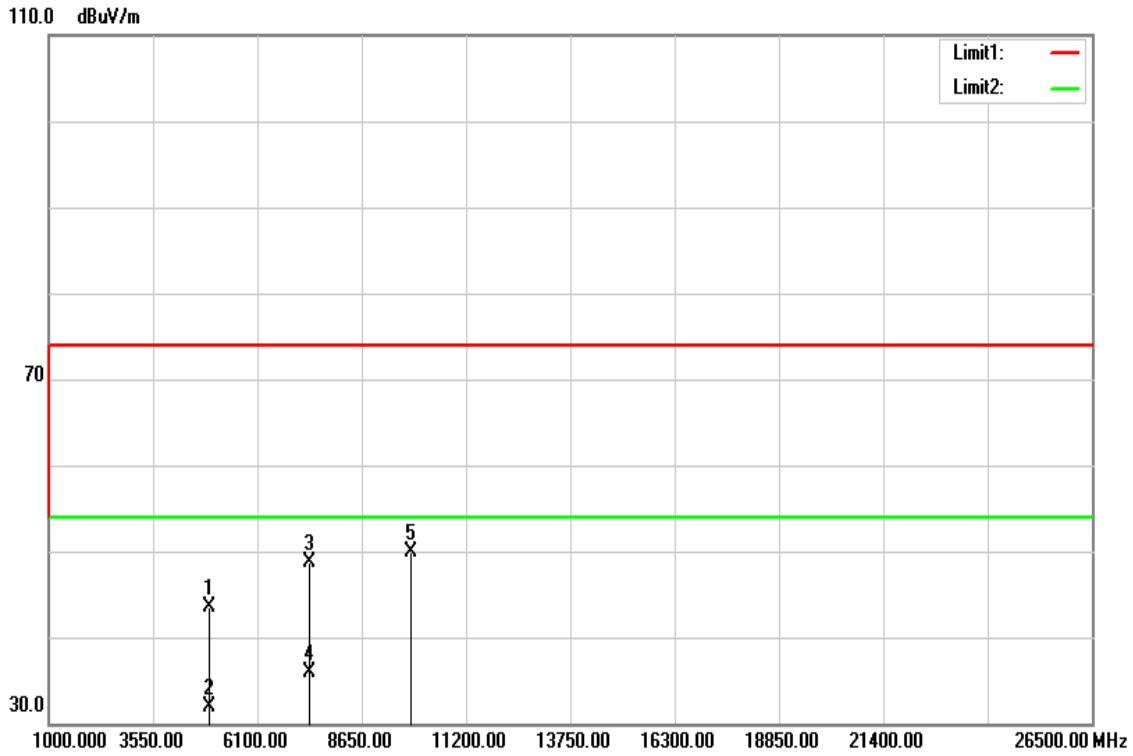

Polarity: Horizontal

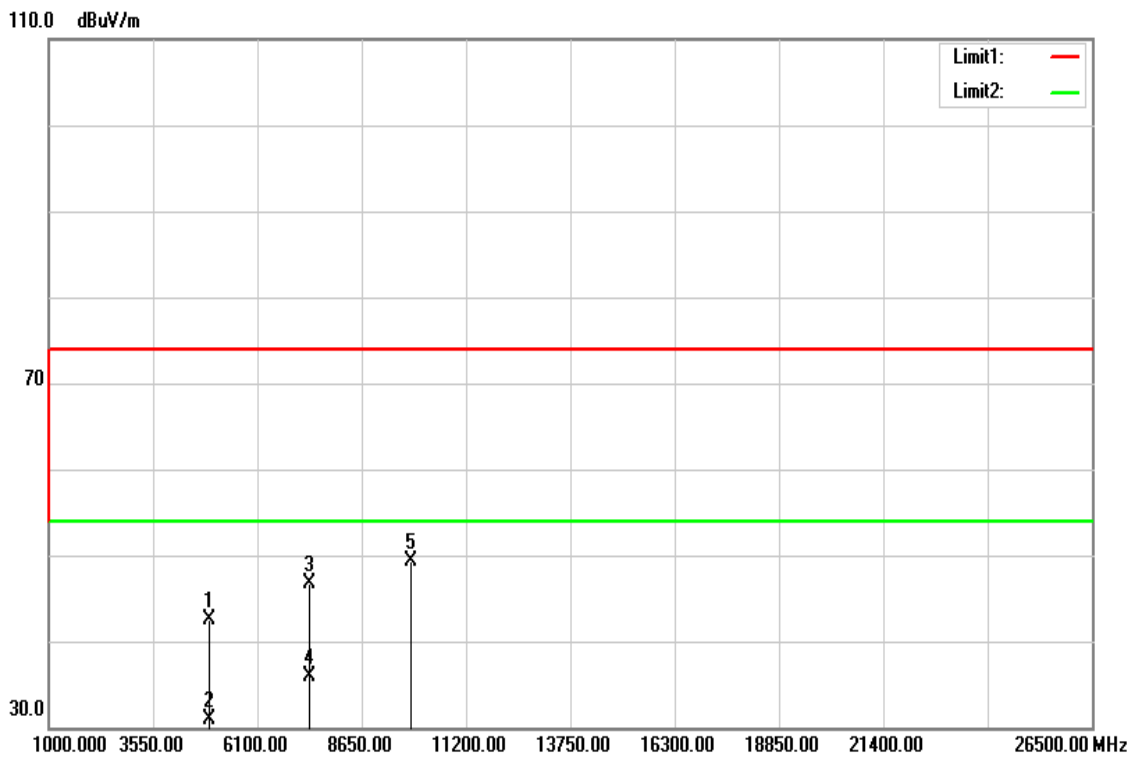

Operation Mode: TX / IEEE 802.11g / CH High

Test Date: June 1, 2016

Temperature: 27°C

Tested by: Dennis Li

Humidity: 53% RH

Polarity: Ver. / Hor.

Frequency (MHz)	Reading (dBuV)	Correction Factor (dB/m)	Result (dBuV/m)	Limit (dBuV/m)	Margin (dB)	Remark	Ant. Pol. (H/V)
4924.000	38.20	5.37	43.57	74.00	-30.43	peak	V
4924.000	26.50	5.37	31.87	54.00	-22.13	AVG	V
7386.000	35.47	13.17	48.64	74.00	-25.36	peak	V
7386.000	22.81	13.17	35.98	54.00	-18.02	AVG	V
9848.000	32.28	17.60	49.88	74.00	-24.12	peak	V
N/A							
4924.000	37.04	5.37	42.41	74.00	-31.59	peak	H
4924.000	25.61	5.37	30.98	54.00	-23.02	AVG	H
7386.000	33.58	13.17	46.75	74.00	-27.25	peak	H
7386.000	22.72	13.17	35.89	54.00	-18.11	AVG	H
9848.000	31.72	17.60	49.32	74.00	-24.68	peak	H
N/A							

Remark:

1. Measuring frequencies from 1 GHz to the 10th harmonic of highest fundamental frequency.
2. Radiated emissions measured in frequency above 1000MHz were made with an instrument using peak/average detector mode.
3. Average test would be performed if the peak result were greater than the average limit or as required by the applicant.
4. Data of measurement within this frequency range shown " --- " in the table above means the reading of emissions are attenuated more than 20dB below the permissible limits or the field strength is too small to be measured.
5. Measurements above show only up to 6 maximum emissions noted, or would be lesser, with " N/A " remark, if no specific emissions from the EUT are recorded (ie: margin>20dB from the applicable limit) and considered that's already beyond the background noise floor.
6. Margin (dB) = Remark result (dBuV/m) – Average limit (dBuV/m).

TX / IEEE 802.11n HT 20 MHz mode / CH Low

Polarity: Vertical

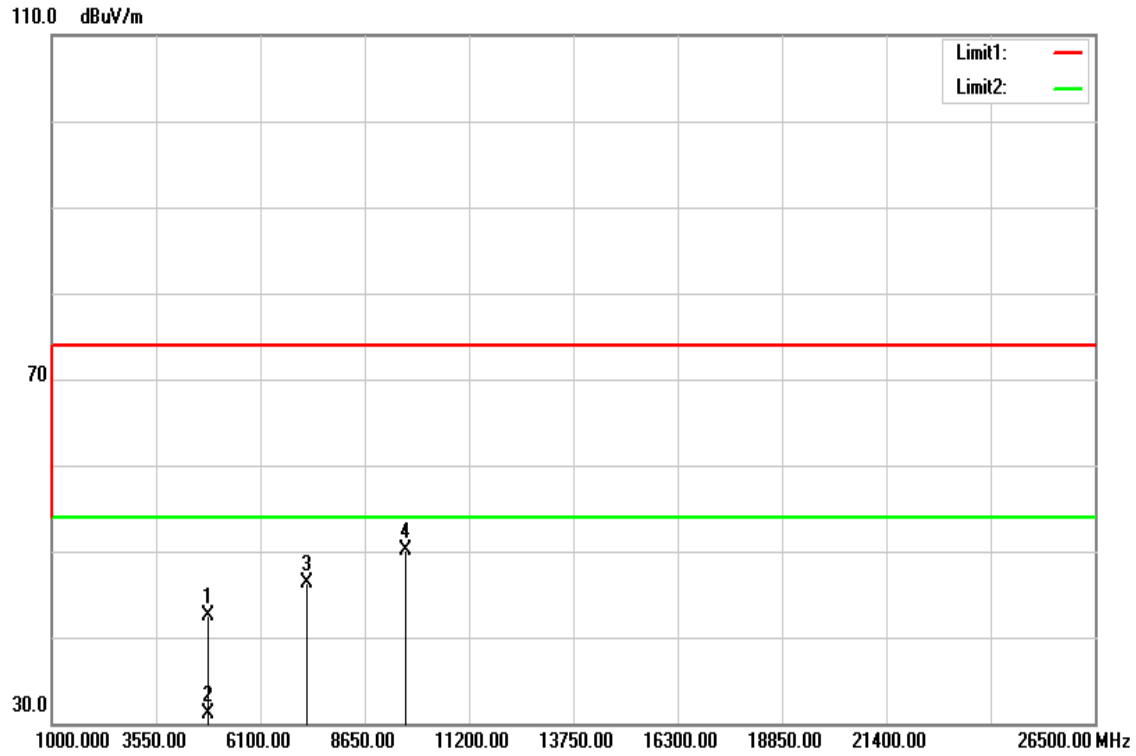

Polarity: Horizontal

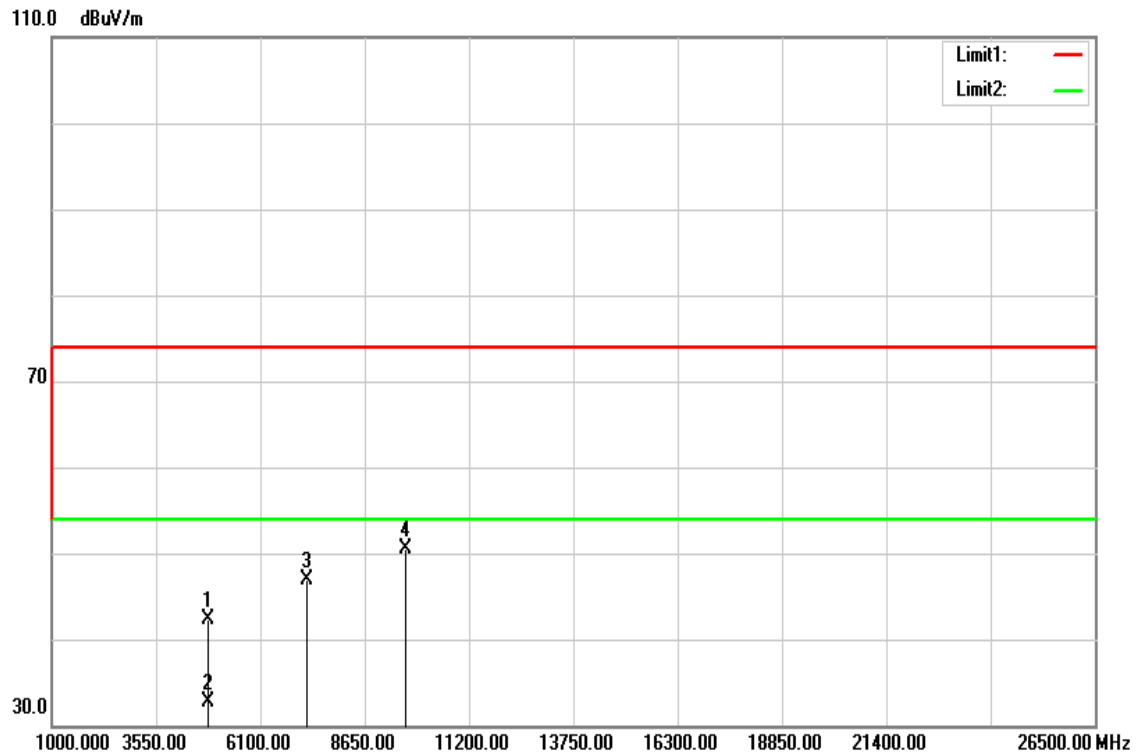

Operation Mode: TX / IEEE 802.11n HT 20 MHz mode / CH Low **Test Date:** June 1, 2016

Temperature: 27°C

Tested by: Dennis Li

Humidity: 53% RH

Polarity: Ver. / Hor.

Frequency (MHz)	Reading (dBuV)	Correction Factor (dB/m)	Result (dBuV/m)	Limit (dBuV/m)	Margin (dB)	Remark	Ant. Pol. (H/V)
4824.000	37.41	5.10	42.51	74.00	-31.49	peak	V
4824.000	26.04	5.10	31.14	54.00	-22.86	AVG	V
7236.000	33.54	12.71	46.25	74.00	-27.75	peak	V
9648.000	32.43	17.60	50.03	74.00	-23.97	peak	V
N/A							
4824.000	37.30	5.10	42.40	74.00	-31.60	peak	H
4824.000	27.54	5.10	32.64	54.00	-21.36	AVG	H
7236.000	34.16	12.71	46.87	74.00	-27.13	peak	H
9648.000	32.90	17.60	50.50	74.00	-23.50	peak	H
N/A							

Remark:

1. Measuring frequencies from 1 GHz to the 10th harmonic of highest fundamental frequency.
2. Radiated emissions measured in frequency above 1000MHz were made with an instrument using peak/average detector mode.
3. Average test would be performed if the peak result were greater than the average limit or as required by the applicant.
4. Data of measurement within this frequency range shown " --- " in the table above means the reading of emissions are attenuated more than 20dB below the permissible limits or the field strength is too small to be measured.
5. Measurements above show only up to 6 maximum emissions noted, or would be lesser, with " N/A " remark, if no specific emissions from the EUT are recorded (ie: margin>20dB from the applicable limit) and considered that's already beyond the background noise floor.
6. Margin (dB) = Remark result (dBuV/m) – Average limit (dBuV/m).

TX / IEEE 802.11n HT 20 MHz mode / CH Mid

Polarity: Vertical

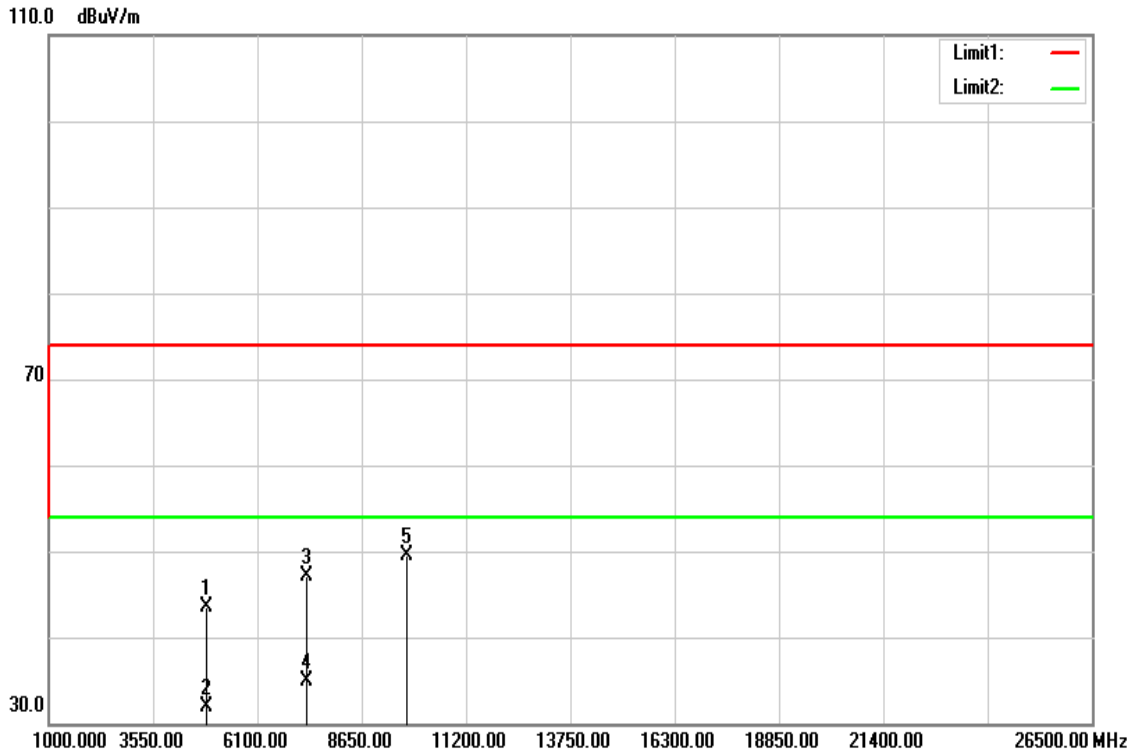

Polarity: Horizontal

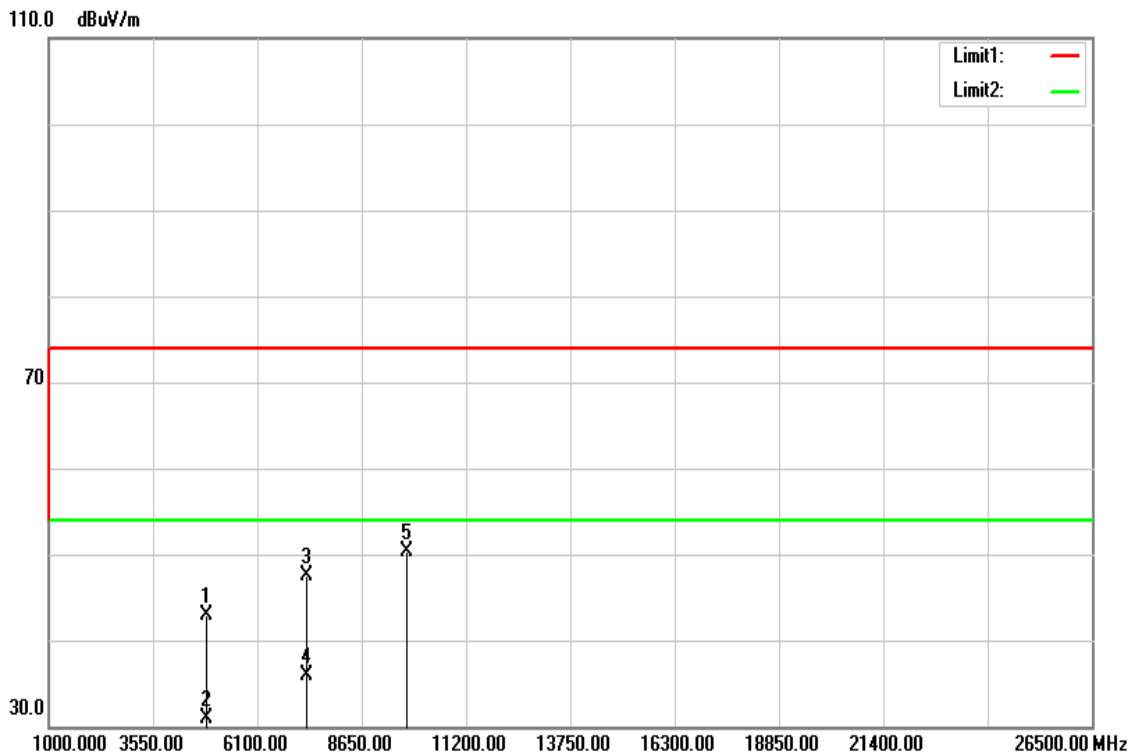

Operation Mode: TX / IEEE 802.11n HT 20 MHz mode / CH Mid **Test Date:** June 1, 2016

Temperature: 27°C

Tested by: Dennis Li

Humidity: 53% RH

Polarity: Ver. / Hor.

Frequency (MHz)	Reading (dBuV)	Correction Factor (dB/m)	Result (dBuV/m)	Limit (dBuV/m)	Margin (dB)	Remark	Ant. Pol. (H/V)
4874.000	38.27	5.23	43.50	74.00	-30.50	peak	V
4874.000	26.75	5.23	31.98	54.00	-22.02	AVG	V
7311.000	34.09	12.94	47.03	74.00	-26.97	peak	V
7311.000	21.93	12.94	34.87	54.00	-19.13	AVG	V
9748.000	31.84	17.60	49.44	74.00	-24.56	peak	V
N/A							
4874.000	37.71	5.23	42.94	74.00	-31.06	peak	H
4874.000	25.76	5.23	30.99	54.00	-23.01	AVG	H
7311.000	34.55	12.94	47.49	74.00	-26.51	peak	H
7311.000	22.94	12.94	35.88	54.00	-18.12	AVG	H
9748.000	32.77	17.60	50.37	74.00	-23.63	peak	H
N/A							

Remark:

1. Measuring frequencies from 1 GHz to the 10th harmonic of highest fundamental frequency.
2. Radiated emissions measured in frequency above 1000MHz were made with an instrument using peak/average detector mode.
3. Average test would be performed if the peak result were greater than the average limit or as required by the applicant.
4. Data of measurement within this frequency range shown " --- " in the table above means the reading of emissions are attenuated more than 20dB below the permissible limits or the field strength is too small to be measured.
5. Measurements above show only up to 6 maximum emissions noted, or would be lesser, with " N/A " remark, if no specific emissions from the EUT are recorded (ie: margin>20dB from the applicable limit) and considered that's already beyond the background noise floor.
6. Margin (dB) = Remark result (dBuV/m) – Average limit (dBuV/m).

TX / IEEE 802.11n HT 20 MHz mode / CH High

Polarity: Vertical

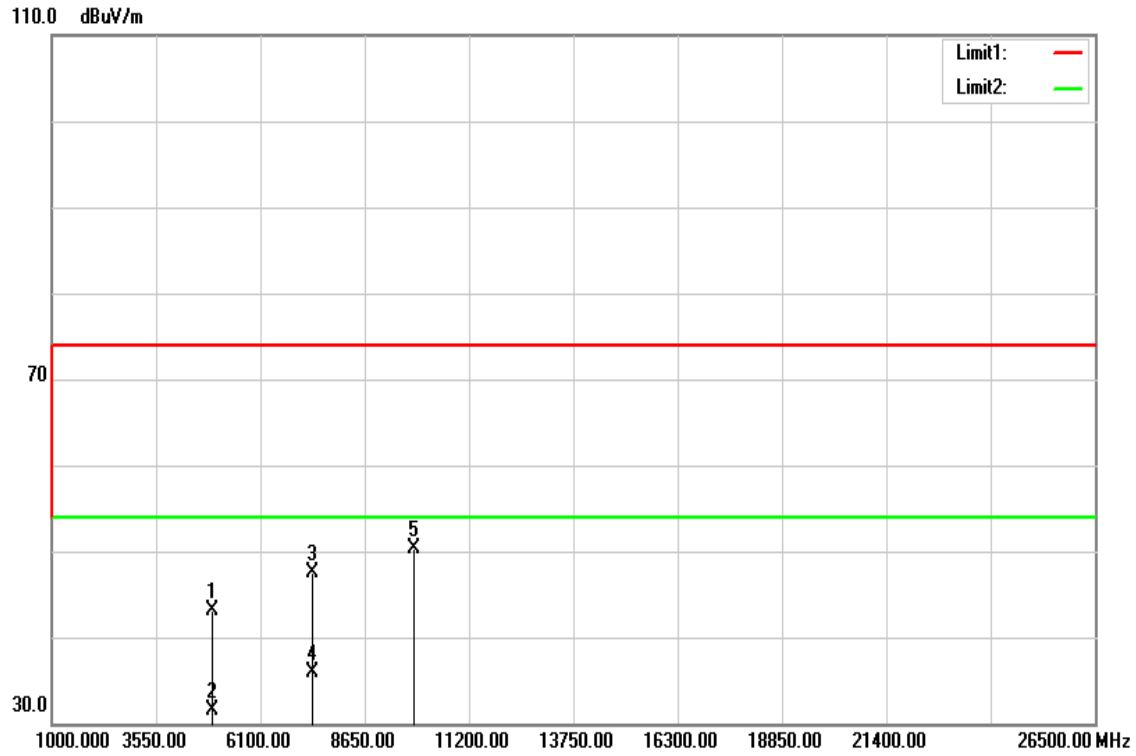

Polarity: Horizontal

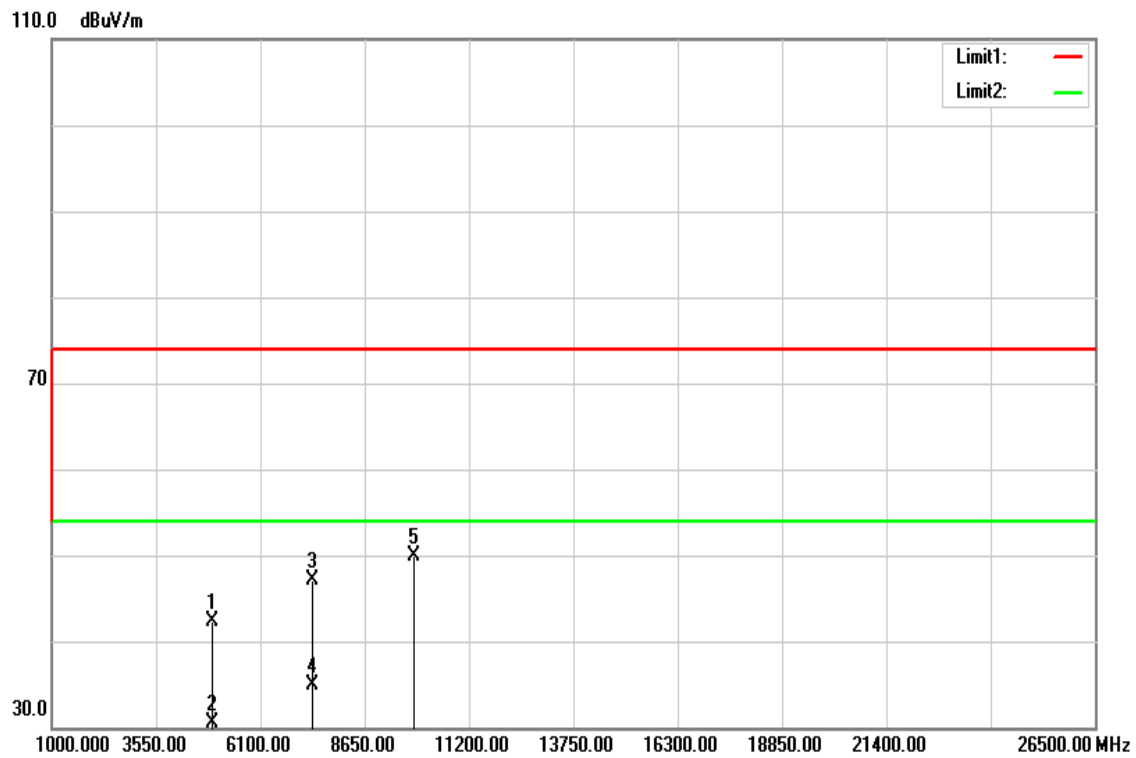

Operation Mode: TX / IEEE 802.11n HT 20 MHz mode / CH High
Temperature: 27°C
Humidity: 53% RH

Test Date: June 1, 2016
Tested by: Dennis Li
Polarity: Ver. / Hor.

Frequency (MHz)	Reading (dBuV)	Correction Factor (dB/m)	Result (dBuV/m)	Limit (dBuV/m)	Margin (dB)	Remark	Ant. Pol. (H/V)
4924.000	37.70	5.37	43.07	74.00	-30.93	peak	V
4924.000	26.09	5.37	31.46	54.00	-22.54	AVG	V
7386.000	34.33	13.17	47.50	74.00	-26.50	peak	V
7386.000	22.74	13.17	35.91	54.00	-18.09	AVG	V
9848.000	32.63	17.60	50.23	74.00	-23.77	peak	V
N/A							
4924.000	36.86	5.37	42.23	74.00	-31.77	peak	H
4924.000	25.19	5.37	30.56	54.00	-23.44	AVG	H
7386.000	33.90	13.17	47.07	74.00	-26.93	peak	H
7386.000	21.70	13.17	34.87	54.00	-19.13	AVG	H
9848.000	32.33	17.60	49.93	74.00	-24.07	peak	H
N/A							

Remark:

1. Measuring frequencies from 1 GHz to the 10th harmonic of highest fundamental frequency.
2. Radiated emissions measured in frequency above 1000MHz were made with an instrument using peak/average detector mode.
3. Average test would be performed if the peak result were greater than the average limit or as required by the applicant.
4. Data of measurement within this frequency range shown " --- " in the table above means the reading of emissions are attenuated more than 20dB below the permissible limits or the field strength is too small to be measured.
5. Measurements above show only up to 6 maximum emissions noted, or would be lesser, with " N/A " remark, if no specific emissions from the EUT are recorded (ie: margin>20dB from the applicable limit) and considered that's already beyond the background noise floor.
6. Margin (dB) = Remark result (dBuV/m) – Average limit (dBuV/m).

TX / IEEE 802.11n HT 40 MHz mode / CH Low

Polarity: Vertical

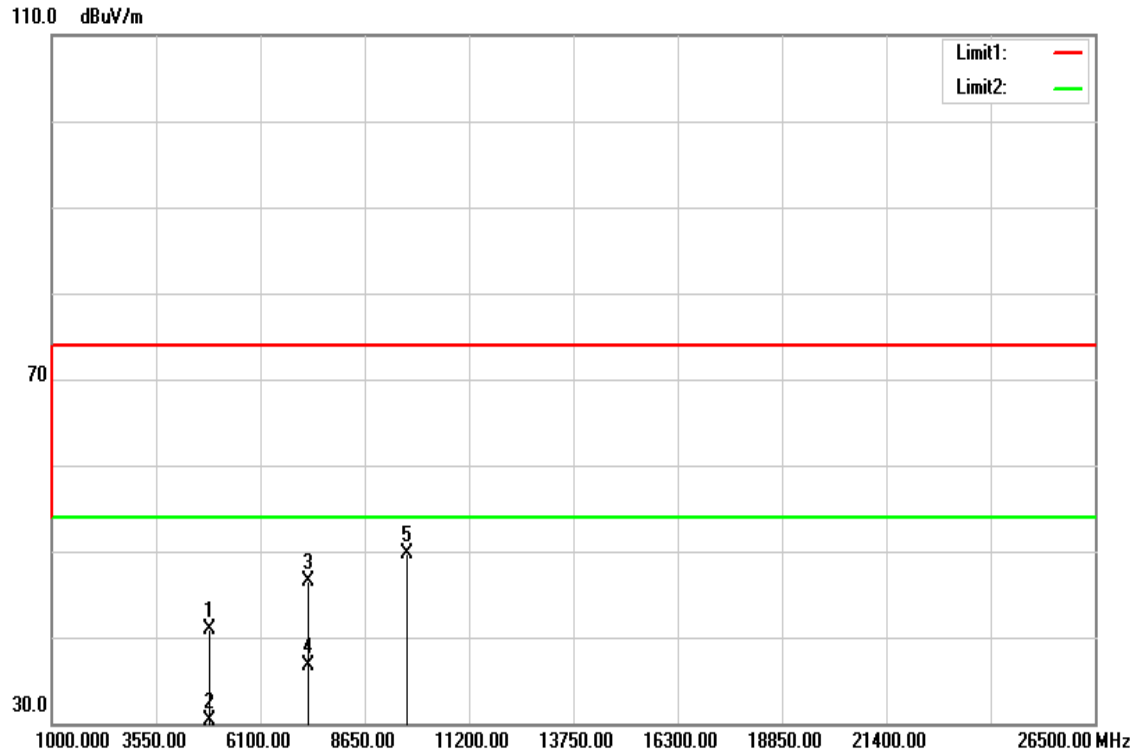

Polarity: Horizontal

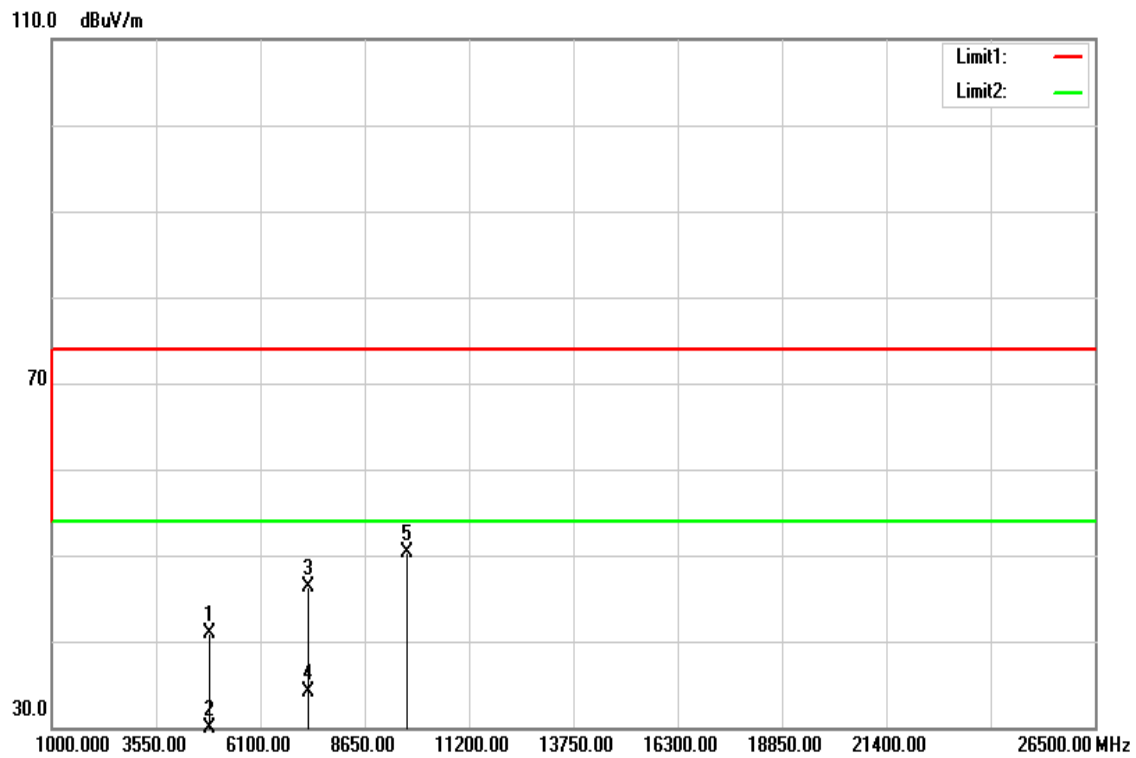

Operation Mode: TX / IEEE 802.11n HT 40 MHz mode
/ CH Low

Test Date: June 1, 2016

Temperature: 27°C

Tested by: Dennis Li

Humidity: 53% RH

Polarity: Ver. / Hor.

Frequency (MHz)	Reading (dBuV)	Correction Factor (dB/m)	Result (dBuV/m)	Limit (dBuV/m)	Margin (dB)	Remark	Ant. Pol. (H/V)
4844.000	35.66	5.15	40.81	74.00	-33.19	peak	V
4844.000	25.18	5.15	30.33	54.00	-23.67	AVG	V
7266.000	33.78	12.80	46.58	74.00	-27.42	peak	V
7266.000	23.98	12.80	36.78	54.00	-17.22	AVG	V
9688.000	32.06	17.60	49.66	74.00	-24.34	peak	V
N/A							
4844.000	35.73	5.15	40.88	74.00	-33.12	peak	H
4844.000	24.69	5.15	29.84	54.00	-24.16	AVG	H
7266.000	33.42	12.80	46.22	74.00	-27.78	peak	H
7266.000	21.34	12.80	34.14	54.00	-19.86	AVG	H
9688.000	32.65	17.60	50.25	74.00	-23.75	peak	H
N/A							

Remark:

1. Measuring frequencies from 1 GHz to the 10th harmonic of highest fundamental frequency.
2. Radiated emissions measured in frequency above 1000MHz were made with an instrument using peak/average detector mode.
3. Average test would be performed if the peak result were greater than the average limit or as required by the applicant.
4. Data of measurement within this frequency range shown " --- " in the table above means the reading of emissions are attenuated more than 20dB below the permissible limits or the field strength is too small to be measured.
5. Measurements above show only up to 6 maximum emissions noted, or would be lesser, with " N/A " remark, if no specific emissions from the EUT are recorded (ie: margin>20dB from the applicable limit) and considered that's already beyond the background noise floor.
6. Margin (dB) = Remark result (dBuV/m) – Average limit (dBuV/m).

TX / IEEE 802.11n HT 40 MHz mode / CH Mid

Polarity: Vertical

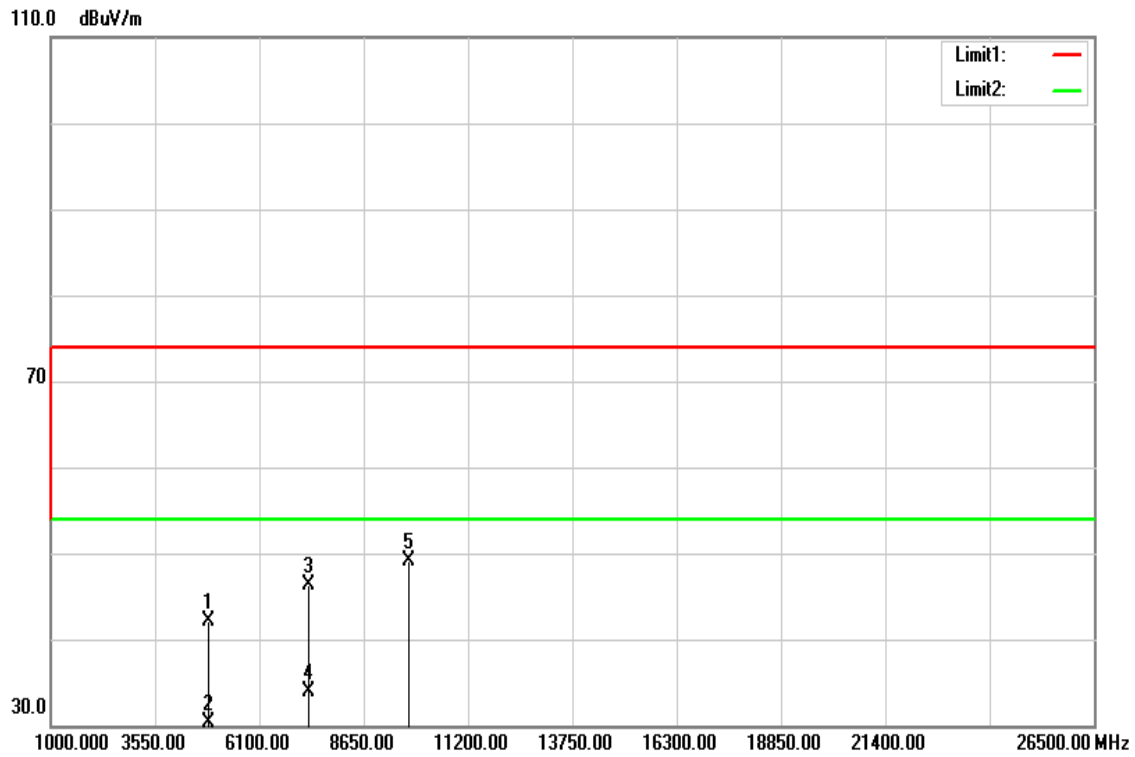

Polarity: Horizontal

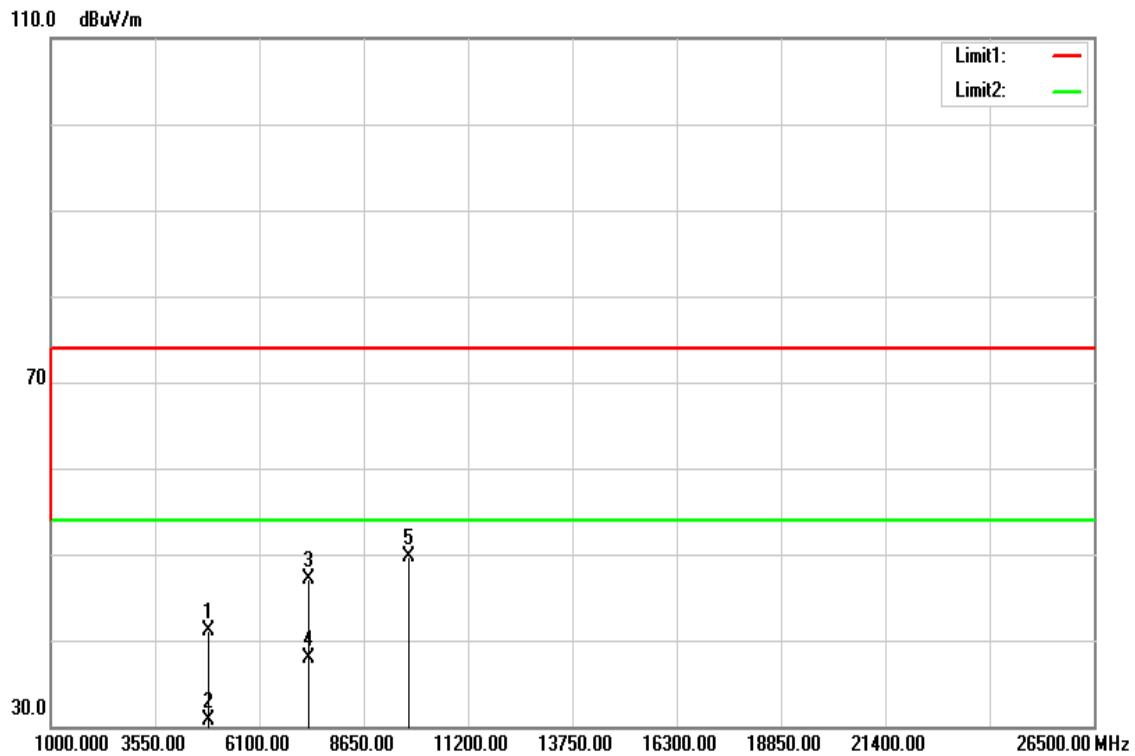

Operation Mode: TX / IEEE 802.11n HT 40 MHz mode
/ CH Mid

Test Date: June 1, 2016

Temperature: 27°C

Tested by: Dennis Li

Humidity: 53% RH

Polarity: Ver. / Hor.

Frequency (MHz)	Reading (dBuV)	Correction Factor (dB/m)	Result (dBuV/m)	Limit (dBuV/m)	Margin (dB)	Remark	Ant. Pol. (H/V)
4874.000	36.86	5.23	42.09	74.00	-31.91	peak	V
4874.000	25.15	5.23	30.38	54.00	-23.62	AVG	V
7311.000	33.29	12.94	46.23	74.00	-27.77	peak	V
7311.000	21.04	12.94	33.98	54.00	-20.02	AVG	V
9748.000	31.49	17.60	49.09	74.00	-24.91	peak	V
N/A							
4874.000	35.85	5.23	41.08	74.00	-32.92	peak	H
4874.000	25.43	5.23	30.66	54.00	-23.34	AVG	H
7311.000	34.07	12.94	47.01	74.00	-26.99	peak	H
7311.000	24.93	12.94	37.87	54.00	-16.13	AVG	H
9748.000	32.03	17.60	49.63	74.00	-24.37	peak	H
N/A							

Remark:

1. Measuring frequencies from 1 GHz to the 10th harmonic of highest fundamental frequency.
2. Radiated emissions measured in frequency above 1000MHz were made with an instrument using peak/average detector mode.
3. Average test would be performed if the peak result were greater than the average limit or as required by the applicant.
4. Data of measurement within this frequency range shown " --- " in the table above means the reading of emissions are attenuated more than 20dB below the permissible limits or the field strength is too small to be measured.
5. Measurements above show only up to 6 maximum emissions noted, or would be lesser, with " N/A " remark, if no specific emissions from the EUT are recorded (ie: margin>20dB from the applicable limit) and considered that's already beyond the background noise floor.
6. Margin (dB) = Remark result (dBuV/m) – Average limit (dBuV/m).

TX / IEEE 802.11n HT 40 MHz mode / CH High

Polarity: Vertical

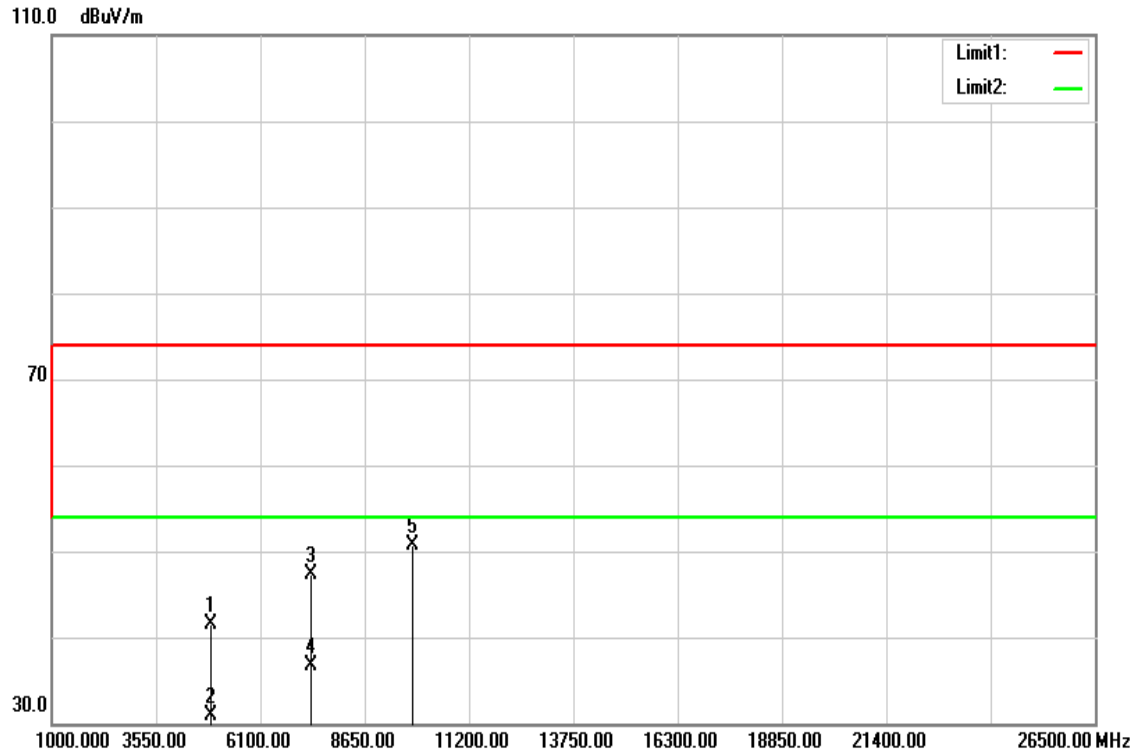

Polarity: Horizontal

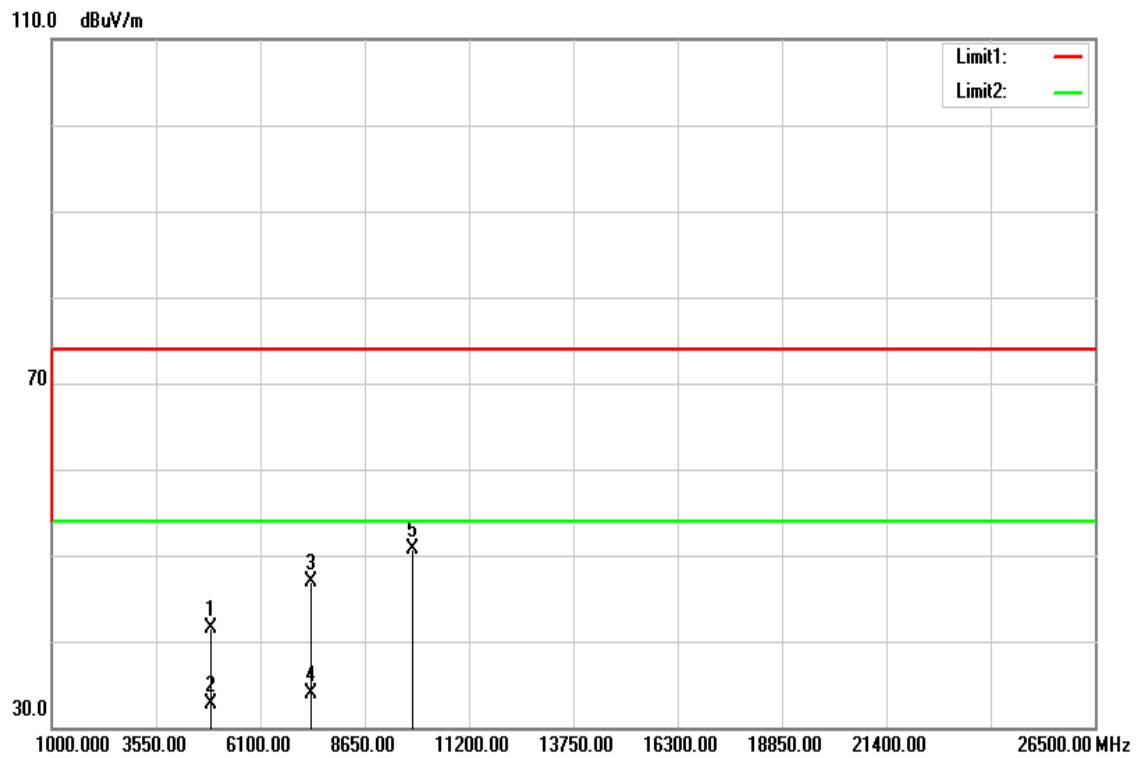

Operation Mode: TX / IEEE 802.11n HT 40 MHz mode
/ CH High

Test Date: June 1, 2016

Temperature: 27°C

Tested by: Dennis Li

Humidity: 53% RH

Polarity: Ver. / Hor.

Frequency (MHz)	Reading (dBuV)	Correction Factor (dB/m)	Result (dBuV/m)	Limit (dBuV/m)	Margin (dB)	Remark	Ant. Pol. (H/V)
4904.000	36.20	5.31	41.51	74.00	-32.49	peak	V
4904.000	25.58	5.31	30.89	54.00	-23.11	AVG	V
7356.000	34.12	13.08	47.20	74.00	-26.80	peak	V
7356.000	23.70	13.08	36.78	54.00	-17.22	AVG	V
9808.000	33.03	17.60	50.63	74.00	-23.37	peak	V
N/A							
4904.000	36.24	5.31	41.55	74.00	-32.45	peak	H
4904.000	27.33	5.31	32.64	54.00	-21.36	AVG	H
7356.000	33.80	13.08	46.88	74.00	-27.12	peak	H
7356.000	20.91	13.08	33.99	54.00	-20.01	AVG	H
9808.000	33.04	17.60	50.64	74.00	-23.36	peak	H
N/A							

Remark:

1. Measuring frequencies from 1 GHz to the 10th harmonic of highest fundamental frequency.
2. Radiated emissions measured in frequency above 1000MHz were made with an instrument using peak/average detector mode.
3. Average test would be performed if the peak result were greater than the average limit or as required by the applicant.
4. Data of measurement within this frequency range shown " --- " in the table above means the reading of emissions are attenuated more than 20dB below the permissible limits or the field strength is too small to be measured.
5. Measurements above show only up to 6 maximum emissions noted, or would be lesser, with " N/A " remark, if no specific emissions from the EUT are recorded (ie: margin>20dB from the applicable limit) and considered that's already beyond the background noise floor.
6. Margin (dB) = Remark result (dBuV/m) – Average limit (dBuV/m).

7.8 POWERLINE CONDUCTED EMISSIONS

LIMIT

According to §15.207(a) & RSS-Gen §7.2.4, except as shown in paragraphs (b) and (c) of this section, for an intentional radiator that is designed to be connected to the public utility (AC) power line, the radio frequency voltage that is conducted back onto the AC power line on any frequency or frequencies within the band 150 kHz to 30 MHz shall not exceed the limits in the following table, as measured using a 50 μ H/50 ohms line impedance stabilization network (LISN). Compliance with the provisions of this paragraph shall be based on the measurement of the radio frequency voltage between each power line and ground at the power terminal. The lower limit applies at the boundary between the frequency ranges.

Frequency Range (MHz)	Limits (dB μ V)	
	Quasi-peak	Average
0.15 to 0.50	66 to 56*	56 to 46*
0.50 to 5	56	46
5 to 30	60	50

* Decreases with the logarithm of the frequency.

Test Configuration

See test photographs attached in Appendix II for the actual connections between EUT and support equipment.

TEST PROCEDURE

1. The EUT was placed on a table, which is 0.8m above ground plane.
2. Maximum procedure was performed on the six highest emissions to ensure EUT compliance.
3. Repeat above procedures until all frequency measured were complete.

TEST RESULTS

The initial step in collecting conducted data is a spectrum analyzer peak scan of the measurement range. Significant peaks are then marked as shown on the following data page, and these signals are then quasi-peaked.

Test Data

Operation Mode: Normal Link **Test Date:** June 2, 2016
Temperature: 24°C **Tested by:** Dennis Li
Humidity: 50% RH

Freq. (MHz)	QP Reading (dBuV)	AV Reading (dBuV)	Corr. factor (dB/m)	QP Result (dBuV/m)	AV Result (dBuV/m)	QP Limit (dBuV)	AV Limit (dBuV)	QP Margin (dB)	AV Margin (dB)	Note
0.1539	39.96	27.77	9.81	49.77	37.58	65.78	55.79	-16.01	-18.21	L1
0.1780	39.87	26.78	9.82	49.69	36.60	64.57	54.58	-14.88	-17.98	L1
0.1860	40.78	28.17	9.82	50.60	37.99	64.21	54.21	-13.61	-16.22	L1
0.2060	36.88	24.11	9.83	46.71	33.94	63.36	53.37	-16.65	-19.43	L1
0.2940	29.82	19.59	9.82	39.64	29.41	60.41	50.41	-20.77	-21.00	L1
0.3780	26.44	15.54	9.81	36.25	25.35	58.32	48.32	-22.07	-22.97	L1
0.5460	22.82	11.76	9.81	32.63	21.57	56.00	46.00	-23.37	-24.43	L1
14.3220	25.29	16.49	10.25	35.54	26.74	60.00	50.00	-24.46	-23.26	L1
0.1700	44.26	31.49	9.89	54.15	41.38	64.96	54.96	-10.81	-13.58	L2
0.1980	43.34	29.91	9.90	53.24	39.81	63.69	53.69	-10.45	-13.88	L2
0.2220	38.31	24.96	9.90	48.21	34.86	62.74	52.74	-14.53	-17.88	L2
0.2580	35.65	22.41	9.89	45.54	32.30	61.50	51.50	-15.96	-19.20	L2
0.4780	29.09	16.17	9.87	38.96	26.04	56.37	46.37	-17.41	-20.33	L2
0.5940	26.78	11.67	9.87	36.65	21.54	56.00	46.00	-19.35	-24.46	L2
14.8260	22.76	15.64	10.57	33.33	26.21	60.00	50.00	-26.67	-23.79	L2

Remark:

1. Measuring frequencies from 0.15 MHz to 30MHz.
2. The emissions measured in frequency range from 0.15 MHz to 30MHz were made with an instrument using Quasi-peak detector and average detector.
3. The IF bandwidth of SPA between 0.15MHz and 30MHz was 10 kHz; the IF bandwidth of Test Receiver between 0.15MHz and 30MHz was 9 kHz;
4. L1 = Line One (Live Line) / L2 = Line Two (Neutral Line)

Test Plots

Conducted emissions (Line 1)

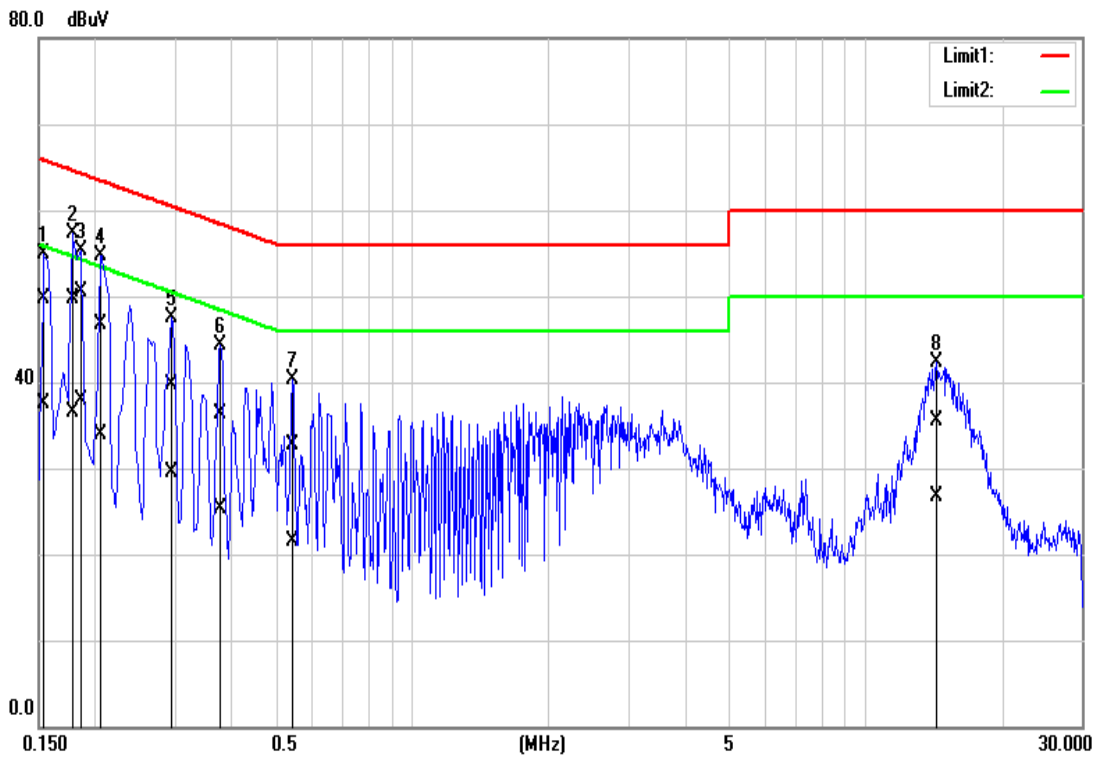

Conducted emissions (Line 2)

