

ELECTROMAGNETIC EMISSIONS COMPLIANCE REPORT

INTENTIONAL RADIATOR CERTIFICATION TO FCC PART 15 SUBPART C REQUIREMENT AND INDUSTRY CANADA RSS 210

OF

Product Name: Tablet Computer

Brand Name: acer

Marketing Name: A3-A30

Model No.: A5003

Model Difference: N/A

FCC ID: HLZA5003

IC: 1754F-A5003

Report No.: E2/2015/20017

Issue Date: Apr. 08, 2015

FCC Rule Part: §15.247, Cat: DTS

IC Rule Part: RSS-210 issue 8 :2010, Annex 8

Prepared for: Acer Incorporated
8F., No.88, Sec. 1, Hsintai 5th Rd., Hsichih, New Taipei
City 22181, Taiwan (R.O.C.)

Prepared by: SGS Taiwan Ltd.
Electronics & Communication Laboratory
No.2, Keji 1st Rd., Guishan District, Taoyuan City,
Taiwan 333



Note: This report shall not be reproduced except in full, without the written approval of SGS Taiwan Ltd. This document may be altered or revised by SGS Taiwan Ltd. Personnel only, and shall be noted in the revision section of the document.

Unless otherwise stated the results shown in this test report refer only to the sample(s) tested and such sample(s) are retained for 90 days only.

除非另有說明，此報告結果僅對測試之樣品負責，同時此樣品僅保留90天。本報告未經本公司書面許可，不可部份複製。

This document is issued by the Company subject to its General Conditions of Service printed overleaf, available on request or accessible at www.sgs.com/terms_and_conditions.htm and, for electronic format documents, subject to Terms and Conditions for Electronic Documents at www.sgs.com/terms_e-document.htm. Attention is drawn to the limitation of liability, indemnification and jurisdiction issues defined therein. Any holder of this document is advised that information contained hereon reflects the Company's findings at the time of its intervention only and within the limits of Client's instructions, if any. The Company's sole responsibility is to its Client and this document does not exonerate parties to a transaction from exercising all their rights and obligations under the transaction documents. This document cannot be reproduced except in full, without prior written approval of the Company. Any unauthorized alteration, forgery or falsification of the content or appearance of this document is unlawful and offenders may be prosecuted to the fullest extent of the law.

SGS Taiwan Ltd.

No.134,WuKungRoad,NewTaipeiIndustrialPark,WukuDistrict,NewTaipeiCity,Taiwan24803/新北市五股區新北產業園區五工路 134 號

台灣檢驗科技股份有限公司

t (886-2) 2299-3279

f (886-2) 2298-0488

www.tw.sgs.com

Member of SGS Group

VERIFICATION OF COMPLIANCE

Applicant: Acer Incorporated
8F., No.88, Sec. 1, Hsintai 5th Rd., Hsichih, New Taipei City 22181,
Taiwan (R.O.C.)

Product Name: Tablet Computer

Brand Name: 

Marketing Name: A3-A30

Model No.: A5003

Model Difference: N/A

FCC ID: HLZA5003

IC: 1754F-A5003

File Number: E2/2015/20017



Date of test: Feb. 25, 2015 ~ Apr. 08, 2015

Date of EUT Received: Feb. 25, 2015

We hereby certify that:

The above equipment was tested by SGS Taiwan Ltd. Electronics & Communication Laboratory. The test data, data evaluation, test procedures, and equipment configurations shown in this report were made in accordance with the procedures given in ANSI C63.10:2013 and the energy emitted by the sample EUT tested as described in this report is in compliance with conducted and radiated emission limits.

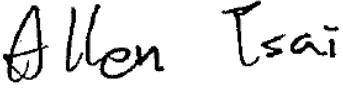
The test results of this report relate only to the tested sample identified in this report.

| | | | |
|---------------------|---|-------------|---------------|
| Test By: |  | Date | Apr. 08, 2015 |
| | <hr/> <i>Marcus Tseng / Engineer</i> | | |
| Prepared By: |  | Date | Apr. 08, 2015 |
| | <hr/> <i>Allen Tsai / Engineer</i> | | |
| Approved By: |  | Date | Apr. 08, 2015 |
| | <hr/> <i>Jim Chang / Asst. Manager</i> | | |

Unless otherwise stated the results shown in this test report refer only to the sample(s) tested and such sample(s) are retained for 90 days only.

除非另有說明，此報告結果僅對測試之樣品負責，同時此樣品僅保留90天。本報告未經本公司書面許可，不可部份複製。

This document is issued by the Company subject to its General Conditions of Service printed overleaf, available on request or accessible at www.sgs.com/terms_and_conditions.htm and, for electronic format documents, subject to Terms and Conditions for Electronic Documents at www.sgs.com/terms_e-document.htm. Attention is drawn to the limitation of liability, indemnification and jurisdiction issues defined therein. Any holder of this document is advised that information contained hereon reflects the Company's findings at the time of its intervention only and within the limits of Client's instructions, if any. The Company's sole responsibility is to its Client and this document does not exonerate parties to a transaction from exercising all their rights and obligations under the transaction documents. This document cannot be reproduced except in full, without prior written approval of the Company. Any unauthorized alteration, forgery or falsification of the content or appearance of this document is unlawful and offenders may be prosecuted to the fullest extent of the law.

Revision History

| Report Number | Revision | Description | Issue Date |
|---------------|----------|------------------------------|---------------|
| E2/2015/20017 | Rev.00 | Initial creation of document | Apr. 08, 2015 |
| | | | |
| | | | |
| | | | |

Unless otherwise stated the results shown in this test report refer only to the sample(s) tested and such sample(s) are retained for 90 days only.

除非另有說明，此報告結果僅對測試之樣品負責，同時此樣品僅保留90天。本報告未經本公司書面許可，不可部份複製。

This document is issued by the Company subject to its General Conditions of Service printed overleaf, available on request or accessible at www.sgs.com/terms_and_conditions.htm and, for electronic format documents, subject to Terms and Conditions for Electronic Documents at www.sgs.com/terms_e-document.htm. Attention is drawn to the limitation of liability, indemnification and jurisdiction issues defined therein. Any holder of this document is advised that information contained hereon reflects the Company's findings at the time of its intervention only and within the limits of Client's instructions, if any. The Company's sole responsibility is to its Client and this document does not exonerate parties to a transaction from exercising all their rights and obligations under the transaction documents. This document cannot be reproduced except in full, without prior written approval of the Company. Any unauthorized alteration, forgery or falsification of the content or appearance of this document is unlawful and offenders may be prosecuted to the fullest extent of the law.

SGS Taiwan Ltd.

No.134,WuKungRoad,NewTaipeiIndustrialPark,WukuDistrict,NewTaipeiCity,Taiwan24803/新北市五股區新北產業園區五工路 134 號

台灣檢驗科技股份有限公司

t (886-2) 2299-3279

f (886-2) 2298-0488

www.tw.sgs.com

Member of SGS Group

Table of Contents

| | | |
|----------|---|-----------|
| 1 | GENERAL INFORMATION..... | 6 |
| 1.1 | Product Description..... | 6 |
| 1.2 | Product Feature of Equipment Under Test | 7 |
| 1.3 | Test Methodology of Applied Standards | 8 |
| 1.4 | Test Facility | 8 |
| 1.5 | Special Accessories | 8 |
| 1.6 | Equipment Modifications | 8 |
| 2 | SYSTEM TEST CONFIGURATION..... | 9 |
| 2.1 | EUT Configuration..... | 9 |
| 2.2 | EUT Exercise | 9 |
| 2.3 | Test Procedure | 9 |
| 2.4 | Measurement Results Explanation Example..... | 9 |
| 2.5 | Configuration of Tested System | 10 |
| 3 | SUMMARY OF TEST RESULTS..... | 12 |
| 4 | DESCRIPTION OF TEST MODES..... | 12 |
| 4.1 | Operated in 2400 ~ 2483.5MHz Band | 12 |
| 4.2 | The Worst Test Modes and Channel Details | 13 |
| 5 | MEASUREMENT UNCERTAINTY | 14 |
| 6 | CONDUCTED EMISSION TEST | 15 |
| 6.1 | Standard Applicable: | 15 |
| 6.2 | Measurement Equipment Used: | 15 |
| 6.3 | EUT Setup:..... | 15 |
| 6.4 | Test SET-UP (Block Diagram of Configuration) | 16 |
| 6.5 | Measurement Procedure:..... | 16 |
| 6.6 | Measurement Result:..... | 16 |
| 7 | PEAK OUTPUT POWER MEASUREMENT | 21 |
| 7.1 | Standard Applicable: | 21 |
| 7.2 | Measurement Equipment Used: | 21 |
| 7.3 | Test Set-up:..... | 21 |
| 7.4 | Measurement Procedure:..... | 22 |
| 7.5 | Measurement Result:..... | 23 |
| 8 | 6dB BANDWIDTH & 99% POWER BANDWIDTH..... | 24 |
| 8.1 | Standard Applicable | 24 |
| 8.2 | Measurement Equipment Used | 24 |

Unless otherwise stated the results shown in this test report refer only to the sample(s) tested and such sample(s) are retained for 90 days only.

除非另有說明，此報告結果僅對測試之樣品負責，同時此樣品僅保留90天。本報告未經本公司書面許可，不可部份複製。

This document is issued by the Company subject to its General Conditions of Service printed overleaf, available on request or accessible at www.sgs.com/terms_and_conditions.htm and, for electronic format documents, subject to Terms and Conditions for Electronic Documents at www.sgs.com/terms_e-document.htm. Attention is drawn to the limitation of liability, indemnification and jurisdiction issues defined therein. Any holder of this document is advised that information contained hereon reflects the Company's findings at the time of its intervention only and within the limits of Client's instructions, if any. The Company's sole responsibility is to its Client and this document does not exonerate parties to a transaction from exercising all their rights and obligations under the transaction documents. This document cannot be reproduced except in full, without prior written approval of the Company. Any unauthorized alteration, forgery or falsification of the content or appearance of this document is unlawful and offenders may be prosecuted to the fullest extent of the law.

| | | |
|-----------|---|-----------|
| 8.3 | Test Set-up:..... | 24 |
| 8.4 | Measurement Procedure:..... | 24 |
| 8.5 | Measurement Result:..... | 25 |
| 9 | CONDUCTED BAND EDGES AND SPURIOUS EMISSION MEASUREMENT..... | 30 |
| 9.1 | Standard Applicable | 30 |
| 9.2 | Measurement Equipment Used: | 30 |
| 9.3 | Test SET-UP:..... | 30 |
| 10 | RADIATED BANDEDGE AND SPURIOUS EMISSION MEASUREMENT | 36 |
| 10.1 | Standard Applicable | 36 |
| 10.2 | Measurement Equipment Used | 37 |
| 10.3 | Test SET-UP | 38 |
| 10.4 | Measurement Procedure..... | 39 |
| 10.5 | Field Strength Calculation..... | 40 |
| 10.6 | Test Results of Radiated Spurious Emissions form 9 KHz to 30 MHz..... | 40 |
| 10.7 | Measurement Result:..... | 40 |
| 11 | PEAK POWER SPECTRAL DENSITY..... | 55 |
| 11.1 | Standard Applicable: | 55 |
| 11.2 | Measurement Equipment Used: | 55 |
| 11.3 | Test Set-up:..... | 55 |
| 11.4 | Measurement Procedure:..... | 55 |
| 11.5 | Measurement Result:..... | 56 |
| 12 | ANTENNA REQUIREMENT..... | 59 |
| 12.1 | Standard Applicable: | 59 |
| 12.2 | Antenna Connected Construction: | 59 |

Unless otherwise stated the results shown in this test report refer only to the sample(s) tested and such sample(s) are retained for 90 days only.

除非另有說明，此報告結果僅對測試之樣品負責，同時此樣品僅保留90天。本報告未經本公司書面許可，不可部份複製。

This document is issued by the Company subject to its General Conditions of Service printed overleaf, available on request or accessible at www.sgs.com/terms_and_conditions.htm and, for electronic format documents, subject to Terms and Conditions for Electronic Documents at www.sgs.com/terms_e-document.htm. Attention is drawn to the limitation of liability, indemnification and jurisdiction issues defined therein. Any holder of this document is advised that information contained hereon reflects the Company's findings at the time of its intervention only and within the limits of Client's instructions, if any. The Company's sole responsibility is to its Client and this document does not exonerate parties to a transaction from exercising all their rights and obligations under the transaction documents. This document cannot be reproduced except in full, without prior written approval of the Company. Any unauthorized alteration, forgery or falsification of the content or appearance of this document is unlawful and offenders may be prosecuted to the fullest extent of the law.

1 GENERAL INFORMATION

1.1 Product Description

General:

| | | |
|------------------------|---|---|
| Product Name: | Tablet Computer | |
| Brand Name: |  | |
| Marketing Name: | A3-A30 | |
| Model No.: | A5003 | |
| Model Difference: | N/A | |
| Product SW/HW version: | Acer_AV0L0_A3-A30_RV01RZ01_WW_CUS1 / E0 | |
| Radio SW/HW version: | 1.5.1.2 / WCN3620 | |
| Test SW Version: | 1.5.1.2 | |
| USB Cable | Model No.: 3080199058, Supplier: 坤記 | |
| Power Supply: | 3.8Vdc from Rechargeable Li-polymer Battery or 5.35V from AC/DC Adapter | |
| | Battery: | Model No.:AP14A4M, Supplier: SONY |
| | Adapter : | 1. Model No.: PA-1100-25, Supplier: LITEON. 2. Model No.: ADP-10HW A, Supplier: DELTA. |

Bluetooth Low Energy:

| | |
|-----------------------|---|
| Frequency Range: | 2402 – 2480MHz |
| Bluetooth Version: | V4.0 dual mode |
| Channel number: | 40 channels |
| Modulation type: | GFSK |
| Transmit Power: | 4.98dBm (Peak) |
| Emission Designation: | 1M05D1D |
| Antenna Designation: | PCB Wire Antenna, Gain: 1.9dBi Model No.: QTNKFWIPB01+A, Supplier: Wgt |

Unless otherwise stated the results shown in this test report refer only to the sample(s) tested and such sample(s) are retained for 90 days only.

除非另有說明，此報告結果僅對測試之樣品負責，同時此樣品僅保留90天。本報告未經本公司書面許可，不可部份複製。

This document is issued by the Company subject to its General Conditions of Service printed overleaf, available on request or accessible at www.sgs.com/terms_and_conditions.htm and, for electronic format documents, subject to Terms and Conditions for Electronic Documents at www.sgs.com/terms_e-document.htm. Attention is drawn to the limitation of liability, indemnification and jurisdiction issues defined therein. Any holder of this document is advised that information contained hereon reflects the Company's findings at the time of its intervention only and within the limits of Client's instructions, if any. The Company's sole responsibility is to its Client and this document does not exonerate parties to a transaction from exercising all their rights and obligations under the transaction documents. This document cannot be reproduced except in full, without prior written approval of the Company. Any unauthorized alteration, forgery or falsification of the content or appearance of this document is unlawful and offenders may be prosecuted to the fullest extent of the law.

1.2 Product Feature of Equipment Under Test

The equipment under Test (Hereafter Called: EUT) is mobile phone supporting, ,Wi-Fi 802.11abgn & ac, Bluetooth with NFC features, and below is details of information.

| Product Feature | |
|---------------------|---|
| Product Name: | Tablet Computer |
| Brand Name: |  |
| Type No.: | A3-A30 |
| Model Difference: | A5003 |
| FCC ID | HLZA5003 |
| IC ID | 1754F-A5003 |
| Wi-Fi Specification | 802.11a/b/g/n/ac |
| Bluetooth Version | V4.0 dual mode |
| NFC Specification | NFC |

Note: The above EUT information was declared by manufacturer. Please refer to the specifications or user's manual for more detailed description.

Unless otherwise stated the results shown in this test report refer only to the sample(s) tested and such sample(s) are retained for 90 days only.

除非另有說明，此報告結果僅對測試之樣品負責，同時此樣品僅保留90天。本報告未經本公司書面許可，不可部份複製。

This document is issued by the Company subject to its General Conditions of Service printed overleaf, available on request or accessible at www.sgs.com/terms_and_conditions.htm and, for electronic format documents, subject to Terms and Conditions for Electronic Documents at www.sgs.com/terms_e-document.htm. Attention is drawn to the limitation of liability, indemnification and jurisdiction issues defined therein. Any holder of this document is advised that information contained hereon reflects the Company's findings at the time of its intervention only and within the limits of Client's instructions, if any. The Company's sole responsibility is to its Client and this document does not exonerate parties to a transaction from exercising all their rights and obligations under the transaction documents. This document cannot be reproduced except in full, without prior written approval of the Company. Any unauthorized alteration, forgery or falsification of the content or appearance of this document is unlawful and offenders may be prosecuted to the fullest extent of the law.

SGS Taiwan Ltd.

No.134,WuKungRoad,NewTaipeiIndustrialPark,WukuDistrict,NewTaipeiCity,Taiwan24803/新北市五股區新北產業園區五工路 134 號

台灣檢驗科技股份有限公司

t (886-2) 2299-3279

f (886-2) 2298-0488

www.tw.sgs.com

Member of SGS Group

1.3 Test Methodology of Applied Standards

FCC Part 15, Subpart C §15.247

FCC KDB 558074 D01 DTS Meas. Guidance V03r02

ANSI C63.10:2013

IC RSS 210 issue 8:2010 Annex 8

RSS-Gen. issue 4

Note:

1. All test items have been performed and record as per the above standards.
2. The composite system is compliance with FCC Subpart B is authorized under the certification procedure.
3. The EUT was placed 1.5m height for frequency above 1GHz in accordance with ANSI C63.10:2013.

1.4 Test Facility

SGS Taiwan Ltd. Electronics & Communication Laboratory No.2, Keji 1st Rd., Guishan District, Taoyuan City, Taiwan. (TAF code 0513)

FCC Registration Numbers are: 628985

Canada Registration Number: 4620A

1.5 Special Accessories

There are no special accessories used while test was conducted.

1.6 Equipment Modifications

There was no modification incorporated into the EUT.

Unless otherwise stated the results shown in this test report refer only to the sample(s) tested and such sample(s) are retained for 90 days only.

除非另有說明，此報告結果僅對測試之樣品負責，同時此樣品僅保留90天。本報告未經本公司書面許可，不可部份複製。

This document is issued by the Company subject to its General Conditions of Service printed overleaf, available on request or accessible at www.sgs.com/terms_and_conditions.htm and, for electronic format documents, subject to Terms and Conditions for Electronic Documents at www.sgs.com/terms_e-document.htm. Attention is drawn to the limitation of liability, indemnification and jurisdiction issues defined therein. Any holder of this document is advised that information contained hereon reflects the Company's findings at the time of its intervention only and within the limits of Client's instructions, if any. The Company's sole responsibility is to its Client and this document does not exonerate parties to a transaction from exercising all their rights and obligations under the transaction documents. This document cannot be reproduced except in full, without prior written approval of the Company. Any unauthorized alteration, forgery or falsification of the content or appearance of this document is unlawful and offenders may be prosecuted to the fullest extent of the law.

2 SYSTEM TEST CONFIGURATION

2.1 EUT Configuration

The EUT configuration for testing is installed on RF field strength measurement to meet the Commissions requirement and operating in a manner which intends to maximize its emission characteristics in a continuous normal application.

2.2 EUT Exercise

An engineering test mode (software/firmware) that applicant provided was utilized to manipulate the EUT into transmit, selection of the test channel, and modulation scheme.

2.3 Test Procedure

2.3.1 Conducted Emissions

The EUT is a placed on as turn table which is 0.8 m above ground plane. Conducted emissions from the EUT measured in the frequency range between 0.15 MHz and 30MHz,. The CISPR Quasi-Peak and Average detector mode is employed according to §15.107. The two LISNs provide 50 ohm/ 50uH of coupling impedance for the measuring instrument. Both lines of the power mains connected to the EUT were checked for maximum conducted interference.

2.3.2 Radiated Emissions

The EUT is a placed on as turn table which is 0.8 m above ground plane. The turn table shall rotate 360 degrees to determine the position of maximum emission level. EUT is set 3m away from the receiving antenna which varied from 1m to 4m to find out the highest emission. And also, each emission was to be maximized by changing the polarization of receiving antenna both horizontal and vertical. In order to find out the max. emission, the relative positions of this hand-held transmitter (EUT) was rotated through three orthogonal axes and measurement procedures for electric field radiated emissions above 1 GHz the EUT measurement is to be made “while keeping the antenna in the ‘cone of radiation’ from that area and pointed at the area both in azimuth and elevation, with polarization oriented for maximum response.” is still within the 3dB illumination BW of the measurement antenna.

2.4 Measurement Results Explanation Example

For all conducted test items:

The offset level is set in the spectrum analyzer to compensate the RF cable loss and attenuation factor between EUT conducted port and spectrum analyzer. With the offset compensation, the spectrum analyzer reading level is exactly EUT RF output level.

Note:

The spectrum analyzer offset is derived from RF cable loss and attenuator factor.

Following shows an offset computation example with cable loss 1.4 dB.

Unless otherwise stated the results shown in this test report refer only to the sample(s) tested and such sample(s) are retained for 90 days only.

除非另有說明，此報告結果僅對測試之樣品負責，同時此樣品僅保留90天。本報告未經本公司書面許可，不可部份複製。

This document is issued by the Company subject to its General Conditions of Service printed overleaf, available on request or accessible at www.sgs.com/terms_and_conditions.htm and, for electronic format documents, subject to Terms and Conditions for Electronic Documents at www.sgs.com/terms_e-document.htm. Attention is drawn to the limitation of liability, indemnification and jurisdiction issues defined therein. Any holder of this document is advised that information contained hereon reflects the Company's findings at the time of its intervention only and within the limits of Client's instructions, if any. The Company's sole responsibility is to its Client and this document does not exonerate parties to a transaction from exercising all their rights and obligations under the transaction documents. This document cannot be reproduced except in full, without prior written approval of the Company. Any unauthorized alteration, forgery or falsification of the content or appearance of this document is unlawful and offenders may be prosecuted to the fullest extent of the law.

2.5 Configuration of Tested System

Fig. 2-1 Conducted (Antenna Port) Configuration

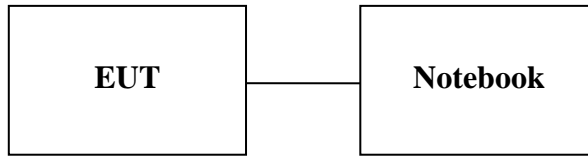

Fig. 2-2 Radiated Emission Configuration

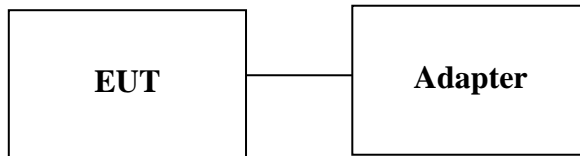

Table 2-1 Equipment Used in Tested System

| Item | Equipment | Mfr/Brand | Model/Type No. | Series No. | Data Cable | Power Cord |
|------|-------------------------|-----------|----------------|------------|------------|------------|
| 1. | Bluetooth Test Software | CSR2.3 | N/A | N/A | N/A | N/A |
| 2. | Notebook | Lenovo | L430 | R9-YYG88 | Shield | Un-shield |

Unless otherwise stated the results shown in this test report refer only to the sample(s) tested and such sample(s) are retained for 90 days only.

除非另有說明，此報告結果僅對測試之樣品負責，同時此樣品僅保留90天。本報告未經本公司書面許可，不可部份複製。

This document is issued by the Company subject to its General Conditions of Service printed overleaf, available on request or accessible at www.sgs.com/terms_and_conditions.htm and, for electronic format documents, subject to Terms and Conditions for Electronic Documents at www.sgs.com/terms_e-document.htm. Attention is drawn to the limitation of liability, indemnification and jurisdiction issues defined therein. Any holder of this document is advised that information contained hereon reflects the Company's findings at the time of its intervention only and within the limits of Client's instructions, if any. The Company's sole responsibility is to its Client and this document does not exonerate parties to a transaction from exercising all their rights and obligations under the transaction documents. This document cannot be reproduced except in full, without prior written approval of the Company. Any unauthorized alteration, forgery or falsification of the content or appearance of this document is unlawful and offenders may be prosecuted to the fullest extent of the law.

Fig. 2-2 AC Power Line Conducted Emission

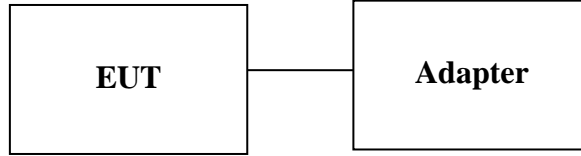

Table 2-2 Equipment Used in Tested System

| Item | Equipment | Mfr/Brand | Model/Type No. | Series No. | Data Cable | Power Cord |
|------|-------------------------|-----------|----------------|------------|------------|------------|
| 1. | Bluetooth Test Software | N/A | N/A | N/A | N/A | N/A |

Unless otherwise stated the results shown in this test report refer only to the sample(s) tested and such sample(s) are retained for 90 days only.

除非另有說明，此報告結果僅對測試之樣品負責，同時此樣品僅保留90天。本報告未經本公司書面許可，不可部份複製。

This document is issued by the Company subject to its General Conditions of Service printed overleaf, available on request or accessible at www.sgs.com/terms_and_conditions.htm and, for electronic format documents, subject to Terms and Conditions for Electronic Documents at www.sgs.com/terms_e-document.htm. Attention is drawn to the limitation of liability, indemnification and jurisdiction issues defined therein. Any holder of this document is advised that information contained hereon reflects the Company's findings at the time of its intervention only and within the limits of Client's instructions, if any. The Company's sole responsibility is to its Client and this document does not exonerate parties to a transaction from exercising all their rights and obligations under the transaction documents. This document cannot be reproduced except in full, without prior written approval of the Company. Any unauthorized alteration, forgery or falsification of the content or appearance of this document is unlawful and offenders may be prosecuted to the fullest extent of the law.

SGS Taiwan Ltd.

No.134,WuKungRoad,NewTaipeiIndustrialPark,WukuDistrict,NewTaipeiCity,Taiwan24803/新北市五股區新北產業園區五工路 134 號

台灣檢驗科技股份有限公司

t (886-2) 2299-3279

f (886-2) 2298-0488

www.tw.sgs.com

Member of SGS Group

3 SUMMARY OF TEST RESULTS

| FCC Rules | Description Of Test | Result |
|---|--|-----------|
| §15.207(a) RSS-Gen §8.8 | AC Power Line Conducted Emission | Compliant |
| §15.247(b) (3) RSS-210 §A8.4(4) | Peak Output Power | Compliant |
| §15.247(a)(2) RSS-210 §A8.2(a) RSS-Gen §6.6 | 6dB Bandwidth & 99% Power Bandwidth | Compliant |
| §15.247(d) RSS-210 §A8.5 | Conducted Band Edge and Spurious Emission | Compliant |
| §15.247(d) RSS-210 §A8.5 | Radiated Band Edge and Spurious Emission | Compliant |
| §15.247(e) RSS-210 §A8.2(b) | Peak Power Density | Compliant |
| §15.203 §15.247(b) RSS- Gen §6.7 RSS- Gen §8.3 | Antenna Requirement | Compliant |

4 DESCRIPTION OF TEST MODES

4.1 Operated in 2400 ~ 2483.5MHz Band

40 channels are provided for Bluetooth LE

| CHANNEL | FREQUENCY | CHANNEL | FREQUENCY | CHANNEL | FREQUENCY |
|---------|-----------|---------|-----------|---------|-----------|
| 0 | 2402 MHz | 14 | 2430 MHz | 28 | 2458 MHz |
| 1 | 2404 MHz | 15 | 2432 MHz | 29 | 2460 MHz |
| 2 | 2406 MHz | 16 | 2434 MHz | 30 | 2462 MHz |
| 3 | 2408 MHz | 17 | 2436 MHz | 31 | 2464 MHz |
| 4 | 2410 MHz | 18 | 2438 MHz | 32 | 2466 MHz |
| 5 | 2412 MHz | 19 | 2440 MHz | 33 | 2468 MHz |
| 6 | 2414 MHz | 20 | 2442 MHz | 34 | 2470 MHz |
| 7 | 2416MHz | 21 | 2444 MHz | 35 | 2472 MHz |
| 8 | 2418 MHz | 22 | 2446 MHz | 36 | 2474 MHz |
| 9 | 2420 MHz | 23 | 2448 MHz | 37 | 2476 MHz |
| 10 | 2422 MHz | 24 | 2450 MHz | 38 | 2478 MHz |
| 11 | 2424 MHz | 25 | 2452 MHz | 39 | 2480 MHz |
| 12 | 2426 MHz | 26 | 2454 MHz | | |
| 13 | 2428 MHz | 27 | 2456 MHz | | |

Unless otherwise stated the results shown in this test report refer only to the sample(s) tested and such sample(s) are retained for 90 days only.

除非另有說明，此報告結果僅對測試之樣品負責，同時此樣品僅保留90天。本報告未經本公司書面許可，不可部份複製。

This document is issued by the Company subject to its General Conditions of Service printed overleaf, available on request or accessible at www.sgs.com/terms_and_conditions.htm and, for electronic format documents, subject to Terms and Conditions for Electronic Documents at www.sgs.com/terms_e-document.htm. Attention is drawn to the limitation of liability, indemnification and jurisdiction issues defined therein. Any holder of this document is advised that information contained hereon reflects the Company's findings at the time of its intervention only and within the limits of Client's instructions, if any. The Company's sole responsibility is to its Client and this document does not exonerate parties to a transaction from exercising all their rights and obligations under the transaction documents. This document cannot be reproduced except in full, without prior written approval of the Company. Any unauthorized alteration, forgery or falsification of the content or appearance of this document is unlawful and offenders may be prosecuted to the fullest extent of the law.

4.2 The Worst Test Modes and Channel Details

1. The EUT has been tested under operating condition.
2. Test program used to control the EUT for staying in continuous transmitting and receiving mode is programmed.

RADIATED EMISSION TEST:

| RADIATED EMISSION TEST (BELOW 1 GHz) | | | | | |
|--------------------------------------|-------------------|----------------|------------|------------------|--------------|
| MODE | AVAILABLE CHANNEL | TESTED CHANNEL | MODULATION | DATA RATE (Mbps) | ANTENNA PORT |
| Bluetooth LE | 0 to 39 | 0,20,39 | GFSK | 1.0 | MAIN |
| RADIATED EMISSION TEST (ABOVE 1 GHz) | | | | | |
| MODE | AVAILABLE CHANNEL | TESTED CHANNEL | MODULATION | DATA RATE (Mbps) | ANTENNA PORT |
| Bluetooth LE | 0 to 39 | 0,20,39 | GFSK | 1.0 | MAIN |

Note:

The field strength of radiation emission was measured as EUT stand-up position (H mode) and lie down position (E1, E2 mode) for Bluetooth LE 4.1 Transmitter for channel Low, Mid and High, the worst case E2 position was reported.

ANTENNA PORT CONDUCTED MEASUREMENT:

| CONDUCTED TEST | | | | | |
|----------------|-------------------|----------------|------------|------------------|--------------|
| MODE | AVAILABLE CHANNEL | TESTED CHANNEL | MODULATION | DATA RATE (Mbps) | ANTENNA PORT |
| Bluetooth LE | 0 to 39 | 0,20,39 | GFSK | 1.0 | MAIN |

Unless otherwise stated the results shown in this test report refer only to the sample(s) tested and such sample(s) are retained for 90 days only.

除非另有說明，此報告結果僅對測試之樣品負責，同時此樣品僅保留90天。本報告未經本公司書面許可，不可部份複製。

This document is issued by the Company subject to its General Conditions of Service printed overleaf, available on request or accessible at www.sgs.com/terms_and_conditions.htm and, for electronic format documents, subject to Terms and Conditions for Electronic Documents at www.sgs.com/terms_e-document.htm. Attention is drawn to the limitation of liability, indemnification and jurisdiction issues defined therein. Any holder of this document is advised that information contained hereon reflects the Company's findings at the time of its intervention only and within the limits of Client's instructions, if any. The Company's sole responsibility is to its Client and this document does not exonerate parties to a transaction from exercising all their rights and obligations under the transaction documents. This document cannot be reproduced except in full, without prior written approval of the Company. Any unauthorized alteration, forgery or falsification of the content or appearance of this document is unlawful and offenders may be prosecuted to the fullest extent of the law.

5 MEASUREMENT UNCERTAINTY

| Test Items | Uncertainty |
|---|-----------------------------|
| AC Power Line Conducted Emission | +/- 2.586 dB |
| Peak Output Power | +/- 0.84 dB |
| 6dB Bandwidth | +/- 51.33 Hz |
| 100 KHz Bandwidth Of Frequency Band Edges | +/- 1.55 dB |
| Peak Power Density | +/- 1.3 dB |
| Temperature | +/- 0.65 °C |
| Humidity | +/- 4.6 % |
| DC / AC Power Source | DC= +/- 0.13%, AC= +/- 0.2% |

Radiated Spurious Emission:

| | |
|--|----------------------------|
| Measurement uncertainty (Polarization : Vertical) | 30MHz - 180MHz: +/- 3.37dB |
| | 180MHz -417MHz: +/- 3.19dB |
| | 0.417GHz-1GHz: +/- 3.19dB |
| | 1GHz - 18GHz: +/- 4.04dB |
| | 18GHz - 40GHz: +/- 4.04dB |

| | |
|--|----------------------------|
| Measurement uncertainty (Polarization : Horizontal) | 30MHz - 167MHz: +/- 4.22dB |
| | 167MHz -500MHz: +/- 3.44dB |
| | 0.5GHz-1GHz: +/- 3.39dB |
| | 1GHz - 18GHz: +/- 4.08dB |
| | 18GHz - 40GHz: +/- 4.08dB |

This uncertainty represents an expanded uncertainty expressed at approximately the 95% confidence level using a coverage factor of k=2.

Unless otherwise stated the results shown in this test report refer only to the sample(s) tested and such sample(s) are retained for 90 days only.

除非另有說明，此報告結果僅對測試之樣品負責，同時此樣品僅保留90天。本報告未經本公司書面許可，不可部份複製。

This document is issued by the Company subject to its General Conditions of Service printed overleaf, available on request or accessible at www.sgs.com/terms_and_conditions.htm and, for electronic format documents, subject to Terms and Conditions for Electronic Documents at www.sgs.com/terms_e-document.htm. Attention is drawn to the limitation of liability, indemnification and jurisdiction issues defined therein. Any holder of this document is advised that information contained hereon reflects the Company's findings at the time of its intervention only and within the limits of Client's instructions, if any. The Company's sole responsibility is to its Client and this document does not exonerate parties to a transaction from exercising all their rights and obligations under the transaction documents. This document cannot be reproduced except in full, without prior written approval of the Company. Any unauthorized alteration, forgery or falsification of the content or appearance of this document is unlawful and offenders may be prosecuted to the fullest extent of the law.

SGS Taiwan Ltd.

No.134,WuKungRoad,NewTaipeiIndustrialPark,WukuDistrict,NewTaipeiCity,Taiwan24803/新北市五股區新北產業園區五工路 134 號

台灣檢驗科技股份有限公司

t (886-2) 2299-3279

f (886-2) 2298-0488

www.tw.sgs.com

Member of SGS Group

6 CONDUCTED EMISSION TEST

6.1 Standard Applicable:

Frequency range within 150kHz to 30MHz shall not exceed the Limit table as below.

| Frequency range MHz | Limits dB(uV) | |
|------------------------|------------------|----------|
| | Quasi-peak | Average |
| 0.15 to 0.50 | 66 to 56 | 56 to 46 |
| 0.50 to 5 | 56 | 46 |
| 5 to 30 | 60 | 50 |

Note

- 1.The lower limit shall apply at the transition frequencies
- 2.The limit decreases linearly with the logarithm of the frequency in the range 0.15 MHz to 0.50 MHz.

6.2 Measurement Equipment Used:

| Conducted Emission Test Site | | | | | |
|------------------------------|-------------|-------------------|------------------|--------------|------------|
| EQUIPMENT TYPE | MFR | MODEL NUMBER | SERIAL NUMBER | LAST CAL. | CAL DUE. |
| EMI Test Receiver | R&S | ESCI 3 | 101311 | 06/20/2014 | 06/19/2015 |
| LISN | Schwarzbeck | NSLK 8127 | 8127-648 | 06/10/2014 | 06/09/2015 |
| LISN | Rolf-Heine | NNB-2/16Z | 99012 | 03/04/2015 | 03/03/2016 |
| Coaxial Cables | N/A | N30N30-1042-150cm | N/A | 01/06/2015 | 01/07/2016 |

6.3 EUT Setup:

1. The conducted emission tests were performed in the test site, using the setup in accordance with the ANSI C63.10:2013.
2. The AC/DC Power adaptor of EUT was plug-in LISN. The EUT was placed flushed with the rear of the table.
3. The LISN was connected with 120Vac/60Hz power source.

Unless otherwise stated the results shown in this test report refer only to the sample(s) tested and such sample(s) are retained for 90 days only.

除非另有說明，此報告結果僅對測試之樣品負責，同時此樣品僅保留90天。本報告未經本公司書面許可，不可部份複製。

This document is issued by the Company subject to its General Conditions of Service printed overleaf, available on request or accessible at www.sgs.com/terms_and_conditions.htm and, for electronic format documents, subject to Terms and Conditions for Electronic Documents at www.sgs.com/terms_e-document.htm. Attention is drawn to the limitation of liability, indemnification and jurisdiction issues defined therein. Any holder of this document is advised that information contained hereon reflects the Company's findings at the time of its intervention only and within the limits of Client's instructions, if any. The Company's sole responsibility is to its Client and this document does not exonerate parties to a transaction from exercising all their rights and obligations under the transaction documents. This document cannot be reproduced except in full, without prior written approval of the Company. Any unauthorized alteration, forgery or falsification of the content or appearance of this document is unlawful and offenders may be prosecuted to the fullest extent of the law.

SGS Taiwan Ltd.

台灣檢驗科技股份有限公司

No.134,WuKungRoad,NewTaipeiIndustrialPark,WukuDistrict,NewTaipeiCity,Taiwan24803/新北市五股區新北產業園區五工路 134 號

t (886-2) 2299-3279

f (886-2) 2298-0488

www.tw.sgs.com

Member of SGS Group

6.4 Test SET-UP (Block Diagram of Configuration)

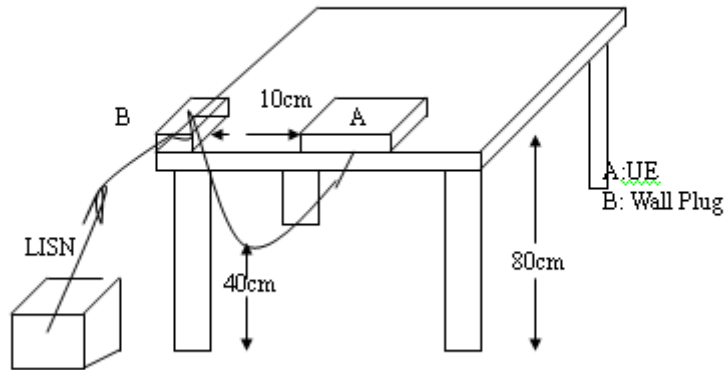

6.5 Measurement Procedure:

1. The EUT was placed on a table which is 0.8m above ground plane.
2. Maximum procedure was performed on the six highest emissions to ensure EUT compliance.
3. Repeat above procedures until all phases of power being supplied by given UE are completed

6.6 Measurement Result:

The initial step in collecting conducted data is a spectrum analyzer peak scan of the measurement range. Significant peaks are then marked as shown on the following data page, and these signals are then quasi-peaked.

Note: Refer to next page for measurement data and plots.

Note2: The * reveals the worst-case results that closet to the limit

Unless otherwise stated the results shown in this test report refer only to the sample(s) tested and such sample(s) are retained for 90 days only.

除非另有說明，此報告結果僅對測試之樣品負責，同時此樣品僅保留90天。本報告未經本公司書面許可，不可部份複製。

This document is issued by the Company subject to its General Conditions of Service printed overleaf, available on request or accessible at www.sgs.com/terms_and_conditions.htm and, for electronic format documents, subject to Terms and Conditions for Electronic Documents at www.sgs.com/terms_e-document.htm. Attention is drawn to the limitation of liability, indemnification and jurisdiction issues defined therein. Any holder of this document is advised that information contained hereon reflects the Company's findings at the time of its intervention only and within the limits of Client's instructions, if any. The Company's sole responsibility is to its Client and this document does not exonerate parties to a transaction from exercising all their rights and obligations under the transaction documents. This document cannot be reproduced except in full, without prior written approval of the Company. Any unauthorized alteration, forgery or falsification of the content or appearance of this document is unlawful and offenders may be prosecuted to the fullest extent of the law.

AC POWER LINE CONDUCTED EMISSION TEST DATA

| | | | |
|-----------------|----------------|------------|---------------|
| Operation Mode: | Operation mode | Test Date: | Mar. 26, 2015 |
| Temperature: | 21 | Humidity: | 70 % |
| Model No.: | PA-1100-25 | | |
| Phase: | L1 | | |

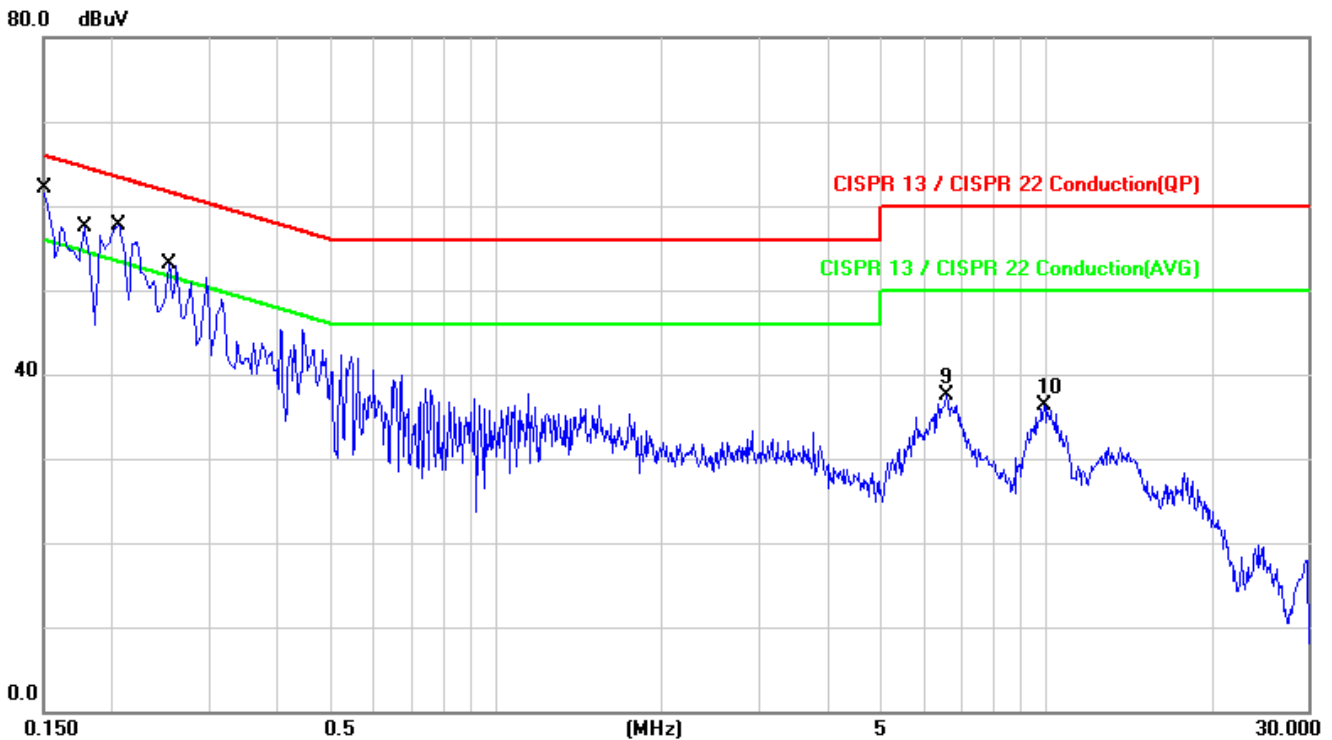

| No. | Mk. | Freq. (MHz) | Reading dBuV | Factor (dB) | Measurement (dBuV) | Limit (dBuV) | Over (dB) | Detector | Comment |
|-----|-----|----------------|-----------------|----------------|-----------------------|-----------------|--------------|----------|---------|
| 1 | * | 0.1516 | 54.40 | 0.12 | 54.52 | 65.91 | -11.39 | QP | |
| 2 | | 0.1516 | 38.70 | 0.12 | 38.82 | 55.91 | -17.09 | AVG | |
| 3 | | 0.1780 | 49.90 | 0.12 | 50.02 | 64.58 | -14.56 | QP | |
| 4 | | 0.1780 | 35.40 | 0.12 | 35.52 | 54.58 | -19.06 | AVG | |
| 5 | | 0.2060 | 50.80 | 0.12 | 50.92 | 63.37 | -12.45 | QP | |
| 6 | | 0.2060 | 37.30 | 0.12 | 37.42 | 53.37 | -15.95 | AVG | |
| 7 | | 0.2540 | 45.20 | 0.12 | 45.32 | 61.63 | -16.31 | QP | |
| 8 | | 0.2540 | 30.40 | 0.12 | 30.52 | 51.63 | -21.11 | AVG | |
| 9 | | 6.6020 | 37.11 | 0.32 | 37.43 | 60.00 | -22.57 | peak | |
| 10 | | 9.9580 | 35.91 | 0.40 | 36.31 | 60.00 | -23.69 | peak | |

Unless otherwise stated the results shown in this test report refer only to the sample(s) tested and such sample(s) are retained for 90 days only.

除非另有說明，此報告結果僅對測試之樣品負責，同時此樣品僅保留90天。本報告未經本公司書面許可，不可部份複製。

This document is issued by the Company subject to its General Conditions of Service printed overleaf, available on request or accessible at www.sgs.com/terms_and_conditions.htm and, for electronic format documents, subject to Terms and Conditions for Electronic Documents at www.sgs.com/terms_e-document.htm. Attention is drawn to the limitation of liability, indemnification and jurisdiction issues defined therein. Any holder of this document is advised that information contained hereon reflects the Company's findings at the time of its intervention only and within the limits of Client's instructions, if any. The Company's sole responsibility is to its Client and this document does not exonerate parties to a transaction from exercising all their rights and obligations under the transaction documents. This document cannot be reproduced except in full, without prior written approval of the Company. Any unauthorized alteration, forgery or falsification of the content or appearance of this document is unlawful and offenders may be prosecuted to the fullest extent of the law.

SGS Taiwan Ltd.

No. 134, WuKung Road, New Taipei Industrial Park, Wuku District, New Taipei City, Taiwan 24803 / 新北市五股區新北產業園區五工路 134 號

台灣檢驗科技股份有限公司

t (886-2) 2299-3279

f (886-2) 2298-0488

www.tw.sgs.com

Member of SGS Group

| | | | | | |
|-----------------|----------------|-----------|------------|---------------|------|
| Operation Mode: | Operation mode | | Test Date: | Mar. 26, 2015 | |
| Temperature: | 21 | Humidity: | 70 % | Test By: | Vito |
| Model No.: | PA-1100-25 | | | | |
| Phase: | N | | | | |

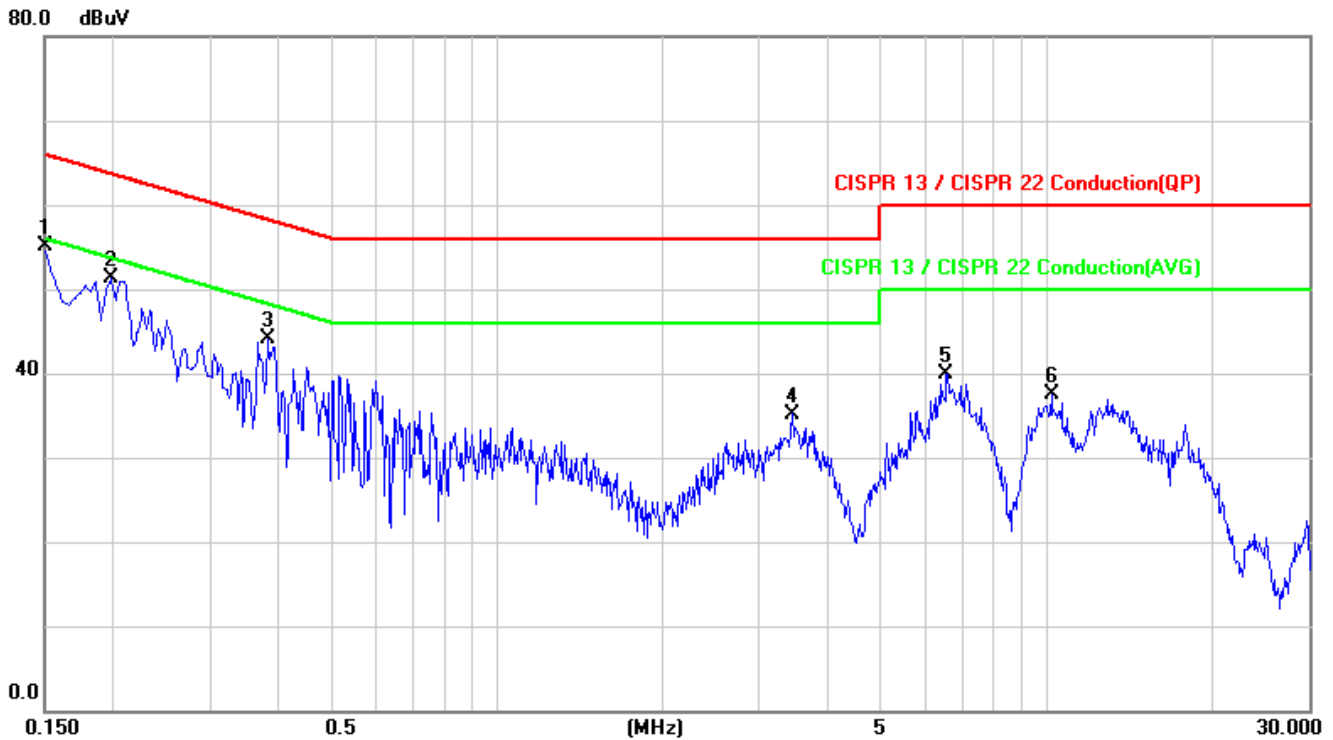

| No. | Mk. | Freq. (MHz) | Reading dBuV | Factor (dB) | Measurement (dBuV) | Limit (dBuV) | Over (dB) | Detector | Comment |
|-----|-----|----------------|-----------------|----------------|-----------------------|-----------------|--------------|----------|---------|
| 1 | * | 0.1500 | 54.98 | 0.12 | 55.10 | 66.00 | -10.90 | peak | |
| 2 | | 0.1980 | 51.17 | 0.12 | 51.29 | 63.69 | -12.40 | peak | |
| 3 | | 0.3820 | 44.01 | 0.12 | 44.13 | 58.24 | -14.11 | peak | |
| 4 | | 3.4420 | 34.97 | 0.23 | 35.20 | 56.00 | -20.80 | peak | |
| 5 | | 6.5700 | 39.54 | 0.32 | 39.86 | 60.00 | -20.14 | peak | |
| 6 | | 10.2220 | 37.06 | 0.40 | 37.46 | 60.00 | -22.54 | peak | |

Unless otherwise stated the results shown in this test report refer only to the sample(s) tested and such sample(s) are retained for 90 days only.

除非另有說明，此報告結果僅對測試之樣品負責，同時此樣品僅保留90天。本報告未經本公司書面許可，不可部份複製。

This document is issued by the Company subject to its General Conditions of Service printed overleaf, available on request or accessible at www.sgs.com/terms_and_conditions.htm and, for electronic format documents, subject to Terms and Conditions for Electronic Documents at www.sgs.com/terms_e-document.htm. Attention is drawn to the limitation of liability, indemnification and jurisdiction issues defined therein. Any holder of this document is advised that information contained hereon reflects the Company's findings at the time of its intervention only and within the limits of Client's instructions, if any. The Company's sole responsibility is to its Client and this document does not exonerate parties to a transaction from exercising all their rights and obligations under the transaction documents. This document cannot be reproduced except in full, without prior written approval of the Company. Any unauthorized alteration, forgery or falsification of the content or appearance of this document is unlawful and offenders may be prosecuted to the fullest extent of the law.

| | | | | | |
|-----------------|----------------|-----------|------------|---------------|------|
| Operation Mode: | Operation mode | | Test Date: | Mar. 26, 2015 | |
| Temperature: | 21 | Humidity: | 70 % | Test By: | Vito |
| Model No.: | ADP-10HW | | | | |
| Phase: | L1 | | | | |

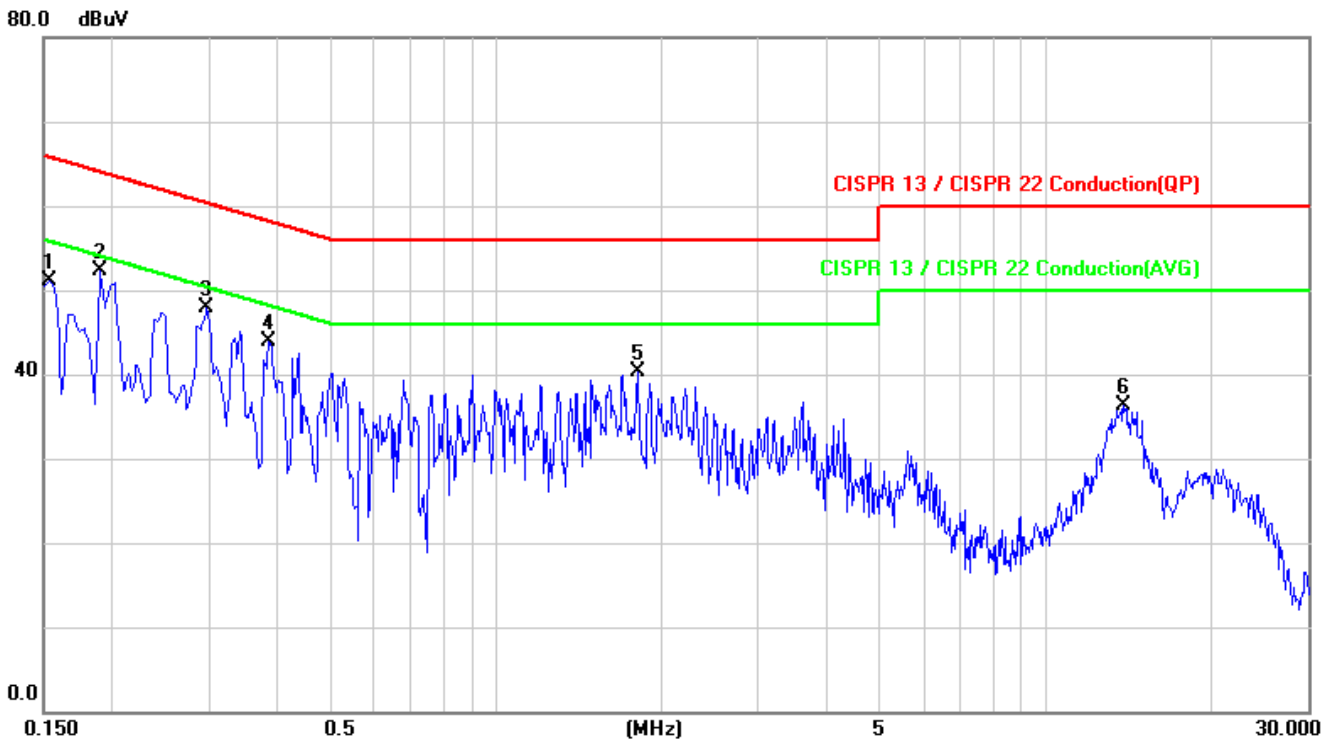

| No. | Mk. | Freq. (MHz) | Reading dBuV | Factor (dB) | Measurement (dBuV) | Limit (dBuV) | Over (dB) | Detector | Comment |
|-----|-----|----------------|-----------------|----------------|-----------------------|-----------------|--------------|----------|---------|
| 1 | | 0.1540 | 51.09 | 0.05 | 51.14 | 65.78 | -14.64 | peak | |
| 2 | * | 0.1900 | 52.36 | 0.04 | 52.40 | 64.04 | -11.64 | peak | |
| 3 | | 0.2980 | 47.91 | 0.08 | 47.99 | 60.30 | -12.31 | peak | |
| 4 | | 0.3860 | 43.70 | 0.12 | 43.82 | 58.15 | -14.33 | peak | |
| 5 | | 1.8100 | 39.79 | 0.49 | 40.28 | 56.00 | -15.72 | peak | |
| 6 | | 13.8420 | 35.89 | 0.37 | 36.26 | 60.00 | -23.74 | peak | |

Unless otherwise stated the results shown in this test report refer only to the sample(s) tested and such sample(s) are retained for 90 days only.

除非另有說明，此報告結果僅對測試之樣品負責，同時此樣品僅保留90天。本報告未經本公司書面許可，不可部份複製。

This document is issued by the Company subject to its General Conditions of Service printed overleaf, available on request or accessible at www.sgs.com/terms_and_conditions.htm and, for electronic format documents, subject to Terms and Conditions for Electronic Documents at www.sgs.com/terms_e-document.htm. Attention is drawn to the limitation of liability, indemnification and jurisdiction issues defined therein. Any holder of this document is advised that information contained hereon reflects the Company's findings at the time of its intervention only and within the limits of Client's instructions, if any. The Company's sole responsibility is to its Client and this document does not exonerate parties to a transaction from exercising all their rights and obligations under the transaction documents. This document cannot be reproduced except in full, without prior written approval of the Company. Any unauthorized alteration, forgery or falsification of the content or appearance of this document is unlawful and offenders may be prosecuted to the fullest extent of the law.

SGS Taiwan Ltd.

No. 134, WuKung Road, New Taipei Industrial Park, Wuku District, New Taipei City, Taiwan 24803 / 新北市五股區新北產業園區五工路 134 號

台灣檢驗科技股份有限公司

t (886-2) 2299-3279

f (886-2) 2298-0488

www.tw.sgs.com

Member of SGS Group

| | | | | | |
|-----------------|----------------|-----------|------------|---------------|------|
| Operation Mode: | Operation mode | | Test Date: | Mar. 26, 2015 | |
| Temperature: | 21 | Humidity: | 70 % | Test By: | Vito |
| Model No.: | ADP-10HW | | | | |
| Phase: | N | | | | |

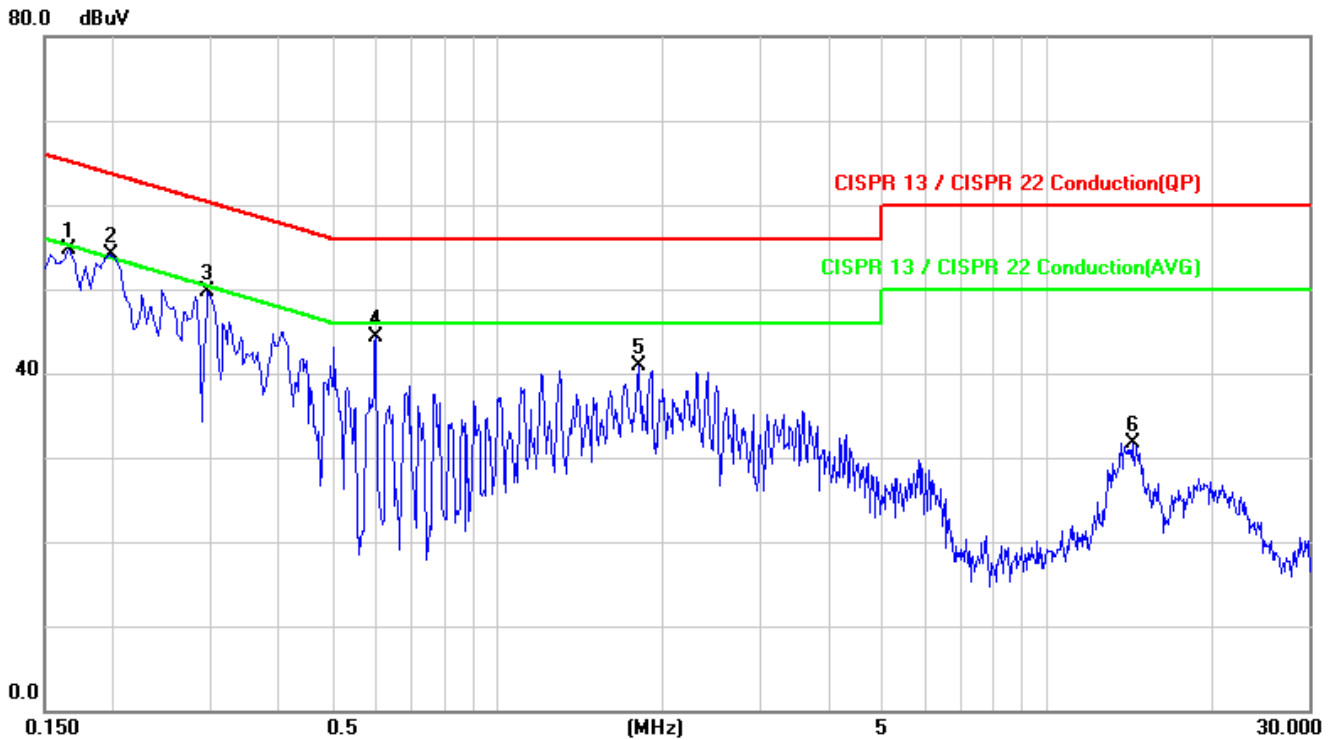

| No. | Mk. | Freq. (MHz) | Reading dBuV | Factor (dB) | Measurement (dBuV) | Limit (dBuV) | Over (dB) | Detector | Comment |
|-----|-----|----------------|-----------------|----------------|-----------------------|-----------------|--------------|----------|---------|
| 1 | | 0.1660 | 54.71 | 0.05 | 54.76 | 65.16 | -10.40 | peak | |
| 2 | * | 0.1980 | 54.01 | 0.04 | 54.05 | 63.69 | -9.64 | peak | |
| 3 | | 0.2980 | 49.53 | 0.08 | 49.61 | 60.30 | -10.69 | peak | |
| 4 | | 0.6020 | 44.17 | 0.21 | 44.38 | 56.00 | -11.62 | peak | |
| 5 | | 1.8100 | 40.47 | 0.49 | 40.96 | 56.00 | -15.04 | peak | |
| 6 | | 14.3260 | 31.45 | 0.35 | 31.80 | 60.00 | -28.20 | peak | |

Unless otherwise stated the results shown in this test report refer only to the sample(s) tested and such sample(s) are retained for 90 days only.

除非另有說明，此報告結果僅對測試之樣品負責，同時此樣品僅保留90天。本報告未經本公司書面許可，不可部份複製。

This document is issued by the Company subject to its General Conditions of Service printed overleaf, available on request or accessible at www.sgs.com/terms_and_conditions.htm and, for electronic format documents, subject to Terms and Conditions for Electronic Documents at www.sgs.com/terms_e-document.htm. Attention is drawn to the limitation of liability, indemnification and jurisdiction issues defined therein. Any holder of this document is advised that information contained hereon reflects the Company's findings at the time of its intervention only and within the limits of Client's instructions, if any. The Company's sole responsibility is to its Client and this document does not exonerate parties to a transaction from exercising all their rights and obligations under the transaction documents. This document cannot be reproduced except in full, without prior written approval of the Company. Any unauthorized alteration, forgery or falsification of the content or appearance of this document is unlawful and offenders may be prosecuted to the fullest extent of the law.

SGS Taiwan Ltd.

No. 134, WuKungRoad, NewTaipeiIndustrialPark, WukuDistrict, NewTaipeiCity, Taiwan24803/新北市五股區新北產業園區五工路 134 號

台灣檢驗科技股份有限公司

t (886-2) 2299-3279

f (886-2) 2298-0488

www.tw.sgs.com

Member of SGS Group

7 PEAK OUTPUT POWER MEASUREMENT

7.1 Standard Applicable:

For systems using digital modulation in the 2400-2483.5 MHz bands, the limit for peak output power is 1Watt.

If the transmitting antenna of directional gain greater than 6dBi are used the peak output power form the intentional radiator shall be reduced below the above stated value by the amount in dB that the directional gain of the Antenna exceeds 6dBi.

In case of point-to-point operation, the limit has to be reduced by 1dB for every 3dB that the directional gain of Antenna exceeds 6dBi.

7.2 Measurement Equipment Used:

| Conducted Emission Test Site | | | | | |
|------------------------------|-----------|--------------|---------------|------------|------------|
| EQUIPMENT TYPE | MFR | MODEL NUMBER | SERIAL NUMBER | LAST CAL. | CAL DUE. |
| Power Meter | Anritsu | ML2496A | 1326001 | 06/21/2014 | 06/20/2015 |
| Power Sensor | Anritsu | MA2411B | 1315048 | 06/21/2014 | 06/20/2015 |
| Spectrum Analyzer | Agilent | N9010A | MY53400256 | 10/15/2014 | 10/14/2015 |
| DC Block | PASTERNAK | PE8210 | RF29 | 12/19/2014 | 12/18/2015 |
| Attenuator | WOKEN | 218FS-10 | RF23 | 12/19/2014 | 12/18/2015 |
| Splitter | RF-LAMBAD | RFLT2W1G18G | RF35 | 12/19/2014 | 12/18/2015 |

7.3 Test Set-up:



Unless otherwise stated the results shown in this test report refer only to the sample(s) tested and such sample(s) are retained for 90 days only.

除非另有說明，此報告結果僅對測試之樣品負責，同時此樣品僅保留90天。本報告未經本公司書面許可，不可部份複製。

This document is issued by the Company subject to its General Conditions of Service printed overleaf, available on request or accessible at www.sgs.com/terms_and_conditions.htm and, for electronic format documents, subject to Terms and Conditions for Electronic Documents at www.sgs.com/terms_e-document.htm. Attention is drawn to the limitation of liability, indemnification and jurisdiction issues defined therein. Any holder of this document is advised that information contained hereon reflects the Company's findings at the time of its intervention only and within the limits of Client's instructions, if any. The Company's sole responsibility is to its Client and this document does not exonerate parties to a transaction from exercising all their rights and obligations under the transaction documents. This document cannot be reproduced except in full, without prior written approval of the Company. Any unauthorized alteration, forgery or falsification of the content or appearance of this document is unlawful and offenders may be prosecuted to the fullest extent of the law.

SGS Taiwan Ltd.

No. 134, WuKungRoad, NewTaipeiIndustrialPark, WukuDistrict, NewTaipeiCity, Taiwan24803/新北市五股區新北產業園區五工路 134 號

台灣檢驗科技股份有限公司

t (886-2) 2299-3279

f (886-2) 2298-0488

www.tw.sgs.com

Member of SGS Group

7.4 Measurement Procedure:

1. Place the EUT on the table and set it in transmitting mode.
2. The testing follows the Measurement Procedure of FCC KDB 558074 D01 DTS Meas. Guidance V03r02.
3. Remove the antenna from the EUT and then connect a low loss RF cable from the antenna port to the power meter.

Power Meter:

It is used as the auxiliary test equipment to conduct the output power measurement.

4. Record the max. Reading as observed from Power Meter.
5. Repeat above procedures until all test default channel measured was complete.

Duty Factor:



Unless otherwise stated the results shown in this test report refer only to the sample(s) tested and such sample(s) are retained for 90 days only.

除非另有說明，此報告結果僅對測試之樣品負責，同時此樣品僅保留90天。本報告未經本公司書面許可，不可部份複製。

This document is issued by the Company subject to its General Conditions of Service printed overleaf, available on request or accessible at www.sgs.com/terms_and_conditions.htm and, for electronic format documents, subject to Terms and Conditions for Electronic Documents at www.sgs.com/terms_e-document.htm. Attention is drawn to the limitation of liability, indemnification and jurisdiction issues defined therein. Any holder of this document is advised that information contained hereon reflects the Company's findings at the time of its intervention only and within the limits of Client's instructions, if any. The Company's sole responsibility is to its Client and this document does not exonerate parties to a transaction from exercising all their rights and obligations under the transaction documents. This document cannot be reproduced except in full, without prior written approval of the Company. Any unauthorized alteration, forgery or falsification of the content or appearance of this document is unlawful and offenders may be prosecuted to the fullest extent of the law.

7.5 Measurement Result:

BT4.0 mode:

| CH | Frequency (MHz) | Peak Power Output(dBm) | Required Limit |
|----|-----------------|------------------------|-----------------|
| 0 | 2402 | 2.77 | 1 Watt = 30 dBm |
| 20 | 2442 | 4.54 | 1 Watt = 30 dBm |
| 39 | 2480 | 4.98 | 1 Watt = 30 dBm |

| CH | Frequency (MHz) | Average Power Output(dBm) | Required Limit |
|----|-----------------|---------------------------|-----------------|
| 0 | 2402 | 0.57 | 1 Watt = 30 dBm |
| 20 | 2442 | 2.32 | 1 Watt = 30 dBm |
| 39 | 2480 | 2.76 | 1 Watt = 30 dBm |

**Note: Measured by power meter, as cable loss+ Duty cycle factor that offsets on the power meter*

Unless otherwise stated the results shown in this test report refer only to the sample(s) tested and such sample(s) are retained for 90 days only.

除非另有說明，此報告結果僅對測試之樣品負責，同時此樣品僅保留90天。本報告未經本公司書面許可，不可部份複製。

This document is issued by the Company subject to its General Conditions of Service printed overleaf, available on request or accessible at www.sgs.com/terms_and_conditions.htm and, for electronic format documents, subject to Terms and Conditions for Electronic Documents at www.sgs.com/terms_e-document.htm. Attention is drawn to the limitation of liability, indemnification and jurisdiction issues defined therein. Any holder of this document is advised that information contained hereon reflects the Company's findings at the time of its intervention only and within the limits of Client's instructions, if any. The Company's sole responsibility is to its Client and this document does not exonerate parties to a transaction from exercising all their rights and obligations under the transaction documents. This document cannot be reproduced except in full, without prior written approval of the Company. Any unauthorized alteration, forgery or falsification of the content or appearance of this document is unlawful and offenders may be prosecuted to the fullest extent of the law.

SGS Taiwan Ltd.

No.134,WuKungRoad,NewTaipeiIndustrialPark,WukuDistrict,NewTaipeiCity,Taiwan24803/新北市五股區新北產業園區五工路 134 號

台灣檢驗科技股份有限公司

t (886-2) 2299-3279

f (886-2) 2298-0488

www.tw.sgs.com

Member of SGS Group

8 6dB BANDWIDTH & 99% POWER BANDWIDTH

8.1 Standard Applicable

The minimum 6 dB bandwidth shall be at least 500 kHz .

8.2 Measurement Equipment Used

| Conducted Emission Test Site | | | | | |
|------------------------------|-----------|--------------|---------------|------------|------------|
| EQUIPMENT TYPE | MFR | MODEL NUMBER | SERIAL NUMBER | LAST CAL. | CAL DUE. |
| Spectrum Analyzer | Agilent | N9010A | MY53400256 | 10/15/2014 | 10/14/2015 |
| DC Block | PASTERNAK | PE8210 | RF29 | 12/19/2014 | 12/18/2015 |
| Attenuator | WOKEN | 218FS-10 | RF23 | 12/19/2014 | 12/18/2015 |

8.3 Test Set-up:

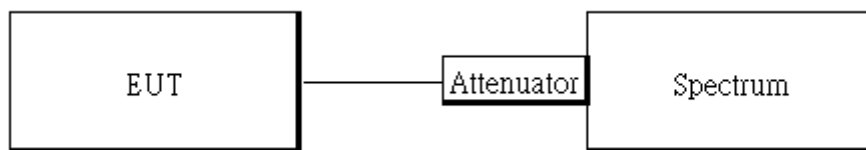

8.4 Measurement Procedure:

1. Place the EUT on the table and set it in transmitting mode.
2. The testing follows the Measurement Procedure of FCC KDB 558074 D01 DTS Meas. Guidance V03r02.
2. Remove the antenna from the EUT and then connect a low loss RF cable from the antenna port to the spectrum analyzer.
3. Set the spectrum analyzer as RBW = 100 kHz, VBW = 3*RBW, Span = 5MHz, Detector=Peak, Sweep=auto.
4. Mark the peak frequency and -6dB (upper and lower) frequency.
5. Repeat above procedures until all test default channel measured were complete.

Unless otherwise stated the results shown in this test report refer only to the sample(s) tested and such sample(s) are retained for 90 days only.

除非另有說明，此報告結果僅對測試之樣品負責，同時此樣品僅保留90天。本報告未經本公司書面許可，不可部份複製。

This document is issued by the Company subject to its General Conditions of Service printed overleaf, available on request or accessible at www.sgs.com/terms_and_conditions.htm and, for electronic format documents, subject to Terms and Conditions for Electronic Documents at www.sgs.com/terms_e-document.htm. Attention is drawn to the limitation of liability, indemnification and jurisdiction issues defined therein. Any holder of this document is advised that information contained hereon reflects the Company's findings at the time of its intervention only and within the limits of Client's instructions, if any. The Company's sole responsibility is to its Client and this document does not exonerate parties to a transaction from exercising all their rights and obligations under the transaction documents. This document cannot be reproduced except in full, without prior written approval of the Company. Any unauthorized alteration, forgery or falsification of the content or appearance of this document is unlawful and offenders may be prosecuted to the fullest extent of the law.

8.5 Measurement Result:

BT4.0 mode

| Frequency (MHz) | Bandwidth (kHz) | Bandwidth (kHz) | Result |
|-----------------|-----------------|-----------------|--------|
| 2402 | 721.9 | > 500 | PASS |
| 2442 | 722.4 | > 500 | PASS |
| 2480 | 720.3 | > 500 | PASS |

BT4.0 mode

| Frequency MHz | 99%Bandwidth (MHz) |
|---------------|--------------------|
| 2402 | 1.0451 |
| 2442 | 1.0460 |
| 2480 | 1.0471 |

Note: Refer to next page for plots.

Unless otherwise stated the results shown in this test report refer only to the sample(s) tested and such sample(s) are retained for 90 days only.

除非另有說明，此報告結果僅對測試之樣品負責，同時此樣品僅保留90天。本報告未經本公司書面許可，不可部份複製。

This document is issued by the Company subject to its General Conditions of Service printed overleaf, available on request or accessible at www.sgs.com/terms_and_conditions.htm and, for electronic format documents, subject to Terms and Conditions for Electronic Documents at www.sgs.com/terms_e-document.htm. Attention is drawn to the limitation of liability, indemnification and jurisdiction issues defined therein. Any holder of this document is advised that information contained hereon reflects the Company's findings at the time of its intervention only and within the limits of Client's instructions, if any. The Company's sole responsibility is to its Client and this document does not exonerate parties to a transaction from exercising all their rights and obligations under the transaction documents. This document cannot be reproduced except in full, without prior written approval of the Company. Any unauthorized alteration, forgery or falsification of the content or appearance of this document is unlawful and offenders may be prosecuted to the fullest extent of the law.

SGS Taiwan Ltd.

No.134,WuKungRoad,NewTaipeiIndustrialPark,WukuDistrict,NewTaipeiCity,Taiwan24803/新北市五股區新北產業園區五工路 134 號

台灣檢驗科技股份有限公司

t (886-2) 2299-3279

f (886-2) 2298-0488

www.tw.sgs.com

Member of SGS Group

BT4.0 mode 6dB Band Width Test Data CH-Low

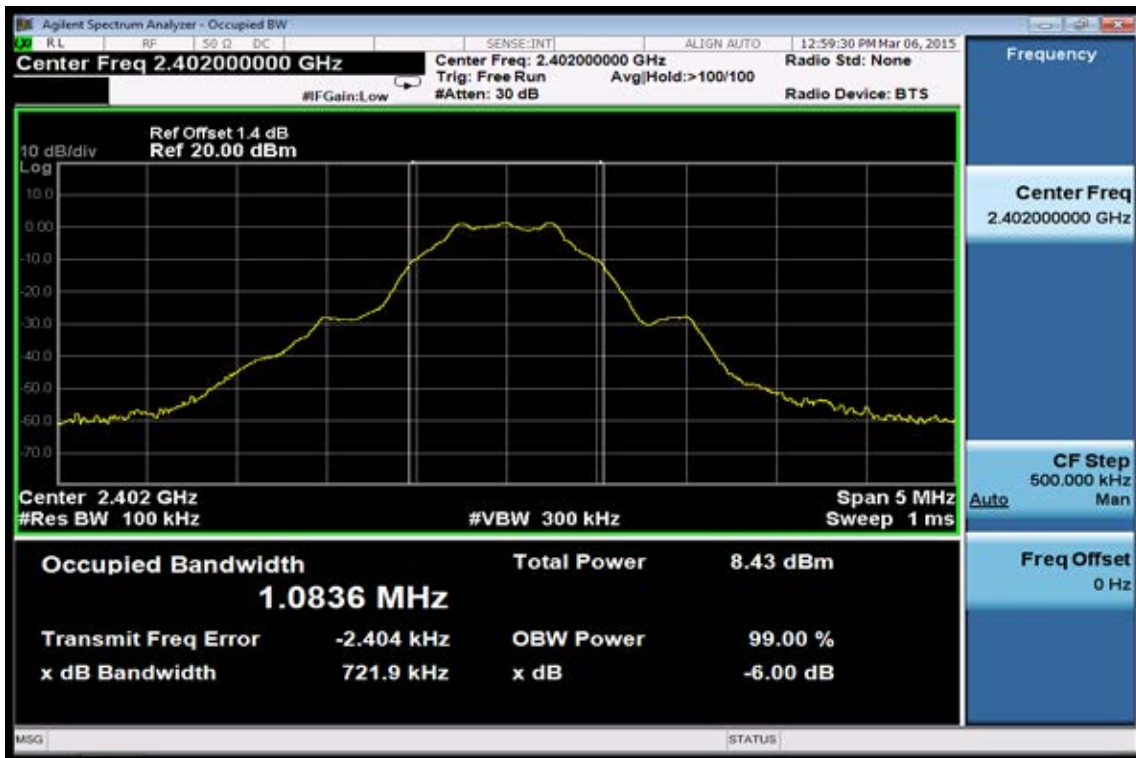

6dB Band Width Test Data CH-Mid

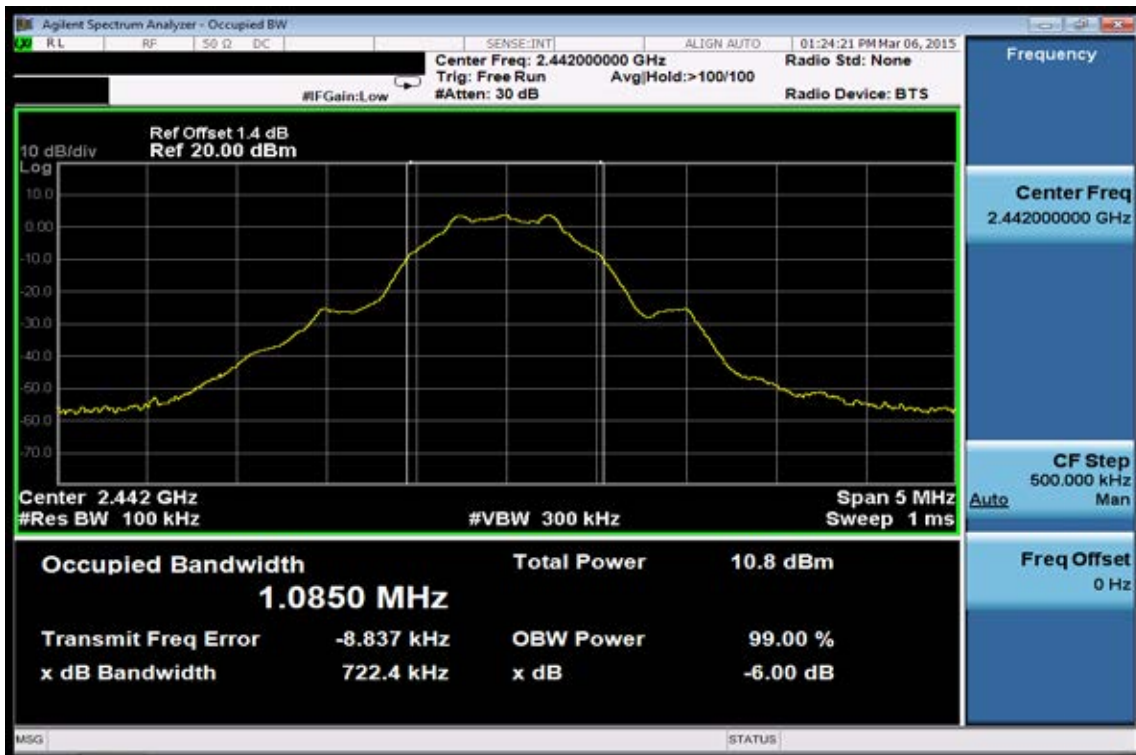

Unless otherwise stated the results shown in this test report refer only to the sample(s) tested and such sample(s) are retained for 90 days only.

除非另有說明，此報告結果僅對測試之樣品負責，同時此樣品僅保留90天。本報告未經本公司書面許可，不可部份複製。

This document is issued by the Company subject to its General Conditions of Service printed overleaf, available on request or accessible at www.sgs.com/terms_and_conditions.htm and, for electronic format documents, subject to Terms and Conditions for Electronic Documents at www.sgs.com/terms_e-document.htm. Attention is drawn to the limitation of liability, indemnification and jurisdiction issues defined therein. Any holder of this document is advised that information contained hereon reflects the Company's findings at the time of its intervention only and within the limits of Client's instructions, if any. The Company's sole responsibility is to its Client and this document does not exonerate parties to a transaction from exercising all their rights and obligations under the transaction documents. This document cannot be reproduced except in full, without prior written approval of the Company. Any unauthorized alteration, forgery or falsification of the content or appearance of this document is unlawful and offenders may be prosecuted to the fullest extent of the law.

SGS Taiwan Ltd.

No. 134, WuKungRoad, NewTaipeiIndustrialPark, WukuDistrict, NewTaipeiCity, Taiwan24803/新北市五股區新北產業園區五工路 134 號

台灣檢驗科技股份有限公司

t (886-2) 2299-3279

f (886-2) 2298-0488

www.tw.sgs.com

Member of SGS Group

6dB Band Width Test Data CH-High

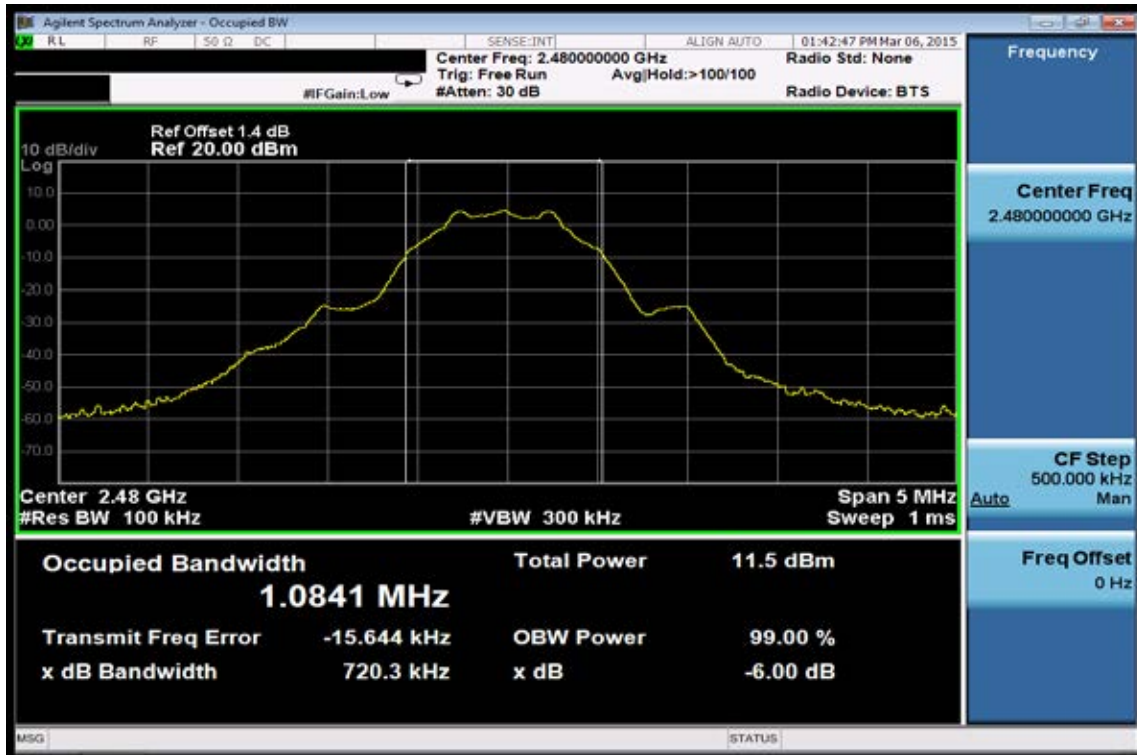

Unless otherwise stated the results shown in this test report refer only to the sample(s) tested and such sample(s) are retained for 90 days only.

除非另有說明，此報告結果僅對測試之樣品負責，同時此樣品僅保留90天。本報告未經本公司書面許可，不可部份複製。

This document is issued by the Company subject to its General Conditions of Service printed overleaf, available on request or accessible at www.sgs.com/terms_and_conditions.htm and, for electronic format documents, subject to Terms and Conditions for Electronic Documents at www.sgs.com/terms_e-document.htm. Attention is drawn to the limitation of liability, indemnification and jurisdiction issues defined therein. Any holder of this document is advised that information contained hereon reflects the Company's findings at the time of its intervention only and within the limits of Client's instructions, if any. The Company's sole responsibility is to its Client and this document does not exonerate parties to a transaction from exercising all their rights and obligations under the transaction documents. This document cannot be reproduced except in full, without prior written approval of the Company. Any unauthorized alteration, forgery or falsification of the content or appearance of this document is unlawful and offenders may be prosecuted to the fullest extent of the law.

SGS Taiwan Ltd.

No. 134, WuKungRoad, NewTaipeiIndustrialPark, WukuDistrict, NewTaipeiCity, Taiwan24803/新北市五股區新北產業園區五工路 134 號

台灣檢驗科技股份有限公司

t (886-2) 2299-3279

f (886-2) 2298-0488

www.tw.sgs.com

Member of SGS Group

BT4.0 mode
99% Band Width Test Data CH-Low

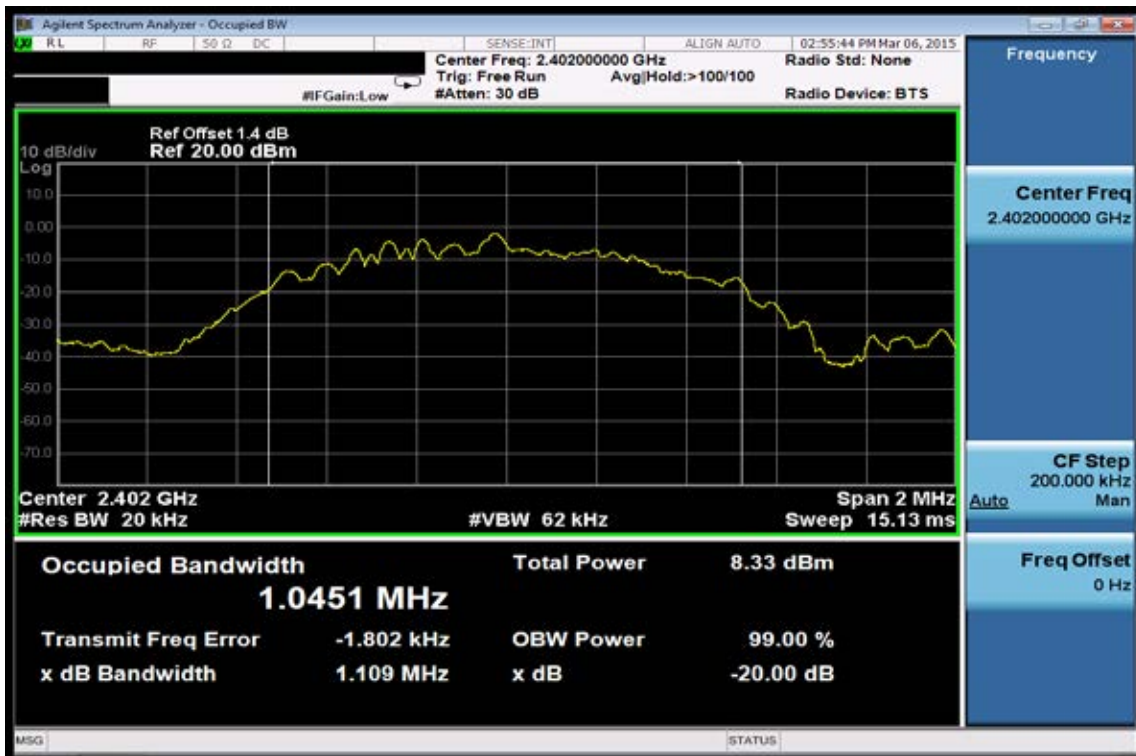

99% Band Width Test Data CH-Mid

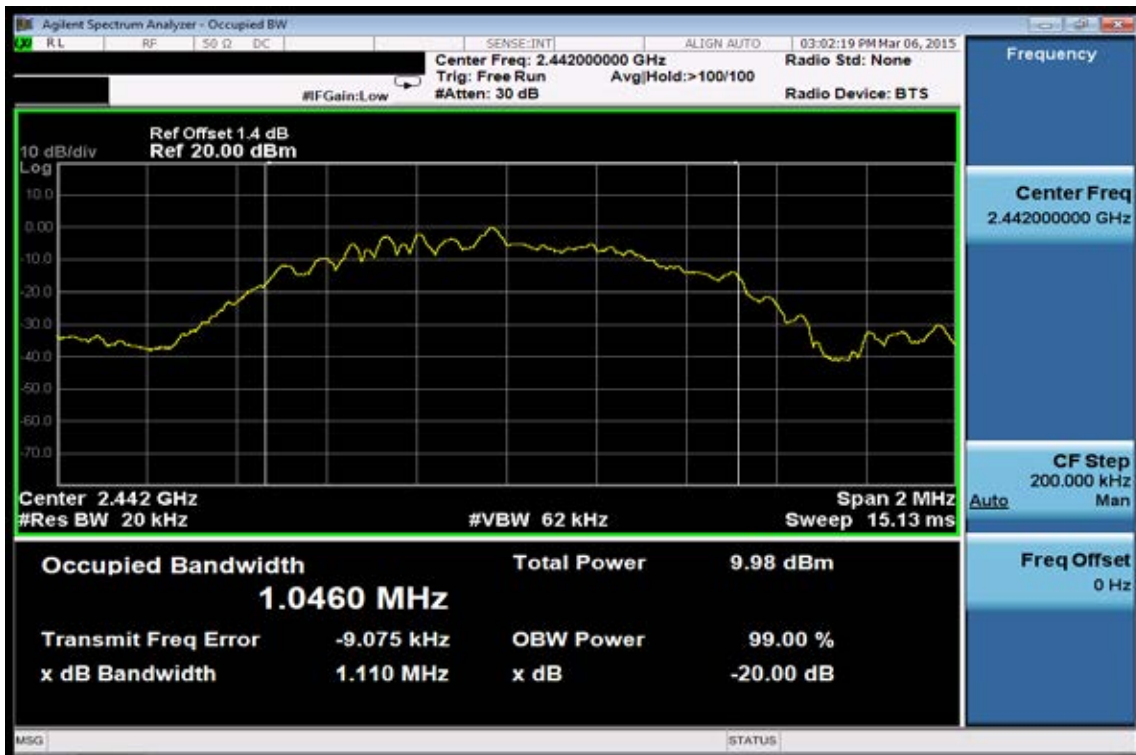

Unless otherwise stated the results shown in this test report refer only to the sample(s) tested and such sample(s) are retained for 90 days only.

除非另有說明，此報告結果僅對測試之樣品負責，同時此樣品僅保留90天。本報告未經本公司書面許可，不可部份複製。

This document is issued by the Company subject to its General Conditions of Service printed overleaf, available on request or accessible at www.sgs.com/terms_and_conditions.htm and, for electronic format documents, subject to Terms and Conditions for Electronic Documents at www.sgs.com/terms_e-document.htm. Attention is drawn to the limitation of liability, indemnification and jurisdiction issues defined therein. Any holder of this document is advised that information contained hereon reflects the Company's findings at the time of its intervention only and within the limits of Client's instructions, if any. The Company's sole responsibility is to its Client and this document does not exonerate parties to a transaction from exercising all their rights and obligations under the transaction documents. This document cannot be reproduced except in full, without prior written approval of the Company. Any unauthorized alteration, forgery or falsification of the content or appearance of this document is unlawful and offenders may be prosecuted to the fullest extent of the law.

SGS Taiwan Ltd.

No. 134, WuKungRoad, NewTaipeiIndustrialPark, WukuDistrict, NewTaipeiCity, Taiwan24803/新北市五股區新北產業園區五工路 134 號

台灣檢驗科技股份有限公司

t (886-2) 2299-3279

f (886-2) 2298-0488

www.tw.sgs.com

Member of SGS Group

99% Band Width Test Data CH-High

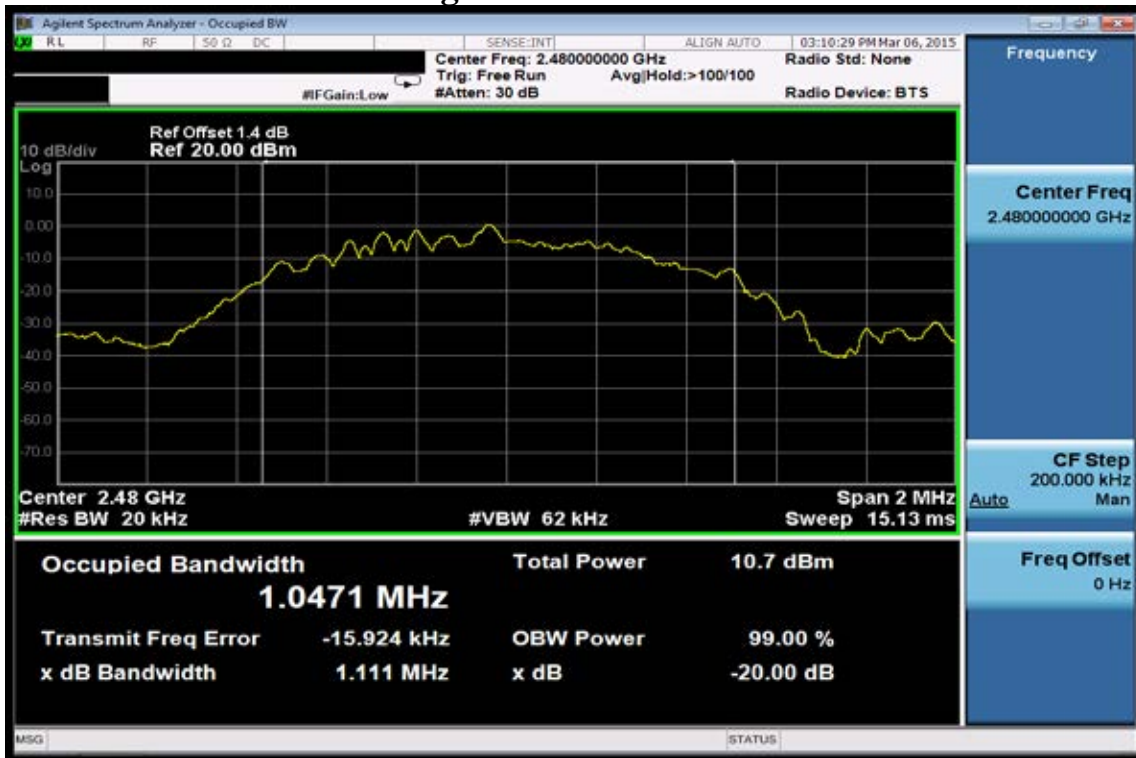

Unless otherwise stated the results shown in this test report refer only to the sample(s) tested and such sample(s) are retained for 90 days only.

除非另有說明，此報告結果僅對測試之樣品負責，同時此樣品僅保留90天。本報告未經本公司書面許可，不可部份複製。

This document is issued by the Company subject to its General Conditions of Service printed overleaf, available on request or accessible at www.sgs.com/terms_and_conditions.htm and, for electronic format documents, subject to Terms and Conditions for Electronic Documents at www.sgs.com/terms_e-document.htm. Attention is drawn to the limitation of liability, indemnification and jurisdiction issues defined therein. Any holder of this document is advised that information contained hereon reflects the Company's findings at the time of its intervention only and within the limits of Client's instructions, if any. The Company's sole responsibility is to its Client and this document does not exonerate parties to a transaction from exercising all their rights and obligations under the transaction documents. This document cannot be reproduced except in full, without prior written approval of the Company. Any unauthorized alteration, forgery or falsification of the content or appearance of this document is unlawful and offenders may be prosecuted to the fullest extent of the law.

SGS Taiwan Ltd.

No. 134, WuKungRoad, NewTaipeiIndustrialPark, WukuDistrict, NewTaipeiCity, Taiwan24803/新北市五股區新北產業園區五工路 134 號

台灣檢驗科技股份有限公司

t (886-2) 2299-3279

f (886-2) 2298-0488

www.tw.sgs.com

Member of SGS Group

9 CONDUCTED BAND EDGES AND SPURIOUS EMISSION MEASUREMENT

9.1 Standard Applicable

In any 100 kHz bandwidth outside the frequency band in which the spread spectrum or digitally modulated intentional radiator is operating, the radio frequency power that is produced by the intentional radiator shall be at least 20 dB below that in the 100 kHz bandwidth within the band that contains the highest level of the desired power, based on either an RF conducted or a radiated measurement, provided the transmitter demonstrates compliance with the peak conducted power limits. In addition, radiated emissions which fall in the restricted bands, as defined in §15.205(a), must also comply with the radiated emission limits specified in §15.209(a).

9.2 Measurement Equipment Used:

| Conducted Emission Test Site | | | | | |
|------------------------------|-----------|--------------|---------------|------------|------------|
| EQUIPMENT TYPE | MFR | MODEL NUMBER | SERIAL NUMBER | LAST CAL. | CAL DUE. |
| Spectrum Analyzer | Agilent | N9010A | MY53400256 | 10/15/2014 | 10/14/2015 |
| DC Block | PASTERNAK | PE8210 | RF29 | 12/19/2014 | 12/18/2015 |
| Attenuator | WOKEN | 218FS-10 | RF23 | 12/19/2014 | 12/18/2015 |

9.3 Test SET-UP:

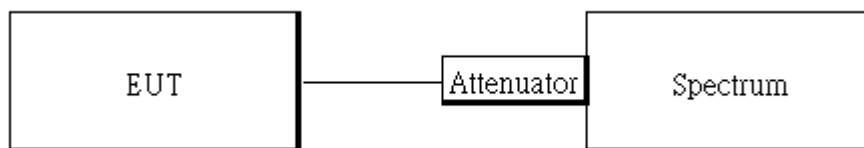

Unless otherwise stated the results shown in this test report refer only to the sample(s) tested and such sample(s) are retained for 90 days only.

除非另有說明，此報告結果僅對測試之樣品負責，同時此樣品僅保留90天。本報告未經本公司書面許可，不可部份複製。

This document is issued by the Company subject to its General Conditions of Service printed overleaf, available on request or accessible at www.sgs.com/terms_and_conditions.htm and, for electronic format documents, subject to Terms and Conditions for Electronic Documents at www.sgs.com/terms_e-document.htm. Attention is drawn to the limitation of liability, indemnification and jurisdiction issues defined therein. Any holder of this document is advised that information contained hereon reflects the Company's findings at the time of its intervention only and within the limits of Client's instructions, if any. The Company's sole responsibility is to its Client and this document does not exonerate parties to a transaction from exercising all their rights and obligations under the transaction documents. This document cannot be reproduced except in full, without prior written approval of the Company. Any unauthorized alteration, forgery or falsification of the content or appearance of this document is unlawful and offenders may be prosecuted to the fullest extent of the law.

9.3.1 Measurement Procedure

Conducted Band Edge:

1. To connect Antenna Port of EUT to Spectrum.
2. The testing follows the Measurement Procedure of FCC KDB 558074 D01 DTS Meas. Guidance V03r02.
3. Remove the antenna from the EUT and then connect a low loss RF cable from the antenna port to the spectrum analyzer.
4. Set start to edge frequency, and stop frequency of spectrum analyzer so as to encompass the spectrum to be examined.
5. Set the spectrum analyzer as RBW=100KHz, VBW=300KHz, Detector = Peak, Sweep = auto
6. Mark the highest reading of the emission as the reference level measurement.
7. Set DL as the limit = reading on marker 1 – 20dBm
8. Marker on frequency, 2.3999GHz and 2.4836GHz, and examine shall 100 KHz immediately outside the authorized (2400~2483.5) be attenuated by 20dB at least relative to the maximum emission of power.
9. Repeat above procedures until all default test channel (low, middle, and high) was complete.

Conducted Spurious Emission:

1. To connect Antenna Port of EUT to Spectrum.
2. The testing follows the Measurement Procedure of FCC KDB 558074 D01 DTS Meas. Guidance V03r02.
3. Set RBW = 100K & VBW \geq 300K, Detector =Peak, Sweep = Auto
4. Allow trace to fully stabilize.
5. Use the peak marker function to determine the maximum power level in any 100 kHz band segment within the fundamental EBW.
6. Repeat above procedures until all default test channel measured were complete.

9.3.2 Measurement Result

Note: Refer to next page spectrum analyzer data chart and tabular data sheets.

Unless otherwise stated the results shown in this test report refer only to the sample(s) tested and such sample(s) are retained for 90 days only.

除非另有說明，此報告結果僅對測試之樣品負責，同時此樣品僅保留90天。本報告未經本公司書面許可，不可部份複製。

This document is issued by the Company subject to its General Conditions of Service printed overleaf, available on request or accessible at www.sgs.com/terms_and_conditions.htm and, for electronic format documents, subject to Terms and Conditions for Electronic Documents at www.sgs.com/terms_e-document.htm. Attention is drawn to the limitation of liability, indemnification and jurisdiction issues defined therein. Any holder of this document is advised that information contained hereon reflects the Company's findings at the time of its intervention only and within the limits of Client's instructions, if any. The Company's sole responsibility is to its Client and this document does not exonerate parties to a transaction from exercising all their rights and obligations under the transaction documents. This document cannot be reproduced except in full, without prior written approval of the Company. Any unauthorized alteration, forgery or falsification of the content or appearance of this document is unlawful and offenders may be prosecuted to the fullest extent of the law.

SGS Taiwan Ltd.

台灣檢驗科技股份有限公司

No.134,WuKungRoad,NewTaipeiIndustrialPark,WukuDistrict,NewTaipeiCity,Taiwan24803/新北市五股區新北產業園區五工路 134 號

t (886-2) 2299-3279

f (886-2) 2298-0488

www.tw.sgs.com

Member of SGS Group

BT4.0 mode Band Edges Test Data CH-Low

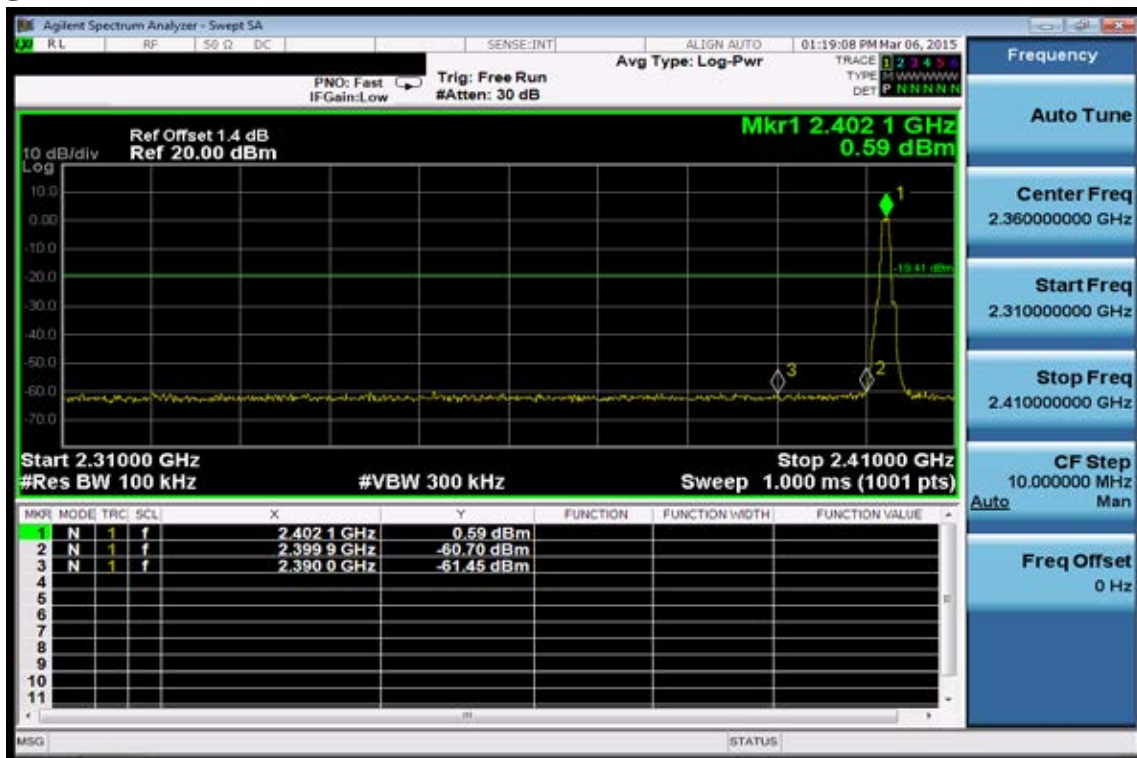

Band Edges Test Data CH-High



Unless otherwise stated the results shown in this test report refer only to the sample(s) tested and such sample(s) are retained for 90 days only.

除非另有說明，此報告結果僅對測試之樣品負責，同時此樣品僅保留90天。本報告未經本公司書面許可，不可部份複製。

This document is issued by the Company subject to its General Conditions of Service printed overleaf, available on request or accessible at www.sgs.com/terms_and_conditions.htm and, for electronic format documents, subject to Terms and Conditions for Electronic Documents at www.sgs.com/terms_e-document.htm. Attention is drawn to the limitation of liability, indemnification and jurisdiction issues defined therein. Any holder of this document is advised that information contained hereon reflects the Company's findings at the time of its intervention only and within the limits of Client's instructions, if any. The Company's sole responsibility is to its Client and this document does not exonerate parties to a transaction from exercising all their rights and obligations under the transaction documents. This document cannot be reproduced except in full, without prior written approval of the Company. Any unauthorized alteration, forgery or falsification of the content or appearance of this document is unlawful and offenders may be prosecuted to the fullest extent of the law.

Conducted Spurious Emission Measurement Result CH-Low 30MHz – 3GHz

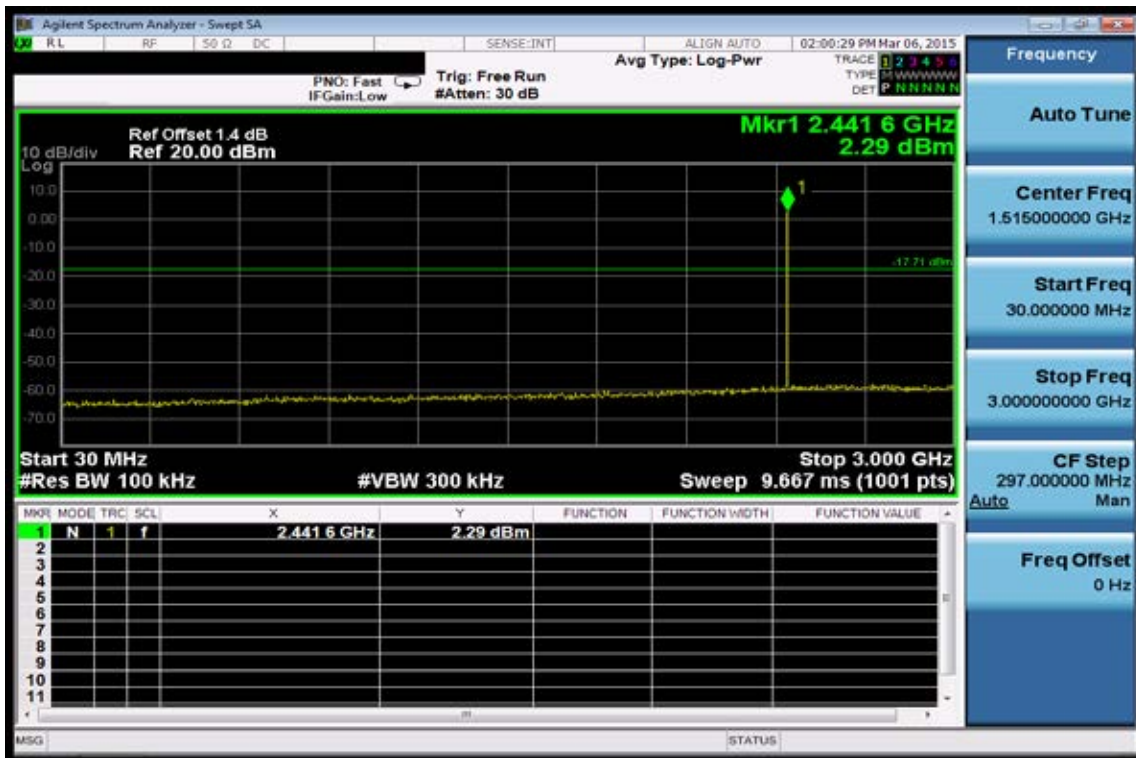

CH-Low 3GHz – 26.5GHz

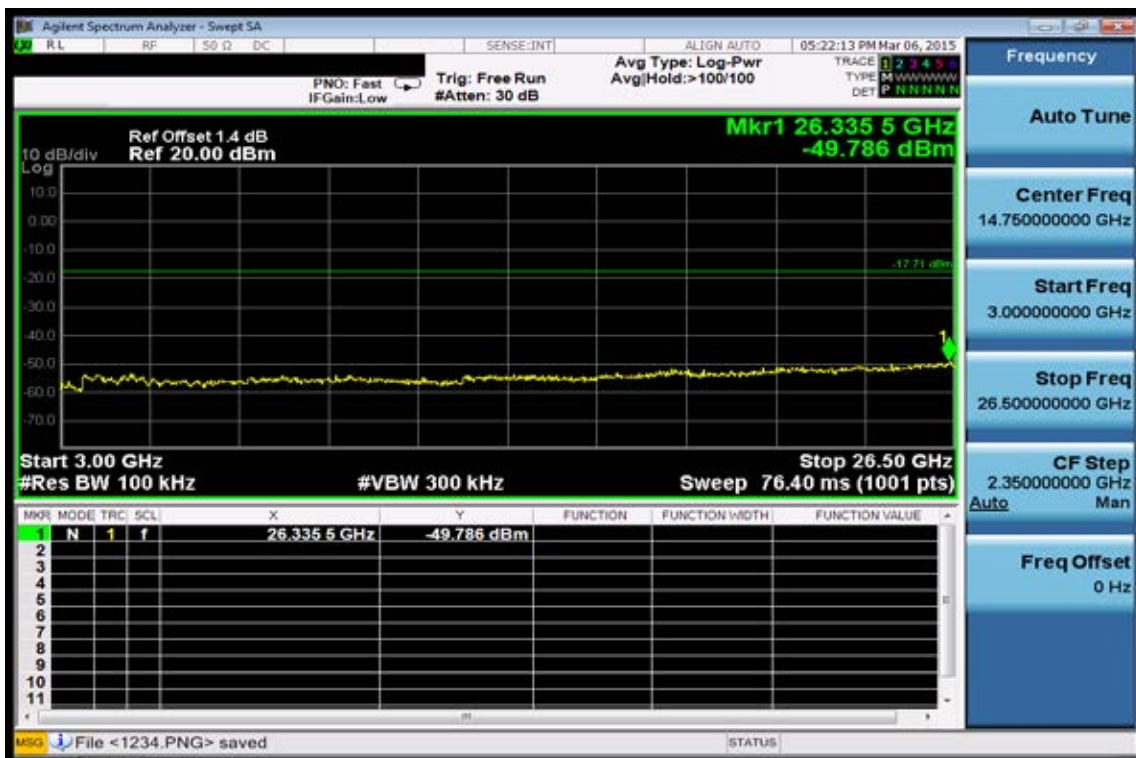

Unless otherwise stated the results shown in this test report refer only to the sample(s) tested and such sample(s) are retained for 90 days only.

除非另有說明，此報告結果僅對測試之樣品負責，同時此樣品僅保留90天。本報告未經本公司書面許可，不可部份複製。

This document is issued by the Company subject to its General Conditions of Service printed overleaf, available on request or accessible at www.sgs.com/terms_and_conditions.htm and, for electronic format documents, subject to Terms and Conditions for Electronic Documents at www.sgs.com/terms_e-document.htm. Attention is drawn to the limitation of liability, indemnification and jurisdiction issues defined therein. Any holder of this document is advised that information contained hereon reflects the Company's findings at the time of its intervention only and within the limits of Client's instructions, if any. The Company's sole responsibility is to its Client and this document does not exonerate parties to a transaction from exercising all their rights and obligations under the transaction documents. This document cannot be reproduced except in full, without prior written approval of the Company. Any unauthorized alteration, forgery or falsification of the content or appearance of this document is unlawful and offenders may be prosecuted to the fullest extent of the law.

CH-Mid 30MHz – 3GHz

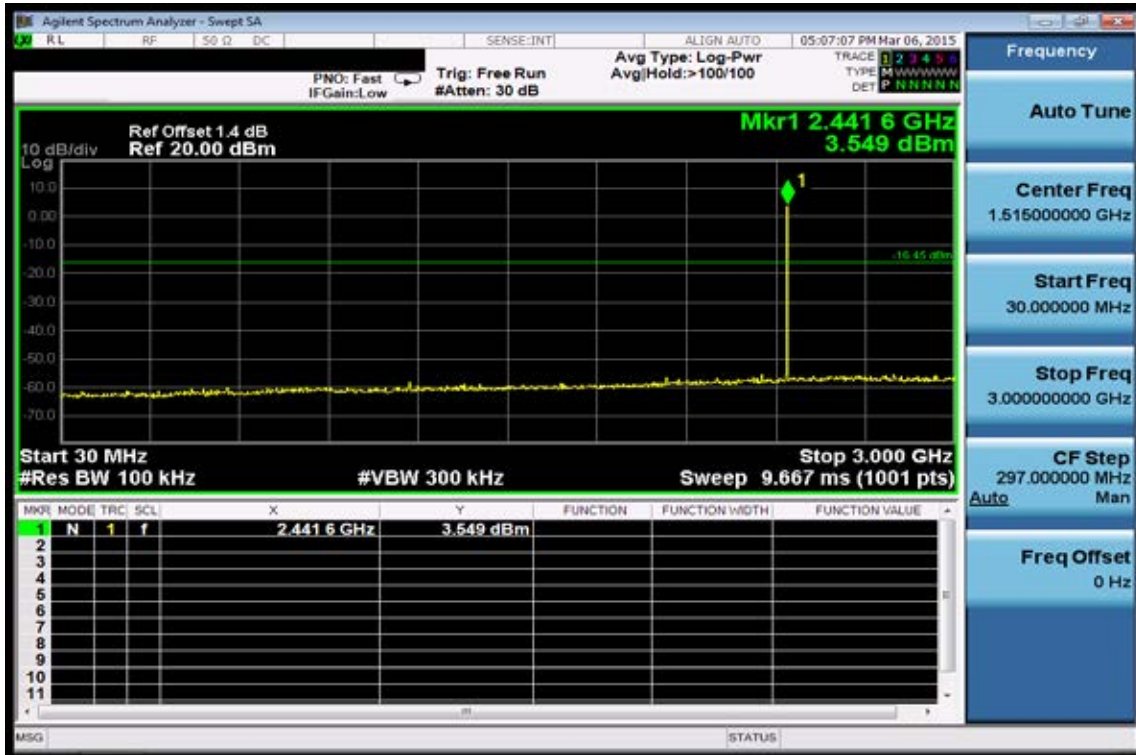

CH-Mid 3GHz – 26.5GHz

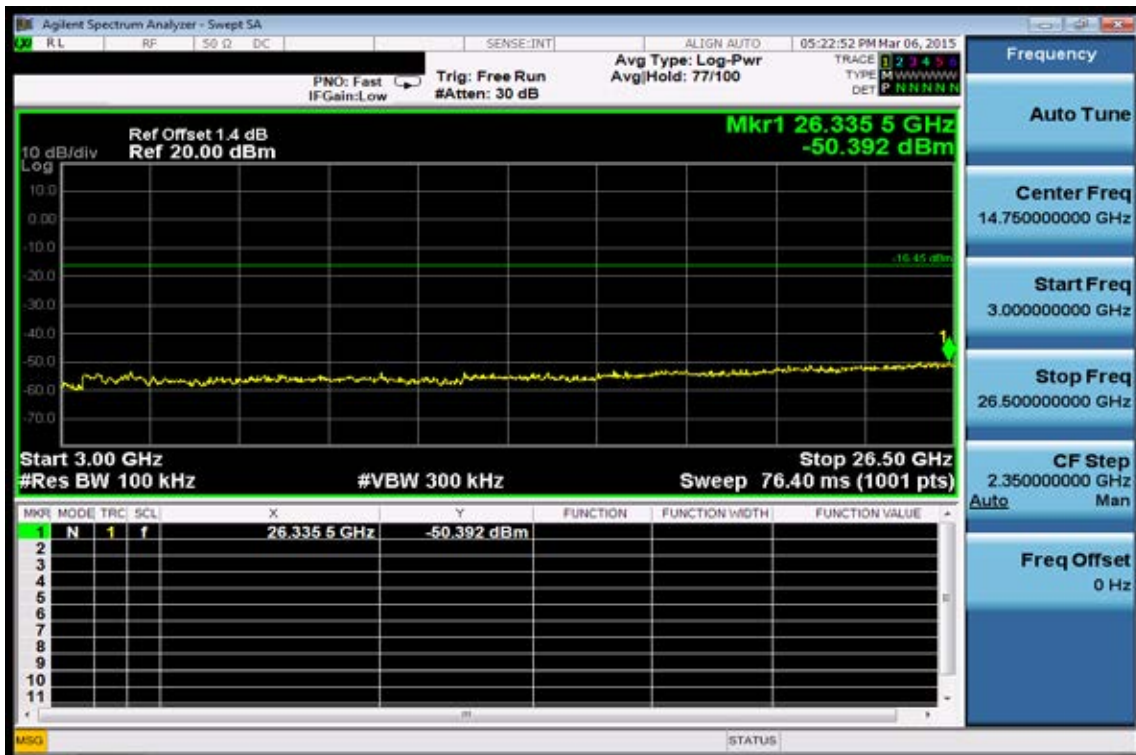

Unless otherwise stated the results shown in this test report refer only to the sample(s) tested and such sample(s) are retained for 90 days only.

除非另有說明，此報告結果僅對測試之樣品負責，同時此樣品僅保留90天。本報告未經本公司書面許可，不可部份複製。

This document is issued by the Company subject to its General Conditions of Service printed overleaf, available on request or accessible at www.sgs.com/terms_and_conditions.htm and, for electronic format documents, subject to Terms and Conditions for Electronic Documents at www.sgs.com/terms_e-document.htm. Attention is drawn to the limitation of liability, indemnification and jurisdiction issues defined therein. Any holder of this document is advised that information contained hereon reflects the Company's findings at the time of its intervention only and within the limits of Client's instructions, if any. The Company's sole responsibility is to its Client and this document does not exonerate parties to a transaction from exercising all their rights and obligations under the transaction documents. This document cannot be reproduced except in full, without prior written approval of the Company. Any unauthorized alteration, forgery or falsification of the content or appearance of this document is unlawful and offenders may be prosecuted to the fullest extent of the law.

SGS Taiwan Ltd.

No. 134, WuKungRoad, NewTaipeiIndustrialPark, WukuDistrict, NewTaipeiCity, Taiwan24803/新北市五股區新北產業園區五工路 134 號

台灣檢驗科技股份有限公司

t (886-2) 2299-3279

f (886-2) 2298-0488

www.tw.sgs.com

Member of SGS Group

CH-High 30MHz – 3GHz

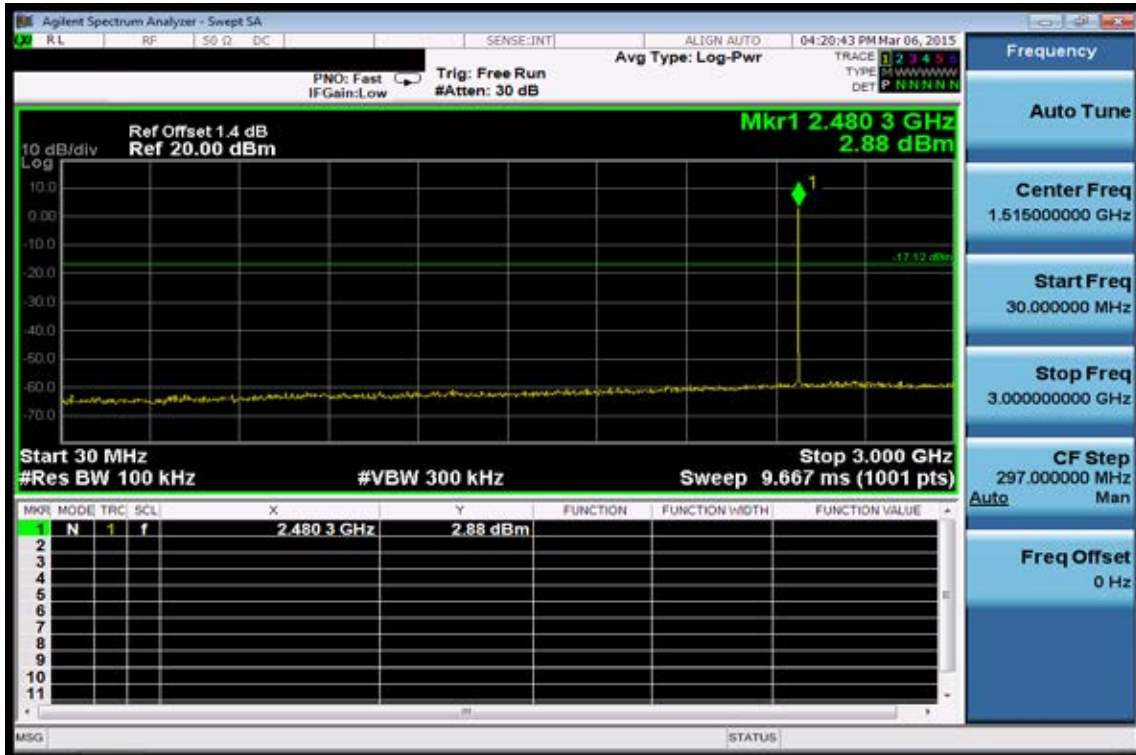

CH- High 3GHz – 26.5GHz

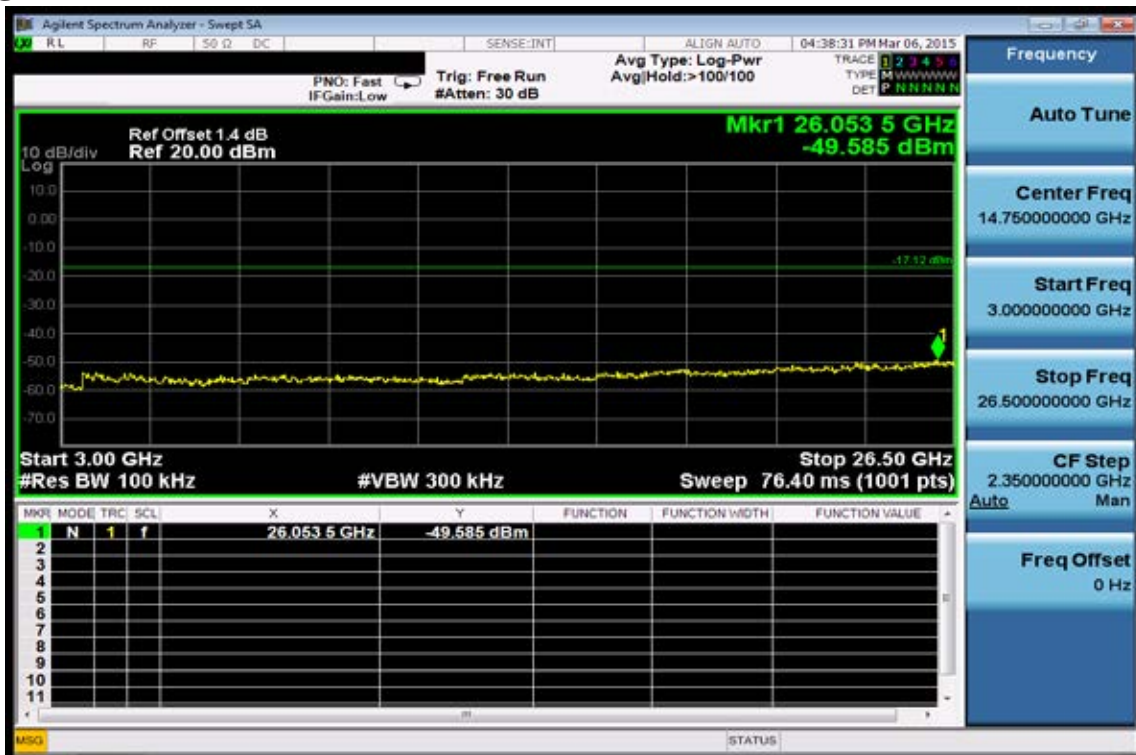

Unless otherwise stated the results shown in this test report refer only to the sample(s) tested and such sample(s) are retained for 90 days only.

除非另有說明，此報告結果僅對測試之樣品負責，同時此樣品僅保留90天。本報告未經本公司書面許可，不可部份複製。

This document is issued by the Company subject to its General Conditions of Service printed overleaf, available on request or accessible at www.sgs.com/terms_and_conditions.htm and, for electronic format documents, subject to Terms and Conditions for Electronic Documents at www.sgs.com/terms_e-document.htm. Attention is drawn to the limitation of liability, indemnification and jurisdiction issues defined therein. Any holder of this document is advised that information contained hereon reflects the Company's findings at the time of its intervention only and within the limits of Client's instructions, if any. The Company's sole responsibility is to its Client and this document does not exonerate parties to a transaction from exercising all their rights and obligations under the transaction documents. This document cannot be reproduced except in full, without prior written approval of the Company. Any unauthorized alteration, forgery or falsification of the content or appearance of this document is unlawful and offenders may be prosecuted to the fullest extent of the law.

SGS Taiwan Ltd.

No. 134, WuKungRoad, NewTaipeiIndustrialPark, WukuDistrict, NewTaipeiCity, Taiwan24803/新北市五股區新北產業園區五工路 134 號

台灣檢驗科技股份有限公司

t (886-2) 2299-3279

f (886-2) 2298-0488

www.tw.sgs.com

Member of SGS Group

10 RADIATED BANDEDGE AND SPURIOUS EMISSION MEASUREMENT

10.1 Standard Applicable

In any 100 kHz bandwidth outside the frequency band in which the spread spectrum or digitally modulated intentional radiator is operating, the radio frequency power that is produced by the intentional radiator shall be at least 20 dB below that in the 100 kHz bandwidth within the band that contains the highest level of the desired power, based on either an RF conducted or a radiated measurement, provided the transmitter demonstrates compliance with the peak conducted power limits. In addition, radiated emissions which fall in the restricted bands must also comply with the §15.209 limit as below.

And according to §15.33(a) (1), for an intentional radiator operates below 10GHz, the frequency range of measurements: to the tenth harmonic of the highest fundamental frequency or to 40GHz, whichever is lower.

| Frequency (MHz) | Field strength (microvolts/meter) | Distance (meters) |
|-----------------|-----------------------------------|-------------------|
| 0.009-0.490 | 2400/F(KHz) | 300 |
| 0.490-1.705 | 24000/F(KHz) | 30 |
| 1.705-30 | 30 | 30 |
| 30-88 | 100 | 3 |
| 88-216 | 150 | 3 |
| 216-960 | 200 | 3 |
| Above 960 | 500 | 3 |

Note:

1. The lower limit shall apply at the transition frequencies.
2. Emission level (dBμ V/m) = 20 log Emission level (dBμ V/m)

Unless otherwise stated the results shown in this test report refer only to the sample(s) tested and such sample(s) are retained for 90 days only.

除非另有說明，此報告結果僅對測試之樣品負責，同時此樣品僅保留90天。本報告未經本公司書面許可，不可部份複製。

This document is issued by the Company subject to its General Conditions of Service printed overleaf, available on request or accessible at www.sgs.com/terms_and_conditions.htm and, for electronic format documents, subject to Terms and Conditions for Electronic Documents at www.sgs.com/terms_e-document.htm. Attention is drawn to the limitation of liability, indemnification and jurisdiction issues defined therein. Any holder of this document is advised that information contained hereon reflects the Company's findings at the time of its intervention only and within the limits of Client's instructions, if any. The Company's sole responsibility is to its Client and this document does not exonerate parties to a transaction from exercising all their rights and obligations under the transaction documents. This document cannot be reproduced except in full, without prior written approval of the Company. Any unauthorized alteration, forgery or falsification of the content or appearance of this document is unlawful and offenders may be prosecuted to the fullest extent of the law.

SGS Taiwan Ltd.

No.134,WuKungRoad,NewTaipeiIndustrialPark,WukuDistrict,NewTaipeiCity,Taiwan24803/新北市五股區新北產業園區五工路 134 號

台灣檢驗科技股份有限公司

t (886-2) 2299-3279

f (886-2) 2298-0488

www.tw.sgs.com

Member of SGS Group

10.2 Measurement Equipment Used

| 966 Chamber | | | | | |
|------------------------|-----------------|-----------------------------|------------------|------------|------------|
| EQUIPMENT TYPE | MFR | MODEL NUMBER | SERIAL NUMBER | LAST CAL. | CAL DUE. |
| EMI Test Receiver | R&S | ESU 40 | 100363 | 04/12/2014 | 04/11/2015 |
| Spectrum Analyzer | Agilent | N9010A | MY53400256 | 10/15/2014 | 10/14/2015 |
| Loop Antenna | ETS-Lindgren | 6502 | 00143303 | 12/09/2014 | 12/08/2015 |
| Broadband Antenna | TESEQ | CBL 6112D | 35240 | 12/05/2014 | 12/04/2015 |
| Horn Antenna | ETS-Lindgren | 3117 | 00143272 | 12/08/2014 | 12/07/2015 |
| Horn Antenna | ETS-Lindgren | 3160-09 | 00117911 | 11/13/2014 | 11/12/2015 |
| Pre Amplifier | EMC Instruments | EMC330 | 980096 | 12/19/2014 | 12/18/2015 |
| Pre Amplifier | EMC Instruments | EMC0011830 | 980199 | 12/19/2014 | 12/18/2015 |
| Pre Amplifier | R&S | SCU-18 | 10204 | 12/19/2014 | 12/18/2015 |
| Pre Amplifier | R&S | SCU-26 | 100780 | 12/19/2014 | 12/18/2015 |
| Filter 2400-2483.5 MHz | EWT | EWT-14-0166 | M2 | 01/02/2015 | 01/01/2016 |
| Attenuator | WOKEN | 218FS-10 | RF27 | 12/19/2014 | 12/18/2015 |
| Turn Table | MF | N/A | N/A | N.C.R. | N.C.R. |
| Antenna Master | MF | N/A | N/A | N.C.R. | N.C.R. |
| Test Software | World-Pallas | Dr. E | V 3.0 Lite | N.C.R. | N.C.R. |
| Coaxial Cable | Huber+Suhner | RG 214/U | 966Rx 9K-30M | 12/19/2014 | 12/18/2015 |
| Coaxial Cable | Huber+Suhner | RG 214/U SUCOFLEX 104 | 966Rx 30M-3G | 12/19/2014 | 12/18/2015 |
| Coaxial Cable | Huber+Suhner | SUCOFLEX 104 | 966Rx 1G-18G | 12/19/2014 | 12/18/2015 |
| Coaxial Cable | Huber+Suhner | mini 141-12 SUCOFLEX 104 | 966Rx 18G-40G | 12/19/2014 | 12/18/2015 |
| Coaxial Cable | Huber+Suhner | SUCOFLEX 104 | 966Tx 30M-18G | 12/19/2014 | 12/18/2015 |
| Coaxial Cable | Huber+Suhner | SUCOFLEX 102 | 966Tx 18G-40G | 12/19/2014 | 12/18/2015 |

Unless otherwise stated the results shown in this test report refer only to the sample(s) tested and such sample(s) are retained for 90 days only.

除非另有說明，此報告結果僅對測試之樣品負責，同時此樣品僅保留90天。本報告未經本公司書面許可，不可部份複製。

This document is issued by the Company subject to its General Conditions of Service printed overleaf, available on request or accessible at www.sgs.com/terms_and_conditions.htm and, for electronic format documents, subject to Terms and Conditions for Electronic Documents at www.sgs.com/terms_e-document.htm. Attention is drawn to the limitation of liability, indemnification and jurisdiction issues defined therein. Any holder of this document is advised that information contained hereon reflects the Company's findings at the time of its intervention only and within the limits of Client's instructions, if any. The Company's sole responsibility is to its Client and this document does not exonerate parties to a transaction from exercising all their rights and obligations under the transaction documents. This document cannot be reproduced except in full, without prior written approval of the Company. Any unauthorized alteration, forgery or falsification of the content or appearance of this document is unlawful and offenders may be prosecuted to the fullest extent of the law.

SGS Taiwan Ltd.

No. 134, WuKungRoad, NewTaipeiIndustrialPark, WukuDistrict, NewTaipeiCity, Taiwan24803/新北市五股區新北產業園區五工路 134 號

台灣檢驗科技股份有限公司

t (886-2) 2299-3279

f (886-2) 2298-0488

www.tw.sgs.com

Member of SGS Group

10.3 Test SET-UP

(A) Radiated Emission Test Set-UP Frequency Below 30MHz.

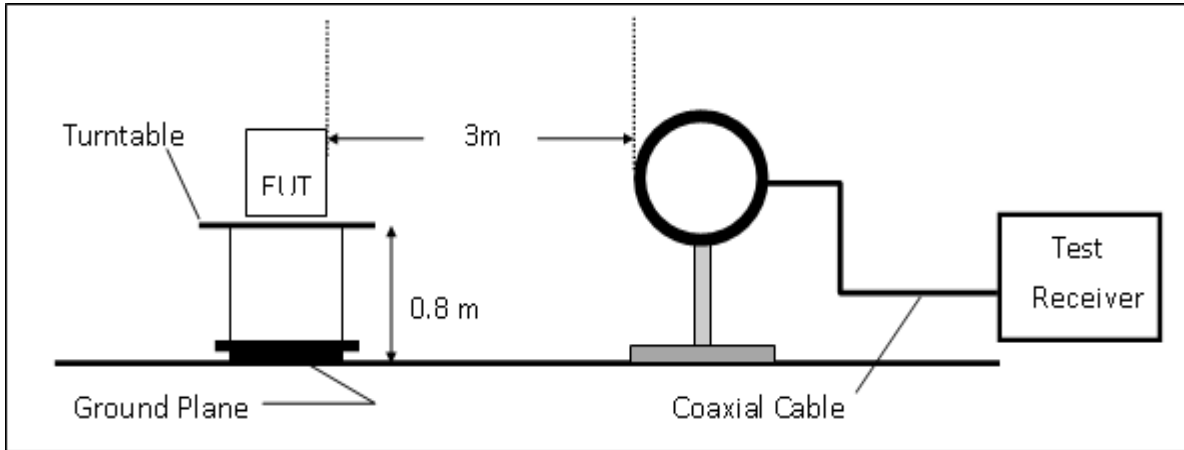

(B) Radiated Emission Test Set-UP, Frequency form 30MHz to 1000MHz

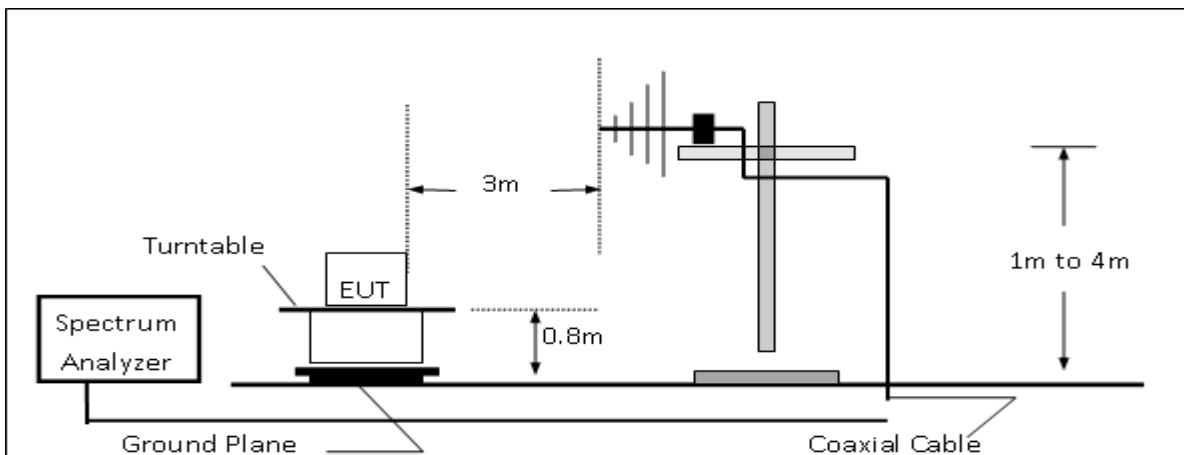

(C) Radiated Emission Test Set-UP Frequency Over 1 GHz

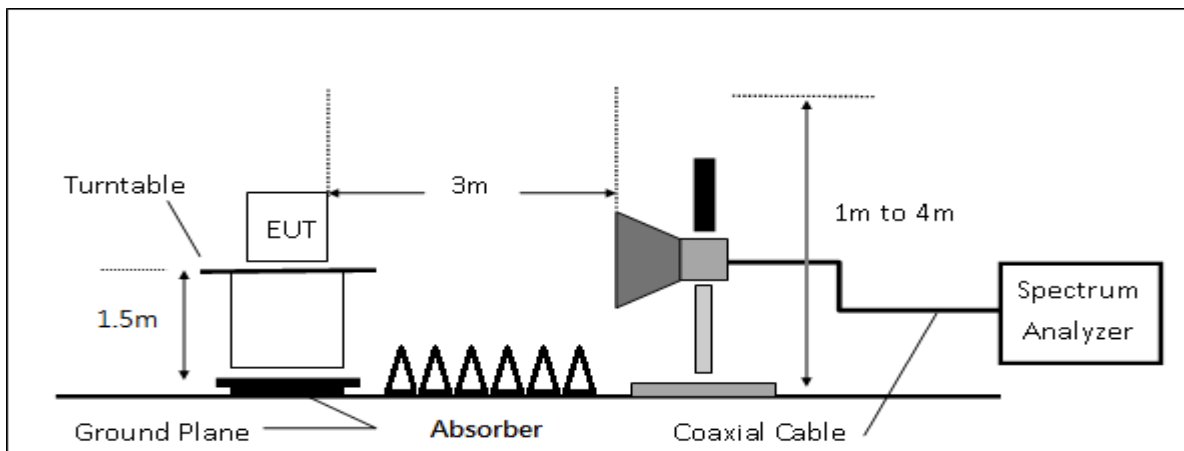

Unless otherwise stated the results shown in this test report refer only to the sample(s) tested and such sample(s) are retained for 90 days only.

除非另有說明，此報告結果僅對測試之樣品負責，同時此樣品僅保留90天。本報告未經本公司書面許可，不可部份複製。

This document is issued by the Company subject to its General Conditions of Service printed overleaf, available on request or accessible at www.sgs.com/terms_and_conditions.htm and, for electronic format documents, subject to Terms and Conditions for Electronic Documents at www.sgs.com/terms_e-document.htm. Attention is drawn to the limitation of liability, indemnification and jurisdiction issues defined therein. Any holder of this document is advised that information contained hereon reflects the Company's findings at the time of its intervention only and within the limits of Client's instructions, if any. The Company's sole responsibility is to its Client and this document does not exonerate parties to a transaction from exercising all their rights and obligations under the transaction documents. This document cannot be reproduced except in full, without prior written approval of the Company. Any unauthorized alteration, forgery or falsification of the content or appearance of this document is unlawful and offenders may be prosecuted to the fullest extent of the law.

10.4 Measurement Procedure

1. The testing follows the Measurement Procedure of FCC KDB 558074 D01 DTS Meas. Guidance V03r02.
2. The EUT was placed on a turn table with 0.8m for frequency < 1GHz and 1.5m for frequency > 1GHz above ground plane.
3. The turn table shall rotate 360 degrees to determine the position of maximum emission level.
4. EUT is set 3m away from the receiving antenna which varied from 1m to 4m to find out the highest emissions.
5. Set the spectrum analyzer as RBW=120 kHz and VBW=300 kHz for Peak Detector (PK) and Quasi-peak (QP) at frequency below 1 GHz.
6. Set the spectrum analyzer as RBW=1 MHz, VBW=3 MHz for Peak Detector at frequency above 1 GHz.
7. Set the spectrum analyzer as RBW=1 MHz, VBW=10 Hz (Duty cycle > 98%) or VBW $\geq 1/T$ (Duty cycle < 98%) for Average Detector at frequency above 1 GHz.
8. When measurement procedures for electric field radiated emissions above 1 GHz the EUT measurement is to be made “while keeping the antenna in the ‘cone of radiation’ from that area and pointed at the area both in azimuth and elevation, with polarization oriented for maximum response.” is still within the 3dB illumination BW of the measurement antenna.
9. Maximum procedure was performed on the six highest emissions to ensure EUT compliance.
10. And also, each emission was to be maximized by changing the polarization of receiving antenna both horizontal and vertical. On spectrum, change spectrum mode in linear display mode, and reduce VBW = 10Hz if average reading is measured.
11. Repeat above procedures until all default test channel measured were complete.

Unless otherwise stated the results shown in this test report refer only to the sample(s) tested and such sample(s) are retained for 90 days only.

除非另有說明，此報告結果僅對測試之樣品負責，同時此樣品僅保留90天。本報告未經本公司書面許可，不可部份複製。

This document is issued by the Company subject to its General Conditions of Service printed overleaf, available on request or accessible at www.sgs.com/terms_and_conditions.htm and, for electronic format documents, subject to Terms and Conditions for Electronic Documents at www.sgs.com/terms_e-document.htm. Attention is drawn to the limitation of liability, indemnification and jurisdiction issues defined therein. Any holder of this document is advised that information contained hereon reflects the Company's findings at the time of its intervention only and within the limits of Client's instructions, if any. The Company's sole responsibility is to its Client and this document does not exonerate parties to a transaction from exercising all their rights and obligations under the transaction documents. This document cannot be reproduced except in full, without prior written approval of the Company. Any unauthorized alteration, forgery or falsification of the content or appearance of this document is unlawful and offenders may be prosecuted to the fullest extent of the law.

SGS Taiwan Ltd.

台灣檢驗科技股份有限公司

No. 134, WuKungRoad, NewTaipeiIndustrialPark, WukuDistrict, NewTaipeiCity, Taiwan24803/新北市五股區新北產業園區五工路 134 號

t (886-2) 2299-3279

f (886-2) 2298-0488

www.tw.sgs.com

Member of SGS Group

10.5 Field Strength Calculation

The field strength is calculated by adding the Antenna Factor and Cable Factor and subtracting the Amplifier Gain and Duty Cycle Correction Factor (if any) from the measured reading. The basic equation with a sample calculation is as follows:

$$FS = RA + AF + CL - AG$$

| | | |
|-------|------------------------|--|
| Where | FS = Field Strength | CL = Cable Attenuation Factor (Cable Loss) |
| | RA = Reading Amplitude | AG = Amplifier Gain |
| | AF = Antenna Factor | |

Actual FS(dBμV/m) = SPA. Reading level(dBμV) + Factor(dB)

Factor(dB) = Antenna Factor(dBμV/m) + Cable Loss(dB) – Pre_Amplifier Gain(dB)

Note :

“F” : denotes Fundamental Frequency. ; “H” : denotes Harmonic Frequency.

“E” : denotes Band Edge Frequency. ; “S” : denotes Spurious Frequency.

10.6 Test Results of Radiated Spurious Emissions form 9 KHz to 30 MHz

The low frequency, which started from 9 kHz to 30MHz, was pre-scanned and the result which was 20dB lower than the limit per 15.31(o) was not reported.

10.7 Measurement Result:

Note: Refer to next page spectrum analyzer data chart and tabular data sheets.

Unless otherwise stated the results shown in this test report refer only to the sample(s) tested and such sample(s) are retained for 90 days only.

除非另有說明，此報告結果僅對測試之樣品負責，同時此樣品僅保留90天。本報告未經本公司書面許可，不可部份複製。

This document is issued by the Company subject to its General Conditions of Service printed overleaf, available on request or accessible at www.sgs.com/terms_and_conditions.htm and, for electronic format documents, subject to Terms and Conditions for Electronic Documents at www.sgs.com/terms_e-document.htm. Attention is drawn to the limitation of liability, indemnification and jurisdiction issues defined therein. Any holder of this document is advised that information contained hereon reflects the Company's findings at the time of its intervention only and within the limits of Client's instructions, if any. The Company's sole responsibility is to its Client and this document does not exonerate parties to a transaction from exercising all their rights and obligations under the transaction documents. This document cannot be reproduced except in full, without prior written approval of the Company. Any unauthorized alteration, forgery or falsification of the content or appearance of this document is unlawful and offenders may be prosecuted to the fullest extent of the law.

SGS Taiwan Ltd.

No.134,WuKungRoad,NewTaipeiIndustrialPark,WukuDistrict,NewTaipeiCity,Taiwan24803/新北市五股區新北產業園區五工路 134 號

台灣檢驗科技股份有限公司

t (886-2) 2299-3279

f (886-2) 2298-0488

www.tw.sgs.com

Member of SGS Group

Radiated Band Edge Measurement Result (BT4.0 mode)

| | | | |
|-----------------------|----------------|--------------------------|-----------------|
| Operation Band | :BT4.0 | Test Date | :2015-03-27 |
| Fundamental Frequency | :2402 MHz | Temp./Humi. | :17.5deg_C/72RH |
| Operation Mode | :Band Edge LOW | Engineer | :Vito |
| EUT Pol. | :E2 Plane | Measurement Antenna Pol. | :VERTICAL |

| Freq. | Detector Mode | Note | Spectrum Reading Level | Factor | Actual FS | Limit @3m | Margin |
|---------|---------------|---------|------------------------|--------|--------------|--------------|--------|
| MHz | PK/QP/AV | F/H/E/S | dB μ V | dB | dB μ V/m | dB μ V/m | dB |
| 2390.00 | Peak | E | 40.25 | 6.62 | 46.87 | 74.00 | -27.13 |
| 2390.00 | Average | E | 31.00 | 6.62 | 37.62 | 54.00 | -16.38 |

| | | | |
|-----------------------|----------------|--------------------------|-----------------|
| Operation Band | :BT4.0 | Test Date | :2015-03-27 |
| Fundamental Frequency | :2402 MHz | Temp./Humi. | :17.5deg_C/72RH |
| Operation Mode | :Band Edge LOW | Engineer | :Vito |
| EUT Pol. | :E2 Plane | Measurement Antenna Pol. | :HORIZONTAL |

| Freq. | Detector Mode | Note | Spectrum Reading Level | Factor | Actual FS | Limit @3m | Margin |
|---------|---------------|---------|------------------------|--------|--------------|--------------|--------|
| MHz | PK/QP/AV | F/H/E/S | dB μ V | dB | dB μ V/m | dB μ V/m | dB |
| 2390.00 | Peak | E | 39.60 | 6.62 | 46.22 | 74.00 | -27.78 |
| 2390.00 | Average | E | 30.98 | 6.62 | 37.60 | 54.00 | -16.40 |

Unless otherwise stated the results shown in this test report refer only to the sample(s) tested and such sample(s) are retained for 90 days only.

除非另有說明，此報告結果僅對測試之樣品負責，同時此樣品僅保留90天。本報告未經本公司書面許可，不可部份複製。

This document is issued by the Company subject to its General Conditions of Service printed overleaf, available on request or accessible at www.sgs.com/terms_and_conditions.htm and, for electronic format documents, subject to Terms and Conditions for Electronic Documents at www.sgs.com/terms_e-document.htm. Attention is drawn to the limitation of liability, indemnification and jurisdiction issues defined therein. Any holder of this document is advised that information contained hereon reflects the Company's findings at the time of its intervention only and within the limits of Client's instructions, if any. The Company's sole responsibility is to its Client and this document does not exonerate parties to a transaction from exercising all their rights and obligations under the transaction documents. This document cannot be reproduced except in full, without prior written approval of the Company. Any unauthorized alteration, forgery or falsification of the content or appearance of this document is unlawful and offenders may be prosecuted to the fullest extent of the law.

SGS Taiwan Ltd.

No.134,WuKungRoad,NewTaipeiIndustrialPark,WukuDistrict,NewTaipeiCity,Taiwan24803/新北市五股區新北產業園區五工路 134 號

台灣檢驗科技股份有限公司

t (886-2) 2299-3279

f (886-2) 2298-0488

www.tw.sgs.com

Member of SGS Group

| | | | |
|-----------------------|------------------|--------------------------|-----------------|
| Operation Band | :BT4.0 | Test Date | :2015-03-27 |
| Fundamental Frequency | :2480 MHz | Temp./Humi. | :17.5deg_C/72RH |
| Operation Mode | : Band Edge HIGH | Engineer | :Vito |
| EUT Pol. | :E2 Plane | Measurement Antenna Pol. | :VERTICAL |

| Freq. | Detector Mode | Note | Spectrum Reading Level | Factor | Actual FS | Limit @3m | Margin |
|---------|---------------|---------|------------------------|--------|--------------|--------------|--------|
| MHz | PK/QP/AV | F/H/E/S | dB μ V | dB | dB μ V/m | dB μ V/m | dB |
| 2483.50 | Peak | E | 47.89 | 6.96 | 54.86 | 74.00 | -19.14 |
| 2483.50 | Average | E | 37.96 | 6.96 | 44.92 | 54.00 | -9.08 |

| | | | |
|-----------------------|------------------|--------------------------|-----------------|
| Operation Band | :BT4.0 | Test Date | :2015-03-27 |
| Fundamental Frequency | :2480 MHz | Temp./Humi. | :17.5deg_C/72RH |
| Operation Mode | : Band Edge HIGH | Engineer | :Vito |
| EUT Pol. | :E2 Plane | Measurement Antenna Pol. | :HORIZONTAL |

| Freq. | Detector Mode | Note | Spectrum Reading Level | Factor | Actual FS | Limit @3m | Margin |
|---------|---------------|---------|------------------------|--------|--------------|--------------|--------|
| MHz | PK/QP/AV | F/H/E/S | dB μ V | dB | dB μ V/m | dB μ V/m | dB |
| 2483.50 | Peak | E | 52.77 | 6.96 | 59.73 | 74.00 | -14.27 |
| 2483.50 | Average | E | 41.30 | 6.96 | 48.26 | 54.00 | -5.74 |

Unless otherwise stated the results shown in this test report refer only to the sample(s) tested and such sample(s) are retained for 90 days only.

除非另有說明，此報告結果僅對測試之樣品負責，同時此樣品僅保留90天。本報告未經本公司書面許可，不可部份複製。

This document is issued by the Company subject to its General Conditions of Service printed overleaf, available on request or accessible at www.sgs.com/terms_and_conditions.htm and, for electronic format documents, subject to Terms and Conditions for Electronic Documents at www.sgs.com/terms_e-document.htm. Attention is drawn to the limitation of liability, indemnification and jurisdiction issues defined therein. Any holder of this document is advised that information contained hereon reflects the Company's findings at the time of its intervention only and within the limits of Client's instructions, if any. The Company's sole responsibility is to its Client and this document does not exonerate parties to a transaction from exercising all their rights and obligations under the transaction documents. This document cannot be reproduced except in full, without prior written approval of the Company. Any unauthorized alteration, forgery or falsification of the content or appearance of this document is unlawful and offenders may be prosecuted to the fullest extent of the law.

SGS Taiwan Ltd.

No.134,WuKungRoad,NewTaipeiIndustrialPark,WukuDistrict,NewTaipeiCity,Taiwan24803/新北市五股區新北產業園區五工路 134 號

台灣檢驗科技股份有限公司

t (886-2) 2299-3279

f (886-2) 2298-0488

www.tw.sgs.com

Member of SGS Group

**Radiated Spurious Emission Measurement Result (BT4.0 mode)
For Frequency from 30MHz to 1000MHz**

| | | | |
|-----------------------|-----------|--------------------------|-----------------|
| Operation Band | :BT4.0 | Test Date | :2015-03-27 |
| Fundamental Frequency | :2402 MHz | Temp./Humi. | :17.5deg_C/72RH |
| Operation Mode | :TX LOW | Engineer | :Vito |
| EUT Pol. | :E2 Plane | Measurement Antenna Pol. | :VERTICAL |

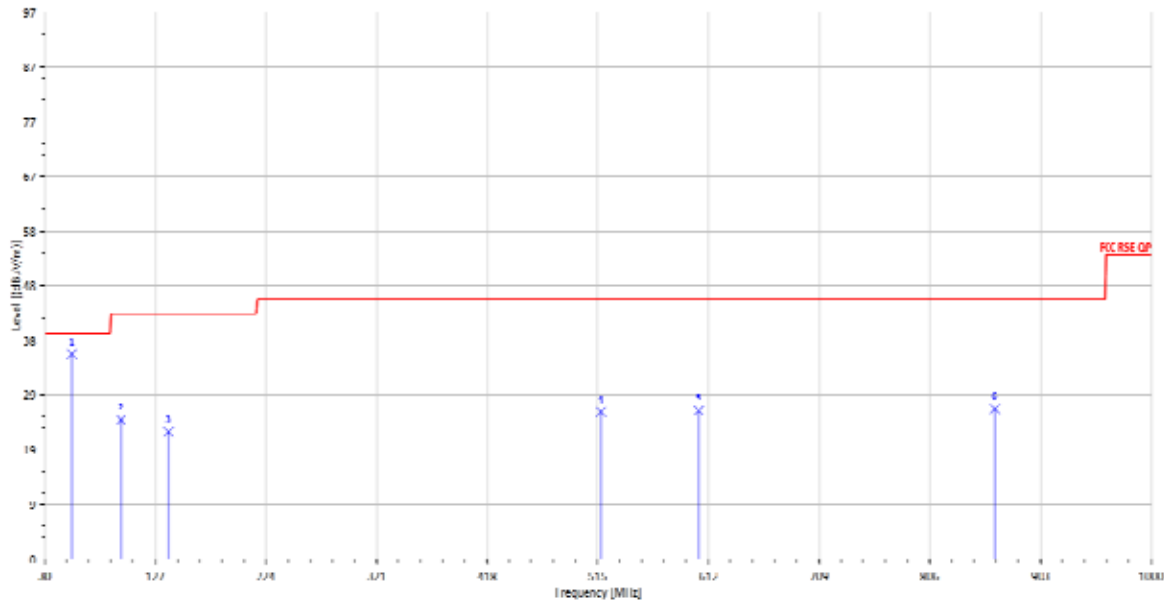

| Freq. MHz | Detector Mode | Note | Spectrum Reading Level dBμV | Factor dB | Actual FS dBμV/m | Limit @3m dBμV/m | Margin dB |
|--------------|------------------|------|-----------------------------------|--------------|------------------------|------------------------|--------------|
| 54.25 | Peak | S | 63.12 | -26.79 | 36.32 | 40.00 | -3.68 |
| 96.93 | Peak | S | 49.02 | -24.36 | 24.66 | 43.50 | -18.84 |
| 138.64 | Peak | S | 44.12 | -21.60 | 22.51 | 43.50 | -20.99 |
| 517.91 | Peak | S | 39.69 | -13.60 | 26.09 | 46.00 | -19.91 |
| 603.27 | Peak | S | 38.95 | -12.65 | 26.30 | 46.00 | -19.70 |
| 863.23 | Peak | S | 35.13 | -8.53 | 26.61 | 46.00 | -19.39 |

Unless otherwise stated the results shown in this test report refer only to the sample(s) tested and such sample(s) are retained for 90 days only.

除非另有說明，此報告結果僅對測試之樣品負責，同時此樣品僅保留90天。本報告未經本公司書面許可，不可部份複製。

This document is issued by the Company subject to its General Conditions of Service printed overleaf, available on request or accessible at www.sgs.com/terms_and_conditions.htm and, for electronic format documents, subject to Terms and Conditions for Electronic Documents at www.sgs.com/terms_e-document.htm. Attention is drawn to the limitation of liability, indemnification and jurisdiction issues defined therein. Any holder of this document is advised that information contained hereon reflects the Company's findings at the time of its intervention only and within the limits of Client's instructions, if any. The Company's sole responsibility is to its Client and this document does not exonerate parties to a transaction from exercising all their rights and obligations under the transaction documents. This document cannot be reproduced except in full, without prior written approval of the Company. Any unauthorized alteration, forgery or falsification of the content or appearance of this document is unlawful and offenders may be prosecuted to the fullest extent of the law.

SGS Taiwan Ltd.

No. 134, WuKungRoad, NewTaipeiIndustrialPark, WukuDistrict, NewTaipeiCity, Taiwan24803/新北市五股區新北產業園區五工路 134 號

台灣檢驗科技股份有限公司

t (886-2) 2299-3279

f (886-2) 2298-0488

www.tw.sgs.com

Member of SGS Group

| | | | |
|-----------------------|-----------|--------------------------|-----------------|
| Operation Band | :BT4.0 | Test Date | :2015-03-27 |
| Fundamental Frequency | :2402 MHz | Temp./Humi. | :17.5deg_C/72RH |
| Operation Mode | :TX LOW | Engineer | :Vito |
| EUT Pol. | :E2 Plane | Measurement Antenna Pol. | :HORIZONTAL |

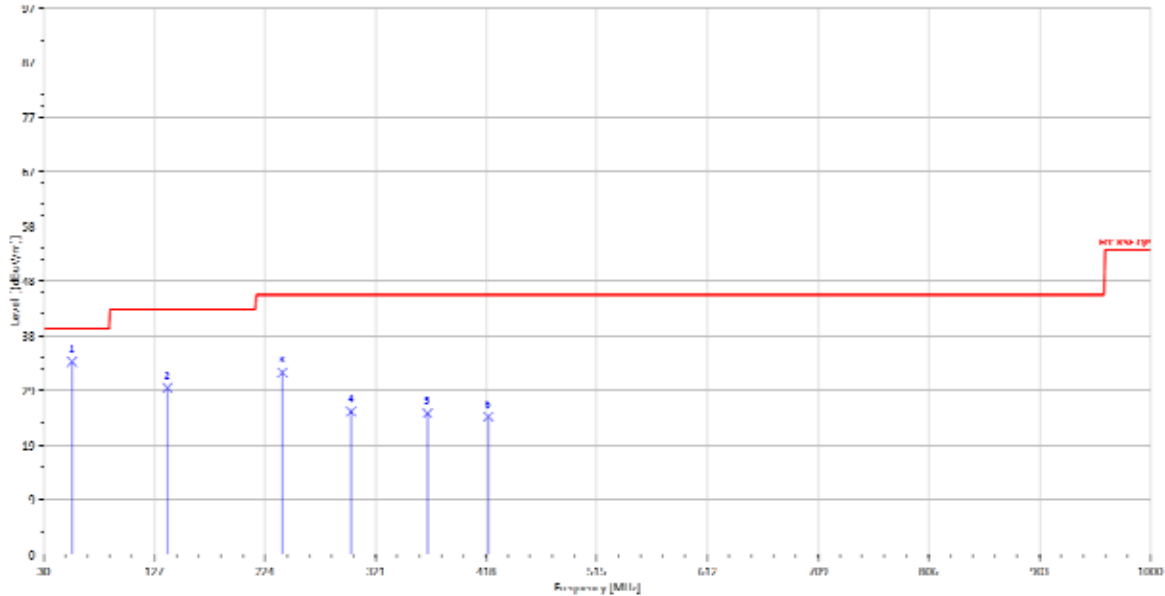

| Freq. MHz | Detector Mode PK/QP/AV | Note F/H/E/S | Spectrum Reading Level dBμV | Factor dB | Actual FS dBμV/m | Limit @3m dBμV/m | Margin dB |
|--------------|------------------------------|-----------------|-----------------------------------|--------------|------------------------|------------------------|--------------|
| 55.22 | Peak | S | 61.21 | -27.06 | 34.15 | 40.00 | -5.85 |
| 138.64 | Peak | S | 51.11 | -21.60 | 29.51 | 43.50 | -13.99 |
| 239.52 | Peak | S | 53.41 | -21.14 | 32.27 | 46.00 | -13.73 |
| 299.66 | Peak | S | 44.58 | -19.28 | 25.30 | 46.00 | -20.70 |
| 366.59 | Peak | S | 41.87 | -16.91 | 24.97 | 46.00 | -21.03 |
| 419.94 | Peak | S | 39.78 | -15.40 | 24.38 | 46.00 | -21.62 |

Unless otherwise stated the results shown in this test report refer only to the sample(s) tested and such sample(s) are retained for 90 days only.

除非另有說明，此報告結果僅對測試之樣品負責，同時此樣品僅保留90天。本報告未經本公司書面許可，不可部份複製。

This document is issued by the Company subject to its General Conditions of Service printed overleaf, available on request or accessible at www.sgs.com/terms_and_conditions.htm and, for electronic format documents, subject to Terms and Conditions for Electronic Documents at www.sgs.com/terms_e-document.htm. Attention is drawn to the limitation of liability, indemnification and jurisdiction issues defined therein. Any holder of this document is advised that information contained hereon reflects the Company's findings at the time of its intervention only and within the limits of Client's instructions, if any. The Company's sole responsibility is to its Client and this document does not exonerate parties to a transaction from exercising all their rights and obligations under the transaction documents. This document cannot be reproduced except in full, without prior written approval of the Company. Any unauthorized alteration, forgery or falsification of the content or appearance of this document is unlawful and offenders may be prosecuted to the fullest extent of the law.

| | | | |
|-----------------------|-----------|--------------------------|-----------------|
| Operation Band | :BT4.0 | Test Date | :2015-03-27 |
| Fundamental Frequency | :2442 MHz | Temp./Humi. | :17.5deg_C/72RH |
| Operation Mode | :TX MID | Engineer | :Vito |
| EUT Pol. | :E2 Plane | Measurement Antenna Pol. | :VERTICAL |

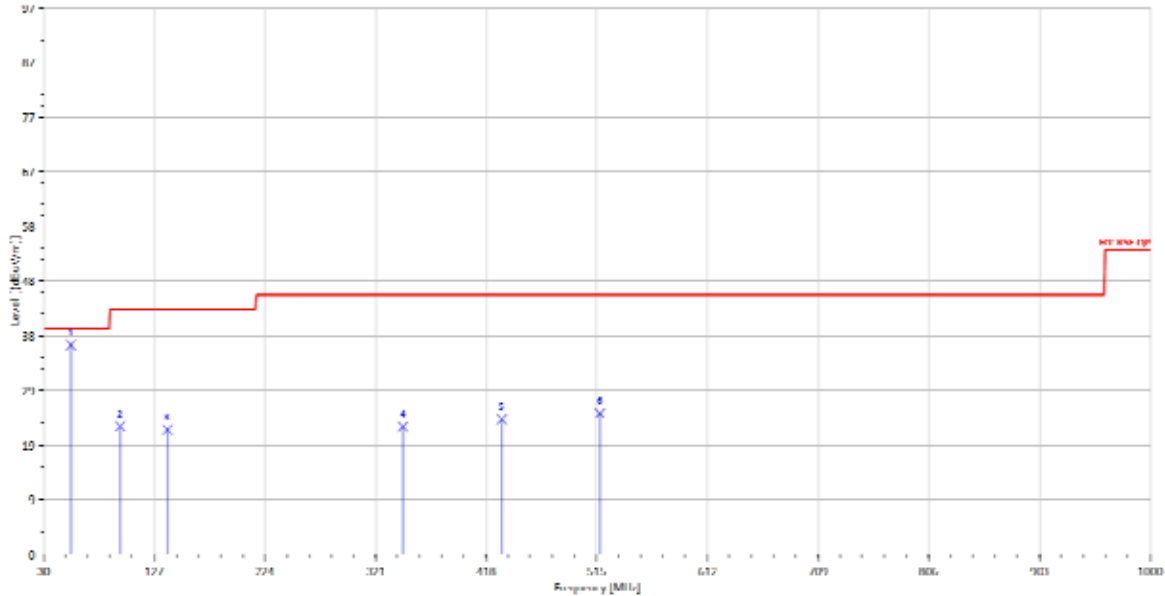

| Freq. MHz | Detector Mode | Note F/H/E/S | Spectrum Reading Level dBμV | Factor dB | Actual FS dBμV/m | Limit @3m dBμV/m | Margin dB |
|--------------|------------------|-----------------|-----------------------------------|--------------|------------------------|------------------------|--------------|
| 54.25 | Peak | S | 63.90 | -26.79 | 37.11 | 40.00 | -2.89 |
| 96.93 | Peak | S | 47.07 | -24.36 | 22.71 | 43.50 | -20.79 |
| 138.64 | Peak | S | 43.72 | -21.60 | 22.12 | 43.50 | -21.38 |
| 345.25 | Peak | S | 40.19 | -17.54 | 22.65 | 46.00 | -23.35 |
| 431.58 | Peak | S | 39.27 | -15.34 | 23.93 | 46.00 | -22.07 |
| 517.91 | Peak | S | 38.56 | -13.60 | 24.95 | 46.00 | -21.05 |

Unless otherwise stated the results shown in this test report refer only to the sample(s) tested and such sample(s) are retained for 90 days only.

除非另有說明，此報告結果僅對測試之樣品負責，同時此樣品僅保留90天。本報告未經本公司書面許可，不可部份複製。

This document is issued by the Company subject to its General Conditions of Service printed overleaf, available on request or accessible at www.sgs.com/terms_and_conditions.htm and, for electronic format documents, subject to Terms and Conditions for Electronic Documents at www.sgs.com/terms_e-document.htm. Attention is drawn to the limitation of liability, indemnification and jurisdiction issues defined therein. Any holder of this document is advised that information contained hereon reflects the Company's findings at the time of its intervention only and within the limits of Client's instructions, if any. The Company's sole responsibility is to its Client and this document does not exonerate parties to a transaction from exercising all their rights and obligations under the transaction documents. This document cannot be reproduced except in full, without prior written approval of the Company. Any unauthorized alteration, forgery or falsification of the content or appearance of this document is unlawful and offenders may be prosecuted to the fullest extent of the law.

| | | | |
|-----------------------|-----------|--------------------------|-----------------|
| Operation Band | :BT4.0 | Test Date | :2015-03-27 |
| Fundamental Frequency | :2442 MHz | Temp./Humi. | :17.5deg_C/72RH |
| Operation Mode | :TX MID | Engineer | :Vito |
| EUT Pol. | :E2 Plane | Measurement Antenna Pol. | :HORIZONTAL |

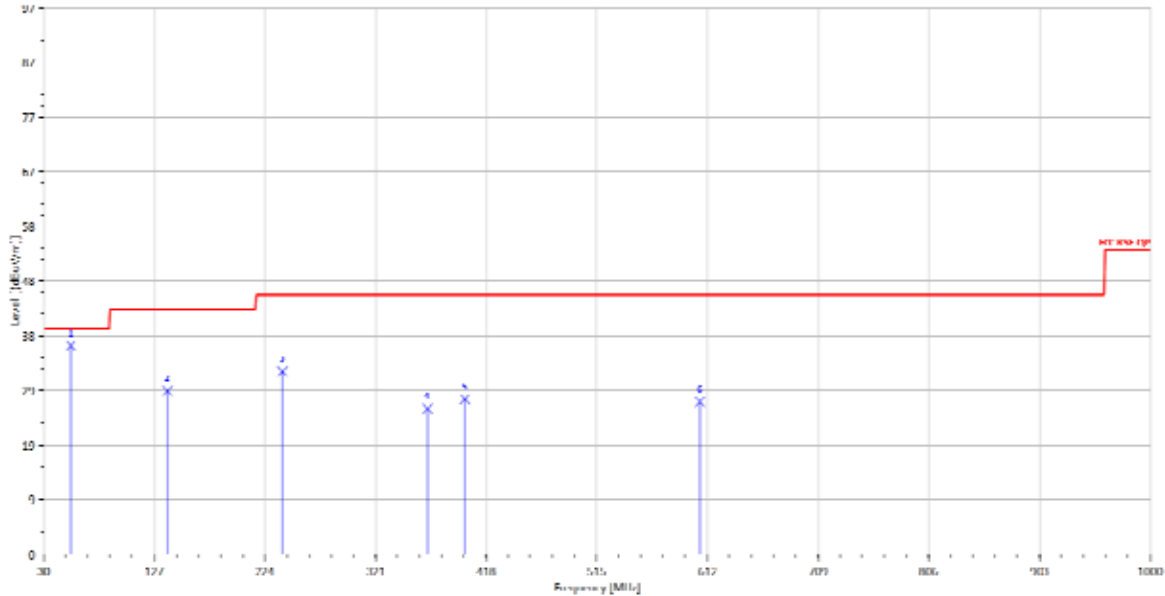

| Freq. MHz | Detector Mode | Note | Spectrum Reading Level dBμV | Factor dB | Actual FS dBμV/m | Limit @3m dBμV/m | Margin dB |
|--------------|------------------|------|-----------------------------------|--------------|------------------------|------------------------|--------------|
| 54.25 | Peak | S | 63.80 | -26.79 | 37.00 | 40.00 | -3.00 |
| 138.64 | Peak | S | 50.59 | -21.60 | 28.98 | 43.50 | -14.52 |
| 239.52 | Peak | S | 53.57 | -21.14 | 32.42 | 46.00 | -13.58 |
| 366.59 | Peak | S | 42.75 | -16.91 | 25.85 | 46.00 | -20.15 |
| 399.57 | Peak | S | 43.39 | -15.88 | 27.51 | 46.00 | -18.49 |
| 605.21 | Peak | S | 39.70 | -12.64 | 27.06 | 46.00 | -18.94 |

Unless otherwise stated the results shown in this test report refer only to the sample(s) tested and such sample(s) are retained for 90 days only.

除非另有說明，此報告結果僅對測試之樣品負責，同時此樣品僅保留90天。本報告未經本公司書面許可，不可部份複製。

This document is issued by the Company subject to its General Conditions of Service printed overleaf, available on request or accessible at www.sgs.com/terms_and_conditions.htm and, for electronic format documents, subject to Terms and Conditions for Electronic Documents at www.sgs.com/terms_e-document.htm. Attention is drawn to the limitation of liability, indemnification and jurisdiction issues defined therein. Any holder of this document is advised that information contained hereon reflects the Company's findings at the time of its intervention only and within the limits of Client's instructions, if any. The Company's sole responsibility is to its Client and this document does not exonerate parties to a transaction from exercising all their rights and obligations under the transaction documents. This document cannot be reproduced except in full, without prior written approval of the Company. Any unauthorized alteration, forgery or falsification of the content or appearance of this document is unlawful and offenders may be prosecuted to the fullest extent of the law.

| | | | |
|-----------------------|-----------|--------------------------|-----------------|
| Operation Band | :BT4.0 | Test Date | :2015-03-27 |
| Fundamental Frequency | :2480 MHz | Temp./Humi. | :17.5deg_C/72RH |
| Operation Mode | :TX HIGH | Engineer | :Vito |
| EUT Pol. | :E2 Plane | Measurement Antenna Pol. | :VERTICAL |

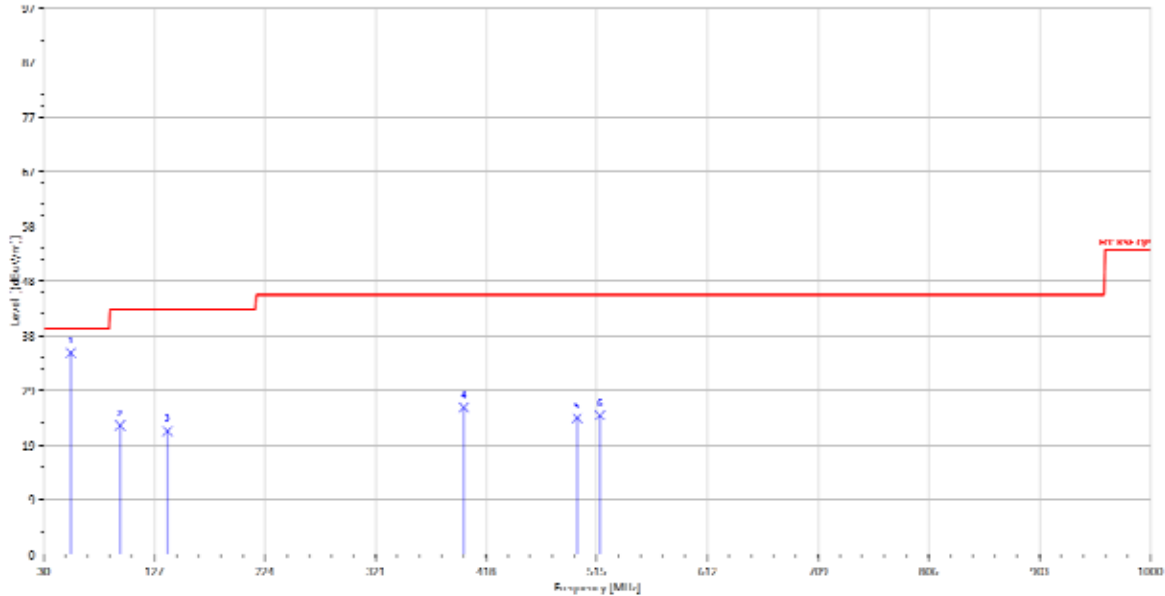

| Freq. MHz | Detector Mode | Note F/H/E/S | Spectrum Reading Level dBμV | Factor dB | Actual FS dBμV/m | Limit @3m dBμV/m | Margin dB |
|--------------|------------------|-----------------|-----------------------------------|--------------|------------------------|------------------------|--------------|
| 54.25 | Peak | S | 62.54 | -26.79 | 35.75 | 40.00 | -4.25 |
| 96.93 | Peak | S | 47.21 | -24.36 | 22.85 | 43.50 | -20.65 |
| 138.64 | Peak | S | 43.45 | -21.60 | 21.85 | 43.50 | -21.65 |
| 398.60 | Peak | S | 41.99 | -15.93 | 26.06 | 46.00 | -19.94 |
| 497.54 | Peak | S | 38.38 | -14.23 | 24.15 | 46.00 | -21.85 |
| 517.91 | Peak | S | 38.22 | -13.60 | 24.62 | 46.00 | -21.38 |

Unless otherwise stated the results shown in this test report refer only to the sample(s) tested and such sample(s) are retained for 90 days only.

除非另有說明，此報告結果僅對測試之樣品負責，同時此樣品僅保留90天。本報告未經本公司書面許可，不可部份複製。

This document is issued by the Company subject to its General Conditions of Service printed overleaf, available on request or accessible at www.sgs.com/terms_and_conditions.htm and, for electronic format documents, subject to Terms and Conditions for Electronic Documents at www.sgs.com/terms_e-document.htm. Attention is drawn to the limitation of liability, indemnification and jurisdiction issues defined therein. Any holder of this document is advised that information contained hereon reflects the Company's findings at the time of its intervention only and within the limits of Client's instructions, if any. The Company's sole responsibility is to its Client and this document does not exonerate parties to a transaction from exercising all their rights and obligations under the transaction documents. This document cannot be reproduced except in full, without prior written approval of the Company. Any unauthorized alteration, forgery or falsification of the content or appearance of this document is unlawful and offenders may be prosecuted to the fullest extent of the law.

| | | | |
|-----------------------|-----------|--------------------------|-----------------|
| Operation Band | :BT4.0 | Test Date | :2015-03-27 |
| Fundamental Frequency | :2480 MHz | Temp./Humi. | :17.5deg_C/72RH |
| Operation Mode | :TX HIGH | Engineer | :Vito |
| EUT Pol. | :E2 Plane | Measurement Antenna Pol. | :HORIZONTAL |

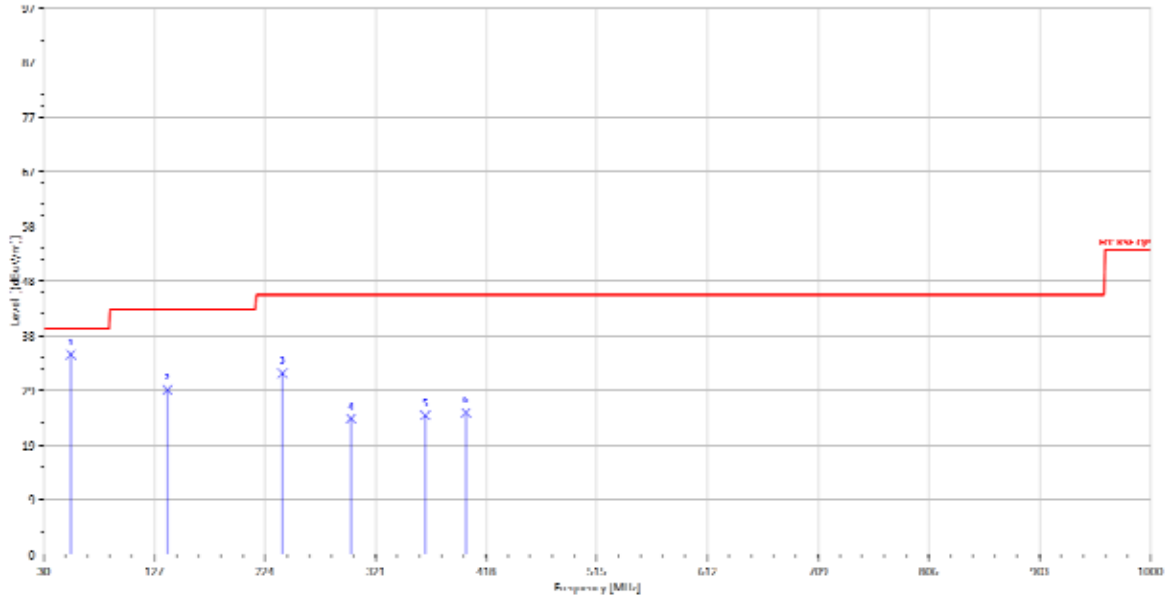

| Freq. MHz | Detector Mode | Note | Spectrum Reading Level dBμV | Factor dB | Actual FS dBμV/m | Limit @3m dBμV/m | Margin dB |
|--------------|------------------|------|-----------------------------------|--------------|------------------------|------------------------|--------------|
| 54.25 | Peak | S | 62.24 | -26.79 | 35.45 | 40.00 | -4.55 |
| 138.64 | Peak | S | 50.79 | -21.60 | 29.19 | 43.50 | -14.31 |
| 239.52 | Peak | S | 53.25 | -21.14 | 32.11 | 46.00 | -13.89 |
| 299.66 | Peak | S | 43.34 | -19.28 | 24.06 | 46.00 | -21.94 |
| 364.65 | Peak | S | 41.59 | -16.98 | 24.61 | 46.00 | -21.39 |
| 400.54 | Peak | S | 40.98 | -15.84 | 25.14 | 46.00 | -20.86 |

Unless otherwise stated the results shown in this test report refer only to the sample(s) tested and such sample(s) are retained for 90 days only.

除非另有說明，此報告結果僅對測試之樣品負責，同時此樣品僅保留90天。本報告未經本公司書面許可，不可部份複製。

This document is issued by the Company subject to its General Conditions of Service printed overleaf, available on request or accessible at www.sgs.com/terms_and_conditions.htm and, for electronic format documents, subject to Terms and Conditions for Electronic Documents at www.sgs.com/terms_e-document.htm. Attention is drawn to the limitation of liability, indemnification and jurisdiction issues defined therein. Any holder of this document is advised that information contained hereon reflects the Company's findings at the time of its intervention only and within the limits of Client's instructions, if any. The Company's sole responsibility is to its Client and this document does not exonerate parties to a transaction from exercising all their rights and obligations under the transaction documents. This document cannot be reproduced except in full, without prior written approval of the Company. Any unauthorized alteration, forgery or falsification of the content or appearance of this document is unlawful and offenders may be prosecuted to the fullest extent of the law.

For Frequency above 1GHz

| | | | |
|-----------------------|-----------|--------------------------|-----------------|
| Operation Band | :BT4.0 | Test Date | :2015-03-27 |
| Fundamental Frequency | :2402 MHz | Temp./Humi. | :17.5deg_C/72RH |
| Operation Mode | :TX LOW | Engineer | :Vito |
| EUT Pol. | :E2 Plane | Measurement Antenna Pol. | :VERTICAL |

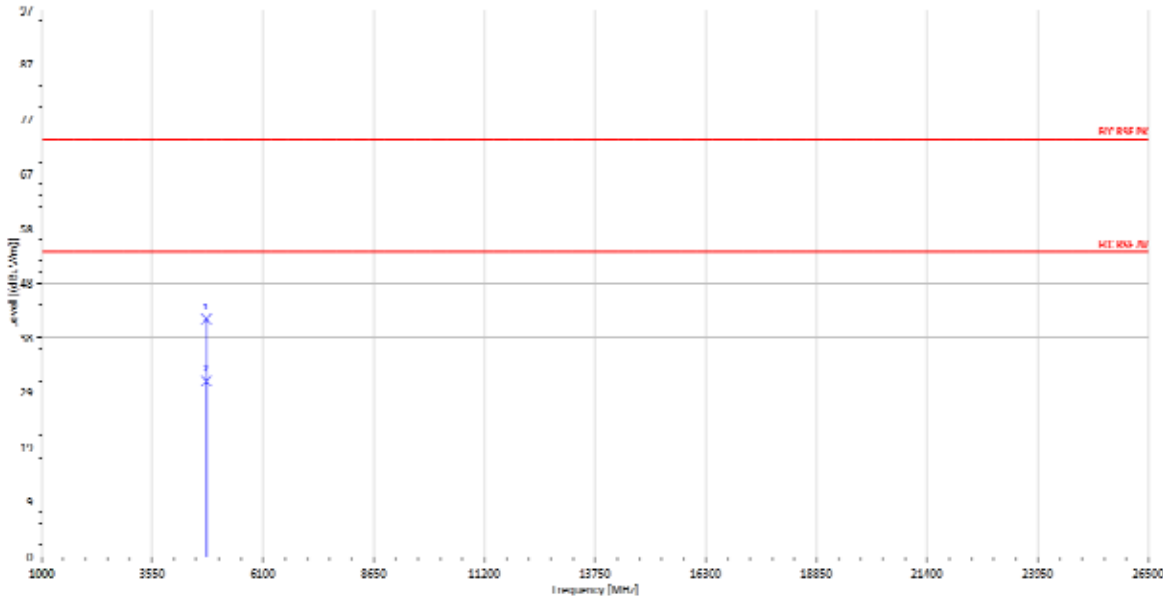

| Freq. MHz | Detector Mode | Note F/H/E/S | Spectrum Reading Level dBμV | Factor dB | Actual FS dBμV/m | Limit @3m dBμV/m | Margin dB |
|--------------|------------------|-----------------|-----------------------------------|--------------|------------------------|------------------------|--------------|
| 4804.00 | Peak | H | 31.12 | 10.98 | 42.09 | 74.00 | -31.91 |
| 4804.00 | Average | H | 20.05 | 10.98 | 31.03 | 54.00 | -22.97 |

Unless otherwise stated the results shown in this test report refer only to the sample(s) tested and such sample(s) are retained for 90 days only.

除非另有說明，此報告結果僅對測試之樣品負責，同時此樣品僅保留90天。本報告未經本公司書面許可，不可部份複製。

This document is issued by the Company subject to its General Conditions of Service printed overleaf, available on request or accessible at www.sgs.com/terms_and_conditions.htm and, for electronic format documents, subject to Terms and Conditions for Electronic Documents at www.sgs.com/terms_e-document.htm. Attention is drawn to the limitation of liability, indemnification and jurisdiction issues defined therein. Any holder of this document is advised that information contained hereon reflects the Company's findings at the time of its intervention only and within the limits of Client's instructions, if any. The Company's sole responsibility is to its Client and this document does not exonerate parties to a transaction from exercising all their rights and obligations under the transaction documents. This document cannot be reproduced except in full, without prior written approval of the Company. Any unauthorized alteration, forgery or falsification of the content or appearance of this document is unlawful and offenders may be prosecuted to the fullest extent of the law.

| | | | |
|-----------------------|-----------|--------------------------|-----------------|
| Operation Band | :BT4.0 | Test Date | :2015-03-27 |
| Fundamental Frequency | :2402 MHz | Temp./Humi. | :17.5deg_C/72RH |
| Operation Mode | :TX LOW | Engineer | :Vito |
| EUT Pol. | :E2 Plane | Measurement Antenna Pol. | :HORIZONTAL |

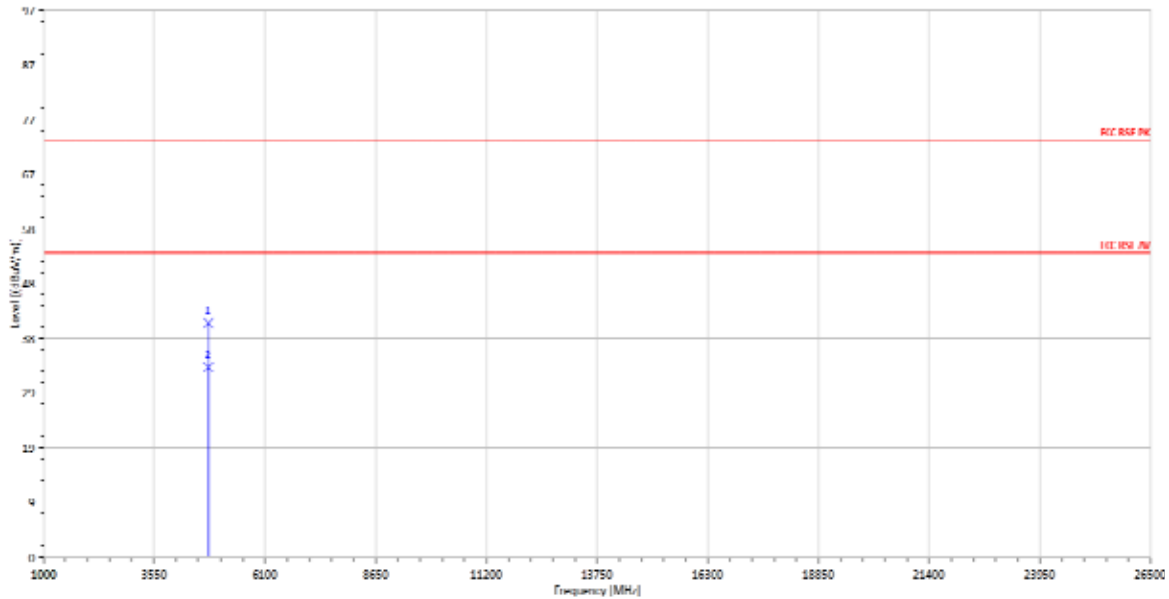

| Freq. MHz | Detector Mode | Note F/H/E/S | Spectrum Reading Level dBμV | Factor dB | Actual FS dBμV/m | Limit @3m dBμV/m | Margin dB |
|--------------|------------------|-----------------|-----------------------------------|--------------|------------------------|------------------------|--------------|
| 4804.00 | Peak | H | 30.50 | 10.98 | 41.47 | 74.00 | -32.53 |
| 4804.00 | Average | H | 22.69 | 10.98 | 33.67 | 54.00 | -20.33 |

Unless otherwise stated the results shown in this test report refer only to the sample(s) tested and such sample(s) are retained for 90 days only.

除非另有說明，此報告結果僅對測試之樣品負責，同時此樣品僅保留90天。本報告未經本公司書面許可，不可部份複製。

This document is issued by the Company subject to its General Conditions of Service printed overleaf, available on request or accessible at www.sgs.com/terms_and_conditions.htm and, for electronic format documents, subject to Terms and Conditions for Electronic Documents at www.sgs.com/terms_e-document.htm. Attention is drawn to the limitation of liability, indemnification and jurisdiction issues defined therein. Any holder of this document is advised that information contained hereon reflects the Company's findings at the time of its intervention only and within the limits of Client's instructions, if any. The Company's sole responsibility is to its Client and this document does not exonerate parties to a transaction from exercising all their rights and obligations under the transaction documents. This document cannot be reproduced except in full, without prior written approval of the Company. Any unauthorized alteration, forgery or falsification of the content or appearance of this document is unlawful and offenders may be prosecuted to the fullest extent of the law.

| | | | |
|-----------------------|-----------|--------------------------|-----------------|
| Operation Band | :BT4.0 | Test Date | :2015-03-27 |
| Fundamental Frequency | :2442 MHz | Temp./Humi. | :17.5deg_C/72RH |
| Operation Mode | :TX MID | Engineer | :Vito |
| EUT Pol. | :E2 Plane | Measurement Antenna Pol. | :VERTICAL |

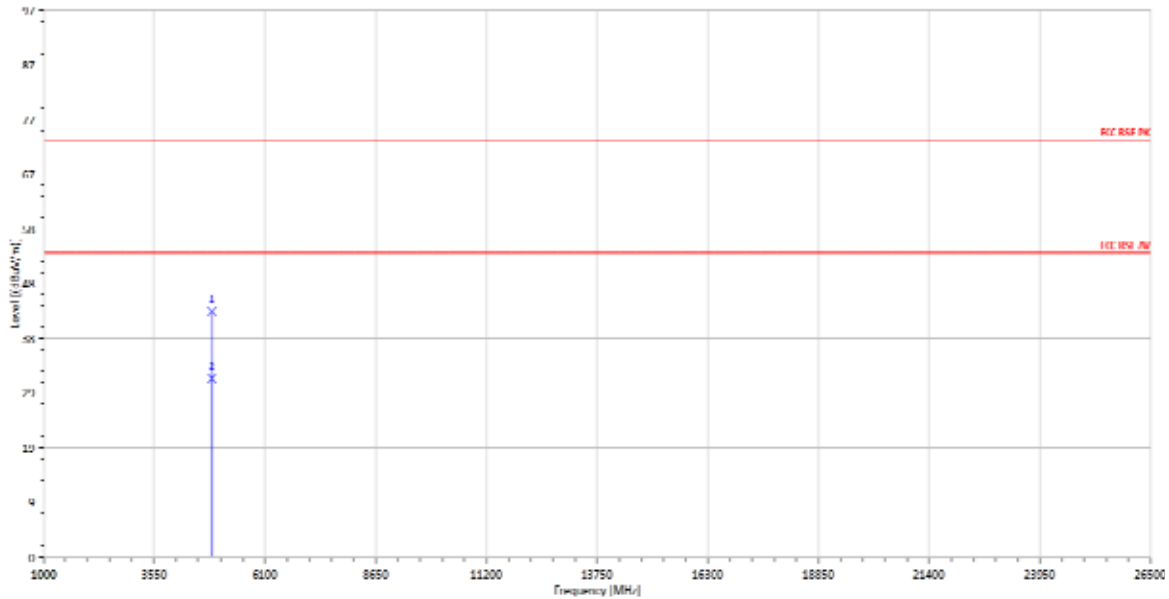

| Freq. MHz | Detector Mode | Note F/H/E/S | Spectrum Reading Level dBμV | Factor dB | Actual FS dBμV/m | Limit @3m dBμV/m | Margin dB |
|--------------|------------------|-----------------|-----------------------------------|--------------|------------------------|------------------------|--------------|
| 4884.00 | Peak | H | 32.63 | 10.92 | 43.56 | 74.00 | -30.44 |
| 4884.00 | Average | H | 20.75 | 10.92 | 31.67 | 54.00 | -22.33 |

Unless otherwise stated the results shown in this test report refer only to the sample(s) tested and such sample(s) are retained for 90 days only.

除非另有說明，此報告結果僅對測試之樣品負責，同時此樣品僅保留90天。本報告未經本公司書面許可，不可部份複製。

This document is issued by the Company subject to its General Conditions of Service printed overleaf, available on request or accessible at www.sgs.com/terms_and_conditions.htm and, for electronic format documents, subject to Terms and Conditions for Electronic Documents at www.sgs.com/terms_e-document.htm. Attention is drawn to the limitation of liability, indemnification and jurisdiction issues defined therein. Any holder of this document is advised that information contained hereon reflects the Company's findings at the time of its intervention only and within the limits of Client's instructions, if any. The Company's sole responsibility is to its Client and this document does not exonerate parties to a transaction from exercising all their rights and obligations under the transaction documents. This document cannot be reproduced except in full, without prior written approval of the Company. Any unauthorized alteration, forgery or falsification of the content or appearance of this document is unlawful and offenders may be prosecuted to the fullest extent of the law.

SGS Taiwan Ltd.

No.134,WuKungRoad,NewTaipeiIndustrialPark,WukuDistrict,NewTaipeiCity,Taiwan24803/新北市五股區新北產業園區五工路 134 號

台灣檢驗科技股份有限公司

t (886-2) 2299-3279

f (886-2) 2298-0488

www.tw.sgs.com

Member of SGS Group

| | | | |
|-----------------------|-----------|--------------------------|-----------------|
| Operation Band | :BT4.0 | Test Date | :2015-03-27 |
| Fundamental Frequency | :2442 MHz | Temp./Humi. | :17.5deg_C/72RH |
| Operation Mode | :TX MID | Engineer | :Vito |
| EUT Pol. | :E2 Plane | Measurement Antenna Pol. | :HORIZONTAL |

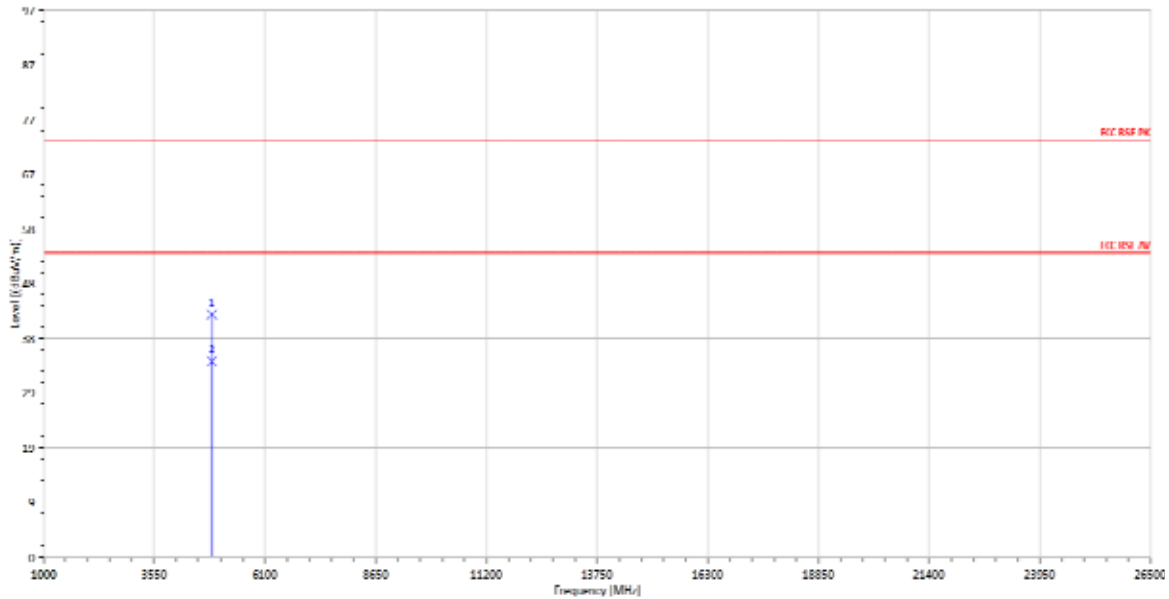

| Freq. MHz | Detector Mode | Note F/H/E/S | Spectrum Reading Level dBμV | Factor dB | Actual FS dBμV/m | Limit @3m dBμV/m | Margin dB |
|--------------|------------------|-----------------|-----------------------------------|--------------|------------------------|------------------------|--------------|
| 4884.00 | Peak | H | 32.08 | 10.92 | 43.00 | 74.00 | -31.00 |
| 4884.00 | Average | H | 23.76 | 10.92 | 34.68 | 54.00 | -19.32 |

Unless otherwise stated the results shown in this test report refer only to the sample(s) tested and such sample(s) are retained for 90 days only.

除非另有說明，此報告結果僅對測試之樣品負責，同時此樣品僅保留90天。本報告未經本公司書面許可，不可部份複製。

This document is issued by the Company subject to its General Conditions of Service printed overleaf, available on request or accessible at www.sgs.com/terms_and_conditions.htm and, for electronic format documents, subject to Terms and Conditions for Electronic Documents at www.sgs.com/terms_e-document.htm. Attention is drawn to the limitation of liability, indemnification and jurisdiction issues defined therein. Any holder of this document is advised that information contained hereon reflects the Company's findings at the time of its intervention only and within the limits of Client's instructions, if any. The Company's sole responsibility is to its Client and this document does not exonerate parties to a transaction from exercising all their rights and obligations under the transaction documents. This document cannot be reproduced except in full, without prior written approval of the Company. Any unauthorized alteration, forgery or falsification of the content or appearance of this document is unlawful and offenders may be prosecuted to the fullest extent of the law.

SGS Taiwan Ltd.

No.134,WuKungRoad,NewTaipeiIndustrialPark,WukuDistrict,NewTaipeiCity,Taiwan24803/新北市五股區新北產業園區五工路 134 號

台灣檢驗科技股份有限公司

t (886-2) 2299-3279

f (886-2) 2298-0488

www.tw.sgs.com

Member of SGS Group

| | | | |
|-----------------------|-----------|--------------------------|-----------------|
| Operation Band | :BT4.0 | Test Date | :2015-03-27 |
| Fundamental Frequency | :2480 MHz | Temp./Humi. | :17.5deg_C/72RH |
| Operation Mode | :TX HIGH | Engineer | :Vito |
| EUT Pol. | :E2 Plane | Measurement Antenna Pol. | :VERTICAL |

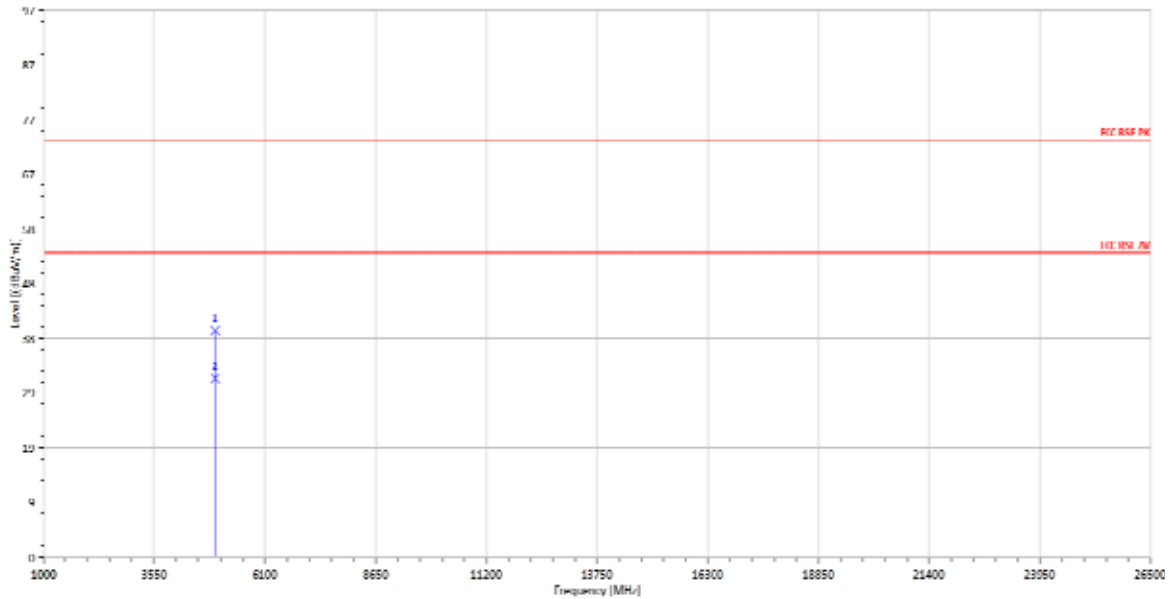

| Freq. MHz | Detector Mode | Note F/H/E/S | Spectrum Reading Level dBμV | Factor dB | Actual FS dBμV/m | Limit @3m dBμV/m | Margin dB |
|--------------|------------------|-----------------|-----------------------------------|--------------|------------------------|------------------------|--------------|
| 4960.00 | Peak | H | 29.16 | 10.99 | 40.15 | 74.00 | -33.85 |
| 4960.00 | Average | H | 20.68 | 10.99 | 31.67 | 54.00 | -22.33 |

Unless otherwise stated the results shown in this test report refer only to the sample(s) tested and such sample(s) are retained for 90 days only.

除非另有說明，此報告結果僅對測試之樣品負責，同時此樣品僅保留90天。本報告未經本公司書面許可，不可部份複製。

This document is issued by the Company subject to its General Conditions of Service printed overleaf, available on request or accessible at www.sgs.com/terms_and_conditions.htm and, for electronic format documents, subject to Terms and Conditions for Electronic Documents at www.sgs.com/terms_e-document.htm. Attention is drawn to the limitation of liability, indemnification and jurisdiction issues defined therein. Any holder of this document is advised that information contained hereon reflects the Company's findings at the time of its intervention only and within the limits of Client's instructions, if any. The Company's sole responsibility is to its Client and this document does not exonerate parties to a transaction from exercising all their rights and obligations under the transaction documents. This document cannot be reproduced except in full, without prior written approval of the Company. Any unauthorized alteration, forgery or falsification of the content or appearance of this document is unlawful and offenders may be prosecuted to the fullest extent of the law.

| | | | |
|-----------------------|-----------|--------------------------|-----------------|
| Operation Band | :BT4.0 | Test Date | :2015-03-27 |
| Fundamental Frequency | :2480 MHz | Temp./Humi. | :17.5deg_C/72RH |
| Operation Mode | :TX HIGH | Engineer | :Vito |
| EUT Pol. | :E2 Plane | Measurement Antenna Pol. | :HORIZONTAL |

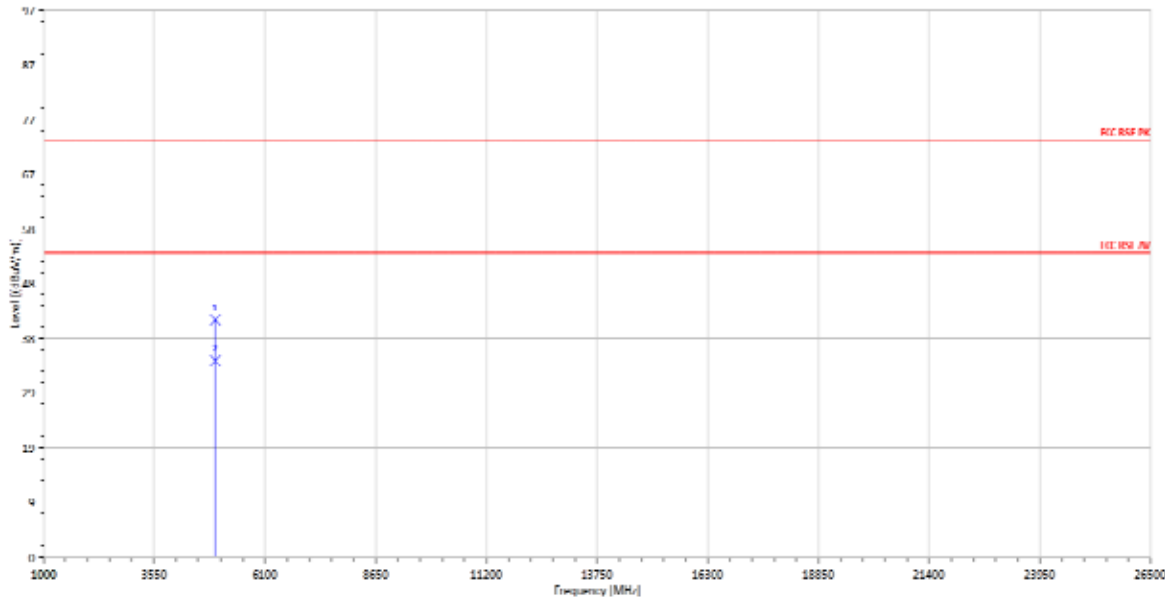

| Freq. MHz | Detector Mode | Note F/H/E/S | Spectrum Reading Level dBμV | Factor dB | Actual FS dBμV/m | Limit @3m dBμV/m | Margin dB |
|--------------|------------------|-----------------|-----------------------------------|--------------|------------------------|------------------------|--------------|
| 4960.00 | Peak | H | 31.06 | 10.99 | 42.06 | 74.00 | -31.94 |
| 4960.00 | Average | H | 23.80 | 10.99 | 34.79 | 54.00 | -19.21 |

Unless otherwise stated the results shown in this test report refer only to the sample(s) tested and such sample(s) are retained for 90 days only.

除非另有說明，此報告結果僅對測試之樣品負責，同時此樣品僅保留90天。本報告未經本公司書面許可，不可部份複製。

This document is issued by the Company subject to its General Conditions of Service printed overleaf, available on request or accessible at www.sgs.com/terms_and_conditions.htm and, for electronic format documents, subject to Terms and Conditions for Electronic Documents at www.sgs.com/terms_e-document.htm. Attention is drawn to the limitation of liability, indemnification and jurisdiction issues defined therein. Any holder of this document is advised that information contained hereon reflects the Company's findings at the time of its intervention only and within the limits of Client's instructions, if any. The Company's sole responsibility is to its Client and this document does not exonerate parties to a transaction from exercising all their rights and obligations under the transaction documents. This document cannot be reproduced except in full, without prior written approval of the Company. Any unauthorized alteration, forgery or falsification of the content or appearance of this document is unlawful and offenders may be prosecuted to the fullest extent of the law.

SGS Taiwan Ltd.

No.134,WuKungRoad,NewTaipeiIndustrialPark,WukuDistrict,NewTaipeiCity,Taiwan24803/新北市五股區新北產業園區五工路 134 號

台灣檢驗科技股份有限公司

t (886-2) 2299-3279

f (886-2) 2298-0488

www.tw.sgs.com

Member of SGS Group

11 PEAK POWER SPECTRAL DENSITY

11.1 Standard Applicable:

The power spectral density conducted from the intentional radiator to the antenna shall not be greater than 8dBm in any 3 kHz band during any time interval of continuous transmission.

11.2 Measurement Equipment Used:

| Conducted Emission Test Site | | | | | |
|------------------------------|-----------|--------------|---------------|------------|------------|
| EQUIPMENT TYPE | MFR | MODEL NUMBER | SERIAL NUMBER | LAST CAL. | CAL DUE. |
| Spectrum Analyzer | Agilent | N9010A | MY53400256 | 10/15/2014 | 10/14/2015 |
| DC Block | PASTERNAK | PE8210 | RF29 | 12/19/2014 | 12/18/2015 |
| Attenuator | WOKEN | 218FS-10 | RF23 | 12/19/2014 | 12/18/2015 |

11.3 Test Set-up:



11.4 Measurement Procedure:

1. Set analyzer center frequency to DTS channel center frequency.
2. The testing follows the Measurement Procedure of FCC KDB 558074 D01 DTS Meas. Guidance V03r02.
2. Set the span to 1.5 times the DTS channel bandwidth.
3. Set the RBW \geq 3 kHz.
4. Set the VBW \geq 3 x RBW.
5. Detector = peak.
6. Sweep time = auto couple.
7. Trace mode = max hold.
8. Allow trace to fully stabilize.
9. Use the peak marker function to determine the maximum amplitude level.
10. If measured value exceeds limit, reduce RBW (no less than 3 kHz) and repeat.

Unless otherwise stated the results shown in this test report refer only to the sample(s) tested and such sample(s) are retained for 90 days only.

除非另有說明，此報告結果僅對測試之樣品負責，同時此樣品僅保留90天。本報告未經本公司書面許可，不可部份複製。

This document is issued by the Company subject to its General Conditions of Service printed overleaf, available on request or accessible at www.sgs.com/terms_and_conditions.htm and, for electronic format documents, subject to Terms and Conditions for Electronic Documents at www.sgs.com/terms_e-document.htm. Attention is drawn to the limitation of liability, indemnification and jurisdiction issues defined therein. Any holder of this document is advised that information contained hereon reflects the Company's findings at the time of its intervention only and within the limits of Client's instructions, if any. The Company's sole responsibility is to its Client and this document does not exonerate parties to a transaction from exercising all their rights and obligations under the transaction documents. This document cannot be reproduced except in full, without prior written approval of the Company. Any unauthorized alteration, forgery or falsification of the content or appearance of this document is unlawful and offenders may be prosecuted to the fullest extent of the law.

SGS Taiwan Ltd.

No.134,WuKungRoad,NewTaipeiIndustrialPark,WukuDistrict,NewTaipeiCity,Taiwan24803/新北市五股區新北產業園區五工路 134 號

台灣檢驗科技股份有限公司

t (886-2) 2299-3279

f (886-2) 2298-0488

www.tw.sgs.com

Member of SGS Group

11.5 Measurement Result:

BT4.0 mode

| Frequency MHz | RF Power Density (dBm) | Limit (dBm) | Result |
|------------------|---------------------------|----------------|--------|
| 2402 | -12.88 | 8 | PASS |
| 2442 | -11.29 | 8 | PASS |
| 2480 | -10.62 | 8 | PASS |

Note: Refer to next page for plots.

Unless otherwise stated the results shown in this test report refer only to the sample(s) tested and such sample(s) are retained for 90 days only.

除非另有說明，此報告結果僅對測試之樣品負責，同時此樣品僅保留90天。本報告未經本公司書面許可，不可部份複製。

This document is issued by the Company subject to its General Conditions of Service printed overleaf, available on request or accessible at www.sgs.com/terms_and_conditions.htm and, for electronic format documents, subject to Terms and Conditions for Electronic Documents at www.sgs.com/terms_e-document.htm. Attention is drawn to the limitation of liability, indemnification and jurisdiction issues defined therein. Any holder of this document is advised that information contained hereon reflects the Company's findings at the time of its intervention only and within the limits of Client's instructions, if any. The Company's sole responsibility is to its Client and this document does not exonerate parties to a transaction from exercising all their rights and obligations under the transaction documents. This document cannot be reproduced except in full, without prior written approval of the Company. Any unauthorized alteration, forgery or falsification of the content or appearance of this document is unlawful and offenders may be prosecuted to the fullest extent of the law.

SGS Taiwan Ltd.

No.134,WuKungRoad,NewTaipeiIndustrialPark,WukuDistrict,NewTaipeiCity,Taiwan24803/新北市五股區新北產業園區五工路 134 號

台灣檢驗科技股份有限公司

t (886-2) 2299-3279

f (886-2) 2298-0488

www.tw.sgs.com

Member of SGS Group

BT4.0 mode
Power Spectral Density Test Plot (CH-Low)

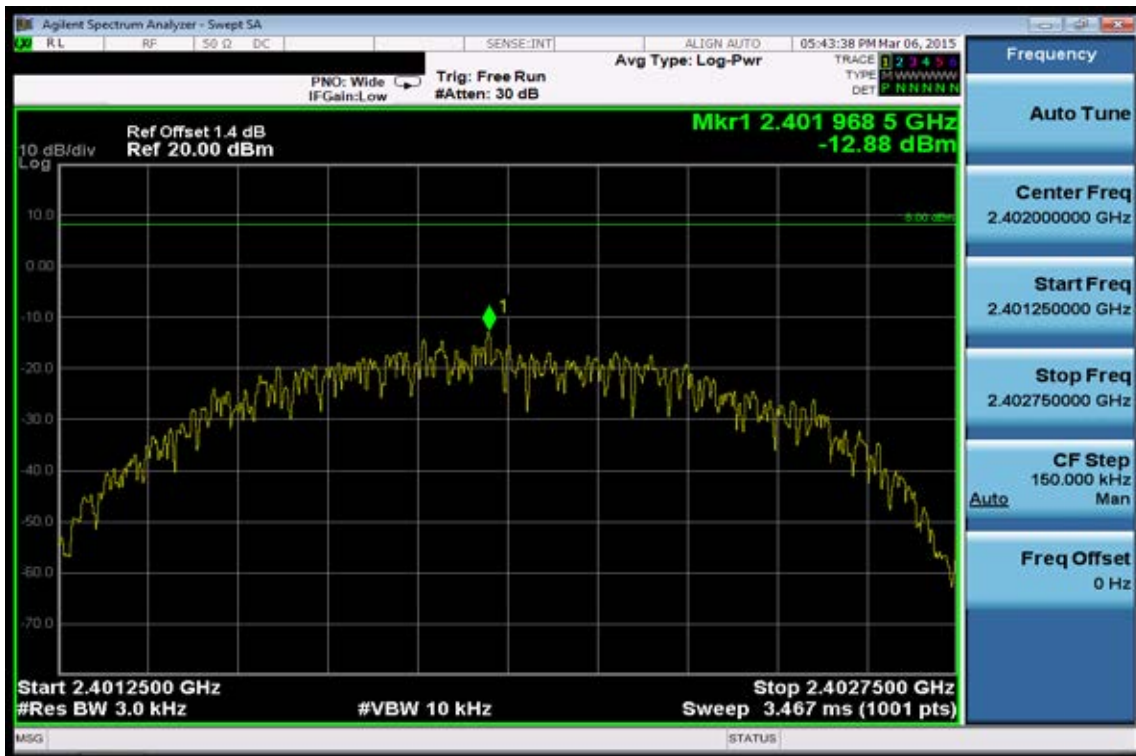

Power Spectral Density Test Plot (CH-Mid)

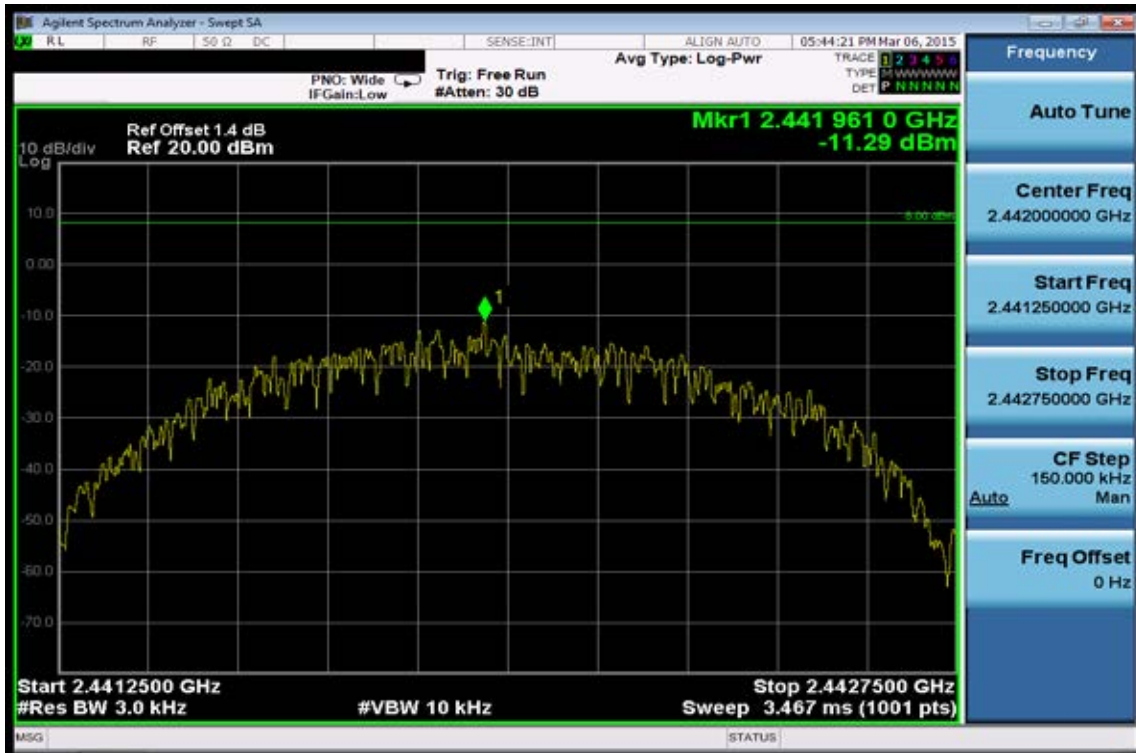

Unless otherwise stated the results shown in this test report refer only to the sample(s) tested and such sample(s) are retained for 90 days only.

除非另有說明，此報告結果僅對測試之樣品負責，同時此樣品僅保留90天。本報告未經本公司書面許可，不可部份複製。

This document is issued by the Company subject to its General Conditions of Service printed overleaf, available on request or accessible at www.sgs.com/terms_and_conditions.htm and, for electronic format documents, subject to Terms and Conditions for Electronic Documents at www.sgs.com/terms_e-document.htm. Attention is drawn to the limitation of liability, indemnification and jurisdiction issues defined therein. Any holder of this document is advised that information contained hereon reflects the Company's findings at the time of its intervention only and within the limits of Client's instructions, if any. The Company's sole responsibility is to its Client and this document does not exonerate parties to a transaction from exercising all their rights and obligations under the transaction documents. This document cannot be reproduced except in full, without prior written approval of the Company. Any unauthorized alteration, forgery or falsification of the content or appearance of this document is unlawful and offenders may be prosecuted to the fullest extent of the law.

SGS Taiwan Ltd.

No. 134, WuKungRoad, NewTaipeiIndustrialPark, WukuDistrict, NewTaipeiCity, Taiwan24803/新北市五股區新北產業園區五工路 134 號

台灣檢驗科技股份有限公司

t (886-2) 2299-3279

f (886-2) 2298-0488

www.tw.sgs.com

Member of SGS Group

Power Spectral Density Test Plot (CH-High)



Unless otherwise stated the results shown in this test report refer only to the sample(s) tested and such sample(s) are retained for 90 days only.

除非另有說明，此報告結果僅對測試之樣品負責，同時此樣品僅保留90天。本報告未經本公司書面許可，不可部份複製。

This document is issued by the Company subject to its General Conditions of Service printed overleaf, available on request or accessible at www.sgs.com/terms_and_conditions.htm and, for electronic format documents, subject to Terms and Conditions for Electronic Documents at www.sgs.com/terms_e-document.htm. Attention is drawn to the limitation of liability, indemnification and jurisdiction issues defined therein. Any holder of this document is advised that information contained hereon reflects the Company's findings at the time of its intervention only and within the limits of Client's instructions, if any. The Company's sole responsibility is to its Client and this document does not exonerate parties to a transaction from exercising all their rights and obligations under the transaction documents. This document cannot be reproduced except in full, without prior written approval of the Company. Any unauthorized alteration, forgery or falsification of the content or appearance of this document is unlawful and offenders may be prosecuted to the fullest extent of the law.

SGS Taiwan Ltd.

No. 134, WuKungRoad, NewTaipeiIndustrialPark, WukuDistrict, NewTaipeiCity, Taiwan24803/新北市五股區新北產業園區五工路 134 號

台灣檢驗科技股份有限公司

t (886-2) 2299-3279

f (886-2) 2298-0488

www.tw.sgs.com

Member of SGS Group

12 ANTENNA REQUIREMENT

12.1 Standard Applicable:

For intentional device, according to §15.203, an intentional radiator shall be designed to ensure that no antenna other than furnished by the responsible party shall be used with the device.

If the transmitting antenna is greater than 6dBi, the power shall be reduced by the same level in dB comparing to gain minus 6dBi.

In case of point-to-point operation, the power shall be reduced by the one dB for every 3 dB that the directional gain of antenna exceeds 6dBi.

According to RSS-GEN 6.7

As per RSP-100, each applicant for equipment certification must provide a list of all antenna types that may be used with the transmitter, indicating the maximum permissible antenna gain (in dBi).

When a measurement at the antenna connector is used to determine RF output power, the effective gain of the device's antenna shall be stated, based on a measurement or on data from the antenna's manufacturer. The test report shall state the RF power, output power setting and spurious emission measurements, including the antenna type used.

In addition, applicants shall perform RF power and spurious emission measurements with each antenna type supplied or specified by the manufacturer for use with the transmitter.

According to RSS-GEN 8.3

The applicant for equipment certification, as per RSP-100, must provide a list of all antenna types that may be used with the licence-exempt transmitter, indicating the maximum permissible antenna gain (in dBi) and the required impedance for each antenna.

Licence-exempt transmitters that have received equipment certification may operate with different types of antennas. However, it is not permissible to exceed the maximum equivalent isotropically radiated power (e.i.r.p.) limits specified in the applicable standard (RSS) for the licence-exempt apparatus.

Testing shall be performed using the highest gain antenna of each combination of licence-exempt transmitter and antenna type, with the transmitter output power set at the maximum level. When a measurement at the antenna connector is used to determine RF output power, the effective gain of the device's antenna shall be stated, based on a measurement or on data from the antenna manufacturer.

12.2 Antenna Connected Construction:

An embedded-in antenna design is used.

The antenna connector is designed with unique type RF connector and no consideration of replacement. Please see EUT photo and antenna spec. for details.

The antenna gain is less than 6dBi. Therefore, it is not necessary to reduce maximum output power limit.

~ End of Report ~

Unless otherwise stated the results shown in this test report refer only to the sample(s) tested and such sample(s) are retained for 90 days only.

除非另有說明，此報告結果僅對測試之樣品負責，同時此樣品僅保留90天。本報告未經本公司書面許可，不可部份複製。

This document is issued by the Company subject to its General Conditions of Service printed overleaf, available on request or accessible at www.sgs.com/terms_and_conditions.htm and, for electronic format documents, subject to Terms and Conditions for Electronic Documents at www.sgs.com/terms_e-document.htm. Attention is drawn to the limitation of liability, indemnification and jurisdiction issues defined therein. Any holder of this document is advised that information contained hereon reflects the Company's findings at the time of its intervention only and within the limits of Client's instructions, if any. The Company's sole responsibility is to its Client and this document does not exonerate parties to a transaction from exercising all their rights and obligations under the transaction documents. This document cannot be reproduced except in full, without prior written approval of the Company. Any unauthorized alteration, forgery or falsification of the content or appearance of this document is unlawful and offenders may be prosecuted to the fullest extent of the law.

SGS Taiwan Ltd.

台灣檢驗科技股份有限公司

No. 134, WuKungRoad, NewTaipeiIndustrialPark, WukuDistrict, NewTaipeiCity, Taiwan24803/新北市五股區新北產業園區五工路 134 號

t (886-2) 2299-3279

f (886-2) 2298-0488

www.tw.sgs.com

Member of SGS Group