



# FCC TEST REPORT (Bluetooth EDR)

**REPORT NO.:** RF140828C01-1

**MODEL NO.:** A1410

**FCC ID:** HLZA1410

**RECEIVED:** Aug. 28, 2014

**TESTED:** Sep. 05 ~ Sep. 19, 2014

**ISSUED:** Sep. 22, 2014

**APPLICANT:** Acer Incorporated

**ADDRESS:** 8F., No. 88, Sec. 1, Xintai 5th Rd., Xizhi Dist., New Taipei City 221, Taiwan

**ISSUED BY:** Bureau Veritas Consumer Products Services (H.K.) Ltd., Taoyuan Branch

**LAB ADDRESS:** No. 47-2, 14th Ling, Chia Pau Vil., Lin Kou Dist., New Taipei City, Taiwan, R.O.C.

**TEST LOCATION:** No. 19, Hwa Ya 2nd Rd, Wen Hwa Tsuen, Kwei Shan Hsiang, Taoyuan Hsien 333, Taiwan, R.O.C.

This report should not be used by the client to claim product certification, approval, or endorsement by TAF or any government agencies.



This report is for your exclusive use. Any copying or replication of this report to or for any other person or entity, or use of our name or trademark, is permitted only with our prior written permission. This report sets forth our findings solely with respect to the test samples identified herein. The results set forth in this report are not indicative or representative of the quality or characteristics of the lot from which a test sample was taken or any similar or identical product unless specifically and expressly noted. Our report includes all of the tests requested by you and the results thereof based upon the information that you provided to us. You have 60 days from date of issuance of this report to notify us of any material error or omission caused by our negligence, provided, however, that such notice shall be in writing and shall specifically address the issue you wish to raise. A failure to raise such issue within the prescribed time shall constitute your unqualified acceptance of the completeness of this report, the tests conducted and the correctness of the report contents. Unless specific mention, the uncertainty of measurement has been explicitly taken into account to declare the compliance or non-compliance to the specification.

## Table of Contents

RELEASE CONTROL RECORD .....	4
1. CERTIFICATION .....	5
2. SUMMARY OF TEST RESULTS .....	6
2.1 MEASUREMENT UNCERTAINTY .....	6
3. GENERAL INFORMATION .....	7
3.1 GENERAL DESCRIPTION OF EUT .....	7
3.2 DESCRIPTION OF TEST MODES .....	8
3.2.1 TEST MODE APPLICABILITY AND TESTED CHANNEL DETAIL .....	9
3.3 DESCRIPTION OF SUPPORT UNITS .....	11
3.3.1 CONFIGURATION OF SYSTEM UNDER TEST .....	11
3.4 GENERAL DESCRIPTION OF APPLIED STANDARDS .....	11
4. TEST TYPES AND RESULTS .....	12
4.1 RADIATED EMISSION AND BANDEDGE MEASUREMENT .....	12
4.1.1 LIMITS OF RADIATED EMISSION AND BANDEDGE MEASUREMENT .....	12
4.1.2 TEST INSTRUMENTS .....	13
4.1.3 TEST PROCEDURES .....	14
4.1.4 DEVIATION FROM TEST STANDARD .....	14
4.1.5 TEST SETUP .....	15
4.1.6 EUT OPERATING CONDITIONS .....	16
4.1.7 TEST RESULTS .....	17
4.2 CONDUCTED EMISSION MEASUREMENT .....	25
4.2.1 LIMITS OF CONDUCTED EMISSION MEASUREMENT .....	25
4.2.2 TEST INSTRUMENTS .....	25
4.2.3 TEST PROCEDURES .....	26
4.2.4 DEVIATION FROM TEST STANDARD .....	26
4.2.5 TEST SETUP .....	27
4.2.6 EUT OPERATING CONDITIONS .....	27
4.2.7 TEST RESULTS .....	28
4.3 NUMBER OF HOPPING FREQUENCY USED .....	32
4.3.1 LIMIT OF HOPPING FREQUENCY USED .....	32
4.3.2 TEST SETUP .....	32
4.3.3 TEST INSTRUMENTS .....	32
4.3.4 TEST PROCEDURES .....	32
4.3.5 DEVIATION FROM TEST STANDARD .....	32
4.3.6 TEST RESULTS .....	32
4.4 DWELL TIME ON EACH CHANNEL .....	34
4.4.1 LIMIT OF DWELL TIME USED .....	34
4.4.2 TEST SETUP .....	34
4.4.3 TEST INSTRUMENTS .....	34
4.4.4 TEST PROCEDURES .....	34
4.4.5 DEVIATION FROM TEST STANDARD .....	34
4.4.6 TEST RESULTS .....	35
4.5 CHANNEL BANDWIDTH .....	39
4.5.1 LIMITS OF CHANNEL BANDWIDTH .....	39
4.5.2 TEST SETUP .....	39
4.5.3 TEST INSTRUMENTS .....	39
4.5.4 TEST PROCEDURE .....	39
4.5.5 DEVIATION FROM TEST STANDARD .....	39



A D T

4.5.6	EUT OPERATING CONDITION.....	39
4.5.7	TEST RESULTS .....	40
4.6	HOPPING CHANNEL SEPARATION .....	41
4.6.1	LIMIT OF HOPPING CHANNEL SEPARATION .....	41
4.6.2	TEST SETUP .....	41
4.6.3	TEST INSTRUMENTS.....	41
4.6.4	TEST PROCEDURES .....	41
4.6.5	DEVIATION FROM TEST STANDARD .....	41
4.6.6	TEST RESULTS .....	42
4.7	MAXIMUM OUTPUT POWER .....	43
4.7.1	LIMITS OF MAXIMUM OUTPUT POWER MEASUREMENT .....	43
4.7.2	TEST SETUP .....	43
4.7.3	TEST INSTRUMENTS.....	43
4.7.4	TEST PROCEDURES .....	43
4.7.5	DEVIATION FROM TEST STANDARD .....	43
4.7.6	EUT OPERATING CONDITION.....	43
4.7.7	TEST RESULTS .....	44
4.8	CONDUCTED OUT OF BAND EMISSION MEASUREMENT .....	45
4.8.1	LIMITS OF CONDUCTED OUT OF BAND EMISSION MEASUREMENT.....	45
4.8.2	TEST INSTRUMENTS.....	45
4.8.3	TEST PROCEDURE.....	45
4.8.4	DEVIATION FROM TEST STANDARD .....	45
4.8.5	EUT OPERATING CONDITION.....	45
4.8.6	TEST RESULTS .....	45
5.	PHOTOGRAPHS OF THE TEST CONFIGURATION.....	48
6.	INFORMATION ON THE TESTING LABORATORIES.....	49
7.	APPENDIX A - MODIFICATIONS RECORDERS FOR ENGINEERING CHANGES TO THE EUT BY THE LAB.....	50



A D T

## RELEASE CONTROL RECORD

ISSUE NO.	REASON FOR CHANGE	DATE ISSUED
RF140828C01-1	Original release.	Sep. 22, 2014



A D T

## 1. CERTIFICATION

**PRODUCT:** Tablet Computer  
**MODEL NO.:** A1410  
**BRAND:** Acer  
**APPLICANT:** Acer Incorporated  
**TESTED:** Sep. 05 ~ Sep. 19, 2014  
**TEST SAMPLE:** ENGINEERING SAMPLE  
**STANDARDS:** **FCC Part 15, Subpart C (Section 15.247)**  
ANSI C63.10-2009

The above equipment (model: A1410) has been tested by **Bureau Veritas Consumer Products Services (H.K.) Ltd., Taoyuan Branch**, and found compliance with the requirement of the above standards. The test record, data evaluation & Equipment Under Test (EUT) configurations represented herein are true and accurate accounts of the measurements of the sample's EMC characteristics under the conditions specified in this report.

**PREPARED BY** :  , **DATE** : Sep. 22, 2014  
Pettie Chen / Senior Specialist

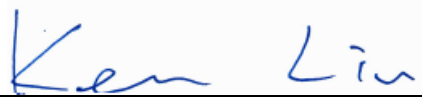
**APPROVED BY** :  , **DATE** : Sep. 22, 2014  
Ken Liu / Senior Manager

## 2. SUMMARY OF TEST RESULTS

The EUT has been tested according to the following specifications:

APPLIED STANDARD: FCC Part 15, Subpart C			
STANDARD SECTION	TEST TYPE AND LIMIT	RESULT	REMARK
15.207	AC Power Conducted Emission	PASS	Meet the requirement of limit. Minimum passing margin is -9.09dB at 1.61719MHz.
15.247(a)(1) (iii)	Number of Hopping Frequency Used	PASS	Meet the requirement of limit.
15.247(a)(1) (iii)	Dwell Time on Each Channel	PASS	Meet the requirement of limit.
15.247(a)(1)	1. Hopping Channel Separation 2. Spectrum Bandwidth of a Frequency Hopping Sequence Spread Spectrum System	PASS	Meet the requirement of limit.
15.247(b)	Maximum Peak Output Power	PASS	Meet the requirement of limit.
15.205 & 209	Radiated Emissions	PASS	Meet the requirement of limit. Minimum passing margin is -4.6dB at 33.30MHz.
15.247(d)	Band Edge Measurement	PASS	Meet the requirement of limit. Minimum passing margin is -28.9dB at 2483.50MHz.
15.247(d)	Antenna Port Emission	PASS	Meet the requirement of limit.
15.203	Antenna Requirement	PASS	Antenna connector is IPEX not a standard connector.

**NOTE:** If The Frequency Hopping System operating in 2400-2483.5MHz band and the output power less than 125mW. The hopping channel carrier frequencies separated by a minimum of 25kHz or two-thirds of the 20dB bandwidth of hopping channel whichever is greater.

### 2.1 MEASUREMENT UNCERTAINTY

Where relevant, the following measurement uncertainty levels have been estimated for tests performed on the EUT as specified in CISPR 16-4-2:

MEASUREMENT	FREQUENCY	UNCERTAINTY
Conducted emission	150kHz ~ 30MHz	2.44 dB
Radiated emissions	30MHz ~ 200MHz	3.63 dB
	200MHz ~1000MHz	3.64 dB
	1GHz ~ 18GHz	2.29 dB
	18GHz ~ 40GHz	2.29 dB

This uncertainty represents an expanded uncertainty expressed at approximately the 95% confidence level using a coverage factor of k=2.

### 3. GENERAL INFORMATION

#### 3.1 GENERAL DESCRIPTION OF EUT

<b>EUT</b>	Tablet Computer
<b>MODEL NO.</b>	A1410
<b>POWER SUPPLY</b>	3.8Vdc (Battery) 5.2 or 5.35Vdc (Adapter) 5.0Vdc (Host equipment)
<b>MODULATION TYPE</b>	GFSK, $\pi/4$ -DQPSK, 8DPSK
<b>MODULATION TECHNOLOGY</b>	FHSS
<b>TRANSFER RATE</b>	1/2/3Mbps
<b>OPERATING FREQUENCY</b>	2402 ~ 2480MHz
<b>NUMBER OF CHANNEL</b>	79
<b>MAX. OUTPUT POWER</b>	2.642mW
<b>ANTENNA TYPE</b>	PIFA antenna with 3.5dBi gain
<b>ANTENNA CONNECTOR</b>	IPEX
<b>DATA CABLE</b>	1.2m non-shielded USB cable without core
<b>I/O PORTS</b>	Refer to user's manual
<b>ACCESSORY DEVICES</b>	Adapter, Battery

**NOTE:**

1. The EUT consumes power from the following battery and adapters.

Battery	
<b>BRAND:</b>	LGC
<b>MODEL:</b>	AP14F8K
<b>RATING:</b>	3.8Vdc

ADAPTER 1	
<b>BRAND:</b>	LITEON
<b>MODEL:</b>	PA-1070-07
<b>INPUT:</b>	100-240Vac, 50/60Hz, 0.25A
<b>OUTPUT:</b>	5.2Vdc, 1.35A LPS

ADAPTER 2	
<b>BRAND:</b>	DELTA Electronics, INC.
<b>MODEL:</b>	ADP-10HW A
<b>INPUT:</b>	100-240Vac, 50-60Hz, 0.4A
<b>OUTPUT:</b>	5.35Vdc, 2A

\* Adapter 2 was the worst for the final tests.

2. The above EUT information is declared by manufacturer and for more detailed features description, please refer to the manufacturer's specifications or User's Manual.



### 3.2 DESCRIPTION OF TEST MODES

79 channels are provided to this EUT:

CHANNEL	FREQ. (MHz)	CHANNEL	FREQ. (MHz)	CHANNEL	FREQ. (MHz)	CHANNEL	FREQ. (MHz)
0	2402	20	2422	40	2442	60	2462
1	2403	21	2423	41	2443	61	2463
2	2404	22	2424	42	2444	62	2464
3	2405	23	2425	43	2445	63	2465
4	2406	24	2426	44	2446	64	2466
5	2407	25	2427	45	2447	65	2467
6	2408	26	2428	46	2448	66	2468
7	2409	27	2429	47	2449	67	2469
8	2410	28	2430	48	2450	68	2470
9	2411	29	2431	49	2451	69	2471
10	2412	30	2432	50	2452	70	2472
11	2413	31	2433	51	2453	71	2473
12	2414	32	2434	52	2454	72	2474
13	2415	33	2435	53	2455	73	2475
14	2416	34	2436	54	2456	74	2476
15	2417	35	2437	55	2457	75	2477
16	2418	36	2438	56	2458	76	2478
17	2419	37	2439	57	2459	77	2479
18	2420	38	2440	58	2460	78	2480
19	2421	39	2441	59	2461		



### 3.2.1 TEST MODE APPLICABILITY AND TESTED CHANNEL DETAIL

EUT CONFIGURE MODE	APPLICABLE TO				DESCRIPTION
	RE $\geq$ 1G	RE<1G	PLC	APCM	
A	-	√	√	-	Power from adapter 1
B	√	√	√	√	Power from adapter 2

Where **RE $\geq$ 1G**: Radiated Emission above 1GHz      **RE<1G**: Radiated Emission below 1GHz  
**PLC**: Power Line Conducted Emission      **APCM**: Antenna Port Conducted Measurement

**NOTE:** The EUT had been pre-tested on the positioned of each 3 axis. The worst case was found when positioned on **Z-plane**.

**NOTE:** "-" means no effect.

#### **RADIATED EMISSION TEST (ABOVE 1 GHz):**

- Pre-Scan has been conducted to determine the worst-case mode from all possible combinations between available modulations, antenna ports (if EUT with antenna diversity architecture) and packet type.
- Following channel(s) was (were) selected for the final test as listed below.

EUT CONFIGURE MODE	AVAILABLE CHANNEL	TESTED CHANNEL	MODULATION TECHNOLOGY	MODULATION TYPE	PACKET TYPE
B	0 to 78	0, 39, 78	FHSS	GFSK	DH5
B	0 to 78	0, 39, 78	FHSS	8DPSK	DH5

#### **RADIATED EMISSION TEST (BELOW 1 GHz):**

- Pre-Scan has been conducted to determine the worst-case mode from all possible combinations between available modulations, antenna ports (if EUT with antenna diversity architecture) and packet type.
- Following channel(s) was (were) selected for the final test as listed below.

EUT CONFIGURE MODE	AVAILABLE CHANNEL	TESTED CHANNEL	MODULATION TECHNOLOGY	MODULATION TYPE	PACKET TYPE
A, B	0 to 78	39	FHSS	GFSK	DH5

#### **POWER LINE CONDUCTED EMISSION:**

- Pre-Scan has been conducted to determine the worst-case mode from all possible combinations between available modulations, antenna ports (if EUT with antenna diversity architecture) and packet type.
- Following channel(s) was (were) selected for the final test as listed below.

EUT CONFIGURE MODE	AVAILABLE CHANNEL	TESTED CHANNEL	MODULATION TECHNOLOGY	MODULATION TYPE	PACKET TYPE
A, B	0 to 78	39	FHSS	GFSK	DH5



**BANDEDGE MEASUREMENT:**

- Pre-Scan has been conducted to determine the worst-case mode from all possible combinations between available modulations, antenna ports (if EUT with antenna diversity architecture), and packet types.
- Following channel(s) was (were) selected for the final test as listed below.

EUT CONFIGURE MODE	AVAILABLE CHANNEL	TESTED CHANNEL	MODULATION TECHNOLOGY	MODULATION TYPE	PACKET TYPE
B	0 to 78	0, 78	FHSS	GFSK	DH5
B	0 to 78	0, 78	FHSS	8DPSK	DH5

**ANTENNA PORT CONDUCTED MEASUREMENT:**

- This item includes all test value of each mode, but only includes spectrum plot of worst value of each mode.
- Pre-Scan has been conducted to determine the worst-case mode from all possible combinations between available modulations, antenna ports (if EUT with antenna diversity architecture), and packet types.
- Following channel(s) was (were) selected for the final test as listed below.

EUT CONFIGURE MODE	AVAILABLE CHANNEL	TESTED CHANNEL	MODULATION TECHNOLOGY	MODULATION TYPE	PACKET TYPE
B	0 to 78	0, 39, 78	FHSS	GFSK	DH5
B	0 to 78	0, 39, 78	FHSS	8DPSK	DH5

**TEST CONDITION:**

APPLICABLE TO	ENVIRONMENTAL CONDITIONS	INPUT POWER	TESTED BY
RE≥1G	25deg. C, 65%RH 21deg. C, 71%RH	120Vac, 60Hz	Ted Chang Nick Hsu
RE<1G	25deg. C, 65%RH	120Vac, 60Hz	Ted Chang
PLC	24deg. C, 64%RH	120Vac, 60Hz	Match Tsui
APCM	25deg. C, 60%RH	120Vac, 60Hz	Nick Chen

### 3.3 DESCRIPTION OF SUPPORT UNITS

The EUT has been tested as an independent unit together with other necessary accessories or support units.

#### 3.3.1 CONFIGURATION OF SYSTEM UNDER TEST

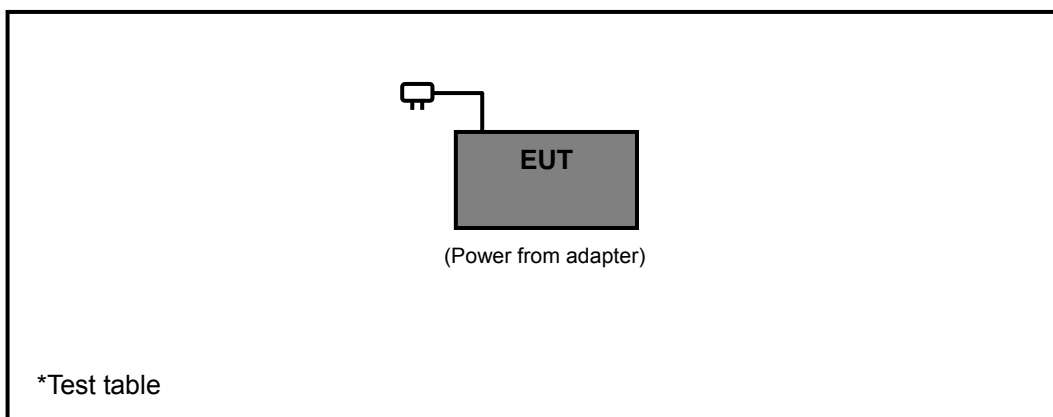

### 3.4 GENERAL DESCRIPTION OF APPLIED STANDARDS

The EUT is a RF Product. According to the specifications of the manufacturer, it must comply with the requirements of the following standards:

**FCC Part 15, Subpart C (15.247)**

**FCC Public Notice DA 00-705**

**ANSI C63.10-2009**

All test items have been performed and recorded as per the above standards.

**NOTE:** The EUT is also considered as a kind of computer peripheral, because the connection to computer is necessary for typical use. It has been verified to comply with the requirements of FCC Part 15, Subpart B, Class B (DoC). The test report has been issued separately.

## 4. TEST TYPES AND RESULTS

### 4.1 RADIATED EMISSION AND BANDEDGE MEASUREMENT

#### 4.1.1 LIMITS OF RADIATED EMISSION AND BANDEDGE MEASUREMENT

Radiated emissions which fall in the restricted bands must comply with the radiated emission limits specified as below table. Other emissions shall be at least 20dB below the highest level of the desired power:

FREQUENCIES (MHz)	FIELD STRENGTH (microvolts/meter)	MEASUREMENT DISTANCE (meters)
0.009 ~ 0.490	2400/F(kHz)	300
0.490 ~ 1.705	24000/F(kHz)	30
1.705 ~ 30.0	30	30
30 ~ 88	100	3
88 ~ 216	150	3
216 ~ 960	200	3
Above 960	500	3

**NOTE:**

1. The lower limit shall apply at the transition frequencies.
2. Emission level (dBuV/m) = 20 log Emission level (uV/m).
3. For frequencies above 1000MHz, the field strength limits are based on average detector, however, the peak field strength of any emission shall not exceed the maximum permitted average limits, specified above by more than 20dB under any condition of modulation.



A D T

#### 4.1.2 TEST INSTRUMENTS

DESCRIPTION & MANUFACTURER	MODEL NO.	SERIAL NO.	DATE OF CALIBRATION	DUE DATE OF CALIBRATION
Test Receiver ROHDE & SCHWARZ	ESCS30	100289	Nov. 29, 2013	Nov. 28, 2014
Spectrum Analyzer ROHDE & SCHWARZ	FSP40	100269	Feb. 11, 2014	Feb. 10, 2015
BILOG Antenna SCHWARZBECK	VULB9168	9168-156	Feb. 25, 2014	Feb. 24, 2015
HORN Antenna SCHWARZBECK	BBHA 9120D	9120D-404	Jan. 05, 2014	Jan. 04, 2015
HORN Antenna SCHWARZBECK	BBHA 9170	BBHA9170241	Feb. 17, 2014	Feb. 16, 2015
Preamplifier Agilent	8449B	3008A01961	Oct. 28, 2013	Oct. 27, 2014
Preamplifier Agilent	8447D	2944A10638	Oct. 18, 2013	Oct. 17, 2014
RF signal cable HUBER+SUHNNER	SUCOFLEX 104	309220/4 250724/4 295012/4	Aug. 09, 2014	Aug. 08, 2015
RF signal cable Worken	5D-FB	Cable-HYCH9-01	Aug. 11, 2014	Aug. 10, 2015
Software BV ADT	ADT_Radiated_ V7.6.15.9.4	NA	NA	NA
Antenna Tower EMCO	2070/2080	512.835.4684	NA	NA
Turn Table EMCO	2087-2.03	NA	NA	NA
Antenna Tower & Turn Table Controller EMCO	2090	NA	NA	NA
High Speed Peak Power Meter	ML2495A	0824011	Jul. 26, 2014	Jul. 25, 2015
Power Sensor	MA2411B	0738171	Jul. 26, 2014	Jul. 25, 2015

- NOTE:** 1. The calibration interval of the above test instruments is 12 months and the calibrations are traceable to NML/ROC and NIST/USA.
2. The test was performed in HwaYa Chamber 9.
3. The horn antenna and HP preamplifier (model: 8449B) are used only for the measurement of emission frequency above 1GHz if tested.
4. The FCC Site Registration No. is 215374.
5. The IC Site Registration No. is IC 7450F-9.

#### 4.1.3 TEST PROCEDURES

- a. The EUT was placed on the top of a rotating table 0.8 meters above the ground at a 3 meter semi-anechoic chamber. The table was rotated 360 degrees to determine the position of the highest radiation.
- b. The EUT was set 3 meters away from the interference-receiving antenna, which was mounted on the top of a variable-height antenna tower.
- c. The antenna is a broadband antenna, and its height is varied from one meter to four meters above the ground to determine the maximum value of the field strength. Both horizontal and vertical polarizations of the antenna are set to make the measurement.
- d. For each suspected emission, the EUT was arranged to its worst case and then the antenna was tuned to heights from 1 meter to 4 meters and the rotatable table was turned from 0 degrees to 360 degrees to find the maximum reading.
- e. The test-receiver system was set to Peak Detect Function and Specified Bandwidth with Maximum Hold Mode.
- f. If the emission level of the EUT in peak mode was lower than the limit specified, then testing could be stopped and the peak values of the EUT would be reported. Otherwise the emissions would be re-tested one by one using peak, quasi-peak or average method as specified and then reported in a data sheet.

**NOTE:**

1. The resolution bandwidth and video bandwidth of test receiver/spectrum analyzer is 120kHz for Quasi-peak detection at frequency below 1GHz.
2. The resolution bandwidth of test receiver/spectrum analyzer is 1 MHz and video bandwidth is 3MHz for Peak detection at frequency above 1GHz.
3. All modes of operation were investigated and the worst-case emissions are reported.

#### 4.1.4 DEVIATION FROM TEST STANDARD

No deviation.

### 4.1.5 TEST SETUP

#### Frequency range 30MHz~1GHz

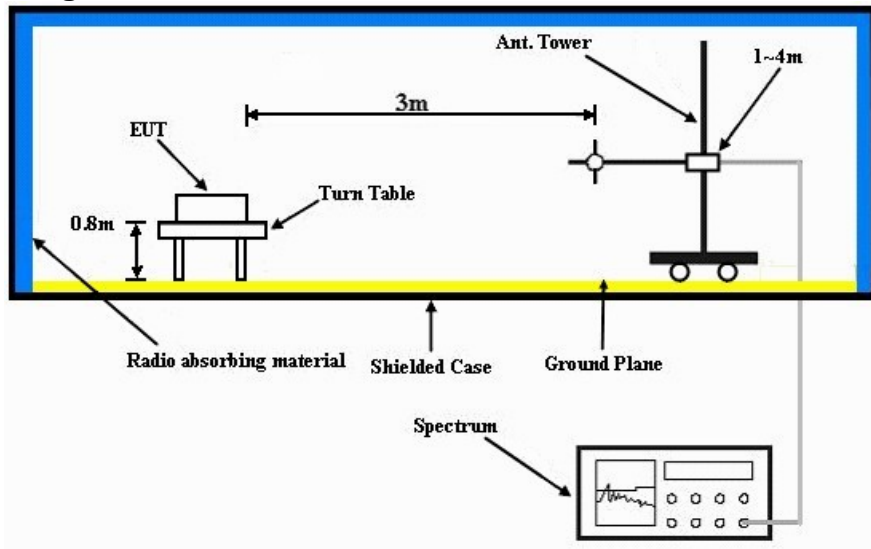

#### Frequency range above 1GHz

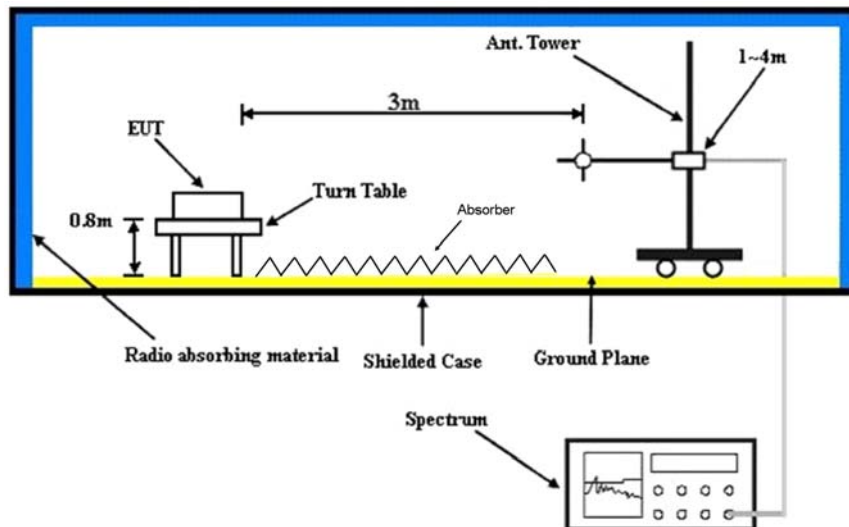

For the actual test configuration, please refer to the attached file (Test Setup Photo).

#### 4.1.6 EUT OPERATING CONDITIONS

- a. Placed the EUT on the testing table.
- b. Prepared notebook to act as communication partner and placed it outside of testing area.
- c. The communication partner connected with EUT via a USB cable and ran a test program (provided by manufacturer) to enable EUT under transmission condition continuously at specific channel frequency.
- d. The communication partner sent data to EUT by command "PING".
- e. The necessary accessories enable the system in full functions.



#### 4.1.7 TEST RESULTS

#### ABOVE 1GHz DATA :

#### BT\_GFSK

<b>CHANNEL</b>	TX Channel 0	<b>DETECTOR FUNCTION</b>	Peak (PK) Average (AV)
<b>FREQUENCY RANGE</b>	1GHz ~ 25GHz		

ANTENNA POLARITY & TEST DISTANCE: HORIZONTAL AT 3 M								
NO.	FREQ. (MHz)	EMISSION LEVEL (dBuV/m)	LIMIT (dBuV/m)	MARGIN (dB)	ANTENNA HEIGHT (m)	TABLE ANGLE (Degree)	RAW VALUE (dBuV)	CORRECTION FACTOR (dB/m)
1	2390.00	49.9 PK	74.0	-24.1	1.00 H	216	54.90	-5.00
2	2390.00	37.1 AV	54.0	-16.9	1.00 H	216	42.10	-5.00
3	#2400.00	42.6 PK	79.5	-36.9	1.13 H	217	47.60	-5.00
4	#2400.00	12.5 AV	49.4	-36.9	1.13 H	217	17.50	-5.00
5	*2402.00	99.5 PK			1.14 H	217	66.50	33.00
6	*2402.00	69.4 AV			1.14 H	217	36.40	33.00
7	4804.00	45.9 PK	74.0	-28.1	1.00 H	1	44.50	1.40
8	4804.00	32.9 AV	54.0	-21.1	1.00 H	1	31.50	1.40
ANTENNA POLARITY & TEST DISTANCE: VERTICAL AT 3 M								
NO.	FREQ. (MHz)	EMISSION LEVEL (dBuV/m)	LIMIT (dBuV/m)	MARGIN (dB)	ANTENNA HEIGHT (m)	TABLE ANGLE (Degree)	RAW VALUE (dBuV)	CORRECTION FACTOR (dB/m)
1	2390.00	51.0 PK	74.0	-23.0	1.00 V	79	56.00	-5.00
2	2390.00	37.5 AV	54.0	-16.5	1.00 V	79	42.50	-5.00
3	#2400.00	43.4 PK	78.1	-34.7	1.00 V	87	48.40	-5.00
4	#2400.00	13.3 AV	48.0	-34.7	1.00 V	87	18.30	-5.00
5	*2402.00	98.1 PK			1.00 V	87	65.10	33.00
6	*2402.00	68.0 AV			1.00 V	87	35.00	33.00
7	4804.00	46.4 PK	74.0	-27.6	1.02 V	14	45.00	1.40
8	4804.00	34.4 AV	54.0	-19.6	1.02 V	14	33.00	1.40

#### REMARKS:

1. Emission Level(dBuV/m) = Raw Value(dBuV) + Correction Factor(dB/m)
2. Correction Factor(dB/m) = Antenna Factor(dB/m) + Cable Factor(dB)
3. The other emission levels were very low against the limit.
4. Margin value = Emission Level – Limit value
5. " \* ": Fundamental frequency.
6. " # ": The radiated frequency is out of the restricted band.
7. The DH5 packet was the worst case duty cycle for a transmit dwell time on a channel, based upon bluetooth theory the transmitter is on 0.625 \* 5 per 296.25 ms per channel. Therefore, the duty cycle correlation factor be equal to:  $20\log(3.125 / 100) = -30.1 \text{ dB}$
8. Average value = peak reading +  $20\log(\text{duty cycle})$ .



A D T

<b>CHANNEL</b>	TX Channel 39	<b>DETECTOR FUNCTION</b>	Peak (PK) Average (AV)
<b>FREQUENCY RANGE</b>	1GHz ~ 25GHz		

ANTENNA POLARITY & TEST DISTANCE: HORIZONTAL AT 3 M								
NO.	FREQ. (MHz)	EMISSION LEVEL (dBuV/m)	LIMIT (dBuV/m)	MARGIN (dB)	ANTENNA HEIGHT (m)	TABLE ANGLE (Degree)	RAW VALUE (dBuV)	CORRECTION FACTOR (dB/m)
1	*2441.00	104.6 PK			1.30 H	138	71.30	33.30
2	*2441.00	74.5 AV			1.30 H	138	41.20	33.30
3	4882.00	46.3 PK	74.0	-27.7	1.00 H	360	44.80	1.50
4	4882.00	32.2 AV	54.0	-21.8	1.00 H	360	30.70	1.50
ANTENNA POLARITY & TEST DISTANCE: VERTICAL AT 3 M								
NO.	FREQ. (MHz)	EMISSION LEVEL (dBuV/m)	LIMIT (dBuV/m)	MARGIN (dB)	ANTENNA HEIGHT (m)	TABLE ANGLE (Degree)	RAW VALUE (dBuV)	CORRECTION FACTOR (dB/m)
1	*2441.00	96.8 PK			1.00 V	20	63.50	33.30
2	*2441.00	66.7 AV			1.00 V	20	33.40	33.30
3	4882.00	45.9 PK	74.0	-28.1	1.00 V	28	44.40	1.50
4	4882.00	34.2 AV	54.0	-19.8	1.00 V	28	32.70	1.50

**REMARKS:**

1. Emission Level(dBuV/m) = Raw Value(dBuV) + Correction Factor(dB/m)
2. Correction Factor(dB/m) = Antenna Factor(dB/m) + Cable Factor(dB)
3. The other emission levels were very low against the limit.
4. Margin value = Emission Level – Limit value
5. " \* ": Fundamental frequency.
6. The DH5 packet was the worst case duty cycle for a transmit dwell time on a channel, based upon bluetooth theory the transmitter is on 0.625 \* 5 per 296.25 ms per channel. Therefore, the duty cycle correlation factor be equal to:  $20\log(3.125 / 100) = -30.1$  dB
7. Average value = peak reading +  $20\log(\text{duty cycle})$ .



A D T

<b>CHANNEL</b>	TX Channel 78	<b>DETECTOR FUNCTION</b>	Peak (PK) Average (AV)
<b>FREQUENCY RANGE</b>	1GHz ~ 25GHz		

ANTENNA POLARITY & TEST DISTANCE: HORIZONTAL AT 3 M								
NO.	FREQ. (MHz)	EMISSION LEVEL (dBuV/m)	LIMIT (dBuV/m)	MARGIN (dB)	ANTENNA HEIGHT (m)	TABLE ANGLE (Degree)	RAW VALUE (dBuV)	CORRECTION FACTOR (dB/m)
1	*2480.00	103.6 PK			1.28 H	140	70.20	33.40
2	*2480.00	73.5 AV			1.28 H	140	40.10	33.40
3	2483.50	43.9 PK	74.0	-30.1	1.28 H	139	48.60	-4.70
4	2483.50	13.8 AV	54.0	-40.2	1.28 H	139	18.50	-4.70
5	4960.00	45.5 PK	74.0	-28.5	1.00 H	79	43.80	1.70
6	4960.00	33.3 AV	54.0	-20.7	1.00 H	79	31.60	1.70
ANTENNA POLARITY & TEST DISTANCE: VERTICAL AT 3 M								
NO.	FREQ. (MHz)	EMISSION LEVEL (dBuV/m)	LIMIT (dBuV/m)	MARGIN (dB)	ANTENNA HEIGHT (m)	TABLE ANGLE (Degree)	RAW VALUE (dBuV)	CORRECTION FACTOR (dB/m)
1	*2480.00	98.7 PK			1.00 V	19	65.30	33.40
2	*2480.00	68.6 AV			1.00 V	19	35.20	33.40
3	2483.50	45.1 PK	74.0	-28.9	1.00 V	20	49.80	-4.70
4	2483.50	15.0 AV	54.0	-39.0	1.00 V	20	19.70	-4.70
5	4960.00	46.1 PK	74.0	-27.9	1.00 V	27	44.40	1.70
6	4960.00	34.9 AV	54.0	-19.1	1.00 V	27	33.20	1.70

**REMARKS:**

1. Emission Level(dBuV/m) = Raw Value(dBuV) + Correction Factor(dB/m)
2. Correction Factor(dB/m) = Antenna Factor(dB/m) + Cable Factor(dB)
3. The other emission levels were very low against the limit.
4. Margin value = Emission Level – Limit value
5. " \* ": Fundamental frequency.
6. The DH5 packet was the worst case duty cycle for a transmit dwell time on a channel, based upon bluetooth theory the transmitter is on 0.625 \* 5 per 296.25 ms per channel. Therefore, the duty cycle correlation factor be equal to:  $20\log(3.125 / 100) = -30.1$  dB
7. Average value = peak reading +  $20\log(\text{duty cycle})$ .



A D T

**BT\_8DPSK**

<b>CHANNEL</b>	TX Channel 0	<b>DETECTOR FUNCTION</b>	Peak (PK) Average (AV)
<b>FREQUENCY RANGE</b>	1GHz ~ 25GHz		

**ANTENNA POLARITY & TEST DISTANCE: HORIZONTAL AT 3 M**

NO.	FREQ. (MHz)	EMISSION LEVEL (dBuV/m)	LIMIT (dBuV/m)	MARGIN (dB)	ANTENNA HEIGHT (m)	TABLE ANGLE (Degree)	RAW VALUE (dBuV)	CORRECTION FACTOR (dB/m)
1	2390.00	49.5 PK	74.0	-24.5	1.54 H	206	50.40	-0.90
2	2390.00	37.6 AV	54.0	-16.4	1.54 H	206	38.50	-0.90
3	#2400.00	44.4 PK	79.3	-34.9	2.00 H	217	45.30	-0.90
4	#2400.00	14.3 AV	49.2	-34.9	2.00 H	217	15.20	-0.90
5	*2402.00	99.3 PK			2.00 H	217	66.00	33.30
6	*2402.00	69.2 AV			2.00 H	217	35.90	33.30
7	4804.00	47.0 PK	74.0	-27.0	1.07 H	76	41.00	6.00
8	4804.00	16.9 AV	54.0	-37.1	1.07 H	76	10.90	6.00

**ANTENNA POLARITY & TEST DISTANCE: VERTICAL AT 3 M**

NO.	FREQ. (MHz)	EMISSION LEVEL (dBuV/m)	LIMIT (dBuV/m)	MARGIN (dB)	ANTENNA HEIGHT (m)	TABLE ANGLE (Degree)	RAW VALUE (dBuV)	CORRECTION FACTOR (dB/m)
1	2390.00	50.0 PK	74.0	-24.0	1.18 V	124	50.90	-0.90
2	2390.00	37.0 AV	54.0	-17.0	1.18 V	124	37.90	-0.90
3	#2400.00	45.2 PK	74.9	-29.7	1.49 V	235	46.10	-0.90
4	#2400.00	15.1 AV	44.8	-29.7	1.49 V	235	16.00	-0.90
5	*2402.00	94.9 PK			1.49 V	235	61.60	33.30
6	*2402.00	64.8 AV			1.49 V	235	31.50	33.30
7	4804.00	46.9 PK	74.0	-27.1	1.39 V	132	40.90	6.00
8	4804.00	16.8 AV	54.0	-37.2	1.39 V	132	10.80	6.00

**REMARKS:**

1. Emission Level(dBuV/m) = Raw Value(dBuV) + Correction Factor(dB/m)
2. Correction Factor(dB/m) = Antenna Factor(dB/m) + Cable Factor(dB)
3. The other emission levels were very low against the limit.
4. Margin value = Emission Level – Limit value
5. " \* ": Fundamental frequency.
6. " # ": The radiated frequency is out of the restricted band.
7. The DH5 packet was the worst case duty cycle for a transmit dwell time on a channel, based upon bluetooth theory the transmitter is on 0.625 \* 5 per 296.25 ms per channel. Therefore, the duty cycle correlation factor be equal to:  $20\log(3.125 / 100) = -30.1 \text{ dB}$
8. Average value = peak reading +  $20\log(\text{duty cycle})$ .



A D T

<b>CHANNEL</b>	TX Channel 39	<b>DETECTOR FUNCTION</b>	Peak (PK) Average (AV)
<b>FREQUENCY RANGE</b>	1GHz ~ 25GHz		

ANTENNA POLARITY & TEST DISTANCE: HORIZONTAL AT 3 M								
NO.	FREQ. (MHz)	EMISSION LEVEL (dBuV/m)	LIMIT (dBuV/m)	MARGIN (dB)	ANTENNA HEIGHT (m)	TABLE ANGLE (Degree)	RAW VALUE (dBuV)	CORRECTION FACTOR (dB/m)
1	*2441.00	99.2 PK			1.18 H	293	65.80	33.40
2	*2441.00	69.1 AV			1.18 H	293	35.70	33.40
3	4882.00	47.7 PK	74.0	-26.3	1.10 H	324	41.60	6.10
4	4882.00	17.6 AV	54.0	-36.4	1.10 H	324	11.50	6.10
5	7323.00	53.0 PK	74.0	-21.0	1.03 H	244	40.80	12.20
6	7323.00	22.9 AV	54.0	-31.1	1.03 H	244	10.70	12.20
ANTENNA POLARITY & TEST DISTANCE: VERTICAL AT 3 M								
NO.	FREQ. (MHz)	EMISSION LEVEL (dBuV/m)	LIMIT (dBuV/m)	MARGIN (dB)	ANTENNA HEIGHT (m)	TABLE ANGLE (Degree)	RAW VALUE (dBuV)	CORRECTION FACTOR (dB/m)
1	*2441.00	96.8 PK			1.48 V	304	63.40	33.40
2	*2441.00	66.7 AV			1.48 V	304	33.30	33.40
3	4882.00	46.8 PK	74.0	-27.2	1.17 V	267	40.70	6.10
4	4882.00	16.7 AV	54.0	-37.3	1.17 V	267	10.60	6.10
5	7323.00	52.4 PK	74.0	-21.6	1.05 V	85	40.20	12.20
6	7323.00	22.3 AV	54.0	-31.7	1.05 V	85	10.10	12.20

**REMARKS:**

1. Emission Level(dBuV/m) = Raw Value(dBuV) + Correction Factor(dB/m)
2. Correction Factor(dB/m) = Antenna Factor(dB/m) + Cable Factor(dB)
3. The other emission levels were very low against the limit.
4. Margin value = Emission Level – Limit value
5. " \* ": Fundamental frequency.
6. The DH5 packet was the worst case duty cycle for a transmit dwell time on a channel, based upon bluetooth theory the transmitter is on 0.625 \* 5 per 296.25 ms per channel. Therefore, the duty cycle correlation factor be equal to:  $20\log(3.125 / 100) = -30.1 \text{ dB}$
7. Average value = peak reading +  $20\log(\text{duty cycle})$ .



A D T

<b>CHANNEL</b>	TX Channel 78	<b>DETECTOR FUNCTION</b>	Peak (PK) Average (AV)
<b>FREQUENCY RANGE</b>	1GHz ~ 25GHz		

**ANTENNA POLARITY & TEST DISTANCE: HORIZONTAL AT 3 M**

NO.	FREQ. (MHz)	EMISSION LEVEL (dBuV/m)	LIMIT (dBuV/m)	MARGIN (dB)	ANTENNA HEIGHT (m)	TABLE ANGLE (Degree)	RAW VALUE (dBuV)	CORRECTION FACTOR (dB/m)
1	*2480.00	98.0 PK			1.89 H	293	64.60	33.40
2	*2480.00	67.9 AV			1.89 H	293	34.50	33.40
3	2483.50	44.6 PK	74.0	-29.4	1.89 H	293	45.40	-0.80
4	2483.50	14.5 AV	54.0	-39.5	1.89 H	293	15.30	-0.80
5	4960.00	48.2 PK	74.0	-25.8	1.18 H	94	41.80	6.40
6	4960.00	18.1 AV	54.0	-35.9	1.18 H	94	11.70	6.40

**ANTENNA POLARITY & TEST DISTANCE: VERTICAL AT 3 M**

NO.	FREQ. (MHz)	EMISSION LEVEL (dBuV/m)	LIMIT (dBuV/m)	MARGIN (dB)	ANTENNA HEIGHT (m)	TABLE ANGLE (Degree)	RAW VALUE (dBuV)	CORRECTION FACTOR (dB/m)
1	*2480.00	96.2 PK			1.45 V	302	62.80	33.40
2	*2480.00	66.1 AV			1.45 V	302	32.70	33.40
3	2483.50	44.6 PK	74.0	-29.4	1.45 V	302	45.40	-0.80
4	2483.50	14.5 AV	54.0	-39.5	1.45 V	302	15.30	-0.80
5	4960.00	47.4 PK	74.0	-26.6	1.26 V	354	41.00	6.40
6	4960.00	17.3 AV	54.0	-36.7	1.26 V	354	10.90	6.40

**REMARKS:**

1. Emission Level(dBuV/m) = Raw Value(dBuV) + Correction Factor(dB/m)
2. Correction Factor(dB/m) = Antenna Factor(dB/m) + Cable Factor(dB)
3. The other emission levels were very low against the limit.
4. Margin value = Emission Level – Limit value
5. " \* ": Fundamental frequency.
6. The DH5 packet was the worst case duty cycle for a transmit dwell time on a channel, based upon bluetooth theory the transmitter is on 0.625 \* 5 per 296.25 ms per channel. Therefore, the duty cycle correlation factor be equal to:  $20\log(3.125 / 100) = -30.1 \text{ dB}$
7. Average value = peak reading +  $20\log(\text{duty cycle})$ .



A D T

## BELOW 1GHz WORST-CASE DATA

### BT\_GFSK

<b>CHANNEL</b>	TX Channel 39	<b>DETECTOR FUNCTION</b>	Quasi-Peak (QP)
<b>FREQUENCY RANGE</b>	30MHz ~ 1GHz		
<b>TEST MODE</b>	A		

ANTENNA POLARITY & TEST DISTANCE: HORIZONTAL AT 3 M								
NO.	FREQ. (MHz)	EMISSION LEVEL (dBuV/m)	LIMIT (dBuV/m)	MARGIN (dB)	ANTENNA HEIGHT (m)	TABLE ANGLE (Degree)	RAW VALUE (dBuV)	CORRECTION FACTOR (dB/m)
1	30.10	25.4 QP	40.0	-14.6	1.49 H	85	41.40	-16.00
2	51.70	23.1 QP	40.0	-16.9	1.00 H	85	37.00	-13.90
3	78.50	27.1 QP	40.0	-12.9	1.99 H	194	45.60	-18.50
4	151.50	25.4 QP	43.5	-18.1	1.99 H	25	39.10	-13.70
5	665.80	32.4 QP	46.0	-13.6	1.49 H	84	37.70	-5.30
6	994.00	31.2 QP	54.0	-22.8	1.01 H	225	31.00	0.20

ANTENNA POLARITY & TEST DISTANCE: VERTICAL AT 3 M								
NO.	FREQ. (MHz)	EMISSION LEVEL (dBuV/m)	LIMIT (dBuV/m)	MARGIN (dB)	ANTENNA HEIGHT (m)	TABLE ANGLE (Degree)	RAW VALUE (dBuV)	CORRECTION FACTOR (dB/m)
1	33.30	34.5 QP	40.0	-5.5	1.49 V	45	50.60	-16.10
2	52.00	32.1 QP	40.0	-7.9	1.24 V	241	46.00	-13.90
3	78.60	27.0 QP	40.0	-13.0	1.99 V	41	45.50	-18.50
4	153.00	25.1 QP	43.5	-18.4	1.49 V	199	38.80	-13.70
5	888.50	29.5 QP	46.0	-16.5	1.00 V	241	31.10	-1.60
6	992.40	30.8 QP	54.0	-23.2	1.24 V	74	30.60	0.20

### REMARKS:

1. Emission Level(dBuV/m) = Raw Value(dBuV) + Correction Factor(dB/m)
2. Correction Factor(dB/m) = Antenna Factor(dB/m) + Cable Factor(dB)
3. The other emission levels were very low against the limit.
4. Margin value = Emission Level – Limit value



A D T

<b>CHANNEL</b>	TX Channel 39	<b>DETECTOR FUNCTION</b>	Quasi-Peak (QP)
<b>FREQUENCY RANGE</b>	30MHz ~ 1GHz		
<b>TEST MODE</b>	B		

<b>ANTENNA POLARITY &amp; TEST DISTANCE: HORIZONTAL AT 3 M</b>								
NO.	FREQ. (MHz)	EMISSION LEVEL (dBuV/m)	LIMIT (dBuV/m)	MARGIN (dB)	ANTENNA HEIGHT (m)	TABLE ANGLE (Degree)	RAW VALUE (dBuV)	CORRECTION FACTOR (dB/m)
1	30.00	25.8 QP	40.0	-14.2	1.24 H	255	41.80	-16.00
2	51.70	23.6 QP	40.0	-16.4	1.49 H	24	37.50	-13.90
3	78.40	27.0 QP	40.0	-13.0	1.49 H	114	45.50	-18.50
4	151.20	25.9 QP	43.5	-17.6	1.99 H	24	39.60	-13.70
5	665.80	32.5 QP	46.0	-13.5	1.01 H	251	37.80	-5.30
6	994.00	31.8 QP	54.0	-22.2	1.01 H	196	31.60	0.20

<b>ANTENNA POLARITY &amp; TEST DISTANCE: VERTICAL AT 3 M</b>								
NO.	FREQ. (MHz)	EMISSION LEVEL (dBuV/m)	LIMIT (dBuV/m)	MARGIN (dB)	ANTENNA HEIGHT (m)	TABLE ANGLE (Degree)	RAW VALUE (dBuV)	CORRECTION FACTOR (dB/m)
1	33.30	35.4 QP	40.0	-4.6	1.24 V	41	51.50	-16.10
2	52.00	32.9 QP	40.0	-7.1	1.49 V	243	46.80	-13.90
3	78.40	27.2 QP	40.0	-12.8	1.49 V	225	45.70	-18.50
4	152.90	25.7 QP	43.5	-17.8	1.49 V	296	39.40	-13.70
5	888.50	29.9 QP	46.0	-16.1	1.49 V	205	31.50	-1.60
6	992.40	31.6 QP	54.0	-22.4	1.24 V	25	31.40	0.20

**REMARKS:**

1. Emission Level(dBuV/m) = Raw Value(dBuV) + Correction Factor(dB/m)
2. Correction Factor(dB/m) = Antenna Factor(dB/m) + Cable Factor(dB)
3. The other emission levels were very low against the limit.
4. Margin value = Emission Level – Limit value



## 4.2 CONDUCTED EMISSION MEASUREMENT

### 4.2.1 LIMITS OF CONDUCTED EMISSION MEASUREMENT

FREQUENCY OF EMISSION (MHz)	CONDUCTED LIMIT (dB $\mu$ V)	
	Quasi-peak	Average
0.15 ~ 0.5	66 to 56	56 to 46
0.5 ~ 5	56	46
5 ~ 30	60	50

- NOTE:**
1. The lower limit shall apply at the transition frequencies.
  2. The limit decreases in line with the logarithm of the frequency in the range of 0.15 to 0.50MHz.
  3. All emanations from a class A/B digital device or system, including any network of conductors and apparatus connected thereto, shall not exceed the level of field strengths specified above.

### 4.2.2 TEST INSTRUMENTS

DESCRIPTION & MANUFACTURER	MODEL NO.	SERIAL NO.	DATE OF CALIBRATION	DUE DATE OF CALIBRATION
Test Receiver ROHDE & SCHWARZ	ESCS30	100288	Apr. 24, 2014	Apr. 23, 2015
RF signal cable Woken	5D-FB	Cable-HYCO2-01	Dec. 27, 2013	Dec. 26, 2014
LISN ROHDE & SCHWARZ (EUT)	ESH2-Z5	100100	Dec. 23, 2013	Dec. 22, 2014
LISN ROHDE & SCHWARZ (Peripheral)	ESH3-Z5	100312	Jul. 10, 2014	Jul. 09, 2015
Software ADT	BV ADT_Cond_ V7.3.7.3	NA	NA	NA

- NOTE:**
1. The calibration interval of the above test instruments is 12 months and the calibrations are traceable to NML/ROC and NIST/USA.
  2. The test was performed in HwaYa Shielded Room 2.
  3. The VCCI Site Registration No. is C-2047.

#### 4.2.3 TEST PROCEDURES

- a. The EUT was placed 0.4 meters from the conducting wall of the shielded room with EUT being connected to the power mains through a line impedance stabilization network (LISN). Other support units were connected to the power mains through another LISN. The two LISNs provide 50 ohm/ 50uH of coupling impedance for the measuring instrument.
- b. Both lines of the power mains connected to the EUT were checked for maximum conducted interference.
- c. The frequency range from 150kHz to 30MHz was searched. Emission levels under (Limit - 20dB) was not recorded.

**NOTE:** All modes of operation were investigated and the worst-case emissions are reported.

#### 4.2.4 DEVIATION FROM TEST STANDARD

No deviation.

#### 4.2.5 TEST SETUP

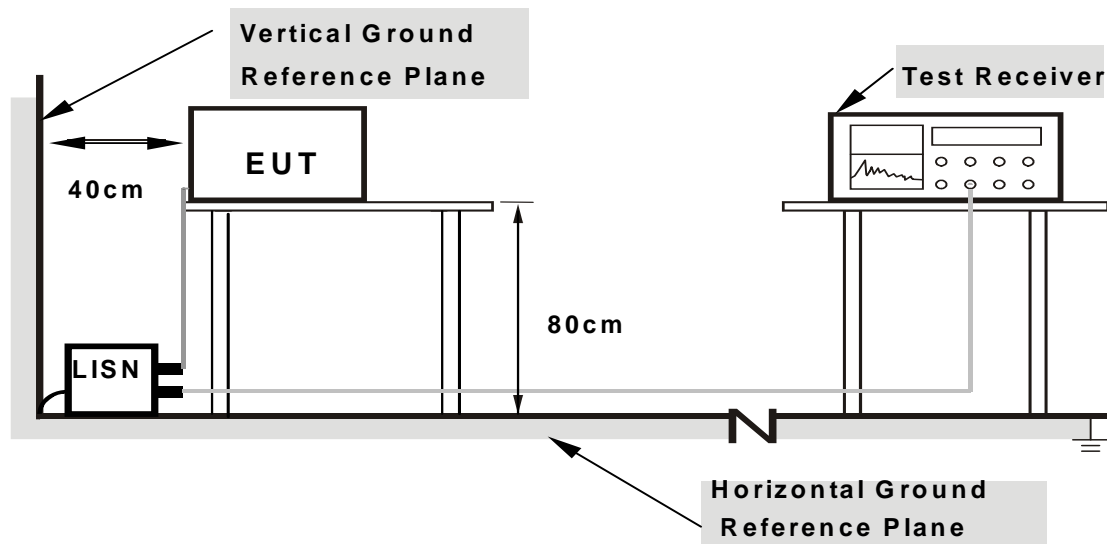

- Note:**
1. Support units were connected to second LISN.
  2. Both of LISNs (AMN) are 80 cm from EUT and at least 80 from other units and other metal planes

For the actual test configuration, please refer to the attached file (Test Setup Photo).

#### 4.2.6 EUT OPERATING CONDITIONS

Set the EUT under transmission condition continuously at specific channel frequency.



A D T

## 4.2.7 TEST RESULTS

### CONDUCTED WORST-CASE DATA : GFSK

PHASE	Line 1	6dB BANDWIDTH	9kHz
TEST MODE	A		

No	Freq. [MHz]	Corr. Factor (dB)	Reading Value		Emission Level		Limit		Margin	
			[dB (uV)]		[dB (uV)]		[dB (uV)]		(dB)	
			Q.P.	AV.	Q.P.	AV.	Q.P.	AV.	Q.P.	AV.
1	0.16953	0.27	49.51	38.46	49.78	38.73	64.98	54.98	-15.20	-16.25
2	0.31797	0.29	40.94	32.45	41.23	32.74	59.76	49.76	-18.53	-17.02
3	0.96641	0.34	41.84	33.96	42.18	34.30	56.00	46.00	-13.82	-11.70
4	<b>1.61719</b>	<b>0.35</b>	<b>45.54</b>	<b>36.56</b>	<b>45.89</b>	<b>36.91</b>	<b>56.00</b>	<b>46.00</b>	<b>-10.11</b>	<b>-9.09</b>
5	3.35156	0.41	43.43	34.67	43.84	35.08	56.00	46.00	-12.16	-10.92
6	15.95901	0.54	40.75	32.71	41.29	33.25	60.00	50.00	-18.71	-16.75

#### REMARKS:

1. Q.P. and AV. are abbreviations of quasi-peak and average individually.
2. The emission levels of other frequencies were very low against the limit.
3. Margin value = Emission level - Limit value
4. Correction factor = Insertion loss + Cable loss
5. Emission Level = Correction Factor + Reading Value.

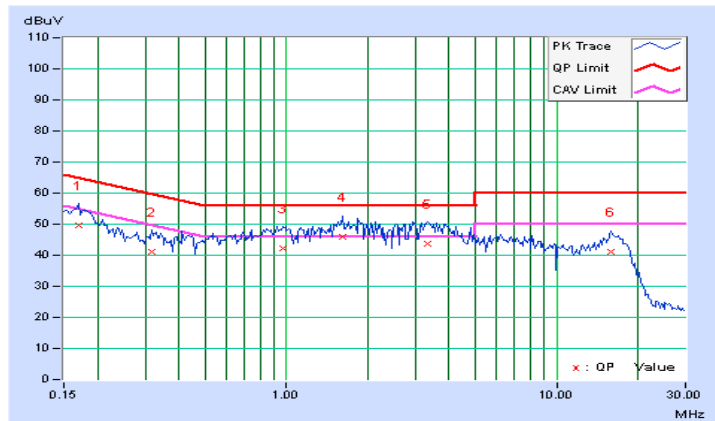



A D T

PHASE	Line 2	6dB BANDWIDTH	9kHz
TEST MODE	A		

No	Freq. [MHz]	Corr. Factor (dB)	Reading Value		Emission Level		Limit		Margin	
			[dB (uV)]		[dB (uV)]		[dB (uV)]		(dB)	
			Q.P.	AV.	Q.P.	AV.	Q.P.	AV.	Q.P.	AV.
1	0.16562	0.27	45.56	31.99	45.83	32.26	65.18	55.18	-19.35	-22.92
2	0.18906	0.28	41.14	29.41	41.42	29.69	64.08	54.08	-22.66	-24.39
3	1.31250	0.35	39.84	32.74	40.19	33.09	56.00	46.00	-15.81	-12.91
4	1.59375	0.36	40.56	33.31	40.92	33.67	56.00	46.00	-15.08	-12.33
5	2.76563	0.40	41.63	34.37	42.03	34.77	56.00	46.00	-13.97	-11.23
6	16.46484	0.59	39.45	30.16	40.04	30.75	60.00	50.00	-19.96	-19.25

**REMARKS:**

1. Q.P. and AV. are abbreviations of quasi-peak and average individually.
2. The emission levels of other frequencies were very low against the limit.
3. Margin value = Emission level - Limit value
4. Correction factor = Insertion loss + Cable loss
5. Emission Level = Correction Factor + Reading Value.

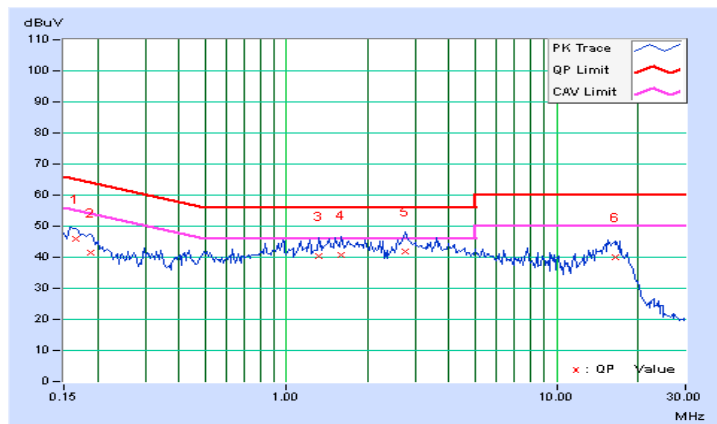

<b>PHASE</b>	Line 1	<b>6dB BANDWIDTH</b>	9kHz
<b>TEST MODE</b>	B		

No	Freq. [MHz]	Corr. Factor (dB)	Reading Value		Emission Level		Limit		Margin	
			[dB (uV)]		[dB (uV)]		[dB (uV)]		(dB)	
			Q.P.	AV.	Q.P.	AV.	Q.P.	AV.	Q.P.	AV.
1	0.15391	0.27	53.28	42.23	53.55	42.50	65.79	55.79	-12.24	-13.29
2	0.18516	0.28	50.99	39.02	51.27	39.30	64.25	54.25	-12.99	-14.96
3	0.65781	0.32	39.16	31.10	39.48	31.42	56.00	46.00	-16.52	-14.58
4	2.17188	0.37	31.89	22.74	32.26	23.11	56.00	46.00	-23.74	-22.89
5	4.10938	0.43	31.02	20.93	31.45	21.36	56.00	46.00	-24.55	-24.64
6	14.93750	0.53	37.17	29.88	37.70	30.41	60.00	50.00	-22.30	-19.59

**REMARKS:**

1. Q.P. and AV. are abbreviations of quasi-peak and average individually.
2. The emission levels of other frequencies were very low against the limit.
3. Margin value = Emission level - Limit value
4. Correction factor = Insertion loss + Cable loss
5. Emission Level = Correction Factor + Reading Value.

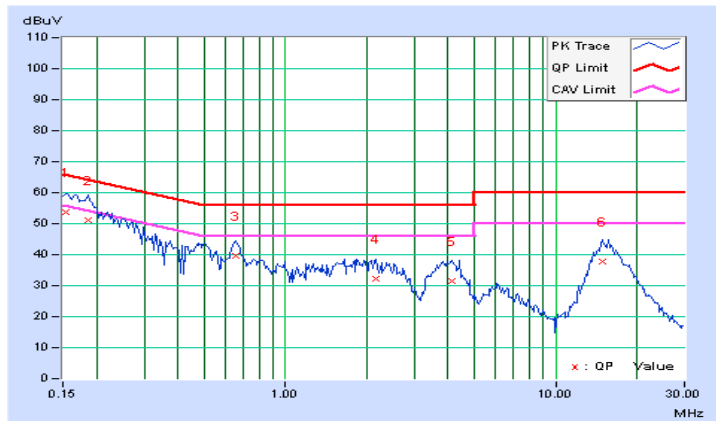



A D T

PHASE	Line 2	6dB BANDWIDTH	9kHz
TEST MODE	B		

No	Freq. [MHz]	Corr. Factor (dB)	Reading Value		Emission Level		Limit		Margin	
			[dB (uV)]		[dB (uV)]		[dB (uV)]		(dB)	
			Q.P.	AV.	Q.P.	AV.	Q.P.	AV.	Q.P.	AV.
1	0.16953	0.27	48.83	36.51	49.10	36.78	64.98	54.98	-15.88	-18.20
2	0.18906	0.28	45.80	34.91	46.08	35.19	64.08	54.08	-18.00	-18.89
3	0.59531	0.31	36.74	24.94	37.05	25.25	56.00	46.00	-18.95	-20.75
4	2.20703	0.38	31.02	21.47	31.40	21.85	56.00	46.00	-24.60	-24.15
5	3.85938	0.44	29.75	21.05	30.19	21.49	56.00	46.00	-25.81	-24.51
6	15.55859	0.57	34.24	26.60	34.81	27.17	60.00	50.00	-25.19	-22.83

**REMARKS:**

1. Q.P. and AV. are abbreviations of quasi-peak and average individually.
2. The emission levels of other frequencies were very low against the limit.
3. Margin value = Emission level - Limit value
4. Correction factor = Insertion loss + Cable loss
5. Emission Level = Correction Factor + Reading Value.

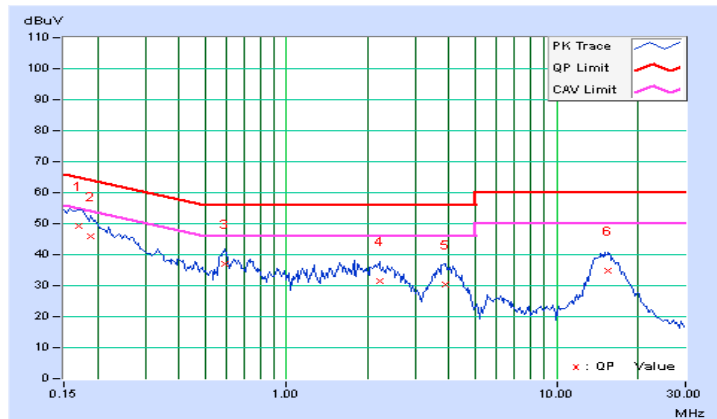

### 4.3 NUMBER OF HOPPING FREQUENCY USED

#### 4.3.1 LIMIT OF HOPPING FREQUENCY USED

At least 15 channels frequencies, and should be equally spaced.

#### 4.3.2 TEST SETUP

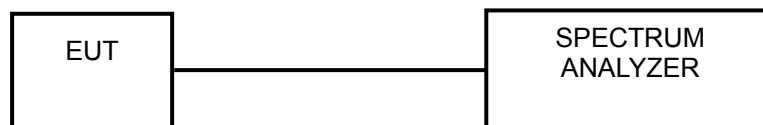

#### 4.3.3 TEST INSTRUMENTS

Refer to section 4.1.2 to get information of above instrument.

#### 4.3.4 TEST PROCEDURES

- a. Check the calibration of the measuring instrument (SA) using either an internal calibrator or a known signal from an external generator.
- b. Turn on the EUT and connect its antenna terminal to measurement via a low loss cable. Then set it to any one measured frequency within its operating range and make sure the instrument is operated in its linear range.
- c. Set the SA on MaxHold Mode, and then keep the EUT in hopping mode. Record all the signals from each channel until each one has been recorded.
- d. Set the SA on View mode and then plot the result on SA screen.
- e. Repeat above procedures until all frequencies measured were complete.

#### 4.3.5 DEVIATION FROM TEST STANDARD

No deviation.

#### 4.3.6 TEST RESULTS

There are 79 hopping frequencies in the hopping mode. Please refer to next page for the test result. On the plots, it shows that the hopping frequencies are equally spaced.





A D T

### GFSK

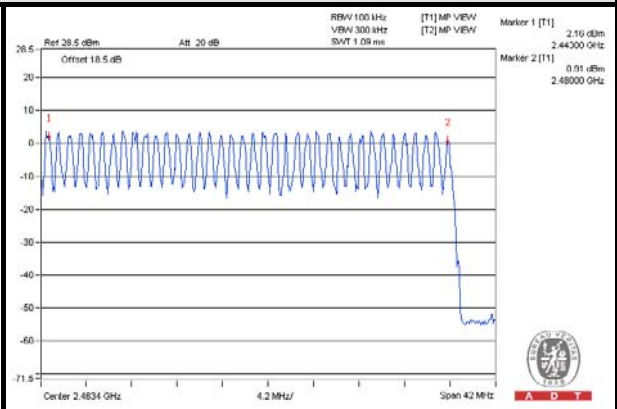
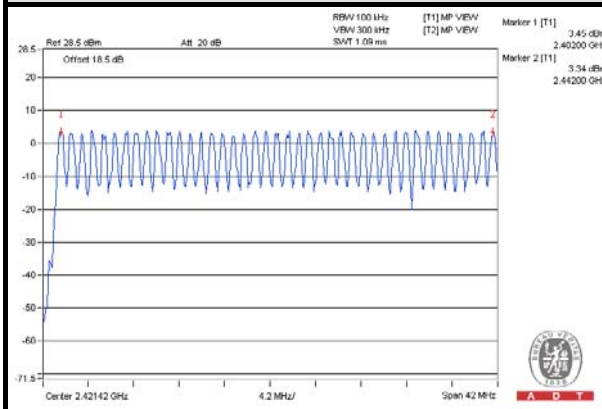

### 8DPSK

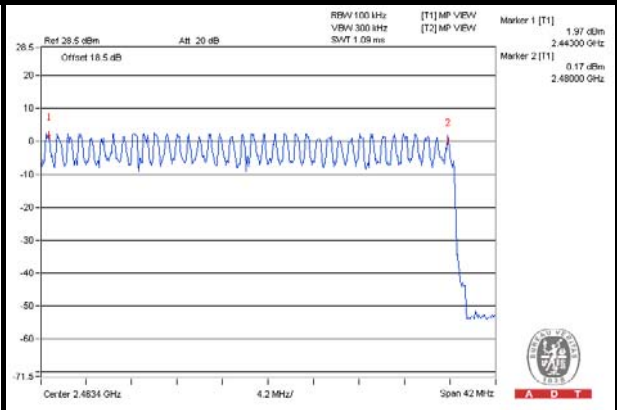
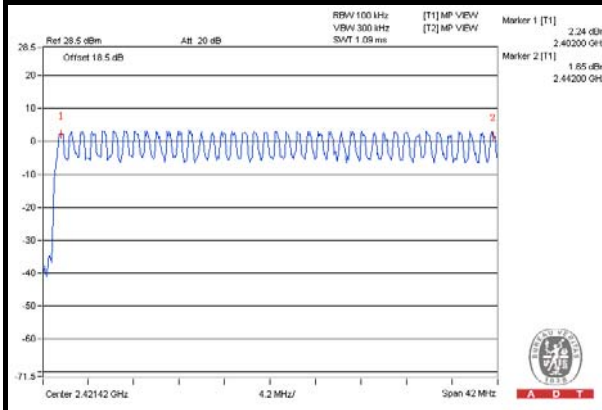

## 4.4 DWELL TIME ON EACH CHANNEL

### 4.4.1 LIMIT OF DWELL TIME USED

The average time of occupancy on any channel shall not be greater than 0.4 seconds within a period of 0.4 seconds multiplied by the number of hopping channels employed.

### 4.4.2 TEST SETUP

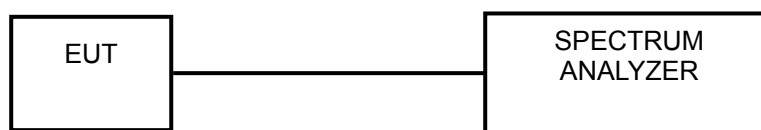

### 4.4.3 TEST INSTRUMENTS

Refer to section 4.1.2 to get information of above instrument.

### 4.4.4 TEST PROCEDURES

- a. Check the calibration of the measuring instrument (SA) using either an internal calibrator or a known signal from an external generator.
- b. Turn on the EUT and connect its antenna terminal to measurement via a low loss cable. Then set it to any one measured frequency within its operating range and make sure the instrument is operated in its linear range.
- c. Adjust the center frequency of SA on any frequency be measured and set SA to zero span mode. And then, set RBW and VBW of spectrum analyzer to proper value.
- d. Measure the time duration of one transmission on the measured frequency. And then plot the result with time difference of this time duration.
- e. Repeat above procedures until all different time-slot modes have been completed.

### 4.4.5 DEVIATION FROM TEST STANDARD

No deviation.

#### 4.4.6 TEST RESULTS

##### GFSK

Mode	Number of transmission in a 31.6 (79Hopping*0.4)	Length of transmission time (msec)	Result (msec)	Limit (msec)
DH1	50 (times / 5 sec) * 6.32 = 316.00 times	0.438	138.408	400
DH3	27 (times / 5 sec) * 6.32 = 170.64 times	1.740	296.914	400
DH5	17 (times / 5 sec) * 6.32 = 107.44 times	2.950	316.948	400

**NOTE:** Test plots of the transmitting time slot are shown on next page.



A D T

### DH1

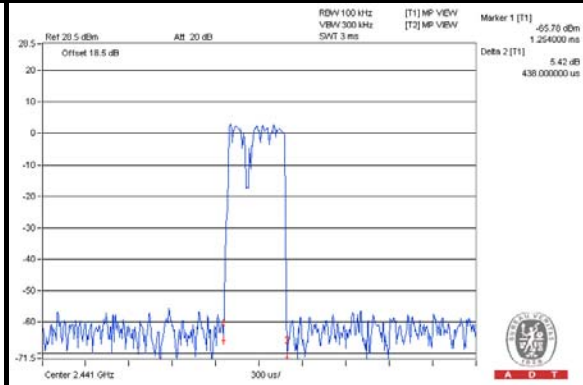
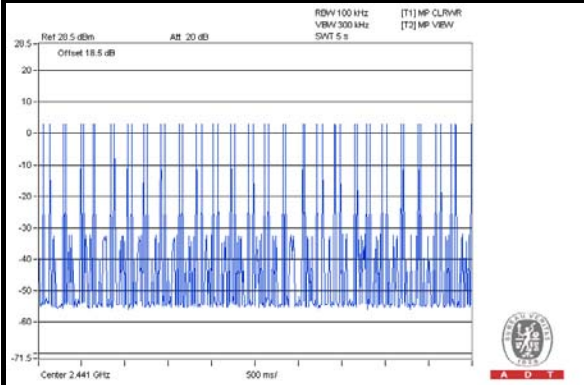

### DH3

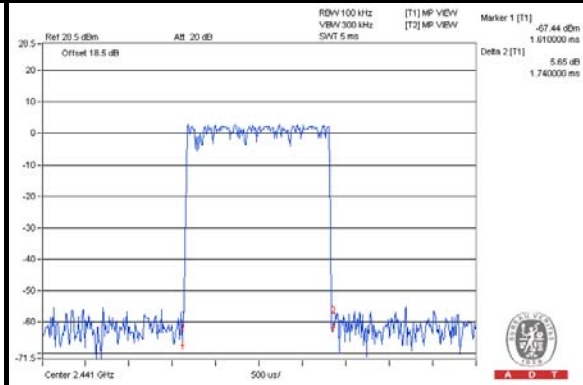
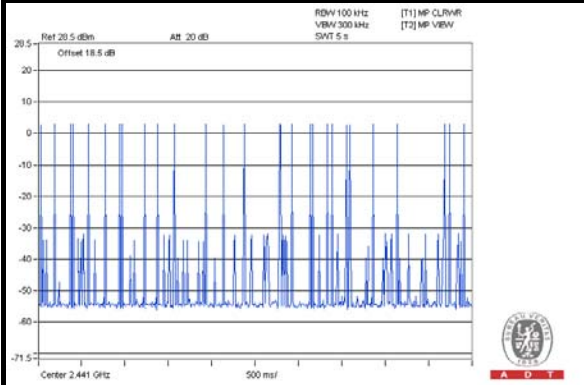

### DH5

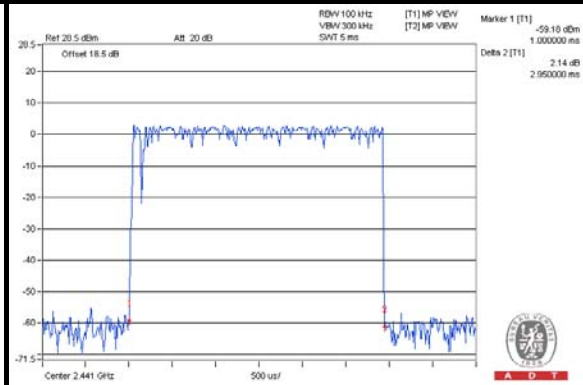
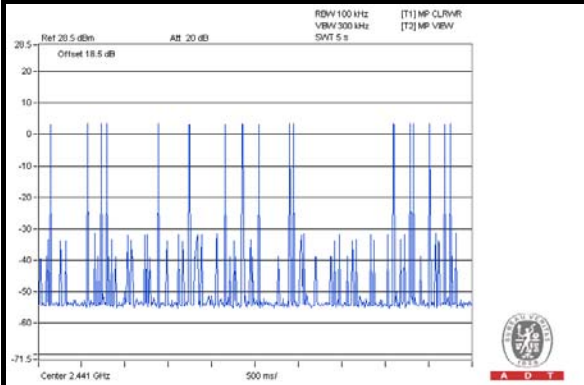



A D T

### 8DPSK

Mode	Number of transmission in a 31.6 (79Hopping*0.4)	Length of transmission time (msec)	Result (msec)	Limit (msec)
DH1	$50 \text{ (times / 5 sec)} * 6.32 = 316.00 \text{ times}$	0.468	147.888	400
DH3	$25 \text{ (times / 5 sec)} * 6.32 = 158.00 \text{ times}$	1.730	273.340	400
DH5	$18 \text{ (times / 5 sec)} * 6.32 = 113.76 \text{ times}$	2.976	338.550	400

**NOTE:** Test plots of the transmitting time slot are shown on next page.



A D T

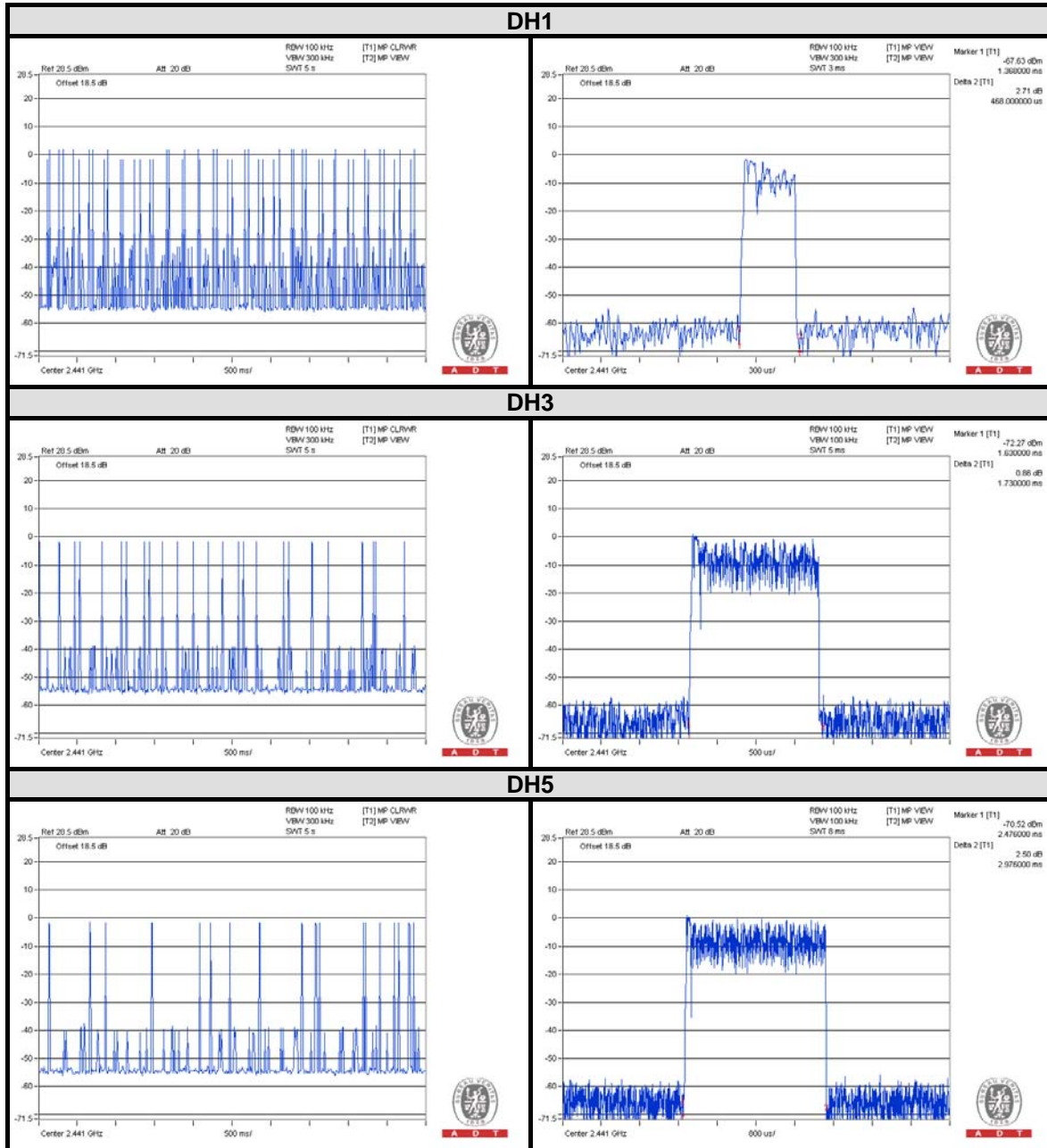

## 4.5 CHANNEL BANDWIDTH

### 4.5.1 LIMITS OF CHANNEL BANDWIDTH

For frequency hopping system operating in the 2400-2483.5MHz, If the 20dB bandwidth of hopping channel is greater than 25kHz, two-thirds 20dB bandwidth of hopping channel shall be a minimum limit for the hopping channel separation.

### 4.5.2 TEST SETUP

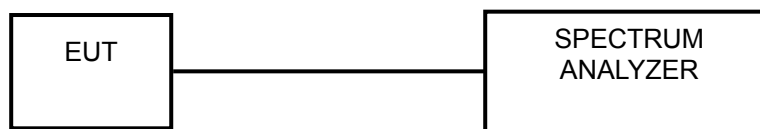

### 4.5.3 TEST INSTRUMENTS

Refer to section 4.1.2 to get information of above instrument.

### 4.5.4 TEST PROCEDURE

- Check the calibration of the measuring instrument using either an internal calibrator or a known signal from an external generator.
- Turn on the EUT and connect it to measurement instrument. Then set it to any one convenient frequency within its operating range. Set a reference level on the measuring instrument equal to the highest peak value.
- Measure the frequency difference of two frequencies that were attenuated 20dB from the reference level. Record the frequency difference as the emission bandwidth.
- Repeat above procedures until all frequencies measured were complete.

### 4.5.5 DEVIATION FROM TEST STANDARD

No deviation.

### 4.5.6 EUT OPERATING CONDITION

The software provided by client enabled the EUT to transmit and receive data at lowest, middle and highest channel frequencies individually.



A D T

### 4.5.7 TEST RESULTS

CHANNEL	FREQUENCY (MHz)	20dB BANDWIDTH (MHz)	
		GFSK	8DPSK
0	2402	0.890	1.31
39	2441	0.998	1.31
78	2480	1.000	1.30

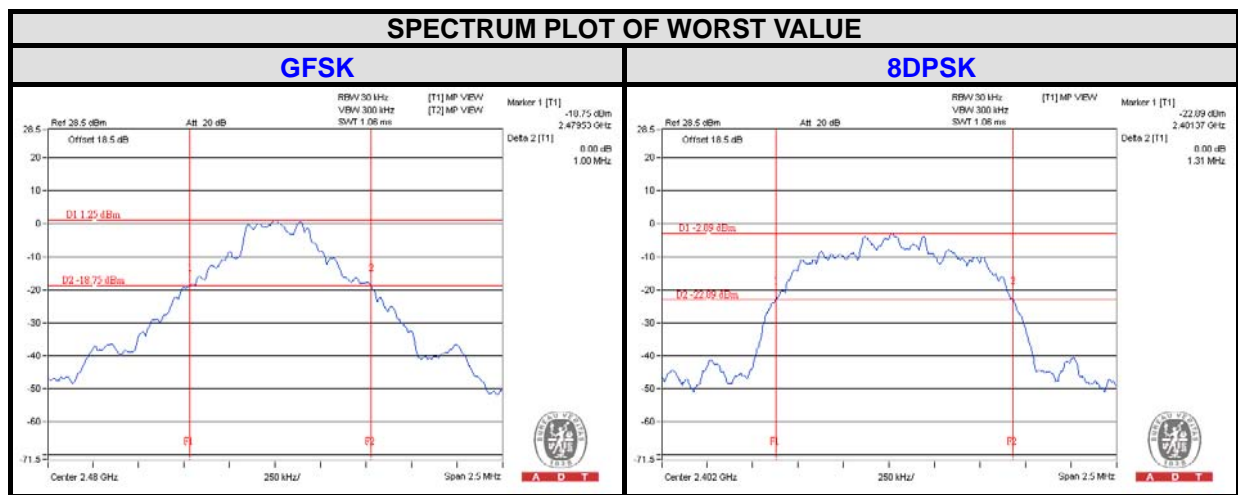



## 4.6 HOPPING CHANNEL SEPARATION

### 4.6.1 LIMIT OF HOPPING CHANNEL SEPARATION

At least 25kHz or two-third of 20dB hopping channel bandwidth (whichever is greater).

### 4.6.2 TEST SETUP

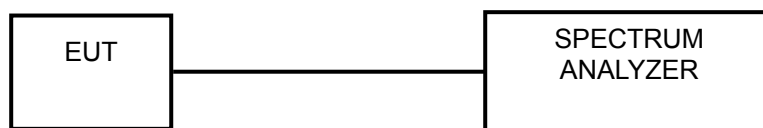

### 4.6.3 TEST INSTRUMENTS

Refer to section 4.1.2 to get information of above instrument.

### 4.6.4 TEST PROCEDURES

- a. Check the calibration of the measuring instrument using either an internal calibrator or a known signal from an external generator.
- b. Turn on the EUT and connect it to measurement instrument. Then set it to any one convenient frequency within its operating range.
- c. By using the MaxHold function record the separation of two adjacent channels.
- d. Measure the frequency difference of these two adjacent channels by SA MARK function. And then plot the result on SA screen.
- e. Repeat above procedures until all frequencies measured were complete.

### 4.6.5 DEVIATION FROM TEST STANDARD

No deviation.



A D T

### 4.6.6 TEST RESULTS

CHANNEL	FREQUENCY (MHz)	ADJACENT CHANNEL SEPARATION (MHz)		20dB BANDWIDTH (MHz)		MINIMUM LIMIT (MHz)		PASS / FAIL
		GFSK	8DPSK	GFSK	8DPSK	GFSK	8DPSK	
0	2402	1.00	1.01	0.890	1.31	0.593	0.873	PASS
39	2441	1.00	1.00	0.998	1.31	0.665	0.873	PASS
78	2480	1.00	1.00	1.000	1.30	0.667	0.867	PASS

**NOTE:** The minimum limit is two-third 20dB bandwidth.

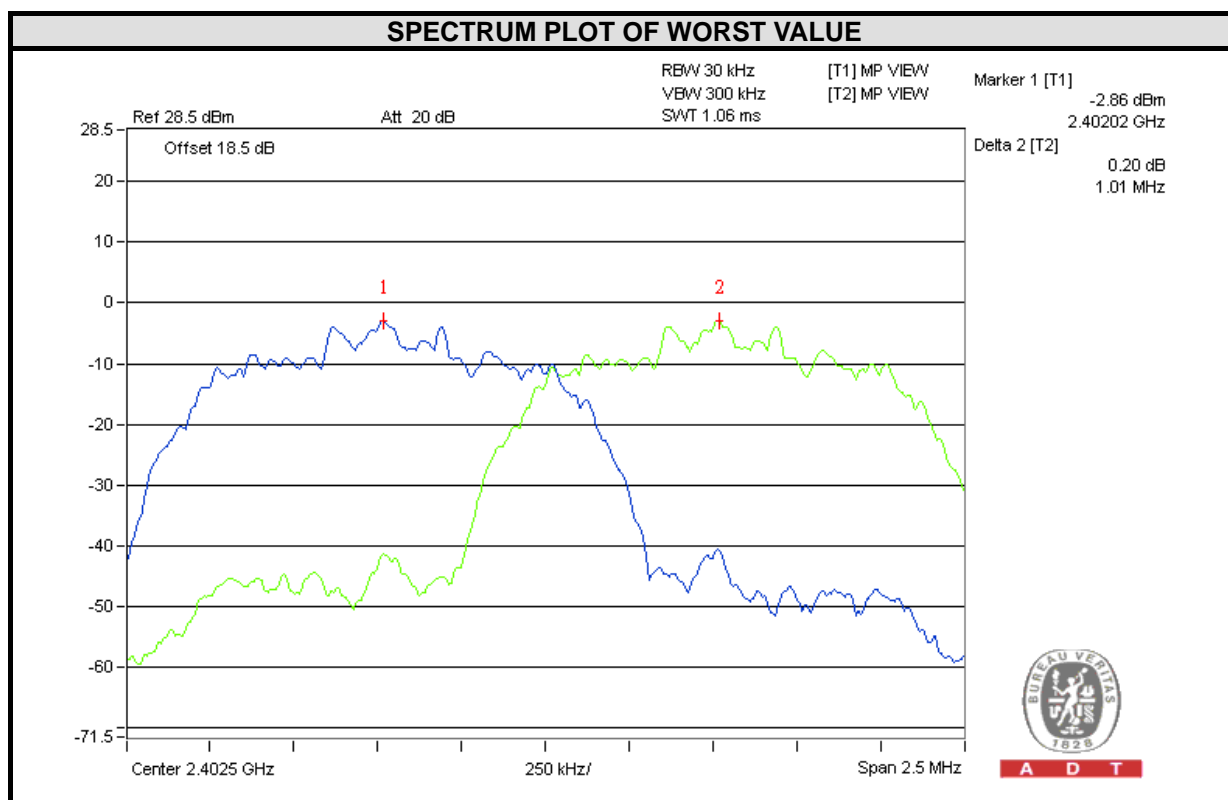

A D T

## 4.7 MAXIMUM OUTPUT POWER

### 4.7.1 LIMITS OF MAXIMUM OUTPUT POWER MEASUREMENT

The Maximum Output Power Measurement is 125mW.

### 4.7.2 TEST SETUP

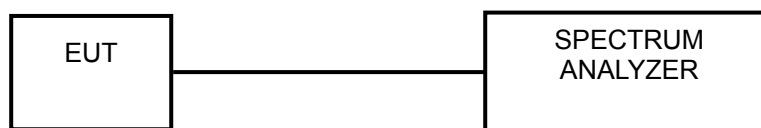

### 4.7.3 TEST INSTRUMENTS

Refer to section 4.1.2 to get information of above instrument.

### 4.7.4 TEST PROCEDURES

- a. Check the calibration of the measuring instrument using either an internal calibrator or a known signal from an external generator.
- b. Turn on the EUT and connect it to measurement instrument. Then set it to any one convenient frequency within its operating range. Set a reference level on the measuring instrument equal to the highest peak value.
- c. The center frequency of the spectrum analyzer is set to the fundamental frequency and using 3MHz RBW and 10 MHz VBW.
- d. Measure the captured power within the band and recording the plot.
- e. Repeat above procedures until all frequencies required were complete.

### 4.7.5 DEVIATION FROM TEST STANDARD

No deviation.

### 4.7.6 EUT OPERATING CONDITION

The software provided by client enabled the EUT to transmit and receive data at lowest, middle and highest channel frequencies individually.



A D T

### 4.7.7 TEST RESULTS

CHANNEL	FREQUENCY (MHz)	OUTPUT POWER (mW)		OUTPUT POWER (dBm)		POWER LIMIT (mW)	PASS / FAIL
		GFSK	8DPSK	GFSK	8DPSK		
0	2402	2.553	2.056	4.07	3.13	125	PASS
39	2441	<b>2.642</b>	1.932	4.22	2.86	125	PASS
78	2480	2.612	1.858	4.17	2.69	125	PASS

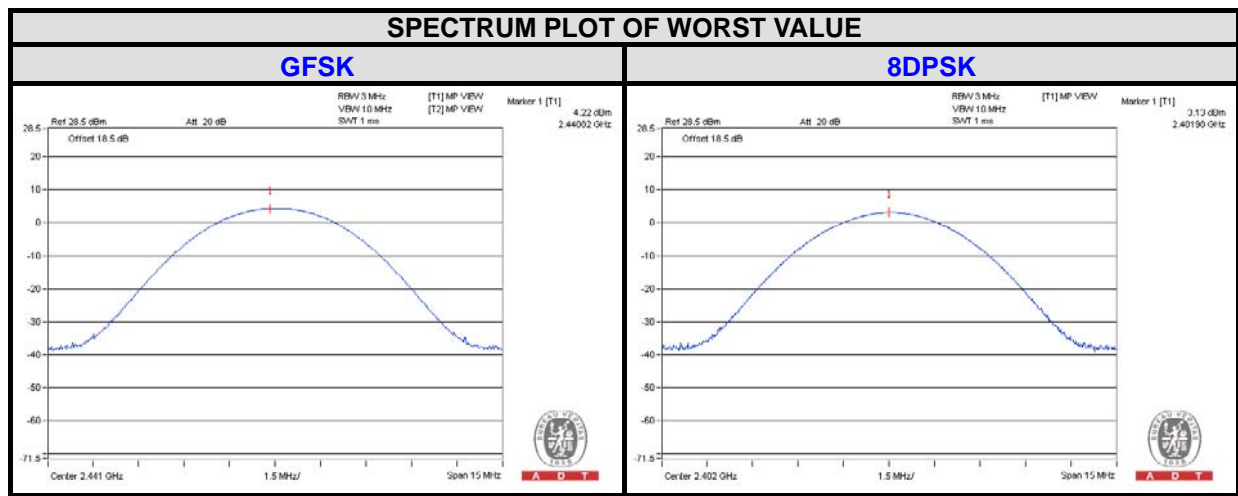

## 4.8 CONDUCTED OUT OF BAND EMISSION MEASUREMENT

### 4.8.1 LIMITS OF CONDUCTED OUT OF BAND EMISSION MEASUREMENT

Below  $-20\text{dB}$  of the highest emission level of operating band (in 100kHz RBW).

### 4.8.2 TEST INSTRUMENTS

Refer to section 4.1.2 to get information of above instrument.

### 4.8.3 TEST PROCEDURE

The transmitter output was connected to the spectrum analyzer via a low lose cable. Set both RBW and VBW of spectrum analyzer to 100 kHz and 300 kHz with suitable frequency span including 100 MHz bandwidth from band edge. The band edges was measured and recorded.

### 4.8.4 DEVIATION FROM TEST STANDARD

No deviation.

### 4.8.5 EUT OPERATING CONDITION

The software provided by client enabled the EUT to transmit and receive data at lowest, middle and highest channel frequencies individually.

### 4.8.6 TEST RESULTS

The spectrum plots are attached on the following images. D1 line indicates the highest level, D2 line indicates the 20dB offset below D1. It shows compliance with the requirement.



A D T

### GFSK

#### Hopping disabled\_ Low Channel

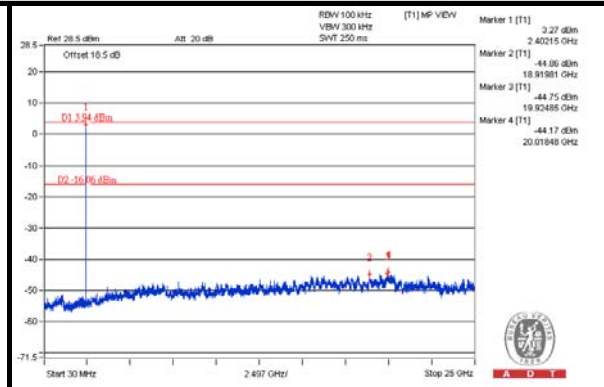
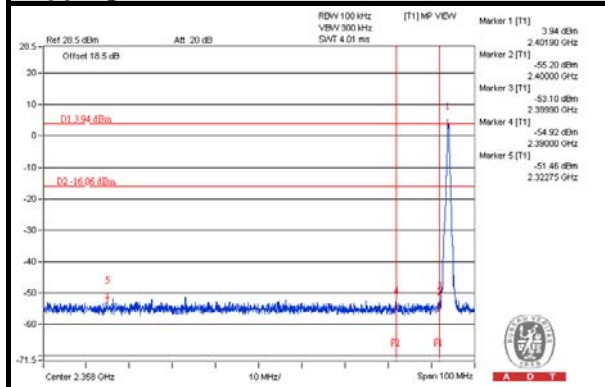

#### Hopping disabled\_ High Channel

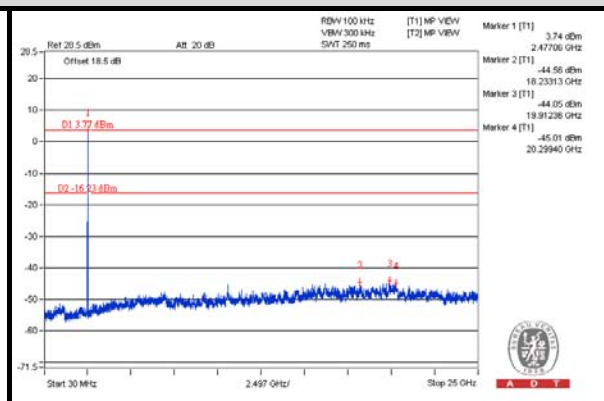
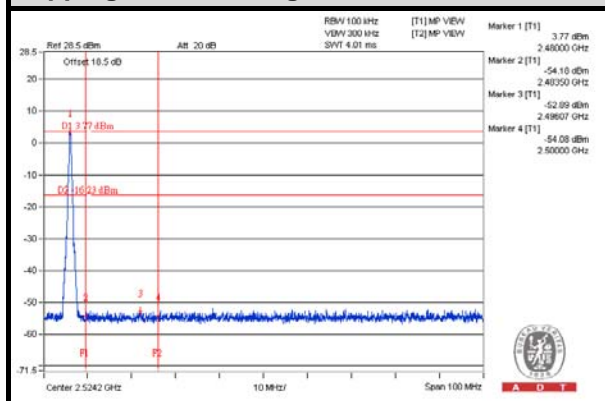

#### Hopping enabled\_ Low Channel

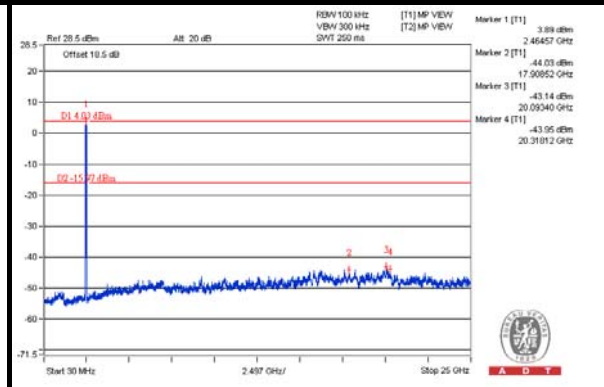
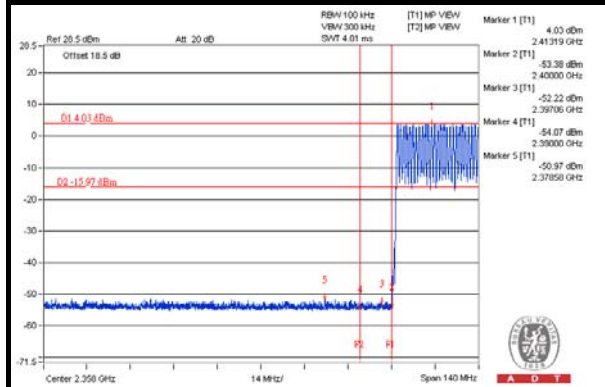

#### Hopping enabled\_ High Channel

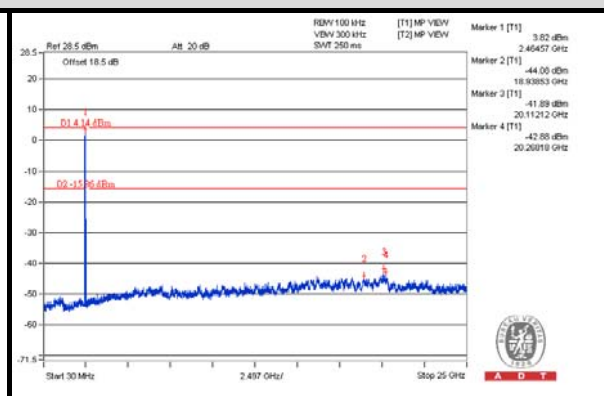
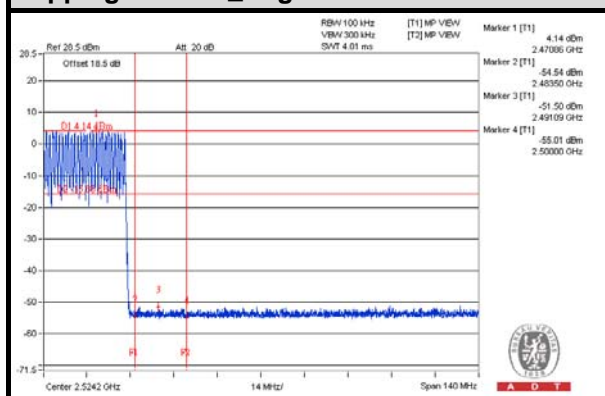



A D T

### 8DPSK

#### Hopping disabled\_ Low Channel

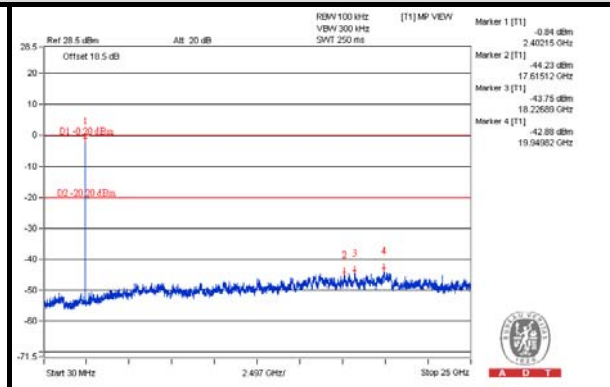
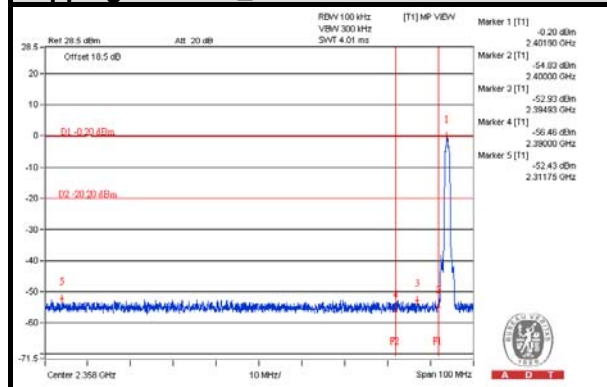

#### Hopping disabled\_ High Channel

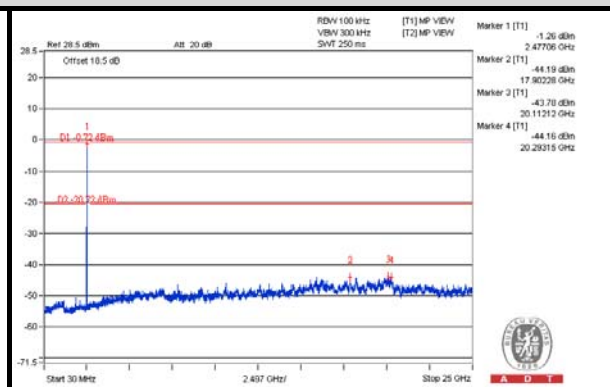
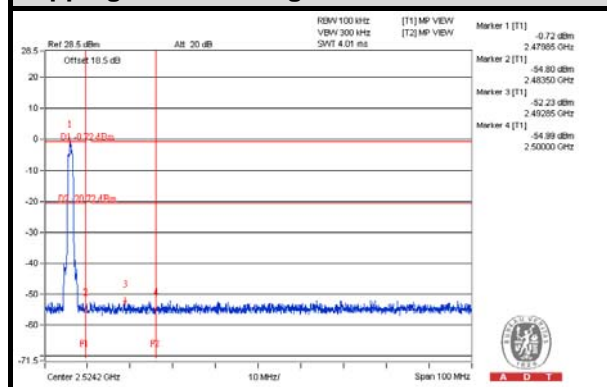

#### Hopping enabled\_ Low Channel

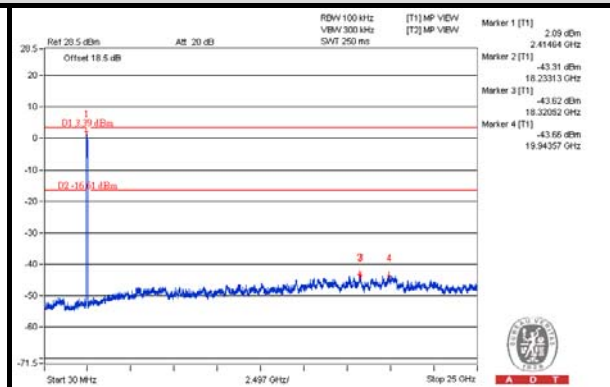
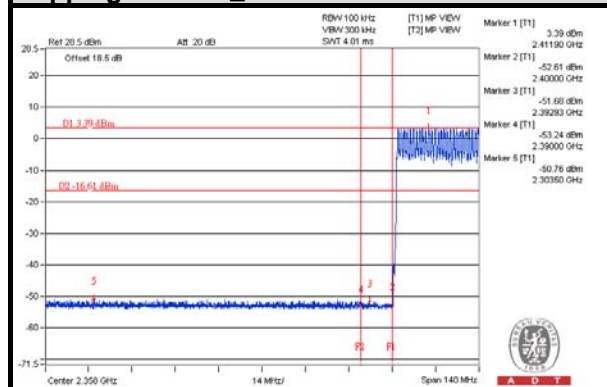

#### Hopping enabled\_ High Channel

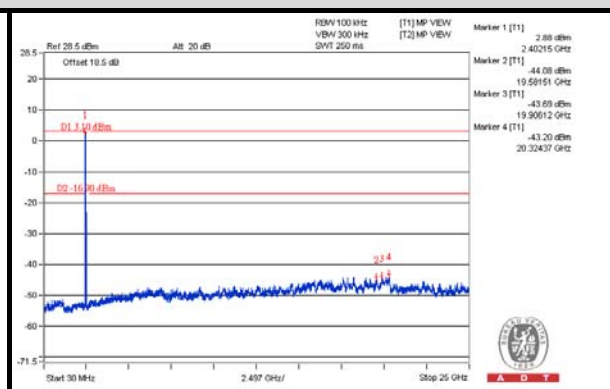
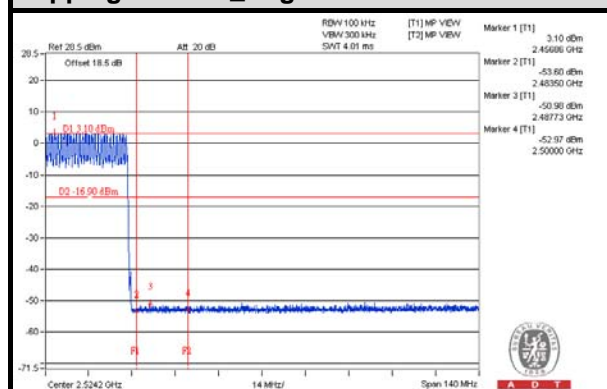



A D T

## 5. PHOTOGRAPHS OF THE TEST CONFIGURATION

Please refer to the attached file (Test Setup Photo).





## 6. INFORMATION ON THE TESTING LABORATORIES

We, Bureau Veritas Consumer Products Services (H.K.) Ltd., Taoyuan Branch, were founded in 1988 to provide our best service in EMC, Radio, Telecom and Safety consultation. Our laboratories are accredited and approved according to ISO/IEC 17025.

If you have any comments, please feel free to contact us at the following:

**Linko EMC/RF Lab:**

Tel: 886-2-26052180

Fax: 886-2-26051924

**Hsin Chu EMC/RF Lab:**

Tel: 886-3-5935343

Fax: 886-3-5935342

**Hwa Ya EMC/RF/Safety Telecom Lab:**

Tel: 886-3-3183232

Fax: 886-3-3270892

**Email:** [service.adt@tw.bureauveritas.com](mailto:service.adt@tw.bureauveritas.com)

**Web Site:** [www.bureauveritas-adt.com](http://www.bureauveritas-adt.com)

The address and road map of all our labs can be found in our web site also.



A D T

## **7. APPENDIX A – MODIFICATIONS RECORDERS FOR ENGINEERING CHANGES TO THE EUT BY THE LAB**

No any modifications are made to the EUT by the lab during the test.

--- END ---