



FCC TEST REPORT (WLAN)

REPORT NO.: RF141002C15

MODEL NO.: A1408

FCC ID: HLZA1408

RECEIVED: Oct. 02, 2014

TESTED: Oct. 09 ~ Oct. 14, 2014

ISSUED: Oct. 21, 2014

APPLICANT: Acer Incorporated

ADDRESS: 8F., No. 88, Sec. 1, Xintai 5th Rd., Xizhi Dist.,
New Taipei City 221, Taiwan

ISSUED BY: Bureau Veritas Consumer Products Services
(H.K.) Ltd., Taoyuan Branch

LAB ADDRESS: No. 47-2, 14th Ling, Chia Pau Vil., Lin Kou Dist.,
New Taipei City, Taiwan, R.O.C.

TEST LOCATION: No. 19, Hwa Ya 2nd Rd, Wen Hwa Tsuen, Kwei
Shan Hsiang, Taoyuan Hsien 333, Taiwan, R.O.C.

This report should not be used by the client to claim product certification, approval, or endorsement by TAF or any government agencies.



This report is for your exclusive use. Any copying or replication of this report to or for any other person or entity, or use of our name or trademark, is permitted only with our prior written permission. This report sets forth our findings solely with respect to the test samples identified herein. The results set forth in this report are not indicative or representative of the quality or characteristics of the lot from which a test sample was taken or any similar or identical product unless specifically and expressly noted. Our report includes all of the tests requested by you and the results thereof based upon the information that you provided to us. You have 60 days from date of issuance of this report to notify us of any material error or omission caused by our negligence, provided, however, that such notice shall be in writing and shall specifically address the issue you wish to raise. A failure to raise such issue within the prescribed time shall constitute your unqualified acceptance of the completeness of this report, the tests conducted and the correctness of the report contents. Unless specific mention, the uncertainty of measurement has been explicitly taken into account to declare the compliance or non-compliance to the specification.



A D T

TABLE OF CONTENTS

RELEASE CONTROL RECORD	4
1. CERTIFICATION.....	5
2. SUMMARY OF TEST RESULTS	6
2.1 MEASUREMENT UNCERTAINTY	6
3. GENERAL INFORMATION.....	7
3.1 GENERAL DESCRIPTION OF EUT.....	7
3.2 DESCRIPTION OF TEST MODES.....	8
3.2.1 TEST MODE APPLICABILITY AND TESTED CHANNEL DETAIL.....	9
3.3 DUTY CYCLE OF TEST SIGNAL.....	11
3.4 DESCRIPTION OF SUPPORT UNITS.....	12
3.4.1 CONFIGURATION OF SYSTEM UNDER TEST.....	12
3.5 GENERAL DESCRIPTION OF APPLIED STANDARDS.....	13
4. TEST TYPES AND RESULTS	14
4.1 RADIATED EMISSION AND BANDEDGE MEASUREMENT	14
4.1.1 LIMITS OF RADIATED EMISSION AND BANDEDGE MEASUREMENT.....	14
4.1.2 TEST INSTRUMENTS.....	15
4.1.3 TEST PROCEDURES	16
4.1.4 DEVIATION FROM TEST STANDARD	16
4.1.5 TEST SETUP.....	17
4.1.6 EUT OPERATING CONDITIONS.....	18
4.1.7 TEST RESULTS	19
4.2 CONDUCTED EMISSION MEASUREMENT.....	30
4.2.1 LIMITS OF CONDUCTED EMISSION MEASUREMENT.....	30
4.2.2 TEST INSTRUMENTS.....	30
4.2.3 TEST PROCEDURES	31
4.2.4 DEVIATION FROM TEST STANDARD	31
4.2.5 TEST SETUP.....	31
4.2.6 EUT OPERATING CONDITIONS.....	31
4.2.7 TEST RESULTS	32
4.3 6dB BANDWIDTH MEASUREMENT	36
4.3.1 LIMITS OF 6dB BANDWIDTH MEASUREMENT.....	36
4.3.2 TEST SETUP.....	36
4.3.3 TEST INSTRUMENTS.....	36
4.3.4 TEST PROCEDURE.....	36
4.3.5 DEVIATION FROM TEST STANDARD	36
4.3.6 EUT OPERATING CONDITIONS.....	36
4.3.7 TEST RESULTS	37
4.4 CONDUCTED OUTPUT POWER	39
4.4.1 LIMITS OF CONDUCTED OUTPUT POWER MEASUREMENT	39



A D T

4.4.2	TEST SETUP	39
4.4.3	TEST INSTRUMENTS.....	39
4.4.4	TEST PROCEDURES	39
4.4.5	DEVIATION FROM TEST STANDARD	40
4.4.6	EUT OPERATING CONDITIONS	40
4.4.7	TEST RESULTS	41
4.5	POWER SPECTRAL DENSITY MEASUREMENT.....	43
4.5.1	LIMITS OF POWER SPECTRAL DENSITY MEASUREMENT.....	43
4.5.2	TEST SETUP.....	43
4.5.3	TEST INSTRUMENTS.....	43
4.5.4	TEST PROCEDURE.....	43
4.5.5	DEVIATION FROM TEST STANDARD	43
4.5.6	EUT OPERATING CONDITION	43
4.5.7	TEST RESULTS	44
4.6	CONDUCTED OUT OF BAND EMISSION MEASUREMENT	46
4.6.1	LIMITS OF CONDUCTED OUT OF BAND EMISSION MEASUREMENT.....	46
4.6.2	TEST SETUP.....	46
4.6.3	TEST INSTRUMENTS.....	46
4.6.4	TEST PROCEDURE.....	47
4.6.5	DEVIATION FROM TEST STANDARD	47
4.6.6	EUT OPERATING CONDITION	47
4.6.7	TEST RESULTS	47
5.	PHOTOGRAPHS OF THE TEST CONFIGURATION	51
6.	INFORMATION ON THE TESTING LABORATORIES.....	52
7.	APPENDIX A – MODIFICATIONS RECORDERS FOR ENGINEERING CHANGES TO THE EUT BY THE LAB.....	53



RELEASE CONTROL RECORD

ISSUE NO.	REASON FOR CHANGE	DATE ISSUED
RF141002C15	Original release.	Oct. 21, 2014



1. CERTIFICATION

PRODUCT: Tablet Computer
MODEL NO.: A1408
BRAND: Acer
APPLICANT: Acer Incorporated
TESTED: Oct. 09 ~ Oct. 14, 2014
TEST SAMPLE: ENGINEERING SAMPLE
STANDARDS: **FCC Part 15, Subpart C (Section 15.247)**
ANSI C63.10-2009

The above equipment (model: A1408) has been tested by **Bureau Veritas Consumer Products Services (H.K.) Ltd., Taoyuan Branch**, and found compliance with the requirement of the above standards. The test record, data evaluation & Equipment Under Test (EUT) configurations represented herein are true and accurate accounts of the measurements of the sample's EMC characteristics under the conditions specified in this report.

PREPARED BY: Ivy Lin , **DATE:** Oct. 21, 2014
Ivy Lin / Specialist

APPROVED BY: Ken Liu , **DATE:** Oct. 21, 2014
Ken Liu / Senior Manager

2. SUMMARY OF TEST RESULTS

The EUT has been tested according to the following specifications:

APPLIED STANDARD: FCC PART 15, SUBPART C (SECTION 15.247)			
STANDARD SECTION	TEST TYPE	RESULT	REMARK
15.207	AC Power Conducted Emission	PASS	Meet the requirement of limit. Minimum passing margin is -10.87dB at 0.68196MHz.
15.205 & 209	Radiated Emissions	PASS	Meet the requirement of limit. Minimum passing margin is -1.0dB at 2483.50MHz.
15.247(d)	Band Edge Measurement	PASS	Meet the requirement of limit. Minimum passing margin is -1.0dB at 2483.50MHz.
15.247(d)	Antenna Port Emission	PASS	Meet the requirement of limit.
15.247(a)(2)	6dB bandwidth	PASS	Meet the requirement of limit.
15.247(b)	Conducted power	PASS	Meet the requirement of limit.
15.247(e)	Power Spectral Density	PASS	Meet the requirement of limit.
15.203	Antenna Requirement	PASS	Antenna connector is IPEX MHF 4L not a standard connector.

2.1 MEASUREMENT UNCERTAINTY

Where relevant, the following measurement uncertainty levels have been estimated for tests performed on the EUT as specified in CISPR 16-4-2:

MEASUREMENT	FREQUENCY	UNCERTAINTY
Conducted emissions	150kHz~30MHz	2.44 dB
Radiated emissions	30MHz ~ 200MHz	3.86 dB
	200MHz ~1000MHz	3.87 dB
	1GHz ~ 18GHz	2.29 dB
	18GHz ~ 40GHz	2.29 dB

This uncertainty represents an expanded uncertainty expressed at approximately the 95% confidence level using a coverage factor of $k = 2$.

3. GENERAL INFORMATION

3.1 GENERAL DESCRIPTION OF EUT

EUT	Tablet Computer
MODEL NO.	A1408
POWER SUPPLY	3.8Vdc (Battery) 5.2 or 5.35Vdc (Adapter) 5.0Vdc (Host equipment)
MODULATION TYPE	CCK, DQPSK, DBPSK for DSSS 64QAM, 16QAM, QPSK, BPSK for OFDM
MODULATION TECHNOLOGY	DSSS, OFDM
TRANSFER RATE	802.11b: 11.0/ 5.5/ 2.0/ 1.0Mbps 802.11g: 54.0/ 48.0/ 36.0/ 24.0/ 18.0/ 12.0/ 9.0/ 6.0Mbps 802.11n: up to 72.2Mbps
OPERATING FREQUENCY	2412 ~ 2462MHz
NUMBER OF CHANNEL	11 for 802.11b, 802.11g, 802.11n (20MHz)
OUTPUT POWER	219.786mW
ANTENNA TYPE	PIFA antenna with 3.90dBi gain
ANTENNA CONNECTOR	IPEX MHF 4L
DATA CABLE	1.2m non-shielded USB cable without core
I/O PORTS	Refer to user's manual
ACCESSORY DEVICES	Adapter, Battery

NOTE:

- The EUT provides one completed transmitter and one receiver.

MODULATION MODE	TX FUNCTION
802.11b	1TX
802.11g	1TX
802.11n (20MHz)	1TX

- The EUT consumes power from the following battery and adapters.

Battery	
BRAND:	LGC
MODEL:	AP14E8K
RATING:	3.8Vdc

ADAPTER 1	
BRAND:	LITEON
MODEL:	PA-1070-07
INPUT:	100-240Vac, 50/60Hz, 0.25A
OUTPUT:	5.2Vdc, 1.35A LPS

ADAPTER 2	
BRAND:	DELTA Electronics, INC.
MODEL:	ADP-10HW A
INPUT:	100-240Vac, 50-60Hz, 0.4A
OUTPUT:	5.35Vdc, 2A

* Adapter 1 was the worst for the final tests.

- The above EUT information is declared by manufacturer and for more detailed features description, please refer to the manufacturer's specifications or user's manual

3.2 DESCRIPTION OF TEST MODES

11 channels are provided for 802.11b, 802.11g and 802.11n (20MHz):

CHANNEL	FREQUENCY	CHANNEL	FREQUENCY
1	2412MHz	7	2442MHz
2	2417MHz	8	2447MHz
3	2422MHz	9	2452MHz
4	2427MHz	10	2457MHz
5	2432MHz	11	2462MHz
6	2437MHz		



3.2.1 TEST MODE APPLICABILITY AND TESTED CHANNEL DETAIL

EUT CONFIGURE MODE	APPLICABLE TO				DESCRIPTION
	RE≥1G	RE<1G	PLC	APCM	
A	√	√	√	√	Power from adapter 1
B	-	√	√	-	Power from adapter 2

Where **RE≥1G**: Radiated Emission above 1GHz **RE<1G**: Radiated Emission below 1GHz
PLC: Power Line Conducted Emission **APCM**: Antenna Port Conducted Measurement

NOTE: The EUT had been pre-tested on the positioned of each 3 axis. The worst case was found when positioned on **Y-plane**.

NOTE: "-" means no effect.

RADIATED EMISSION TEST (ABOVE 1GHz):

- Pre-Scan has been conducted to determine the worst-case mode from all possible combinations between available modulations, data rates and antenna ports (if EUT with antenna diversity architecture).
- Following channel(s) was (were) selected for the final test as listed below.

EUT CONFIGURE MODE	MODE	AVAILABLE CHANNEL	TESTED CHANNEL	MODULATION TECHNOLOGY	MODULATION TYPE	DATA RATE (Mbps)
A	802.11b	1 to 11	1, 6, 11	DSSS	DBPSK	1.0
A	802.11g	1 to 11	1, 6, 11	OFDM	BPSK	6.0
A	802.11n (20MHz)	1 to 11	1, 6, 11	OFDM	BPSK	6.5

RADIATED EMISSION TEST (BELOW 1GHz):

- Pre-Scan has been conducted to determine the worst-case mode from all possible combinations between available modulations, data rates and antenna ports (if EUT with antenna diversity architecture).
- Following channel(s) was (were) selected for the final test as listed below.

EUT CONFIGURE MODE	MODE	AVAILABLE CHANNEL	TESTED CHANNEL	MODULATION TECHNOLOGY	MODULATION TYPE	DATA RATE (Mbps)
A, B	802.11g	1 to 11	6	OFDM	BPSK	6.0

POWER LINE CONDUCTED EMISSION TEST:

- Pre-Scan has been conducted to determine the worst-case mode from all possible combinations between available modulations, data rates and antenna ports (if EUT with antenna diversity architecture).
- Following channel(s) was (were) selected for the final test as listed below.

EUT CONFIGURE MODE	MODE	AVAILABLE CHANNEL	TESTED CHANNEL	MODULATION TECHNOLOGY	MODULATION TYPE	DATA RATE (Mbps)
A, B	802.11g	1 to 11	6	OFDM	BPSK	6.0



BANDEDGE MEASUREMENT:

- Pre-Scan has been conducted to determine the worst-case mode from all possible combinations between available modulations, data rates and antenna ports (if EUT with antenna diversity architecture).
- Following channel(s) was (were) selected for the final test as listed below.

EUT CONFIGURE MODE	MODE	AVAILABLE CHANNEL	TESTED CHANNEL	MODULATION TECHNOLOGY	MODULATION TYPE	DATA RATE (Mbps)
A	802.11b	1 to 11	1, 11	DSSS	DBPSK	1.0
A	802.11g	1 to 11	1, 11	OFDM	BPSK	6.0
A	802.11n (20MHz)	1 to 11	1, 11	OFDM	BPSK	6.5

ANTENNA PORT CONDUCTED MEASUREMENT:

- This item includes all test value of each mode, but only includes spectrum plot of worst value of each mode.
- Pre-Scan has been conducted to determine the worst-case mode from all possible combinations between available modulations, data rates and antenna ports (if EUT with antenna diversity architecture).
- Following channel(s) was (were) selected for the final test as listed below.

EUT CONFIGURE MODE	MODE	AVAILABLE CHANNEL	TESTED CHANNEL	MODULATION TECHNOLOGY	MODULATION TYPE	DATA RATE (Mbps)
A	802.11b	1 to 11	1, 6, 11	DSSS	DBPSK	1.0
A	802.11g	1 to 11	1, 6, 11	OFDM	BPSK	6.0
A	802.11n (20MHz)	1 to 11	1, 6, 11	OFDM	BPSK	6.5

TEST CONDITION:

APPLICABLE TO	ENVIRONMENTAL CONDITIONS	INPUT POWER	TESTED BY
RE≥1G	21deg. C, 71%RH	120Vac, 60Hz	Nick Hsu
RE<1G	21deg. C, 71%RH	120Vac, 60Hz	Nick Hsu
PLC	18deg. C, 72%RH, 23deg. C, 69%RH	120Vac, 60Hz	Nick Hsu
APCM	25deg. C, 60%RH	120Vac, 60Hz	Nick Chen

3.3 DUTY CYCLE OF TEST SIGNAL

802.11b: Duty cycle = $8.610/8.710 = 0.989$, Duty cycle of test signal is $> 98\%$

802.11g: Duty cycle = $1.424/1.545 = 0.922$, Duty factor = $10 * \log(1/0.922) = 0.35$

802.11n (20MHz): Duty cycle = $1.334/1.451 = 0.919$, Duty factor = $10 * \log(1/0.919) = 0.37$

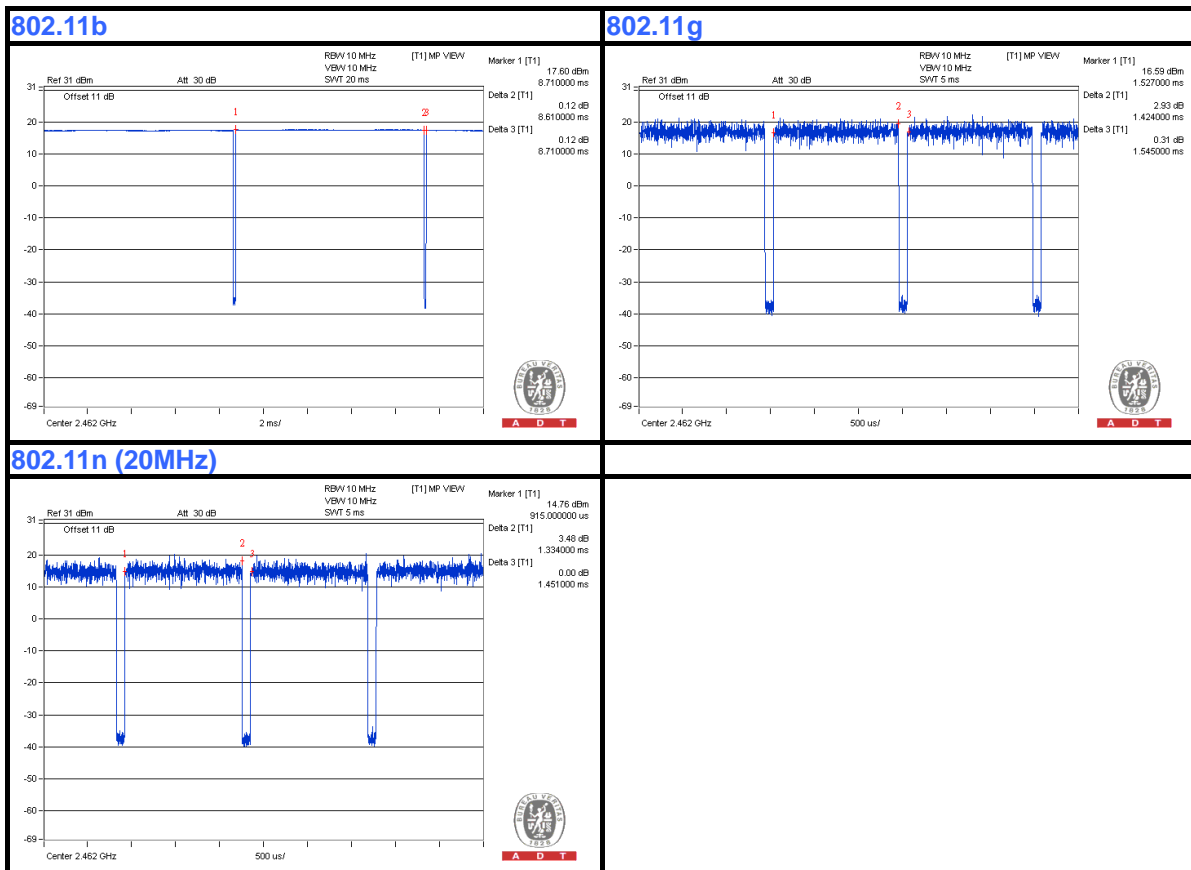

3.4 DESCRIPTION OF SUPPORT UNITS

The EUT has been tested as an independent unit.

3.4.1 CONFIGURATION OF SYSTEM UNDER TEST

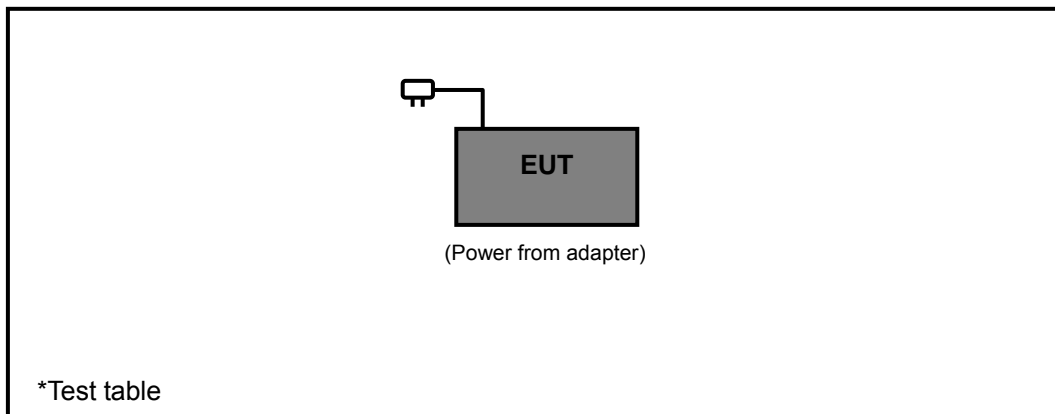



A D T

3.5 GENERAL DESCRIPTION OF APPLIED STANDARDS

The EUT is a RF Product. According to the specifications of the manufacturer, it must comply with the requirements of the following standards:

FCC Part 15, Subpart C (15.247)

558074 D01 DTS Meas Guidance v03r02

ANSI C63.10-2009

All test items have been performed and recorded as per the above standards.

NOTE: The EUT is also considered as a kind of computer peripheral, because the connection to computer is necessary for typical use. It has been verified to comply with the requirements of FCC Part 15, Subpart B, Class B (DoC). The test report has been issued separately.

4. TEST TYPES AND RESULTS

4.1 RADIATED EMISSION AND BANDEDGE MEASUREMENT

4.1.1 LIMITS OF RADIATED EMISSION AND BANDEDGE MEASUREMENT

Radiated emissions which fall in the restricted bands must comply with the radiated emission limits specified as below table. Other emissions shall be at least 20dB below the highest level of the desired power:

FREQUENCIES (MHz)	FIELD STRENGTH (microvolts/meter)	MEASUREMENT DISTANCE (meters)
0.009 ~ 0.490	2400/F(kHz)	300
0.490 ~ 1.705	24000/F(kHz)	30
1.705 ~ 30.0	30	30
30 ~ 88	100	3
88 ~ 216	150	3
216 ~ 960	200	3
Above 960	500	3

NOTE:

1. The lower limit shall apply at the transition frequencies.
2. Emission level (dBuV/m) = 20 log Emission level (uV/m).
3. For frequencies above 1000MHz, the field strength limits are based on average detector, however, the peak field strength of any emission shall not exceed the maximum permitted average limits, specified above by more than 20dB under any condition of modulation.



4.1.2 TEST INSTRUMENTS

DESCRIPTION & MANUFACTURER	MODEL NO.	SERIAL NO.	DATE OF CALIBRATION	DUE DATE OF CALIBRATION
Test Receiver ROHDE & SCHWARZ	ESIB7	100187	Jan. 02, 2014	Jan. 01, 2015
Spectrum Analyzer ROHDE & SCHWARZ	FSP40	100039	Mar. 03, 2014	Mar. 02, 2015
BILOG Antenna SCHWARZBECK	VULB9168	9168-160	Feb. 26, 2014	Feb. 25, 2015
HORN Antenna SCHWARZBECK	9120D	209	Aug. 25, 2014	Aug. 24, 2015
HORN Antenna SCHWARZBECK	BBHA 9170	BBHA9170241	Feb. 17, 2014	Feb. 16, 2015
Preamplifier Agilent	8447D	2944A10633	Oct. 07, 2014	Oct. 05, 2015
Preamplifier Agilent	8449B	3008A01964	Aug. 22, 2014	Aug. 21, 2015
RF signal cable HUBER+SUHNNER	SUCOFLEX 104	214378/4	Aug. 22, 2014	Aug. 21, 2015
RF signal cable HUBER+SUHNNER	SUCOFLEX 106	12738/6 +309224/4	Aug. 22, 2014	Aug. 21, 2015
Software BV ADT	ADT_Radiated_ V7.6.15.9.4	NA	NA	NA
Antenna Tower inn-co GmbH	MA 4000	013303	NA	NA
Antenna Tower Controller inn-co GmbH	CO2000	017303	NA	NA
Turn Table BV ADT	TT100	TT93021703	NA	NA
Turn Table Controller BV ADT	SC100	SC93021703	NA	NA
High Speed Peak Power Meter	ML2495A	0824011	Jul. 26, 2014	Jul. 25, 2015
Power Sensor	MA2411B	0738171	Jul. 26, 2014	Jul. 25, 2015

- NOTE:**
1. The calibration interval of the above test instruments is 12 months and the calibrations are traceable to NML/ROC and NIST/USA.
 2. The calibration interval of the loop antenna is 24 months and the calibrations are traceable to NML/ROC and NIST/USA.
 2. The test was performed in HwaYa Chamber 3.
 3. The horn antenna and HP preamplifier (model: 8449B) are used only for the measurement of emission frequency above 1GHz if tested.
 4. The FCC Site Registration No. is 988962.
 5. The IC Site Registration No. is IC 7450F-3.

4.1.3 TEST PROCEDURES

- a. The EUT was placed on the top of a rotating table 0.8 meters above the ground at a 3 meters semi-anechoic chamber. The table was rotated 360 degrees to determine the position of the highest radiation.
- b. The EUT was set 3 meters away from the interference-receiving antenna, which was mounted on the top of a variable-height antenna tower.
- c. Height of receiving antenna is varied from one meter to four meters above the ground to determine the maximum value of the field strength. Both horizontal and vertical polarizations of the antenna are set to make the measurement.
- d. For each suspected emission, the EUT was arranged to its worst case and then the antenna was tuned to heights from 1 meter to 4 meters and the rotatable table was turned from 0 degrees to 360 degrees to find the maximum reading.
- e. The test-receiver system was set to Peak Detect Function and Specified Bandwidth with Maximum Hold Mode.
- f. If the emission level of the EUT in peak mode was lower than the limit specified, then testing could be stopped and the peak values of the EUT would be reported. Otherwise the emissions would be re-tested one by one using peak, quasi-peak or average method as specified and then reported in a data sheet.

NOTE:

1. The resolution bandwidth and video bandwidth of test receiver/spectrum analyzer is 120kHz for Quasi-peak detection at frequency below 1GHz.
2. The resolution bandwidth of test receiver/spectrum analyzer is 1MHz and video bandwidth is 3MHz for Peak detection at frequency above 1GHz.
3. The resolution bandwidth of test receiver/spectrum analyzer is 1MHz and the video bandwidth is $\geq 1/T$ (Duty cycle < 98%) or 10Hz(Duty cycle > 98%) for Average detection (AV) at frequency above 1GHz.
4. All modes of operation were investigated and the worst-case emissions are reported.

4.1.4 DEVIATION FROM TEST STANDARD

No deviation.

4.1.5 TEST SETUP

Frequency range 30MHz~1GHz

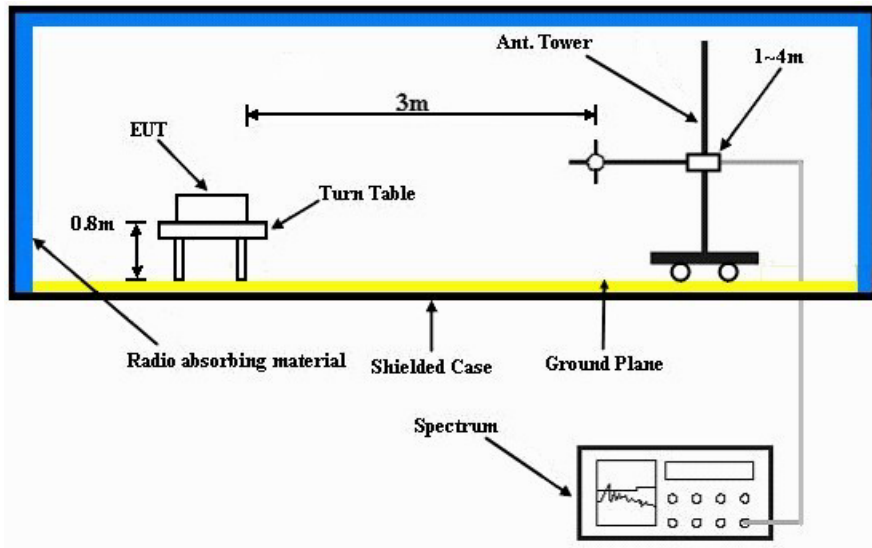

Frequency range above 1GHz

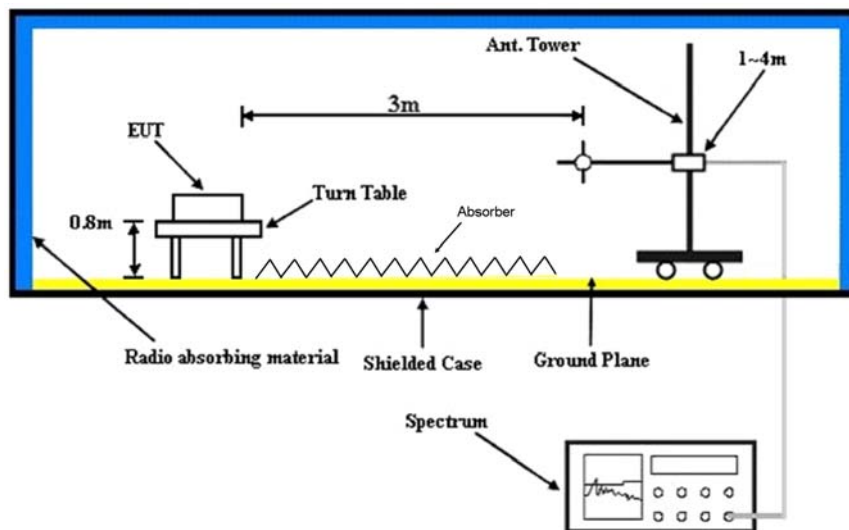

For the actual test configuration, please refer to the attached file (Test Setup Photo).

4.1.6 EUT OPERATING CONDITIONS

Set the EUT under transmission condition continuously at specific channel frequency



A D T

4.1.7 TEST RESULTS

ABOVE 1GHz DATA :

802.11b

CHANNEL	TX Channel 1	DETECTOR FUNCTION	Peak (PK)
FREQUENCY RANGE	1GHz ~ 25GHz		Average (AV)

ANTENNA POLARITY & TEST DISTANCE: HORIZONTAL AT 3 M								
NO.	FREQ. (MHz)	EMISSION LEVEL (dBuV/m)	LIMIT (dBuV/m)	MARGIN (dB)	ANTENNA HEIGHT (m)	TABLE ANGLE (Degree)	RAW VALUE (dBuV)	CORRECTION FACTOR (dB/m)
1	2390.00	57.2 PK	74.0	-16.8	1.22 H	55	24.00	33.20
2	2390.00	47.1 AV	54.0	-6.9	1.22 H	55	13.90	33.20
3	*2412.00	106.0 PK			1.00 H	45	72.70	33.30
4	*2412.00	102.6 AV			1.00 H	45	69.30	33.30
5	4824.00	48.6 PK	74.0	-25.4	1.02 H	61	42.50	6.10
6	4824.00	38.4 AV	54.0	-15.6	1.02 H	61	32.30	6.10
ANTENNA POLARITY & TEST DISTANCE: VERTICAL AT 3 M								
NO.	FREQ. (MHz)	EMISSION LEVEL (dBuV/m)	LIMIT (dBuV/m)	MARGIN (dB)	ANTENNA HEIGHT (m)	TABLE ANGLE (Degree)	RAW VALUE (dBuV)	CORRECTION FACTOR (dB/m)
1	2390.00	57.3 PK	74.0	-16.7	1.27 V	254	24.10	33.20
2	2390.00	46.1 AV	54.0	-7.9	1.27 V	254	12.90	33.20
3	*2412.00	104.0 PK			1.27 V	68	70.70	33.30
4	*2412.00	100.4 AV			1.27 V	68	67.10	33.30
5	4824.00	48.2 PK	74.0	-25.8	1.00 V	194	42.10	6.10
6	4824.00	35.7 AV	54.0	-18.3	1.00 V	194	29.60	6.10

REMARKS:

1. Emission Level(dBuV/m) = Raw Value(dBuV) + Correction Factor(dB/m)
2. Correction Factor(dB/m) = Antenna Factor(dB/m) + Cable Factor(dB) – Pre-Amplifier Factor(dB)
3. The other emission levels were very low against the limit.
4. Margin value = Emission Level – Limit value
5. “ * “: Fundamental frequency.



A D T

CHANNEL	TX Channel 6	DETECTOR FUNCTION	Peak (PK)
FREQUENCY RANGE	1GHz ~ 25GHz		Average (AV)

ANTENNA POLARITY & TEST DISTANCE: HORIZONTAL AT 3 M

NO.	FREQ. (MHz)	EMISSION LEVEL (dBuV/m)	LIMIT (dBuV/m)	MARGIN (dB)	ANTENNA HEIGHT (m)	TABLE ANGLE (Degree)	RAW VALUE (dBuV)	CORRECTION FACTOR (dB/m)
1	*2437.00	106.3 PK			1.22 H	46	72.90	33.40
2	*2437.00	102.7 AV			1.22 H	46	69.30	33.40
3	4874.00	48.1 PK	74.0	-25.9	1.27 H	60	41.90	6.20
4	4874.00	36.9 AV	54.0	-17.1	1.27 H	60	30.70	6.20

ANTENNA POLARITY & TEST DISTANCE: VERTICAL AT 3 M

NO.	FREQ. (MHz)	EMISSION LEVEL (dBuV/m)	LIMIT (dBuV/m)	MARGIN (dB)	ANTENNA HEIGHT (m)	TABLE ANGLE (Degree)	RAW VALUE (dBuV)	CORRECTION FACTOR (dB/m)
1	*2437.00	104.5 PK			1.45 V	69	71.10	33.40
2	*2437.00	100.7 AV			1.45 V	69	67.30	33.40
3	4874.00	48.7 PK	74.0	-25.3	1.00 V	202	42.50	6.20
4	4874.00	35.7 AV	54.0	-18.3	1.00 V	202	29.50	6.20

REMARKS:

1. Emission Level(dBuV/m) = Raw Value(dBuV) + Correction Factor(dB/m)
2. Correction Factor(dB/m) = Antenna Factor(dB/m) + Cable Factor(dB) – Pre-Amplifier Factor(dB)
3. The other emission levels were very low against the limit.
4. Margin value = Emission Level – Limit value
5. “ * “: Fundamental frequency.



A D T

CHANNEL	TX Channel 11	DETECTOR FUNCTION	Peak (PK)
FREQUENCY RANGE	1GHz ~ 25GHz		Average (AV)

ANTENNA POLARITY & TEST DISTANCE: HORIZONTAL AT 3 M

NO.	FREQ. (MHz)	EMISSION LEVEL (dBuV/m)	LIMIT (dBuV/m)	MARGIN (dB)	ANTENNA HEIGHT (m)	TABLE ANGLE (Degree)	RAW VALUE (dBuV)	CORRECTION FACTOR (dB/m)
1	*2462.00	106.1 PK			1.00 H	169	72.80	33.30
2	*2462.00	102.5 AV			1.00 H	169	69.20	33.30
3	2483.50	58.0 PK	74.0	-16.0	1.25 H	170	24.60	33.40
4	2483.50	47.1 AV	54.0	-6.9	1.25 H	170	13.70	33.40
5	4924.00	48.6 PK	74.0	-25.4	1.22 H	109	42.30	6.30
6	4924.00	35.5 AV	54.0	-18.5	1.22 H	109	29.20	6.30

ANTENNA POLARITY & TEST DISTANCE: VERTICAL AT 3 M

NO.	FREQ. (MHz)	EMISSION LEVEL (dBuV/m)	LIMIT (dBuV/m)	MARGIN (dB)	ANTENNA HEIGHT (m)	TABLE ANGLE (Degree)	RAW VALUE (dBuV)	CORRECTION FACTOR (dB/m)
1	*2462.00	104.6 PK			1.25 V	69	71.30	33.30
2	*2462.00	100.8 AV			1.25 V	69	67.50	33.30
3	2483.50	58.7 PK	74.0	-15.3	1.17 V	69	25.30	33.40
4	2483.50	46.5 AV	54.0	-7.5	1.17 V	69	13.10	33.40
5	4924.00	48.3 PK	74.0	-25.7	1.27 V	322	42.00	6.30
6	4924.00	35.8 AV	54.0	-18.2	1.27 V	322	29.50	6.30

REMARKS:

1. Emission Level(dBuV/m) = Raw Value(dBuV) + Correction Factor(dB/m)
2. Correction Factor(dB/m) = Antenna Factor(dB/m) + Cable Factor(dB)
– Pre-Amplifier Factor(dB)
3. The other emission levels were very low against the limit.
4. Margin value = Emission Level – Limit value
5. “ * “: Fundamental frequency.



A D T

802.11g

CHANNEL	TX Channel 1	DETECTOR FUNCTION	Peak (PK)
FREQUENCY RANGE	1GHz ~ 25GHz		Average (AV)

ANTENNA POLARITY & TEST DISTANCE: HORIZONTAL AT 3 M

NO.	FREQ. (MHz)	EMISSION LEVEL (dBuV/m)	LIMIT (dBuV/m)	MARGIN (dB)	ANTENNA HEIGHT (m)	TABLE ANGLE (Degree)	RAW VALUE (dBuV)	CORRECTION FACTOR (dB/m)
1	2390.00	70.8 PK	74.0	-3.2	1.00 H	37	37.60	33.20
2	2390.00	50.7 AV	54.0	-3.3	1.00 H	37	17.50	33.20
3	*2412.00	108.0 PK			1.25 H	55	74.70	33.30
4	*2412.00	98.0 AV			1.25 H	55	64.70	33.30
5	4824.00	48.2 PK	74.0	-25.8	1.11 H	105	42.10	6.10
6	4824.00	34.6 AV	54.0	-19.4	1.11 H	105	28.50	6.10

ANTENNA POLARITY & TEST DISTANCE: VERTICAL AT 3 M

NO.	FREQ. (MHz)	EMISSION LEVEL (dBuV/m)	LIMIT (dBuV/m)	MARGIN (dB)	ANTENNA HEIGHT (m)	TABLE ANGLE (Degree)	RAW VALUE (dBuV)	CORRECTION FACTOR (dB/m)
1	2390.00	69.8 PK	74.0	-4.2	1.28 V	69	36.60	33.20
2	2390.00	49.9 AV	54.0	-4.1	1.28 V	69	16.70	33.20
3	*2412.00	106.4 PK			1.73 V	70	73.10	33.30
4	*2412.00	96.2 AV			1.73 V	70	62.90	33.30
5	4824.00	47.7 PK	74.0	-26.3	1.14 V	154	41.60	6.10
6	4824.00	34.5 AV	54.0	-19.5	1.14 V	154	28.40	6.10

REMARKS:

1. Emission Level(dBuV/m) = Raw Value(dBuV) + Correction Factor(dB/m)
2. Correction Factor(dB/m) = Antenna Factor(dB/m) + Cable Factor(dB) - Pre-Amplifier Factor(dB)
3. The other emission levels were very low against the limit.
4. Margin value = Emission Level - Limit value
5. " * ": Fundamental frequency.



A D T

CHANNEL	TX Channel 6	DETECTOR FUNCTION	Peak (PK)
FREQUENCY RANGE	1GHz ~ 25GHz		Average (AV)

ANTENNA POLARITY & TEST DISTANCE: HORIZONTAL AT 3 M

NO.	FREQ. (MHz)	EMISSION LEVEL (dBuV/m)	LIMIT (dBuV/m)	MARGIN (dB)	ANTENNA HEIGHT (m)	TABLE ANGLE (Degree)	RAW VALUE (dBuV)	CORRECTION FACTOR (dB/m)
1	*2437.00	109.0 PK			1.23 H	46	75.60	33.40
2	*2437.00	99.0 AV			1.23 H	46	65.60	33.40
3	4874.00	47.4 PK	74.0	-26.6	1.12 H	153	41.20	6.20
4	4874.00	34.8 AV	54.0	-19.2	1.12 H	153	28.60	6.20

ANTENNA POLARITY & TEST DISTANCE: VERTICAL AT 3 M

NO.	FREQ. (MHz)	EMISSION LEVEL (dBuV/m)	LIMIT (dBuV/m)	MARGIN (dB)	ANTENNA HEIGHT (m)	TABLE ANGLE (Degree)	RAW VALUE (dBuV)	CORRECTION FACTOR (dB/m)
1	*2437.00	106.8 PK			1.00 V	67	73.40	33.40
2	*2437.00	96.4 AV			1.00 V	67	63.00	33.40
3	4874.00	47.8 PK	74.0	-26.2	1.02 V	256	41.60	6.20
4	4874.00	34.9 AV	54.0	-19.1	1.02 V	256	28.70	6.20

REMARKS:

1. Emission Level(dBuV/m) = Raw Value(dBuV) + Correction Factor(dB/m)
2. Correction Factor(dB/m) = Antenna Factor(dB/m) + Cable Factor(dB) – Pre-Amplifier Factor(dB)
3. The other emission levels were very low against the limit.
4. Margin value = Emission Level – Limit value
5. “ * “: Fundamental frequency.



A D T

CHANNEL	TX Channel 11	DETECTOR FUNCTION	Peak (PK)
FREQUENCY RANGE	1GHz ~ 25GHz		Average (AV)

ANTENNA POLARITY & TEST DISTANCE: HORIZONTAL AT 3 M

NO.	FREQ. (MHz)	EMISSION LEVEL (dBuV/m)	LIMIT (dBuV/m)	MARGIN (dB)	ANTENNA HEIGHT (m)	TABLE ANGLE (Degree)	RAW VALUE (dBuV)	CORRECTION FACTOR (dB/m)
1	*2462.00	107.3 PK			1.00 H	169	74.00	33.30
2	*2462.00	98.2 AV			1.00 H	169	64.90	33.30
3	2483.50	73.0 PK	74.0	-1.0	1.00 H	167	39.60	33.40
4	2483.50	51.9 AV	54.0	-2.1	1.00 H	167	18.50	33.40
5	4924.00	47.8 PK	74.0	-26.2	1.13 H	69	41.50	6.30
6	4924.00	34.9 AV	54.0	-19.1	1.13 H	69	28.60	6.30

ANTENNA POLARITY & TEST DISTANCE: VERTICAL AT 3 M

NO.	FREQ. (MHz)	EMISSION LEVEL (dBuV/m)	LIMIT (dBuV/m)	MARGIN (dB)	ANTENNA HEIGHT (m)	TABLE ANGLE (Degree)	RAW VALUE (dBuV)	CORRECTION FACTOR (dB/m)
1	*2462.00	103.5 PK			1.00 V	99	70.20	33.30
2	*2462.00	94.4 AV			1.00 V	99	61.10	33.30
3	2483.50	70.9 PK	74.0	-3.1	1.00 V	83	37.50	33.40
4	2483.50	50.6 AV	54.0	-3.4	1.00 V	83	17.20	33.40
5	4924.00	48.9 PK	74.0	-25.1	1.02 V	192	42.60	6.30
6	4924.00	35.1 AV	54.0	-18.9	1.02 V	192	28.80	6.30

REMARKS:

1. Emission Level(dBuV/m) = Raw Value(dBuV) + Correction Factor(dB/m)
2. Correction Factor(dB/m) = Antenna Factor(dB/m) + Cable Factor(dB)
– Pre-Amplifier Factor(dB)
3. The other emission levels were very low against the limit.
4. Margin value = Emission Level – Limit value
5. “ * “: Fundamental frequency.



A D T

802.11n (20MHz)

CHANNEL	TX Channel 1	DETECTOR FUNCTION	Peak (PK)
FREQUENCY RANGE	1GHz ~ 25GHz		Average (AV)

ANTENNA POLARITY & TEST DISTANCE: HORIZONTAL AT 3 M

NO.	FREQ. (MHz)	EMISSION LEVEL (dBuV/m)	LIMIT (dBuV/m)	MARGIN (dB)	ANTENNA HEIGHT (m)	TABLE ANGLE (Degree)	RAW VALUE (dBuV)	CORRECTION FACTOR (dB/m)
1	2390.00	67.5 PK	74.0	-6.5	1.00 H	46	34.30	33.20
2	2390.00	49.8 AV	54.0	-4.2	1.00 H	46	16.60	33.20
3	*2412.00	106.0 PK			1.24 H	46	72.70	33.30
4	*2412.00	95.5 AV			1.24 H	46	62.20	33.30
5	4824.00	47.2 PK	74.0	-26.8	1.11 H	128	41.10	6.10
6	4824.00	34.3 AV	54.0	-19.7	1.11 H	128	28.20	6.10

ANTENNA POLARITY & TEST DISTANCE: VERTICAL AT 3 M

NO.	FREQ. (MHz)	EMISSION LEVEL (dBuV/m)	LIMIT (dBuV/m)	MARGIN (dB)	ANTENNA HEIGHT (m)	TABLE ANGLE (Degree)	RAW VALUE (dBuV)	CORRECTION FACTOR (dB/m)
1	2390.00	65.3 PK	74.0	-8.7	1.79 V	85	32.10	33.20
2	2390.00	49.8 AV	54.0	-4.2	1.79 V	85	16.60	33.20
3	*2412.00	103.6 PK			1.75 V	70	70.30	33.30
4	*2412.00	94.0 AV			1.75 V	70	60.70	33.30
5	4824.00	47.5 PK	74.0	-26.5	1.01 V	275	41.40	6.10
6	4824.00	34.2 AV	54.0	-19.8	1.01 V	275	28.10	6.10

REMARKS:

1. Emission Level(dBuV/m) = Raw Value(dBuV) + Correction Factor(dB/m)
2. Correction Factor(dB/m) = Antenna Factor(dB/m) + Cable Factor(dB)
– Pre-Amplifier Factor(dB)
3. The other emission levels were very low against the limit.
4. Margin value = Emission Level – Limit value
5. “ * “: Fundamental frequency.



A D T

CHANNEL	TX Channel 6	DETECTOR FUNCTION	Peak (PK)
FREQUENCY RANGE	1GHz ~ 25GHz		Average (AV)

ANTENNA POLARITY & TEST DISTANCE: HORIZONTAL AT 3 M

NO.	FREQ. (MHz)	EMISSION LEVEL (dBuV/m)	LIMIT (dBuV/m)	MARGIN (dB)	ANTENNA HEIGHT (m)	TABLE ANGLE (Degree)	RAW VALUE (dBuV)	CORRECTION FACTOR (dB/m)
1	*2437.00	105.3 PK			1.00 H	45	71.90	33.40
2	*2437.00	96.2 AV			1.00 H	45	62.80	33.40
3	4874.00	47.6 PK	74.0	-26.4	1.08 H	127	41.40	6.20
4	4874.00	34.5 AV	54.0	-19.5	1.08 H	127	28.30	6.20

ANTENNA POLARITY & TEST DISTANCE: VERTICAL AT 3 M

NO.	FREQ. (MHz)	EMISSION LEVEL (dBuV/m)	LIMIT (dBuV/m)	MARGIN (dB)	ANTENNA HEIGHT (m)	TABLE ANGLE (Degree)	RAW VALUE (dBuV)	CORRECTION FACTOR (dB/m)
1	*2437.00	103.6 PK			1.05 V	82	70.20	33.40
2	*2437.00	93.6 AV			1.05 V	82	60.20	33.40
3	4874.00	47.6 PK	74.0	-26.4	1.00 V	292	41.40	6.20
4	4874.00	34.6 AV	54.0	-19.4	1.00 V	292	28.40	6.20

REMARKS:

1. Emission Level(dBuV/m) = Raw Value(dBuV) + Correction Factor(dB/m)
2. Correction Factor(dB/m) = Antenna Factor(dB/m) + Cable Factor(dB) – Pre-Amplifier Factor(dB)
3. The other emission levels were very low against the limit.
4. Margin value = Emission Level – Limit value
5. “ * “: Fundamental frequency.



A D T

CHANNEL	TX Channel 11	DETECTOR FUNCTION	Peak (PK)
FREQUENCY RANGE	1GHz ~ 25GHz		Average (AV)

ANTENNA POLARITY & TEST DISTANCE: HORIZONTAL AT 3 M

NO.	FREQ. (MHz)	EMISSION LEVEL (dBuV/m)	LIMIT (dBuV/m)	MARGIN (dB)	ANTENNA HEIGHT (m)	TABLE ANGLE (Degree)	RAW VALUE (dBuV)	CORRECTION FACTOR (dB/m)
1	*2462.00	104.9 PK			1.00 H	169	71.60	33.30
2	*2462.00	95.5 AV			1.00 H	169	62.20	33.30
3	2483.50	71.0 PK	74.0	-3.0	1.00 H	169	37.60	33.40
4	2483.50	49.7 AV	54.0	-4.3	1.00 H	169	16.30	33.40
5	4924.00	47.7 PK	74.0	-26.3	1.13 H	208	41.40	6.30
6	4924.00	35.0 AV	54.0	-19.0	1.13 H	208	28.70	6.30

ANTENNA POLARITY & TEST DISTANCE: VERTICAL AT 3 M

NO.	FREQ. (MHz)	EMISSION LEVEL (dBuV/m)	LIMIT (dBuV/m)	MARGIN (dB)	ANTENNA HEIGHT (m)	TABLE ANGLE (Degree)	RAW VALUE (dBuV)	CORRECTION FACTOR (dB/m)
1	*2462.00	103.7 PK			1.70 V	83	70.40	33.30
2	*2462.00	93.8 AV			1.70 V	83	60.50	33.30
3	2483.50	69.7 PK	74.0	-4.3	1.68 V	87	36.30	33.40
4	2483.50	49.0 AV	54.0	-5.0	1.68 V	87	15.60	33.40
5	4924.00	48.4 PK	74.0	-25.6	1.02 V	271	42.10	6.30
6	4924.00	34.9 AV	54.0	-19.1	1.02 V	271	28.60	6.30

REMARKS:

1. Emission Level(dBuV/m) = Raw Value(dBuV) + Correction Factor(dB/m)
2. Correction Factor(dB/m) = Antenna Factor(dB/m) + Cable Factor(dB)
– Pre-Amplifier Factor(dB)
3. The other emission levels were very low against the limit.
4. Margin value = Emission Level – Limit value
5. “ * “: Fundamental frequency.



A D T

BELOW 1GHz WORST-CASE DATA: 802.11g

CHANNEL	TX Channel 6	DETECTOR FUNCTION	Quasi-Peak (QP)
FREQUENCY RANGE	30MHz ~ 1GHz		
TEST MODE	A		

ANTENNA POLARITY & TEST DISTANCE: HORIZONTAL AT 3 M								
NO.	FREQ. (MHz)	EMISSION LEVEL (dBuV/m)	LIMIT (dBuV/m)	MARGIN (dB)	ANTENNA HEIGHT (m)	TABLE ANGLE (Degree)	RAW VALUE (dBuV)	CORRECTION FACTOR (dB/m)
1	57.12	32.2 QP	40.0	-7.8	2.00 H	10	46.70	-14.50
2	132.95	23.4 QP	43.5	-20.1	2.00 H	123	38.30	-14.90
3	206.83	24.6 QP	43.5	-18.9	1.01 H	261	41.00	-16.40
4	414.87	23.6 QP	46.0	-22.4	1.01 H	8	33.50	-9.90
5	622.91	35.1 QP	46.0	-10.9	1.50 H	354	40.50	-5.40
6	830.95	29.6 QP	46.0	-16.4	1.01 H	356	30.90	-1.30
ANTENNA POLARITY & TEST DISTANCE: VERTICAL AT 3 M								
NO.	FREQ. (MHz)	EMISSION LEVEL (dBuV/m)	LIMIT (dBuV/m)	MARGIN (dB)	ANTENNA HEIGHT (m)	TABLE ANGLE (Degree)	RAW VALUE (dBuV)	CORRECTION FACTOR (dB/m)
1	29.90	32.1 QP	40.0	-7.9	1.00 V	97	48.00	-15.90
2	57.12	31.5 QP	40.0	-8.5	1.00 V	335	46.00	-14.50
3	80.45	27.1 QP	40.0	-12.9	1.00 V	135	45.70	-18.60
4	148.50	23.5 QP	43.5	-20.0	1.00 V	168	37.30	-13.80
5	372.09	20.2 QP	46.0	-25.8	1.49 V	69	30.80	-10.60
6	622.91	29.1 QP	46.0	-16.9	1.00 V	326	34.50	-5.40

REMARKS:

- Emission Level(dBuV/m) = Raw Value(dBuV) + Correction Factor(dB/m)
- Correction Factor(dB/m) = Antenna Factor(dB/m) + Cable Factor(dB)
– Pre-Amplifier Factor(dB)
- The other emission levels were very low against the limit.
- Margin value = Emission Level – Limit value



A D T

CHANNEL	TX Channel 6	DETECTOR FUNCTION	Quasi-Peak (QP)
FREQUENCY RANGE	30MHz ~ 1GHz		
TEST MODE	B		

ANTENNA POLARITY & TEST DISTANCE: HORIZONTAL AT 3 M

NO.	FREQ. (MHz)	EMISSION LEVEL (dBuV/m)	LIMIT (dBuV/m)	MARGIN (dB)	ANTENNA HEIGHT (m)	TABLE ANGLE (Degree)	RAW VALUE (dBuV)	CORRECTION FACTOR (dB/m)
1	57.12	31.8 QP	40.0	-8.2	1.99 H	16	46.30	-14.50
2	144.61	24.8 QP	43.5	-18.7	1.99 H	267	38.80	-14.00
3	171.83	28.9 QP	43.5	-14.6	1.49 H	296	43.10	-14.20
4	210.72	29.1 QP	43.5	-14.4	1.00 H	175	45.30	-16.20
5	249.60	24.0 QP	46.0	-22.0	1.00 H	303	38.10	-14.10
6	622.91	35.2 QP	46.0	-10.8	1.49 H	10	40.60	-5.40

ANTENNA POLARITY & TEST DISTANCE: VERTICAL AT 3 M

NO.	FREQ. (MHz)	EMISSION LEVEL (dBuV/m)	LIMIT (dBuV/m)	MARGIN (dB)	ANTENNA HEIGHT (m)	TABLE ANGLE (Degree)	RAW VALUE (dBuV)	CORRECTION FACTOR (dB/m)
1	33.79	31.1 QP	40.0	-8.9	1.00 V	194	46.80	-15.70
2	57.12	29.2 QP	40.0	-10.8	1.00 V	232	43.70	-14.50
3	142.67	22.8 QP	43.5	-20.7	1.00 V	265	37.00	-14.20
4	173.78	22.3 QP	43.5	-21.2	2.00 V	206	36.50	-14.20
5	201.00	22.4 QP	43.5	-21.1	1.50 V	212	38.90	-16.50
6	622.91	27.2 QP	46.0	-18.8	1.00 V	138	32.60	-5.40

REMARKS:

1. Emission Level(dBuV/m) = Raw Value(dBuV) + Correction Factor(dB/m)
2. Correction Factor(dB/m) = Antenna Factor(dB/m) + Cable Factor(dB)
– Pre-Amplifier Factor(dB)
3. The other emission levels were very low against the limit.
4. Margin value = Emission Level – Limit value



A D T

4.2 CONDUCTED EMISSION MEASUREMENT

4.2.1 LIMITS OF CONDUCTED EMISSION MEASUREMENT

FREQUENCY OF EMISSION (MHz)	CONDUCTED LIMIT (dB μ V)	
	Quasi-peak	Average
0.15 ~ 0.5	66 to 56	56 to 46
0.5 ~ 5	56	46
5 ~ 30	60	50

- NOTE:** 1. The lower limit shall apply at the transition frequencies.
2. The limit decreases in line with the logarithm of the frequency in the range of 0.15 to 0.50MHz.
3. All emanations from a class A/B digital device or system, including any network of conductors and apparatus connected thereto, shall not exceed the level of field strengths specified above.

4.2.2 TEST INSTRUMENTS

DESCRIPTION & MANUFACTURER	MODEL NO.	SERIAL NO.	DATE OF CALIBRATION	DUE DATE OF CALIBRATION
Test Receiver ROHDE & SCHWARZ	ESCS30	100288	Apr. 24, 2014	Apr. 23, 2015
RF signal cable Woken	5D-FB	Cable-HYCO2-01	Dec. 27, 2013	Dec. 26, 2014
LISN ROHDE & SCHWARZ (EUT)	ESH2-Z5	100100	Dec. 23, 2013	Dec. 22, 2014
LISN ROHDE & SCHWARZ (Peripheral)	ESH3-Z5	100312	Jul. 10, 2014	Jul. 09, 2015
Software ADT	BV ADT_Cond_ V7.3.7.3	NA	NA	NA

- NOTE:** 1. The calibration interval of the above test instruments is 12 months and the calibrations are traceable to NML/ROC and NIST/USA.
2. The test was performed in HwaYa Shielded Room 2.
3. The VCCI Site Registration No. is C-2047.

4.2.3 TEST PROCEDURES

- a. The EUT was placed 0.4 meters from the conducting wall of the shielded room with EUT being connected to the power mains through a line impedance stabilization network (LISN). Other support units were connected to the power mains through another LISN. The two LISNs provide 50 ohm/ 50uH of coupling impedance for the measuring instrument.
- b. Both lines of the power mains connected to the EUT were checked for maximum conducted interference.
- c. The frequency range from 150kHz to 30MHz was searched. Emission levels under (Limit - 20dB) was not recorded.

NOTE: All modes of operation were investigated and the worst-case emissions are reported.

4.2.4 DEVIATION FROM TEST STANDARD

No deviation.

4.2.5 TEST SETUP

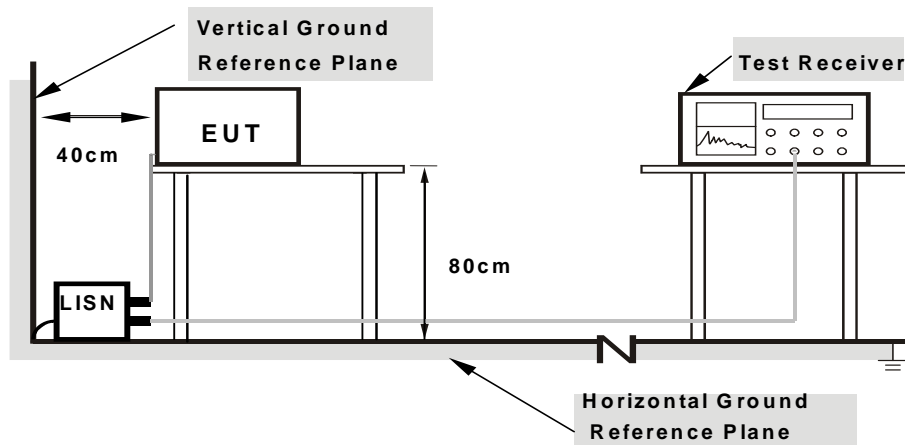

- Note:**
1. Support units were connected to second LISN.
 2. Both of LISNs (AMN) are 80 cm from EUT and at least 80 from other units and other metal planes

For the actual test configuration, please refer to the attached file (Test Setup Photo).

4.2.6 EUT OPERATING CONDITIONS

Same as 4.1.6.

4.2.7 TEST RESULTS

CONDUCTED WORST-CASE DATA : 802.11g

PHASE	Line 1	6dB BANDWIDTH	9kHz
TEST MODE	A		

No	Freq. [MHz]	Corr. Factor (dB)	Reading Value		Emission Level		Limit		Margin	
			[dB (uV)]		[dB (uV)]		[dB (uV)]		(dB)	
			Q.P.	AV.	Q.P.	AV.	Q.P.	AV.	Q.P.	AV.
1	0.93516	0.29	42.03	32.37	42.32	32.66	56.00	46.00	-13.68	-13.34
2	1.35156	0.32	42.75	34.14	43.07	34.46	56.00	46.00	-12.93	-11.54
3	1.61328	0.34	42.30	33.97	42.64	34.31	56.00	46.00	-13.36	-11.69
4	2.00391	0.37	41.57	31.75	41.94	32.12	56.00	46.00	-14.06	-13.88
5	2.81250	0.40	41.70	33.18	42.10	33.58	56.00	46.00	-13.90	-12.42
6	14.62109	0.58	39.92	31.66	40.50	32.24	60.00	50.00	-19.50	-17.76

REMARKS:

1. Q.P. and AV. are abbreviations of quasi-peak and average individually.
2. The emission levels of other frequencies were very low against the limit.
3. Margin value = Emission level - Limit value
4. Correction factor = Insertion loss + Cable loss
5. Emission Level = Correction Factor + Reading Value.

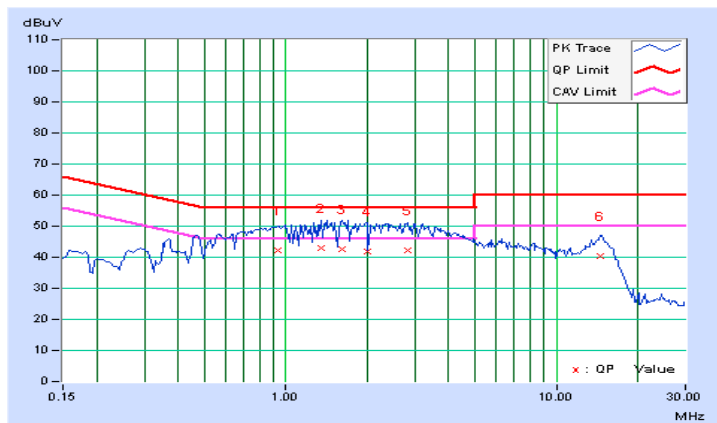

PHASE	Line 1	6dB BANDWIDTH	9kHz
TEST MODE	A		

No	Freq. [MHz]	Corr. Factor (dB)	Reading Value		Emission Level		Limit		Margin	
			[dB (uV)]		[dB (uV)]		[dB (uV)]		(dB)	
			Q.P.	AV.	Q.P.	AV.	Q.P.	AV.	Q.P.	AV.
1	0.96641	0.29	40.37	29.96	40.66	30.25	56.00	46.00	-15.34	-15.75
2	1.32813	0.32	41.34	31.29	41.66	31.61	56.00	46.00	-14.34	-14.39
3	1.82081	0.37	40.18	30.19	40.55	30.56	56.00	46.00	-15.45	-15.44
4	2.66016	0.42	40.96	30.86	41.38	31.28	56.00	46.00	-14.62	-14.72
5	3.91797	0.49	37.69	28.37	38.18	28.86	56.00	46.00	-17.82	-17.14
6	14.87500	0.67	37.64	29.70	38.31	30.37	60.00	50.00	-21.69	-19.63

REMARKS:

1. Q.P. and AV. are abbreviations of quasi-peak and average individually.
2. The emission levels of other frequencies were very low against the limit.
3. Margin value = Emission level - Limit value
4. Correction factor = Insertion loss + Cable loss
5. Emission Level = Correction Factor + Reading Value.

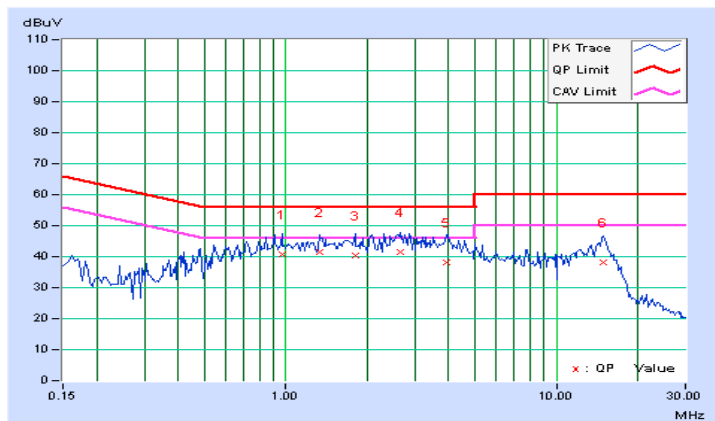

PHASE	Line 1	6dB BANDWIDTH	9kHz
TEST MODE	B		

No	Freq. [MHz]	Corr. Factor (dB)	Reading Value		Emission Level		Limit		Margin	
			[dB (uV)]		[dB (uV)]		[dB (uV)]		(dB)	
			Q.P.	AV.	Q.P.	AV.	Q.P.	AV.	Q.P.	AV.
1	0.15391	0.22	46.96	34.28	47.18	34.50	65.79	55.79	-18.61	-21.29
2	0.18516	0.23	44.55	32.97	44.78	33.20	64.25	54.25	-19.47	-21.05
3	0.20859	0.24	42.31	28.15	42.55	28.39	63.26	53.26	-20.71	-24.87
4	0.26328	0.23	40.88	29.10	41.11	29.33	61.33	51.33	-20.21	-21.99
5	0.31406	0.23	37.47	26.17	37.70	26.40	59.86	49.86	-22.16	-23.46
6	0.68196	0.26	41.89	34.87	42.15	35.13	56.00	46.00	-13.85	-10.87

REMARKS:

1. Q.P. and AV. are abbreviations of quasi-peak and average individually.
2. The emission levels of other frequencies were very low against the limit.
3. Margin value = Emission level - Limit value
4. Correction factor = Insertion loss + Cable loss
5. Emission Level = Correction Factor + Reading Value.

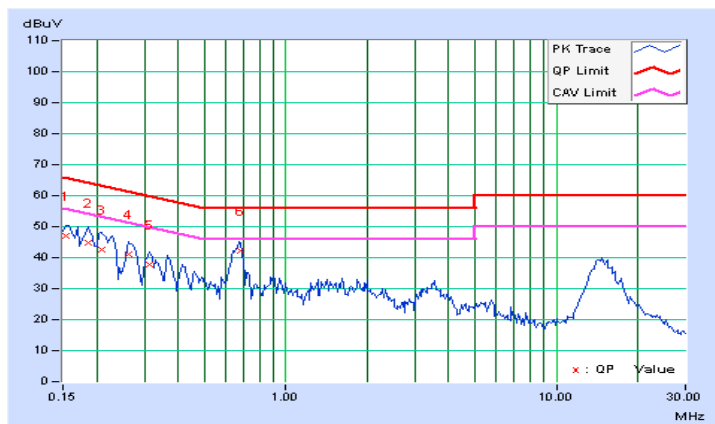

PHASE	Line 1	6dB BANDWIDTH	9kHz
TEST MODE	B		

No	Freq. [MHz]	Corr. Factor (dB)	Reading Value		Emission Level		Limit		Margin	
			[dB (uV)]		[dB (uV)]		[dB (uV)]		(dB)	
			Q.P.	AV.	Q.P.	AV.	Q.P.	AV.	Q.P.	AV.
1	0.15391	0.23	47.27	33.08	47.50	33.31	65.79	55.79	-18.29	-22.48
2	0.18125	0.23	43.84	28.56	44.07	28.79	64.43	54.43	-20.35	-25.63
3	0.22812	0.25	44.07	30.61	44.32	30.86	62.52	52.52	-18.20	-21.66
4	0.26719	0.26	42.56	29.02	42.82	29.28	61.20	51.20	-18.38	-21.92
5	0.31406	0.27	38.67	24.29	38.94	24.56	59.86	49.86	-20.92	-25.30
6	0.68704	0.30	38.62	31.52	38.92	31.82	56.00	46.00	-17.08	-14.18

REMARKS:

1. Q.P. and AV. are abbreviations of quasi-peak and average individually.
2. The emission levels of other frequencies were very low against the limit.
3. Margin value = Emission level - Limit value
4. Correction factor = Insertion loss + Cable loss
5. Emission Level = Correction Factor + Reading Value.

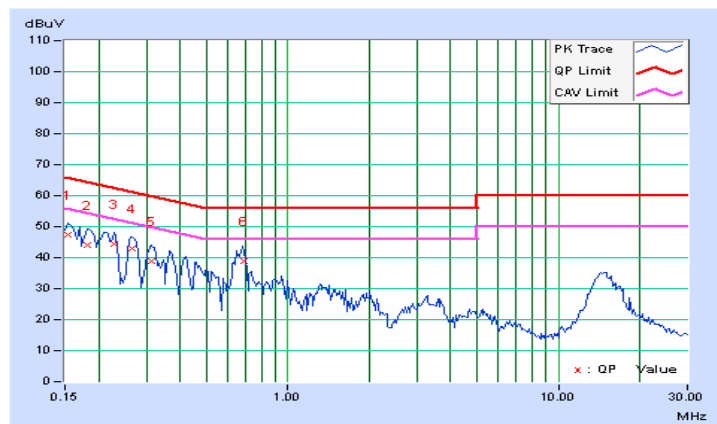

4.3 6dB BANDWIDTH MEASUREMENT

4.3.1 LIMITS OF 6dB BANDWIDTH MEASUREMENT

The minimum of 6dB Bandwidth Measurement is 0.5 MHz.

4.3.2 TEST SETUP

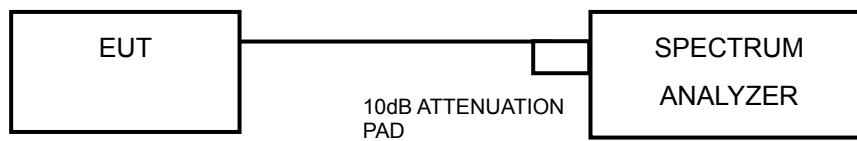

4.3.3 TEST INSTRUMENTS

Refer to section 4.1.2 to get information of above instrument.

4.3.4 TEST PROCEDURE

- a. Set resolution bandwidth (RBW) = 100kHz
- b. Set the video bandwidth (VBW) $\geq 3 \times$ RBW, Detector = Peak.
- c. Trace mode = max hold.
- d. Sweep = auto couple.
- e. Measure the maximum width of the emission that is constrained by the frequencies associated with the two amplitude points (upper and lower) that are attenuated by 6 dB relative to the maximum level measured in the fundamental emission

4.3.5 DEVIATION FROM TEST STANDARD

No deviation.

4.3.6 EUT OPERATING CONDITIONS

The software provided by client to enable the EUT under transmission condition continuously at lowest, middle and highest channel frequencies individually.

4.3.7 TEST RESULTS

802.11b

CHANNEL	FREQUENCY (MHz)	6dB BANDWIDTH (MHz)	MINIMUM LIMIT (MHz)	PASS / FAIL
1	2412	8.08	0.5	PASS
6	2437	8.08	0.5	PASS
11	2462	8.07	0.5	PASS

802.11g

CHANNEL	FREQUENCY (MHz)	6dB BANDWIDTH (MHz)	MINIMUM LIMIT (MHz)	PASS / FAIL
1	2412	15.18	0.5	PASS
6	2437	15.16	0.5	PASS
11	2462	15.17	0.5	PASS

802.11n (20MHz)

CHANNEL	FREQUENCY (MHz)	6dB BANDWIDTH (MHz)	MINIMUM LIMIT (MHz)	PASS / FAIL
1	2412	15.18	0.5	PASS
6	2437	15.17	0.5	PASS
11	2462	15.17	0.5	PASS



A D T

SPECTRUM PLOT OF WORST VALUE

802.11b

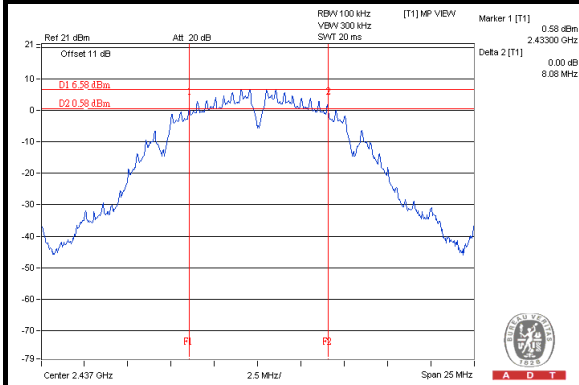

802.11g

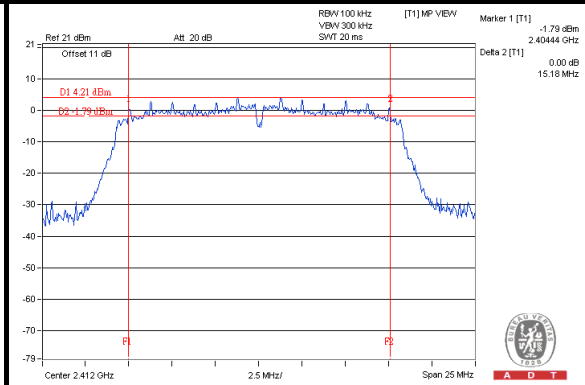

802.11n (20MHz)

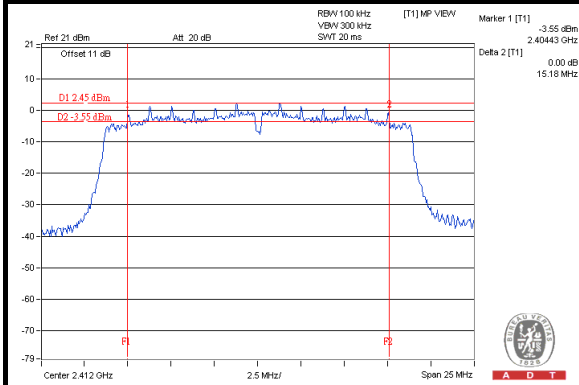

4.4 CONDUCTED OUTPUT POWER

4.4.1 LIMITS OF CONDUCTED OUTPUT POWER MEASUREMENT

For systems using digital modulation in the 2400–2483.5 MHz bands: 1 Watt (30dBm)

4.4.2 TEST SETUP

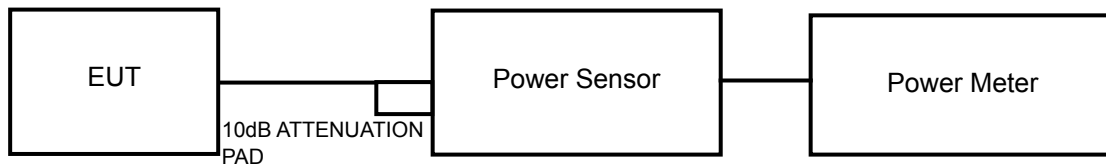

4.4.3 TEST INSTRUMENTS

Refer to section 4.1.2 to get information of above instrument.

4.4.4 TEST PROCEDURES

A peak / average power sensor was used on the output port of the EUT. A power meter was used to read the response of the peak / average power sensor. Record the power level.



A D T

4.4.5 DEVIATION FROM TEST STANDARD

No deviation.

4.4.6 EUT OPERATING CONDITIONS

Same as Item 4.3.6.

4.4.7 TEST RESULTS

FOR PEAK POWER

802.11b

CHANNEL	FREQUENCY (MHz)	PEAK POWER (mW)	PEAK POWER (dBm)	LIMIT (dBm)	PASS/FAIL
1	2412	57.943	17.63	30	PASS
6	2437	60.534	17.82	30	PASS
11	2462	59.566	17.75	30	PASS

802.11g

CHANNEL	FREQUENCY (MHz)	PEAK POWER (mW)	PEAK POWER (dBm)	LIMIT (dBm)	PASS/FAIL
1	2412	217.27	23.37	30	PASS
6	2437	219.786	23.42	30	PASS
11	2462	200.447	23.02	30	PASS

802.11n (20MHz)

CHANNEL	FREQUENCY (MHz)	PEAK POWER (mW)	PEAK POWER (dBm)	LIMIT (dBm)	PASS/FAIL
1	2412	166.341	22.21	30	PASS
6	2437	169.434	22.29	30	PASS
11	2462	164.816	22.17	30	PASS



A D T

FOR AVERAGE POWER

802.11b

CHANNEL	FREQUENCY (MHz)	AVERAGE POWER (mW)	AVERAGE POWER (dBm)
1	2412	28.379	14.53
6	2437	30.549	14.85
11	2462	29.923	14.76

802.11g

CHANNEL	FREQUENCY (MHz)	AVERAGE POWER (mW)	AVERAGE POWER (dBm)
1	2412	31.769	15.02
6	2437	31.046	14.92
11	2462	31.477	14.98

802.11n (20MHz)

CHANNEL	FREQUENCY (MHz)	AVERAGE POWER (mW)	AVERAGE POWER (dBm)
1	2412	19.999	13.01
6	2437	20.654	13.15
11	2462	20.417	13.10

4.5 POWER SPECTRAL DENSITY MEASUREMENT

4.5.1 LIMITS OF POWER SPECTRAL DENSITY MEASUREMENT

The Maximum of Power Spectral Density Measurement is 8dBm.

4.5.2 TEST SETUP

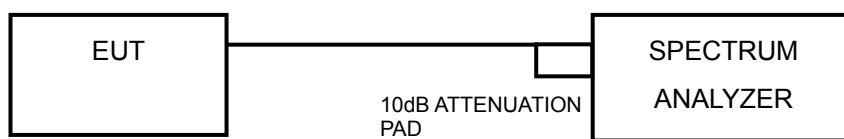

4.5.3 TEST INSTRUMENTS

Refer to section 4.1.2 to get information of above instrument.

4.5.4 TEST PROCEDURE

- a) Set analyzer center frequency to DTS channel center frequency.
- b) Set the span to 1.5 times the DTS bandwidth.
- c) Set the RBW to: $3 \text{ kHz} \leq \text{RBW} \leq 100 \text{ kHz}$.
- d) Set the VBW $\geq 3 \times \text{RBW}$.
- e) Detector = peak.
- f) Sweep time = auto couple.
- g) Trace mode = max hold.
- h) Allow trace to fully stabilize.
- i) Use the peak marker function to determine the maximum amplitude level within the RBW.

4.5.5 DEVIATION FROM TEST STANDARD

No deviation.

4.5.6 EUT OPERATING CONDITION

Same as Item 4.3.6

4.5.7 TEST RESULTS

802.11b

Channel	Freq. (MHz)	PSD (dBm/3kHz)	Limit (dBm/3kHz)	PASS /FAIL
1	2412	-7.84	8	PASS
6	2437	-7.60	8	PASS
11	2462	-7.68	8	PASS

802.11g

Channel	Freq. (MHz)	PSD (dBm/3kHz)	Limit (dBm/3kHz)	PASS /FAIL
1	2412	-10.70	8	PASS
6	2437	-10.59	8	PASS
11	2462	-10.61	8	PASS

802.11n (20MHz)

Channel	Freq. (MHz)	PSD (dBm/3kHz)	Limit (dBm/3kHz)	PASS /FAIL
1	2412	-12.77	8	PASS
6	2437	-12.06	8	PASS
11	2462	-11.92	8	PASS



A D T

SPECTRUM PLOT OF WORST VALUE

802.11b

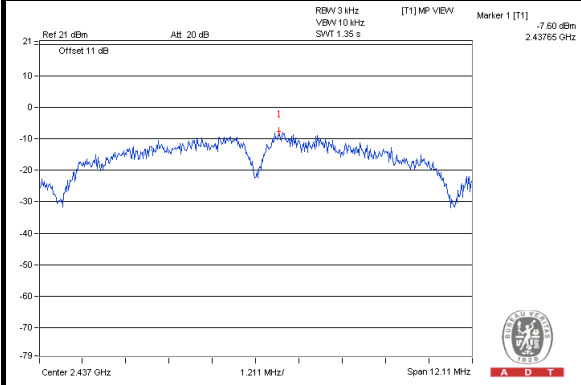

802.11g

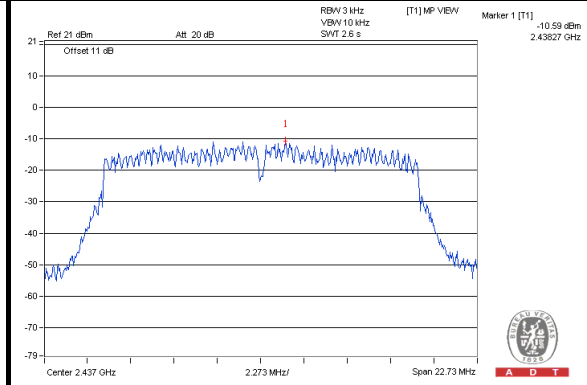

802.11n (20MHz)

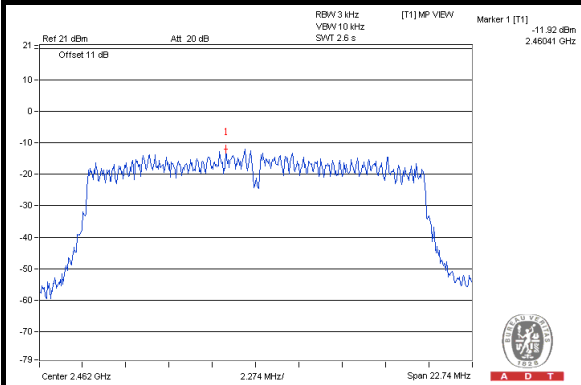

4.6 CONDUCTED OUT OF BAND EMISSION MEASUREMENT

4.6.1 LIMITS OF CONDUCTED OUT OF BAND EMISSION MEASUREMENT

Below -20dB of the highest emission level of operating band (in 100kHz Resolution Bandwidth).

4.6.2 TEST SETUP

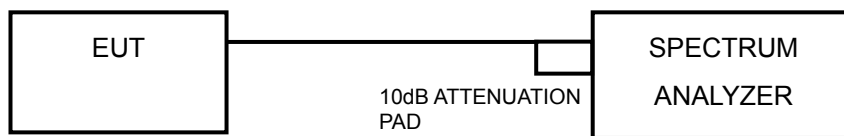

4.6.3 TEST INSTRUMENTS

Refer to section 4.1.2 to get information of above instrument.

4.6.4 TEST PROCEDURE

MEASUREMENT PROCEDURE REF

1. Set the RBW = 100 kHz.
2. Set the VBW \geq 300 kHz.
3. Detector = peak.
4. Sweep time = auto couple.
5. Trace mode = max hold.
6. Allow trace to fully stabilize.
7. Use the peak marker function to determine the maximum power level in any 100 kHz band segment within the fundamental EBW.

MEASUREMENT PROCEDURE OOB

1. Set RBW = 100 kHz.
2. Set VBW \geq 300 kHz.
3. Detector = peak.
4. Sweep = auto couple.
5. Trace Mode = max hold.
6. Allow trace to fully stabilize.
7. Use the peak marker function to determine the maximum amplitude level.

4.6.5 DEVIATION FROM TEST STANDARD

No deviation.

4.6.6 EUT OPERATING CONDITION

Same as Item 4.3.6

4.6.7 TEST RESULTS

The spectrum plots are attached on the following pages. D1 line indicates the highest level, and D2 line indicates the 20dB offset below D1. It shows compliance with the requirement.



A D T

802.11b

CH 1

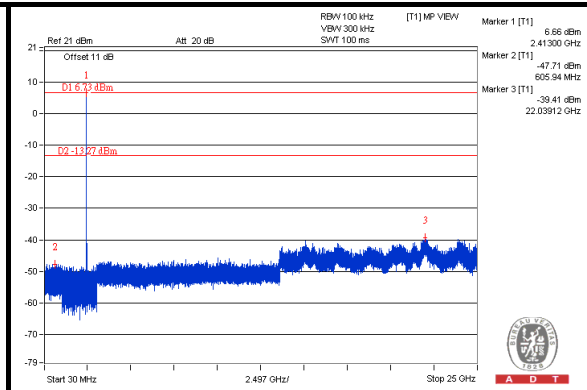
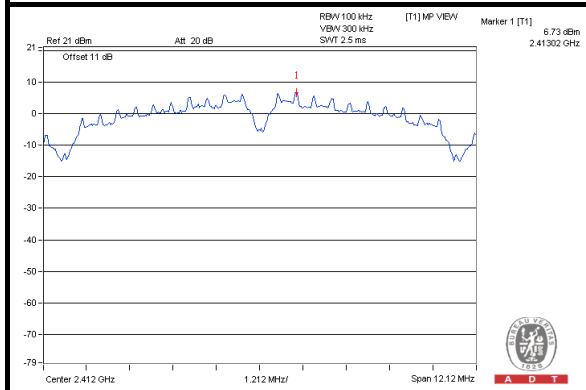

CH 6

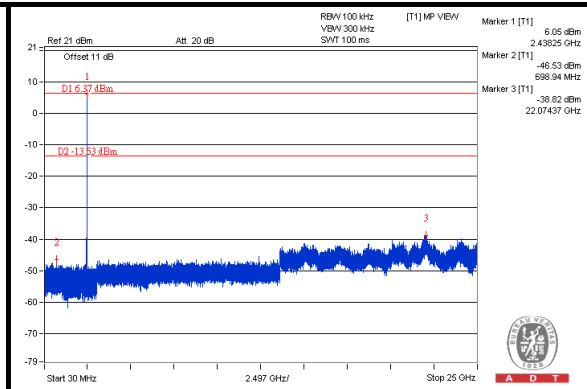
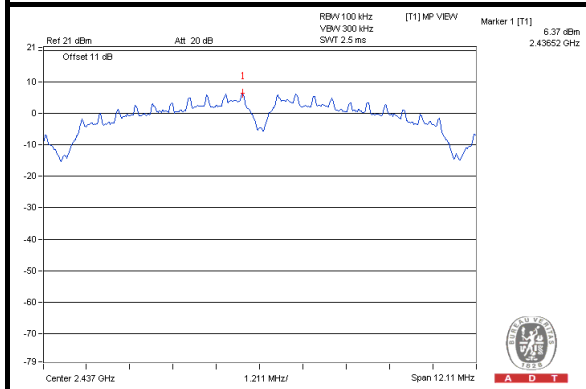

CH 11

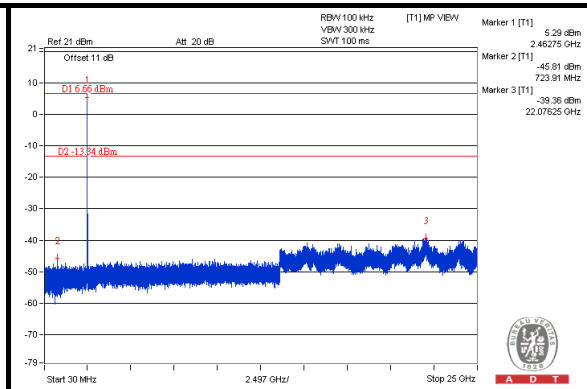
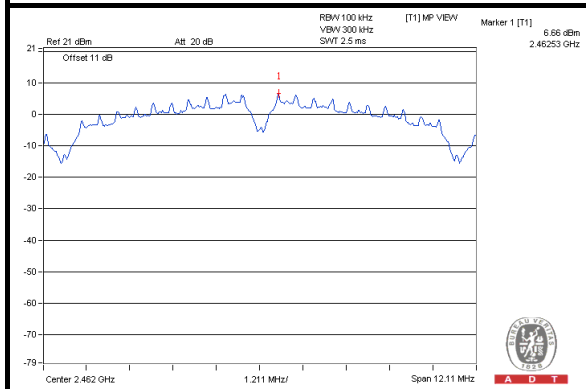

CH 1 Band edge

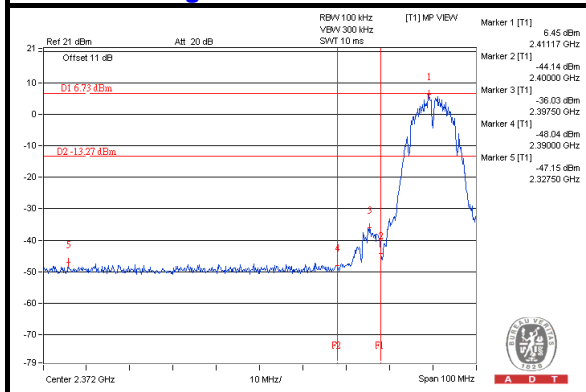

CH 11 Band edge

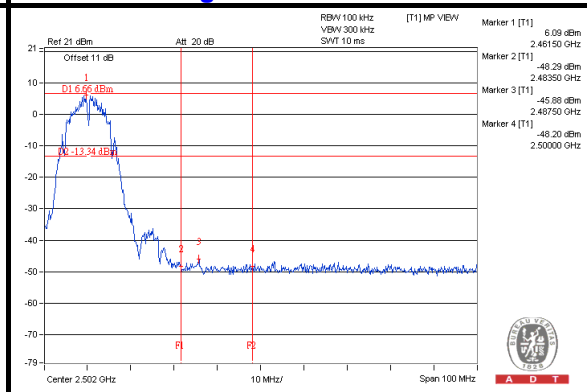



A D T

802.11g

CH 1

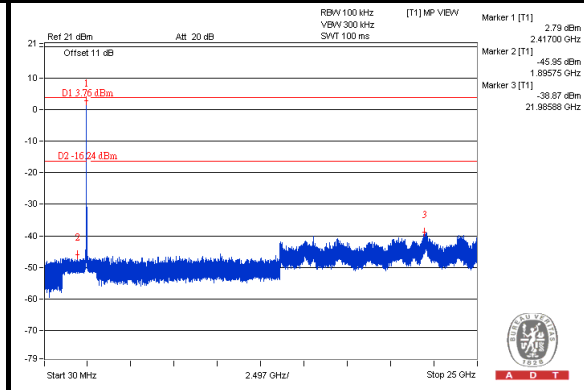
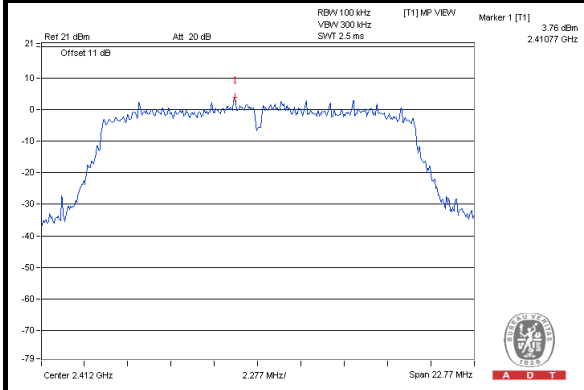

CH 6

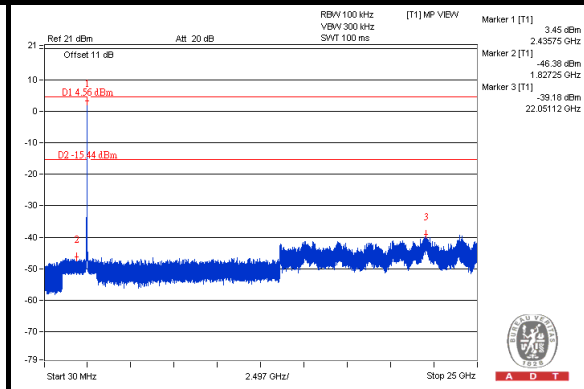
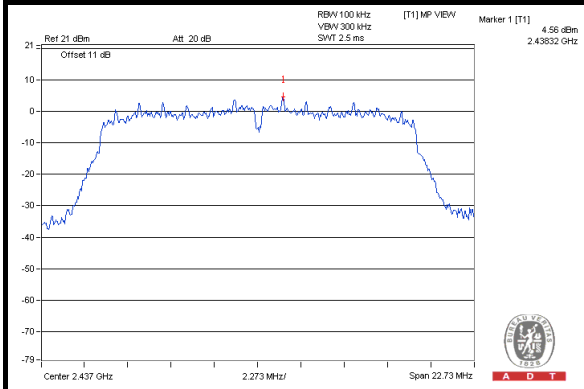

CH 11

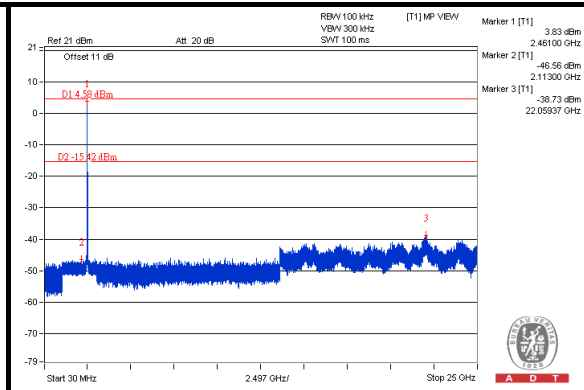
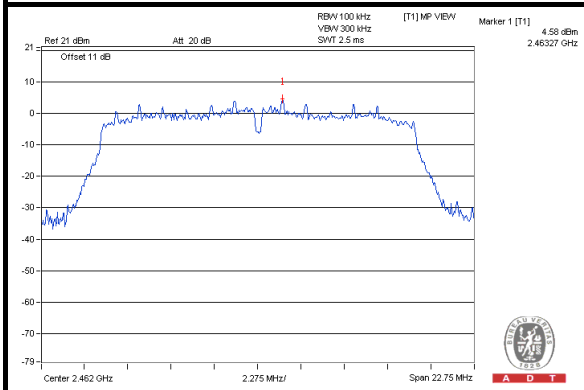

CH 1 Band edge

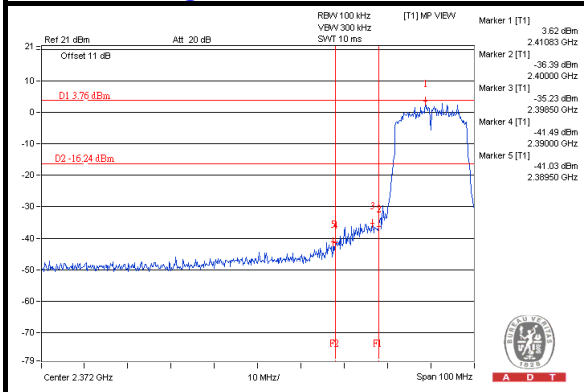

CH 11 Band edge

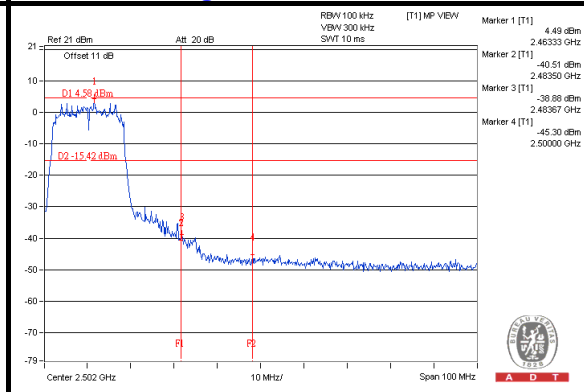



A D T

802.11n (20MHz)

CH 1

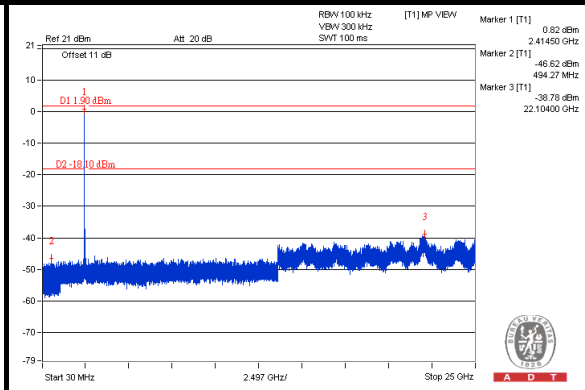
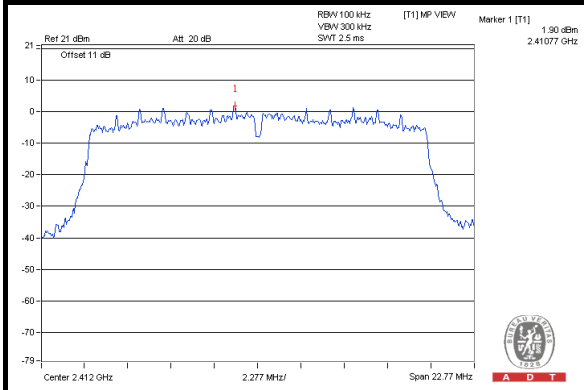

CH 6

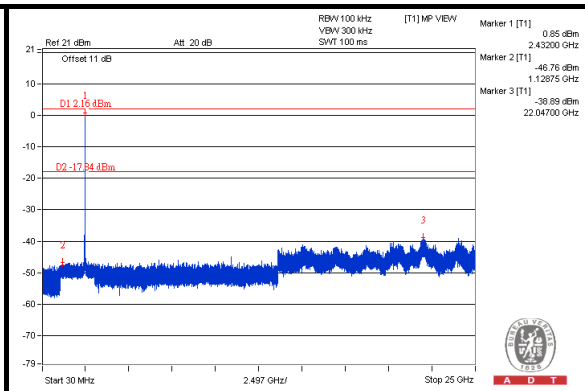
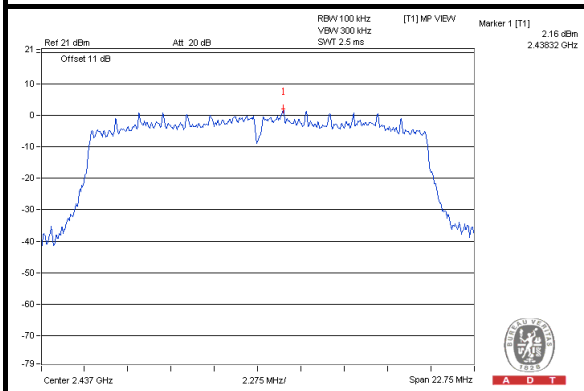

CH 11

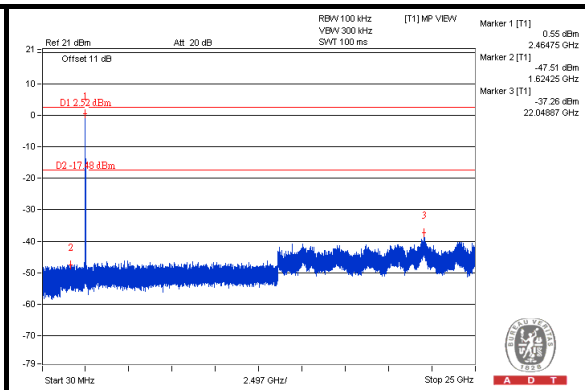
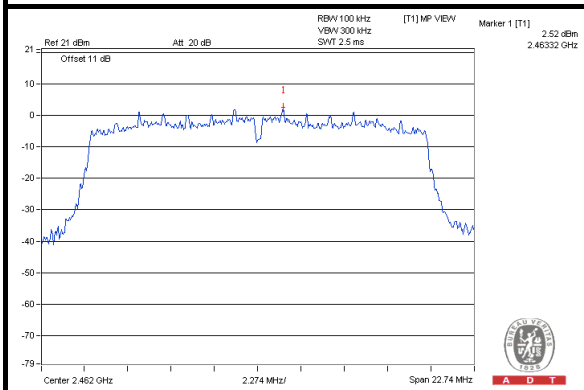

CH 1 Band edge

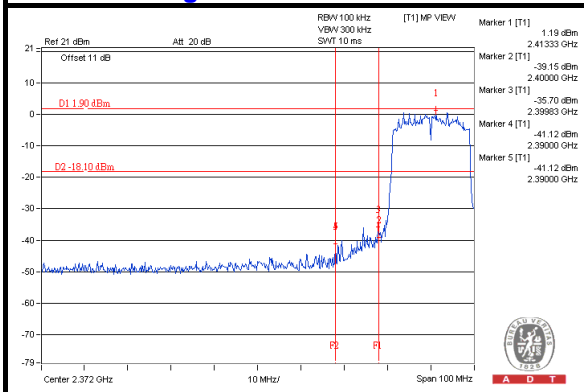

CH 11 Band edge

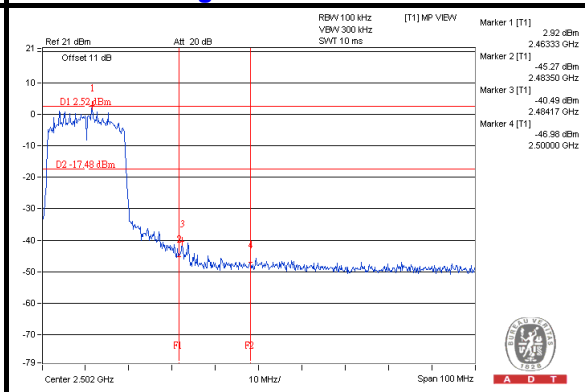



A D T

5. PHOTOGRAPHS OF THE TEST CONFIGURATION

Please refer to the attached file (Test Setup Photo).



6. INFORMATION ON THE TESTING LABORATORIES

We, Bureau Veritas Consumer Products Services (H.K.) Ltd., Taoyuan Branch, were founded in 1988 to provide our best service in EMC, Radio, Telecom and Safety consultation. Our laboratories are accredited and approved according to ISO/IEC 17025.

If you have any comments, please feel free to contact us at the following:

Linko EMC/RF Lab:

Tel: 886-2-26052180

Fax: 886-2-26051924

Hsin Chu EMC/RF/Telecom Lab:

Tel: 886-3-5935343

Fax: 886-3-5935342

Hwa Ya EMC/RF/Safety Lab:

Tel: 886-3-3183232

Fax: 886-3-3270892

Email: service.adt@tw.bureauveritas.com

Web Site: www.bureauveritas-adt.com

The address and road map of all our labs can be found in our web site also.



A D T

7. APPENDIX A – MODIFICATIONS RECORDERS FOR ENGINEERING CHANGES TO THE EUT BY THE LAB

No any modifications are made to the EUT by the lab during the test.

---END---