



FCC TEST REPORT (Bluetooth LE)

REPORT NO.: RF141002C15-2

MODEL NO.: A1408

FCC ID: HLZA1408

RECEIVED: Oct. 02, 2014

TESTED: Oct. 10 ~ Oct. 14, 2014

ISSUED: Oct. 21, 2014

APPLICANT: Acer Incorporated

ADDRESS: 8F., No. 88, Sec. 1, Xintai 5th Rd., Xizhi Dist.,
New Taipei City 221, Taiwan

ISSUED BY: Bureau Veritas Consumer Products Services
(H.K.) Ltd., Taoyuan Branch

LAB ADDRESS: No. 47-2, 14th Ling, Chia Pau Vil., Lin Kou Dist.,
New Taipei City, Taiwan, R.O.C.

TEST LOCATION: No. 19, Hwa Ya 2nd Rd, Wen Hwa Tsuen, Kwei
Shan Hsiang, Taoyuan Hsien 333, Taiwan, R.O.C.

This report should not be used by the client to claim product certification, approval, or endorsement by TAF or any government agencies.



This report is for your exclusive use. Any copying or replication of this report to or for any other person or entity, or use of our name or trademark, is permitted only with our prior written permission. This report sets forth our findings solely with respect to the test samples identified herein. The results set forth in this report are not indicative or representative of the quality or characteristics of the lot from which a test sample was taken or any similar or identical product unless specifically and expressly noted. Our report includes all of the tests requested by you and the results thereof based upon the information that you provided to us. You have 60 days from date of issuance of this report to notify us of any material error or omission caused by our negligence, provided, however, that such notice shall be in writing and shall specifically address the issue you wish to raise. A failure to raise such issue within the prescribed time shall constitute your unqualified acceptance of the completeness of this report, the tests conducted and the correctness of the report contents. Unless specific mention, the uncertainty of measurement has been explicitly taken into account to declare the compliance or non-compliance to the specification

Table of Contents

RELEASE CONTROL RECORD.....	4
1. CERTIFICATION.....	5
2. SUMMARY OF TEST RESULTS.....	6
2.1 MEASUREMENT UNCERTAINTY.....	6
3. GENERAL INFORMATION.....	7
3.1 GENERAL DESCRIPTION OF EUT.....	7
3.2 DESCRIPTION OF TEST MODES.....	8
3.2.1 TEST MODE APPLICABILITY AND TESTED CHANNEL DETAIL.....	9
3.3 DESCRIPTION OF SUPPORT UNITS.....	11
3.3.1 CONFIGURATION OF SYSTEM UNDER TEST.....	11
3.4 GENERAL DESCRIPTION OF APPLIED STANDARDS.....	12
4. TEST TYPES AND RESULTS.....	13
4.1 RADIATED EMISSION AND BANDEDGE MEASUREMENT.....	13
4.1.1 LIMITS OF RADIATED EMISSION AND BANDEDGE MEASUREMENT.....	13
4.1.2 TEST INSTRUMENTS.....	14
4.1.3 TEST PROCEDURES.....	15
4.1.4 DEVIATION FROM TEST STANDARD.....	15
4.1.5 TEST SETUP.....	16
4.1.6 EUT OPERATING CONDITIONS.....	17
4.1.7 TEST RESULTS.....	18
4.2 CONDUCTED EMISSION MEASUREMENT.....	23
4.2.1 LIMITS OF CONDUCTED EMISSION MEASUREMENT.....	23
4.2.2 TEST INSTRUMENTS.....	23
4.2.3 TEST PROCEDURES.....	24
4.2.4 DEVIATION FROM TEST STANDARD.....	24
4.2.5 TEST SETUP.....	25
4.2.6 EUT OPERATING CONDITIONS.....	25
4.2.7 TEST RESULTS.....	26
4.3 6dB BANDWIDTH MEASUREMENT.....	30
4.3.1 LIMITS OF 6dB BANDWIDTH MEASUREMENT.....	30
4.3.2 TEST SETUP.....	30
4.3.3 TEST INSTRUMENTS.....	30
4.3.4 TEST PROCEDURE.....	30
4.3.5 DEVIATION FROM TEST STANDARD.....	30
4.3.6 EUT OPERATING CONDITIONS.....	30
4.3.7 TEST RESULTS.....	31
4.4 CONDUCTED OUTPUT POWER.....	32
4.4.1 LIMITS OF CONDUCTED OUTPUT POWER MEASUREMENT.....	32
4.4.2 TEST SETUP.....	32
4.4.3 TEST INSTRUMENTS.....	32
4.4.4 TEST PROCEDURES.....	32
4.4.5 DEVIATION FROM TEST STANDARD.....	32
4.4.6 EUT OPERATING CONDITIONS.....	32
4.4.7 TEST RESULTS.....	32
4.5 POWER SPECTRAL DENSITY MEASUREMENT.....	33
4.5.1 LIMITS OF POWER SPECTRAL DENSITY MEASUREMENT.....	33
4.5.2 TEST SETUP.....	33



4.5.3	TEST INSTRUMENTS	33
4.5.4	TEST PROCEDURE	33
4.5.5	DEVIATION FROM TEST STANDARD	33
4.5.6	EUT OPERATING CONDITION	33
4.5.7	TEST RESULTS	34
4.6	CONDUCTED OUT OF BAND EMISSION MEASUREMENT	35
4.6.1	LIMITS OF OUT OF BAND EMISSION MEASUREMENT	35
4.6.2	TEST SETUP	35
4.6.3	TEST INSTRUMENTS	35
4.6.4	TEST PROCEDURE	36
4.6.5	DEVIATION FROM TEST STANDARD	36
4.6.6	EUT OPERATING CONDITION	36
4.6.7	TEST RESULTS	36
4.6.8	TEST RESULTS	37
5.	PHOTOGRAPHS OF THE TEST CONFIGURATION	38
6.	INFORMATION ON THE TESTING LABORATORIES	39
7.	APPENDIX A - MODIFICATIONS RECORDERS FOR ENGINEERING CHANGES TO THE EUT BY THE LAB	40



RELEASE CONTROL RECORD

ISSUE NO.	REASON FOR CHANGE	DATE ISSUED
RF141002C15-2	Original release	Oct. 21, 2014



1. CERTIFICATION

PRODUCT: Tablet Computer
MODEL NO.: A1408
BRAND: Acer
APPLICANT: Acer Incorporated
TESTED: Oct. 10 ~ Oct. 14, 2014
TEST SAMPLE: ENGINEERING SAMPLE
STANDARDS: **FCC Part 15, Subpart C (Section 15.247)**
ANSI C63.10-2009

The above equipment (model: A1408) has been tested by **Bureau Veritas Consumer Products Services (H.K.) Ltd., Taoyuan Branch**, and found compliance with the requirement of the above standards. The test record, data evaluation & Equipment Under Test (EUT) configurations represented herein are true and accurate accounts of the measurements of the sample's EMC characteristics under the conditions specified in this report.

PREPARED BY : Ivy Lin , **DATE** : Oct. 21, 2014
Ivy Lin / Specialist

APPROVED BY : Ken Liu , **DATE** : Oct. 21, 2014
Ken Liu / Senior Manager

2. SUMMARY OF TEST RESULTS

The EUT has been tested according to the following specifications:

APPLIED STANDARD: FCC PART 15, SUBPART C (SECTION 15.247)			
STANDARD SECTION	TEST TYPE AND LIMIT	RESULT	REMARK
15.207	AC Power Conducted Emission	PASS	Meet the requirement of limit. Minimum passing margin is -11.57dB at 2.57813MHz.
15.205 & 209	Radiated Emissions	PASS	Meet the requirement of limit. Minimum passing margin is -7.1dB at 2483.50MHz.
15.247(d)	Band Edge Measurement	PASS	Meet the requirement of limit. Minimum passing margin is -7.1dB at 2483.50MHz.
15.247(d)	Antenna Port Emission	PASS	Meet the requirement of limit.
15.247(a)(2)	6dB bandwidth	PASS	Meet the requirement of limit.
15.247(b)	Conducted power	PASS	Meet the requirement of limit.
15.247(e)	Power Spectral Density	PASS	Meet the requirement of limit.
15.203	Antenna Requirement	PASS	Antenna connector is IPEX MHF 4L not a standard connector.

2.1 MEASUREMENT UNCERTAINTY

Where relevant, the following measurement uncertainty levels have been estimated for tests performed on the EUT as specified in CISPR 16-4-2:

MEASUREMENT	FREQUENCY	UNCERTAINTY
Conducted emission	150kHz ~ 30MHz	2.44 dB
Radiated emissions	30MHz ~ 200MHz	3.86 dB
	200MHz ~ 1000MHz	3.87 dB
	1GHz ~ 18GHz	2.29 dB
	18GHz ~ 40GHz	2.29 dB

This uncertainty represents an expanded uncertainty expressed at approximately the 95% confidence level using a coverage factor of k=2.

3. GENERAL INFORMATION

3.1 GENERAL DESCRIPTION OF EUT

EUT	Tablet Computer
MODEL NO.	A1408
POWER SUPPLY	3.8Vdc (Battery) 5.2 or 5.35Vdc (Adapter) 5.0Vdc (Host equipment)
MODULATION TYPE	GFSK
TRANSFER RATE	1Mbps
OPERATING FREQUENCY	2402 ~ 2480MHz
NUMBER OF CHANNEL	40
CHANNEL SPACING	2MHz
OUTPUT POWER	3.404mW
ANTENNA TYPE	PIFA antenna with 3.90dBi gain
ANTENNA CONNECTOR	IPEX MHF 4L
DATA CABLE	1.2m non-shielded USB cable without core
I/O PORTS	Refer to user's manual
ACCESSORY DEVICES	Adapter, Battery

NOTE:

1. The EUT consumes power from the following battery & adapter.

Battery	
BRAND:	LGC
MODEL:	AP14E8K
RATING:	3.8Vdc

ADAPTER 1	
BRAND:	LITEON
MODEL:	PA-1070-07
INPUT:	100-240Vac, 50/60Hz, 0.25A
OUTPUT:	5.2Vdc, 1.35A LPS

ADAPTER 2	
BRAND:	DELTA Electronics, INC.
MODEL:	ADP-10HW A
INPUT:	100-240Vac, 50-60Hz, 0.4A
OUTPUT:	5.35Vdc, 2A

* Adapter 2 was the worst for the final tests.

2. The above EUT information is declared by manufacturer and for more detailed features description, please refer to the manufacturer's specifications or User's Manual.

3.2 DESCRIPTION OF TEST MODES

40 channels are provided to this EUT:

CHANNEL	FREQ. (MHz)	CHANNEL	FREQ. (MHz)	CHANNEL	FREQ. (MHz)	CHANNEL	FREQ. (MHz)
0	2402	10	2422	20	2442	30	2462
1	2404	11	2424	21	2444	31	2464
2	2406	12	2426	22	2446	32	2466
3	2408	13	2428	23	2448	33	2468
4	2410	14	2430	24	2450	34	2470
5	2412	15	2432	25	2452	35	2472
6	2414	16	2434	26	2454	36	2474
7	2416	17	2436	27	2456	37	2476
8	2418	18	2438	28	2458	38	2478
9	2420	19	2440	29	2460	39	2480

3.2.1 TEST MODE APPLICABILITY AND TESTED CHANNEL DETAIL

EUT CONFIGURE MODE	APPLICABLE TO				DESCRIPTION
	RE \geq 1G	RE $<$ 1G	PLC	APCM	
A	-	√	√	-	Power from adapter 1
B	√	√	√	√	Power from adapter 2

Where **RE \geq 1G**: Radiated Emission above 1GHz **RE $<$ 1G**: Radiated Emission below 1GHz
PLC: Power Line Conducted Emission **APCM**: Antenna Port Conducted Measurement

NOTE:

1. The EUT had been pre-tested on the positioned of each 3 axis. The worst case was found when positioned on **Y-plane**.
2. "-" means no effect.

RADIATED EMISSION TEST (ABOVE 1GHz):

- Pre-Scan has been conducted to determine the worst-case mode from all possible combinations between available modulations and antenna ports (if EUT with antenna diversity architecture).
- Following channel(s) was (were) selected for the final test as listed below.

EUT CONFIGURE MODE	AVAILABLE CHANNEL	TESTED CHANNEL	MODULATION TYPE	DATA RATE (Mbps)
B	0 to 39	0, 19, 39	GFSK	1.0

RADIATED EMISSION TEST (BELOW 1GHz):

- Pre-Scan has been conducted to determine the worst-case mode from all possible combinations between available modulations and antenna ports (if EUT with antenna diversity architecture).
- Following channel(s) was (were) selected for the final test as listed below.

EUT CONFIGURE MODE	AVAILABLE CHANNEL	TESTED CHANNEL	MODULATION TYPE	DATA RATE (Mbps)
A, B	0 to 39	0	GFSK	1.0

POWER LINE CONDUCTED EMISSION TEST:

- Pre-Scan has been conducted to determine the worst-case mode from all possible combinations between available modulations and antenna ports (if EUT with antenna diversity architecture).
- Following channel(s) was (were) selected for the final test as listed below.

EUT CONFIGURE MODE	AVAILABLE CHANNEL	TESTED CHANNEL	MODULATION TYPE	DATA RATE (Mbps)
A, B	0 to 39	0	GFSK	1.0

ANTENNA PORT CONDUCTED MEASUREMENT:

- Pre-Scan has been conducted to determine the worst-case mode from all possible combinations between available modulations, data rates and antenna ports (if EUT with antenna diversity architecture).
- Following channel(s) was (were) selected for the final test as listed below.

EUT CONFIGURE MODE	AVAILABLE CHANNEL	TESTED CHANNEL	MODULATION TYPE	DATA RATE (Mbps)
B	0 to 39	0, 19, 39	GFSK	1.0

TEST CONDITION:

APPLICABLE TO	ENVIRONMENTAL CONDITIONS	INPUT POWER	TESTED BY
RE \geq 1G	21deg. C, 71%RH	120Vac, 60Hz	Nick Hsu
RE $<$ 1G	21deg. C, 71%RH	120Vac, 60Hz	Nick Hsu
PLC	18deg. C, 72%RH, 23deg. C, 69%RH	120Vac, 60Hz	Nick Hsu
APCM	25deg. C, 60%RH	120Vac, 60Hz	Nick Chen

3.3 DESCRIPTION OF SUPPORT UNITS

The EUT has been tested as an independent unit.

3.3.1 CONFIGURATION OF SYSTEM UNDER TEST

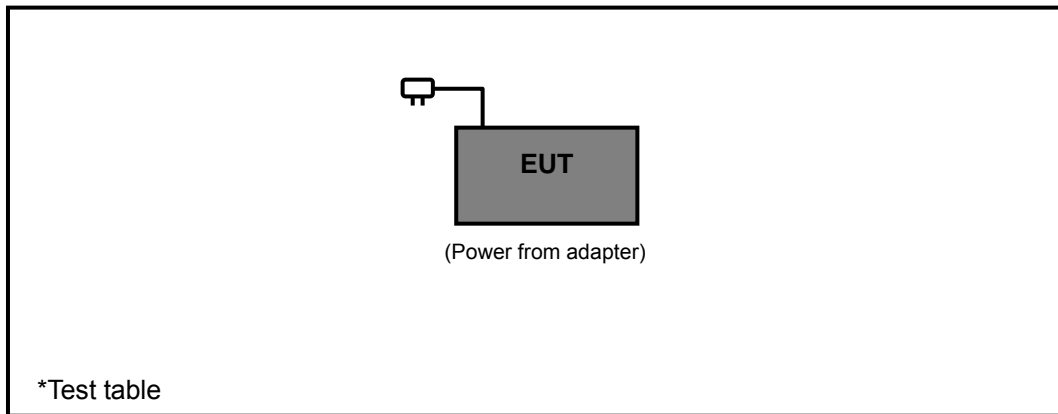

3.4 GENERAL DESCRIPTION OF APPLIED STANDARDS

The EUT is a RF Product. According to the specifications of the manufacturer, it must comply with the requirements of the following standards:

FCC Part 15, Subpart C (15.247)
558074 D01 DTS Meas Guidance v03r02
ANSI C63.10-2009

All test items have been performed and recorded as per the above standards.

NOTE: The EUT is also considered as a kind of computer peripheral, because the connection to computer is necessary for typical use. It has been verified to comply with the requirements of FCC Part 15, Subpart B, Class B (DoC). The test report has been issued separately.

4. TEST TYPES AND RESULTS

4.1 RADIATED EMISSION AND BANDEDGE MEASUREMENT

4.1.1 LIMITS OF RADIATED EMISSION AND BANDEDGE MEASUREMENT

Radiated emissions which fall in the restricted bands must comply with the radiated emission limits specified as below table. Other emissions shall be at least 20dB below the highest level of the desired power:

FREQUENCIES (MHz)	FIELD STRENGTH (microvolts/meter)	MEASUREMENT DISTANCE (meters)
0.009 ~ 0.490	2400/F(kHz)	300
0.490 ~ 1.705	24000/F(kHz)	30
1.705 ~ 30.0	30	30
30 ~ 88	100	3
88 ~ 216	150	3
216 ~ 960	200	3
Above 960	500	3

NOTE:

1. The lower limit shall apply at the transition frequencies.
2. Emission level (dBuV/m) = 20 log Emission level (uV/m).
3. For frequencies above 1000MHz, the field strength limits are based on average detector, however, the peak field strength of any emission shall not exceed the maximum permitted average limits, specified above by more than 20dB under any condition of modulation.



4.1.2 TEST INSTRUMENTS

DESCRIPTION & MANUFACTURER	MODEL NO.	SERIAL NO.	DATE OF CALIBRATION	DUE DATE OF CALIBRATION
Test Receiver ROHDE & SCHWARZ	ESIB7	100187	Jan. 02, 2014	Jan. 01, 2015
Spectrum Analyzer ROHDE & SCHWARZ	FSP40	100039	Mar. 03, 2014	Mar. 02, 2015
BILOG Antenna SCHWARZBECK	VULB9168	9168-160	Feb. 26, 2014	Feb. 25, 2015
HORN Antenna SCHWARZBECK	9120D	209	Aug. 25, 2014	Aug. 24, 2015
HORN Antenna SCHWARZBECK	BBHA 9170	BBHA9170241	Feb. 17, 2014	Feb. 16, 2015
Preamplifier Agilent	8447D	2944A10633	Oct. 07, 2014	Oct. 05, 2015
Preamplifier Agilent	8449B	3008A01964	Aug. 22, 2014	Aug. 21, 2015
RF signal cable HUBER+SUHNNER	SUCOFLEX 104	214378/4	Aug. 22, 2014	Aug. 21, 2015
RF signal cable HUBER+SUHNNER	SUCOFLEX 106	12738/6 +309224/4	Aug. 22, 2014	Aug. 21, 2015
Software BV ADT	ADT_Radiated_ V7.6.15.9.4	NA	NA	NA
Antenna Tower inn-co GmbH	MA 4000	013303	NA	NA
Antenna Tower Controller inn-co GmbH	CO2000	017303	NA	NA
Turn Table BV ADT	TT100	TT93021703	NA	NA
Turn Table Controller BV ADT	SC100	SC93021703	NA	NA
High Speed Peak Power Meter	ML2495A	0824011	Jul. 26, 2014	Jul. 25, 2015
Power Sensor	MA2411B	0738171	Jul. 26, 2014	Jul. 25, 2015

- NOTE:**
1. The calibration interval of the above test instruments is 12 months and the calibrations are traceable to NML/ROC and NIST/USA.
 2. The calibration interval of the loop antenna is 24 months and the calibrations are traceable to NML/ROC and NIST/USA.
 2. The test was performed in HwaYa Chamber 3.
 3. The horn antenna and HP preamplifier (model: 8449B) are used only for the measurement of emission frequency above 1GHz if tested.
 4. The FCC Site Registration No. is 988962.
 5. The IC Site Registration No. is IC 7450F-3.

4.1.3 TEST PROCEDURES

- a. The EUT was placed on the top of a rotating table 0.8 meters above the ground at a 3 meter semi-anechoic chamber. The table was rotated 360 degrees to determine the position of the highest radiation.
- b. The EUT was set 3 meters away from the interference-receiving antenna, which was mounted on the top of a variable-height antenna tower.
- c. The antenna is a broadband antenna, and its height is varied from one meter to four meters above the ground to determine the maximum value of the field strength. Both horizontal and vertical polarizations of the antenna are set to make the measurement.
- d. For each suspected emission, the EUT was arranged to its worst case and then the antenna was tuned to heights from 1 meter to 4 meters and the rotatable table was turned from 0 degrees to 360 degrees to find the maximum reading.
- e. The test-receiver system was set to Peak Detect Function and Specified Bandwidth with Maximum Hold Mode.
- f. If the emission level of the EUT in peak mode was lower than the limit specified, then testing could be stopped and the peak values of the EUT would be reported. Otherwise the emissions would be re-tested one by one using peak, quasi-peak or average method as specified and then reported in a data sheet.

NOTE:

1. The resolution bandwidth and video bandwidth of test receiver/spectrum analyzer is 120kHz for Quasi-peak detection at frequency below 1GHz.
2. The resolution bandwidth of test receiver/spectrum analyzer is 1 MHz and video bandwidth is 3MHz for Peak detection at frequency above 1GHz.
3. The resolution bandwidth of test receiver/spectrum analyzer is 1MHz and the video bandwidth is $\geq 1/T$ (Duty cycle < 98%) or 10Hz(Duty cycle > 98%) for Average detection (AV) at frequency above 1GHz.
4. All modes of operation were investigated and the worst-case emissions are reported.

4.1.4 DEVIATION FROM TEST STANDARD

No deviation.

4.1.5 TEST SETUP

Frequency range 30MHz~1GHz

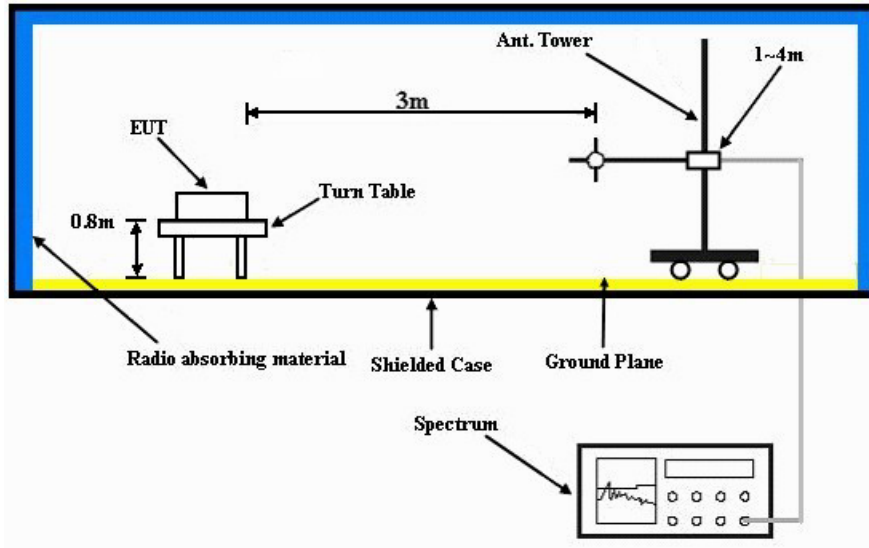

Frequency range above 1GHz

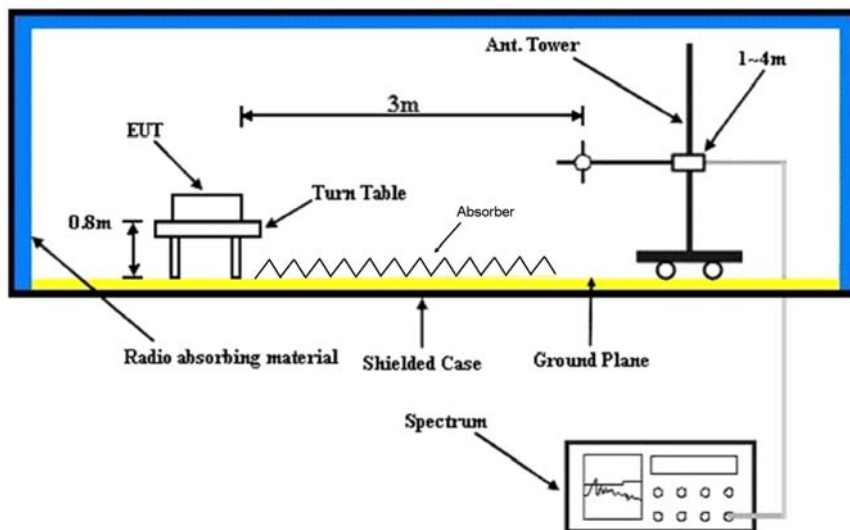

For the actual test configuration, please refer to the attached file (Test Setup Photo).

4.1.6 EUT OPERATING CONDITIONS

Set the EUT under transmission condition continuously at specific channel frequency

4.1.7 TEST RESULTS

ABOVE 1GHz WORST-CASE DATA :

CHANNEL	TX Channel 0	DETECTOR FUNCTION	Peak (PK)
FREQUENCY RANGE	1GHz ~ 25GHz		Average (AV)

ANTENNA POLARITY & TEST DISTANCE: HORIZONTAL AT 3 M								
NO.	FREQ. (MHz)	EMISSION LEVEL (dBuV/m)	LIMIT (dBuV/m)	MARGIN (dB)	ANTENNA HEIGHT (m)	TABLE ANGLE (Degree)	RAW VALUE (dBuV)	CORRECTION FACTOR (dB/m)
1	2390.00	56.4 PK	74.0	-17.6	1.09 H	247	23.20	33.20
2	2390.00	45.8 AV	54.0	-8.2	1.09 H	247	12.60	33.20
3	*2402.00	103.0 PK			1.00 H	38	69.70	33.30
4	*2402.00	101.9 AV			1.00 H	38	68.60	33.30
5	4804.00	47.0 PK	74.0	-27.0	1.14 H	246	41.00	6.00
6	4804.00	34.7 AV	54.0	-19.3	1.14 H	246	28.70	6.00
ANTENNA POLARITY & TEST DISTANCE: VERTICAL AT 3 M								
NO.	FREQ. (MHz)	EMISSION LEVEL (dBuV/m)	LIMIT (dBuV/m)	MARGIN (dB)	ANTENNA HEIGHT (m)	TABLE ANGLE (Degree)	RAW VALUE (dBuV)	CORRECTION FACTOR (dB/m)
1	2390.00	57.6 PK	74.0	-16.4	1.15 V	226	24.40	33.20
2	2390.00	45.7 AV	54.0	-8.3	1.15 V	226	12.50	33.20
3	*2402.00	100.8 PK			1.78 V	69	67.50	33.30
4	*2402.00	99.5 AV			1.78 V	69	66.20	33.30
5	4804.00	47.1 PK	74.0	-26.9	1.05 V	278	41.10	6.00
6	4804.00	34.5 AV	54.0	-19.5	1.05 V	278	28.50	6.00

REMARKS:

1. Emission Level(dBuV/m) = Raw Value(dBuV) + Correction Factor(dB/m)
2. Correction Factor(dB/m) = Antenna Factor(dB/m) + Cable Factor(dB)
– Pre-Amplifier Factor(dB)
3. The other emission levels were very low against the limit.
4. Margin value = Emission Level – Limit value
5. " * ": Fundamental frequency.



CHANNEL	TX Channel 19	DETECTOR FUNCTION	Peak (PK)
FREQUENCY RANGE	1GHz ~ 25GHz		Average (AV)

ANTENNA POLARITY & TEST DISTANCE: HORIZONTAL AT 3 M								
NO.	FREQ. (MHz)	EMISSION LEVEL (dBuV/m)	LIMIT (dBuV/m)	MARGIN (dB)	ANTENNA HEIGHT (m)	TABLE ANGLE (Degree)	RAW VALUE (dBuV)	CORRECTION FACTOR (dB/m)
1	*2440.00	102.1 PK			1.03 H	169	68.70	33.40
2	*2440.00	100.7 AV			1.03 H	169	67.30	33.40
3	4880.00	47.1 PK	74.0	-26.9	1.11 H	69	41.00	6.10
4	4880.00	35.0 AV	54.0	-19.0	1.11 H	69	28.90	6.10

ANTENNA POLARITY & TEST DISTANCE: VERTICAL AT 3 M								
NO.	FREQ. (MHz)	EMISSION LEVEL (dBuV/m)	LIMIT (dBuV/m)	MARGIN (dB)	ANTENNA HEIGHT (m)	TABLE ANGLE (Degree)	RAW VALUE (dBuV)	CORRECTION FACTOR (dB/m)
1	*2440.00	99.2 PK			1.51 V	70	65.80	33.40
2	*2440.00	97.7 AV			1.51 V	70	64.30	33.40
3	4880.00	46.7 PK	74.0	-27.3	1.03 V	98	40.60	6.10
4	4880.00	35.1 AV	54.0	-18.9	1.03 V	98	29.00	6.10

REMARKS:

1. Emission Level(dBuV/m) = Raw Value(dBuV) + Correction Factor(dB/m)
2. Correction Factor(dB/m) = Antenna Factor(dB/m) + Cable Factor(dB)
– Pre-Amplifier Factor(dB)
3. The other emission levels were very low against the limit.
4. Margin value = Emission Level – Limit value
5. " * ": Fundamental frequency.



CHANNEL	TX Channel 39	DETECTOR FUNCTION	Peak (PK)
FREQUENCY RANGE	1GHz ~ 25GHz		Average (AV)

ANTENNA POLARITY & TEST DISTANCE: HORIZONTAL AT 3 M								
NO.	FREQ. (MHz)	EMISSION LEVEL (dBuV/m)	LIMIT (dBuV/m)	MARGIN (dB)	ANTENNA HEIGHT (m)	TABLE ANGLE (Degree)	RAW VALUE (dBuV)	CORRECTION FACTOR (dB/m)
1	*2480.00	100.2 PK			1.00 H	37	66.80	33.40
2	*2480.00	99.2 AV			1.00 H	37	65.80	33.40
3	2483.50	57.1 PK	74.0	-16.9	1.17 H	84	23.70	33.40
4	2483.50	46.9 AV	54.0	-7.1	1.17 H	84	13.50	33.40
5	4960.00	47.9 PK	74.0	-26.1	1.13 H	153	41.50	6.40
6	4960.00	35.2 AV	54.0	-18.8	1.13 H	153	28.80	6.40
ANTENNA POLARITY & TEST DISTANCE: VERTICAL AT 3 M								
NO.	FREQ. (MHz)	EMISSION LEVEL (dBuV/m)	LIMIT (dBuV/m)	MARGIN (dB)	ANTENNA HEIGHT (m)	TABLE ANGLE (Degree)	RAW VALUE (dBuV)	CORRECTION FACTOR (dB/m)
1	*2480.00	98.8 PK			1.00 V	81	65.40	33.40
2	*2480.00	97.8 AV			1.00 V	81	64.40	33.40
3	2483.50	57.3 PK	74.0	-16.7	1.03 V	132	23.90	33.40
4	2483.50	46.6 AV	54.0	-7.4	1.03 V	132	13.20	33.40
5	4960.00	47.5 PK	74.0	-26.5	1.02 V	271	41.10	6.40
6	4960.00	34.9 AV	54.0	-19.1	1.02 V	271	28.50	6.40

REMARKS:

1. Emission Level(dBuV/m) = Raw Value(dBuV) + Correction Factor(dB/m)
2. Correction Factor(dB/m) = Antenna Factor(dB/m) + Cable Factor(dB)
– Pre-Amplifier Factor(dB)
3. The other emission levels were very low against the limit.
4. Margin value = Emission Level – Limit value
5. " * ": Fundamental frequency.

BELOW 1GHz WORST-CASE DATA :

CHANNEL	TX Channel 0	DETECTOR FUNCTION	Quasi-Peak (QP)
FREQUENCY RANGE	30MHz ~ 1GHz		
TEST MODE	A		

ANTENNA POLARITY & TEST DISTANCE: HORIZONTAL AT 3 M								
NO.	FREQ. (MHz)	EMISSION LEVEL (dBuV/m)	LIMIT (dBuV/m)	MARGIN (dB)	ANTENNA HEIGHT (m)	TABLE ANGLE (Degree)	RAW VALUE (dBuV)	CORRECTION FACTOR (dB/m)
1	57.12	31.2 QP	40.0	-8.8	1.99 H	11	45.70	-14.50
2	136.84	22.2 QP	43.5	-21.3	1.99 H	281	36.80	-14.60
3	206.83	24.9 QP	43.5	-18.6	1.00 H	249	41.30	-16.40
4	414.87	24.8 QP	46.0	-21.2	1.00 H	14	34.70	-9.90
5	622.91	34.7 QP	46.0	-11.3	1.49 H	352	40.10	-5.40
6	830.95	29.5 QP	46.0	-16.5	1.99 H	11	30.80	-1.30

ANTENNA POLARITY & TEST DISTANCE: VERTICAL AT 3 M								
NO.	FREQ. (MHz)	EMISSION LEVEL (dBuV/m)	LIMIT (dBuV/m)	MARGIN (dB)	ANTENNA HEIGHT (m)	TABLE ANGLE (Degree)	RAW VALUE (dBuV)	CORRECTION FACTOR (dB/m)
1	29.90	28.8 QP	40.0	-11.2	1.01 V	269	44.70	-15.90
2	57.12	29.6 QP	40.0	-10.4	1.01 V	16	44.10	-14.50
3	80.45	24.5 QP	40.0	-15.5	1.01 V	158	43.10	-18.60
4	136.84	17.2 QP	43.5	-26.3	2.00 V	217	31.80	-14.60
5	206.83	18.3 QP	43.5	-25.2	1.01 V	63	34.70	-16.40
6	622.91	28.5 QP	46.0	-17.5	1.01 V	314	33.90	-5.40

REMARKS:

1. Emission Level(dBuV/m) = Raw Value(dBuV) + Correction Factor(dB/m)
2. Correction Factor(dB/m) = Antenna Factor(dB/m) + Cable Factor(dB) – Pre-Amplifier Factor(dB)
3. The other emission levels were very low against the limit.
4. Margin value = Emission Level – Limit value



A D T

CHANNEL	TX Channel 0	DETECTOR FUNCTION	Quasi-Peak (QP)
FREQUENCY RANGE	30MHz ~ 1GHz		
TEST MODE	B		

ANTENNA POLARITY & TEST DISTANCE: HORIZONTAL AT 3 M								
NO.	FREQ. (MHz)	EMISSION LEVEL (dBuV/m)	LIMIT (dBuV/m)	MARGIN (dB)	ANTENNA HEIGHT (m)	TABLE ANGLE (Degree)	RAW VALUE (dBuV)	CORRECTION FACTOR (dB/m)
1	57.12	32.7 QP	40.0	-7.3	2.00 H	299	47.20	-14.50
2	70.73	26.2 QP	40.0	-13.8	1.50 H	181	42.40	-16.20
3	167.94	27.7 QP	43.5	-15.8	1.50 H	260	41.70	-14.00
4	206.83	28.8 QP	43.5	-14.7	1.01 H	148	45.20	-16.40
5	280.71	27.6 QP	46.0	-18.4	1.01 H	45	40.10	-12.50
6	622.91	34.5 QP	46.0	-11.5	1.50 H	345	39.90	-5.40
ANTENNA POLARITY & TEST DISTANCE: VERTICAL AT 3 M								
NO.	FREQ. (MHz)	EMISSION LEVEL (dBuV/m)	LIMIT (dBuV/m)	MARGIN (dB)	ANTENNA HEIGHT (m)	TABLE ANGLE (Degree)	RAW VALUE (dBuV)	CORRECTION FACTOR (dB/m)
1	33.79	30.5 QP	40.0	-9.5	1.00 V	103	46.20	-15.70
2	57.12	28.9 QP	40.0	-11.1	1.00 V	14	43.40	-14.50
3	76.56	25.8 QP	40.0	-14.2	1.49 V	10	43.40	-17.60
4	142.67	21.3 QP	43.5	-22.2	1.00 V	296	35.50	-14.20
5	169.89	21.2 QP	43.5	-22.3	1.99 V	220	35.10	-13.90
6	206.83	25.0 QP	43.5	-18.5	1.49 V	228	41.40	-16.40

REMARKS:

1. Emission Level(dBuV/m) = Raw Value(dBuV) + Correction Factor(dB/m)
2. Correction Factor(dB/m) = Antenna Factor(dB/m) + Cable Factor(dB) – Pre-Amplifier Factor(dB)
3. The other emission levels were very low against the limit.
4. Margin value = Emission Level – Limit value

4.2 CONDUCTED EMISSION MEASUREMENT

4.2.1 LIMITS OF CONDUCTED EMISSION MEASUREMENT

FREQUENCY OF EMISSION (MHz)	CONDUCTED LIMIT (dB μ V)	
	Quasi-peak	Average
0.15 ~ 0.5	66 to 56	56 to 46
0.5 ~ 5	56	46
5 ~ 30	60	50

- NOTE:**
1. The lower limit shall apply at the transition frequencies.
 2. The limit decreases in line with the logarithm of the frequency in the range of 0.15 to 0.50MHz.
 3. All emanations from a class A/B digital device or system, including any network of conductors and apparatus connected thereto, shall not exceed the level of field strengths specified above.

4.2.2 TEST INSTRUMENTS

DESCRIPTION & MANUFACTURER	MODEL NO.	SERIAL NO.	DATE OF CALIBRATION	DUE DATE OF CALIBRATION
Test Receiver ROHDE & SCHWARZ	ESCS30	100288	Apr. 24, 2014	Apr. 23, 2015
RF signal cable Woken	5D-FB	Cable-HYCO2-01	Dec. 27, 2013	Dec. 26, 2014
LISN ROHDE & SCHWARZ (EUT)	ESH2-Z5	100100	Dec. 23, 2013	Dec. 22, 2014
LISN ROHDE & SCHWARZ (Peripheral)	ESH3-Z5	100312	Jul. 10, 2014	Jul. 09, 2015
Software ADT	BV ADT_Cond_ V7.3.7.3	NA	NA	NA

- NOTE:**
1. The calibration interval of the above test instruments is 12 months and the calibrations are traceable to NML/ROC and NIST/USA.
 2. The test was performed in HwaYa Shielded Room 2.
 3. The VCCI Site Registration No. is C-2047.

4.2.3 TEST PROCEDURES

- a. The EUT was placed 0.4 meters from the conducting wall of the shielded room with EUT being connected to the power mains through a line impedance stabilization network (LISN). Other support units were connected to the power mains through another LISN. The two LISNs provide 50 ohm/ 50uH of coupling impedance for the measuring instrument.
- b. Both lines of the power mains connected to the EUT were checked for maximum conducted interference.
- c. The frequency range from 150kHz to 30MHz was searched. Emission levels under (Limit - 20dB) was not recorded.

NOTE: All modes of operation were investigated and the worst-case emissions are reported.

4.2.4 DEVIATION FROM TEST STANDARD

No deviation.

4.2.5 TEST SETUP

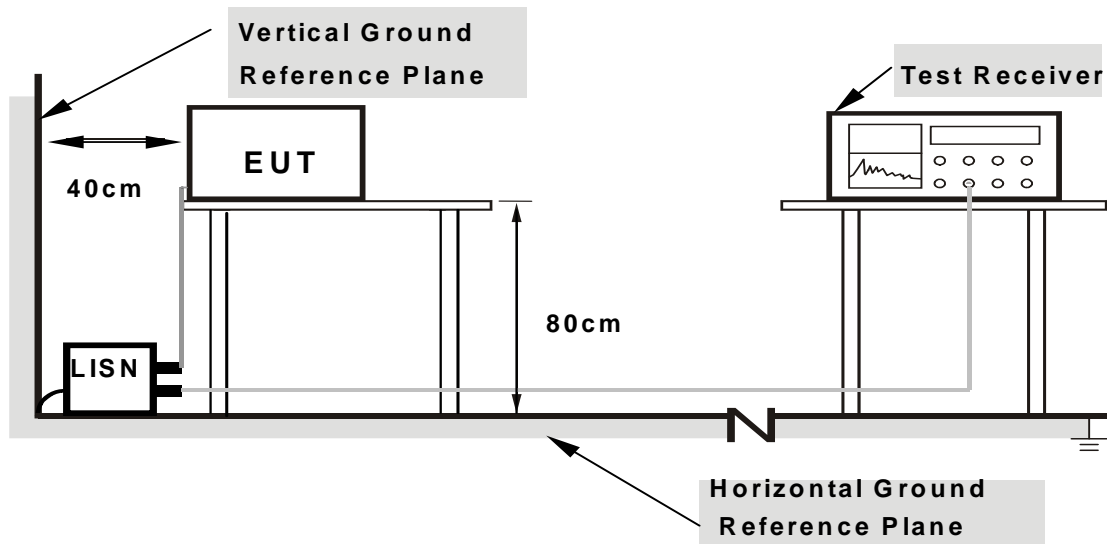

- Note: 1. Support units were connected to second LISN.**
2. Both of LISNs (AMN) are 80 cm from EUT and at least 80 cm from other units and other metal planes

For the actual test configuration, please refer to the attached file (Test Setup Photo).

4.2.6 EUT OPERATING CONDITIONS

Same as 4.1.6.

4.2.7 TEST RESULTS

CONDUCTED WORST-CASE DATA :

PHASE	Line 1	6dB BANDWIDTH	9kHz
TEST MODE	A		

No	Freq. [MHz]	Corr. Factor (dB)	Reading Value		Emission Level		Limit		Margin	
			[dB (uV)]		[dB (uV)]		[dB (uV)]		(dB)	
			Q.P.	AV.	Q.P.	AV.	Q.P.	AV.	Q.P.	AV.
1	0.44388	0.23	39.98	28.43	40.21	28.66	56.99	46.99	-16.78	-18.33
2	0.91563	0.29	39.38	29.35	39.67	29.64	56.00	46.00	-16.33	-16.36
3	1.23438	0.32	40.25	32.63	40.57	32.95	56.00	46.00	-15.43	-13.05
4	1.62500	0.34	40.82	31.51	41.16	31.85	56.00	46.00	-14.84	-14.15
5	2.57813	0.39	41.74	34.04	42.13	34.43	56.00	46.00	-13.87	-11.57
6	3.37891	0.42	40.44	30.91	40.86	31.33	56.00	46.00	-15.14	-14.67

REMARKS:

1. Q.P. and AV. are abbreviations of quasi-peak and average individually.
2. The emission levels of other frequencies were very low against the limit.
3. Margin value = Emission level - Limit value
4. Correction factor = Insertion loss + Cable loss
5. Emission Level = Correction Factor + Reading Value.

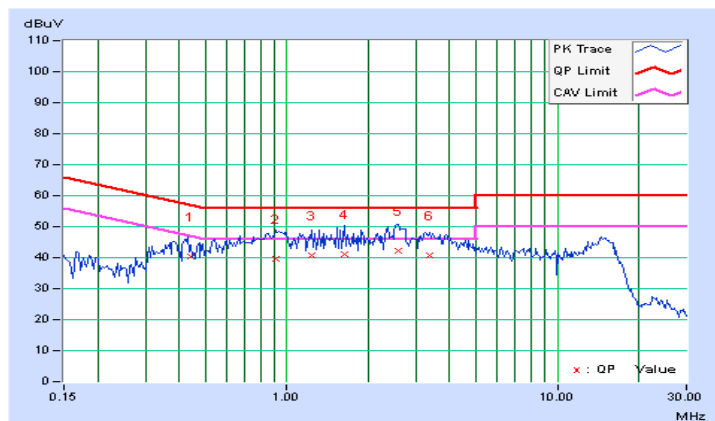

PHASE	Line 1	6dB BANDWIDTH	9kHz
TEST MODE	A		

No	Freq. [MHz]	Corr. Factor (dB)	Reading Value		Emission Level		Limit		Margin	
			[dB (uV)]		[dB (uV)]		[dB (uV)]		(dB)	
			Q.P.	AV.	Q.P.	AV.	Q.P.	AV.	Q.P.	AV.
1	0.91563	0.29	34.64	24.47	34.93	24.76	56.00	46.00	-21.07	-21.24
2	1.21484	0.31	36.58	27.32	36.89	27.63	56.00	46.00	-19.11	-18.37
3	1.59375	0.35	36.97	28.06	37.32	28.41	56.00	46.00	-18.68	-17.59
4	2.41016	0.41	38.37	30.24	38.78	30.65	56.00	46.00	-17.22	-15.35
5	3.75391	0.48	37.08	28.57	37.56	29.05	56.00	46.00	-18.44	-16.95
6	15.35938	0.68	36.85	29.00	37.53	29.68	60.00	50.00	-22.47	-20.32

REMARKS:

1. Q.P. and AV. are abbreviations of quasi-peak and average individually.
2. The emission levels of other frequencies were very low against the limit.
3. Margin value = Emission level - Limit value
4. Correction factor = Insertion loss + Cable loss
5. Emission Level = Correction Factor + Reading Value.

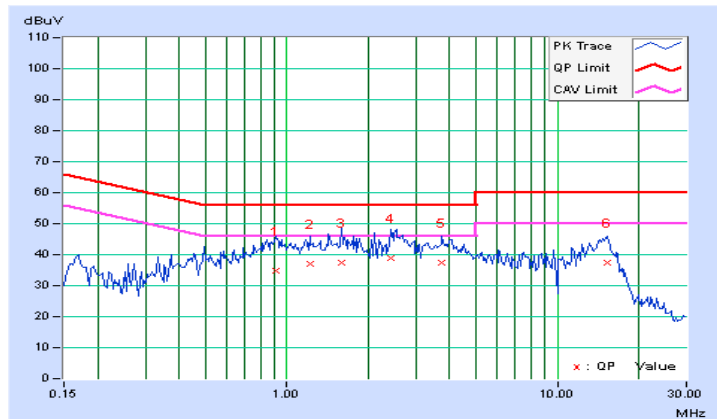

PHASE	Line 1	6dB BANDWIDTH	9kHz
TEST MODE	B		

No	Freq. [MHz]	Corr. Factor (dB)	Reading Value		Emission Level		Limit		Margin	
			[dB (uV)]		[dB (uV)]		[dB (uV)]		(dB)	
			Q.P.	AV.	Q.P.	AV.	Q.P.	AV.	Q.P.	AV.
1	0.15781	0.22	46.42	33.27	46.64	33.49	65.58	55.58	-18.94	-22.09
2	0.18516	0.23	43.73	32.44	43.96	32.67	64.25	54.25	-20.29	-21.58
3	0.22812	0.24	42.99	32.60	43.23	32.84	62.52	52.52	-19.29	-19.68
4	0.26328	0.23	40.53	28.66	40.76	28.89	61.33	51.33	-20.56	-22.43
5	0.67734	0.26	41.24	32.47	41.50	32.73	56.00	46.00	-14.50	-13.27
6	14.67188	0.58	33.68	25.82	34.26	26.40	60.00	50.00	-25.74	-23.60

REMARKS:

1. Q.P. and AV. are abbreviations of quasi-peak and average individually.
2. The emission levels of other frequencies were very low against the limit.
3. Margin value = Emission level - Limit value
4. Correction factor = Insertion loss + Cable loss
5. Emission Level = Correction Factor + Reading Value.

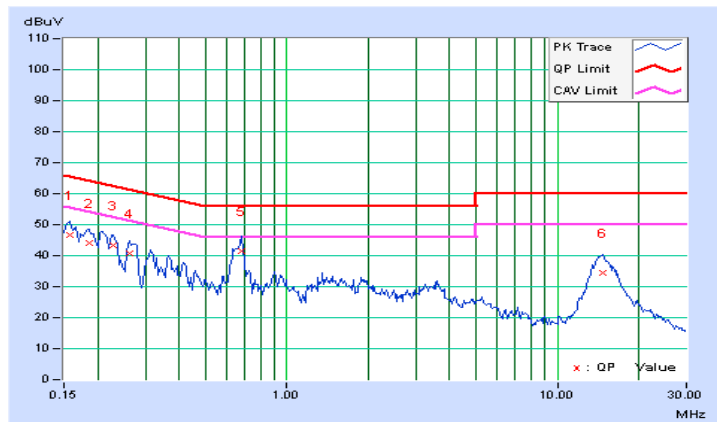

PHASE	Line 1	6dB BANDWIDTH	9kHz
TEST MODE	B		

No	Freq. [MHz]	Corr. Factor (dB)	Reading Value		Emission Level		Limit		Margin	
			[dB (uV)]		[dB (uV)]		[dB (uV)]		(dB)	
			Q.P.	AV.	Q.P.	AV.	Q.P.	AV.	Q.P.	AV.
1	0.15781	0.23	46.15	31.38	46.38	31.61	65.58	55.58	-19.20	-23.97
2	0.18125	0.23	43.83	28.17	44.06	28.40	64.43	54.43	-20.36	-26.02
3	0.22812	0.25	44.46	30.72	44.71	30.97	62.52	52.52	-17.81	-21.55
4	0.27109	0.26	40.94	27.02	41.20	27.28	61.08	51.08	-19.88	-23.80
5	0.31797	0.28	39.19	24.40	39.47	24.68	59.76	49.76	-20.29	-25.08
6	0.68272	0.30	38.99	31.55	39.29	31.85	56.00	46.00	-16.71	-14.15

REMARKS:

1. Q.P. and AV. are abbreviations of quasi-peak and average individually.
2. The emission levels of other frequencies were very low against the limit.
3. Margin value = Emission level - Limit value
4. Correction factor = Insertion loss + Cable loss
5. Emission Level = Correction Factor + Reading Value.

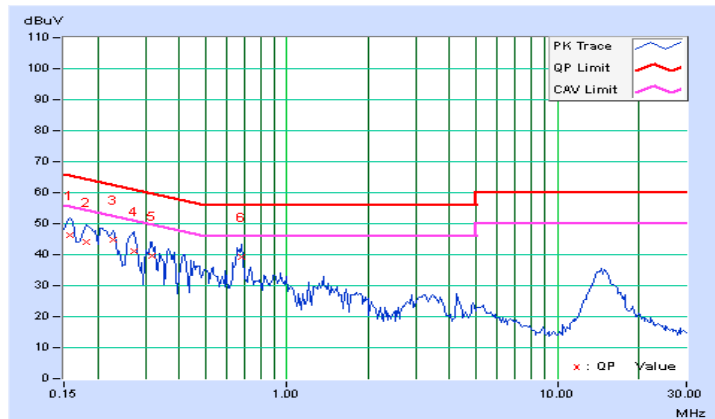

4.3 6dB BANDWIDTH MEASUREMENT

4.3.1 LIMITS OF 6dB BANDWIDTH MEASUREMENT

The minimum of 6dB Bandwidth Measurement is 0.5 MHz.

4.3.2 TEST SETUP

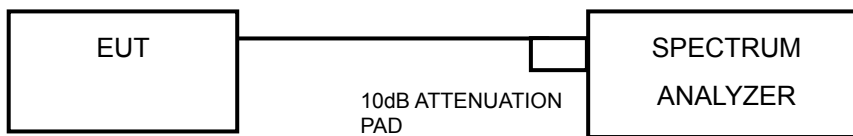

4.3.3 TEST INSTRUMENTS

Refer to section 4.1.2 to get information of above instrument.

4.3.4 TEST PROCEDURE

1. Set resolution bandwidth (RBW) = 100kHz
2. Set the video bandwidth (VBW) $\geq 3 \times$ RBW, Detector = Peak.
3. Trace mode = max hold.
4. Sweep = auto couple.
5. Measure the maximum width of the emission that is constrained by the frequencies associated with the two amplitude points (upper and lower) that are attenuated by 6 dB relative to the maximum level measured in the fundamental emission.

4.3.5 DEVIATION FROM TEST STANDARD

No deviation.

4.3.6 EUT OPERATING CONDITIONS

The software provided by client to enable the EUT under transmission condition continuously at lowest, middle and highest channel frequencies individually.

4.4 CONDUCTED OUTPUT POWER

4.4.1 LIMITS OF CONDUCTED OUTPUT POWER MEASUREMENT

For systems using digital modulation in the 2400–2483.5 MHz: 1 Watt (30dBm)

4.4.2 TEST SETUP

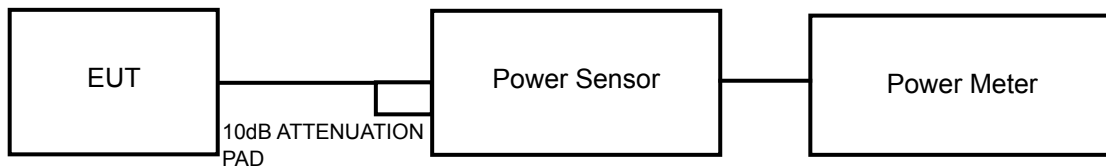

4.4.3 TEST INSTRUMENTS

Refer to section 4.1.2 to get information of above instrument.

4.4.4 TEST PROCEDURES

A peak power sensor was used on the output port of the EUT. A power meter was used to read the response of the peak power sensor. Record the peak power level.

4.4.5 DEVIATION FROM TEST STANDARD

No deviation.

4.4.6 EUT OPERATING CONDITIONS

Same as Item 4.3.6.

4.4.7 TEST RESULTS

CHANNEL	FREQUENCY (MHz)	PEAK POWER (mW)	PEAK POWER (dBm)	LIMIT (dBm)	PASS/FAIL
0	2402	3.404	5.32	30	PASS
19	2440	3.062	4.86	30	PASS
39	2480	3.083	4.89	30	PASS

4.5 POWER SPECTRAL DENSITY MEASUREMENT

4.5.1 LIMITS OF POWER SPECTRAL DENSITY MEASUREMENT

The Maximum of Power Spectral Density Measurement is 8dBm.

4.5.2 TEST SETUP

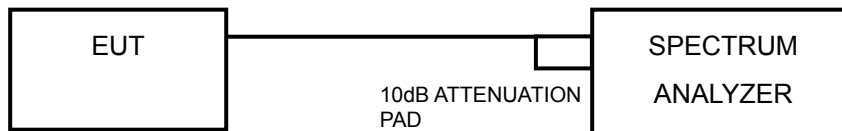

4.5.3 TEST INSTRUMENTS

Refer to section 4.1.2 to get information of above instrument.

4.5.4 TEST PROCEDURE

- a. Set resolution bandwidth (RBW) = approximately 1% of the emission bandwidth
- b. Set the video bandwidth (VBW) $\geq 3 \times$ RBW, Detector = Peak.
- c. Trace mode = max hold.
- d. Sweep = auto couple.
- e. Measure the maximum width of the emission that is constrained by the frequencies associated with the two amplitude points (upper and lower) that are attenuated by 6 dB relative to the maximum level measured in the fundamental emission

4.5.5 DEVIATION FROM TEST STANDARD

No deviation.

4.5.6 EUT OPERATING CONDITION

Same as Item 4.3.6

4.5.7 TEST RESULTS

Channel	FREQ. (MHz)	PSD (dBm/3kHz)	Limit (dBm/3kHz)	PASS /FAIL
0	2402	-8.98	8	PASS
19	2440	-9.58	8	PASS
39	2480	-9.76	8	PASS

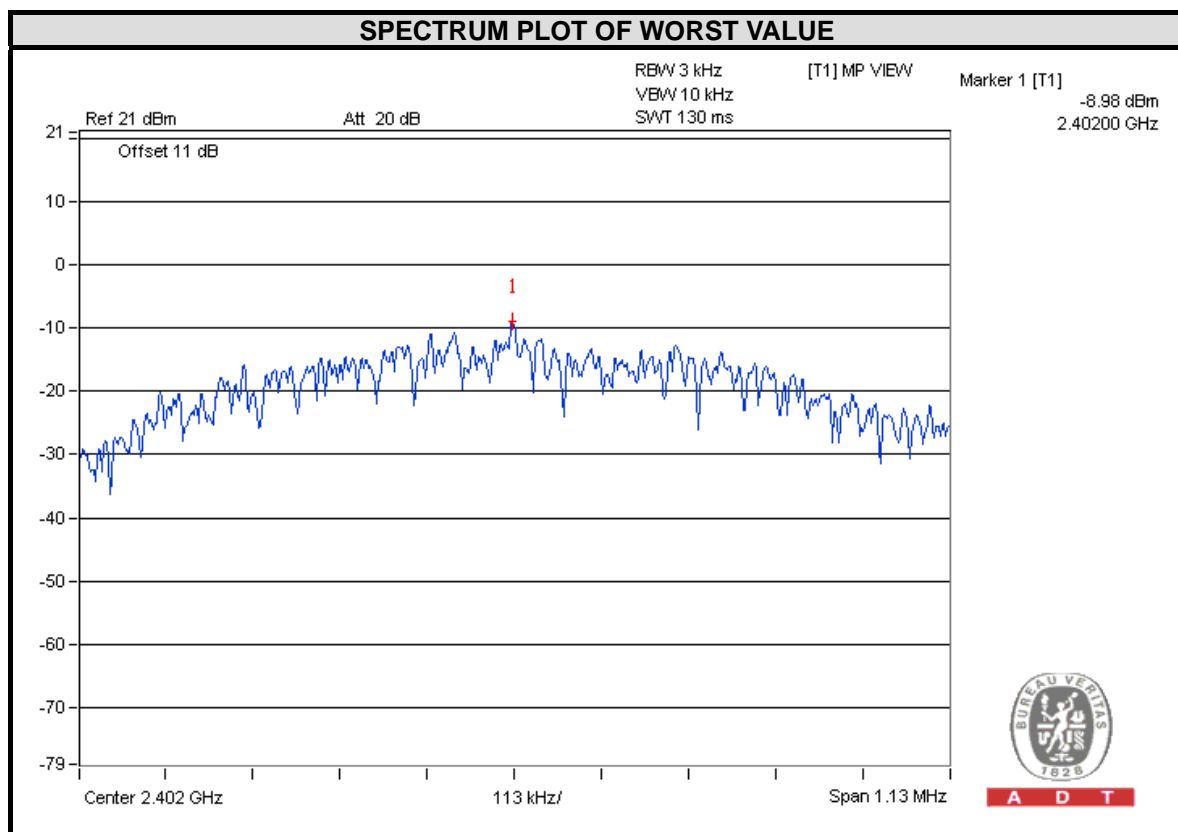

4.6 CONDUCTED OUT OF BAND EMISSION MEASUREMENT

4.6.1 LIMITS OF OUT OF BAND EMISSION MEASUREMENT

Below -20dB of the highest emission level of operating band (in 100kHz Resolution Bandwidth).

4.6.2 TEST SETUP

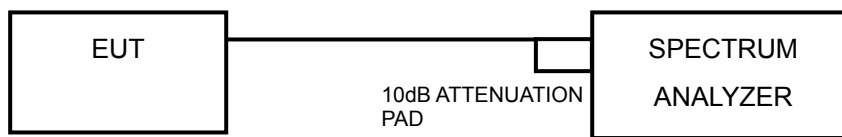

4.6.3 TEST INSTRUMENTS

Refer to section 4.1.2 to get information of above instrument.

4.6.4 TEST PROCEDURE

MEASUREMENT PROCEDURE REF

1. Set the RBW = 100 kHz.
2. Set the VBW \geq 300 kHz.
3. Detector = peak.
4. Sweep time = auto couple.
5. Trace mode = max hold.
6. Allow trace to fully stabilize.
7. Use the peak marker function to determine the maximum power level in any 100 kHz band segment within the fundamental EBW.

MEASUREMENT PROCEDURE OOB

1. Set RBW = 100 kHz.
2. Set VBW \geq 300 kHz.
3. Detector = peak.
4. Sweep = auto couple.
5. Trace Mode = max hold.
6. Allow trace to fully stabilize.
7. Use the peak marker function to determine the maximum amplitude level.

4.6.5 DEVIATION FROM TEST STANDARD

No deviation.

4.6.6 EUT OPERATING CONDITION

Same as Item 4.3.6

4.6.7 TEST RESULTS

The spectrum plots are attached on the following pages. D1 line indicates the highest level, and D2 line indicates the 20dB offset below D1. It shows compliance with the requirement.

4.6.8 TEST RESULTS

CH 0

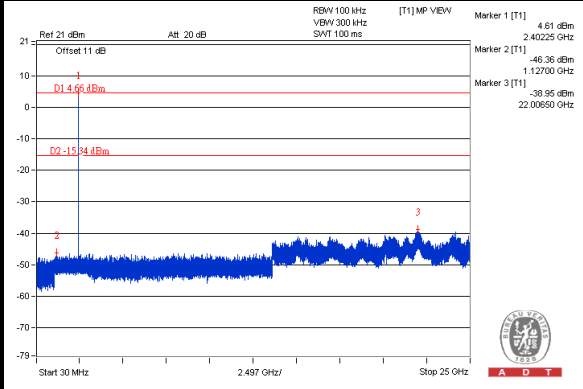
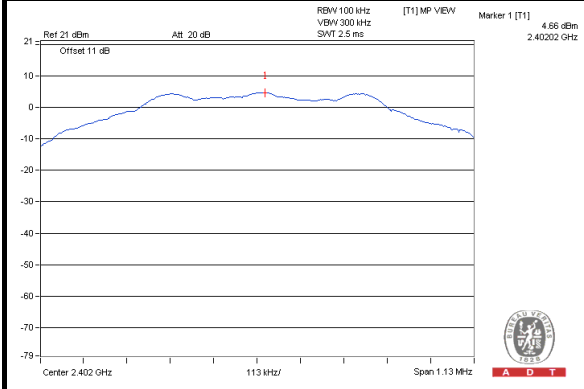

CH 19

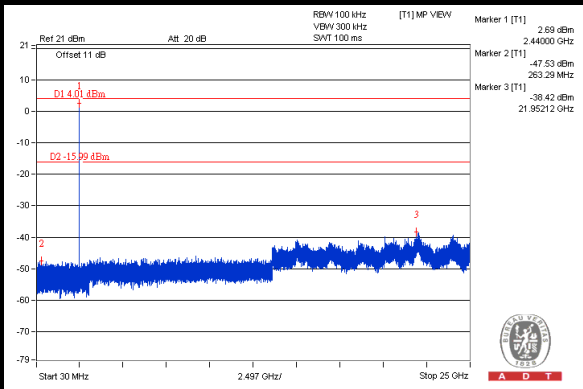
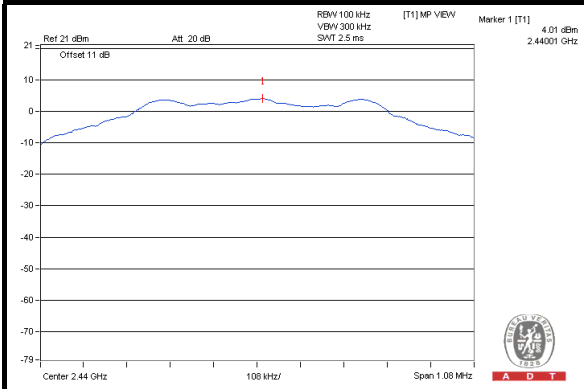

CH 39

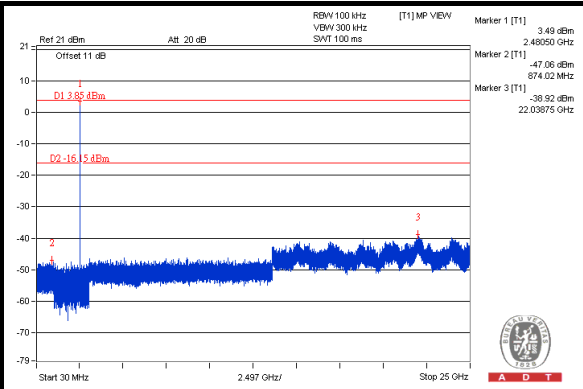
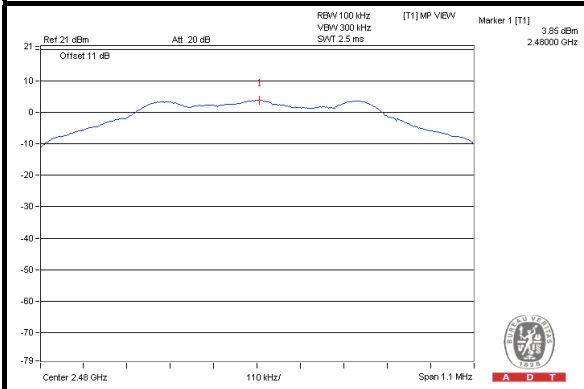

CH 0 Band edge

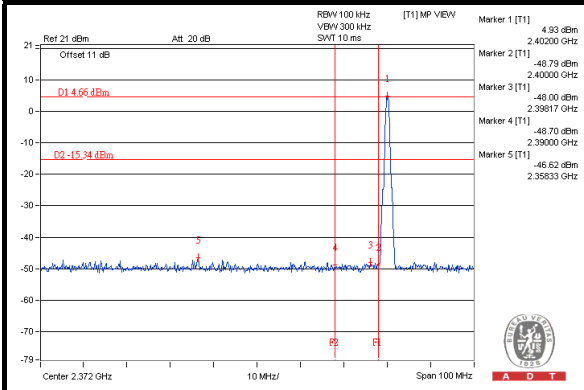

CH 39 Band edge

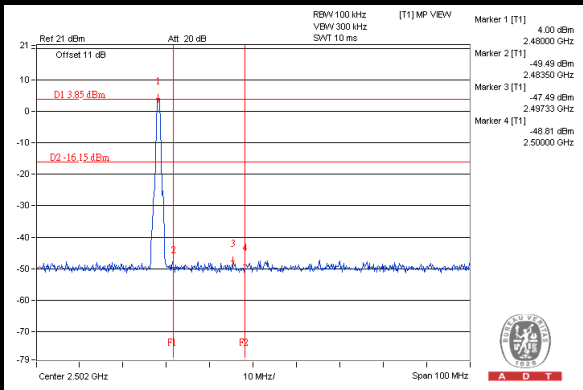

5. PHOTOGRAPHS OF THE TEST CONFIGURATION

Please refer to the attached file (Test Setup Photo).





6. INFORMATION ON THE TESTING LABORATORIES

We, Bureau Veritas Consumer Products Services (H.K.) Ltd., Taoyuan Branch, were founded in 1988 to provide our best service in EMC, Radio, Telecom and Safety consultation. Our laboratories are accredited and approved according to ISO/IEC 17025.

If you have any comments, please feel free to contact us at the following:

Linko EMC/RF Lab:

Tel: 886-2-26052180

Fax: 886-2-26051924

Hsin Chu EMC/RF/Telecom Lab:

Tel: 886-3-5935343

Fax: 886-3-5935342

Hwa Ya EMC/RF/Safety Lab:

Tel: 886-3-3183232

Fax: 886-3-3270892

Email: service.adt@tw.bureauveritas.com

Web Site: www.bureauveritas-adt.com

The address and road map of all our labs can be found in our web site also.



7. APPENDIX A - MODIFICATIONS RECORDERS FOR ENGINEERING CHANGES TO THE EUT BY THE LAB

No modifications were made to the EUT by the lab during the test.

--- END ---