



FCC 47 CFR PART 15 SUBPART C

for

Tablet Computer

Model: A1401

Brand: ACER

Test Report Number:

C140429Z02-RP1

Issued Date: May 26, 2014

Issued for

Acer Incorporated

8F, 88, Sec 1, Xintai 5th Rd. Xizhi, New Taipei City 221 Taiwan, R.O.C

Issued by:

Compliance Certification Services (Shenzhen) Inc.

No.10-1 Mingkeda Logistics park, No.18, Huanguan South Rd.,

Guan Lan Town, Baoan District, Shenzhen, China

TEL: 86-755-28055000

FAX: 86-755-28055221



Note: This report shall not be reproduced except in full, without the written approval of Compliance Certification Services Inc. This document may be altered or revised by Compliance Certification Services Inc. personnel only, and shall be noted in the revision section of the document. The client should not use it to claim product endorsement by TAF, A2LA, NVLAP, NIST or any government agencies. The test results in the report only apply to the tested sample.



Revision History

Rev.	Issue No.	Revisions	Effect Page	Revised By
00	C140429Z02-RP1	Initial Issue	ALL	Sabrina Wang



TABLE OF CONTENTS

1 TEST CERTIFICATION 4

2 TEST RESULT SUMMARY 5

3 EUT DESCRIPTION 6

4 TEST METHODOLOGY 7

 4.1. DESCRIPTION OF TEST MODES 7

5 SETUP OF EQUIPMENT UNDER TEST 8

 5.1. DESCRIPTION OF SUPPORT UNITS 8

 5.2. CONFIGURATION OF SYSTEM UNDER TEST 8

6 FACILITIES AND ACCREDITATIONS 9

 6.1. FACILITIES 9

 6.2. ACCREDITATIONS 9

 6.3. MEASUREMENT UNCERTAINTY 9

7 FCC PART 15.247 REQUIREMENTS 10

 7.1. POWER LINE CONDUCTED EMISSIONS MEASUREMENT 10

 7.2. SPURIOUS EMISSIONS MEASUREMENT 14

 7.3. 6dB BANDWIDTH MEASUREMENT 67

 7.4. PEAK OUTPUT POWER 86

 7.5. BAND EDGES MEASUREMENT 90

 7.6. PEAK POWER SPECTRAL DENSITY MEASUREMENT 120



1 TEST CERTIFICATION

Product	Tablet Computer
Model	A1401
Brand	ACER
Tested	April 29~ May 26, 2014
Applicant	Acer Incorporated 8F, 88, Sec 1, Xintai 5th Rd. Xizhi, New Taipei City 221 Taiwan, R.O.C
Manufacturer	Acer Incorporated 8F, 88, Sec 1, Xintai 5th Rd. Xizhi, New Taipei City 221 Taiwan, R.O.C

APPLICABLE STANDARDS			
Standard	Test Type	Standard	Test Type
15.207(a)	Power Line Conducted Emissions	15.247(d) 15.209(a)	<ul style="list-style-type: none"> ● Spurious Emissions ● Conducted Measurement ● Radiated Emissions
15.247(a)(2)	6dB Bandwidth Measurement	15.247(b)(3) 15.247(b)(4)	Peak Power Measurement
15.247(d)	Band Edges Measurement	15.247(e)	Peak Power Spectral Density

We hereby certify that:

The above equipment was tested by Compliance Certification Services Inc. The test data, data evaluation, test procedures, and equipment configurations shown in this report were made in accordance with the procedures given in **ANSI C63.4: 2009** and the energy emitted by the sample EUT tested as described in this report is in compliance with the requirements of FCC Rules Part 15.207, 15.209, 15.247.

The test results of this report relate only to the tested sample EUT identified in this report.

Approved by:

Reviewed by:

Sunday Hu
Supervisor of EMC Dept.
Compliance Certification Service Inc.

Ruby Zhang
Supervisor of Report Dept.
Compliance Certification Service Inc.



2 TEST RESULT SUMMARY

APPLICABLE STANDARDS			
Standard	Test Type	Result	Remark
15.247(a)(2)	6dB Bandwidth Measurement	Pass	Meet the requirement of limit.
15.247(b)(3) 15.247(b)(4)	Peak Power Measurement	Pass	Meet the requirement of limit.
15.247(d)	Band Edges Measurement	Pass	Meet the requirement of limit.
15.247(e)	Peak Power Spectral Density	Pass	Meet the requirement of limit.
15.247(d) 15.209(a)	● Spurious Emissions ● Conducted Measurement ● Radiated Emissions	Pass	Meet the requirement of limit.
15.207(a)	Power line Conducted Emissions	Pass	Meet the requirement of limit.

- Note:
1. The statements of test result on the above are decided by the request of test standard only; the measurement uncertainties are not factored into this compliance determination.
 2. The information of measurement uncertainty is available upon the customer's request.



3 EUT DESCRIPTION

Product	Tablet Computer
Model Number	A1401
Brand	ACER
Model Discrepancy	N/A
Serial Number	C140429Z02-RP1
Received Date	April 29, 2014
Power Supply	DC5.35V supplied by the Adapter or DC3.7V supplied by the battery
Adapter Manufacturer / Model No.	Adapter 1: Chicony / W12-010N3A I/P: 100-240Vac, 50/60Hz, 0.3A O/P: 5.35Vdc, 2.0A Adapter 2: Delta / ADP-10HW A I/P: 100-240Vac, 50/60Hz, 0.4A max O/P: 5.35Vdc, 2.0A
Frequency Range	IEEE 802.11b/g: 2412 ~ 2462 MHz IEEE 802.11n HT20 : 2412 ~ 2462 MHz
Transmit Power	IEEE 802.11b mode: 16.53dBm (Antenna 0) IEEE 802.11b mode: 16.41dBm (Antenna 1) IEEE 802.11g mode: 19.92dBm (Antenna 0) IEEE 802.11g mode: 19.76dBm (Antenna 1) IEEE 802.11n HT20 MHz mode: 24.10dBm (Combine with Antenna 0 and Antenna 1) IEEE 802.11n HT20 SISO Mode: 19.57dBm (Antenna 0) IEEE 802.11n HT20 SISO Mode: 19.57dBm (Antenna 1)
Modulation Technique	IEEE 802.11b mode: DSSS(CCK,QPSK, BPSK) IEEE 802.11g mode: OFDM (BPSK/QPSK/16QAM/64QAM) IEEE 802.11n HT20 MHz mode: OFDM (BPSK/QPSK/16QAM/64QAM)
Number of Channels	IEEE 802.11b mode: 11 Channels IEEE 802.11g mode: 11 Channels IEEE 802.11n HT20 MHz mode: 11 Channels
Antenna Specification	PCB Antenna 0 with 2.4dBi gain (Max) PCB Antenna 1 with 1.5dBi gain (Max)
Channels Spacing	IEEE 802.11b/g ,802.11n HT20 : 5MHz
Temperature Range	0°C ~ 35°C
Hardware Version	V1.0
Software Version	4.4.2

- Note:** 1. The sample selected for test was engineering sample that approximated to production product and was provided by manufacturer.
2. This submittal(s) (test report) is intended for FCC ID: **HLZA1401** filing to comply with Section 15.207, 15.209 and 15.247 of the FCC Part 15, Subpart C Rules.



4 TEST METHODOLOGY

4.1. DESCRIPTION OF TEST MODES

The EUT has been tested under operating condition.

Software used to control the EUT for staying in continuous transmitting and receiving mode is programmed.

Test Item	Test mode	Worse mode
Conducted Emission	Mode 1 : Copy Data + LCD panel (N080JCE-G41) Mode 2 : HDMI Out + Adapter(W12-010N3A) + LCD panel (N080JCE-G41) Mode 3 : HDMI Out + Adapter(ADP-10HW A) +LCD panel (N080JCE-G41) Mode 4 : HDMI Out + Adapter(W12-010N3A) +LCD panel (B080UAN01.4)	Mode 2
Radiated Emission	Mode 1 : TX	Mode 1

After verification, all tests were carried out with the worst case test modes as shown below except radiated spurious emission below 1GHz, which worst case was in normal link mode only, and power line conducted emission below 30MHz, which worst case was in normal link mode.

IEEE802.11b mode: Channel Low (2412MHz), Channel Mid (2437MHz) and Channel High(2462MHz) with 1Mbps data rate were chosen for full testing.

IEEE802.11g mode: Channel Low (2412MHz), Channel Mid (2437MHz) and Channel High (2462MHz) with 6Mbps data rate were chosen for full testing.

IEEE 802.11n HT20 MHz mode: Channel Low (2412MHz), Channel Mid(2437MHz) and Channel High (2462MHz) with 13Mbps data rate were chosen for full testing.



5 SETUP OF EQUIPMENT UNDER TEST

5.1. DESCRIPTION OF SUPPORT UNITS

The EUT has been tested as an independent unit together with other necessary accessories or support units. The following support units or accessories were used to form a representative test configuration during the tests.

No.	Equipment	Model No.	Serial No.	FCC ID	Brand	Data Cable	Power Cord
1	PC	OPTIPLEX780	C7X53X	N/A	DELL	N/A	Unshielded 1.80m
2	Monitor	S2440LB	CN0N5XDC74261 31EOGZQ	N/A	DELL	Unshielded 1.20m	Unshielded 1.80m
3	Printer	D1668	CN9CKCB2RG	N/A	HP	Unshielded 1.50m	Unshielded 1.50m
4	Modem	DU-562M	DU562MSG.B1	N/A	ACELL	Unshielded 1.50m	N/A
5	Mouse	MS111-P	J1101ANN	N/A	DELL	Unshielded 1.80m	N/A
6	Keyboard	KB212-B	CNOK6KPN71616	N/A	DELL	Unshielded 1.80m	N/A
7	TF Card	N/A	N/A	N/A	Kingston	N/A	N/A
8	Earphone	ST-908	N/A	N/A	SENICC	Shielded 2.20m	N/A

Note:

Grounding was established in accordance with the manufacturer's requirements and conditions for the intended use.

5.2. CONFIGURATION OF SYSTEM UNDER TEST

See test photographs attached in Appendix II for the actual connections between EUT and support equipment.



6 FACILITIES AND ACCREDITATIONS

6.1. FACILITIES

All measurement facilities used to collect the measurement data are located at **No.10-1 Mingkeda Logistics park, No.18, Huanguan South Rd., Guan Lan Town, Baoan District, Shenzhen, China**

The sites are constructed in conformance with the requirements of ANSI C63.4, ANSI C63.7 and CISPR Publication 22. All receiving equipment conforms to CISPR Publication 16-1, "Radio Interference Measuring Apparatus and Measurement Methods."

6.2. ACCREDITATIONS

Our laboratories are accredited and approved by the following accreditation body according to ISO/IEC 17025.

USA	A2LA
China	CNAS

The measuring facility of laboratories has been authorized or registered by the following approval agencies.

USA	FCC
Japan	VCCI(C-3478, R-3135, T-652, G-624)
Canada	INDUSTRY CANADA
Taiwan	BSMI

Copies of granted accreditation certificates are available for downloading from our web site, <http://www.ccsrf.com>

6.3. MEASUREMENT UNCERTAINTY

Where relevant, the following measurement uncertainty levels have been estimated for tests performed on the EUT as specified in CISPR 16-4-2:

Parameter	Uncertainty
Radiated Emission, 30 to 200 MHz Test Site : 966(2)	+/-3.6880dB
Radiated Emission, 200 to 1000 MHz Test Site : 966(2)	+/-3.6695dB
Radiated Emission, 1 to 8 GHz	+/-5.1782dB
Radiated Emission, 8 to 18 GHz	+/-5.2173dB
Conducted Emissions	+/-3.6836dB
Band Width	178kHz
Peak Output Power MU	+/-1.906dB
Band Edge MU	+/-0.182dB
Channel Separation MU	416.178Hz
Duty Cycle MU	0.054ms
Frequency Stability MU	226Hz

This uncertainty represents an expanded uncertainty expressed at approximately the 95% confidence level using a coverage factor of k=2.

The measured result is above (below) the specification limit by a margin less than the measurement uncertainty; it is therefore not possible to state compliance based on the 95% level of confidence. However, the result indicates that compliance (non-compliance) is more probable than non-compliance) with the specification limit.



7 FCC PART 15.247 REQUIREMENTS

7.1. POWER LINE CONDUCTED EMISSIONS MEASUREMENT

7.1.1. LIMITS OF CONDUCTED EMISSIONS MEASUREMENT

According to §15.207(a), except as shown in paragraphs (b) and (c) of this section, for an intentional radiator that is designed to be connected to the public utility (AC) power line, the radio frequency voltage that is conducted back onto the AC power line on any frequency or frequencies within the band 150 kHz to 30 MHz shall not exceed the limits in the following table, as measured using a 50 μH/50 ohms line impedance stabilization network (LISN). Compliance with the provisions of this paragraph shall be based on the measurement of the radio frequency voltage between each power line and ground at the power terminal. The lower limit applies at the boundary between the frequency ranges.

Frequency Range (MHz)	Limits (dBμV)	
	Quasi-peak	Average
0.15 to 0.50	66 to 56*	56 to 46*
0.50 to 5	56	46
5 to 30	60	50

NOTE:

- (1) The lower limit shall apply at the transition frequencies.
- (2) The limit decreases in line with the logarithm of the frequency in the range of 0.15 to 0.50 MHz.
- (3) All emanations from a class A/B digital device or system, including any network of conductors and apparatus connected thereto, shall not exceed the level of field strengths specified above.

7.1.2. TEST INSTRUMENTS

Conducted Emission Test Site					
Name of Equipment	Manufacturer	Model Number	Serial Number	Last Calibration	Due Calibration
EMI TEST RECEIVER	ROHDE&SCHWARZ	ESCI	100783	03/09/2014	03/08/2015
LISN(EUT)	ROHDE&SCHWARZ	ENV216	101543-WX	04/20/2014	04/19/2015
LISN	EMCO	3825/2	8901-1459	03/09/2014	03/08/2015
Temp. / Humidity Meter	VICTOR	HTC-1	N/A	03/17/2014	03/17/2015
Test S/W	FARAD	EZ-EMC/ CCS-3A1-CE			

NOTE: 1. The calibration interval of the above test instruments is 12 months and the calibrations are traceable to NML/ROC and NIST/USA.

2. N.C.R = No Calibration Request.



7.1.3. TEST PROCEDURES (please refer to measurement standard)

- The EUT and Support equipment, if needed, was placed on a non-conducted table, which is 0.8m above the ground plane and 0.4m away from the conducted wall.
- The test equipment EUT installed received AC main power, through a Line Impedance Stabilization Network (LISN), which supplied power source and was grounded to the ground plane. All support equipment power received from a second LISN. The two LISNs provide 50 ohm/ 50uH of coupling impedance for the measuring instrument.
- The EUT test program was started. Emissions were measured on each current carrying line of the EUT using an EMI Test Receiver connected to the LISN powering the EUT.
- The frequency range from 150 kHz to 30 MHz was searched. The test data of the worst-case condition(s) was recorded. Emission levels under limit 20dB were not recorded.



7.1.4. TEST SETUP

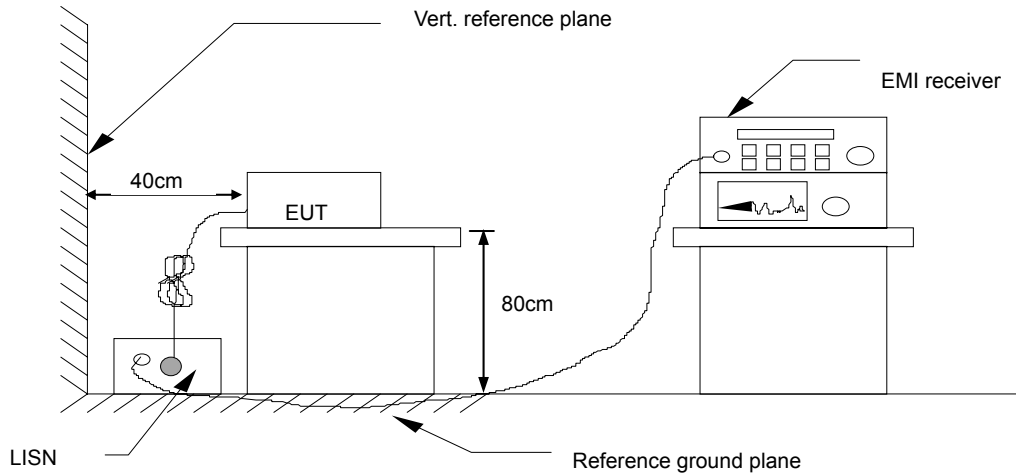

For the actual test configuration, please refer to the related item - Photographs of the Test Configuration.

7.1.5. DATA SAMPLE

Frequency (MHz)	QuasiPeak Reading (dBuV)	Average Reading (dBuV)	Correction Factor (dB)	QuasiPeak Result (dBuV)	Average Result (dBuV)	QuasiPeak Limit (dBuV)	Average Limit (dBuV)	QuasiPeak Margin (dB)	Average Margin (dB)	Remark (Pass/Fail)
X.XXXX	32.69	25.65	11.52	44.21	37.17	65.78	55.79	-21.57	-18.62	Pass

- Factor = Insertion loss of LISN + Cable Loss
- Result = Quasi-peak Reading/ Average Reading + Factor
- Limit = Limit stated in standard
- Margin = Result (dBuV) – Limit (dBuV)



7.1.6. TEST RESULTS

Model No.	HDP1590	RBW,VBW	9 kHz
Environmental Conditions	22°C, 45% RH	Test Mode	Mode 2
Tested by	Sun Guo	Line	L1

Frequency (MHz)	QuasiPeak Reading (dBuV)	Average Reading (dBuV)	Correction Factor (dB)	QuasiPeak Result (dBuV)	Average Result (dBuV)	QuasiPeak Limit (dBuV)	Average Limit (dBuV)	QuasiPeak Margin (dB)	Average Margin (dB)	Remark (Pass/Fail)	Line (L1/L2)
0.3700	42.55	31.78	9.68	52.23	41.46	58.50	48.50	-6.27	-7.04	Pass	L1
0.4140	42.09	33.26	9.68	51.77	42.94	57.57	47.57	-5.80	-4.63	Pass	L1
0.8260	38.86	29.15	9.76	48.62	38.91	56.00	46.00	-7.38	-7.09	Pass	L1
1.1660	38.82	29.34	9.71	48.53	39.05	56.00	46.00	-7.47	-6.95	Pass	L1
2.1780	38.63	27.69	9.72	48.35	37.41	56.00	46.00	-7.65	-8.59	Pass	L1
5.0620	38.59	23.00	9.68	48.27	32.68	60.00	50.00	-11.73	-17.32	Pass	L1
0.4180	42.81	31.88	9.71	52.52	41.59	57.49	47.49	-4.97	-5.90	Pass	L2
0.5220	38.97	28.14	9.68	48.65	37.82	56.00	46.00	-7.35	-8.18	Pass	L2
0.8860	38.72	27.10	9.76	48.48	36.86	56.00	46.00	-7.52	-9.14	Pass	L2
1.1460	38.64	26.56	9.80	48.44	36.36	56.00	46.00	-7.56	-9.64	Pass	L2
1.4460	38.19	25.17	9.78	47.97	34.95	56.00	46.00	-8.03	-11.05	Pass	L2
5.3700	39.07	25.49	9.78	48.85	35.27	60.00	50.00	-11.15	-14.73	Pass	L2

REMARKS: L1 = Line One (Live Line)

L2 = Line Two (Neutral Line)



7.2. SPURIOUS EMISSIONS MEASUREMENT

7.2.1. CONDUCTED EMISSIONS MEASUREMENT

7.2.1.1. LIMITS OF CONDUCTED EMISSIONS MEASUREMENT

§15.247(d) specifies that in any 100 kHz bandwidth outside of the authorized frequency band, the power shall be attenuated according to the following conditions:

If the peak output power procedure is used to measure the fundamental emission power to demonstrate compliance to 15.247(b)(3) requirements, then the peak conducted output power measured within any 100 kHz outside the authorized frequency band shall be attenuated by at least 20 dB relative to the maximum measured in-band peak PSD level.

If the average output power procedure is used to measure the fundamental emission power to demonstrate compliance to 15.247(b)(3) requirements, then the power in any 100 kHz outside of the authorized frequency band shall be attenuated by at least 30 dB relative to the maximum measured in-band average PSD level.

In addition, radiated emissions which fall in the restricted bands, as defined in §15.205(a), must also comply with the radiated emission limits specified in 15.209(a) (see Section 15.205(c)).

7.2.1.2. TEST INSTRUMENTS

Name of Equipment	Manufacturer	Model	Serial Number	Last Calibration	Due Calibration
Spectrum Analyzer	Agilent	E4446A	US44300399	03/01/2014	03/01/2015

7.2.1.3. TEST PROCEDURE (please refer to measurement standard)

Conducted RF measurements of the transmitter output were made to confirm that the EUT antenna port conducted emissions meet the specified limit and to identify any spurious signals that require further investigation or measurements on the radiated emissions site.

The transmitter output is connected to the spectrum analyzer. The resolution bandwidth is set to 100 kHz. The video bandwidth is set to 300 kHz.

Measurements are made over the 30MHz to 26GHz range with the transmitter set to the lowest, middle, and highest channels.



7.2.1.4. TEST RESULTS

Test Plot

IEEE 802.11b mode (Antenna 0)

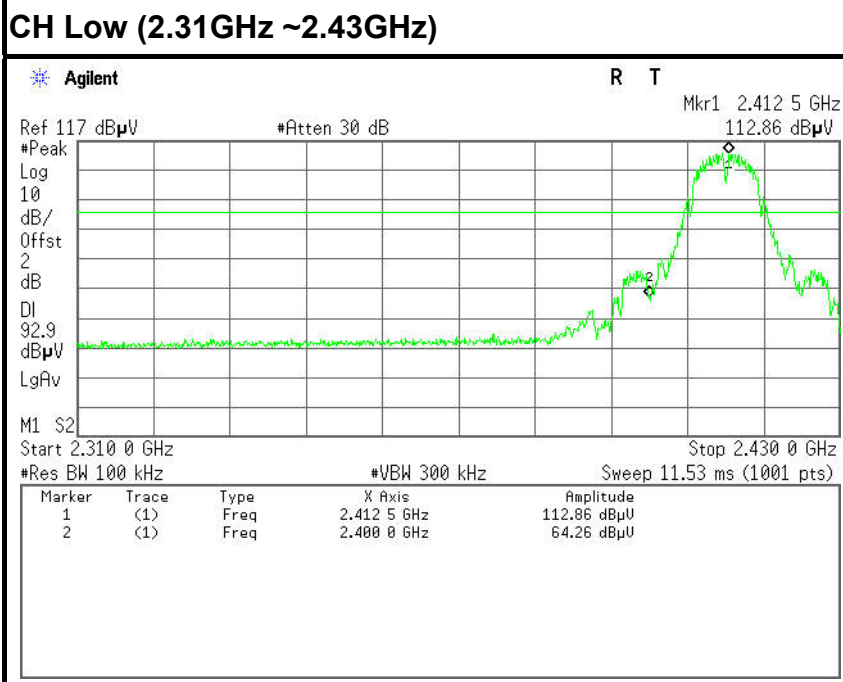
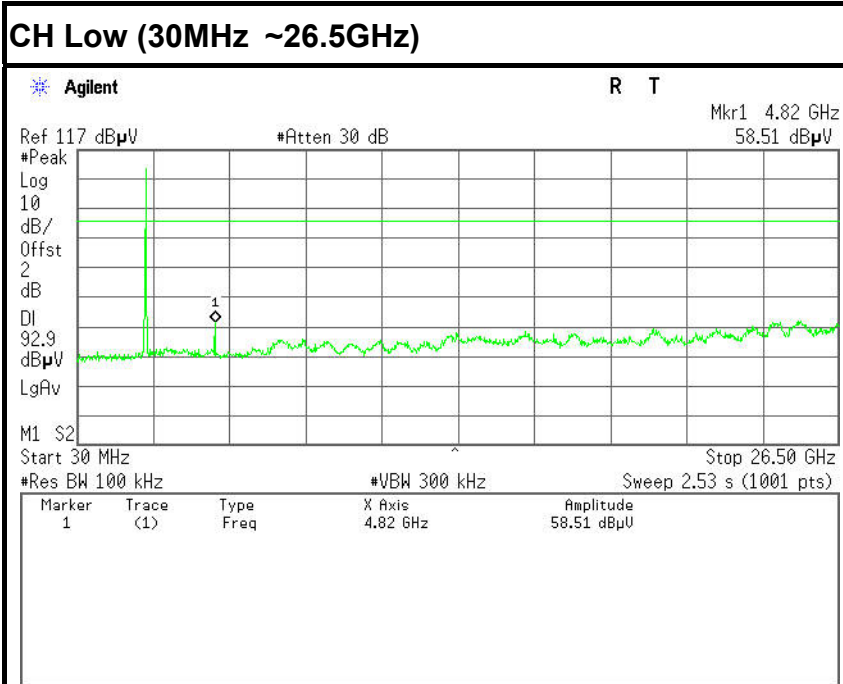

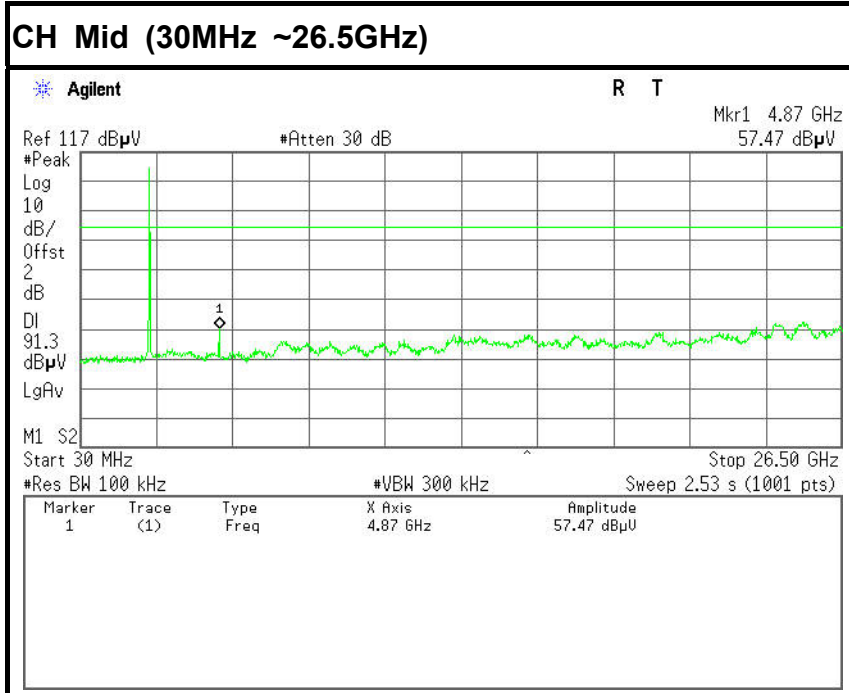



CH High (30MHz ~26.5GHz)

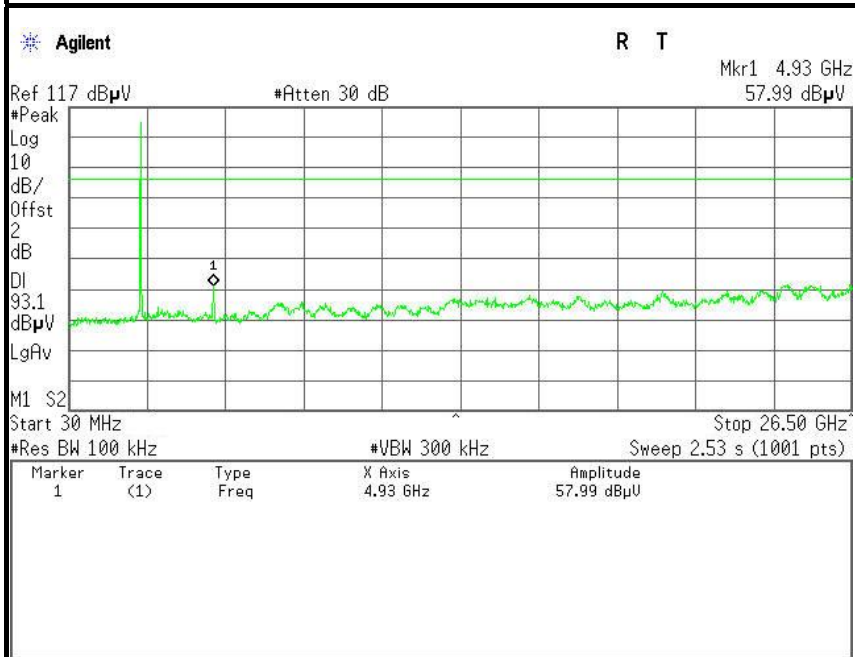

CH High (2.45GHz ~2.5GHz)

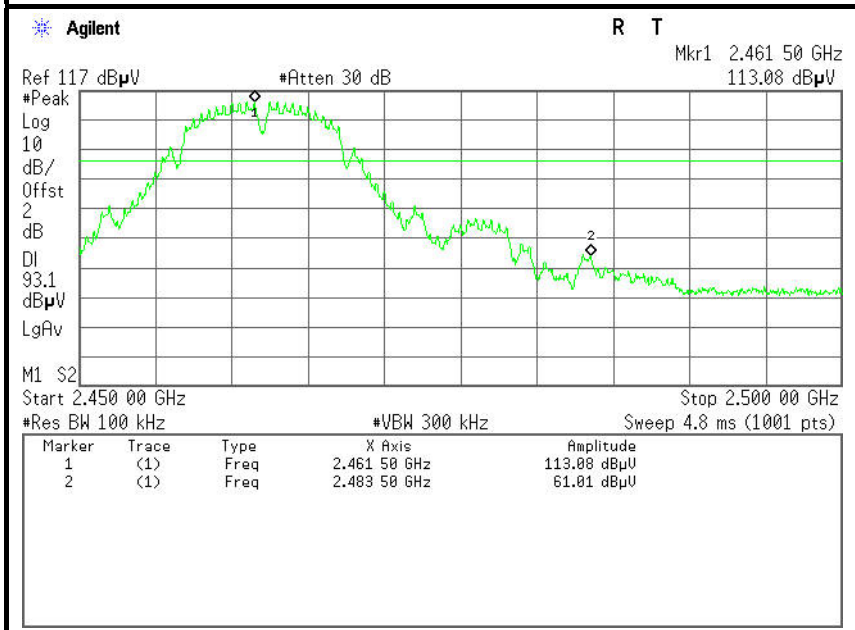



IEEE 802.11b mode (Antenna 1)

CH Low (30MHz ~26.5GHz)

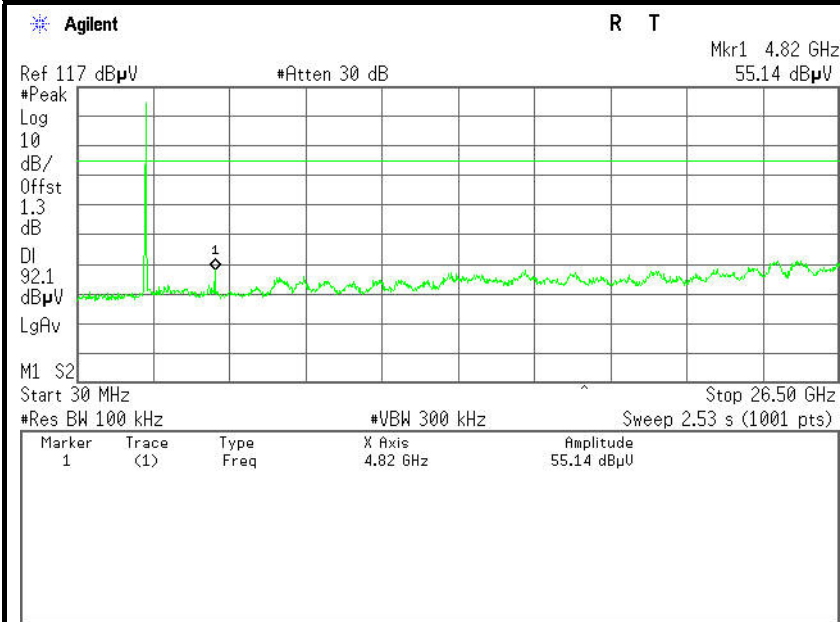

CH Low (2.31GHz ~2.43GHz)

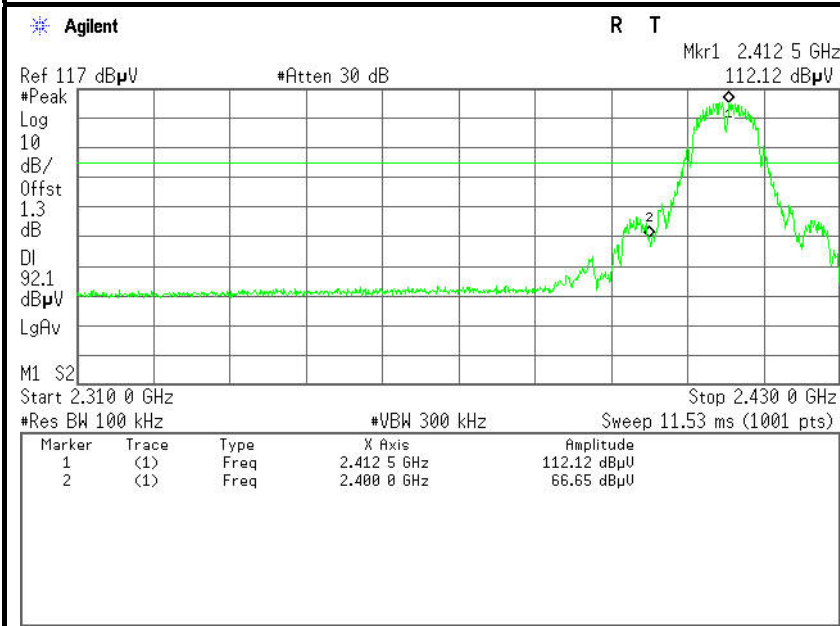

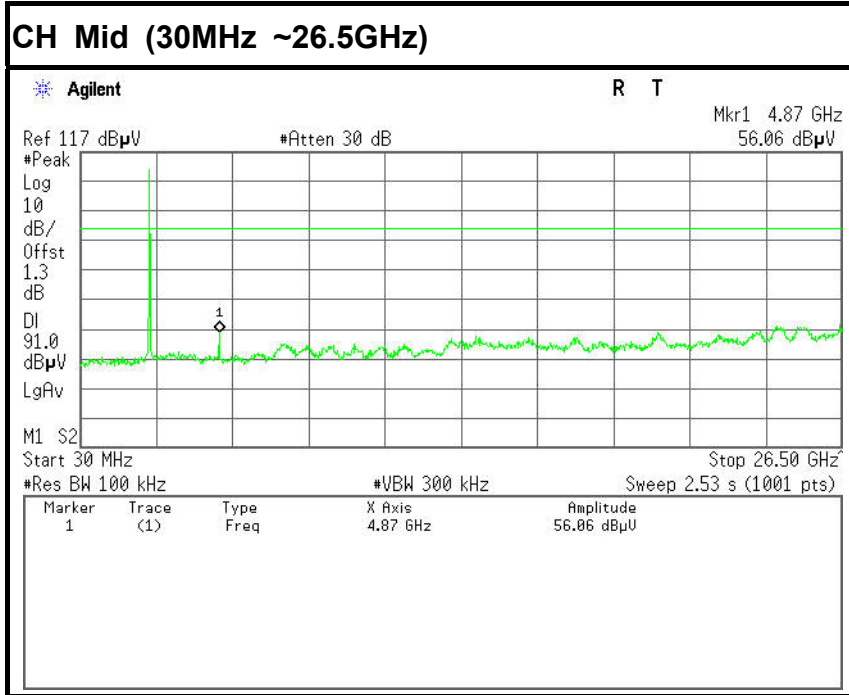



CH High (30MHz ~26.5GHz)

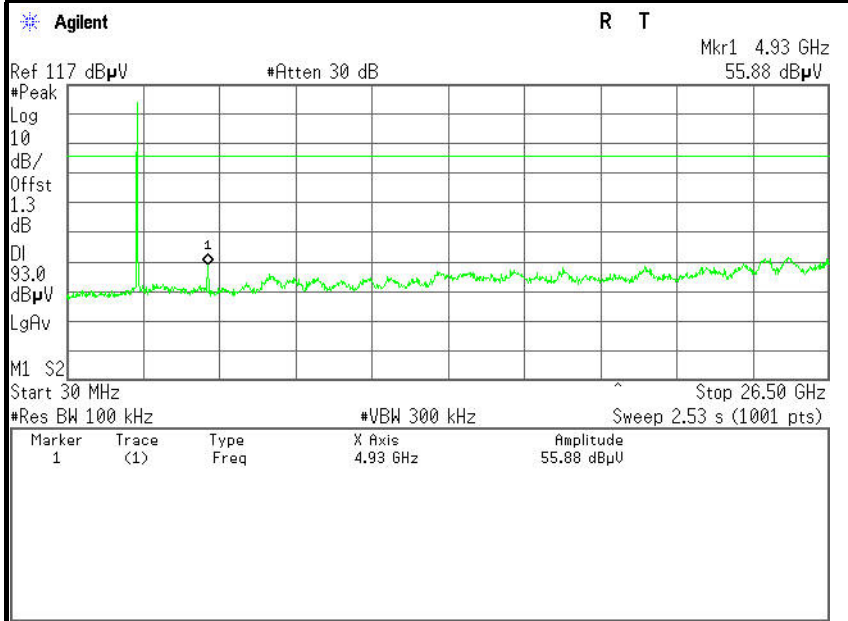

CH High (2.45GHz ~2.5GHz)

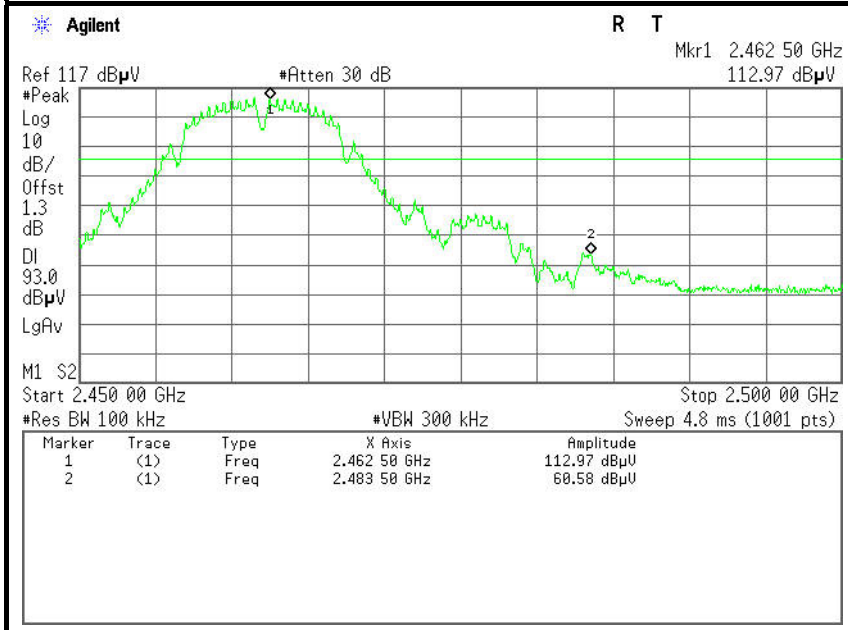



IEEE 802.11g mode (Antenna 0)

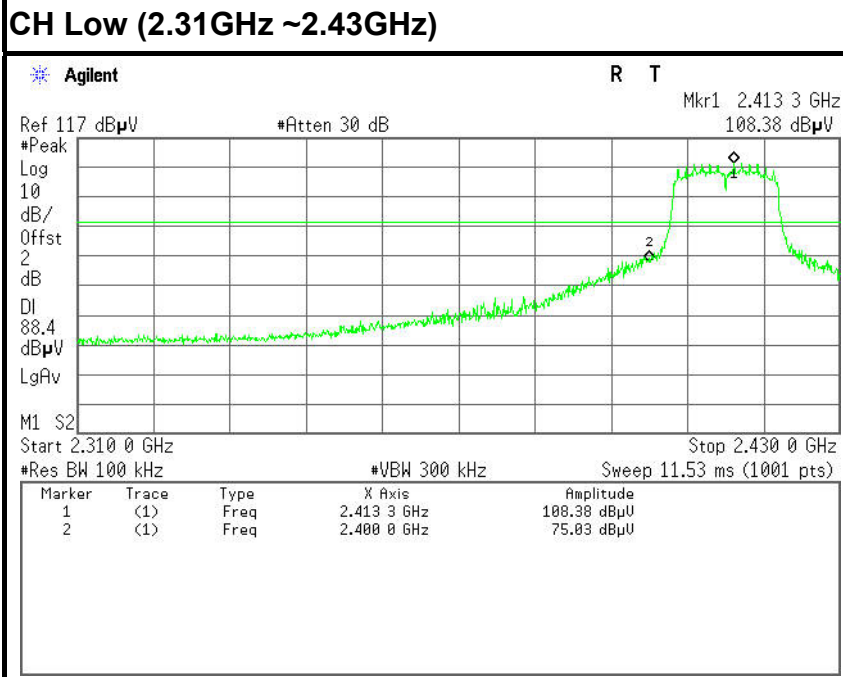
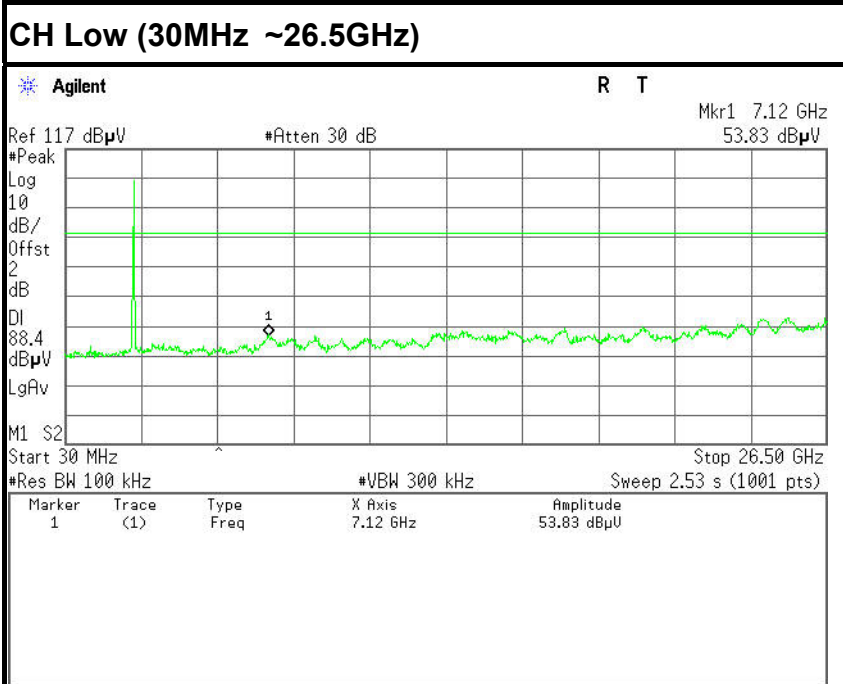

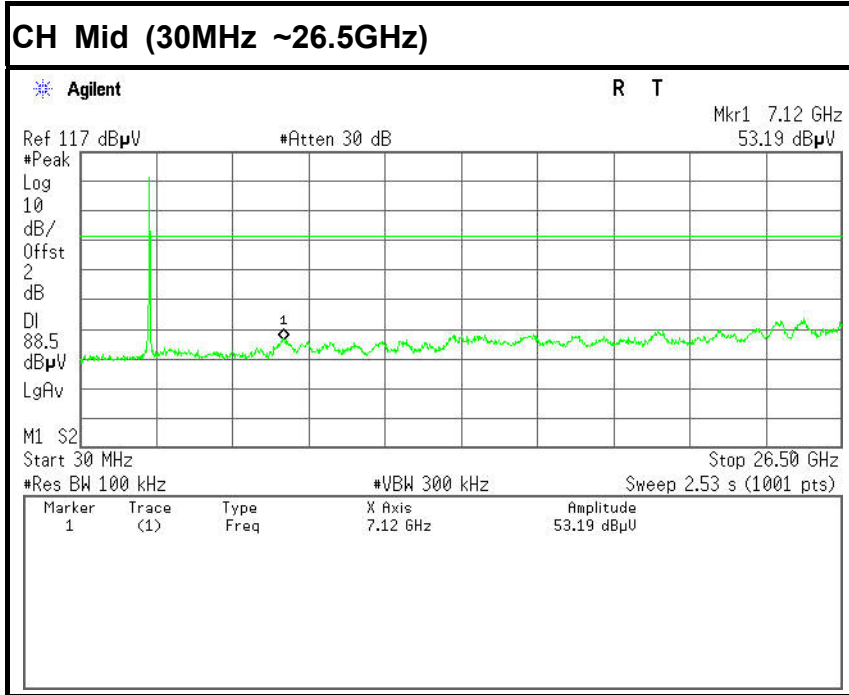



CH High (30MHz ~26.5GHz)

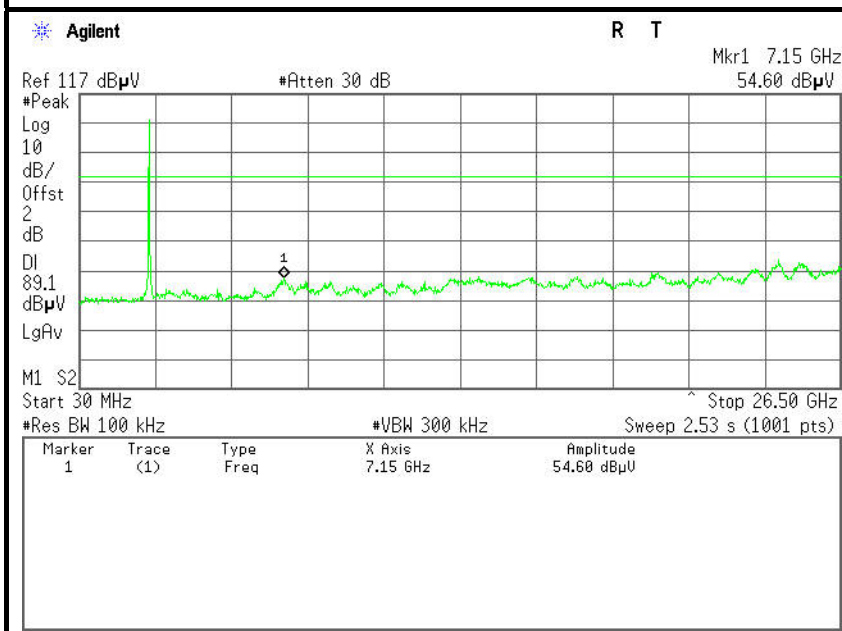

CH High (2.45GHz ~2.5GHz)

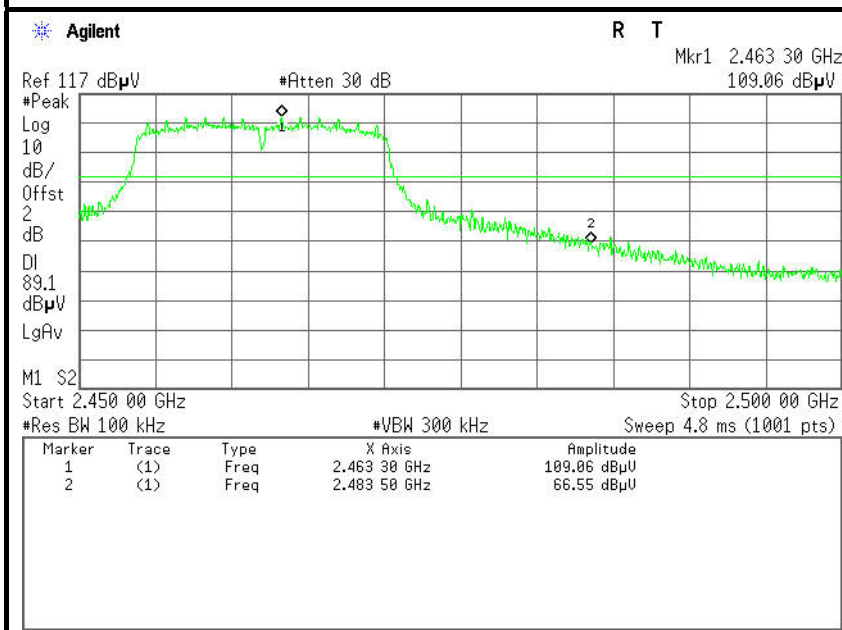



IEEE 802.11g mode (Antenna 1)

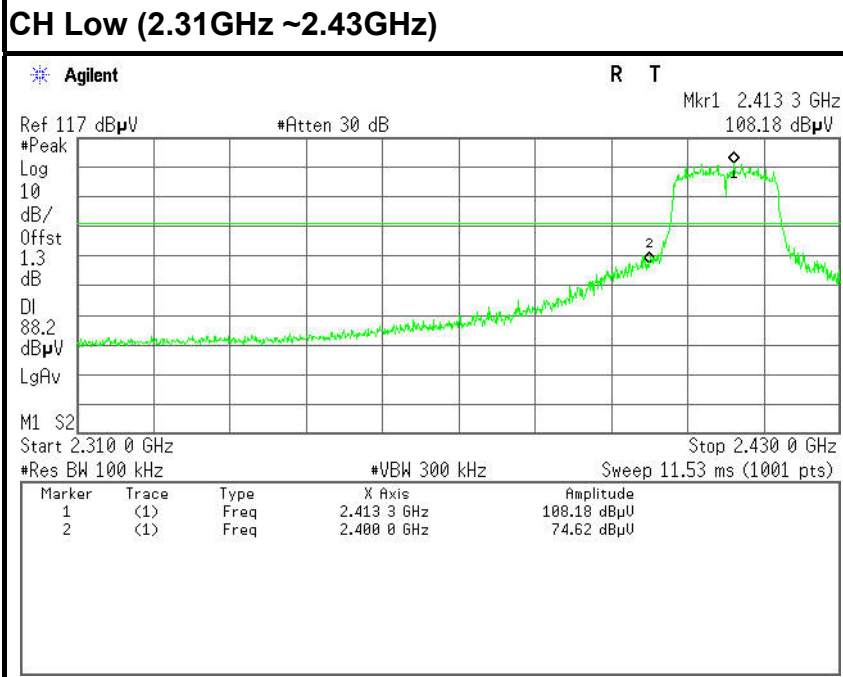
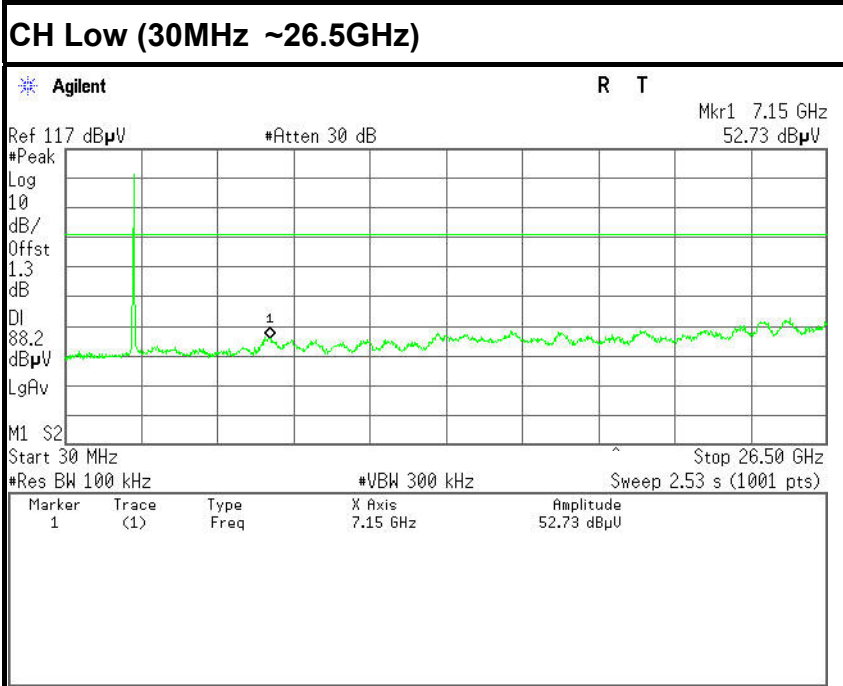

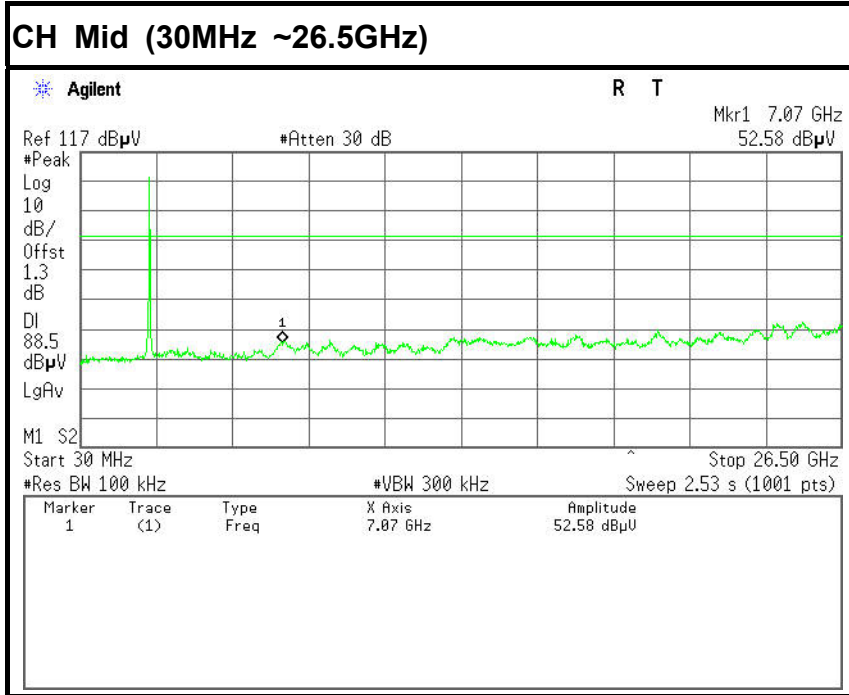



CH High (30MHz ~26.5GHz)

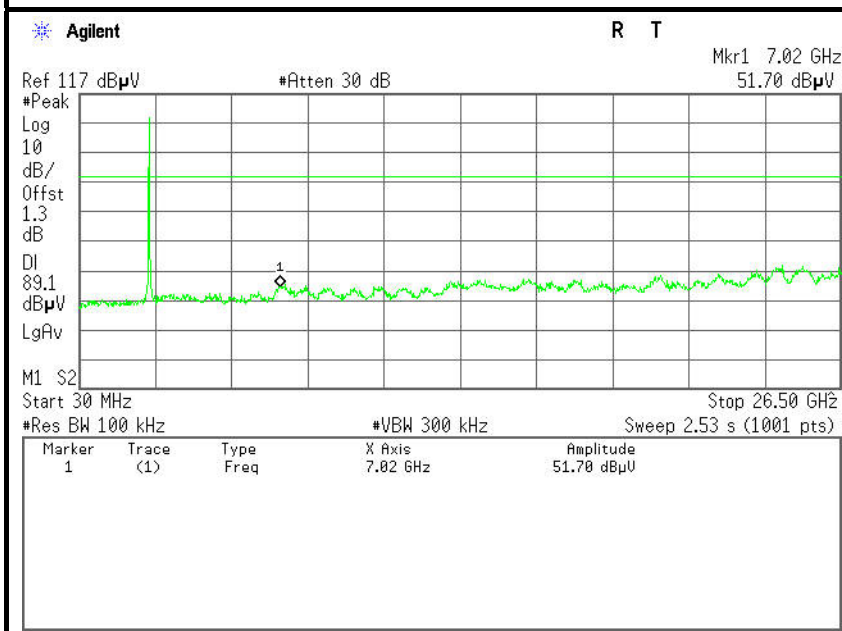

CH High (2.45GHz ~2.5GHz)

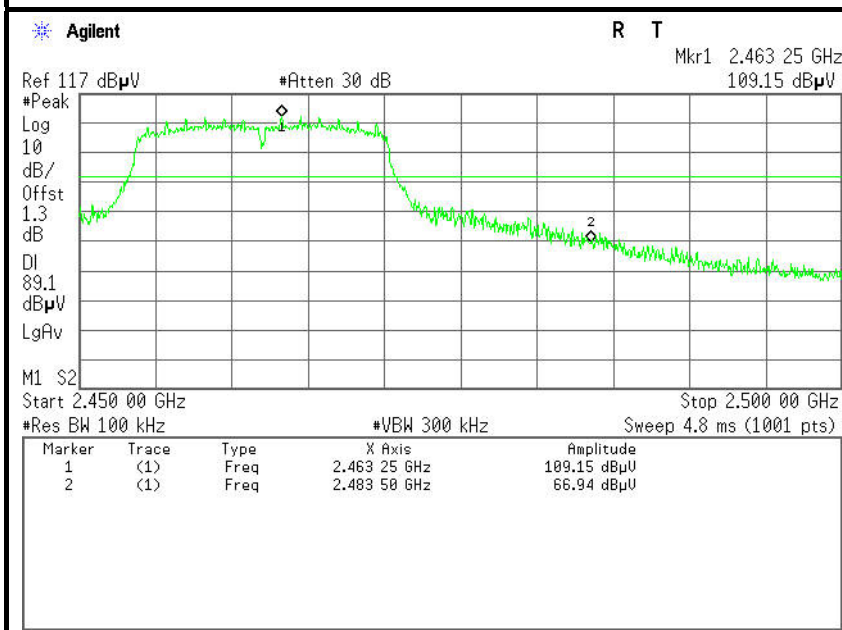



IEEE 802.11n HT20 MHz mode (Antenna 0)

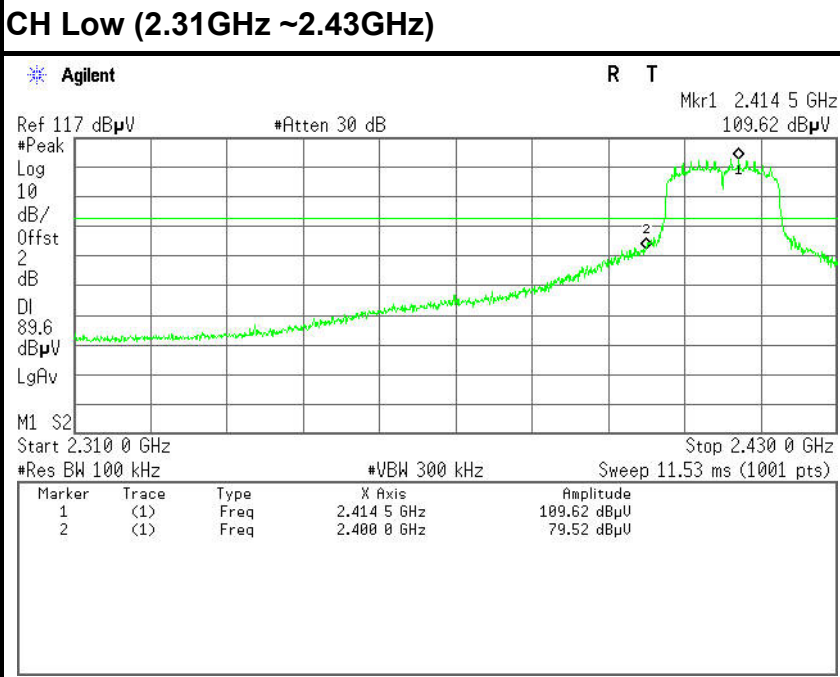
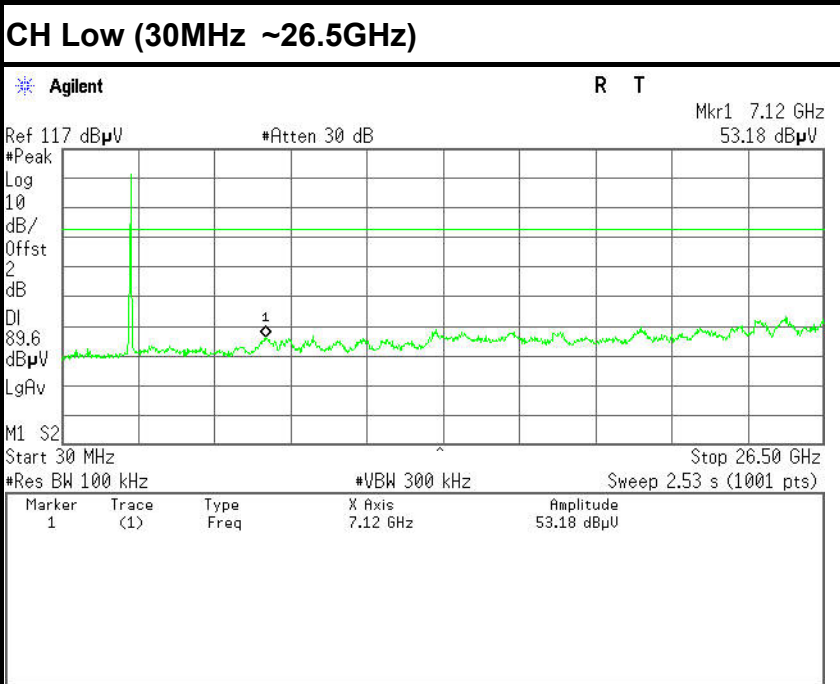

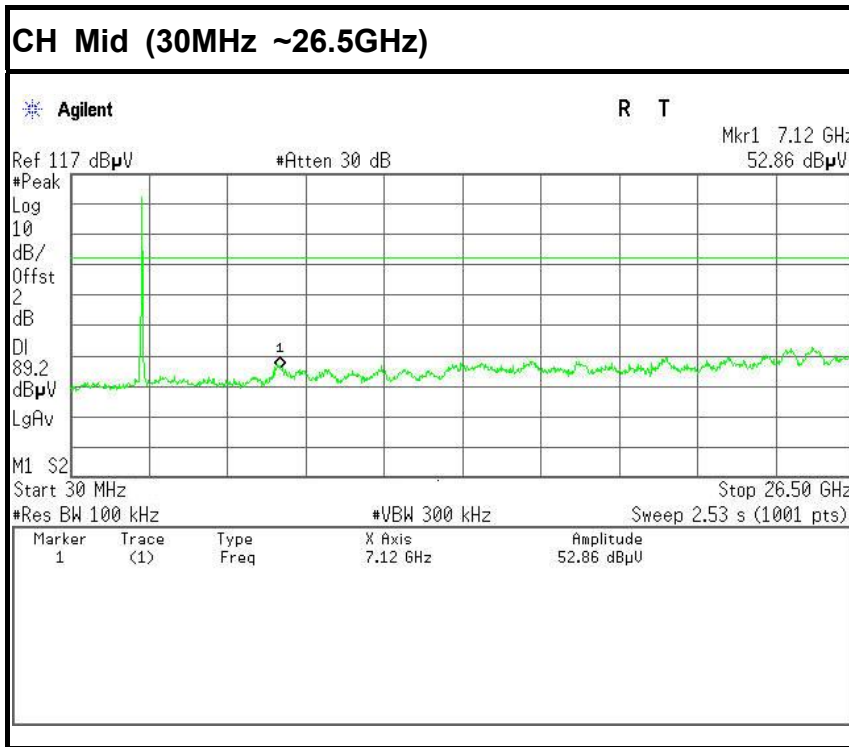

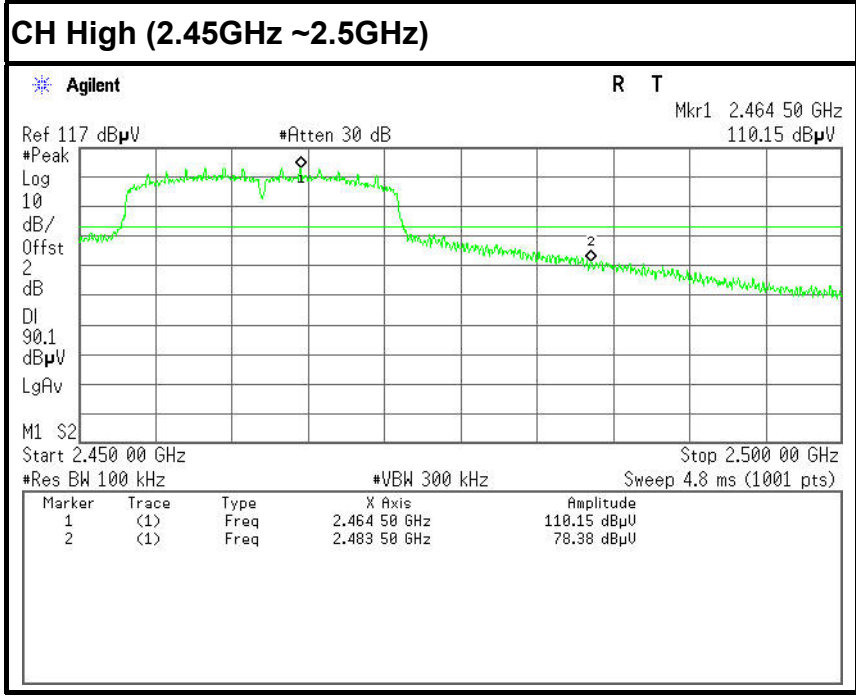
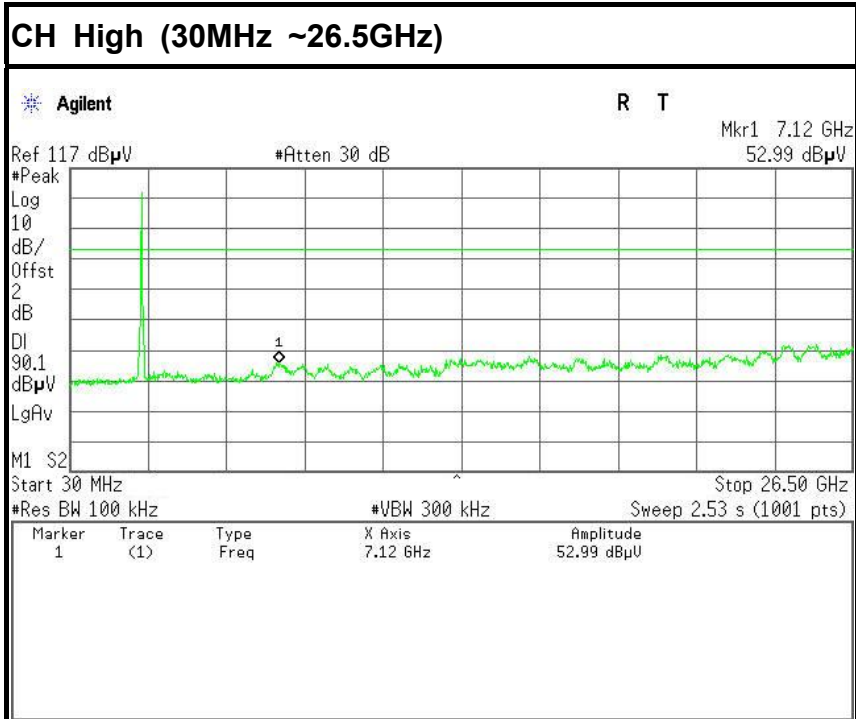



IEEE 802.11n HT20 MHz mode (Antenna 1)

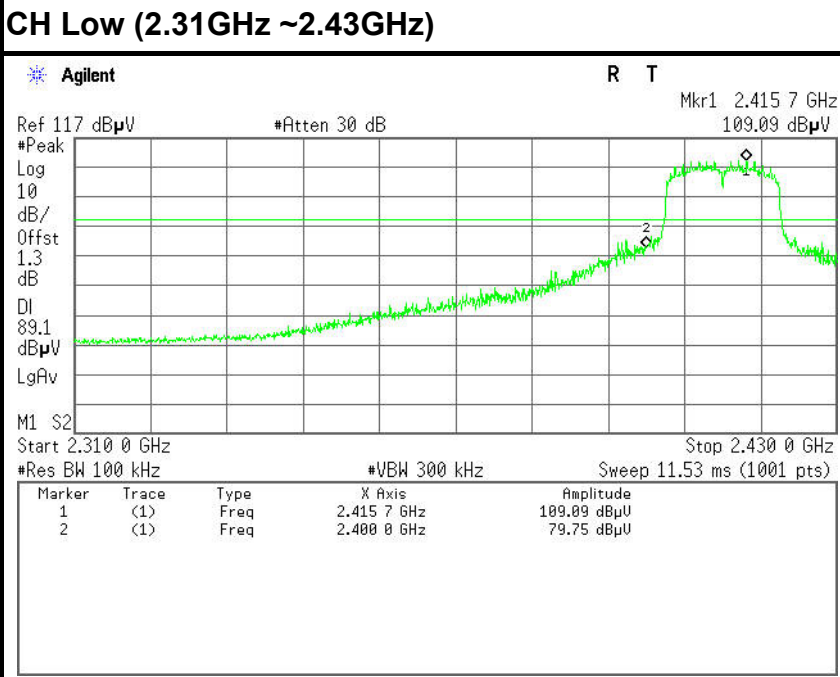
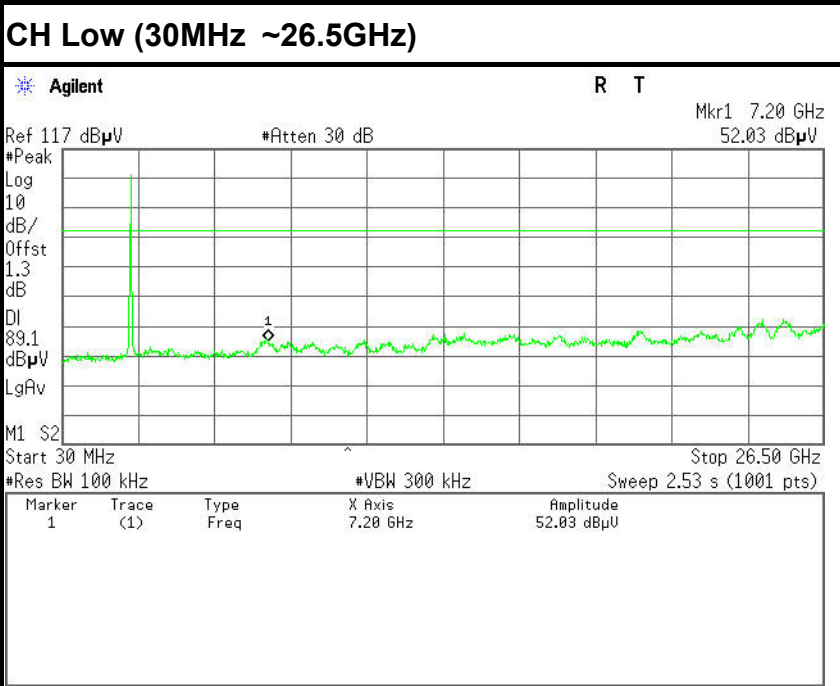

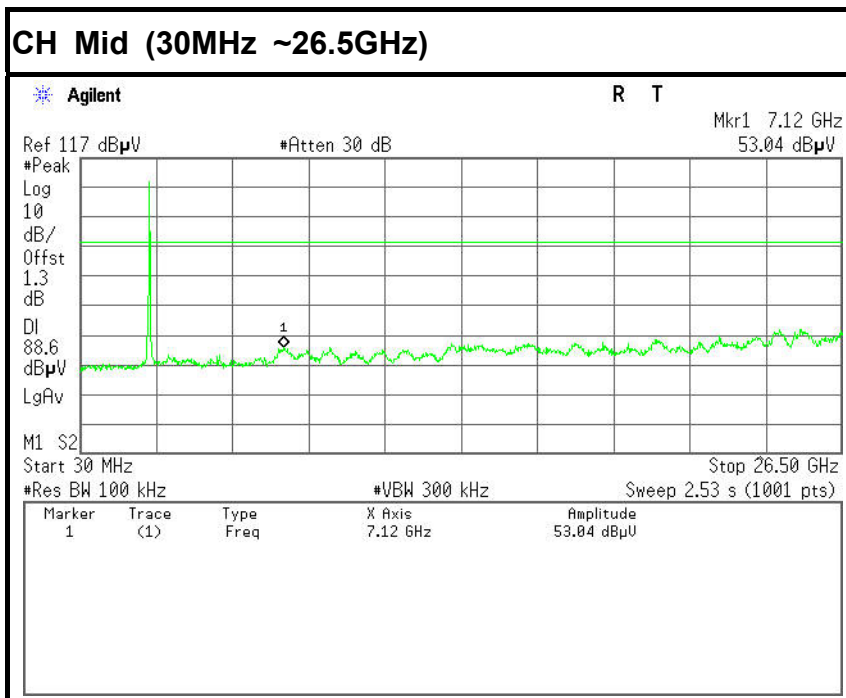



CH High (30MHz ~26.5GHz)

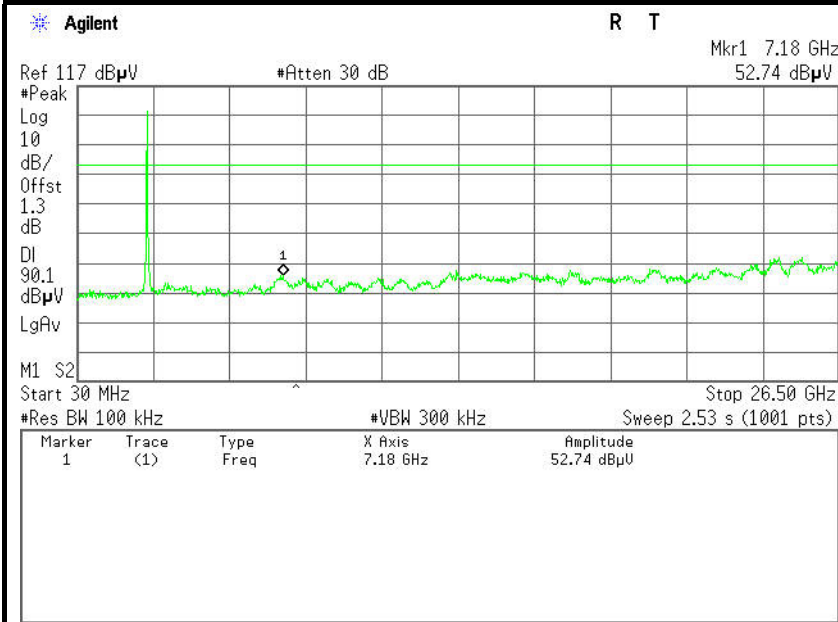

CH High (2.45GHz ~2.5GHz)

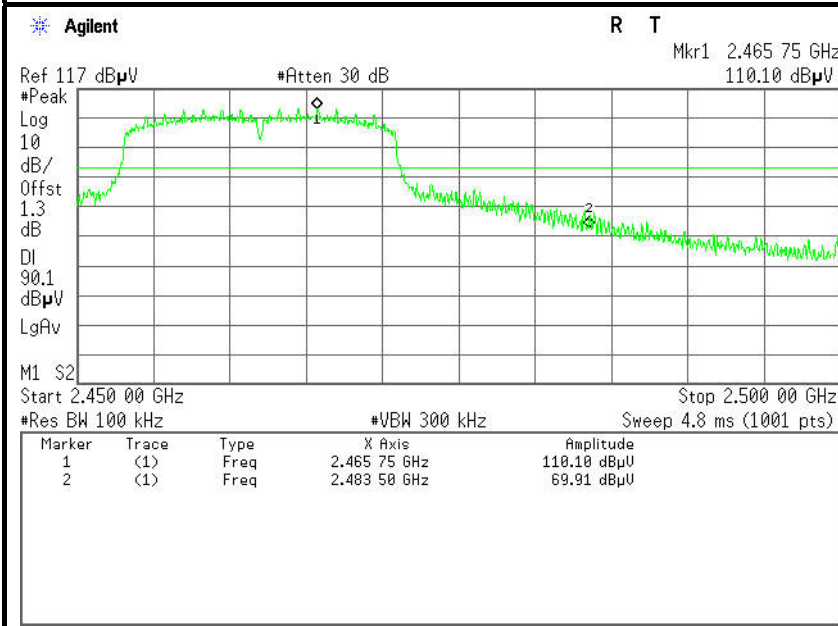



IEEE 802.11n HT20 SISO mode (Antenna 0)

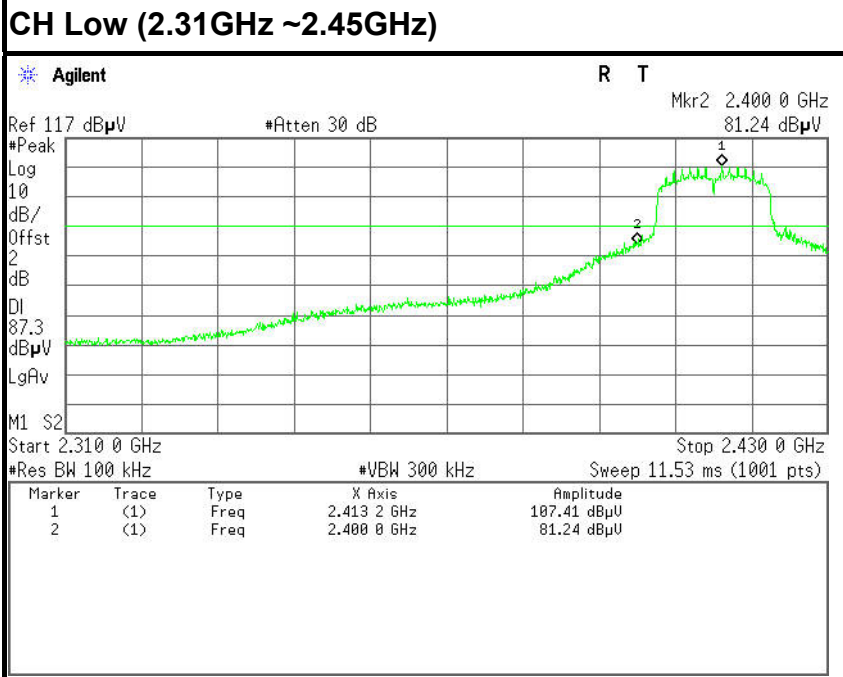
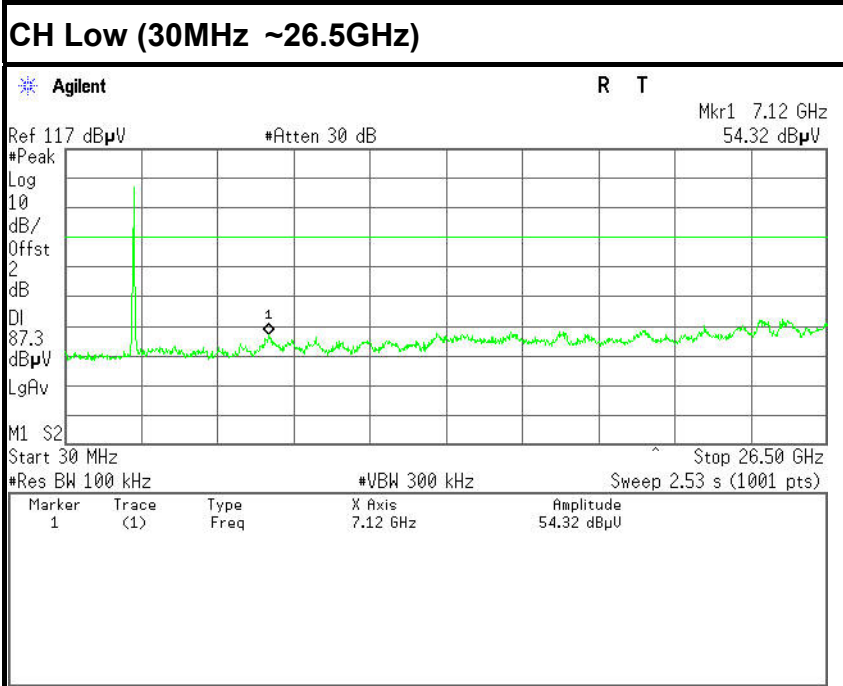

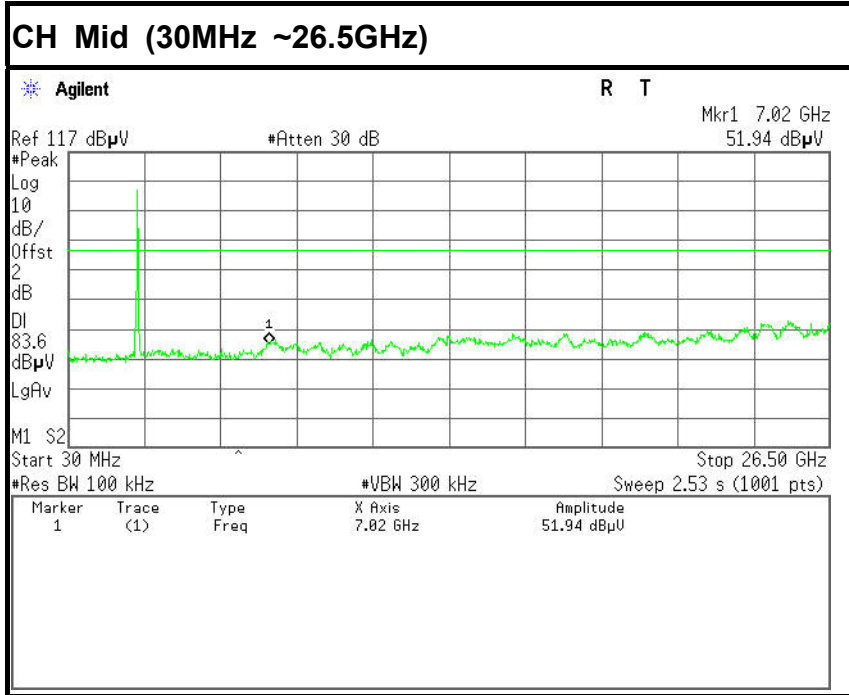

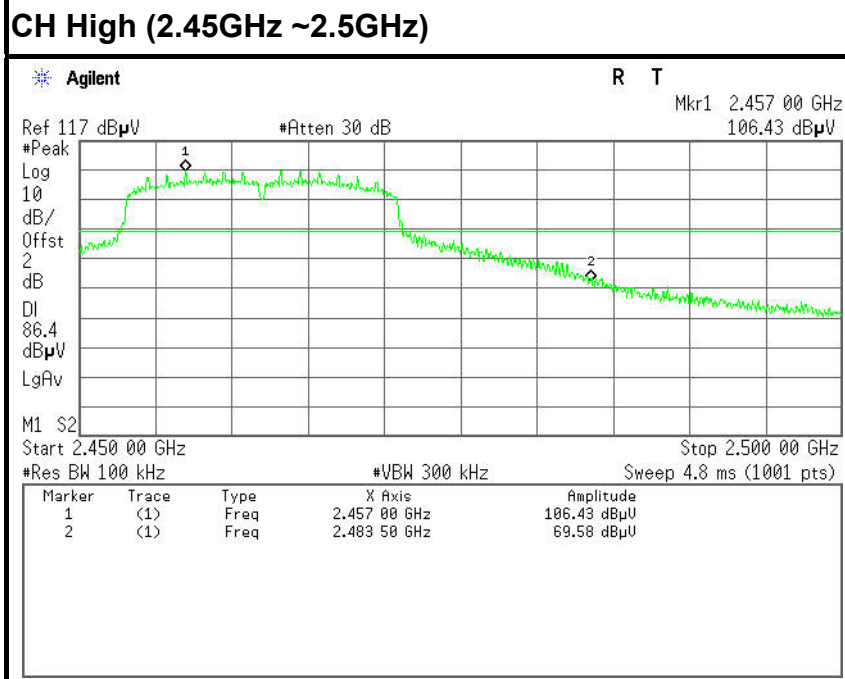
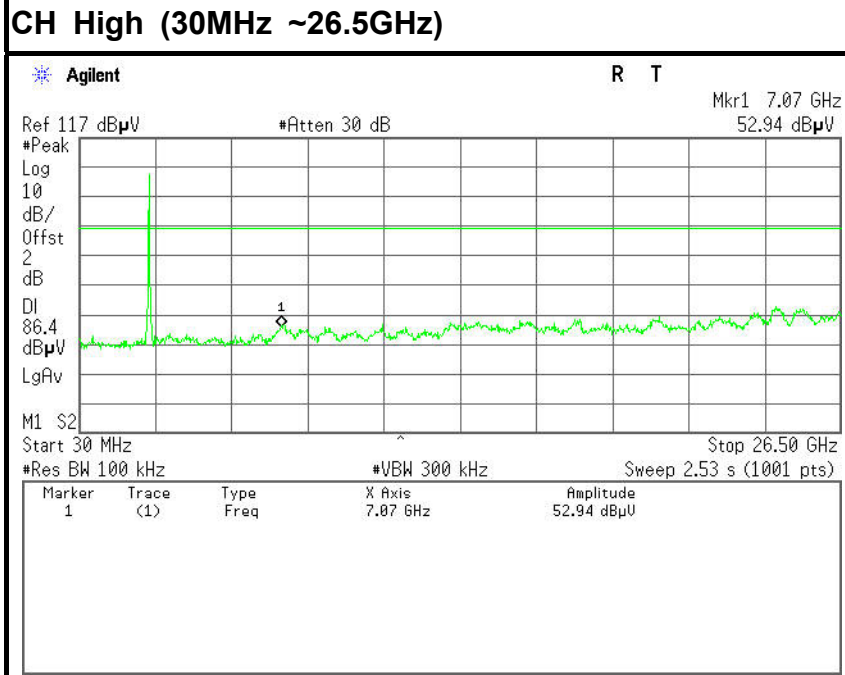



IEEE 802.11n HT20 SISO mode (Antenna 1)

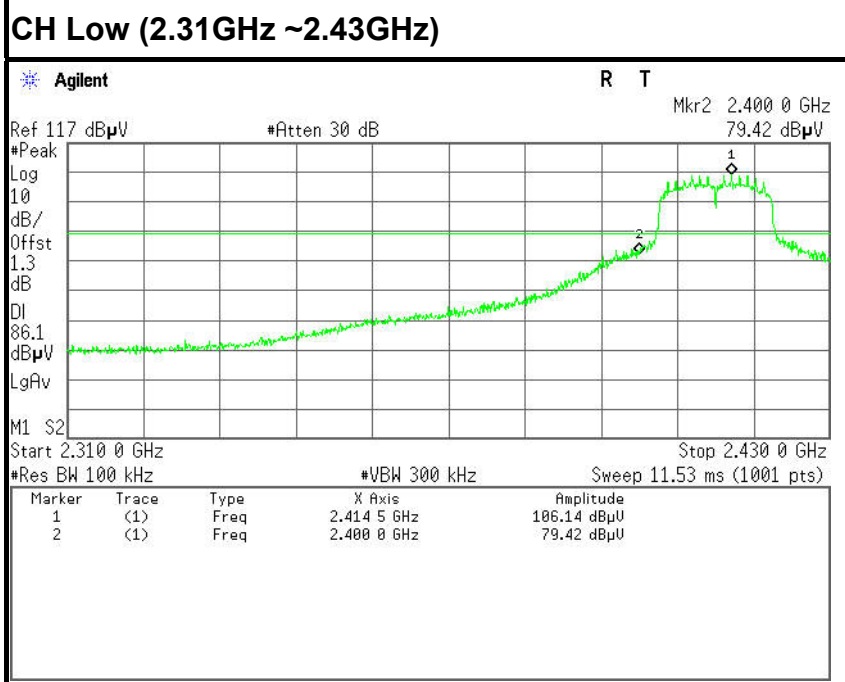
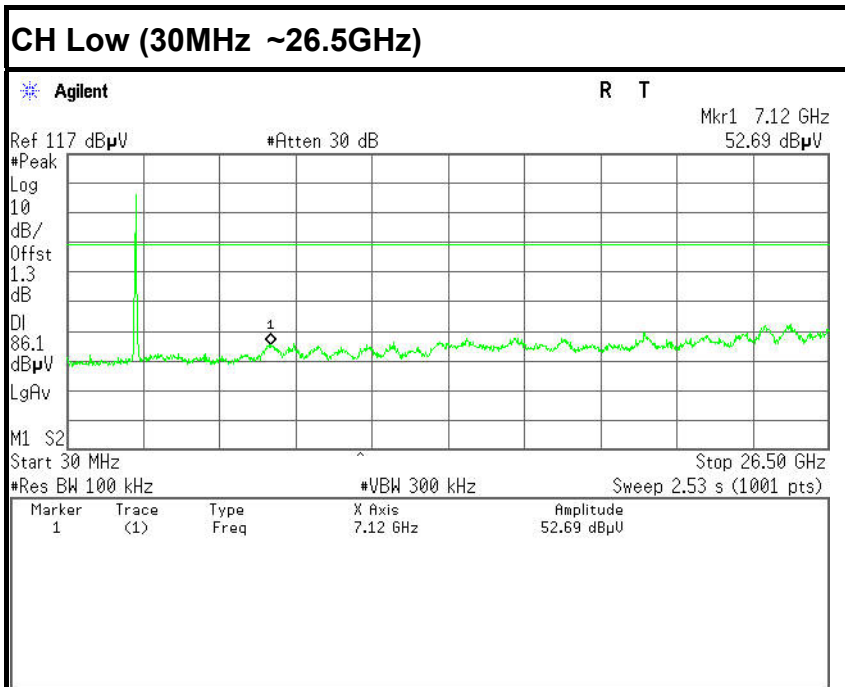

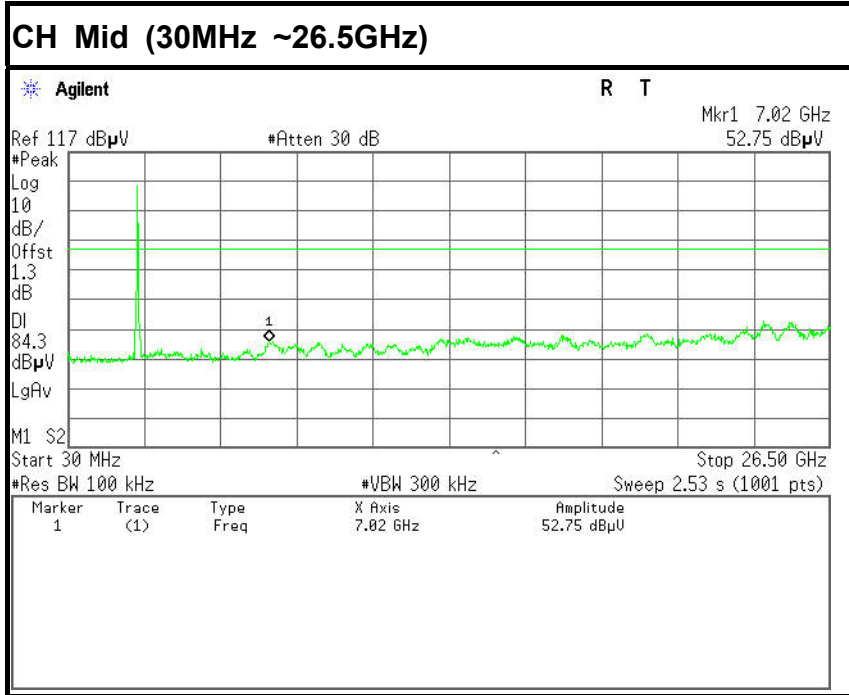



CH High (30MHz ~26.5GHz)

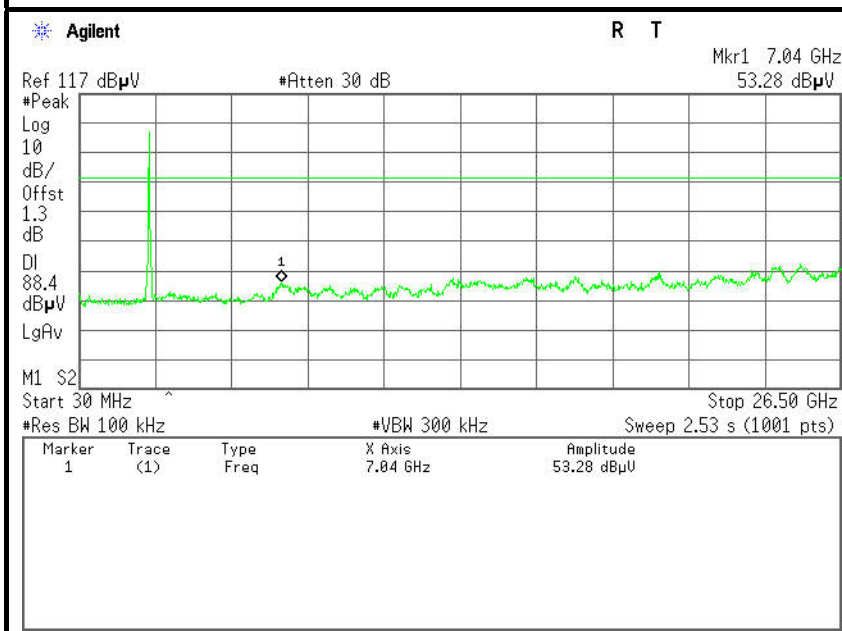

CH High (2.45GHz ~2.5GHz)

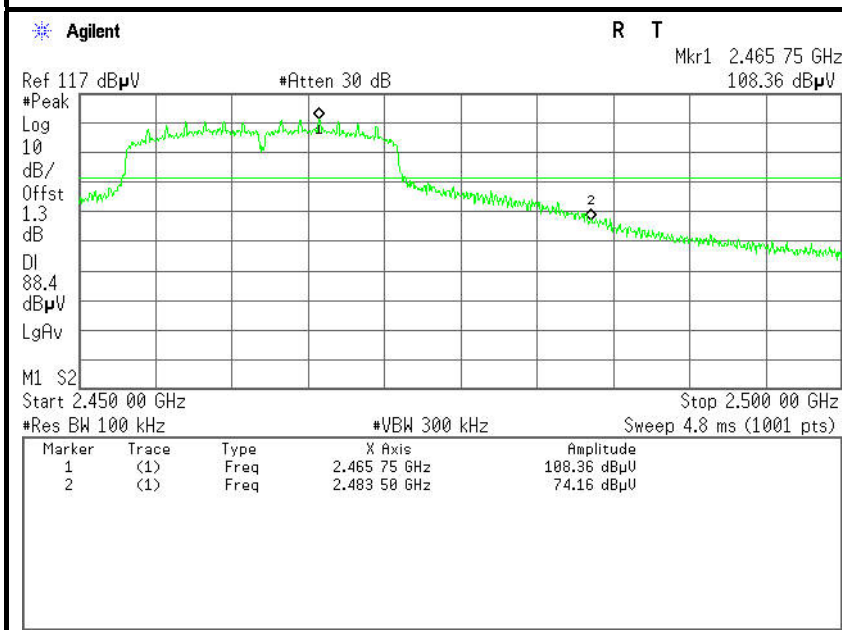



7.2.2. RADIATED EMISSIONS MEASUREMENT

7.2.2.1. LIMITS OF RADIATED EMISSIONS MEASUREMENT

According to §15.209(a), except as provided elsewhere in this Subpart, the emissions from an intentional radiator shall not exceed the field strength levels specified in the following table:

Frequency (MHz)	Field Strength (mV/m)	Measurement Distance (m)
0.009-0.490	2400/F(kHz)	300
0.490-1.705	24000/F(kHz)	30
1.705-30.0	30	30
30-88	100*	3
88-216	150*	3
216-960	200*	3
Above 960	500	3

Remark: Except as provided in paragraph (g), fundamental emissions from intentional radiators operating under this Section shall not be located in the frequency bands 54-72 MHz, 76-88 MHz, 174-216 MHz or 470-806 MHz. However, operation within these frequency bands is permitted under other sections of this Part, e.g., Sections 15.231 and 15.241.

1. In the emission table above, the tighter limit applies at the band edges.

Frequency (MHz)	Field Strength (µV/m at 3-meter)	Field Strength (dBµV/m at 3-meter)
30-88	100	40
88-216	150	43.5
216-960	200	46
Above 960	500	54

NOTE:(1) The lower limit shall apply at the transition frequencies.
(2) Emission level (dBuV/m) = 20 log Emission level (uV/m).



7.2.2.2. TEST INSTRUMENTS

Radiated Emission Test Site 966 (2)					
Name of Equipment	Manufacturer	Model Number	Serial Number	Last Calibration	Due Calibration
PSA Series Spectrum Analyzer	Agilent	E4446A	US44300399	03/01/2014	03/01/2015
EMI TEST RECEIVER	ROHDE&SCHWARZ	ESCI	100783	03/09/2014	03/08/2015
Amplifier	MITEQ	AM-1604-3000	1123808	03/18/2015	03/18/2015
High Noise Amplifier	Agilent	8449B	3008A01838	03/18/2015	03/18/2015
Board-Band Horn Antenna	Schwarzbeck	BBHA 9170	9170-497	07/10/2013	07/09/2014
Bilog Antenna	SCHAFFNER	CBL6143	5082	03/01/2014	03/01/2015
Horn Antenna	SCHWARZBECK	BBHA9120	D286	03/01/2014	03/01/2015
Loop Antenna	COM-POWER	AL-130	121044	09/27/2013	09/26/2014
Turn Table	N/A	N/A	N/A	N.C.R	N.C.R
Controller	Sunol Sciences	SC104V	022310-1	N.C.R	N.C.R
Controller	CT	N/A	N/A	N.C.R	N.C.R
Temp. / Humidity Meter	Anymetre	JR913	N/A	02/28/2014	02/28/2015
Antenna Tower	SUNOL	TLT2	N/A	N.C.R	N.C.R
Test S/W	FARAD	LZ-RF / CCS-SZ-3A2			

- NOTE:** 1. The calibration interval of the above test instruments is 12 months and the calibrations are traceable to NML/ROC and NIST/USA.
2. The FCC Site Registration number is 101879.
3. N.C.R = No Calibration Required.



7.2.2.3. TEST PROCEDURE (please refer to measurement standard)

1. The EUT is placed on a turntable, which is 0.8m above ground plane.
2. The turntable shall be rotated for 360 degrees to determine the position of maximum emission level.
3. EUT is set 3m away from the receiving antenna, which is varied from 1m to 4m to find out the highest emissions.
4. Maximum procedure was performed on the six highest emissions to ensure EUT compliance.
5. And also, each emission was to be maximized by changing the polarization of receiving antenna both horizontal and vertical.
6. Set the spectrum analyzer in the following setting as:
 - Below 1GHz:
 - RBW=100kHz / VBW=300kHz / Sweep=AUTO
 - Above 1GHz:
 - (a) PEAK: RBW=1MHz,VBW=3MHz / Sweep=AUTO
 - (b) AVERAGE: RBW=1MHz / VBW=10Hz / Sweep=AUTO
7. Repeat above procedures until the measurements for all frequencies are complete.



7.2.2.4. TEST SETUP

Below 30MHz

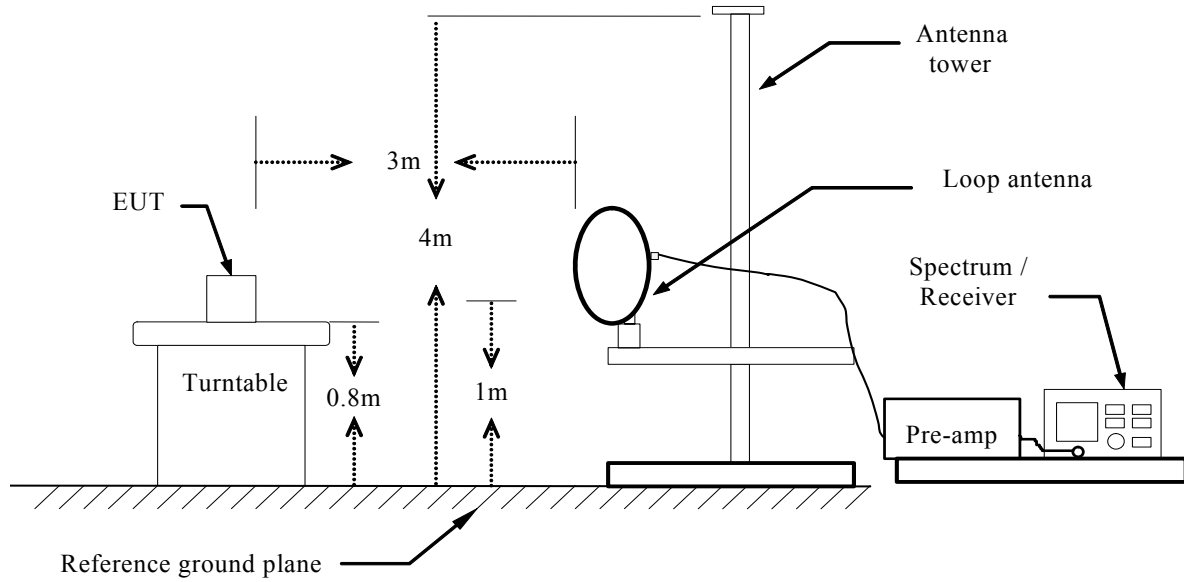

Below 1 GHz

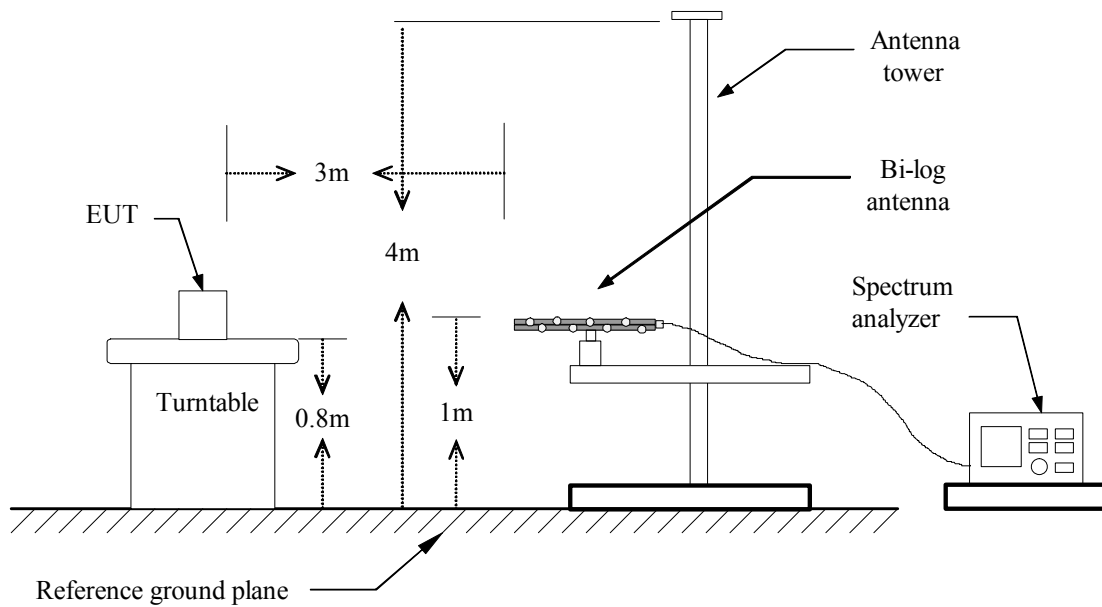



Above 1 GHz

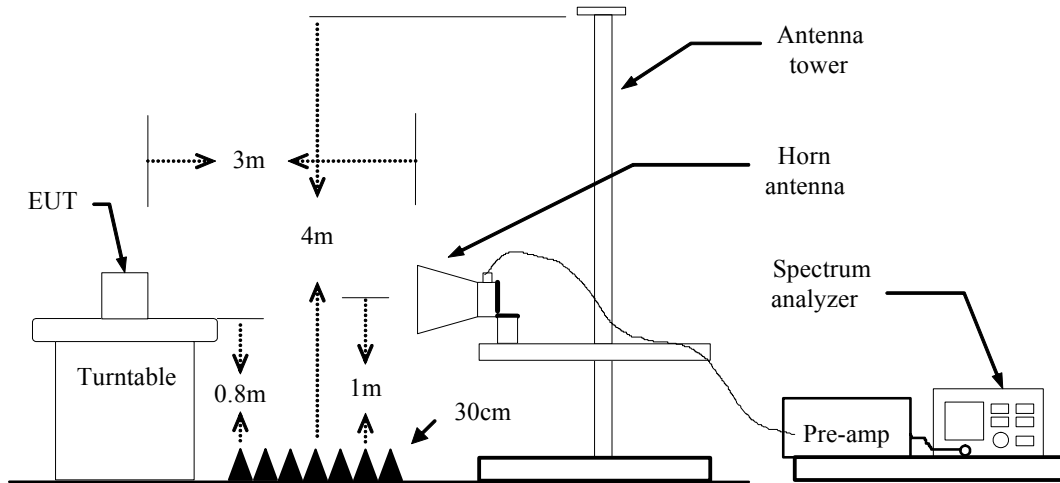

For the actual test configuration, please refer to the related item – Photographs of the Test Configuration.



7.2.2.5. DATA SAPLE

Below 1GHz

Frequency (MHz)	Reading (dBuV)	Correct Factor (dB/m)	Result (dBuV/m)	Limit (dBuV/m)	Margin (dB)	Antenna Pole (V/H)	Remark
XXX.XXXX	36.37	-12.20	24.17	40.00	-15.83	V	QP

Frequency (MHz) = Emission frequency in MHz
 Reading (dBuV) = Uncorrected Analyzer / Receiver reading
 Correct Factor (dB/m) = Antenna factor + Cable loss – Amplifier gain
 Result (dBuV/m) = Reading (dBuV) + Corr. Factor (dB/m)
 Limit (dBuV/m) = Limit stated in standard
 Margin (dB) = Result (dBuV/m) – Limit (dBuV/m)
 Q.P. = Quasi-peak Reading

Above 1GHz

Frequency (MHz)	Reading (dBuV)	Correction Factor (dB/m)	Result (dBuV/m)	Limit (dBuV/m)	Margin (dB)	Antenna Pole (V/H)	Remark
XXXX.XXXX	62.09	-11.42	50.67	74.00	-23.33	V	Peak
XXXX.XXXX	49.78	-11.42	38.36	54.00	-15.64	V	AVG

Frequency (MHz) = Emission frequency in MHz
 Reading (dBuV) = Uncorrected Analyzer / Receiver reading
 Correction Factor (dB/m) = Antenna factor + Cable loss – Amplifier gain
 Result (dBuV/m) = Reading (dBuV) + Corr. Factor (dB/m)
 Limit (dBuV/m) = Limit stated in standard
 Margin (dB) = Result (dBuV/m) – Limit (dBuV/m)
 Peak = Peak Reading
 AVG = Average Reading

Calculation Formula

Margin (dB) = Result (dBuV/m) – Limits (dBuV/m)
 Result (dBuV/m) = Reading (dBuV) + Correction Factor



7.2.2.6. TEST RESULTS

Below 1 GHz

Test Mode: TX

Tested by: Sun Guo

Ambient temperature: 24°C Relative humidity: 52% RH

Date: May 12, 2014

Frequency (MHz)	Reading (dBuV)	Correction Factor (dB/m)	Result (dBuV/m)	Limit (dBuV/m)	Margin (dB)	Antenna Pole (V/H)	Remark
110.5100	55.91	-20.88	35.03	43.50	-8.47	V	QP
199.7500	54.24	-18.72	35.52	43.50	-7.98	V	QP
329.7300	52.26	-17.47	34.79	46.00	-11.21	V	QP
600.3600	47.92	-12.94	34.98	46.00	-11.02	V	QP
700.2700	45.48	-10.33	35.15	46.00	-10.85	V	QP
770.1100	45.22	-10.84	34.38	46.00	-11.62	V	QP
42.6100	49.63	-14.91	34.72	40.00	-5.28	H	QP
186.1700	55.36	-18.59	36.77	43.50	-6.73	H	QP
393.7500	52.37	-16.33	36.04	46.00	-9.96	H	QP
700.2700	45.69	-10.33	35.36	46.00	-10.64	H	QP
752.6500	47.98	-11.33	36.65	46.00	-9.35	H	QP
823.4600	43.44	-10.73	32.71	46.00	-13.29	H	QP

**Remark: No emission found between lowest internal used/generated frequency to 30MHz.

Notes:

- Radiated emissions measured in frequency range from 9kHz to 1GHz were made with an instrument using Quasi-peak detector mode.
- Data of measurement within this frequency range shown " --- " in the table above means the reading of emissions are attenuated more than 20dB below the permissible limits or the field strength is too small to be measured.
- The IF bandwidth of Receiver between 30MHz to 1GHz was 120kHz.
- | | |
|------------------------|--|
| Frequency (MHz). | = Emission frequency in MHz |
| Reading (dBuV/m) | = Receiver reading |
| Correction Factor (dB) | = Antenna factor + Cable loss – Amplifier gain |
| Limit (dBuV/m) | = Limit stated in standard |
| Margin (dB) | = Measured (dBuV/m) – Limits (dBuV/m) |
| Antenna Pol e(H/V) | = Current carrying line of reading |



Above 1 GHz

Antenna 0

Test Mode: TX / IEEE 802.11b(CH Low)

Tested by: Sun Guo

Ambient temperature: 24°C **Relative humidity:** 52% RH

Date: May 12, 2014

Frequency (MHz)	Reading (dBuV)	Correction Factor (dB/m)	Result (dBuV/m)	Limit (dBuV/m)	Margin (dB)	Antenna Pole (V/H)	Remark
1999.000	49.70	-6.61	43.09	74.00	-30.91	V	peak
3313.000	44.30	-2.83	41.47	74.00	-32.53	V	peak
4825.000	42.65	2.86	45.51	74.00	-28.49	V	peak
6013.000	40.43	7.58	48.01	74.00	-25.99	V	peak
6544.000	40.67	7.34	48.01	74.00	-25.99	V	peak
7660.000	40.56	7.55	48.11	74.00	-25.89	V	peak
1666.000	49.72	-8.37	41.35	74.00	-32.65	H	Peak
4825.000	44.27	2.86	47.13	74.00	-26.87	H	Peak
5356.000	43.24	4.24	47.48	74.00	-26.52	H	Peak
6148.000	41.34	7.52	48.86	74.00	-25.14	H	peak
6985.000	41.30	7.14	48.44	74.00	-25.56	H	peak
8434.000	40.75	8.12	48.87	74.00	-25.13	H	peak

REMARKS:

1. Measuring frequencies from 1 GHz to the 10th harmonic of highest fundamental frequency.
2. Radiated emissions measured in frequency above 1000MHz were made with an instrument using peak/average detector mode.
3. Average test would be performed if the peak result were greater than the average limit or as required by the applicant.
4. Data of measurement within this frequency range shown " --- " in the table above means the reading of emissions are attenuated more than 20dB below the permissible limits or the field strength is too small to be measured.
5. Measurements above show only up to 6 maximum emissions noted, or would be lesser, with " N/A " remark, if no specific emissions from the EUT are recorded (ie: margin>20dB from the applicable limit) and considered that's already beyond the background noise floor.
6. Margin (dB) = Remark result (dBuV/m) – Average limit (dBuV/m).



Test Mode: TX / IEEE 802.11b (CH Mid)

Tested by: Sun Guo

Ambient temperature: 24°C Relative humidity: 52% RH

Date: May 12, 2014

Frequency (MHz)	Reading (dBuV)	Correction Factor (dB/m)	Result (dBuV/m)	Limit (dBuV/m)	Margin (dB)	Antenna Pole (V/H)	Remark
1999.000	47.96	-6.61	41.35	74.00	-32.65	V	Peak
3475.000	42.77	-1.27	41.50	74.00	-32.50	V	Peak
4870.000	43.30	3.13	46.43	74.00	-27.57	V	Peak
6040.000	40.43	7.57	48.00	74.00	-26.00	V	Peak
6931.000	40.95	7.16	48.11	74.00	-25.89	V	Peak
7813.000	40.03	7.65	47.68	74.00	-26.32	V	Peak
1999.000	46.55	-6.61	39.94	74.00	-34.06	H	Peak
3628.000	42.93	-0.90	42.03	74.00	-31.97	H	Peak
4870.000	44.42	3.13	47.55	74.00	-26.45	H	Peak
6184.000	40.49	7.51	48.00	74.00	-26.00	H	Peak
6985.000	41.24	7.14	48.38	74.00	-25.62	H	Peak
7741.000	41.64	7.60	49.24	74.00	-24.76	H	Peak

REMARKS:

1. Measuring frequencies from 1 GHz to the 10th harmonic of highest fundamental frequency.
2. Radiated emissions measured in frequency above 1000MHz were made with an instrument using peak/average detector mode.
3. Average test would be performed if the peak result were greater than the average limit or as required by the applicant.
4. Data of measurement within this frequency range shown " --- " in the table above means the reading of emissions are attenuated more than 20dB below the permissible limits or the field strength is too small to be measured.
5. Measurements above show only up to 6 maximum emissions noted, or would be lesser, with " N/A " remark, if no specific emissions from the EUT are recorded (ie: margin>20dB from the applicable limit) and considered that's already beyond the background noise floor.
6. Margin (dB) = Remark result (dBuV/m) – Average limit (dBuV/m).



Test Mode: TX / IEEE 802.11b (CH High)

Tested by: Sun Guo

Ambient temperature: 24°C Relative humidity: 52% RH

Date: May 12, 2014

Frequency (MHz)	Reading (dBuV)	Correction Factor (dB/m)	Result (dBuV/m)	Limit (dBuV/m)	Margin (dB)	Antenna Pole (V/H)	Remark
1999.000	49.60	-6.61	42.99	74.00	-31.01	V	Peak
3799.000	43.31	-0.73	42.58	74.00	-31.42	V	Peak
5104.000	41.54	4.01	45.55	74.00	-28.45	V	Peak
5896.000	41.05	6.92	47.97	74.00	-26.03	V	Peak
7651.000	40.22	7.55	47.77	74.00	-26.23	V	Peak
8920.000	41.45	8.52	49.97	74.00	-24.03	V	Peak
2584.000	45.29	-7.07	38.22	74.00	-35.78	H	Peak
3700.000	43.61	-0.83	42.78	74.00	-31.22	H	Peak
5095.000	41.92	4.01	45.93	74.00	-28.07	H	Peak
6103.000	40.51	7.54	48.05	74.00	-25.95	H	Peak
6733.000	40.34	7.25	47.59	74.00	-26.41	H	Peak
7705.000	40.13	7.58	47.71	74.00	-26.29	H	Peak

REMARKS:

1. Measuring frequencies from 1 GHz to the 10th harmonic of highest fundamental frequency.
2. Radiated emissions measured in frequency above 1000MHz were made with an instrument using peak/average detector mode.
3. Average test would be performed if the peak result were greater than the average limit or as required by the applicant.
4. Data of measurement within this frequency range shown " --- " in the table above means the reading of emissions are attenuated more than 20dB below the permissible limits or the field strength is too small to be measured.
5. Measurements above show only up to 6 maximum emissions noted, or would be lesser, with " N/A " remark, if no specific emissions from the EUT are recorded (ie: margin>20dB from the applicable limit) and considered that's already beyond the background noise floor.
6. Margin (dB) = Remark result (dBuV/m) – Average limit (dBuV/m).



Antenna 1

Test Mode: TX / IEEE 802.11b(CH Low)

Tested by: Sun Guo

Ambient temperature: 24°C **Relative humidity:** 52% RH

Date: May 12, 2014

Frequency (MHz)	Reading (dBuV)	Correction Factor (dB/m)	Result (dBuV/m)	Limit (dBuV/m)	Margin (dB)	Antenna Pole (V/H)	Remark
1990.000	49.42	-6.69	42.73	74.00	-31.27	V	peak
3331.000	45.54	-2.66	42.88	74.00	-31.12	V	peak
5041.000	41.16	3.96	45.12	74.00	-28.88	V	peak
6274.000	40.31	7.46	47.77	74.00	-26.23	V	peak
6958.000	40.82	7.15	47.97	74.00	-26.03	V	peak
7597.000	41.00	7.51	48.51	74.00	-25.49	V	peak
2098.000	46.62	-6.74	39.88	74.00	-34.12	H	Peak
3898.000	43.01	-0.63	42.38	74.00	-31.62	H	Peak
5005.000	41.61	3.92	45.53	74.00	-28.47	H	Peak
5923.000	41.18	7.09	48.27	74.00	-25.73	H	peak
6427.000	40.42	7.39	47.81	74.00	-26.19	H	peak
7606.000	40.59	7.52	48.11	74.00	-25.89	H	peak

REMARKS:

1. Measuring frequencies from 1 GHz to the 10th harmonic of highest fundamental frequency.
2. Radiated emissions measured in frequency above 1000MHz were made with an instrument using peak/average detector mode.
3. Average test would be performed if the peak result were greater than the average limit or as required by the applicant.
4. Data of measurement within this frequency range shown " --- " in the table above means the reading of emissions are attenuated more than 20dB below the permissible limits or the field strength is too small to be measured.
5. Measurements above show only up to 6 maximum emissions noted, or would be lesser, with " N/A " remark, if no specific emissions from the EUT are recorded (ie: margin>20dB from the applicable limit) and considered that's already beyond the background noise floor.
6. Margin (dB) = Remark result (dBuV/m) – Average limit (dBuV/m).



Test Mode: TX / IEEE 802.11b (CH Mid)

Tested by: Sun Guo

Ambient temperature: 24°C Relative humidity: 52% RH

Date: May 12, 2014

Frequency (MHz)	Reading (dBuV)	Correction Factor (dB/m)	Result (dBuV/m)	Limit (dBuV/m)	Margin (dB)	Antenna Pole (V/H)	Remark
1999.000	50.11	-6.61	43.50	74.00	-30.50	V	Peak
3349.000	44.31	-2.48	41.83	74.00	-32.17	V	Peak
4870.000	41.45	3.13	44.58	74.00	-29.42	V	Peak
5950.000	39.93	7.27	47.20	74.00	-26.80	V	Peak
6499.000	41.20	7.36	48.56	74.00	-25.44	V	Peak
8038.000	40.01	7.80	47.81	74.00	-26.19	V	Peak
1999.000	46.69	-6.61	40.08	74.00	-33.92	H	Peak
3511.000	43.15	-1.02	42.13	74.00	-31.87	H	Peak
5059.000	41.71	3.97	45.68	74.00	-28.32	H	Peak
5986.000	40.76	7.50	48.26	74.00	-25.74	H	Peak
6661.000	41.12	7.29	48.41	74.00	-25.59	H	Peak
7786.000	40.51	7.63	48.14	74.00	-25.86	H	Peak

REMARKS:

1. Measuring frequencies from 1 GHz to the 10th harmonic of highest fundamental frequency.
2. Radiated emissions measured in frequency above 1000MHz were made with an instrument using peak/average detector mode.
3. Average test would be performed if the peak result were greater than the average limit or as required by the applicant.
4. Data of measurement within this frequency range shown " --- " in the table above means the reading of emissions are attenuated more than 20dB below the permissible limits or the field strength is too small to be measured.
5. Measurements above show only up to 6 maximum emissions noted, or would be lesser, with " N/A " remark, if no specific emissions from the EUT are recorded (ie: margin>20dB from the applicable limit) and considered that's already beyond the background noise floor.
6. Margin (dB) = Remark result (dBuV/m) – Average limit (dBuV/m).



Test Mode: TX / IEEE 802.11b (CH High)

Tested by: Sun Guo

Ambient temperature: 24°C Relative humidity: 52% RH

Date: May 12, 2014

Frequency (MHz)	Reading (dBuV)	Correction Factor (dB/m)	Result (dBuV/m)	Limit (dBuV/m)	Margin (dB)	Antenna Pole (V/H)	Remark
1999.000	48.36	-6.61	41.75	74.00	-32.25	V	Peak
3493.000	43.01	-1.10	41.91	74.00	-32.09	V	Peak
4888.000	41.67	3.24	44.91	74.00	-29.09	V	Peak
6202.000	41.31	7.50	48.81	74.00	-25.19	V	Peak
7534.000	40.96	7.47	48.43	74.00	-25.57	V	Peak
8317.000	40.84	8.03	48.87	74.00	-25.13	V	Peak
2152.000	46.15	-6.82	39.33	74.00	-34.67	H	Peak
3835.000	43.01	-0.70	42.31	74.00	-31.69	H	Peak
5167.000	41.68	4.07	45.75	74.00	-28.25	H	Peak
5851.000	41.56	6.63	48.19	74.00	-25.81	H	Peak
6589.000	40.48	7.32	47.80	74.00	-26.20	H	Peak
7615.000	40.01	7.52	47.53	74.00	-26.47	H	Peak

REMARKS:

1. Measuring frequencies from 1 GHz to the 10th harmonic of highest fundamental frequency.
2. Radiated emissions measured in frequency above 1000MHz were made with an instrument using peak/average detector mode.
3. Average test would be performed if the peak result were greater than the average limit or as required by the applicant.
4. Data of measurement within this frequency range shown " --- " in the table above means the reading of emissions are attenuated more than 20dB below the permissible limits or the field strength is too small to be measured.
5. Measurements above show only up to 6 maximum emissions noted, or would be lesser, with " N/A " remark, if no specific emissions from the EUT are recorded (ie: margin>20dB from the applicable limit) and considered that's already beyond the background noise floor.
6. Margin (dB) = Remark result (dBuV/m) – Average limit (dBuV/m).



Antenna 0

Test Mode: TX / IEEE 802.11g(CH Low)

Tested by: Sun Guo

Ambient temperature: 24°C **Relative humidity:** 52% RH

Date: May 12, 2014

Frequency (MHz)	Reading (dBuV)	Correction Factor (dB/m)	Result (dBuV/m)	Limit (dBuV/m)	Margin (dB)	Antenna Pole (V/H)	Remark
1999.000	50.20	-6.61	43.59	74.00	-30.41	V	Peak
3898.000	43.06	-0.63	42.43	74.00	-31.57	V	Peak
4825.000	43.18	2.86	46.04	74.00	-27.96	V	Peak
6202.000	40.63	7.50	48.13	74.00	-25.87	V	Peak
7579.000	40.73	7.50	48.23	74.00	-25.77	V	Peak
8785.000	40.54	8.41	48.95	74.00	-25.05	V	Peak
3466.000	44.57	-1.36	43.21	74.00	-30.79	H	Peak
4789.000	41.82	2.64	44.46	74.00	-29.54	H	Peak
5464.000	41.28	4.34	45.62	74.00	-28.38	H	Peak
6328.000	41.41	7.44	48.85	74.00	-25.15	H	Peak
6904.000	41.37	7.17	48.54	74.00	-25.46	H	Peak
8371.000	41.17	8.07	49.24	74.00	-24.76	H	Peak

REMARKS:

1. Measuring frequencies from 1 GHz to the 10th harmonic of highest fundamental frequency.
2. Radiated emissions measured in frequency above 1000MHz were made with an instrument using peak/average detector mode.
3. Average test would be performed if the peak result were greater than the average limit or as required by the applicant.
4. Data of measurement within this frequency range shown " --- " in the table above means the reading of emissions are attenuated more than 20dB below the permissible limits or the field strength is too small to be measured.
5. Measurements above show only up to 6 maximum emissions noted, or would be lesser, with " N/A " remark, if no specific emissions from the EUT are recorded (ie: margin>20dB from the applicable limit) and considered that's already beyond the background noise floor.
6. Margin (dB) = Remark result (dBuV/m) – Average limit (dBuV/m).



Test Mode: TX / IEEE 802.11g (CH Mid)

Tested by: Sun Guo

Ambient temperature: 24°C Relative humidity: 52% RH

Date: May 12, 2014

Frequency (MHz)	Reading (dBuV)	Correction Factor (dB/m)	Result (dBuV/m)	Limit (dBuV/m)	Margin (dB)	Antenna Pole (V/H)	Remark
1999.000	50.61	-6.61	44.00	74.00	-30.00	V	Peak
3511.000	42.22	-1.02	41.20	74.00	-32.80	V	Peak
5284.000	41.69	4.18	45.87	74.00	-28.13	V	Peak
5887.000	41.11	6.86	47.97	74.00	-26.03	V	Peak
6940.000	40.83	7.16	47.99	74.00	-26.01	V	Peak
7624.000	40.50	7.53	48.03	74.00	-25.97	V	Peak
3421.000	42.65	-1.79	40.86	74.00	-33.14	H	Peak
4357.000	42.50	0.48	42.98	74.00	-31.02	H	Peak
5932.000	41.86	7.15	49.01	74.00	-24.99	H	Peak
6931.000	40.75	7.16	47.91	74.00	-26.09	H	Peak
7777.000	40.32	7.63	47.95	74.00	-26.05	H	Peak
8821.000	40.27	8.44	48.71	74.00	-25.29	H	Peak

REMARKS:

1. Measuring frequencies from 1 GHz to the 10th harmonic of highest fundamental frequency.
2. Radiated emissions measured in frequency above 1000MHz were made with an instrument using peak/average detector mode.
3. Average test would be performed if the peak result were greater than the average limit or as required by the applicant.
4. Data of measurement within this frequency range shown " --- " in the table above means the reading of emissions are attenuated more than 20dB below the permissible limits or the field strength is too small to be measured.
5. Measurements above show only up to 6 maximum emissions noted, or would be lesser, with " N/A " remark, if no specific emissions from the EUT are recorded (ie: margin>20dB from the applicable limit) and considered that's already beyond the background noise floor.
6. Margin (dB) = Remark result (dBuV/m) – Average limit (dBuV/m).



Test Mode: TX / IEEE 802.11g (CH High)

Tested by: Sun Guo

Ambient temperature: 24°C Relative humidity: 52% RH

Date: May 12, 2014

Frequency (MHz)	Reading (dBuV)	Correction Factor (dB/m)	Result (dBuV/m)	Limit (dBuV/m)	Margin (dB)	Antenna Pole (V/H)	Remark
1990.000	49.27	-6.69	42.58	74.00	-31.42	V	Peak
3448.000	43.90	-1.53	42.37	74.00	-31.63	V	Peak
4987.000	41.47	3.84	45.31	74.00	-28.69	V	Peak
5770.000	41.96	6.11	48.07	74.00	-25.93	V	Peak
6931.000	42.29	7.16	49.45	74.00	-24.55	V	Peak
7921.000	40.10	7.72	47.82	74.00	-26.18	V	Peak
1999.000	45.91	-6.61	39.30	74.00	-34.70	H	Peak
3898.000	43.47	-0.63	42.84	74.00	-31.16	H	Peak
5041.000	41.45	3.96	45.41	74.00	-28.59	H	Peak
5959.000	42.21	7.33	49.54	74.00	-24.46	H	Peak
6895.000	41.61	7.18	48.79	74.00	-25.21	H	Peak
7705.000	40.80	7.58	48.38	74.00	-25.62	H	Peak

REMARKS:

1. Measuring frequencies from 1 GHz to the 10th harmonic of highest fundamental frequency.
2. Radiated emissions measured in frequency above 1000MHz were made with an instrument using peak/average detector mode.
3. Average test would be performed if the peak result were greater than the average limit or as required by the applicant.
4. Data of measurement within this frequency range shown " --- " in the table above means the reading of emissions are attenuated more than 20dB below the permissible limits or the field strength is too small to be measured.
5. Measurements above show only up to 6 maximum emissions noted, or would be lesser, with " N/A " remark, if no specific emissions from the EUT are recorded (ie: margin>20dB from the applicable limit) and considered that's already beyond the background noise floor.
6. Margin (dB) = Remark result (dBuV/m) – Average limit (dBuV/m).



Antenna 1

Test Mode: TX / IEEE 802.11g(CH Low)

Tested by: Sun Guo

Ambient temperature: 24°C **Relative humidity:** 52% RH

Date: May 12, 2014

Frequency (MHz)	Reading (dBuV)	Correction Factor (dB/m)	Result (dBuV/m)	Limit (dBuV/m)	Margin (dB)	Antenna Pole (V/H)	Remark
1999.000	48.06	-6.61	41.45	74.00	-32.55	V	Peak
3439.000	43.89	-1.62	42.27	74.00	-31.73	V	Peak
4222.000	42.62	0.10	42.72	74.00	-31.28	V	Peak
5248.000	41.41	4.14	45.55	74.00	-28.45	V	Peak
6040.000	41.04	7.57	48.61	74.00	-25.39	V	Peak
7930.000	41.06	7.73	48.79	74.00	-25.21	V	Peak
1999.000	47.10	-6.61	40.49	74.00	-33.51	H	Peak
3358.000	44.28	-2.40	41.88	74.00	-32.12	H	Peak
4168.000	42.97	-0.06	42.91	74.00	-31.09	H	Peak
5086.000	42.57	4.00	46.57	74.00	-27.43	H	Peak
6049.000	41.05	7.57	48.62	74.00	-25.38	H	Peak
8362.000	40.87	8.06	48.93	74.00	-25.07	H	Peak

REMARKS:

1. Measuring frequencies from 1 GHz to the 10th harmonic of highest fundamental frequency.
2. Radiated emissions measured in frequency above 1000MHz were made with an instrument using peak/average detector mode.
3. Average test would be performed if the peak result were greater than the average limit or as required by the applicant.
4. Data of measurement within this frequency range shown " --- " in the table above means the reading of emissions are attenuated more than 20dB below the permissible limits or the field strength is too small to be measured.
5. Measurements above show only up to 6 maximum emissions noted, or would be lesser, with " N/A " remark, if no specific emissions from the EUT are recorded (ie: margin>20dB from the applicable limit) and considered that's already beyond the background noise floor.
6. Margin (dB) = Remark result (dBuV/m) – Average limit (dBuV/m).



Test Mode: TX / IEEE 802.11g (CH Mid)

Tested by: Sun Guo

Ambient temperature: 24°C Relative humidity: 52% RH

Date: May 12, 2014

Frequency (MHz)	Reading (dBuV)	Correction Factor (dB/m)	Result (dBuV/m)	Limit (dBuV/m)	Margin (dB)	Antenna Pole (V/H)	Remark
1999.000	48.80	-6.61	42.19	74.00	-31.81	V	Peak
3376.000	43.77	-2.22	41.55	74.00	-32.45	V	Peak
5203.000	41.12	4.10	45.22	74.00	-28.78	V	Peak
6022.000	40.65	7.58	48.23	74.00	-25.77	V	Peak
6859.000	40.51	7.19	47.70	74.00	-26.30	V	Peak
7507.000	40.35	7.45	47.80	74.00	-26.20	V	Peak
1999.000	47.88	-6.61	41.27	74.00	-32.73	H	Peak
3763.000	43.11	-0.77	42.34	74.00	-31.66	H	Peak
5311.000	41.14	4.20	45.34	74.00	-28.66	H	Peak
6013.000	40.55	7.58	48.13	74.00	-25.87	H	Peak
7741.000	40.60	7.60	48.20	74.00	-25.80	H	Peak
8389.000	40.88	8.09	48.97	74.00	-25.03	H	Peak

REMARKS:

1. Measuring frequencies from 1 GHz to the 10th harmonic of highest fundamental frequency.
2. Radiated emissions measured in frequency above 1000MHz were made with an instrument using peak/average detector mode.
3. Average test would be performed if the peak result were greater than the average limit or as required by the applicant.
4. Data of measurement within this frequency range shown " --- " in the table above means the reading of emissions are attenuated more than 20dB below the permissible limits or the field strength is too small to be measured.
5. Measurements above show only up to 6 maximum emissions noted, or would be lesser, with " N/A " remark, if no specific emissions from the EUT are recorded (ie: margin>20dB from the applicable limit) and considered that's already beyond the background noise floor.
6. Margin (dB) = Remark result (dBuV/m) – Average limit (dBuV/m).



Test Mode: TX / IEEE 802.11g (CH High)

Tested by: Sun Guo

Ambient temperature: 24°C Relative humidity: 52% RH

Date: May 12, 2014

Frequency (MHz)	Reading (dBuV)	Correction Factor (dB/m)	Result (dBuV/m)	Limit (dBuV/m)	Margin (dB)	Antenna Pole (V/H)	Remark
1999.000	49.71	-6.61	43.10	74.00	-30.90	V	Peak
3619.000	42.96	-0.91	42.05	74.00	-31.95	V	Peak
4636.000	41.03	1.71	42.74	74.00	-31.26	V	Peak
5878.000	40.18	6.80	46.98	74.00	-27.02	V	Peak
6976.000	41.09	7.14	48.23	74.00	-25.77	V	Peak
7606.000	40.72	7.52	48.24	74.00	-25.76	V	Peak
1999.000	47.26	-6.61	40.65	74.00	-33.35	H	Peak
3835.000	42.75	-0.70	42.05	74.00	-31.95	H	Peak
5203.000	41.53	4.10	45.63	74.00	-28.37	H	Peak
5995.000	41.03	7.56	48.59	74.00	-25.41	H	Peak
6580.000	41.34	7.32	48.66	74.00	-25.34	H	Peak
8065.000	39.82	7.82	47.64	74.00	-26.36	H	Peak

REMARKS:

1. Measuring frequencies from 1 GHz to the 10th harmonic of highest fundamental frequency.
2. Radiated emissions measured in frequency above 1000MHz were made with an instrument using peak/average detector mode.
3. Average test would be performed if the peak result were greater than the average limit or as required by the applicant.
4. Data of measurement within this frequency range shown " --- " in the table above means the reading of emissions are attenuated more than 20dB below the permissible limits or the field strength is too small to be measured.
5. Measurements above show only up to 6 maximum emissions noted, or would be lesser, with " N/A " remark, if no specific emissions from the EUT are recorded (ie: margin>20dB from the applicable limit) and considered that's already beyond the background noise floor.
6. Margin (dB) = Remark result (dBuV/m) – Average limit (dBuV/m).



Combine with Antenna 0 and Antenna 1

Test Mode: TX / IEEE 802.11n HT20 MHz (CH Low)

Tested by: Sun Guo

Ambient temperature: 24°C **Relative humidity:** 52% RH

Date: May 12, 2014

Frequency (MHz)	Reading (dBuV)	Correction Factor (dB/m)	Result (dBuV/m)	Limit (dBuV/m)	Margin (dB)	Antenna Pole (V/H)	Remark
3700.000	43.46	-0.83	42.63	74.00	-31.37	V	Peak
4825.000	43.06	2.86	45.92	74.00	-28.08	V	Peak
6022.000	40.21	7.58	47.79	74.00	-26.21	V	Peak
6580.000	41.71	7.32	49.03	74.00	-24.97	V	Peak
7741.000	40.60	7.60	48.20	74.00	-25.80	V	Peak
9064.000	40.34	8.42	48.76	74.00	-25.24	V	Peak
1297.000	48.79	-10.54	38.25	74.00	-35.75	H	Peak
3439.000	43.18	-1.62	41.56	74.00	-32.44	H	Peak
4870.000	40.97	3.13	44.10	74.00	-29.90	H	Peak
5689.000	40.61	5.59	46.20	74.00	-27.80	H	Peak
6229.000	41.89	7.48	49.37	74.00	-24.63	H	Peak
7651.000	40.49	7.55	48.04	74.00	-25.96	H	Peak

REMARKS:

1. Measuring frequencies from 1 GHz to the 10th harmonic of highest fundamental frequency.
2. Radiated emissions measured in frequency above 1000MHz were made with an instrument using peak/average detector mode.
3. Average test would be performed if the peak result were greater than the average limit or as required by the applicant.
4. Data of measurement within this frequency range shown " --- " in the table above means the reading of emissions are attenuated more than 20dB below the permissible limits or the field strength is too small to be measured.
5. Measurements above show only up to 6 maximum emissions noted, or would be lesser, with " N/A " remark, if no specific emissions from the EUT are recorded (ie: margin>20dB from the applicable limit) and considered that's already beyond the background noise floor.
6. Margin (dB) = Remark result (dBuV/m) – Average limit (dBuV/m).



Test Mode: TX / IEEE 802.11n HT20 MHz (CH Mid)

Tested by: Sun Guo

Ambient temperature: 24°C Relative humidity: 52% RH

Date: May 12, 2014

Frequency (MHz)	Reading (dBuV)	Correction Factor (dB/m)	Result (dBuV/m)	Limit (dBuV/m)	Margin (dB)	Antenna Pole (V/H)	Remark
1990.000	49.25	-6.69	42.56	74.00	-31.44	V	Peak
3907.000	43.04	-0.62	42.42	74.00	-31.58	V	Peak
5023.000	41.49	3.94	45.43	74.00	-28.57	V	Peak
6049.000	40.58	7.57	48.15	74.00	-25.85	V	Peak
6814.000	41.57	7.22	48.79	74.00	-25.21	V	Peak
7561.000	40.65	7.49	48.14	74.00	-25.86	V	Peak
2143.000	45.61	-6.81	38.80	74.00	-35.20	H	Peak
3880.000	42.88	-0.65	42.23	74.00	-31.77	H	Peak
4735.000	41.73	2.31	44.04	74.00	-29.96	H	Peak
5752.000	40.30	5.99	46.29	74.00	-27.71	H	Peak
6742.000	41.31	7.25	48.56	74.00	-25.44	H	Peak
7813.000	40.68	7.65	48.33	74.00	-25.67	H	Peak

REMARKS:

1. Measuring frequencies from 1 GHz to the 10th harmonic of highest fundamental frequency.
2. Radiated emissions measured in frequency above 1000MHz were made with an instrument using peak/average detector mode.
3. Average test would be performed if the peak result were greater than the average limit or as required by the applicant.
4. Data of measurement within this frequency range shown " --- " in the table above means the reading of emissions are attenuated more than 20dB below the permissible limits or the field strength is too small to be measured.
5. Measurements above show only up to 6 maximum emissions noted, or would be lesser, with " N/A " remark, if no specific emissions from the EUT are recorded (ie: margin>20dB from the applicable limit) and considered that's already beyond the background noise floor.
6. Margin (dB) = Remark result (dBuV/m) – Average limit (dBuV/m).



Test Mode: TX / EEE 802.11n HT20 MHz (CH High)

Tested by: Sun Guo

Ambient temperature: 24°C Relative humidity: 52% RH

Date: May 12, 2014

Frequency (MHz)	Reading (dBuV)	Correction Factor (dB/m)	Result (dBuV/m)	Limit (dBuV/m)	Margin (dB)	Antenna Pole (V/H)	Remark
1999.000	49.82	-6.61	43.21	74.00	-30.79	V	Peak
3547.000	42.78	-0.98	41.80	74.00	-32.20	V	Peak
4951.000	42.57	3.62	46.19	74.00	-27.81	V	Peak
5743.000	40.55	5.93	46.48	74.00	-27.52	V	Peak
6931.000	40.60	7.16	47.76	74.00	-26.24	V	Peak
8785.000	41.29	8.41	49.70	74.00	-24.30	V	Peak
3439.000	44.31	-1.62	42.69	74.00	-31.31	H	Peak
4366.000	41.59	0.50	42.09	74.00	-31.91	H	Peak
5248.000	41.98	4.14	46.12	74.00	-27.88	H	Peak
6157.000	40.22	7.52	47.74	74.00	-26.26	H	Peak
6931.000	40.74	7.16	47.90	74.00	-26.10	H	Peak
8542.000	40.58	8.21	48.79	74.00	-25.21	H	Peak

REMARKS:

1. Measuring frequencies from 1 GHz to the 10th harmonic of highest fundamental frequency.
2. Radiated emissions measured in frequency above 1000MHz were made with an instrument using peak/average detector mode.
3. Average test would be performed if the peak result were greater than the average limit or as required by the applicant.
4. Data of measurement within this frequency range shown " --- " in the table above means the reading of emissions are attenuated more than 20dB below the permissible limits or the field strength is too small to be measured.
5. Measurements above show only up to 6 maximum emissions noted, or would be lesser, with " N/A " remark, if no specific emissions from the EUT are recorded (ie: margin>20dB from the applicable limit) and considered that's already beyond the background noise floor.
6. Margin (dB) = Remark result (dBuV/m) – Average limit (dBuV/m).



Antenna 0

Test Mode: TX/ IEEE 802.11n HT20 MHz SISO (CH Low)

Tested by: Sun Guo

Ambient temperature: 24°C Relative humidity: 52% RH

Date: May 12, 2014

Frequency (MHz)	Reading (dBuV)	Correction Factor (dB/m)	Result (dBuV/m)	Limit (dBuV/m)	Margin (dB)	Antenna Pole (V/H)	Remark
1999.000	51.28	-8.31	42.97	74.00	-31.03	V	Peak
3898.000	42.95	-1.42	41.53	74.00	-32.47	V	Peak
5176.000	42.41	2.52	44.93	74.00	-29.07	V	Peak
7003.000	40.51	7.71	48.22	74.00	-25.78	V	Peak
7777.000	40.77	9.22	49.99	74.00	-24.01	V	Peak
8371.000	41.18	9.45	50.63	74.00	-23.37	V	Peak
1999.000	49.30	-8.31	40.99	74.00	-33.01	H	Peak
3835.000	43.12	-1.65	41.47	74.00	-32.53	H	Peak
4645.000	42.42	1.03	43.45	74.00	-30.55	H	Peak
5347.000	41.45	2.54	43.99	74.00	-30.01	H	Peak
7228.000	41.45	8.14	49.59	74.00	-24.41	H	Peak
8569.000	41.03	9.34	50.37	74.00	-23.63	H	Peak

REMARKS:

1. Measuring frequencies from 1 GHz to the 10th harmonic of highest fundamental frequency.
2. Radiated emissions measured in frequency above 1000MHz were made with an instrument using peak/average detector mode.
3. Average test would be performed if the peak result were greater than the average limit or as required by the applicant.
4. Data of measurement within this frequency range shown " --- " in the table above means the reading of emissions are attenuated more than 20dB below the permissible limits or the field strength is too small to be measured.
5. Measurements above show only up to 6 maximum emissions noted, or would be lesser, with " N/A " remark, if no specific emissions from the EUT are recorded (ie: margin>20dB from the applicable limit) and considered that's already beyond the background noise floor.
6. Margin (dB) = Remark result (dBuV/m) – Average limit (dBuV/m).



Test Mode: TX / IEEE 802.11n HT20 MHz SISO (CH Mid)

Tested by: Sun Guo

Ambient temperature: 24°C Relative humidity: 52% RH

Date: May 12, 2014

Frequency (MHz)	Reading (dBuV)	Correction Factor (dB/m)	Result (dBuV/m)	Limit (dBuV/m)	Margin (dB)	Antenna Pole (V/H)	Remark
1999.000	50.75	-8.31	42.44	74.00	-31.56	V	Peak
3853.000	42.94	-1.58	41.36	74.00	-32.64	V	Peak
4879.000	42.28	2.01	44.29	74.00	-29.71	V	Peak
5293.000	42.50	2.53	45.03	74.00	-28.97	V	Peak
6130.000	41.42	3.95	45.37	74.00	-28.63	V	Peak
7570.000	40.51	8.81	49.32	74.00	-24.68	V	Peak
1999.000	49.74	-8.31	41.43	74.00	-32.57	H	Peak
3349.000	44.70	-3.16	41.54	74.00	-32.46	H	Peak
5059.000	41.02	2.51	43.53	74.00	-30.47	H	Peak
6040.000	40.29	3.56	43.85	74.00	-30.15	H	Peak
6913.000	41.21	7.33	48.54	74.00	-25.46	H	Peak
8326.000	40.76	9.47	50.23	74.00	-23.77	H	Peak

REMARKS:

1. Measuring frequencies from 1 GHz to the 10th harmonic of highest fundamental frequency.
2. Radiated emissions measured in frequency above 1000MHz were made with an instrument using peak/average detector mode.
3. Average test would be performed if the peak result were greater than the average limit or as required by the applicant.
4. Data of measurement within this frequency range shown " --- " in the table above means the reading of emissions are attenuated more than 20dB below the permissible limits or the field strength is too small to be measured.
5. Measurements above show only up to 6 maximum emissions noted, or would be lesser, with " N/A " remark, if no specific emissions from the EUT are recorded (ie: margin>20dB from the applicable limit) and considered that's already beyond the background noise floor.
6. Margin (dB) = Remark result (dBuV/m) – Average limit (dBuV/m).



Test Mode: TX/ IEEE 802.11n HT20 MHz SISO (CH High)

Tested by: Sun Guo

Ambient temperature: 24°C Relative humidity: 52% RH

Date: May 12, 2014

Frequency (MHz)	Reading (dBuV)	Correction Factor (dB/m)	Result (dBuV/m)	Limit (dBuV/m)	Margin (dB)	Antenna Pole (V/H)	Remark
1999.000	50.88	-8.31	42.57	74.00	-31.43	V	Peak
3331.000	44.25	-3.20	41.05	74.00	-32.95	V	Peak
4330.000	42.18	-0.07	42.11	74.00	-31.89	V	Peak
5293.000	42.56	2.53	45.09	74.00	-28.91	V	Peak
6247.000	40.65	4.45	45.10	74.00	-28.90	V	Peak
7030.000	40.68	7.76	48.44	74.00	-25.56	V	Peak
1999.000	48.68	-8.31	40.37	74.00	-33.63	H	Peak
3277.000	44.38	-3.30	41.08	74.00	-32.92	H	Peak
3889.000	43.20	-1.45	41.75	74.00	-32.25	H	Peak
5095.000	41.25	2.52	43.77	74.00	-30.23	H	Peak
5851.000	41.39	3.14	44.53	74.00	-29.47	H	Peak
6859.000	40.78	7.09	47.87	74.00	-26.13	H	Peak

REMARKS:

1. Measuring frequencies from 1 GHz to the 10th harmonic of highest fundamental frequency.
2. Radiated emissions measured in frequency above 1000MHz were made with an instrument using peak/average detector mode.
3. Average test would be performed if the peak result were greater than the average limit or as required by the applicant.
4. Data of measurement within this frequency range shown " --- " in the table above means the reading of emissions are attenuated more than 20dB below the permissible limits or the field strength is too small to be measured.
5. Measurements above show only up to 6 maximum emissions noted, or would be lesser, with " N/A " remark, if no specific emissions from the EUT are recorded (ie: margin>20dB from the applicable limit) and considered that's already beyond the background noise floor.
6. Margin (dB) = Remark result (dBuV/m) – Average limit (dBuV/m).



Antenna 1

Test Mode: TX/ IEEE 802.11n HT20 MHz SISO (CH Low)

Tested by: Sun Guo

Ambient temperature: 24°C **Relative humidity:** 52% RH

Date: May 12, 2014

Frequency (MHz)	Reading (dBuV)	Correction Factor (dB/m)	Result (dBuV/m)	Limit (dBuV/m)	Margin (dB)	Antenna Pole (V/H)	Remark
1999.000	52.69	-8.31	44.38	74.00	-29.62	V	Peak
4267.000	42.67	-0.26	42.41	74.00	-31.59	V	Peak
5257.000	41.91	2.53	44.44	74.00	-29.56	V	Peak
6346.000	40.51	4.88	45.39	74.00	-28.61	V	Peak
7480.000	39.98	8.64	48.62	74.00	-25.38	V	Peak
8191.000	40.27	9.54	49.81	74.00	-24.19	V	Peak
1999.000	48.83	-8.31	40.52	74.00	-33.48	H	Peak
2845.000	45.35	-4.54	40.81	74.00	-33.19	H	Peak
4429.000	42.05	0.22	42.27	74.00	-31.73	H	Peak
5320.000	42.39	2.54	44.93	74.00	-29.07	H	Peak
7129.000	40.86	7.95	48.81	74.00	-25.19	H	Peak
7705.000	41.20	9.07	50.27	74.00	-23.73	H	Peak

REMARKS:

1. Measuring frequencies from 1 GHz to the 10th harmonic of highest fundamental frequency.
2. Radiated emissions measured in frequency above 1000MHz were made with an instrument using peak/average detector mode.
3. Average test would be performed if the peak result were greater than the average limit or as required by the applicant.
4. Data of measurement within this frequency range shown " --- " in the table above means the reading of emissions are attenuated more than 20dB below the permissible limits or the field strength is too small to be measured.
5. Measurements above show only up to 6 maximum emissions noted, or would be lesser, with " N/A " remark, if no specific emissions from the EUT are recorded (ie: margin>20dB from the applicable limit) and considered that's already beyond the background noise floor.
6. Margin (dB) = Remark result (dBuV/m) – Average limit (dBuV/m).



Test Mode: TX / IEEE 802.11n HT20 MHz SISO (CH Mid)

Tested by: Sun Guo

Ambient temperature: 24°C Relative humidity: 52% RH

Date: May 12, 2014

Frequency (MHz)	Reading (dBuV)	Correction Factor (dB/m)	Result (dBuV/m)	Limit (dBuV/m)	Margin (dB)	Antenna Pole (V/H)	Remark
1999.000	48.13	-8.31	39.82	74.00	-34.18	V	Peak
2854.000	44.61	-4.50	40.11	74.00	-33.89	V	Peak
3331.000	44.79	-3.20	41.59	74.00	-32.41	V	Peak
5734.000	41.38	2.94	44.32	74.00	-29.68	V	Peak
6733.000	41.02	6.55	47.57	74.00	-26.43	V	Peak
7183.000	39.91	8.06	47.97	74.00	-26.03	V	Peak
2557.000	46.19	-5.93	40.26	74.00	-33.74	H	Peak
3907.000	42.67	-1.38	41.29	74.00	-32.71	H	Peak
4438.000	42.02	0.25	42.27	74.00	-31.73	H	Peak
5392.000	41.52	2.54	44.06	74.00	-29.94	H	Peak
6967.000	41.14	7.56	48.70	74.00	-25.30	H	Peak
7768.000	40.32	9.20	49.52	74.00	-24.48	H	Peak

REMARKS:

1. Measuring frequencies from 1 GHz to the 10th harmonic of highest fundamental frequency.
2. Radiated emissions measured in frequency above 1000MHz were made with an instrument using peak/average detector mode.
3. Average test would be performed if the peak result were greater than the average limit or as required by the applicant.
4. Data of measurement within this frequency range shown " --- " in the table above means the reading of emissions are attenuated more than 20dB below the permissible limits or the field strength is too small to be measured.
5. Measurements above show only up to 6 maximum emissions noted, or would be lesser, with " N/A " remark, if no specific emissions from the EUT are recorded (ie: margin>20dB from the applicable limit) and considered that's already beyond the background noise floor.
6. Margin (dB) = Remark result (dBuV/m) – Average limit (dBuV/m).



Test Mode: TX/ IEEE 802.11n HT20 MHz SISO (CH High)

Tested by: Sun Guo

Ambient temperature: 24°C Relative humidity: 52% RH

Date: May 12, 2014

Frequency (MHz)	Reading (dBuV)	Correction Factor (dB/m)	Result (dBuV/m)	Limit (dBuV/m)	Margin (dB)	Antenna Pole (V/H)	Remark
1999.000	50.82	-8.31	42.51	74.00	-31.49	V	Peak
3331.000	45.21	-3.20	42.01	74.00	-31.99	V	Peak
4294.000	43.52	-0.18	43.34	74.00	-30.66	V	Peak
5455.000	41.27	2.55	43.82	74.00	-30.18	V	Peak
6751.000	40.57	6.63	47.20	74.00	-26.80	V	Peak
7480.000	40.21	8.64	48.85	74.00	-25.15	V	Peak
1945.000	47.98	-8.39	39.59	74.00	-34.41	H	Peak
2800.000	44.85	-4.76	40.09	74.00	-33.91	H	Peak
3790.000	43.54	-1.82	41.72	74.00	-32.28	H	Peak
5239.000	41.67	2.53	44.20	74.00	-29.80	H	Peak
6958.000	40.48	7.52	48.00	74.00	-26.00	H	Peak
7732.000	41.07	9.13	50.20	74.00	-23.80	H	Peak

REMARKS:

1. Measuring frequencies from 1 GHz to the 10th harmonic of highest fundamental frequency.
2. Radiated emissions measured in frequency above 1000MHz were made with an instrument using peak/average detector mode.
3. Average test would be performed if the peak result were greater than the average limit or as required by the applicant.
4. Data of measurement within this frequency range shown " --- " in the table above means the reading of emissions are attenuated more than 20dB below the permissible limits or the field strength is too small to be measured.
5. Measurements above show only up to 6 maximum emissions noted, or would be lesser, with " N/A " remark, if no specific emissions from the EUT are recorded (ie: margin>20dB from the applicable limit) and considered that's already beyond the background noise floor.
6. Margin (dB) = Remark result (dBuV/m) – Average limit (dBuV/m).



7.3. 6dB BANDWIDTH MEASUREMENT

7.3.1. LIMITS

According to §15.247(a)(2), systems using digital modulation techniques may operate in the 902 - 928 MHz, 2400 - 2483.5 MHz, and 5725 - 5850 MHz bands. The minimum 6 dB bandwidth shall be at least 500 kHz.

7.3.2. TEST INSTRUMENTS

Name of Equipment	Manufacturer	Model	Serial Number	Last Calibration	Calibration Due
Spectrum Analyzer	Agilent	E4446A	US44300399	03/01/2014	03/01/2015

7.3.3. TEST PROCEDURES (please refer to measurement standard)

8.1 Option 1:

- a) Set RBW = 100 kHz.
- b) Set the video bandwidth (VBW) $\geq 3 \times$ RBW.
- c) Detector = Peak.
- d) Trace mode = max hold.
- e) Sweep = auto couple.
- f) Allow the trace to stabilize.
- g) Measure the maximum width of the emission that is constrained by the frequencies associated with the two outermost amplitude points (upper and lower frequencies) that are attenuated by 6 dB relative to the maximum level measured in the fundamental emission.

7.3.4. TEST SETUP

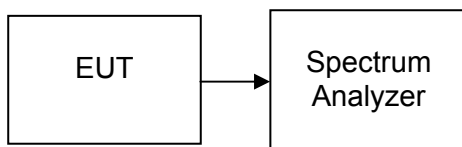



7.3.5. TEST RESULTS

No non-compliance noted

Test Data

Test mode: IEEE 802.11b (Antenna 0)

Channel	Frequency (MHz)	Bandwidth (kHz)	Limit (kHz)	Test Result
Low	2412	8143	>500	PASS
Mid	2437	8113		PASS
High	2462	8137		PASS

Test mode: IEEE 802.11b (Antenna 1)

Channel	Frequency (MHz)	Bandwidth (kHz)	Limit (kHz)	Test Result
Low	2412	8136	>500	PASS
Mid	2437	9062		PASS
High	2462	8581		PASS

Test mode: IEEE 802.11g (Antenna 0)

Channel	Frequency (MHz)	Bandwidth (kHz)	Limit (kHz)	Test Result
Low	2412	15157	>500	PASS
Mid	2437	15440		PASS
High	2462	15499		PASS

Test mode: IEEE 802.11g (Antenna 1)

Channel	Frequency (MHz)	Bandwidth (kHz)	Limit (kHz)	Test Result
Low	2412	15697	>500	PASS
Mid	2437	15316		PASS
High	2462	15320		PASS

Test mode: IEEE 802.11n HT20 MHz (Antenna 0)

Channel	Frequency (MHz)	Bandwidth (kHz)	Limit (kHz)	Test Result
Low	2412	15191	>500	PASS
Mid	2437	15662		PASS
High	2462	15467		PASS



Test mode: IEEE 802.11n HT20 MHz (Antenna 1)

Channel	Frequency (MHz)	Bandwidth (kHz)	Limit (kHz)	Test Result
Low	2412	16344	>500	PASS
Mid	2437	16345		PASS
High	2462	16284		PASS

Test mode: IEEE 802.11n HT20 MHz SISO (Antenna 0)

Channel	Frequency (MHz)	Bandwidth (kHz)	Limit (kHz)	Test Result
Low	2412	17132	>500	PASS
Mid	2437	17071		PASS
High	2462	16867		PASS

Test mode: IEEE 802.11n HT20 MHz SISO (Antenna 1)

Channel	Frequency (MHz)	Bandwidth (kHz)	Limit (kHz)	Test Result
Low	2412	17142	>500	PASS
Mid	2437	17239		PASS
High	2462	17012		PASS



Test Plot

IEEE 802.11b mode (Antenna 0)

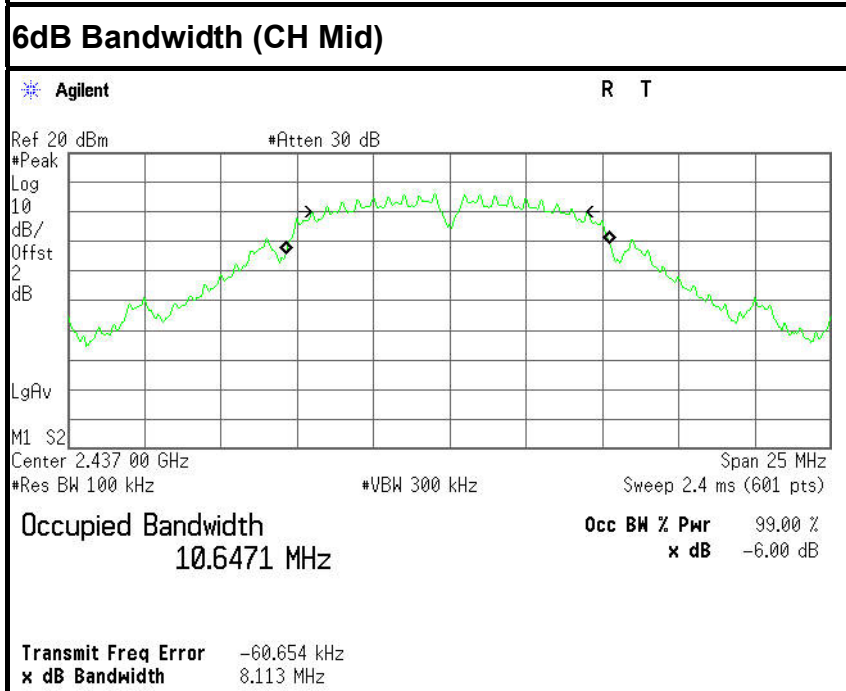
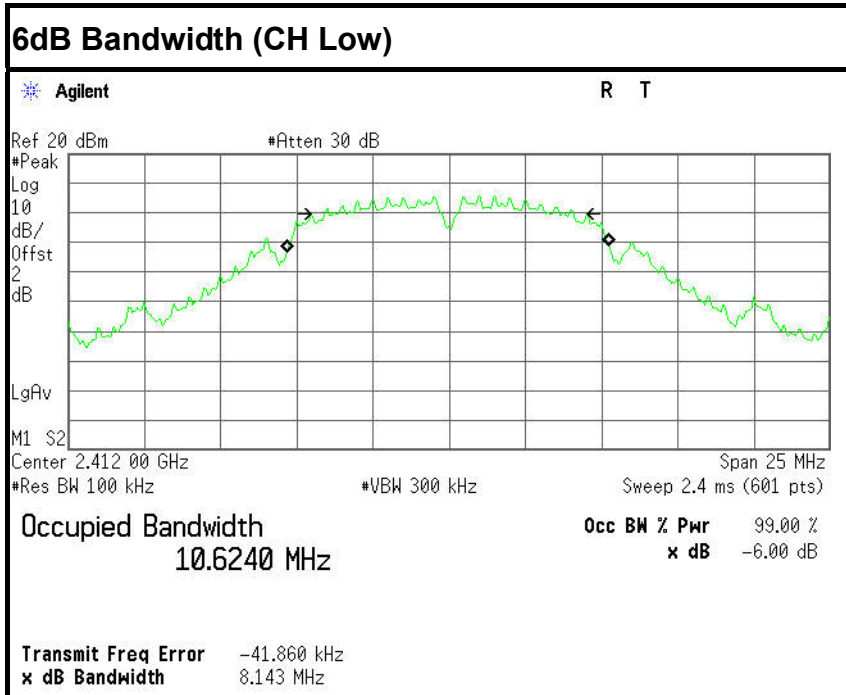

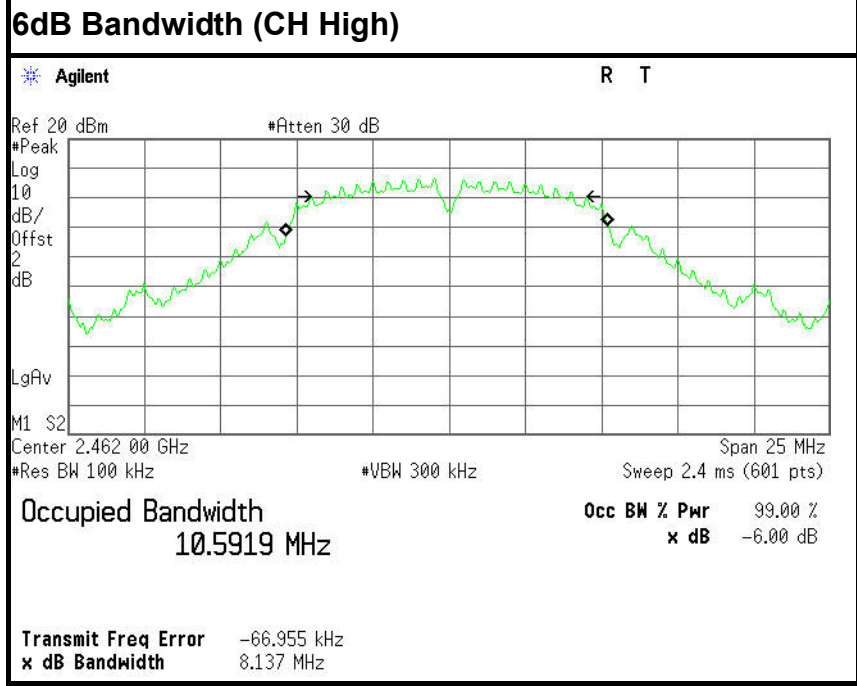



IEEE 802.11b mode (Antenna 1)

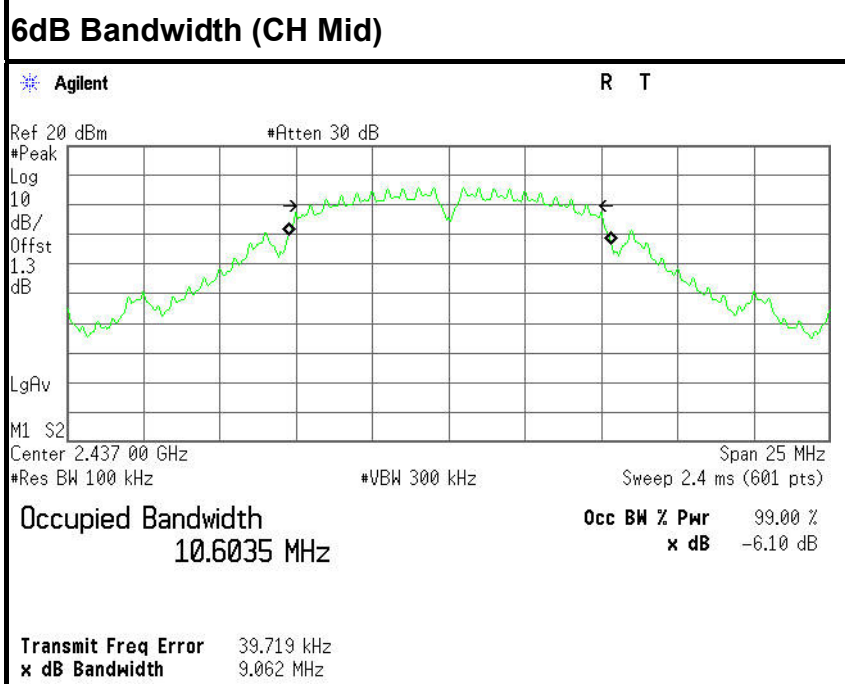
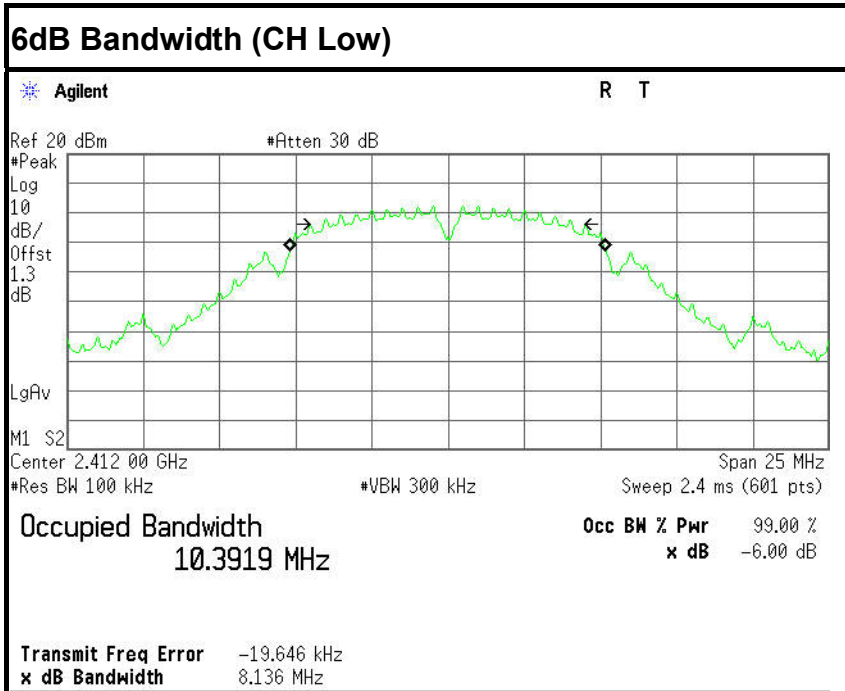



6dB Bandwidth (CH High)

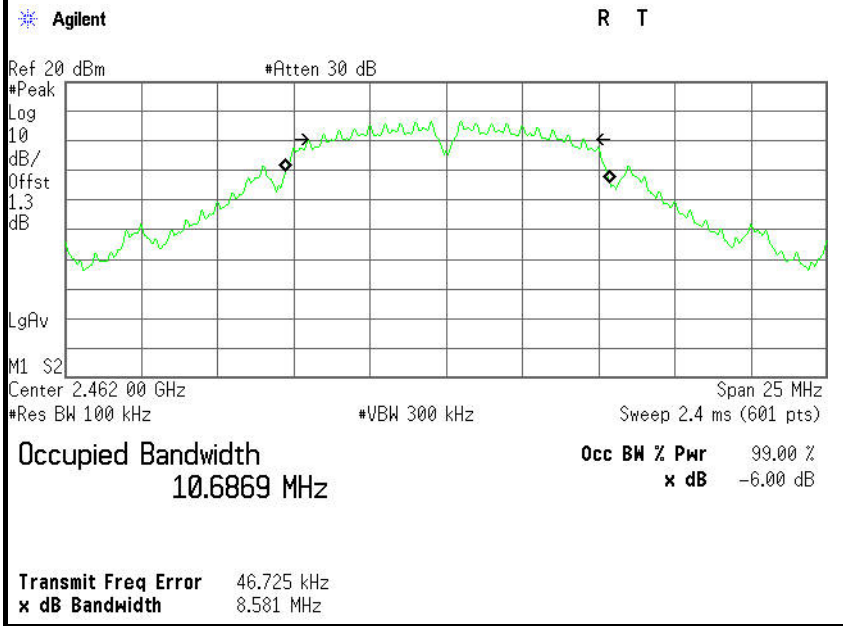



IEEE 802.11g mode (Antenna 0)

6dB Bandwidth (CH Low)

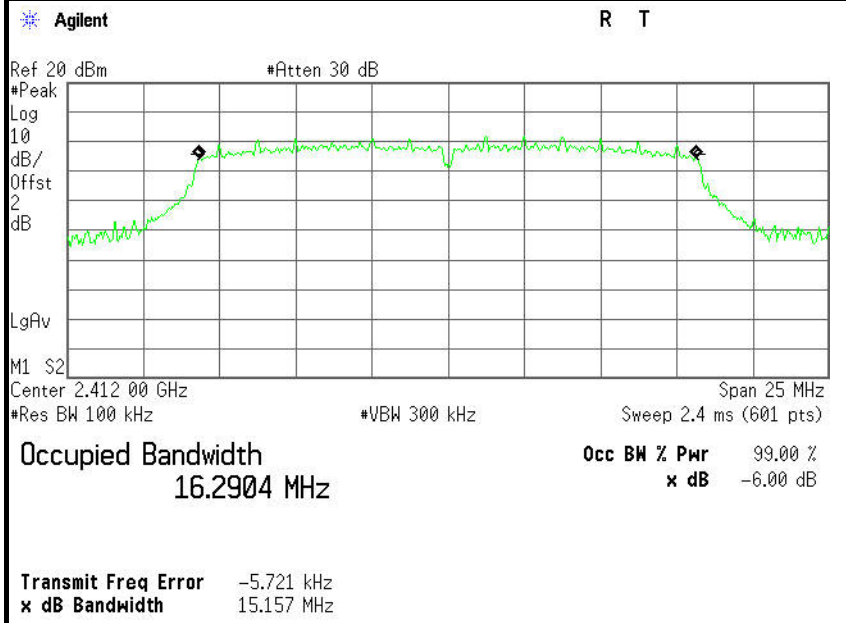

6dB Bandwidth (CH Mid)

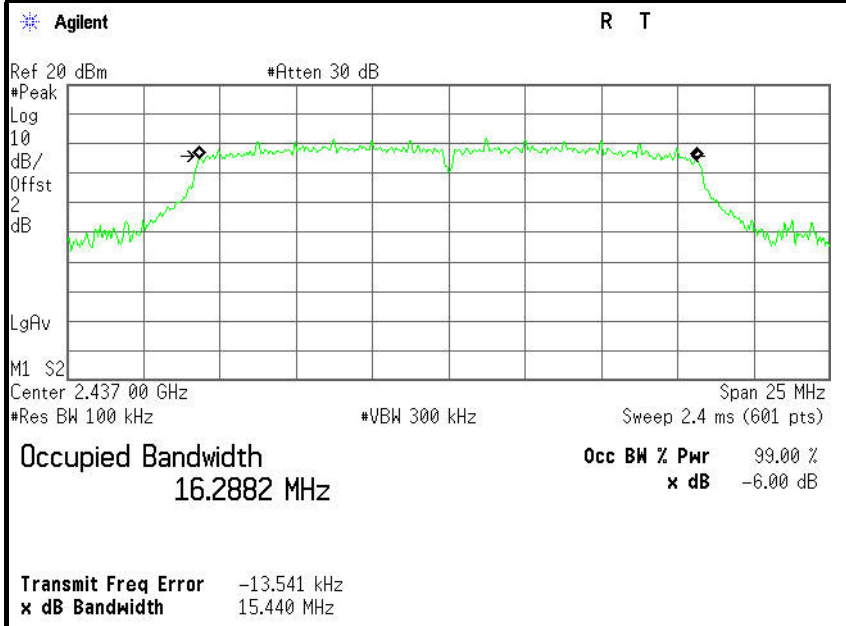

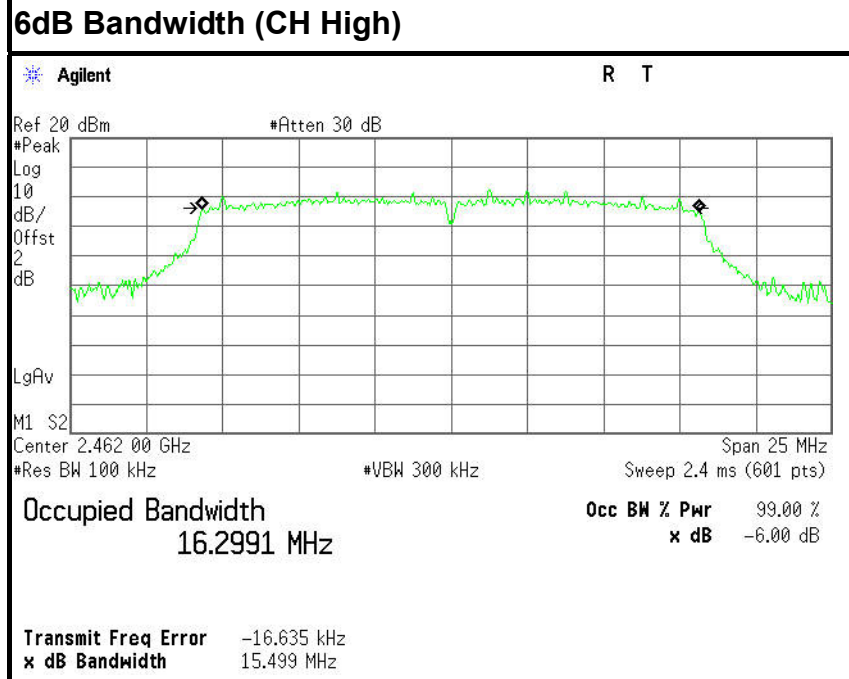



IEEE 802.11g mode (Antenna 1)

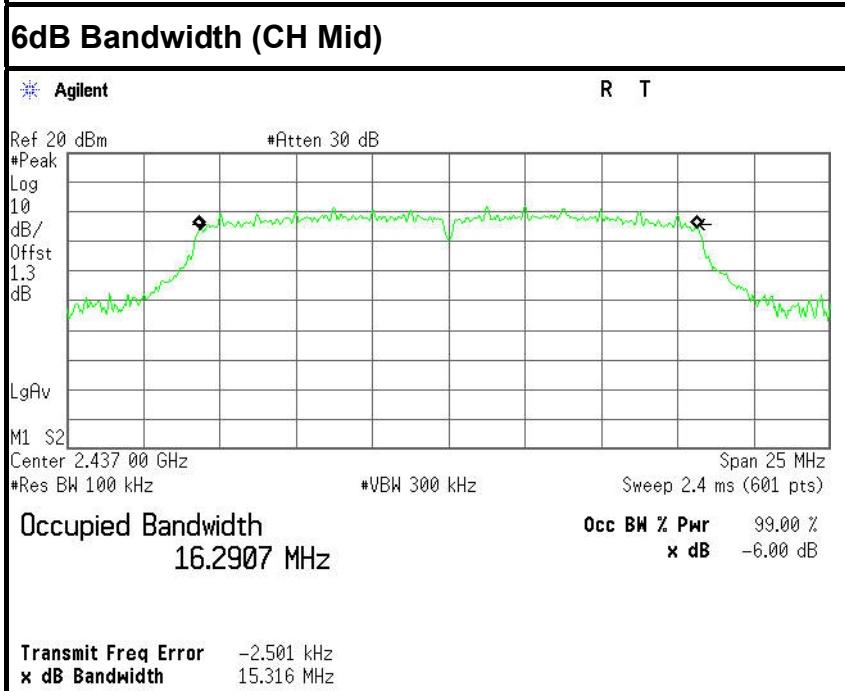
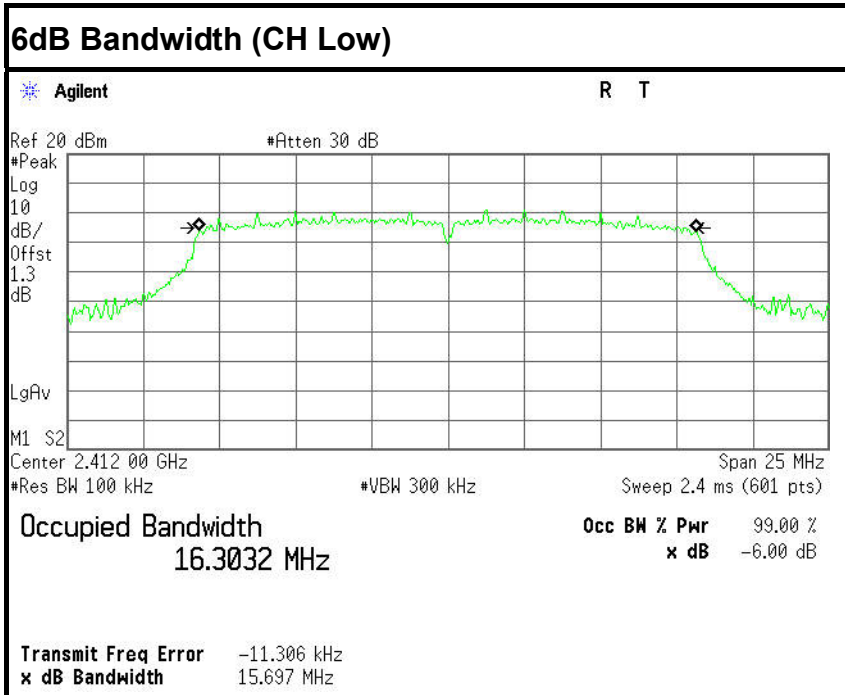

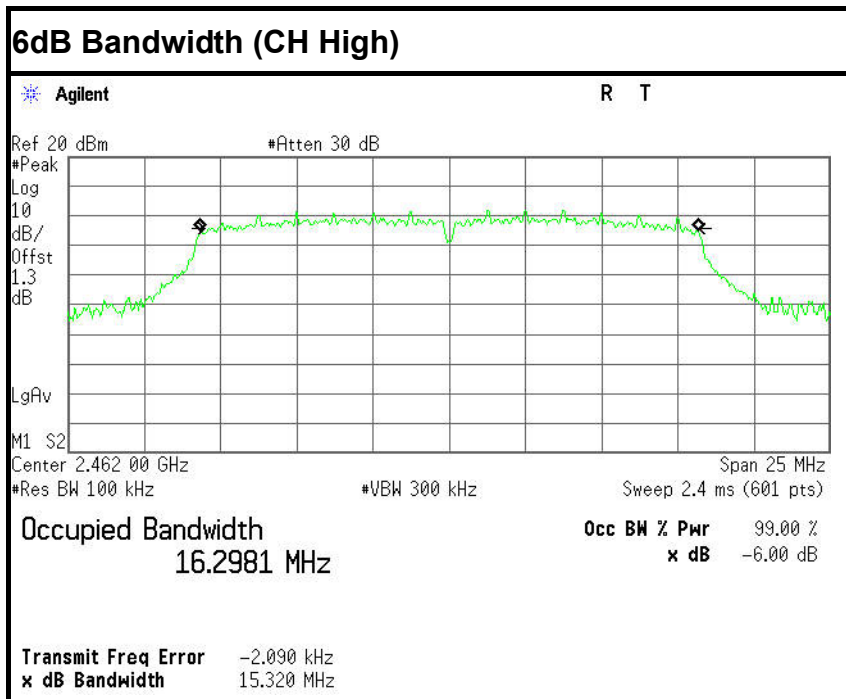



IEEE 802.11n HT20 MHz mode (Antenna 0)

6dB Bandwidth (CH Low)

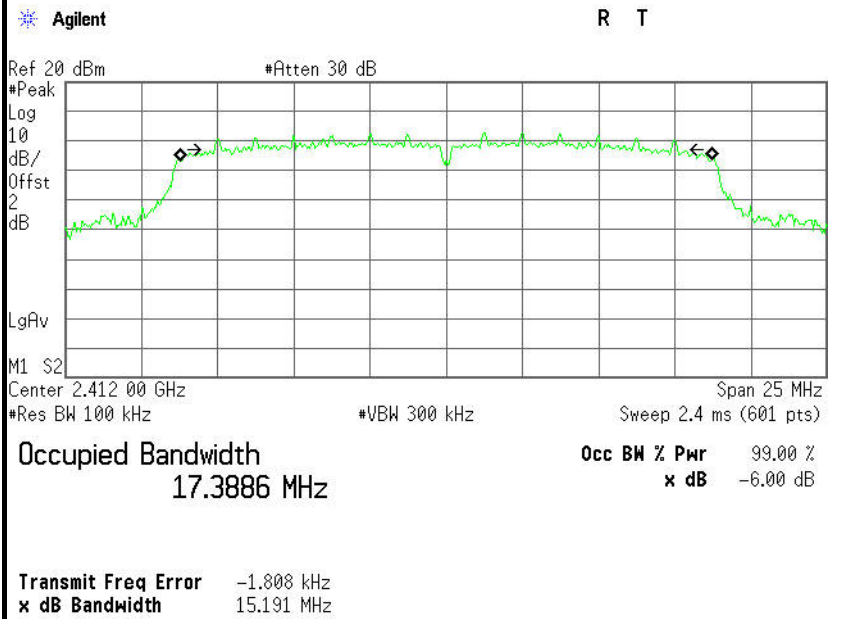

6dB Bandwidth (CH Mid)

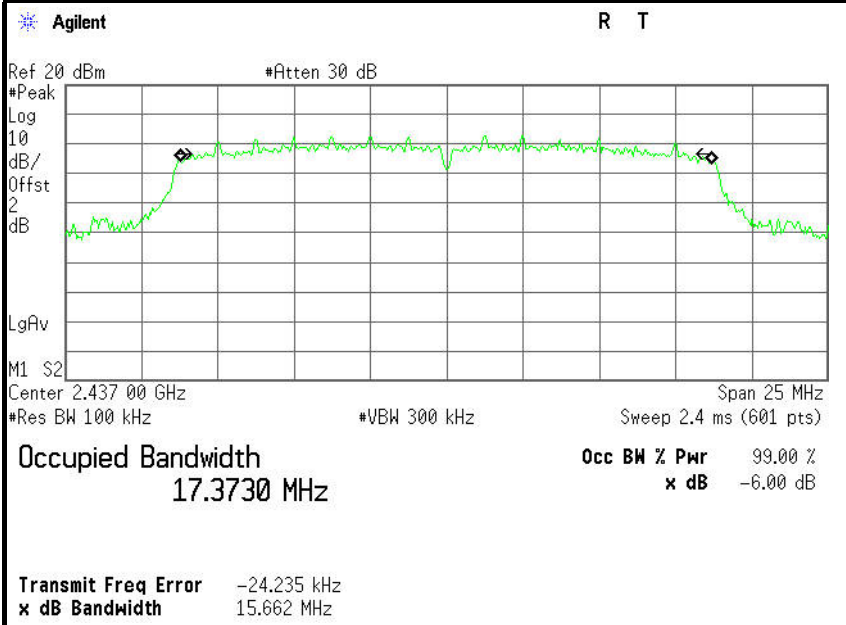

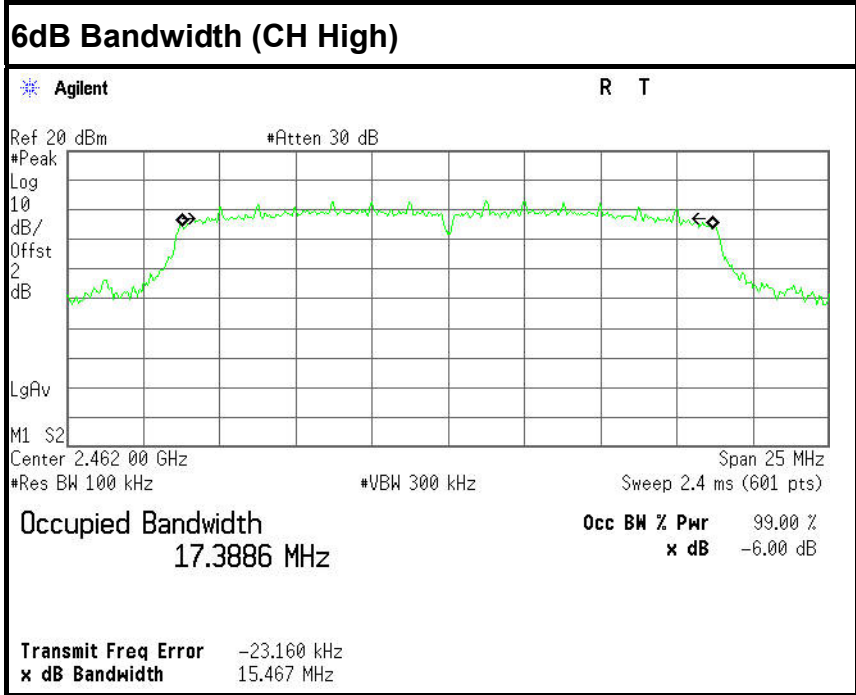



IEEE 802.11n HT20 MHz mode (Antenna 1)

6dB Bandwidth (CH Low)

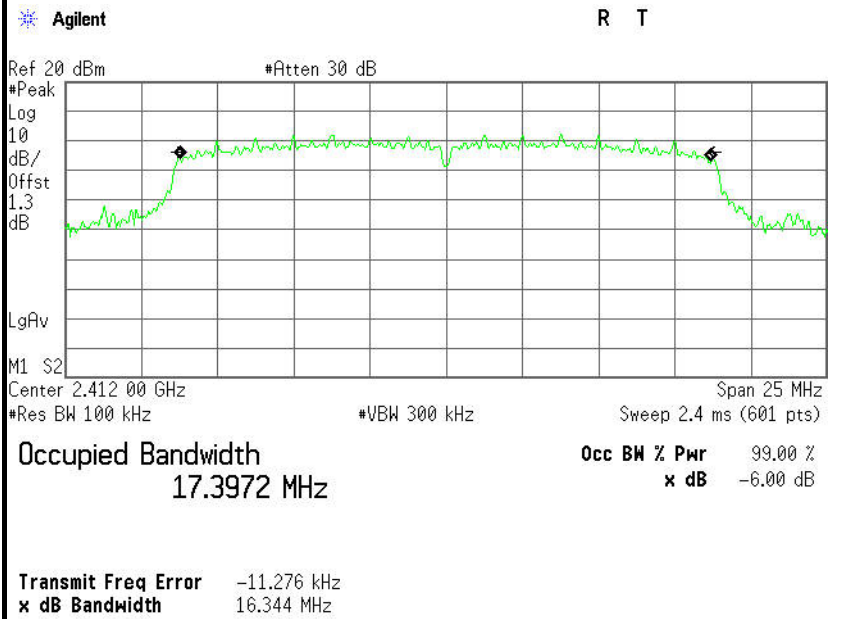

6dB Bandwidth (CH Mid)

