



FCC RF Test Report

APPLICANT : Acer Incorporated
EQUIPMENT : Tablet Computer
BRAND NAME : acer
MODEL NAME : N17H1
MARKETING NAME : Switch 3
FCC ID : HLZ7265D2W
STANDARD : FCC Part 15 Subpart C §15.247
CLASSIFICATION : (DSS) Spread Spectrum Transmitter

The product was integrated the Wireless Module (Model Name: 7265D2W, 7265D2W AN / FCC ID: PD97265D2) during the test.

The product was received on Mar. 15, 2017 and testing was completed on Apr. 12, 2017. We, SPORTON International (ShenZhen) INC., would like to declare that the tested sample has been evaluated in accordance with the test procedures and has been in compliance with the applicable technical standards.

The test results in this report apply exclusively to the tested model / sample. Without written approval of SPORTON International (ShenZhen) INC., the test report shall not be reproduced except in full.

Prepared by: Eric Shih / Manager

Approved by: Jones Tsai / Manager



SPORTON International (ShenZhen) INC.

**1/F, 2/F, Bldg 5, Shiling Industrial Zone, Xinwei Village, Xili, Nanshan District, Shenzhen City,
Guangdong Province, China**



TABLE OF CONTENTS

REVISION HISTORY..... 3

SUMMARY OF TEST RESULT 4

1 GENERAL DESCRIPTION..... 5

 1.1 Applicant..... 5

 1.2 Manufacturer..... 5

 1.3 Product Feature of Equipment Under Test..... 5

 1.4 Product Specification of Equipment Under Test..... 6

 1.5 Modification of EUT 6

 1.6 Component list..... 6

 1.7 Testing Location 7

 1.8 Applicable Standards..... 7

2 TEST CONFIGURATION OF EQUIPMENT UNDER TEST..... 8

 2.1 Descriptions of Test Mode..... 8

 2.2 Test Mode..... 8

 2.3 Connection Diagram of Test System..... 9

 2.4 Support Unit used in test configuration and system 10

 2.5 EUT Operation Test Setup 10

 2.6 Peak Output Power Measurement 11

 2.8 Radiated Band Edges and Spurious Emission Measurement 13

 2.9 AC Conducted Emission Measurement..... 19

 2.10 Antenna Requirements 23

3 LIST OF MEASURING EQUIPMENT..... 24

4 UNCERTAINTY OF EVALUATION..... 25

APPENDIX A. RADIATED SPURIOUS EMISSION

APPENDIX B. SETUP PHOTOGRAPHS



REVISION HISTORY

REPORT NO.	VERSION	DESCRIPTION	ISSUED DATE
FR731501A	Rev. 01	Initial issue of report	Apr. 25, 2017



SUMMARY OF TEST RESULT

Report Section	FCC Rule	IC Rule	Description	Limit	Result	Remark
-	15.247(a)(1)	RSS-247 5.1(d)	Number of Channels	≥ 15Chs	Pass	1
		RSS-247 5.1(b)	Hopping Channel Separation	≥ 2/3 of 20dB BW	Pass	1
		RSS-247 5.1(d)	Dwell Time of Each Channel	≤ 0.4sec in 31.6sec period	Pass	1
		RSS-247 5.1(a)	20dB Bandwidth	NA	Pass	1
-	-	RSS-Gen 6.6	99% Bandwidth	-	Pass	1
2.6	15.247(b)(1)	RSS-247 5.4(b)	Peak Output Power	≤ 125 mW	Pass	-
-	15.247(d)	RSS-247 5.5	Conducted Band Edges	≤ 20dBc	Pass	1
		RSS-247 5.5	Conducted Spurious Emission	≤ 20dBc	Pass	1
2.8	15.247(d)	RSS-247 5.5	Radiated Band Edges and Radiated Spurious Emission	15.209(a) & 15.247(d)	Pass	Under limit 6.21 dB at 30.970 MHz
2.9	15.207	RSS-Gen 8.8	AC Conducted Emission	15.207(a)	Pass	Under limit 8.38 dB at 1.000 MHz
2.10	15.203 & 15.247(b)	N/A	Antenna Requirement	N/A	Pass	-
Remark 1: All conducted test items were leverage from module RF report which can refer to Report No. FCC_7265D2W_BT_Report.						



1 General Description

1.1 Applicant

Acer Incorporated

8F ,88, Sec.1 Xintai 5th Rd. Xizhi, New Taipei City 221, Taiwan, R.O.C

1.2 Manufacturer

Acer Incorporated

8F ,88, Sec.1 Xintai 5th Rd. Xizhi, New Taipei City 221, Taiwan, R.O.C

1.3 Product Feature of Equipment Under Test

Product Feature	
Equipment	Tablet Computer
Brand Name	acer
Model Name	N17H1
Marketing Name	Switch 3
FCC ID	HLZ7265D2W
EUT supports Radios application	WLAN 2.4GHz 802.11b/g/n HT20/HT40 WLAN 5GHz 802.11a/n HT20/HT40 WLAN 5GHz 802.11ac VHT20/VHT40/VHT80 Bluetooth v3.0+EDR/Bluetooth v4.0 LE
HW Version	T8202_MB_V4
SW Version	14393.5
EUT Stage	Pre-Production

Remark: The above EUT's information was declared by manufacturer. Please refer to the specifications or user's manual for more detailed description.

1.4 Product Specification of Equipment Under Test

Standards-related Product Specification	
Tx/Rx Frequency Range	2402 MHz ~ 2480 MHz
Number of Channels	79
Carrier Frequency of Each Channel	2402+n*1 MHz; n=0~78
Maximum Output Power to Antenna	Bluetooth BR(1Mbps) : 4.02 dBm (0.0025 W) Bluetooth EDR (2Mbps) : 0.86 dBm (0.0012 W) Bluetooth EDR (3Mbps) : 1.04 dBm (0.0013 W)
Antenna Type / Gain	Antenna Type : PIFA Antenna with gain 1.68 dBi
Type of Modulation	Bluetooth BR (1Mbps) : GFSK Bluetooth EDR (2Mbps) : $\pi/4$ -DQPSK Bluetooth EDR (3Mbps) : 8-DPSK

1.5 Modification of EUT

No modifications are made to the EUT during all test items.

1.6 Component list

Note: There are two types of EUT, the details refer the following table. According to the difference, we choose sample 1 to perform full test.

Name	N17H1	
	Sample 1	Sample 2
PCB--MB	T8202_mainboard PCB_V4.0 (HUAXIN)	T8202_mainboard PCB_V4.0 (RED BOARD)
CPU	N4200(INTEL)	N3350(INTEL)
Memory	4G+128G	4G+64G



1.7 Testing Location

Test Site	SPORTON International (ShenZhen) INC.	
Test Site Location	1/F, 2/F, Bldg 5, Shiling Industrial Zone, Xinwei Village, Xili, Nanshan District, Shenzhen City, Guangdong Province, China TEL: +86-755-8637-9589 FAX: +86-755-8637-9595	
Test Site No.	Sporton Site No.	
	CO01-SZ	

Test Site	SPORTON International (ShenZhen) INC.	
Test Site Location	No. 3 Building, the third floor of south, Shahe River west, Fengzeyuan warehouse, Nanshan District, Shenzhen, Guangdong, P. R. China TEL: +86-755- 3320-2398	
Test Site No.	Sporton Site No.	FCC/IC Registration No.
	03CH03-SZ	565805/4086F

Note: The test site complies with ANSI C63.4 2014 requirement.

1.8 Applicable Standards

According to the specifications of the manufacturer, the EUT must comply with the requirements of the following standards:

- ♦ FCC Part 15 Subpart C §15.247
- ♦ ANSI C63.10-2013
- ♦ IC RSS-247 Issue 2
- ♦ IC RSS-Gen Issue 4

Remark:

1. All test items were verified and recorded according to the standards and without any deviation during the test.
2. This EUT has also been tested and complied with the requirements of FCC Part 15, Subpart B, recorded in a separate test report.



2 Test Configuration of Equipment Under Test

2.1 Descriptions of Test Mode

- a. The EUT has been associated with peripherals and configuration operated in a manner tended to maximize its emission characteristics in a typical application. Frequency range investigated: conduction (150 kHz to 30 MHz), radiation (9 kHz to the 10th harmonic of the highest fundamental frequency or to 40 GHz, whichever is lower). Pre-scanned tests, X, Y, Z in three orthogonal panels, and different data rates were conducted to determine the final configuration from all possible combinations, and the worst mode of radiated spurious emissions is Bluetooth 1Mbps mode, and recorded in this report.
- b. AC power line Conducted Emission was tested under maximum output power.

2.2 Test Mode

The following summary table is showing all test modes to demonstrate in compliance with the standard.

Summary table of Test Cases	
Radiated Test Cases	Bluetooth EDR 3Mbps 8-DPSK
	Mode 1: CH00_2402 MHz
	Mode 2: CH39_2441 MHz
	Mode 3: CH78_2480 MHz
AC Conducted Emission	Mode 1 : Bluetooth Link + WLAN Link + Earphone + Adapter 1
	Mode 2 : Bluetooth Link + WLAN Link + Earphone + Adapter 2
Remark: The worst case of conducted emission is mode 1; only the test data of it was reported.	

2.3 Connection Diagram of Test System

<Bluetooth Tx Mode>

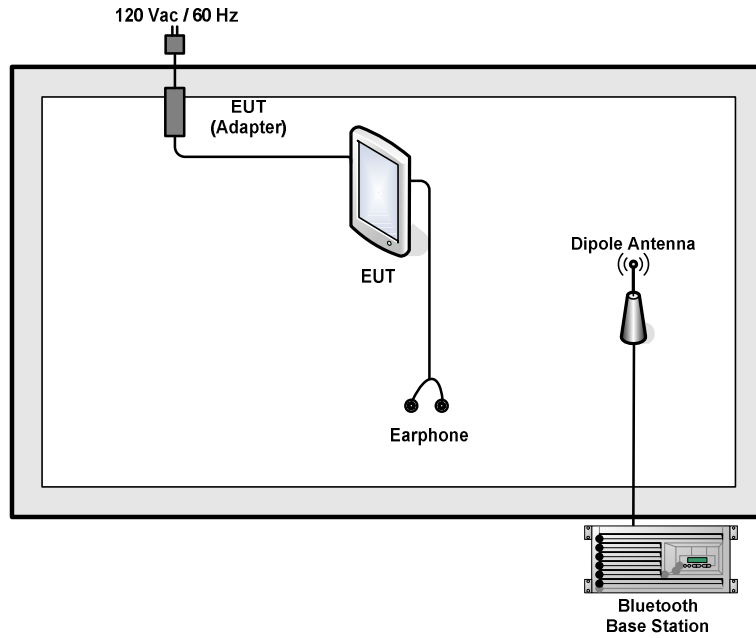

<AC Conducted Emission Mode>

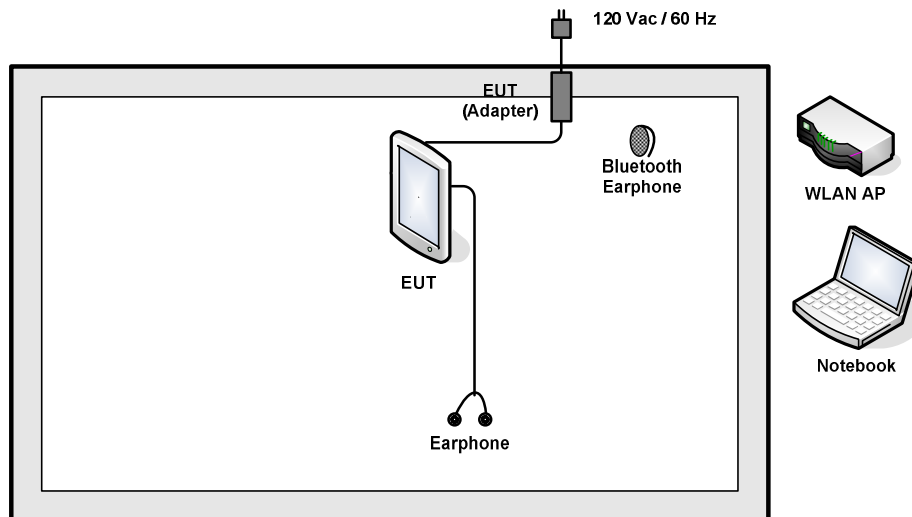



2.4 Support Unit used in test configuration and system

Item	Equipment	Trade Name	Model Name	FCC ID	Data Cable	Power Cord
1.	Bluetooth Base Station	R&S	CBT	Fcc Doc	N/A	Unshielded, 1.8 m
2.	WLAN AP	Dlink	DIR-820L	KA2IR820LA1	N/A	Unshielded, 1.8 m
3.	Notebook	Lenovo	E540	FCC DoC	N/A	AC I/P: Unshielded, 1.2 m DC O/P: Shielded, 1.8 m
4.	Bluetooth Earphone	Nokia	BH-108	PYAHS-107W	N/A	N/A
5.	Earphone	Lenovo	LH102	N/A	Unshielded, 1.2m	N/A

2.5 EUT Operation Test Setup

For Bluetooth function, the engineering test program was provided and enabled to make EUT connect with Bluetooth base station to continuous transmit/receive.

For AC power line conducted emissions, the EUT was set to connect with the WLAN AP under large package sizes transmission.

2.6 Peak Output Power Measurement

2.6.1 Limit of Peak Output Power

The maximum peak conducted output power of the intentional radiator shall not exceed the following:

- (1) For frequency hopping systems operating in the 2400-2483.5 MHz band employing at least 75 non-overlapping hopping channels, and all frequency hopping systems in the 5725-5850 MHz band: 1 watt. For all other frequency hopping systems in the 2400-2483.5 MHz band 0.125 watts.

2.6.2 Measuring Instruments

The measuring equipment is listed in the section 4 of this test report.

2.6.3 Test Procedures

1. The testing follows ANSI C63.10-2013 clause 7.8.5.
1. The RF output of EUT was connected to the power meter by RF cable and attenuator. The path loss was compensated to the results for each measurement.
2. Set to the maximum power setting and enable the EUT transmit continuously.
3. Measure the conducted output power with cable loss and record the results in the test report.
4. Measure and record the results in the test report.

2.6.4 Test Setup

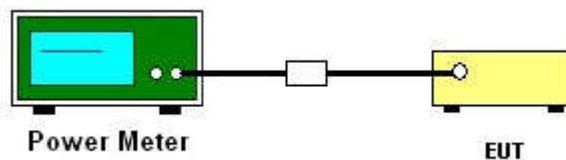



2.6.5 Test Result of Peak Output Power

Test Mode :	1Mbps	Temperature :	24~26°C
Test Engineer :	Sam Zheng	Relative Humidity :	50~53%

Channel	Frequency (MHz)	RF Power (dBm)		
		GFSK	Max. Limits (dBm)	Pass/Fail
		1 Mbps		
00	2402	3.15	20.97	Pass
39	2441	3.73	20.97	Pass
78	2480	4.02	20.97	Pass

Test Mode :	2Mbps	Temperature :	24~26°C
Test Engineer :	Sam Zheng	Relative Humidity :	50~53%

Channel	Frequency (MHz)	RF Power (dBm)		
		$\pi/4$ -DQPSK	Max. Limits (dBm)	Pass/Fail
		2 Mbps		
00	2402	0.00	20.97	Pass
39	2441	0.58	20.97	Pass
78	2480	0.86	20.97	Pass

Test Mode :	3Mbps	Temperature :	24~26°C
Test Engineer :	Sam Zheng	Relative Humidity :	50~53%

Channel	Frequency (MHz)	RF Power (dBm)		
		8-DPSK	Max. Limits (dBm)	Pass/Fail
		3 Mbps		
00	2402	0.23	20.97	Pass
39	2441	0.75	20.97	Pass
78	2480	1.04	20.97	Pass



2.8 Radiated Band Edges and Spurious Emission Measurement

2.8.1 Limit of Radiated Band Edges and Spurious Emission

In any 100 kHz bandwidth outside the intentional radiator frequency band, all harmonics/spurious must be at least 20 dB below the highest emission level within the authorized band. In addition, radiated emissions which fall in the restricted bands must also comply with the limits as below.

Frequency (MHz)	Field Strength (microvolts/meter)	Measurement Distance (meters)
0.009 – 0.490	2400/F(kHz)	300
0.490 – 1.705	24000/F(kHz)	30
1.705 – 30.0	30	30
30 – 88	100	3
88 – 216	150	3
216 - 960	200	3
Above 960	500	3

2.8.2 Measuring Instruments

The measuring equipment is listed in the section 4 of this test report.



2.8.3 Test Procedures

1. The EUT was placed on a turntable with 0.8 meter for frequency below 1GHz and 1.5 meter for frequency above 1GHz respectively above ground.
2. The EUT was set 3 meters from the interference receiving antenna, which was mounted on the top of a variable height antenna tower.
3. For each suspected emission, the EUT was arranged to its worst case and then tune the Antenna tower (from 1 m to 4 m) and turntable (from 0 degree to 360 degrees) to find the maximum reading. A pre-amp and a high pass filter are used for the test in order to get better signal level to comply with the guidelines.
4. Set to the maximum power setting and enable the EUT transmit continuously.
5. Use the following spectrum analyzer settings:
 - (1) Span shall wide enough to fully capture the emission being measured;
 - (2) Set RBW=100 kHz for $f < 1 \text{ GHz}$, RBW=1MHz for $f > 1\text{GHz}$; VBW \geq RBW; Sweep = auto; Detector function = peak; Trace = max hold for peak
 - (3) For average measurement: use duty cycle correction factor method per 15.35(c).
Duty cycle = On time/100 milliseconds
On time = $N_1 * L_1 + N_2 * L_2 + \dots + N_{n-1} * L_{n-1} + N_n * L_n$
Where N_1 is number of type 1 pulses, L_1 is length of type 1 pulses, etc.
Average Emission Level = Peak Emission Level + $20 * \log(\text{Duty cycle})$
6. Corrected Reading: Antenna Factor + Cable Loss + Read Level - Preamp Factor = Level

Note: The average levels were calculated from the peak level corrected with duty cycle correction factor (-24.79dB) derived from $20 \log(\text{dwell time}/100\text{ms})$. This correction is only for signals that hop with the fundamental signal, such as band-edge and harmonic. Other spurious signals that are independent of the hopping signal would not use this correction.

2.8.4 Test Setup

For radiated emissions below 30MHz

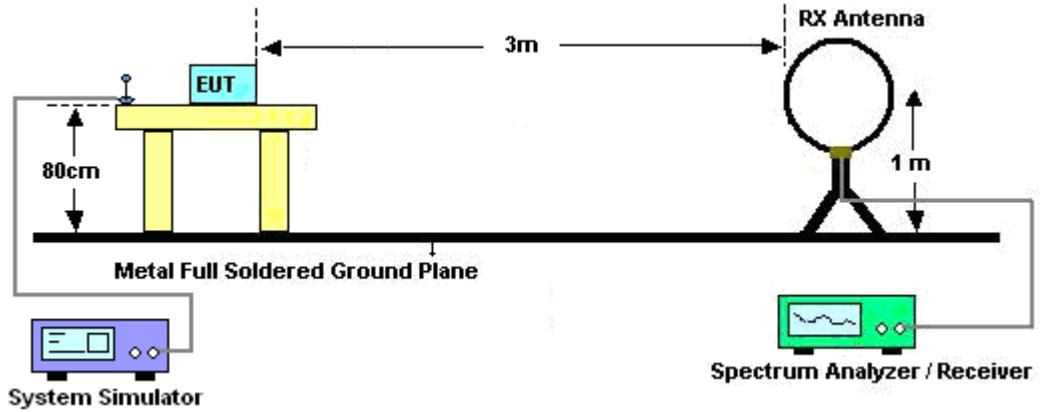

For radiated emissions from 30MHz to 1GHz

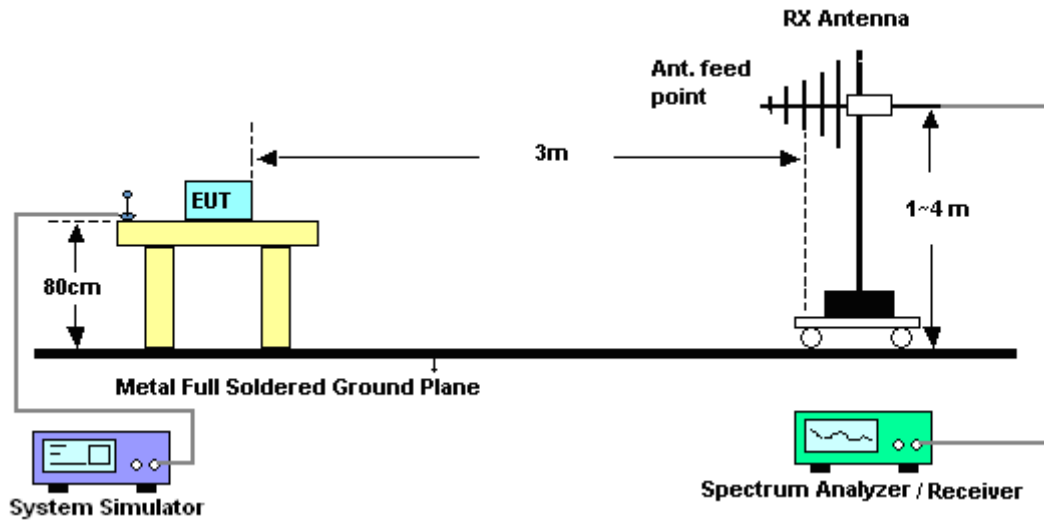

For radiated emissions above 1GHz

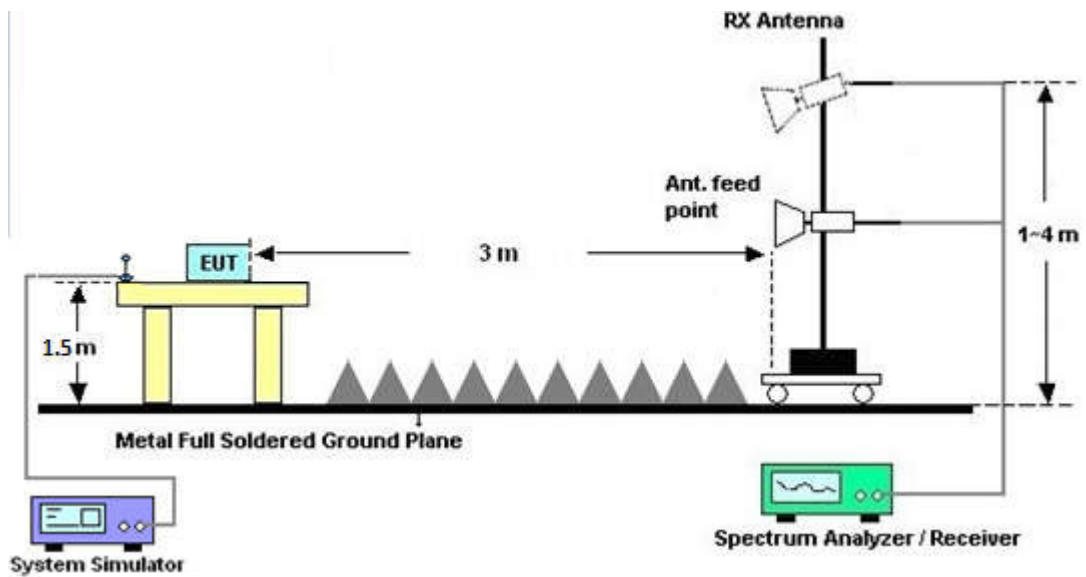

2.8.5 Test Results of Radiated Spurious Emissions (9 kHz ~ 30 MHz)

The low frequency, which started from 9 kHz to 30MHz, was pre-scanned and the result which was 20dB lower than the limit line was not reported.



2.8.6 Duty cycle correction factor for average measurement

DH5 on time (One Pulse) Plot on Channel 39



DH5 on time (Count Pulses) Plot on Channel 39

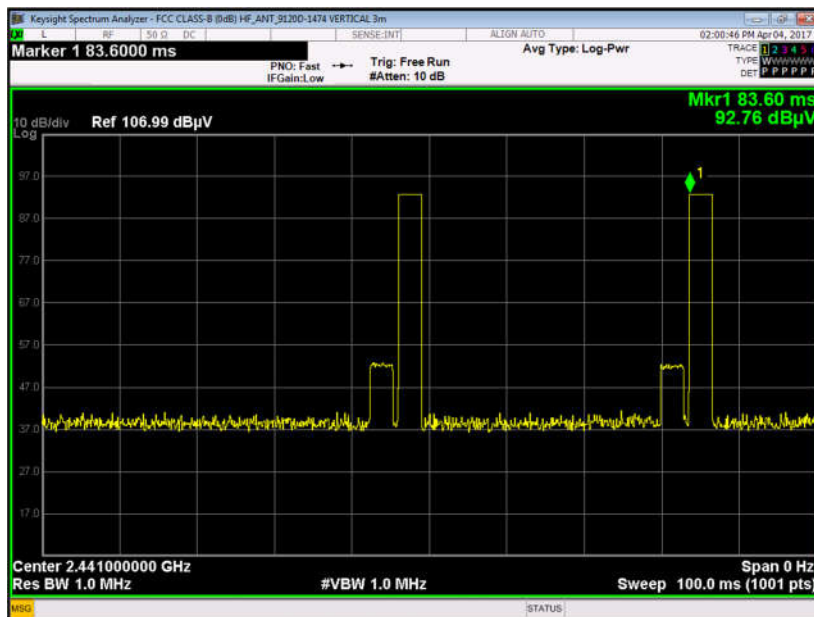

Note:

1. Worst case Duty cycle = on time/100 milliseconds = $2 * 2.88 / 100 = 5.76 \%$
2. Worst case Duty cycle correction factor = $20 * \log(\text{Duty cycle}) = -24.79 \text{ dB}$
3. DH5 has the highest duty cycle worst case and is reported.



Duty Cycle Correction Factor Consideration for AFH mode:

Bluetooth normal hopping rate is 1600Hz and reduced to 800Hz in AFH mode; due to the reduced number of hopping frequencies, with the same packet configuration the dwell time in each channel frequency within 100msec period is longer in AFH mode than normal mode.

In AFH mode, the minimum hopping frequencies are 20, to get the longest dwell time DH5 packet is observed; the period to have DH5 packet completing one hopping sequence is

$$2.88 \text{ ms} \times 20 \text{ channels} = 57.6 \text{ ms}$$

There cannot be 2 complete hopping sequences within 100ms period, considering the random hopping behavior, maximum 2 hops can be possibly observed within the period. $[100\text{ms} / 57.6\text{ms}] = 2 \text{ hops}$

Thus, the maximum possible ON time:

$$2.88 \text{ ms} \times 2 = 5.76 \text{ ms}$$

Worst case Duty Cycle Correction factor, which is derived from the maximum possible ON time,

$$20 \times \log(5.76 \text{ ms}/100\text{ms}) = -24.79 \text{ dB}$$

2.8.7 Test Result of Radiated Spurious at Band Edges

Please refer to Appendix A.

2.8.8 Test Result of Radiated Spurious Emission (30MHz ~ 10th Harmonic)

Please refer to Appendix A.

2.8.9 Test Result of Radiated Spurious Emission (Simultaneous TX)

Please refer to test report (FR731501B).



2.9 AC Conducted Emission Measurement

2.9.1 Limit of AC Conducted Emission

For equipment that is designed to be connected to the public utility (AC) power line, the radio frequency voltage that is conducted back onto the AC power line on any frequency or frequencies within the band 150 kHz to 30 MHz shall not exceed the limits in the following table.

Frequency of emission (MHz)	Conducted limit (dB μ V)	
	Quasi-peak	Average
0.15-0.5	66 to 56*	56 to 46*
0.5-5	56	46
5-30	60	50

*Decreases with the logarithm of the frequency.

2.9.2 Measuring Instruments

The measuring equipment is listed in the section 4 of this test report.

2.9.3 Test Procedures

1. The EUT was placed 0.4 meter from the conducting wall of the shielding room was kept at least 80 centimeters from any other grounded conducting surface.
2. Connect EUT to the power mains through a line impedance stabilization network (LISN).
3. All the support units are connecting to the other LISN.
4. The LISN provides 50 ohm coupling impedance for the measuring instrument.
5. The FCC states that a 50 ohm, 50 microhenry LISN should be used.
6. Both sides of AC line were checked for maximum conducted interference.
7. The frequency range from 150 kHz to 30 MHz was searched.
8. Set the test-receiver system to Peak Detect Function and specified bandwidth (IF Bandwidth = 9kHz) with Maximum Hold Mode. Then measurement is also conducted by Average Detector and Quasi-Peak Detector Function respectively.

2.9.4 Test Setup

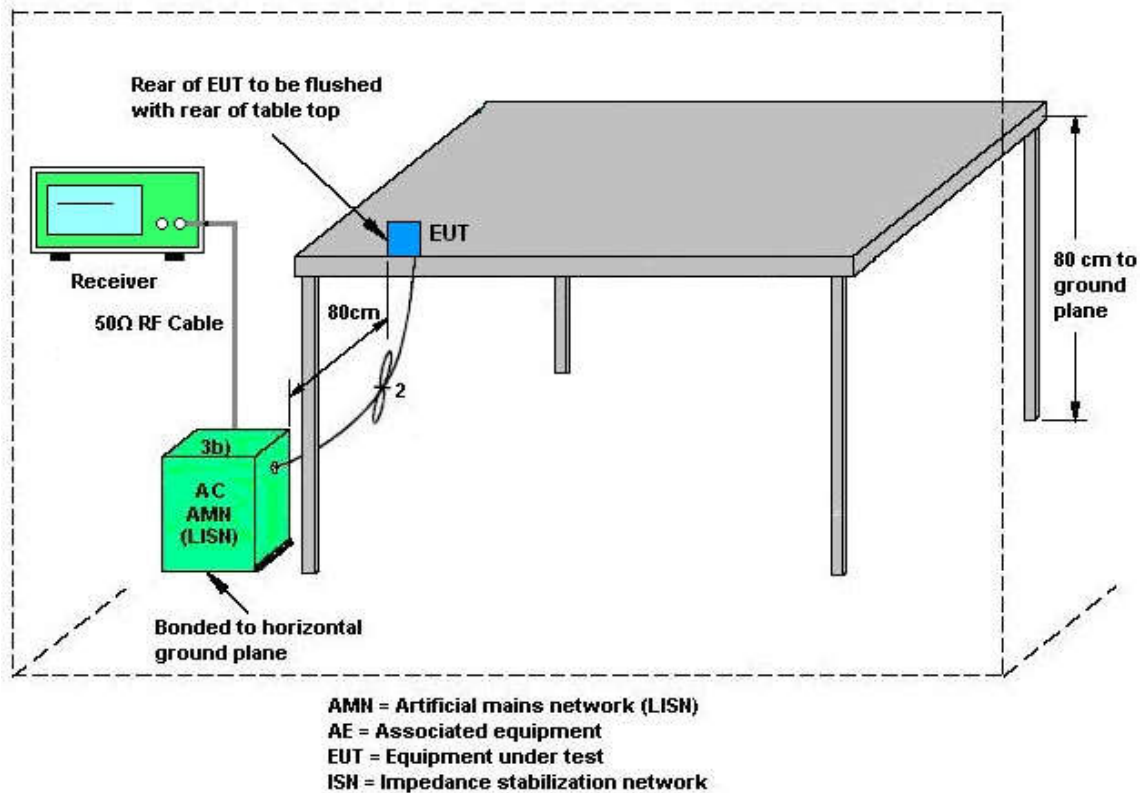



2.9.5 Test Result of AC Conducted Emission

Test Mode :	Mode 1	Temperature :	21~23°C
Test Engineer :	Tao Cheng	Relative Humidity :	41~42%
Test Voltage :	120Vac / 60Hz	Phase :	Line
Function Type :	Bluetooth Link + WLAN Link + Earphone + Adapter 1		

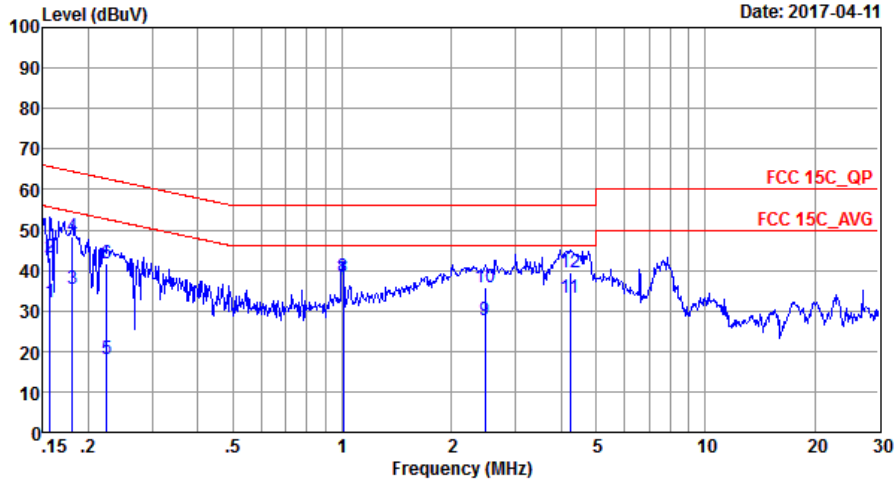

Site : C001-SZ
 Condition: FCC 15C_QP LISN_20170301_L LINE

Mode : Mode 1

	Freq	Level	Over Limit	Limit Line	Read Level	LISN Factor	Cable Loss	Remark
	MHz	dBuV	dB	dBuV	dBuV	dB	dB	
1	0.16	32.21	-23.44	55.65	21.80	0.03	10.38	Average
2	0.16	43.31	-22.34	65.65	32.90	0.03	10.38	QP
3	0.18	35.42	-19.04	54.46	25.10	0.03	10.29	Average
4	0.18	48.22	-16.24	64.46	37.90	0.03	10.29	QP
5	0.22	18.25	-34.41	52.66	8.00	0.03	10.22	Average
6	0.22	41.75	-20.91	62.66	31.50	0.03	10.22	QP
7 *	1.00	37.62	-8.38	46.00	27.40	0.07	10.15	Average
8	1.00	38.52	-17.48	56.00	28.30	0.07	10.15	QP
9	2.47	27.52	-18.48	46.00	17.19	0.14	10.19	Average
10	2.47	35.82	-20.18	56.00	25.49	0.14	10.19	QP
11	4.25	33.14	-12.86	46.00	22.70	0.18	10.26	Average
12	4.25	39.64	-16.36	56.00	29.20	0.18	10.26	QP



Test Mode :	Mode 1	Temperature :	21~23°C
Test Engineer :	Tao Cheng	Relative Humidity :	41~42%
Test Voltage :	120Vac / 60Hz	Phase :	Neutral
Function Type :	Bluetooth Link + WLAN Link + Earphone + Adapter 1		

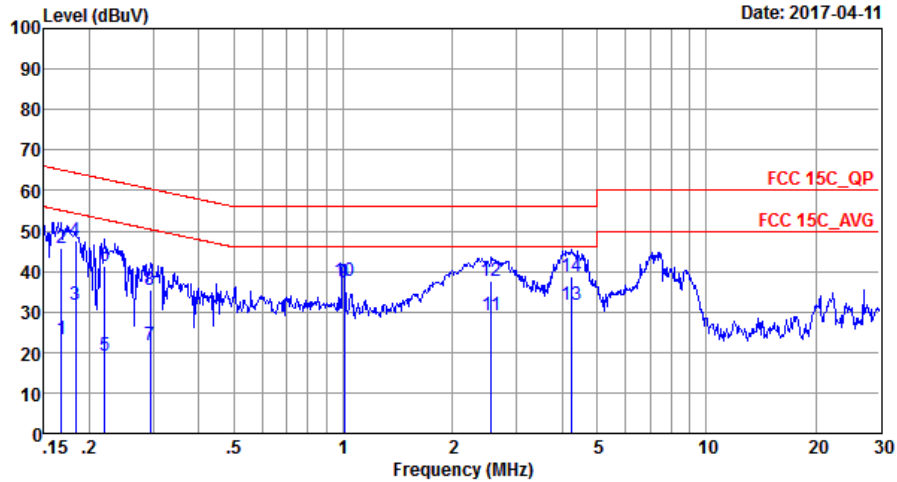

Site : CO01-SZ
 Condition: FCC 15C_QP LISN_20170301_N NEUTRAL

Mode : Mode 1

	Freq	Level	Over Limit	Limit Line	Read Level	LISN Factor	Cable Loss	Remark
	MHz	dBuV	dB	dBuV	dBuV	dB	dB	
1	0.17	23.07	-32.01	55.08	12.70	0.03	10.34	Average
2	0.17	45.87	-19.21	65.08	35.50	0.03	10.34	QP
3	0.18	31.61	-22.72	54.33	21.30	0.03	10.28	Average
4	0.18	47.61	-16.72	64.33	37.30	0.03	10.28	QP
5	0.22	19.25	-33.54	52.79	9.00	0.03	10.22	Average
6	0.22	41.35	-21.44	62.79	31.10	0.03	10.22	QP
7	0.29	21.65	-28.76	50.41	11.40	0.03	10.22	Average
8	0.29	35.45	-24.96	60.41	25.20	0.03	10.22	QP
9 *	1.00	37.10	-8.90	46.00	26.90	0.05	10.15	Average
10	1.00	37.80	-18.20	56.00	27.60	0.05	10.15	QP
11	2.55	29.23	-16.77	46.00	19.00	0.04	10.19	Average
12	2.55	37.53	-18.47	56.00	27.30	0.04	10.19	QP
13	4.27	31.92	-14.08	46.00	21.60	0.06	10.26	Average
14	4.27	38.62	-17.38	56.00	28.30	0.06	10.26	QP



2.10 Antenna Requirements

2.10.1 Standard Applicable

If directional gain of transmitting antennas is greater than 6dBi, the power shall be reduced by the same level in dB comparing to gain minus 6dBi. The use of a permanently attached antenna or of an antenna that uses a unique coupling to the intentional radiator shall be considered sufficient to comply with the rule.

2.10.2 Antenna Anti-Replacement Construction

An embedded-in antenna design is used.

2.10.3 Antenna Gain

The antenna peak gain of EUT is less than 6 dBi. Therefore, it is not necessary to reduce maximum peak output power limit.



3 List of Measuring Equipment

Instrument	Manufacturer	Model No.	Serial No.	Characteristics	Calibration Date	Test Date	Due Date	Remark
Spectrum Analyzer	R&S	FSP30	101400	9kHz~40GHz	Jan. 06, 2017	Mar. 28, 2017~ Apr. 07, 2017	Jan. 05, 2018	Conducted (TH01-SZ)
Pulse Power Sensor	Anritsu	MA2411B	1207253	30MHz~40GHz	Jan. 06, 2017	Mar. 28, 2017~ Apr. 07, 2017	Jan. 05, 2018	Conducted (TH01-SZ)
Power Meter	Anritsu	ML2495A	1218010	50MHz Bandwidth	Jan. 06, 2017	Mar. 28, 2017~ Apr. 07, 2017	Jan. 05, 2018	Conducted (TH01-SZ)
EMI Test Receiver&SA	KEYSIGHT	N9038A	MY544500 83	20Hz~8.4GHz	May 07, 2016	Apr. 04, 2017~ Apr. 12, 2017	May 06, 2017	Radiation (03CH03-SZ)
EXA Spectrum Analyzer	KEYSIGHT	N9010A	MY551502 46	10Hz~44GHz	May 07, 2016	Apr. 04, 2017~ Apr. 12, 2017	May 06, 2017	Radiation (03CH03-SZ)
Loop Antenna	R&S	HFH2-Z2	100354	9kHz~30MHz	May 07, 2016	Apr. 04, 2017~ Apr. 12, 2017	May 06, 2017	Radiation (03CH03-SZ)
Bilog Antenna	TeseQ	CBL6112D	35408	30MHz~2GHz	May 21, 2016	Apr. 04, 2017~ Apr. 12, 2017	May 20, 2017	Radiation (03CH03-SZ)
Double Ridge Horn Antenna	SCHWARZBECK	BBHA9120D	9120D-135 5	1GHz~18GHz	May 07, 2016	Apr. 04, 2017~ Apr. 12, 2017	May 06, 2017	Radiation (03CH03-SZ)
SHF-EHF Horn	com-power	AH-840	101071	18GHz~40GHz	Aug. 10, 2016	Apr. 04, 2017~ Apr. 12, 2017	Aug. 09, 2017	Radiation (03CH03-SZ)
Amplifier	Burgeon	BPA-530	102210	0.01Hz ~3000MHz	Oct. 11, 2016	Apr. 04, 2017~ Apr. 12, 2017	Oct. 10, 2017	Radiation (03CH03-SZ)
Amplifier	Agilent Technologies	83017A	MY395013 02	500MHz~26.5G Hz	Jan. 06, 2017	Apr. 04, 2017~ Apr. 12, 2017	Jan. 05, 2018	Radiation (03CH03-SZ)
HF Amplifier	MITEQ	TTA1840-35- HG	1871923	18GHz~40GHz	Jul. 16, 2016	Apr. 04, 2017~ Apr. 12, 2017	Jul. 15, 2017	Radiation (03CH03-SZ)
AC Power Source	Chroma	61601	616010001 985	N/A	NCR	Apr. 04, 2017~ Apr. 12, 2017	NCR	Radiation (03CH03-SZ)
Turn Table	EM	EM1000	N/A	0~360 degree	NCR	Apr. 04, 2017~ Apr. 12, 2017	NCR	Radiation (03CH03-SZ)
Antenna Mast	EM	EM1000	N/A	1 m~4 m	NCR	Apr. 04, 2017~ Apr. 12, 2017	NCR	Radiation (03CH03-SZ)
EMI Receiver	R&S	ESR7	101630	9kHz~7GHz;	Jan. 06, 2017	Apr. 11, 2017	Jan. 05, 2018	Conduction (CO01-SZ)
AC LISN	EMCO	3816/2SH	00103892	9kHz~30MHz	Jan. 05, 2017	Apr. 11, 2017	Jan. 04, 2018	Conduction (CO01-SZ)
AC LISN (for auxiliary equipment)	MessTec	3816/2SH	00103912	9kHz~30MHz	Jan. 05, 2017	Apr. 11, 2017	Jan. 04, 2018	Conduction (CO01-SZ)
AC Power Source	Chroma	61602	616020000 891	100Vac~250Vac	Jul. 16, 2016	Apr. 11, 2017	Jul. 15, 2017	Conduction (CO01-SZ)
Pulse Limiter	COM-POWER	LIT-153 Transient Limiter	53139	150kHz~30MHz	Oct. 11, 2016	Apr. 11, 2017	Oct. 10, 2017	Conduction (CO01-SZ)

NCR: No Calibration Required



4 Uncertainty of Evaluation

Uncertainty of Conducted Emission Measurement (150 kHz ~ 30 MHz)

Measuring Uncertainty for a Level of Confidence of 95% ($U = 2Uc(y)$)	2.5dB
---	-------

Uncertainty of Radiated Emission Measurement (30 MHz ~ 1000 MHz)

Measuring Uncertainty for a Level of Confidence of 95% ($U = 2Uc(y)$)	5.1dB
---	-------

Uncertainty of Radiated Emission Measurement (1GHz ~ 18GHz)

Measuring Uncertainty for a Level of Confidence of 95% ($U = 2Uc(y)$)	5.0dB
---	-------

Uncertainty of Radiated Emission Measurement (18GHz ~ 40GHz)

Measuring Uncertainty for a Level of Confidence of 95% ($U = 2Uc(y)$)	5.0dB
---	-------



Appendix A. Radiated Spurious Emission

2.4GHz 2400~2483.5MHz

BT (Band Edge @ 3m)

BT	Note	Frequency	Level	Over	Limit	Read	Antenna	Cable	Preamp	Ant	Table	Peak	Pol.
		(MHz)	(dBμV/m)	(dB)	(dBμV/m)	(dBμV)	(dB/m)	(dB)	(dB)	(cm)	(deg)	(P/A)	(H/V)
BT CH00 2402MHz		2371.215	39.86	-34.14	74	42.01	27.37	3.81	33.33	198	114	P	H
		2371.215	15.07	-38.93	54	-	-	-	-	198	114	A	H
	*	2402	88.02	-	-	90.1	27.43	3.81	33.32	198	114	P	H
	*	2402	63.23	-	-	-	-	-	-	198	114	A	H
		2365.545	40.24	-33.76	74	42.5	27.3	3.77	33.33	198	208	P	V
		2365.545	15.45	-38.55	54	-	-	-	-	198	208	A	V
	*	2402	89.6	-	-	91.68	27.43	3.81	33.32	198	208	P	V
	*	2402	64.81	-	-	-	-	-	-	198	208	A	V
BT CH 39 2441MHz		2342.49	40.01	-33.99	74	42.33	27.24	3.77	33.33	150	112	P	H
		2342.49	15.22	-38.78	54	-	-	-	-	150	112	A	H
	*	2441	89.7	-	-	91.56	27.61	3.84	33.31	150	112	P	H
	*	2441	64.91	-	-	-	-	-	-	150	112	A	H
		2494.68	40.17	-33.83	74	41.76	27.8	3.91	33.3	150	112	P	H
		2494.68	15.38	-38.62	54	-	-	-	-	150	112	A	H
		2348	40.11	-33.89	74	42.43	27.24	3.77	33.33	250	204	P	V
		2348	15.32	-38.68	54	-	-	-	-	250	204	A	V
	*	2441	92.39	-	-	94.25	27.61	3.84	33.31	250	204	P	V
	*	2441	67.6	-	-	-	-	-	-	250	204	A	V
		2494.11	41.23	-32.77	74	42.82	27.8	3.91	33.3	250	204	P	V
		2494.11	16.44	-37.56	54	-	-	-	-	250	204	A	V



BT CH 78 2480MHz	*	2480	93.26	-	-	94.95	27.74	3.88	33.31	178	118	P	H
	*	2480	68.47	-	-	-	-	-	-	178	118	A	H
		2485.09	48.94	-25.06	74	50.63	27.74	3.88	33.31	178	118	P	H
		2485.09	24.15	-29.85	54	-	-	-	-	178	118	A	H
	*	2480	93.13	-	-	94.82	27.74	3.88	33.31	187	232	P	V
	*	2480	68.34	-	-	-	-	-	-	187	232	A	V
		2484.81	48.8	-25.20	74	50.49	27.74	3.88	33.31	187	232	P	V
		2484.81	24.01	-29.99	54	-	-	-	-	187	232	A	V
Remark	<ol style="list-style-type: none"> No other spurious found. All results are PASS against Peak and Average limit line. 												



2.4GHz 2400~2483.5MHz

BT (Harmonic @ 3m)

BT	Note	Frequency (MHz)	Level (dBμV/m)	Over Limit (dB)	Limit Line (dBμV/m)	Read Level (dBμV)	Antenna Factor (dB/m)	Cable Loss (dB)	Preamp Factor (dB)	Ant Pos (cm)	Table Pos (deg)	Peak Avg. (P/A)	Pol. (H/V)
BT CH 00 2402MHz		4804	42.3	-31.70	74	61.63	31.44	5.87	56.64	151	219	P	H
		4804	17.51	-36.49	54	-	-	-	-	151	219	A	H
		4804	41.76	-32.24	74	61.09	31.44	5.87	56.64	151	219	P	V
		4804	16.97	-37.03	54	-	-	-	-	151	219	A	V
BT CH 39 2441MHz		4882	40.9	-33.10	74	60.22	31.61	5.98	56.91	150	258	P	H
		4882	16.11	-37.89	54	-	-	-	-	150	258	A	H
		7323	45.56	-28.44	74	60.31	36.19	6.92	57.86	152	309	P	H
		7323	20.77	-33.23	54	-	-	-	-	152	309	A	H
		4882	41.55	-32.45	74	60.87	31.61	5.98	56.91	150	258	P	V
		4882	16.76	-37.24	54	-	-	-	-	150	258	A	V
		7323	45.91	-28.09	74	60.66	36.19	6.92	57.86	152	309	P	V
		7323	21.12	-32.88	54	-	-	-	-	152	309	A	V
BT CH 78 2480MHz		4960	43.07	-30.93	74	61.41	31.82	6.09	56.25	118	289	P	H
		4960	18.28	-35.72	54	-	-	-	-	118	289	A	H
		7440	45.1	-28.90	74	59.6	36.34	6.94	57.78	158	273	P	H
		7440	20.31	-33.69	54	-	-	-	-	158	273	A	H
		4960	42.19	-31.81	74	60.53	31.82	6.09	56.25	118	289	P	V
		4960	17.4	-36.60	54	-	-	-	-	118	289	A	V
		7440	46.56	-27.44	74	61.06	36.34	6.94	57.78	158	273	P	V
		7440	21.77	-32.23	54	-	-	-	-	158	273	A	V
Remark	1. No other spurious found. 2. All results are PASS against Peak and Average limit line.												



Emission below 1GHz

2.4GHz BT (LF)

BT	Note	Frequency	Level	Over	Limit	Read	Antenna	Cable	Preamp	Ant	Table	Peak	Pol.
		(MHz)	(dBμV/m)	(dB)	(dBμV/m)	(dBμV)	(dB/m)	(dB)	(dB)	(cm)	(deg)	(P/A)	(H/V)
2.4GHz BT LF		228.85	37.31	-8.69	46	50.66	16.66	1.27	31.28	100	125	P	H
		305.48	34.84	-11.16	46	45.05	19.57	1.44	31.22	-	-	P	H
		398.6	32.88	-13.12	46	41.4	21.08	1.59	31.19	-	-	P	H
		422.85	31.2	-14.80	46	39.48	21.28	1.67	31.23	-	-	P	H
		458.74	29.94	-16.06	46	37.71	21.78	1.73	31.28	-	-	P	H
		746.83	29.58	-16.42	46	32.65	25.99	2.15	31.21	-	-	P	H
		30.97	33.79	-6.21	40	40.59	24.52	0.65	31.97	100	345	P	V
		175.5	28.99	-14.51	43.5	42.73	16.52	1.17	31.43	-	-	P	V
		228.85	26.43	-19.57	46	39.78	16.66	1.27	31.28	-	-	P	V
		305.48	27.93	-18.07	46	38.14	19.57	1.44	31.22	-	-	P	V
		457.77	30.76	-15.24	46	38.56	21.75	1.73	31.28	-	-	P	V
		536.34	29.08	-16.92	46	34.49	23.97	1.86	31.24	-	-	P	V
Remark	<ol style="list-style-type: none"> No other spurious found. All results are PASS against limit line. 												



Note symbol

*	Fundamental Frequency which can be ignored. However, the level of any unwanted emissions shall not exceed the level of the fundamental frequency.
!	Test result is over limit line.
P/A	Peak or Average
H/V	Horizontal or Vertical



A calculation example for radiated spurious emission is shown as below:

WIFI	Note	Frequency	Level	Over	Limit	Read	Antenna	Cable	Preamp	Ant	Table	Peak	Pol.
Ant.				Limit	Line	Level	Factor	Loss	Factor	Pos	Pos	Avg.	
1+2		(MHz)	(dBμV/m)	(dB)	(dBμV/m)	(dBμV)	(dB/m)	(dB)	(dB)	(cm)	(deg)	(P/A)	(H/V)
802.11b		2390	55.45	-18.55	74	54.51	32.22	4.58	35.86	103	308	P	H
CH 01													
2412MHz		2390	43.54	-10.46	54	42.6	32.22	4.58	35.86	103	308	A	H

- Level(dBμV/m) =
Antenna Factor(dB/m) + Cable Loss(dB) + Read Level(dBμV) - Preamp Factor(dB)
- Over Limit(dB) = Level(dBμV/m) – Limit Line(dBμV/m)

For Peak Limit @ 2390MHz:

- Level(dBμV/m)
= Antenna Factor(dB/m) + Cable Loss(dB) + Read Level(dBμV) - Preamp Factor(dB)
= 32.22(dB/m) + 4.58(dB) + 54.51(dBμV) – 35.86 (dB)
= 55.45 (dBμV/m)
- Over Limit(dB)
= Level(dBμV/m) – Limit Line(dBμV/m)
= 55.45(dBμV/m) – 74(dBμV/m)
= -18.55(dB)

For Average Limit @ 2390MHz:

- Level(dBμV/m)
= Antenna Factor(dB/m) + Cable Loss(dB) + Read Level(dBμV) - Preamp Factor(dB)
= 32.22(dB/m) + 4.58(dB) + 42.6(dBμV) – 35.86 (dB)
= 43.54 (dBμV/m)
- Over Limit(dB)
= Level(dBμV/m) – Limit Line(dBμV/m)
= 43.54(dBμV/m) – 54(dBμV/m)
= -10.46(dB)

Both peak and average measured complies with the limit line, so test result is “PASS”.