

FCC SAR EVALUATION REPORT

In accordance with the requirements of
FCC 47 CFR Part 2(2.1093), ANSI/IEEE C95.1-1992 and
IEEE Std 1528-2013

Product Name : WLAN+Bluetooth module 3165D2W

Brand Name : acer

Model Name : 3165D2W

Report No. : S20120705310001

FCC ID : HLZ3165D2

The product was installed into Windows Tablet (Brand Name: acer, Model Name: N19E1, Acer ENDURO T5, ET510-51W) during test.

Prepared for

Acer Incorporated

8F, 88, Sec.1 Xintai 5th Rd. Xizhi, New Taipei City 221, Taiwan

Prepared by

Shenzhen NTEK Testing Technology Co., Ltd.

1/F, Building E, Fenda Science Park, Sanwei Community, Xixiang Street,
Bao'an District, Shenzhen 518126 P.R.China.

Tel.: 400-800-6106, 0755-3699 5508

Website: <http://www.ntek.org.cn>

TEST RESULT CERTIFICATION

Applicant's name..... Acer Incorporated

Address 8F, 88, Sec.1 Xintai 5th Rd. Xizhi, New Taipei City 221, Taiwan

Manufacturer's Name Acer Incorporated

Address 8F, 88, Sec.1 Xintai 5th Rd. Xizhi, New Taipei City 221, Taiwan

Product description

Product name WLAN+Bluetooth module 3165D2W

Brand Name acer

Model and/or type reference 3165D2W

The product was installed into Windows Tablet (Brand Name: acer, Model Name: N19E1, Acer ENDURO T5, ET510-51W) during test.

FCC 47 CFR Part 2(2.1093)

ANSI/IEEE C95.1-1992

Standards IEEE Std 1528-2013

Published RF exposure KDB procedures

This device described above has been tested by Shenzhen NTEK. In accordance with the measurement methods and procedures specified in IEEE Std 1528-2013 and KDB 865664 D01. Testing has shown that this device is capable of compliance with localized specific absorption rate (SAR) specified in FCC 47 CFR Part 2(2.1093) and ANSI/IEEE C95.1-1992. The test results in this report apply only to the tested sample of the stated device/equipment. Other similar device/equipment will not necessarily produce the same results due to production tolerance and measurement uncertainties.

This report shall not be reproduced except in full, without the written approval of Shenzhen NTEK, this document may be altered or revised by Shenzhen NTEK, personal only, and shall be noted in the revision of the document.

Date of Test

Date (s) of performance of tests Dec. 17, 2020 ~ Dec. 24, 2020

Date of Issue Dec. 25, 2020

Test Result **Pass**

Prepared By (Test Engineer) : Cheng Jiawen
(Cheng Jiawen)

Approved By (Lab Manager) : Alex
(Alex Li)

※ ※ Revision History ※ ※

REV.	DESCRIPTION	ISSUED DATE	REMARK
Rev.1.0	Initial Test Report Release	Dec. 25, 2020	Cheng Jiawen

TABLE OF CONTENTS

1. General Information	6
1.1. RF exposure limits.....	6
1.2. Statement of Compliance	7
1.3. EUT Description	7
1.4. Test specification(s)	8
1.5. Ambient Condition.....	8
2. SAR Measurement System	9
2.1. SATIMO SAR Measurement Set-up Diagram	9
2.2. Robot	10
2.3. E-Field Probe.....	11
2.3.1. E-Field Probe Calibration	11
2.4. SAM phantoms	12
2.4.1. Technical Data	13
2.5. Device Holder	14
2.6. Test Equipment List	15
3. SAR Measurement Procedures	17
3.1. Power Reference	17
3.2. Area scan & Zoom scan.....	17
3.3. Description of interpolation/extrapolation scheme	19
3.4. Volumetric Scan	19
3.5. Power Drift	19
4. System Verification Procedure	20
4.1. Tissue Verification	20
4.1.1. Tissue Dielectric Parameter Check Results	21
4.2. System Verification Procedure	22
4.2.1. System Verification Results.....	23
5. SAR Measurement variability and uncertainty	24
5.1. SAR measurement variability.....	24
5.2. SAR measurement uncertainty	25
6. RF Exposure Positions.....	26
6.1. Tablet host platform exposure conditions.....	26
7. RF Output Power	27
7.1. WLAN & Bluetooth Output Power	27
8. Antenna Location.....	30
9. Stand-alone SAR test exclusion.....	37
10. SAR Results	37
10.1. SAR measurement Result.....	37
10.1.1. SAR measurement Result of WLAN 2.4G	37
10.1.2. SAR measurement Result of WLAN 5.2G	38

10.1.3.	SAR measurement Result of WLAN 5.3G	38
10.1.4.	SAR measurement Result of WLAN 5.6G	39
10.1.5.	SAR measurement Result of WLAN 5.8G	40
10.2.	Simultaneous Transmission Analysis.....	41
11.	Appendix A. Photo documentation	41
12.	Appendix B. System Check Plots	42
13.	Appendix C. Plots of High SAR Measurement.....	53
14.	Appendix D. Calibration Certificate	64

1. General Information

1.1. RF exposure limits

(A).Limits for Occupational/Controlled Exposure (W/kg)

Whole-Body	Partial-Body	Hands, Wrists, Feet and Ankles
0.4	8.0	20.0

(B).Limits for General Population/Uncontrolled Exposure (W/kg)

Whole-Body	Partial-Body	Hands, Wrists, Feet and Ankles
0.08	1.6	4.0

NOTE: **Whole-Body SAR** is averaged over the entire body, **partial-body SAR** is averaged over any 1 gram of tissue defined as a tissue volume in the shape of a cube. **SAR for hands, wrists, feet and ankles** is averaged over any 10 grams of tissue defined as a tissue volume in the shape of a cube.

Occupational/Controlled Environments:

Are defined as locations where there is exposure that may be incurred by people who are aware of the potential for exposure, (i.e. as a result of employment or occupation).

General Population/Uncontrolled Environments:

Are defined as locations where there is the exposure of individuals who have no knowledge or control of their exposure.

NOTE
 TRUNK LIMIT
 1.6 W/kg
 APPLIED TO THIS EUT

1.2. Statement of Compliance

The maximum results of Specific Absorption Rate (SAR) found during testing for 3165D2W are as follows.

Band	Max Reported SAR Value(W/kg)
	1-g Body (Separation distance of 0mm)
WLAN 2.4G	1.343
WLAN 5.2G	1.342
WLAN 5.3G	1.286
WLAN 5.6G	1.434
WLAN 5.8G	1.071

Note: This device is in compliance with Specific Absorption Rate (SAR) for general population / uncontrolled exposure limits (1.6 W/kg) specified in FCC 47 CFR Part 2(2.1093) and ANSI/IEEE C95.1-1992, and had been tested in accordance with the measurement methods and procedures specified in IEEE Std 1528-2013 & KDB 865664 D01.

1.3. EUT Description

Device Information			
Product Name	WLAN+Bluetooth module 3165D2W		
Brand Name	acer		
Model Name	3165D2W		
FCC ID	HLZ3165D2		
Device Phase	Identical Prototype		
Exposure Category	General population / Uncontrolled environment		
Antenna Type	PIFA Antenna		
Battery Information	DC 7.4V, 5000mAh		
Device Operating Configurations			
Supporting Mode(s)	WLAN 2.4G/5G, Bluetooth		
Test Modulation	WLAN(DSSS/OFDM), Bluetooth(GFSK, $\pi/4$ -DQPSK, 8DPSK)		
Device Class	B		
Operating Frequency Range(s)	Band	Tx (MHz)	Rx (MHz)
	WLAN 2.4G	2412-2462	
	WLAN 5.2G	5180-5240	
	WLAN 5.3G	5260-5320	
	WLAN 5.6G	5500-5720	
	WLAN 5.8G	5745-5825	
	Bluetooth	2402-2480	

The product was installed into Windows Tablet (Brand Name: acer, Model Name: N19E1, Acer ENDURO T5,

ET510-51W) during test.

1.4. Test specification(s)

FCC 47 CFR Part 2(2.1093)
ANSI/IEEE C95.1-1992
IEEE Std 1528-2013
KDB 865664 D01 SAR measurement 100 MHz to 6 GHz
KDB 865664 D02 RF Exposure Reporting
KDB 447498 D01 General RF Exposure Guidance
KDB 248227 D01 802.11 Wi-Fi SAR
KDB 616217 D04 SAR for laptop and tablets

1.5. Ambient Condition

Ambient temperature	20°C – 24°C
Relative Humidity	30% – 70%

2. SAR Measurement System

2.1. SATIMO SAR Measurement Set-up Diagram

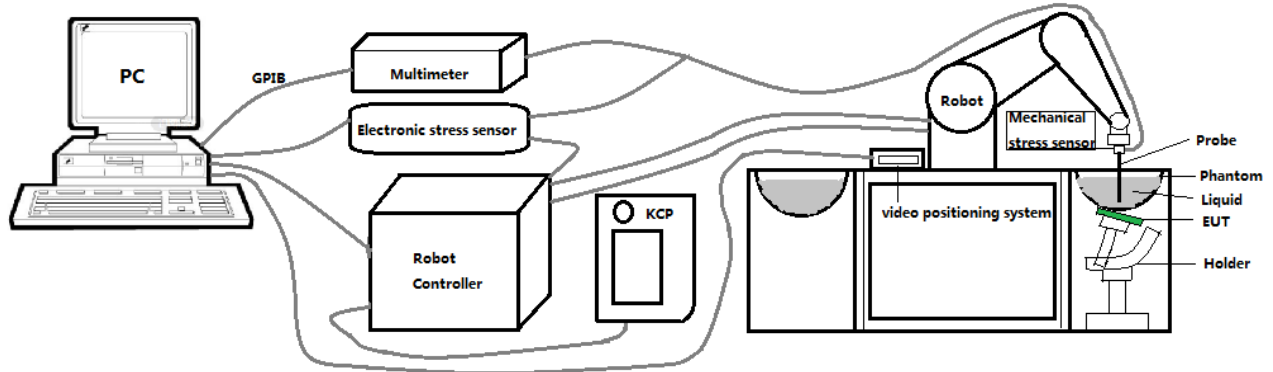

These measurements were performed with the automated near-field scanning system OPENSAR from SATIMO. The system is based on a high precision robot (working range: 901 mm), which positions the probes with a positional repeatability of better than ± 0.03 mm. The SAR measurements were conducted with dosimetric probe (manufactured by SATIMO), designed in the classical triangular configuration and optimized for dosimetric evaluation.

The first step of the field measurement is the evaluation of the voltages induced on the probe by the device under test. Probe diode detectors are nonlinear. Below the diode compression point, the output voltage is proportional to the square of the applied E-field; above the diode compression point, it is linear to the applied E-field. The compression point depends on the diode, and a calibration procedure is necessary for each sensor of the probe.

The Keithley multimeter reads the voltage of each sensor and send these three values to the PC. The corresponding E field value is calculated using the probe calibration factors, which are stored in the working directory. This evaluation includes linearization of the diode characteristics. The field calculation is done separately for each sensor. Each component of the E field is displayed on the "Dipole Area Scan Interface" and the total E field is displayed on the "3D Interface"

2.2. Robot

The SATIMO SAR system uses the high precision robots from KUKA. For the 6-axis controller system, the robot controller version (KUKA) from KUKA is used. The KUKA robot series have many features that are important for our application:



- High precision (repeatability ± 0.03 mm)
- High reliability (industrial design)
- Jerk-free straight movements
- Low ELF interference (the closed metallic construction shields against motor control fields)

2.3. E-Field Probe

This E-field detection probe is composed of three orthogonal dipoles linked to special Schottky diodes with low detection thresholds. The probe allows the measurement of electric fields in liquids such as the one defined in the IEEE and CENELEC standards.

For the measurements the Specific Dosimetric E-Field Probe SN 08/16 EPGO287 with following specifications is used



- Dynamic range: 0.01-100 W/kg
 - Tip Diameter: 2.5 mm
 - Distance between probe tip and sensor center: 1 mm
 - Distance between sensor center and the inner phantom surface: 2 mm (repeatability better than ± 1 mm).
 - Probe linearity: ± 0.08 dB
 - Axial isotropy: 0.06 dB
 - Hemispherical Isotropy: 0.08 dB
 - Calibration range: 650MHz to 5900MHz for head & body simulating liquid.
 - Lower detection limit: 7mW/kg
- Angle between probe axis (evaluation axis) and surface normal line: less than 30° .

2.3.1. E-Field Probe Calibration

Each probe needs to be calibrated according to a dosimetric assessment procedure with accuracy better than $\pm 10\%$. The spherical isotropy shall be evaluated and within ± 0.25 dB. The sensitivity parameters (Norm X, Norm Y, and Norm Z), the diode compression parameter (DCP) and the conversion factor (Conv F) of the probe are tested. The calibration data can be referred to appendix D of this report.

2.4. SAM phantoms

Photo of SAM phantom SN 16/15 SAM119



The SAM phantom is used to measure the SAR relative to people exposed to electro-magnetic field radiated by mobile phones.

2.4.1. Technical Data

Serial Number	Shell thickness	Filling volume	Dimensions	Positionner Material	Permittivity	Loss Tangent
SN 16/15 SAM119	2 mm ±0.2 mm	27 liters	Length:1000 mm Width:500 mm Height:200 mm	Gelcoat with fiberglass	3.4	0.02

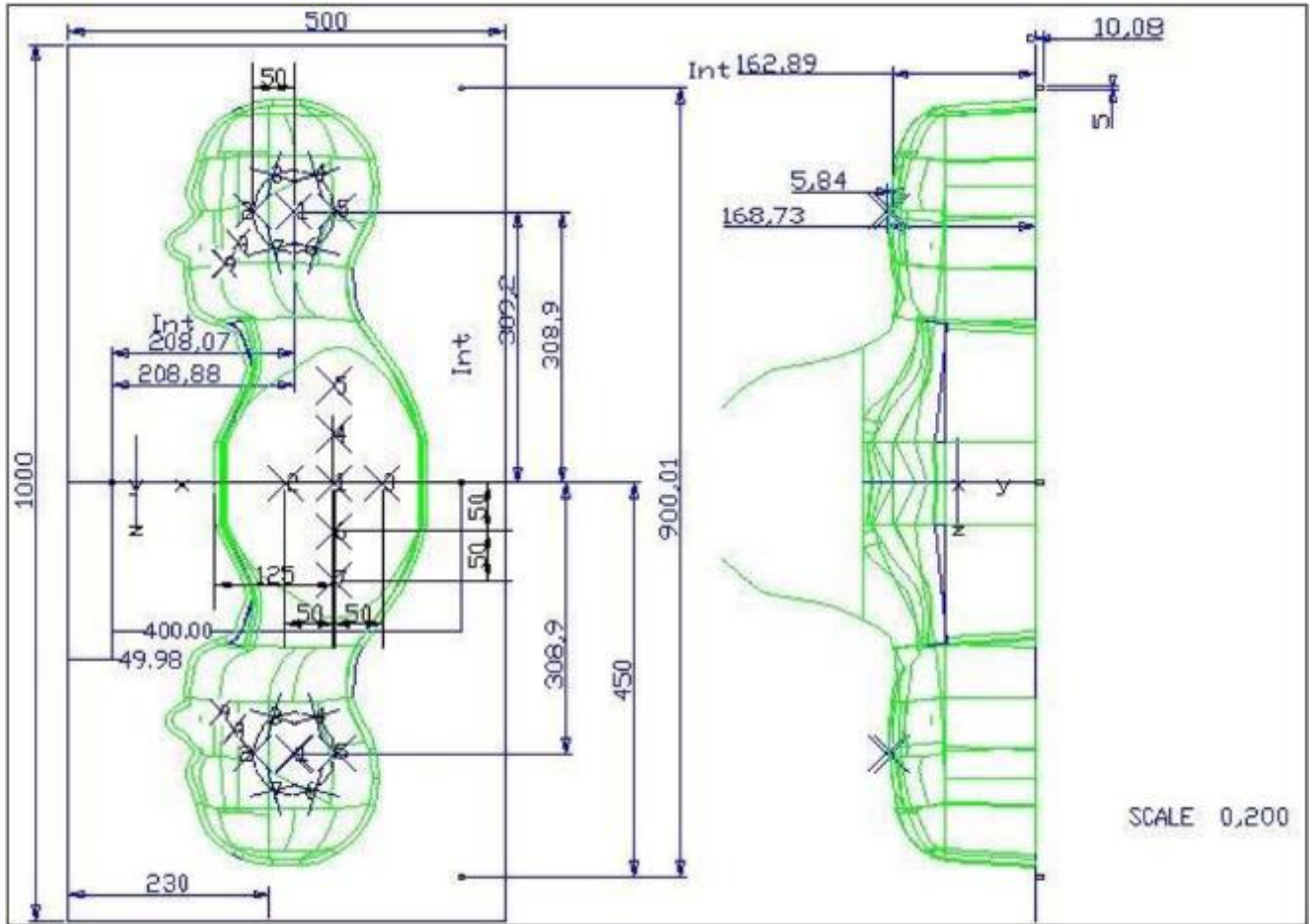

Serial Number	Left Head(mm)		Right Head(mm)		Flat Part(mm)	
	1	2	1	2	1	2
SN 16/15 SAM119	2	2.02	2	2.08	1	2.09
	3	2.05	3	2.06	2	2.06
	4	2.07	4	2.07	3	2.08
	5	2.08	5	2.08	4	2.10
	6	2.05	6	2.07	5	2.10
	7	2.05	7	2.05	6	2.07
	8	2.07	8	2.06	7	2.07
	9	2.08	9	2.06	-	-

The test, based on ultrasonic system, allows measuring the thickness with an accuracy of 10 µm.

2.5. Device Holder

The positioning system allows obtaining cheek and tilting position with a very good accuracy. In compliance with CENELEC, the tilt angle uncertainty is lower than 1 degree.

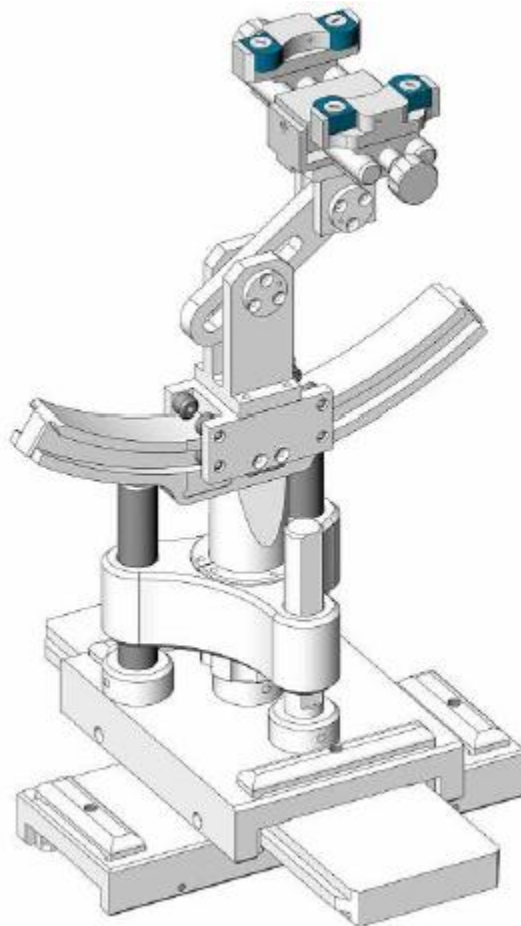

Serial Number	Holder Material	Permittivity	Loss Tangent
SN 16/15 MSH100	Delrin	3.7	0.005

2.6. Test Equipment List

This table gives a complete overview of the SAR measurement equipment.

Devices used during the test described are marked

	Manufacturer	Name of Equipment	Type/Model	Serial Number	Calibration	
					Last Cal.	Due Date
<input checked="" type="checkbox"/>	MVG	E FIELD PROBE	SSE2	SN 08/16 EPGO287	Dec. 27, 2019	Dec. 26, 2020
<input type="checkbox"/>	MVG	750 MHz Dipole	SID750	SN 03/15 DIP 0G750-355	Apr. 19, 2018	Apr. 18, 2021
<input type="checkbox"/>	MVG	835 MHz Dipole	SID835	SN 03/15 DIP 0G835-347	Apr. 19, 2018	Apr. 18, 2021
<input type="checkbox"/>	MVG	900 MHz Dipole	SID900	SN 03/15 DIP 0G900-348	Apr. 19, 2018	Apr. 18, 2021
<input type="checkbox"/>	MVG	1800 MHz Dipole	SID1800	SN 03/15 DIP 1G800-349	Apr. 19, 2018	Apr. 18, 2021
<input type="checkbox"/>	MVG	1900 MHz Dipole	SID1900	SN 03/15 DIP 1G900-350	Apr. 19, 2018	Apr. 18, 2021
<input type="checkbox"/>	MVG	2000 MHz Dipole	SID2000	SN 03/15 DIP 2G000-351	Apr. 19, 2018	Apr. 18, 2021
<input checked="" type="checkbox"/>	MVG	2450 MHz Dipole	SID2450	SN 03/15 DIP 2G450-352	Apr. 19, 2018	Apr. 18, 2021
<input type="checkbox"/>	MVG	2600 MHz Dipole	SID2600	SN 03/15 DIP 2G600-356	Apr. 19, 2018	Apr. 18, 2021
<input checked="" type="checkbox"/>	MVG	5000 MHz Dipole	SWG5500	SN 13/14 WGA 33	Apr. 19, 2018	Apr. 18, 2021
<input checked="" type="checkbox"/>	MVG	Liquid measurement Kit	SCLMP	SN 21/15 OCPG 72	NCR	NCR
<input checked="" type="checkbox"/>	MVG	Power Amplifier	N.A	AMPLISAR_28/14_003	NCR	NCR
<input checked="" type="checkbox"/>	KEITHLEY	Millivoltmeter	2000	4072790	NCR	NCR
<input type="checkbox"/>	R&S	Universal radio communication tester	CMU200	117858	Jul. 13, 2020	Jul. 12, 2021
<input type="checkbox"/>	R&S	Wideband radio communication tester	CMW500	103917	Jul. 13, 2020	Jul. 12, 2021
<input checked="" type="checkbox"/>	HP	Network Analyzer	8753D	3410J01136	Jul. 13, 2020	Jul. 12, 2021
<input checked="" type="checkbox"/>	Agilent	PSG Analog Signal Generator	E8257D	MY51110112	Jul. 13, 2020	Jul. 12, 2021

<input checked="" type="checkbox"/>	Agilent	Power meter	E4419B	MY45102538	Jul. 13, 2020	Jul. 12, 2021
<input checked="" type="checkbox"/>	Agilent	Power sensor	E9301A	MY41495644	Jul. 13, 2020	Jul. 12, 2021
<input checked="" type="checkbox"/>	Agilent	Power sensor	E9301A	US39212148	Jul. 13, 2020	Jul. 12, 2021
<input checked="" type="checkbox"/>	MCLI/USA	Directional Coupler	CB11-20	0D2L51502	Jul. 17, 2020	Jul. 16, 2023

3. SAR Measurement Procedures

The measurement procedures are as follows:

<Conducted power measurement>

- (a) For WWAN power measurement, use base station simulator to configure EUT WWAN transmission in conducted connection with RF cable, at maximum power in each supported wireless interface and frequency band.
- (b) Read the WWAN RF power level from the base station simulator.
- (c) For Wi-Fi/BT power measurement, use engineering software to configure EUT Wi-Fi/BT continuously transmission, at maximum RF power in each supported wireless interface and frequency band.
- (d) Connect EUT RF port through RF cable to the power meter, and measure Wi-Fi/BT output power.

<SAR measurement>

- (a) Use base station simulator to configure EUT WWAN transmission in radiated connection, and engineering software to configure EUT Wi-Fi/BT continuously transmission, at maximum RF power, in the highest power channel.
- (b) Place the EUT in the positions as Appendix A demonstrates.
- (c) Set scan area, grid size and other setting on the OPENSAR software.
- (d) Measure SAR results for the highest power channel on each testing position.
- (e) Find out the largest SAR result on these testing positions of each band.
- (f) Measure SAR results for other channels in worst SAR testing position if the reported SAR of highest power channel is larger than 0.8 W/kg.

According to the test standard, the recommended procedure for assessing the peak spatial-average SAR value consists of the following steps:

- (a) Power reference measurement
- (b) Area scan
- (c) Zoom scan
- (d) Power drift measurement

3.1. Power Reference

The Power Reference Measurement and Power Drift Measurements are for monitoring the power drift of the device under test in the batch process. The minimum distance of probe sensors to surface determines the closest measurement point to phantom surface. This distance cannot be smaller than the distance of sensor calibration points to probe tip as defined in the probe properties.

3.2. Area scan & Zoom scan

The area scan is a 2D scan to find the hot spot location on the DUT. The zoom scan is a 3D scan above the hot spot to calculate the 1g and 10g SAR value.

Measurement of the SAR distribution with a grid of 8 to 16 mm * 8 to 16 mm and a constant distance to

the inner surface of the phantom. Since the sensors cannot directly measure at the inner phantom surface, the values between the sensors and the inner phantom surface are extrapolated. With these values the area of the maximum SAR is calculated by an interpolation scheme. Around this point, a cube of 30 * 30 * 30 mm or 32 * 32 * 32 mm is assessed by measuring 5 or 8 * 5 or 8 * 4 or 5 mm. With these data, the peak spatial-average SAR value can be calculated.

From the scanned SAR distribution, identify the position of the maximum SAR value, in addition identify the positions of any local maxima with SAR values within 2 dB of the maximum value that will not be within the zoom scan of other peaks; additional peaks shall be measured only when the primary peak is within 2 dB of the SAR compliance limit (e.g., 1 W/kg for 1,6 W/kg 1 g limit, or 1,26 W/kg for 2 W/kg, 10 g limit).

Area scan & Zoom scan scan parameters extracted from FCC KDB 865664 D01 SAR measurement 100 MHz to 6 GHz.

		≤ 3 GHz	> 3 GHz
Maximum distance from closest measurement point (geometric center of probe sensors) to phantom surface		5 ± 1 mm	$\frac{1}{2} \cdot \delta \cdot \ln(2) \pm 0.5$ mm
Maximum probe angle from probe axis to phantom surface normal at the measurement location		30° ± 1°	20° ± 1°
Maximum area scan spatial resolution: Δx_{Area} , Δy_{Area}		≤ 2 GHz: ≤ 15 mm 2 – 3 GHz: ≤ 12 mm	3 – 4 GHz: ≤ 12 mm 4 – 6 GHz: ≤ 10 mm
		When the x or y dimension of the test device, in the measurement plane orientation, is smaller than the above, the measurement resolution must be ≤ the corresponding x or y dimension of the test device with at least one measurement point on the test device.	
Maximum zoom scan spatial resolution: Δx_{Zoom} , Δy_{Zoom}		≤ 2 GHz: ≤ 8 mm 2 – 3 GHz: ≤ 5 mm*	3 – 4 GHz: ≤ 5 mm* 4 – 6 GHz: ≤ 4 mm*
Maximum zoom scan spatial resolution, normal to phantom surface	uniform grid: $\Delta z_{Zoom}(n)$	≤ 5 mm	3 – 4 GHz: ≤ 4 mm 4 – 5 GHz: ≤ 3 mm 5 – 6 GHz: ≤ 2 mm
	graded grid	$\Delta z_{Zoom}(1)$: between 1 st two points closest to phantom surface	≤ 4 mm 3 – 4 GHz: ≤ 3 mm 4 – 5 GHz: ≤ 2.5 mm 5 – 6 GHz: ≤ 2 mm
		$\Delta z_{Zoom}(n>1)$: between subsequent points	≤ 1.5 · $\Delta z_{Zoom}(n-1)$
Minimum zoom scan volume	x, y, z	≥ 30 mm	3 – 4 GHz: ≥ 28 mm 4 – 5 GHz: ≥ 25 mm 5 – 6 GHz: ≥ 22 mm

Note: δ is the penetration depth of a plane-wave at normal incidence to the tissue medium; see draft standard IEEE P1528-2011 for details.

* When zoom scan is required and the *reported* SAR from the *area scan based 1-g SAR estimation* procedures of KDB 447498 is ≤ 1.4 W/kg, ≤ 8 mm, ≤ 7 mm and ≤ 5 mm zoom scan resolution may be applied, respectively, for 2 GHz to 3 GHz, 3 GHz to 4 GHz and 4 GHz to 6 GHz.

3.3. Description of interpolation/extrapolation scheme

The local SAR inside the phantom is measured using small dipole sensing elements inside a probe body. The probe tip must not be in contact with the phantom surface in order to minimise measurements errors, but the highest local SAR will occur at the surface of the phantom.

An extrapolation is using to determinate this highest local SAR values. The extrapolation is based on a fourth-order least-square polynomial fit of measured data. The local SAR value is then extrapolated from the liquid surface with a 1 mm step.

The measurements have to be performed over a limited time (due to the duration of the battery) so the step of measurement is high. It could vary between 5 and 8 mm. To obtain an accurate assessment of the maximum SAR averaged over 10 grams and 1 gram requires a very fine resolution in the three dimensional scanned data array.

3.4. Volumetric Scan

The volumetric scan consists to a full 3D scan over a specific area. This 3D scan is useful form multi Tx SAR measurement. Indeed, it is possible with OpenSAR to add, point by point, several volumetric scan to calculate the SAR value of the combined measurement as it is define in the standard IEEE1528 and IEC62209.

3.5. Power Drift

All SAR testing is under the EUT install full charged battery and transmit maximum output power. In OpenSAR measurement software, the power reference measurement and power drift measurement procedures are used for monitoring the power drift of EUT during SAR test. Both these procedures measure the field at a specified reference position before and after the SAR testing. The software will calculate the field difference in V/m. If the power drifts more than $\pm 5\%$, the SAR will be retested.

4. System Verification Procedure

4.1. Tissue Verification

The following tissue formulations are provided for reference only as some of the parameters have not been thoroughly verified. The composition of ingredients may be modified accordingly to achieve the desired target tissue parameters required for routine SAR evaluation.

Ingredients (% of weight)	Head Tissue									
	750	835	900	1800	1900	2000	2450	2600	5200	5800
Frequency Band (MHz)										
Water	34.40	34.40	34.40	55.36	55.36	57.87	57.87	57.87	65.53	65.53
NaCl	0.79	0.79	0.79	0.35	0.35	0.16	0.16	0.16	0.00	0.00
1,2-Propanediol	64.81	64.81	64.81	0.00	0.00	0.00	0.00	0.00	0.00	0.00
Triton X-100	0.00	0.00	0.00	30.45	30.45	19.97	19.97	19.97	24.24	24.24
DGBE	0.00	0.00	0.00	13.84	13.84	22.00	22.00	22.00	10.23	10.23
Ingredients (% of weight)	Body Tissue									
	750	835	900	1800	1900	2000	2450	2600	5200	5800
Frequency Band (MHz)										
Water	50.30	50.30	50.30	69.91	69.91	71.88	71.88	71.88	79.54	79.54
NaCl	0.60	0.60	0.60	0.13	0.13	0.16	0.16	0.16	0.00	0.00
1,2-Propanediol	49.10	49.10	49.10	0.00	0.00	0.00	0.00	0.00	0.00	0.00
Triton X-100	0.00	0.00	0.00	9.99	9.99	19.97	19.97	19.97	11.24	11.24
DGBE	0.00	0.00	0.00	19.97	19.97	7.99	7.99	7.99	9.22	9.22

For SAR measurement of the field distribution inside the phantom, the phantom must be filled with homogeneous tissue simulating liquid to a depth of at least 15 cm. For head SAR testing, the liquid depth from the ear reference point (ERP) of the phantom to the liquid top surface is larger than 15 cm.

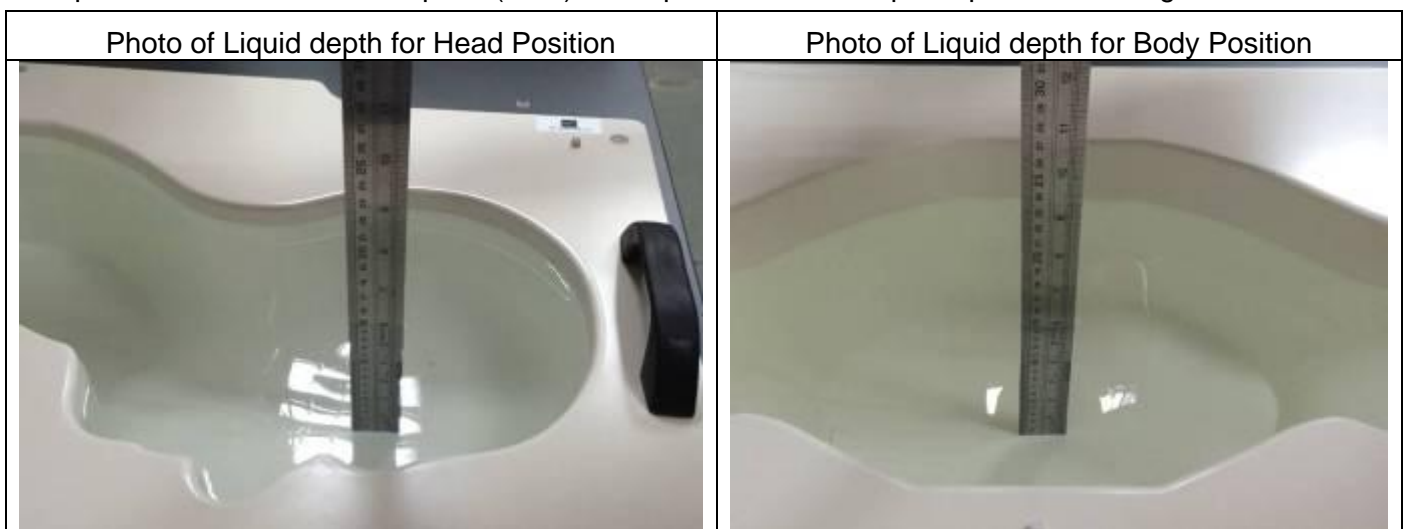

4.1.1. Tissue Dielectric Parameter Check Results

The simulating liquids should be checked at the beginning of a series of SAR measurements to determine if the dielectric parameters are within the tolerances of the specified target values. The measured conductivity and relative permittivity should be within $\pm 5\%$ of the target values.

Tissue Type	Measured Frequency (MHz)	Target Tissue		Measured Tissue		Liquid Temp.	Test Date
		ϵ_r ($\pm 5\%$)	σ (S/m) ($\pm 5\%$)	ϵ_r	σ (S/m)		
Body 2450	2450	52.70 (50.07~55.34)	1.95 (1.85~2.05)	52.30	1.94	21.5 °C	Dec. 23, 2020
Body 5200	5200	49.00 (46.55~51.45)	5.30 (5.04~5.57)	50.26	5.34	21.3 °C	Dec. 24, 2020
Body 5400	5400	48.70 (46.27~51.14)	5.53 (5.25~5.81)	48.85	5.67	21.4 °C	Dec. 17, 2020
Body 5600	5600	48.50 (46.08~50.93)	5.77 (5.48~6.06)	49.92	5.74	21.4 °C	Dec. 18, 2020
Body 5800	5800	48.20 (45.79~50.61)	6.00 (5.70~6.30)	48.71	6.05	21.2 °C	Dec. 24, 2020

NOTE: The dielectric parameters of the tissue-equivalent liquid should be measured under similar ambient conditions and within 2 °C of the conditions expected during the SAR evaluation to satisfy protocol requirements.

4.2. System Verification Procedure

The system verification is performed for verifying the accuracy of the complete measurement system and performance of the software. The dipole is connected to the signal source consisting of signal generator and amplifier via a directional coupler, N-connector cable and adaption to SMA. It is fed with a power of 100mW (below 5GHz) or 100mW (above 5GHz). To adjust this power a power meter is used. The power sensor is connected to the cable before the system verification to measure the power at this point and do adjustments at the signal generator. At the outputs of the directional coupler both return loss as well as forward power are controlled during the system verification to make sure that emitted power at the dipole is kept constant. This can also be checked by the power drift measurement after the test (result on plot).

The system verification is shown as below picture:

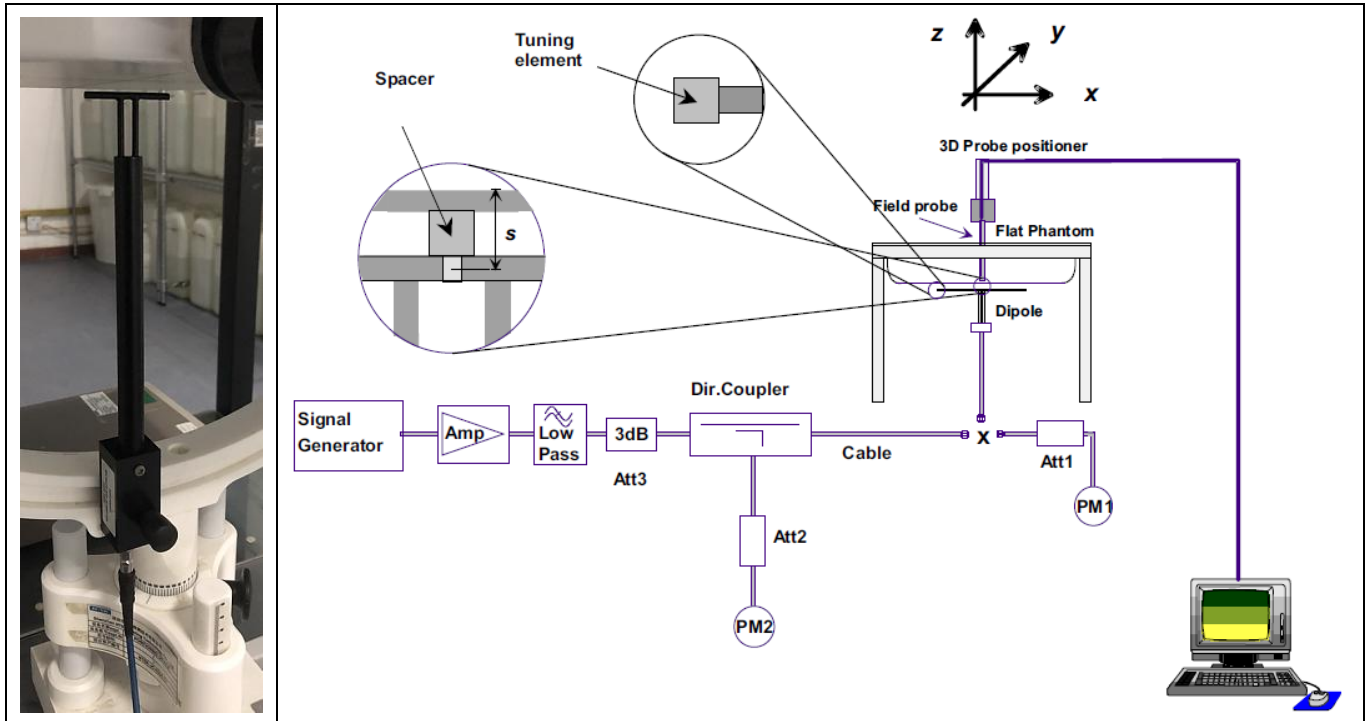

4.2.1. System Verification Results

Comparing to the original SAR value provided by SATIMO, the verification data should be within its specification of $\pm 10\%$. Below table shows the target SAR and measured SAR after normalized to 1W input power. The table below indicates the system performance verification can meet the variation criterion and the plots can be referred to Appendix B of this report.

System Verification	Target SAR (1W) ($\pm 10\%$)		Measured SAR (Normalized to 1W)		Liquid Temp.	Test Date
	1-g (W/Kg)	10-g (W/Kg)	1-g (W/Kg)	10-g (W/Kg)		
2450MHz Body	52.90 (47.61~58.19)	24.09 (21.68~26.50)	55.17	24.27	21.5 °C	Dec. 23, 2020
5200MHz Body	156.85 (141.17~172.54)	55.20 (49.68~60.72)	155.98	56.59	21.3 °C	Dec. 24, 2020
5400MHz Body	163.97 (147.57~180.37)	57.26 (51.53~62.99)	169.84	61.18	21.4 °C	Dec. 17, 2020
5600MHz Body	166.58 (149.92~183.24)	57.87 (52.08~63.66)	179.94	60.85	21.4 °C	Dec. 18, 2020
5800MHz Body	169.30 (152.37~186.23)	58.49 (52.64~64.34)	168.86	57.43	21.2 °C	Dec. 24, 2020

5. SAR Measurement variability and uncertainty

5.1. SAR measurement variability

Per KDB865664 D01 SAR measurement 100 MHz to 6 GHz, SAR measurement variability must be assessed for each frequency band, which is determined by the SAR probe calibration point and tissue-equivalent medium used for the device measurements. The additional measurements are repeated after the completion of all measurements requiring the same head or body tissue-equivalent medium in a frequency band. The test device should be returned to ambient conditions (normal room temperature) with the battery fully charged before it is re-mounted on the device holder for the repeated measurement(s) to minimize any unexpected variations in the repeated results.

- 1) Repeated measurement is not required when the original highest measured SAR is < 0.80 W/kg; steps 2) through 4) do not apply.
- 2) When the original highest measured SAR is ≥ 0.80 W/kg, repeat that measurement once.
- 3) Perform a second repeated measurement only if the ratio of largest to smallest SAR for the original and first repeated measurements is > 1.20 or when the original or repeated measurement is ≥ 1.45 W/kg (~ 10% from the 1-g SAR limit).
- 4) Perform a third repeated measurement only if the original, first or second repeated measurement is ≥ 1.5 W/kg and the ratio of largest to smallest SAR for the original, first and second repeated measurements is > 1.20 .

5.2. SAR measurement uncertainty

The following measurement uncertainty levels have been estimated for tests performed on the EUT as specified in IEEE 1528: 2003. This uncertainty represents an expanded uncertainty expressed at approximately the 95% confidence level using a coverage factor of k=2.

Uncertainty Component	Tol. (±%)	Prob. Dist.	Div.	Ci (1 g)	Ci (10 g)	1 g Ui (±%)	10 g Ui (±%)	Vi
Measurement System □								
Probe Calibration	5.8	N	1	1	1	5.80	5.80	∞
Axial Isotropy	3.5	R	√3	0.7	0.7	1.43	1.43	∞
Hemispherical Isotropy	5.9	R	√3	0.7	0.7	2.41	2.41	∞
Boundary Effect	1	R	√3	1	1	0.58	0.58	∞
Linearity	4.7	R	√3	1	1	2.71	2.71	∞
System Detection Limits	1	R	√3	1	1	0.58	0.58	∞
Modulation response	3	N	1	1	1	3.00	3.00	∞
Readout Electronics	0.5	N	1	1	1	0.50	0.50	∞
Response Time	0	R	√3	1	1	0.00	0.00	∞
Integration Time	1.4	R	√3	1	1	0.81	0.81	∞
RF Ambient Conditions - Noise	3	R	√3	1	1	1.73	1.73	∞
RF Ambient Conditions - Reflections	3	R	√3	1	1	1.73	1.73	∞
Probe Positioner Mechanical Tolerance	1.4	R	√3	1	1	0.81	0.81	∞
Probe Positioning with respect to Phantom Shell	1.4	R	√3	1	1	0.81	0.81	∞
Extrapolation, interpolation and Integration Algorithms for Max. SAR Evaluation	2.3	R	√3	1	1	1.33	1.33	∞
Test sample Related								
Test Sample Positioning	2.6	N	1	1	1	2.60	2.60	11
Device Holder Uncertainty	3	N	1	1	1	3.00	3.00	7
Output Power Variation - SAR drift measurement	5	R	√3	1	1	2.89	2.89	∞
SAR scaling	2	R	√3	1	1	1.15	1.15	∞
Phantom and Tissue Parameters □								
Phantom Uncertainty (shape and thickness tolerances)	4	R	√3	1	1	2.31	2.31	∞
Uncertainty in SAR correction for deviation (in permittivity and conductivity)	2	N	1	1	0.84	2.00	1.68	∞
Liquid Conductivity (temperature uncertainty)	2.5	N	1	0.78	0.71	1.95	1.78	5
Liquid conductivity - measurement uncertainty	4	N	1	0.23	0.26	0.92	1.04	5
Liquid permittivity (temperature uncertainty)	2.5	N	1	0.78	0.71	1.95	1.78	∞
Liquid permittivity - measurement uncertainty	5	N	1	0.23	0.26	1.15	1.30	∞
Combined Standard Uncertainty		RSS				10.63	10.54	
Expanded Uncertainty (95% Confidence interval)		k				21.26	21.08	

6. RF Exposure Positions

6.1. Tablet host platform exposure conditions

Refer to KDB616217 D04, when the modular approach is used, transmitters and modules must be initially tested for standalone operations in generic host conditions according to the following minimum test separation distance and antenna installation requirements for incorporation in the tablet platform. The separation distance required for incorporation in qualified hosts is described in KDB 447498; item 5) of section 4.1 and item 1) of section 5.2.2 etc.

- ≤ 5 mm between the antenna and user for both back surface and edge exposure conditions
- the antennas used by the host must have been tested for equipment approval or qualify for SAR test exclusion
- the antenna polarization, physical orientation, rotation and installation configurations used by the host must have been tested for compliance or qualify for test exclusion
- when the *SAR Test Exclusion Threshold* in KDB 447498 applies, a *test separation distance* of 5 mm is required to determine test exclusion for the tablet platform

The antennas embedded in tablets are typically ≤ 5 mm from the outer housing. The required antenna to user test separation distance is a “not to exceed test” distance required to apply the modular approach. Instead of the typical zero gap tablet edge test requirement between the edge of a tablet and the user, when an antenna has been tested at ≤ 5 mm according to the modular approach it can be incorporated into tablets with at least twice the tested distance from the outer housing of the tablet edge; otherwise, the tablet edge zero gap test requirement applies. When the dedicated host approach is applied, the back surface and edges of the tablet should be tested for SAR compliance with the tablet touching the phantom.

7. RF Output Power

7.1. WLAN & Bluetooth Output Power

Mode	Channel	Frequency (MHz)	Average Output Power (dBm)				Duty Cycle %
			Tune-up	ANT1	Tune-up	ANT2	
802.11b	1	2412	14.50	14.35	14.50	14.33	99%
	6	2437	14.50	14.36	14.50	14.01	99%
	11	2462	14.50	14.49	14.50	14.48	99%
802.11g	1	2412	14.00	13.49	14.00	13.34	99%
	6	2437	14.00	13.88	14.00	13.62	99%
	11	2462	12.50	12.16	12.50	12.12	99%
802.11n HT20	1	2412	13.00	12.38	13.00	12.47	99%
	6	2437	13.00	12.37	13.00	12.17	99%
	11	2462	13.00	12.52	13.00	12.24	99%
802.11n HT40	3	2422	12.00	11.74	12.00	11.62	98%
	6	2437	12.00	11.64	12.00	11.79	98%
	9	2452	12.00	11.47	12.00	11.39	98%

NOTE: Power measurement results of WLAN 2.4G.

Mode	Channel	Frequency (MHz)	Average Output Power (dBm)				Duty Cycle %
			Tune-up	ANT1	Tune-up	ANT2	
802.11a	36	5180	13.50	12.68	13.00	12.86	99%
	40	5200	13.50	13.02	13.00	12.99	99%
	48	5240	13.50	13.36	13.00	12.63	99%
802.11n HT20	36	5180	13.00	12.49	13.00	12.09	99%
	40	5200	13.00	12.57	13.00	12.62	99%
	48	5240	13.00	12.16	13.00	12.93	99%
802.11n HT40	38	5190	13.00	11.78	13.00	12.17	98%
	46	5230	13.00	12.12	13.00	11.84	98%
802.11ac VHT20	36	5180	13.00	11.76	13.00	11.81	99%
	40	5200	13.00	11.80	13.00	11.90	99%
	48	5240	13.00	12.14	13.00	12.79	99%
802.11ac VHT40	38	5190	11.00	10.56	11.00	10.57	98%
	46	5230	11.00	10.91	11.00	10.93	98%
802.11ac VHT80	42	5210	11.00	10.18	10.00	9.38	95%

NOTE: Power measurement results of WLAN 5.2G.

Mode	Channel	Frequency (MHz)	Average Output Power (dBm)				Duty Cycle %
			Tune-up	ANT1	Tune-up	ANT2	

802.11a	52	5260	13.50	13.06	13.50	13.01	99%
	56	5280	13.50	13.20	13.50	13.18	99%
	64	5320	13.50	13.43	13.50	13.36	99%
802.11n HT20	52	5260	13.00	12.20	13.00	12.56	99%
	56	5280	13.00	12.34	13.00	12.75	99%
	64	5320	13.00	12.55	13.00	12.96	99%
802.11n HT40	54	5270	13.00	11.80	12.00	11.78	98%
	62	5310	13.00	12.01	12.00	11.93	98%
802.11ac VHT20	52	5260	13.00	11.71	13.00	11.84	99%
	56	5280	13.00	11.89	13.00	11.97	99%
	64	5320	13.00	12.08	13.00	12.22	99%
802.11ac VHT40	54	5270	12.00	10.92	12.00	10.88	98%
	62	5310	12.00	11.17	12.00	11.14	98%
802.11ac VHT80	58	5290	10.00	9.87	10.00	9.80	95%

NOTE: Power measurement results of WLAN 5.3G.

Mode	Channel	Frequency (MHz)	Average Output Power (dBm)				Duty Cycle %
			Tune-up	ANT1	Tune-up	ANT2	
802.11a	100	5500	13.00	12.71	13.50	12.56	99%
	120	5600	13.00	12.39	13.50	13.08	99%
	144	5720	13.00	12.93	13.50	12.73	99%
802.11n HT20	100	5500	13.00	12.20	13.50	11.96	99%
	120	5600	13.00	12.76	13.50	12.54	99%
	144	5720	13.00	12.49	13.50	13.07	99%
802.11n HT40	102	5510	12.00	11.48	13.00	11.70	98%
	118	5590	12.00	11.87	13.00	12.11	98%
	142	5710	12.00	11.50	13.00	12.15	98%
802.11ac VHT20	100	5500	13.00	11.40	13.00	11.55	99%
	120	5600	13.00	11.97	13.00	12.13	99%
	144	5720	13.00	12.06	13.00	12.18	99%
802.11ac VHT40	102	5510	11.00	10.51	12.00	10.37	98%
	118	5590	11.00	10.89	12.00	10.77	98%
	142	5710	11.00	10.54	12.00	11.74	98%
802.11ac VHT80	106	5530	11.00	9.68	11.00	9.76	95%
	122	5610	11.00	10.14	11.00	10.23	95%
	138	5690	11.00	10.14	11.00	10.23	95%

NOTE: Power measurement results of WLAN 5.6G.

Mode	Channel	Frequency (MHz)	Average Output Power (dBm)				Duty Cycle %
			Tune-up	ANT1	Tune-up	ANT2	
802.11a	149	5745	14.00	12.80	13.00	12.78	99%
	157	5785	14.00	13.18	13.00	12.79	99%
	165	5825	14.00	12.70	13.00	12.74	99%
802.11n HT20	149	5745	13.00	12.19	13.00	12.22	99%
	157	5785	13.00	12.21	13.00	12.28	99%
	165	5825	13.00	12.59	13.00	12.68	99%
802.11n HT40	151	5755	12.00	11.79	12.00	11.72	98%
	159	5795	12.00	11.89	12.00	11.94	98%
802.11ac VHT20	149	5745	13.00	11.61	13.00	11.70	99%
	157	5785	13.00	11.67	13.00	11.73	99%
	165	5825	13.00	12.12	13.00	12.16	99%
802.11ac VHT40	151	5755	11.00	10.24	11.00	10.70	98%
	159	5795	11.00	10.34	11.00	10.74	98%
802.11ac VHT80	155	5775	10.00	9.86	10.00	9.72	95%

NOTE: Power measurement results of WLAN 5.8G.

BR+EDR	Peak Output Power (dBm)				
	Data Rates	Tune-up	Channel		
			0CH	39CH	78CH
	1DH5	5.100	4.694	5.014	3.491
	2DH5	1.000	0.446	0.812	-0.574
	3DH5	1.000	0.583	0.948	-0.517

BLE	Channel	Tune-up	Peak Output Power (dBm)
	0CH	3.100	2.945
	19CH	3.100	3.071
	39CH	3.100	1.891

NOTE: Power measurement results of Bluetooth. 1Mbps highest duty cycle is 77%.

8. Antenna Location

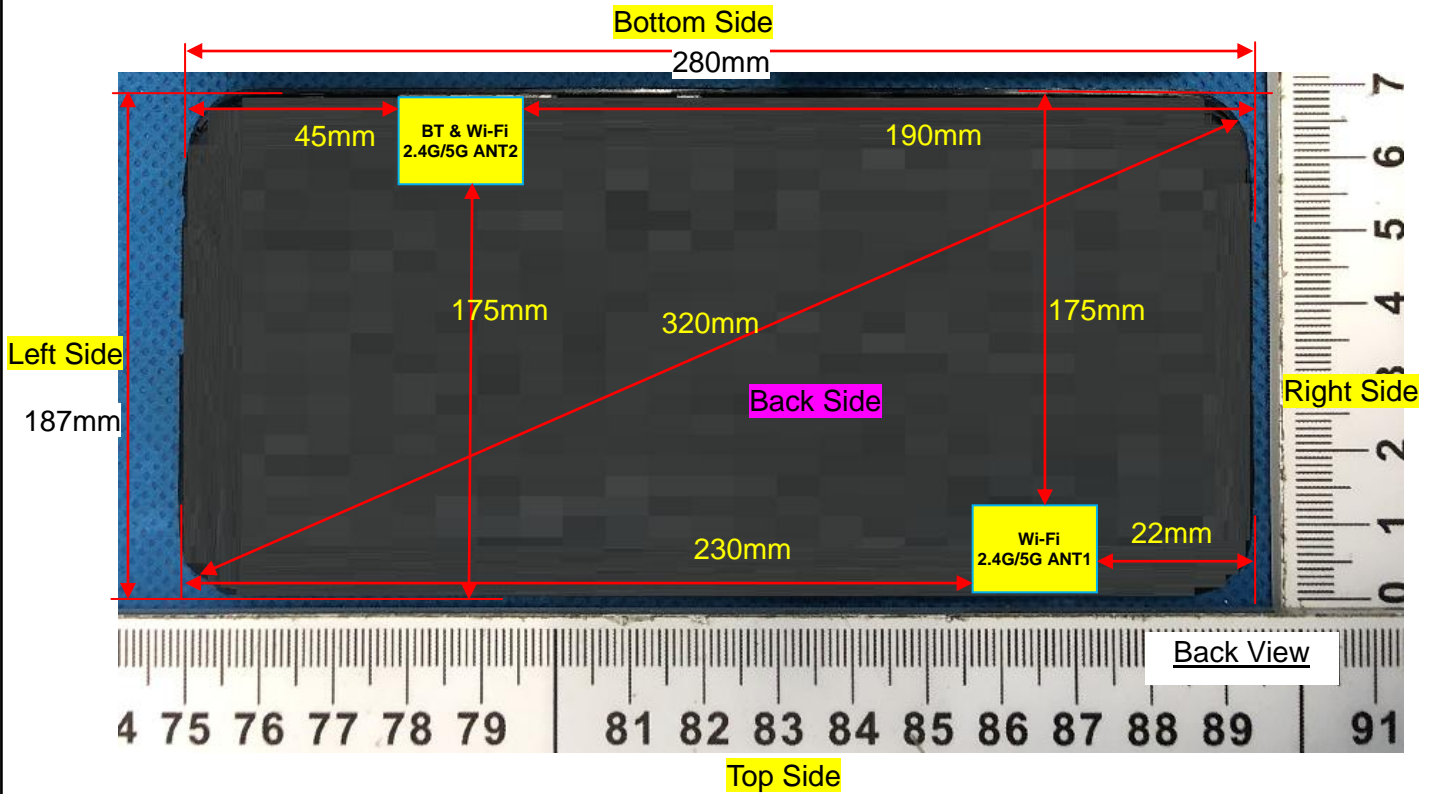

Note: Since the confidentiality request of EUT, the antenna location example diagram see as above.

Distance of the Antenna to the EUT surface/edge						
Antennas	Front Side	Back Side	Left Side	Right Side	Top Side	Bottom Side
WLAN 1	5	5	230	22	5	175
WLAN 2 & Bluetooth	5	5	45	190	175	5

Note: When the minimum separation distance is < 5 mm, a distance of 5 mm is applied to determine SAR test exclusion.

ANT1

Positions for SAR tests		
Test separation distances \leq 50 mm		
Exposure Positions	Tune-up Maximum power of WLAN 2.4G	
	14.5dBm	
Front Side	Antenna to user(mm)	5
	SAR exclusion threshold	8.8
	SAR testing required?	YES
Back Side	Antenna to user(mm)	5
	SAR exclusion threshold	8.8
	SAR testing required?	YES
Right Side	Antenna to user(mm)	22
	SAR exclusion threshold	2.0
	SAR testing required?	NO
Top Side	Antenna to user(mm)	5
	SAR exclusion threshold	8.8
	SAR testing required?	YES
Exposure Positions	Tune-up Maximum power of WLAN 5.2G	
	13.5dBm	
Front Side	Antenna to user(mm)	5
	SAR exclusion threshold	10.2
	SAR testing required?	YES
Back Side	Antenna to user(mm)	5
	SAR exclusion threshold	10.2
	SAR testing required?	YES
Right Side	Antenna to user(mm)	22
	SAR exclusion threshold	2.3
	SAR testing required?	NO
Top Side	Antenna to user(mm)	5
	SAR exclusion threshold	10.2
	SAR testing required?	YES
Exposure Positions	Tune-up Maximum power of WLAN 5.3G	
	13.5dBm	
Front Side	Antenna to user(mm)	5
	SAR exclusion threshold	10.3
	SAR testing required?	YES
Back Side	Antenna to user(mm)	5
	SAR exclusion threshold	10.3
	SAR testing required?	YES

Right Side	Antenna to user(mm)	22
	SAR exclusion threshold	2.3
	SAR testing required?	NO
Top Side	Antenna to user(mm)	5
	SAR exclusion threshold	10.3
	SAR testing required?	YES
Exposure Positions	Tune-up Maximum power of WLAN 5.6G	
	13dBm	
Front Side	Antenna to user(mm)	5
	SAR exclusion threshold	9.5
	SAR testing required?	YES
Back Side	Antenna to user(mm)	5
	SAR exclusion threshold	9.5
	SAR testing required?	YES
Right Side	Antenna to user(mm)	22
	SAR exclusion threshold	2.2
	SAR testing required?	NO
Top Side	Antenna to user(mm)	5
	SAR exclusion threshold	9.5
	SAR testing required?	YES
Exposure Positions	Tune-up Maximum power of WLAN 5.8G	
	14dBm	
Front Side	Antenna to user(mm)	5
	SAR exclusion threshold	12.1
	SAR testing required?	YES
Back Side	Antenna to user(mm)	5
	SAR exclusion threshold	12.1
	SAR testing required?	YES
Right Side	Antenna to user(mm)	22
	SAR exclusion threshold	2.8
	SAR testing required?	NO
Top Side	Antenna to user(mm)	5
	SAR exclusion threshold	12.1
	SAR testing required?	YES

NOTE: Refer to section 4.3.1 of KDB 447498 D01.

Positions for SAR tests		
Test separation distances > 50 mm		
Exposure Positions	Tune-up Maximum power of WLAN 2.4G	
	14.5dBm	28.18mW

Left Side	Antenna to user(mm)	230
	SAR exclusion threshold(mW)	1896
	SAR testing required?	NO
Bottom Side	Antenna to user(mm)	175
	SAR exclusion threshold(mW)	1346
	SAR testing required?	NO
Exposure Positions	Tune-up Maximum power of WLAN 5.2G	
	13.5dBm	22.39mW
Left Side	Antenna to user(mm)	230
	SAR exclusion threshold(mW)	1866
	SAR testing required?	NO
Bottom Side	Antenna to user(mm)	175
	SAR exclusion threshold(mW)	1316
	SAR testing required?	NO
Exposure Positions	Tune-up Maximum power of WLAN 5.3G	
	13.5dBm	22.39mW
Left Side	Antenna to user(mm)	230
	SAR exclusion threshold(mW)	1865
	SAR testing required?	NO
Bottom Side	Antenna to user(mm)	175
	SAR exclusion threshold(mW)	1315
	SAR testing required?	NO
Exposure Positions	Tune-up Maximum power of WLAN 5.6G	
	13dBm	19.95mW
Left Side	Antenna to user(mm)	230
	SAR exclusion threshold(mW)	1862
	SAR testing required?	NO
Bottom Side	Antenna to user(mm)	175
	SAR exclusion threshold(mW)	1312
	SAR testing required?	NO
Exposure Positions	Tune-up Maximum power of WLAN 5.8G	
	14dBm	25.12mW
Left Side	Antenna to user(mm)	230
	SAR exclusion threshold(mW)	1862
	SAR testing required?	NO
Bottom Side	Antenna to user(mm)	175
	SAR exclusion threshold(mW)	1312
	SAR testing required?	NO

NOTE: Refer to section 4.3.1 of KDB 447498 D01.

ANT2

Positions for SAR tests		
Test separation distances \leq 50 mm		
Exposure Positions	Tune-up Maximum power of WLAN 2.4G	
	14.5dBm	
Front Side	Antenna to user(mm)	5
	SAR exclusion threshold	8.8
	SAR testing required?	YES
Back Side	Antenna to user(mm)	5
	SAR exclusion threshold	8.8
	SAR testing required?	YES
Left Side	Antenna to user(mm)	45
	SAR exclusion threshold	1.0
	SAR testing required?	NO
Bottom Side	Antenna to user(mm)	5
	SAR exclusion threshold	8.8
	SAR testing required?	YES
Exposure Positions	Tune-up Maximum power of WLAN 5.2G	
	13dBm	
Front Side	Antenna to user(mm)	5
	SAR exclusion threshold	9.1
	SAR testing required?	YES
Back Side	Antenna to user(mm)	5
	SAR exclusion threshold	9.1
	SAR testing required?	YES
Left Side	Antenna to user(mm)	45
	SAR exclusion threshold	1.0
	SAR testing required?	NO
Bottom Side	Antenna to user(mm)	5
	SAR exclusion threshold	9.1
	SAR testing required?	YES
Exposure Positions	Tune-up Maximum power of WLAN 5.3G	
	13.5dBm	
Front Side	Antenna to user(mm)	5
	SAR exclusion threshold	10.3
	SAR testing required?	YES
Back Side	Antenna to user(mm)	5
	SAR exclusion threshold	10.3
	SAR testing required?	YES
Left Side	Antenna to user(mm)	45

	SAR exclusion threshold	1.1
	SAR testing required?	NO
Bottom Side	Antenna to user(mm)	5
	SAR exclusion threshold	10.3
	SAR testing required?	YES
Exposure Positions	Tune-up Maximum power of WLAN 5.6G	
	13.5dBm	
Front Side	Antenna to user(mm)	5
	SAR exclusion threshold	10.7
	SAR testing required?	YES
Back Side	Antenna to user(mm)	5
	SAR exclusion threshold	10.7
	SAR testing required?	YES
Left Side	Antenna to user(mm)	45
	SAR exclusion threshold	1.2
	SAR testing required?	NO
Bottom Side	Antenna to user(mm)	5
	SAR exclusion threshold	10.7
	SAR testing required?	YES
Exposure Positions	Tune-up Maximum power of WLAN 5.8G	
	13dBm	
Front Side	Antenna to user(mm)	5
	SAR exclusion threshold	9.6
	SAR testing required?	YES
Back Side	Antenna to user(mm)	5
	SAR exclusion threshold	9.6
	SAR testing required?	YES
Left Side	Antenna to user(mm)	45
	SAR exclusion threshold	1.1
	SAR testing required?	NO
Bottom Side	Antenna to user(mm)	5
	SAR exclusion threshold	9.6
	SAR testing required?	YES

NOTE: Refer to section 4.3.1 of KDB 447498 D01.

Positions for SAR tests		
Test separation distances > 50 mm		
Exposure Positions	Tune-up Maximum power of WLAN 2.4G	
	14.5dBm	28.2mW
Right Side	Antenna to user(mm)	190

	SAR exclusion threshold(mW)	1496
	SAR testing required?	NO
Top Side	Antenna to user(mm)	175
	SAR exclusion threshold(mW)	1346
	SAR testing required?	NO
Exposure Positions	Tune-up Maximum power of WLAN 5.2G	
	13dBm	19.95mW
Right Side	Antenna to user(mm)	190
	SAR exclusion threshold(mW)	1466
	SAR testing required?	NO
Top Side	Antenna to user(mm)	175
	SAR exclusion threshold(mW)	1316
	SAR testing required?	NO
Exposure Positions	Tune-up Maximum power of WLAN 5.3G	
	13.5dBm	22.39mW
Right Side	Antenna to user(mm)	190
	SAR exclusion threshold(mW)	1465
	SAR testing required?	NO
Top Side	Antenna to user(mm)	175
	SAR exclusion threshold(mW)	1315
	SAR testing required?	NO
Exposure Positions	Tune-up Maximum power of WLAN 5.6G	
	13.5dBm	22.39mW
Right Side	Antenna to user(mm)	190
	SAR exclusion threshold(mW)	1462
	SAR testing required?	NO
Top Side	Antenna to user(mm)	175
	SAR exclusion threshold(mW)	1312
	SAR testing required?	NO
Exposure Positions	Tune-up Maximum power of WLAN 5.8G	
	13dBm	19.95mW
Right Side	Antenna to user(mm)	190
	SAR exclusion threshold(mW)	1462
	SAR testing required?	NO
Top Side	Antenna to user(mm)	175
	SAR exclusion threshold(mW)	1312
	SAR testing required?	NO

NOTE: Refer to section 4.3.1 of KDB 447498 D01.

9. Stand-alone SAR test exclusion

Refer to FCC KDB 447498D01, the 1-g SAR and 10-g SAR test exclusion thresholds for 100 MHz to 6 GHz at test separation distances ≤ 50 mm are determined by:

$$\left[\frac{\text{max. power of channel, including tune-up tolerance, mW}}{\text{min. test separation distance, mm}} \right] \cdot \left[\sqrt{f_{\text{(GHz)}}} \right] \leq 3.0$$
 for 1-g SAR and ≤ 7.5 for 10-g extremity SAR, where:

- $f_{\text{(GHz)}}$ is the RF channel transmit frequency in GHz
- Power and distance are rounded to the nearest mW and mm before calculation
- The result is rounded to one decimal place for comparison

When the minimum test separation distance is < 5 mm, a distance of 5 mm is applied to determine SAR test exclusion.

Mode	P_{max} (dBm)	P_{max} (mW)	Distance (mm)	f (GHz)	Calculation Result	SAR Exclusion threshold	SAR test exclusion
Bluetooth	5.10	3.24	5	2.480	1.02	3.00	Yes

NOTE: Standalone SAR test exclusion for Bluetooth

10. SAR Results

10.1. SAR measurement Result

10.1.1. SAR measurement Result of WLAN 2.4G

Test Position of Body with 0mm	Test channel /Freq.	Test Mode	SAR Value (W/kg)		Power Drift ($\pm 5\%$)	Conducted power (dBm)	Tune-up power (dBm)	Duty Cycle %	Scaled SAR 1g (W/Kg)	Date
			1g	10g						
ANT1										
Front Side	6/2437	802.11 b	0.106	0.060	-0.80	14.36	14.50	99%	0.111	2020/12/23
Back Side	6/2437	802.11 b	0.220	0.109	-0.98	14.36	14.50	99%	0.230	2020/12/23
Top Side	6/2437	802.11 b	0.100	0.058	1.23	14.36	14.50	99%	0.104	2020/12/23
ANT2										
Front Side	6/2437	802.11 b	0.330	0.165	-2.25	14.01	14.50	99%	0.373	2020/12/23
Back Side	6/2437	802.11 b	1.181	0.509	-0.22	14.01	14.50	99%	1.335	2020/12/23
Bottom Side	6/2437	802.11 b	0.596	0.353	0.61	14.01	14.50	99%	0.674	2020/12/23
Back Side	1/2412	802.11 b	0.940	0.415	0.25	14.33	14.50	99%	0.987	2020/12/23

Back Side	11/2462	802.11 b	1.323	0.551	2.47	14.48	14.50	99%	1.343	2020/12/23
Back Side Repeated	11/2462	802.11 b	1.315	0.548	0.32	14.48	14.50	99%	1.334	2020/12/23

NOTE: Body SAR test results of WLAN 2.4G

10.1.2. SAR measurement Result of WLAN 5.2G

Test Position of Body with 0mm	Test channel /Freq.	Test Mode	SAR Value (W/kg)		Power Drift (±5%)	Conducted power (dBm)	Tune-up power (dBm)	Duty Cycle %	Scaled SAR 1g (W/Kg)	Date
			1g	10g						
ANT1										
Front Side	40/5200	802.11a	0.626	0.234	-2.10	13.02	13.50	99%	0.706	2020/12/24
Back Side	40/5200	802.11a	1.165	0.369	-0.32	13.02	13.50	99%	1.314	2020/12/24
Back Side Repeated	40/5200	802.11a	1.158	0.364	0.28	13.02	13.50	99%	1.306	2020/12/24
Top Side	40/5200	802.11a	0.553	0.218	1.24	13.02	13.50	99%	0.624	2020/12/24
Back Side	36/5180	802.11a	1.100	0.376	-4.88	12.68	13.50	99%	1.342	2020/12/24
Back Side	48/5240	802.11a	0.955	0.306	-3.14	13.36	13.50	99%	0.996	2020/12/24
ANT2										
Front Side	40/5200	802.11a	0.789	0.255	2.76	12.99	13.00	99%	0.799	2020/12/24
Back Side	40/5200	802.11a	1.303	0.404	-1.12	12.99	13.00	99%	1.319	2020/12/24
Back Side Repeated	40/5200	802.11a	1.297	0.400	0.13	12.99	13.00	99%	1.313	2020/12/24
Bottom Side	40/5200	802.11a	0.652	0.246	1.34	12.99	13.00	99%	0.660	2020/12/24
Back Side	36/5180	802.11a	0.923	0.302	3.65	12.86	13.00	99%	0.963	2020/12/24
Back Side	48/5240	802.11a	1.198	0.385	-3.92	12.63	13.00	99%	1.318	2020/12/24

NOTE: Body SAR test results of WLAN 5.2G

10.1.3. SAR measurement Result of WLAN 5.3G

Test Position of Body with 0mm	Test channel /Freq.	Test Mode	SAR Value (W/kg)		Power Drift (±5%)	Conducted power (dBm)	Tune-up power (dBm)	Duty Cycle %	Scaled SAR 1g (W/Kg)	Date
			1g	10g						
ANT1										
Front Side	56/5280	802.11a	0.474	0.167	-0.49	13.20	13.50	99%	0.513	2020/12/17
Back Side	56/5280	802.11a	0.765	0.281	-3.06	13.20	13.50	99%	0.828	2020/12/17
Top Side	56/5280	802.11a	0.451	0.159	0.22	13.20	13.50	99%	0.488	2020/12/17

Back Side	52/5260	802.11a	0.643	0.224	-2.23	13.06	13.50	99%	0.719	2020/12/17
Back Side	64/5320	802.11a	0.650	0.232	1.39	13.43	13.50	99%	0.667	2020/12/17
ANT2										
Front Side	56/5280	802.11a	0.633	0.227	-3.46	13.18	13.50	99%	0.688	2020/12/17
Back Side	56/5280	802.11a	1.183	0.382	-1.10	13.18	13.50	99%	1.286	2020/12/17
Back Side Repeated	56/5280	802.11a	1.177	0.378	-1.10	13.18	13.50	99%	1.280	2020/12/17
Bottom Side	56/5280	802.11a	0.598	0.219	-2.32	13.18	13.50	99%	0.650	2020/12/17
Back Side	52/5260	802.11a	1.029	0.354	-1.51	13.01	13.50	99%	1.164	2020/12/17
Back Side	64/5320	802.11a	0.953	0.320	-2.42	13.36	13.50	99%	0.994	2020/12/17

NOTE: Body SAR test results of WLAN 5.3G

10.1.4. SAR measurement Result of WLAN 5.6G

Test Position of Body with 0mm	Test channel /Freq.	Test Mode	SAR Value (W/kg)		Power Drift (±5%)	Conducted power (dBm)	Tune-up power (dBm)	Duty Cycle %	Scaled SAR 1g (W/Kg)	Date
			1g	10g						
ANT1										
Front Side	120/5600	802.11a	0.681	0.208	2.27	12.39	13.00	99%	0.792	2020/12/18
Back Side	120/5600	802.11a	0.849	0.296	-2.91	12.39	13.00	99%	0.987	2020/12/18
Top Side	120/5600	802.11a	0.637	0.187	1.71	12.39	13.00	99%	0.740	2020/12/18
Back Side	100/5500	802.11a	0.800	0.268	-3.76	12.71	13.00	99%	0.864	2020/12/18
Back Side	144/5720	802.11a	1.099	0.339	-0.46	12.93	13.00	99%	1.128	2020/12/24
Back Side Repeated	144/5720	802.11a	1.092	0.335	1.23	12.93	13.00	99%	1.121	2020/12/24
ANT2										
Front Side	120/5600	802.11a	0.629	0.225	3.74	13.08	13.50	99%	0.700	2020/12/18
Back Side	120/5600	802.11a	1.158	0.365	-0.31	13.08	13.50	99%	1.288	2020/12/18
Bottom Side	120/5600	802.11a	0.602	0.205	-0.88	13.08	13.50	99%	0.670	2020/12/18
Back Side	100/5500	802.11a	0.800	0.268	-2.90	12.56	13.50	99%	1.003	2020/12/18

Back Side	144/5720	802.11a	1.189	0.365	0.21	12.73	13.50	99%	1.434	2020/12/24
Back Side Repeated	144/5720	802.11a	1.180	0.360	0.33	12.73	13.50	99%	1.423	2020/12/24

NOTE: Body SAR test results of WLAN 5.6G

10.1.5. SAR measurement Result of WLAN 5.8G

Test Position of Body with 0mm	Test channel /Freq.	Test Mode	SAR Value (W/kg)		Power Drift (±5%)	Conducted power (dBm)	Tune-up power (dBm)	Duty Cycle %	Scaled SAR 1g (W/Kg)	Date
			1g	10g						
ANT1										
Front Side	157/5785	802.11a	0.490	0.152	3.28	13.18	14.00	99%	0.598	2020/12/24
Back Side	157/5785	802.11a	0.777	0.251	-4.65	13.18	14.00	99%	0.948	2020/12/24
Top Side	157/5785	802.11a	0.451	0.146	2.50	13.18	14.00	99%	0.550	2020/12/24
Back Side	149/5745	802.11a	0.645	0.198	3.87	12.80	14.00	99%	0.859	2020/12/24
Back Side	165/5825	802.11a	0.692	0.217	-1.00	12.70	14.00	99%	0.943	2020/12/24
ANT2										
Front Side	157/5785	802.11a	0.657	0.193	-3.23	12.79	13.00	99%	0.697	2020/12/24
Back Side	157/5785	802.11a	1.010	0.309	-1.63	12.79	13.00	99%	1.071	2020/12/24
Back Side Repeated	157/5785	802.11a	1.004	0.300	-1.63	12.79	13.00	99%	1.064	2020/12/24
Bottom Side	157/5785	802.11a	0.616	0.188	2.94	12.79	13.00	99%	0.653	2020/12/24
Back Side	149/5745	802.11a	1.007	0.311	0.79	12.78	13.00	99%	1.070	2020/12/24
Back Side	165/5825	802.11a	0.804	0.250	-2.95	12.74	13.00	99%	0.862	2020/12/24

NOTE: Body SAR test results of WLAN 5.8G

10.2. Simultaneous Transmission Analysis

NO.	Simultaneous Transmission Configurations	Position
		Body
1	2.4G Wi-Fi ant 1 + 2.4G Wi-Fi ant 2	NO
2	5G Wi-Fi ant 1 + 5G Wi-Fi ant 2	NO
3	2.4G Wi-Fi + 5G Wi-Fi	NO
4	2.4G Wi-Fi + 5G Wi-Fi + Bluetooth	NO
5	2.4G Wi-Fi + Bluetooth	NO
6	5G Wi-Fi + Bluetooth	NO

11. Appendix A. Photo documentation

Refer to appendix Test Setup photo---SAR

12. Appendix B. System Check Plots

Table of contents
MEASUREMENT 1 System Performance Check - SID2450 - Body
MEASUREMENT 2 System Performance Check - SID5200 - Body
MEASUREMENT 3 System Performance Check - SID5400 - Body
MEASUREMENT 4 System Performance Check - SID5600 - Body
MEASUREMENT 5 System Performance Check - SID5800 - Body

MEASUREMENT 1

Date of measurement: 23/12/2020

A. Experimental conditions.

Area Scan	<u>dx=12mm dy=12mm, h= 5.00 mm</u>
ZoomScan	<u>7x7x7,dx=5mm dy=5mm dz=5mm</u>
Phantom	<u>Validation plane</u>
Device Position	<u>Dipole</u>
Band	<u>CW2450</u>
Channels	<u>Middle</u>
Signal	<u>CW (Crest factor: 1.0)</u>

B. SAR Measurement Results

Frequency (MHz)	2450.000000
Relative permittivity (real part)	52.301697
Relative permittivity (imaginary part)	14.233566
Conductivity (S/m)	1.942816
Variation (%)	0.420000

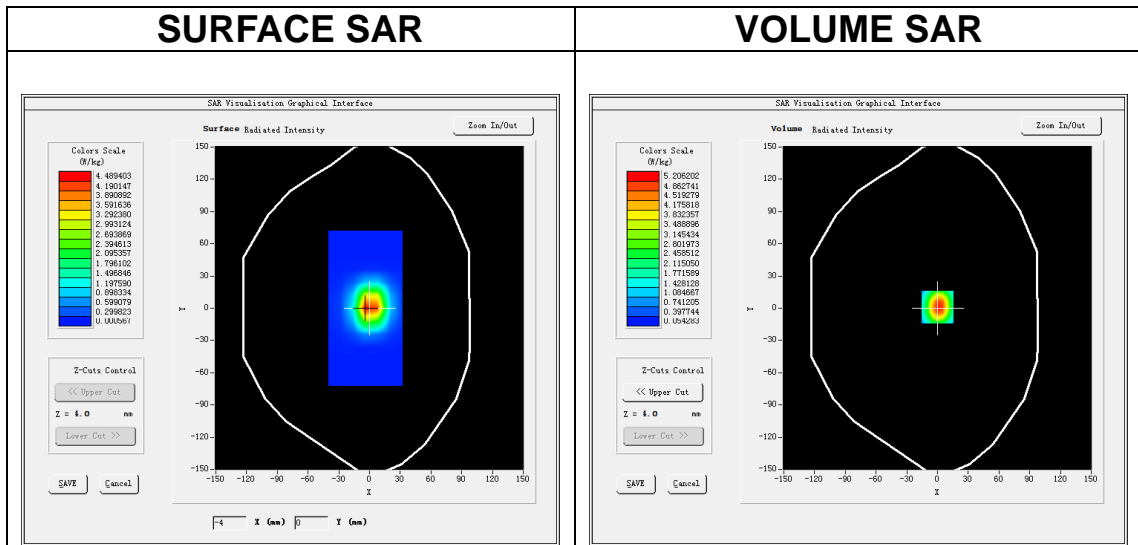

Maximum location: X=0.00, Y=1.00

SAR Peak: 8.46 W/kg

SAR 10g (W/Kg)	2.427285
SAR 1g (W/Kg)	5.517270

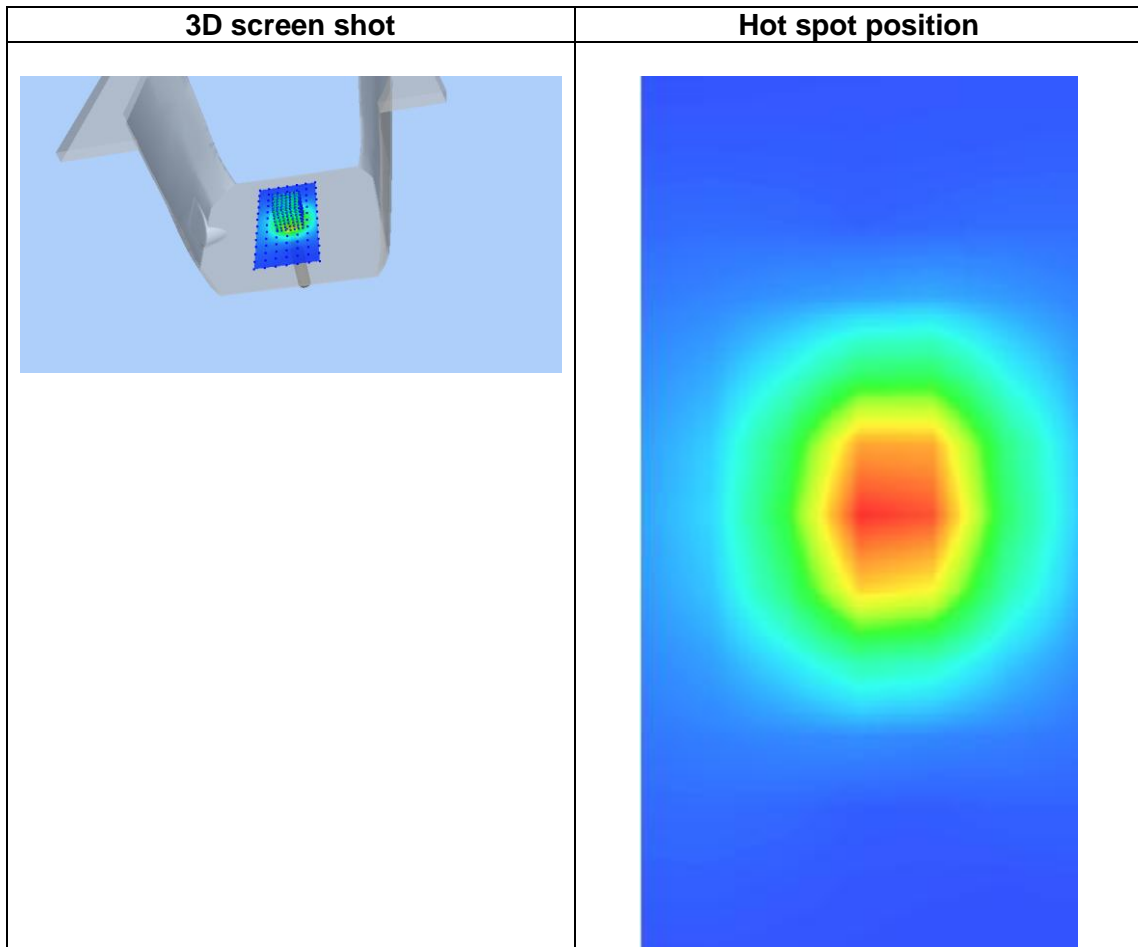
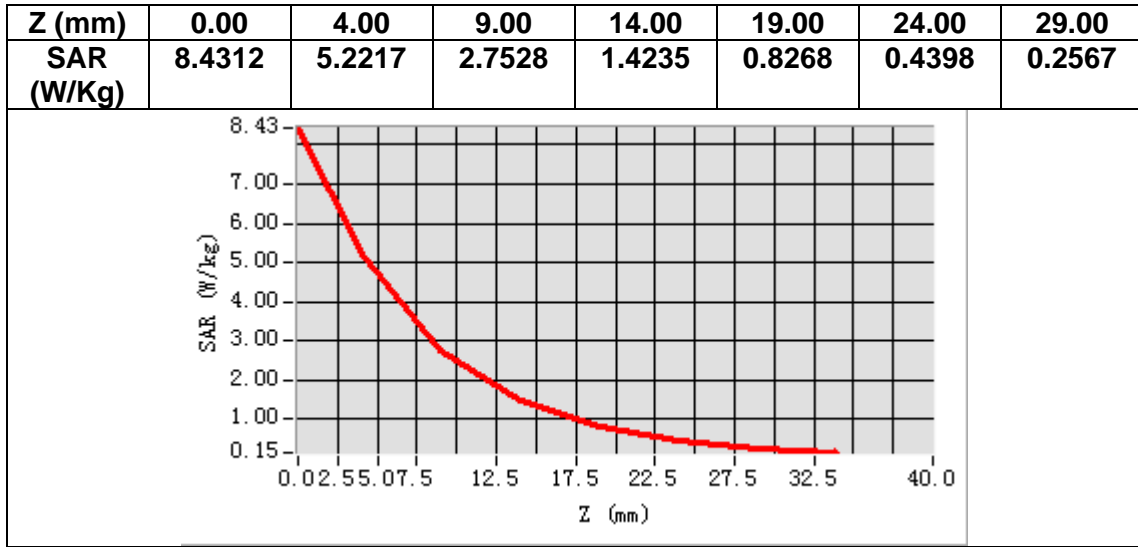

MEASUREMENT 2

Date of measurement: 24/12/2020

A. Experimental conditions.

Area Scan	<u>dx=10mm dy=10mm, h= 2.00 mm</u>
ZoomScan	<u>7x7x12,dx=4mm dy=4mm dz=2mm</u>
Phantom	<u>Validation plane</u>
Device Position	<u>Dipole</u>
Band	<u>CW5200</u>
Channels	<u>Middle</u>
Signal	<u>CW (Crest factor: 1.0)</u>

B. SAR Measurement Results

Frequency (MHz)	5200.000000
Relative permittivity (real part)	50.262845
Relative permittivity (imaginary part)	18.481441
Conductivity (S/m)	5.343842
Variation (%)	4.490000

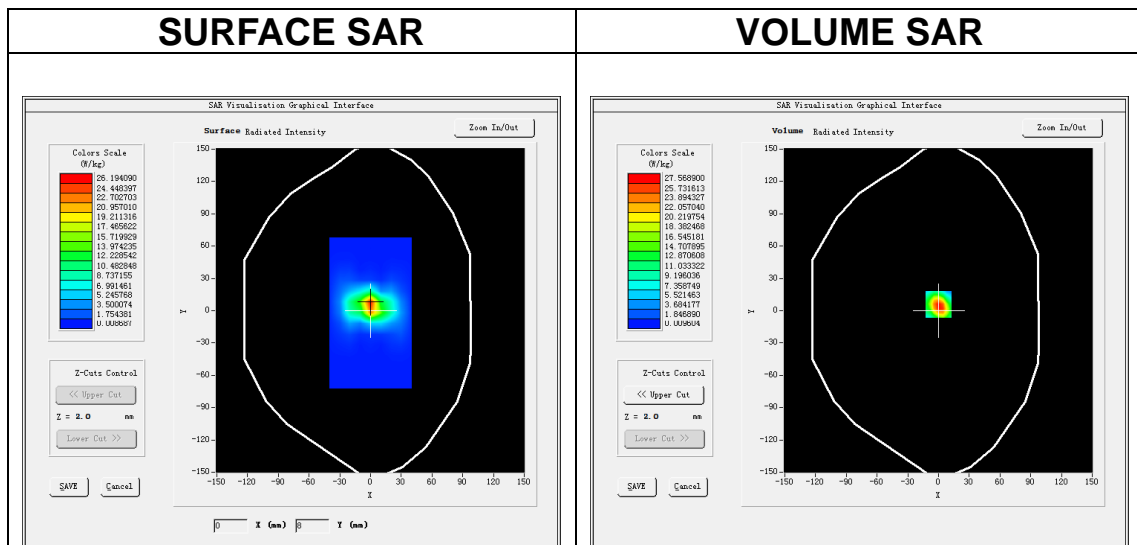

Maximum location: X=0.00, Y=6.00

SAR Peak: 49.61 W/kg

SAR 10g (W/Kg)	5.659184
SAR 1g (W/Kg)	15.598246

Z (m m)	0.00	2.00	4.00	6.00	8.00	10.0	12.0	14.0	16.0	18.0	20.0	22.0
SA R (W/ Kg)	46.6 150	27.5 644	14.0 668	7.05 91	3.59 28	1.78 02	0.89 38	0.46 70	0.24 75	0.13 53	0.06 50	0.04 000

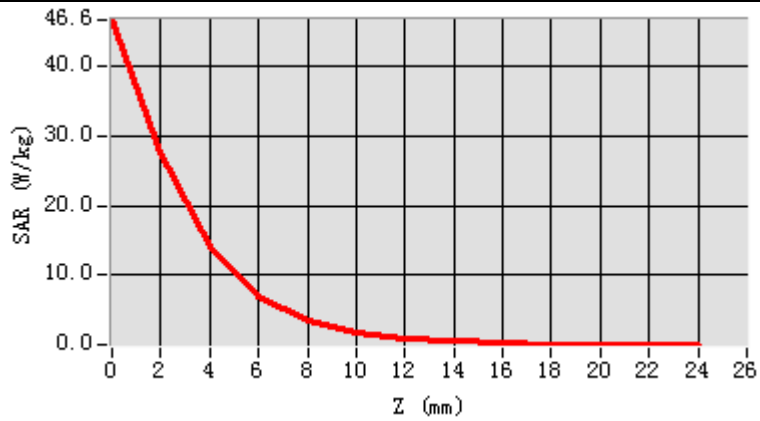

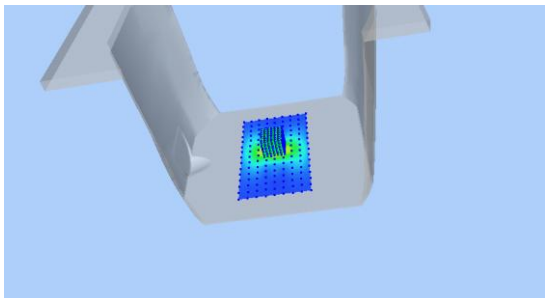
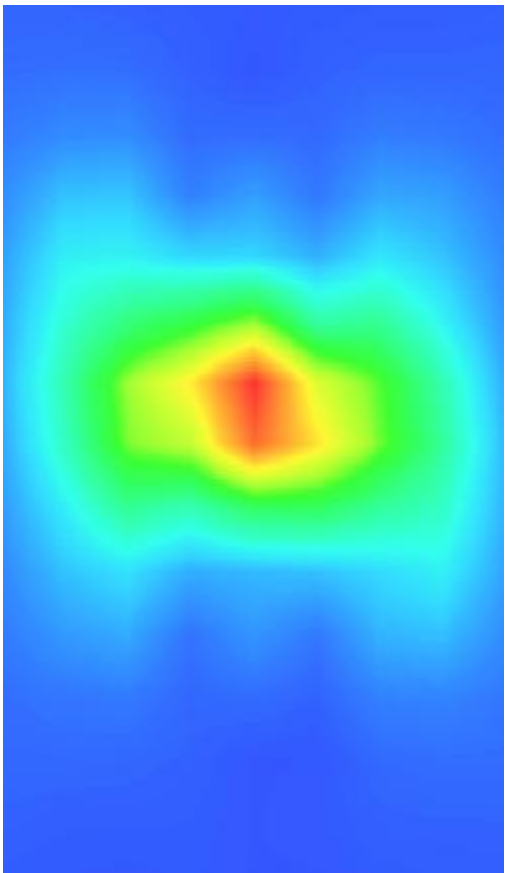
3D screen shot	Hot spot position
	

MEASUREMENT 3

Date of measurement: 17/12/2020

A. Experimental conditions.

Area Scan	<u>dx=10mm dy=10mm, h= 2.00 mm</u>
ZoomScan	<u>7x7x12,dx=4mm dy=4mm dz=2mm</u>
Phantom	<u>Validation plane</u>
Device Position	<u>Dipole</u>
Band	<u>CW5400</u>
Channels	<u>Middle</u>
Signal	<u>CW (Crest factor: 1.0)</u>

B. SAR Measurement Results

Frequency (MHz)	5400.000000
Relative permittivity (real part)	48.854200
Relative permittivity (imaginary part)	18.914024
Conductivity (S/m)	5.671084
Variation (%)	-1.550000

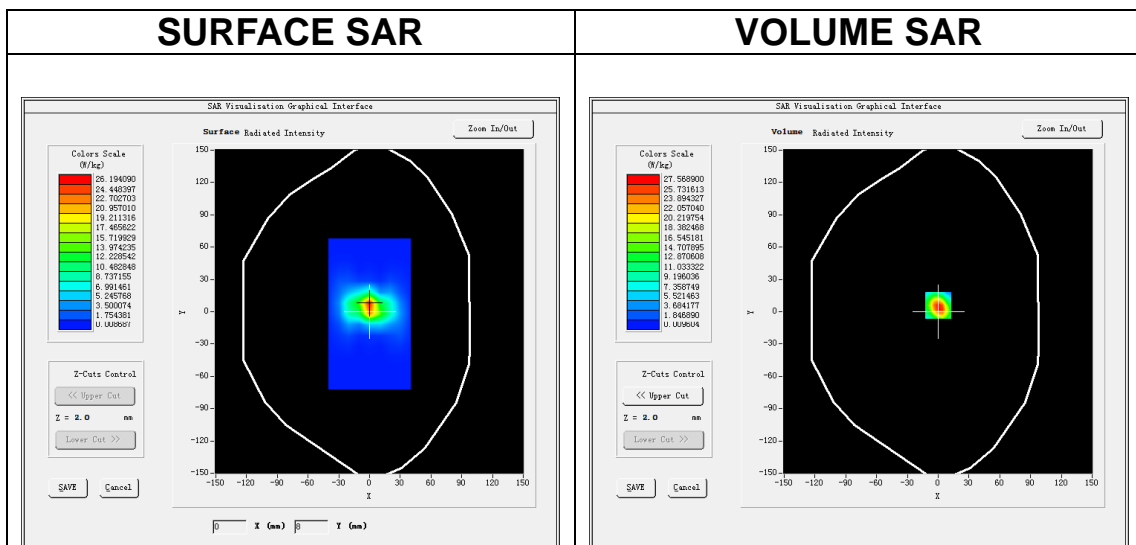

Maximum location: X=0.00, Y=6.00

SAR Peak: 49.61 W/kg

SAR 10g (W/Kg)	6.118324
SAR 1g (W/Kg)	16.984202

Z (m)	0.00	2.00	4.00	6.00	8.00	10.00	12.00	14.00	16.00	18.00	20.00	22.00
SAR (W/Kg)	46.6123	27.5690	14.0601	7.0580	3.5942	1.7862	0.8983	0.4605	0.2435	0.1382	0.0620	0.0471

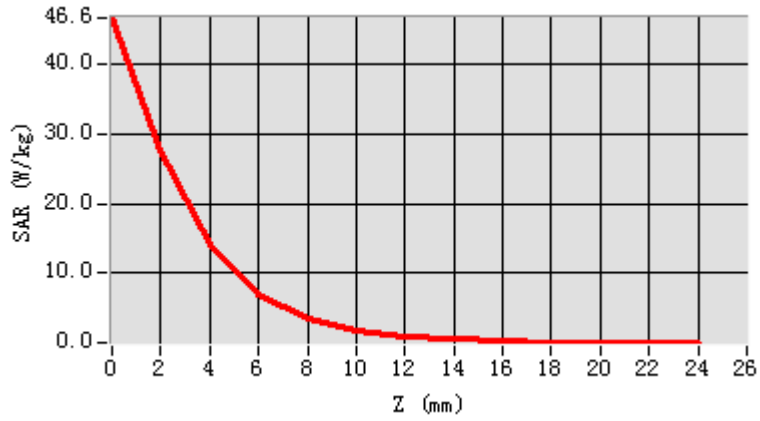

3D screen shot

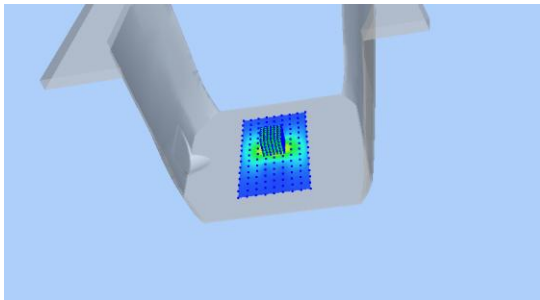

Hot spot position

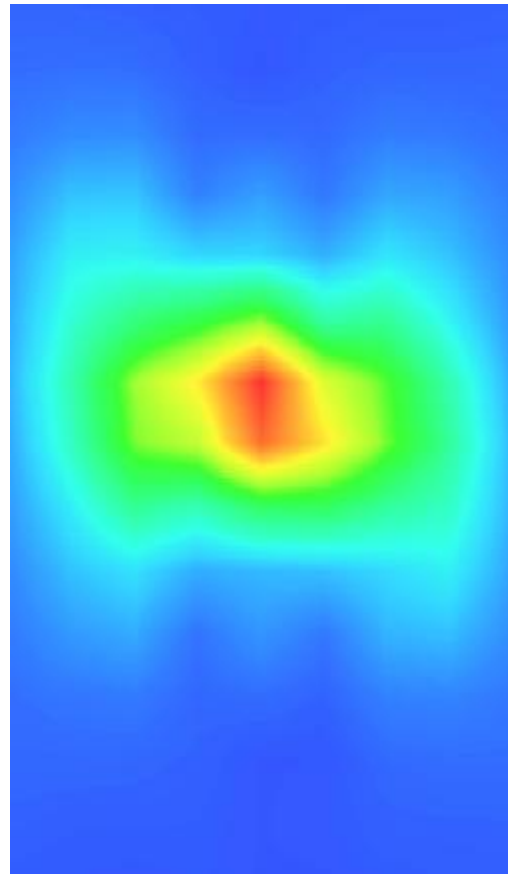

MEASUREMENT 4

Date of measurement: 18/12/2020

A. Experimental conditions.

Area Scan	<u>dx=10mm dy=10mm, h= 2.00 mm</u>
ZoomScan	<u>7x7x12,dx=4mm dy=4mm dz=2mm</u>
Phantom	<u>Validation plane</u>
Device Position	<u>Dipole</u>
Band	<u>CW5600</u>
Channels	<u>Middle</u>
Signal	<u>CW (Crest factor: 1.0)</u>

B. SAR Measurement Results

Frequency (MHz)	5600.000000
Relative permittivity (real part)	49.920330
Relative permittivity (imaginary part)	18.451725
Conductivity (S/m)	5.744255
Variation (%)	-3.120000

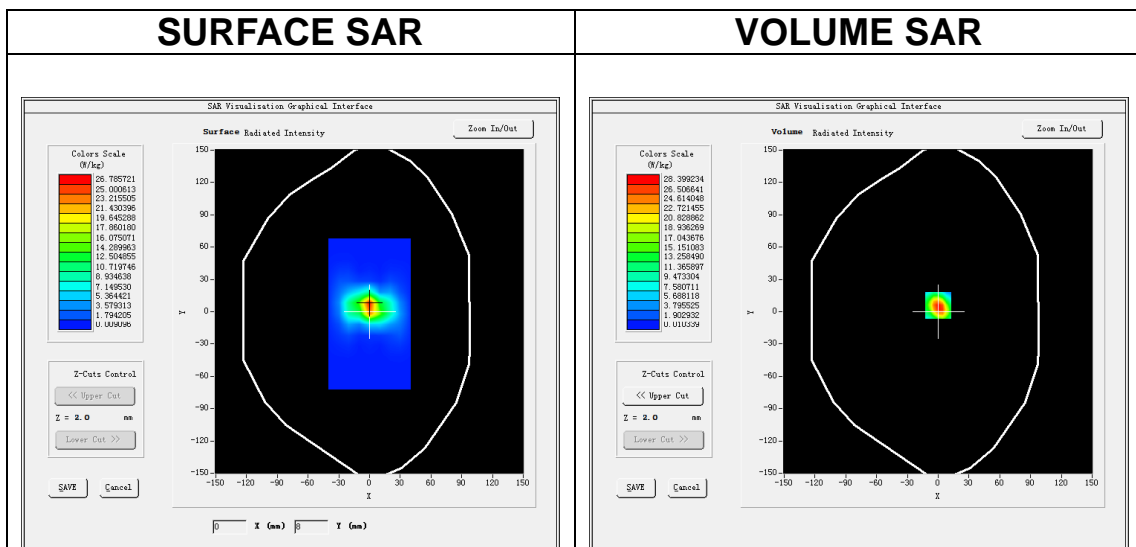

Maximum location: X=0.00, Y=6.00

SAR Peak: 50.97 W/kg

SAR 10g (W/Kg)	6.085019
SAR 1g (W/Kg)	17.994075

Z (m m)	0.00	2.00	4.00	6.00	8.00	10.00	12.00	14.00	16.00	18.00	20.00	22.00
SAR (W/Kg)	48.0319	28.3990	14.4532	7.2935	3.6497	1.8204	0.9245	0.4666	0.2496	0.1343	0.0729	0.0494

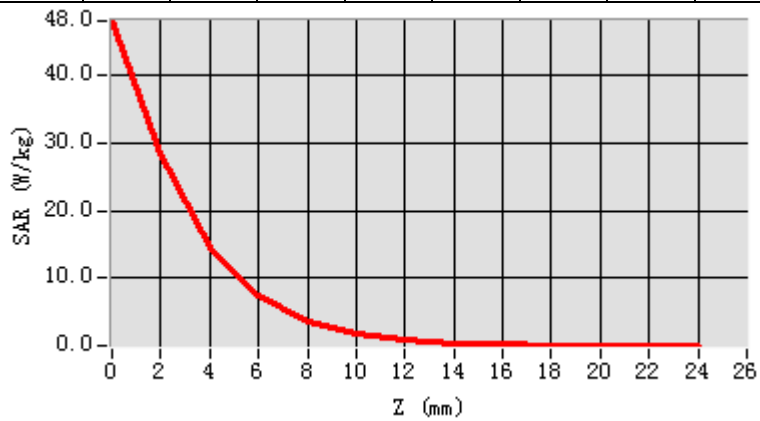

3D screen shot

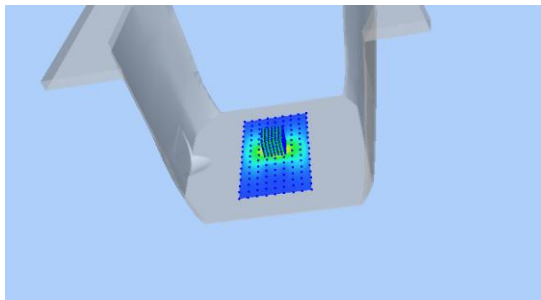

Hot spot position

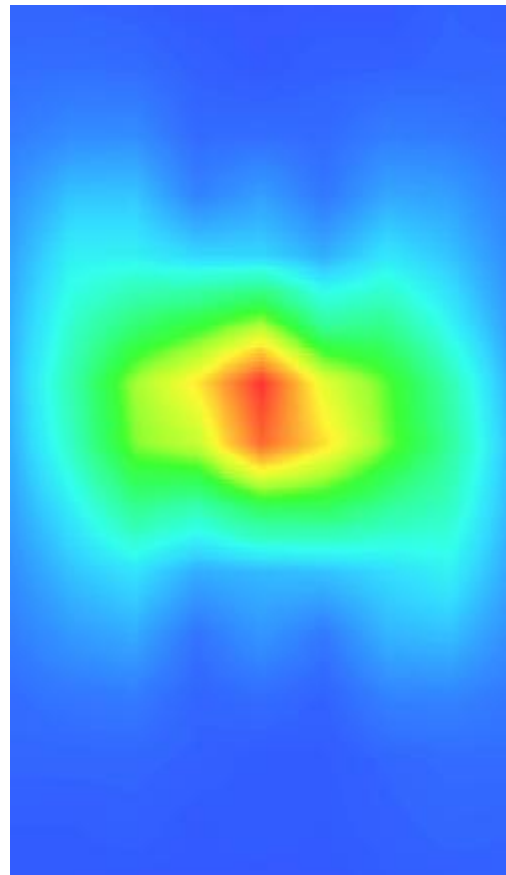

MEASUREMENT 5

Date of measurement: 24/12/2020

A. Experimental conditions.

Area Scan	<u>dx=10mm dy=10mm, h= 2.00 mm</u>
ZoomScan	<u>7x7x12,dx=4mm dy=4mm dz=2mm</u>
Phantom	<u>Validation plane</u>
Device Position	<u>Dipole</u>
Band	<u>CW5800</u>
Channels	<u>Middle</u>
Signal	<u>CW (Crest factor: 1.0)</u>

B. SAR Measurement Results

Frequency (MHz)	5800.000000
Relative permittivity (real part)	48.710523
Relative permittivity (imaginary part)	18.780043
Conductivity (S/m)	6.045240
Variation (%)	1.340000

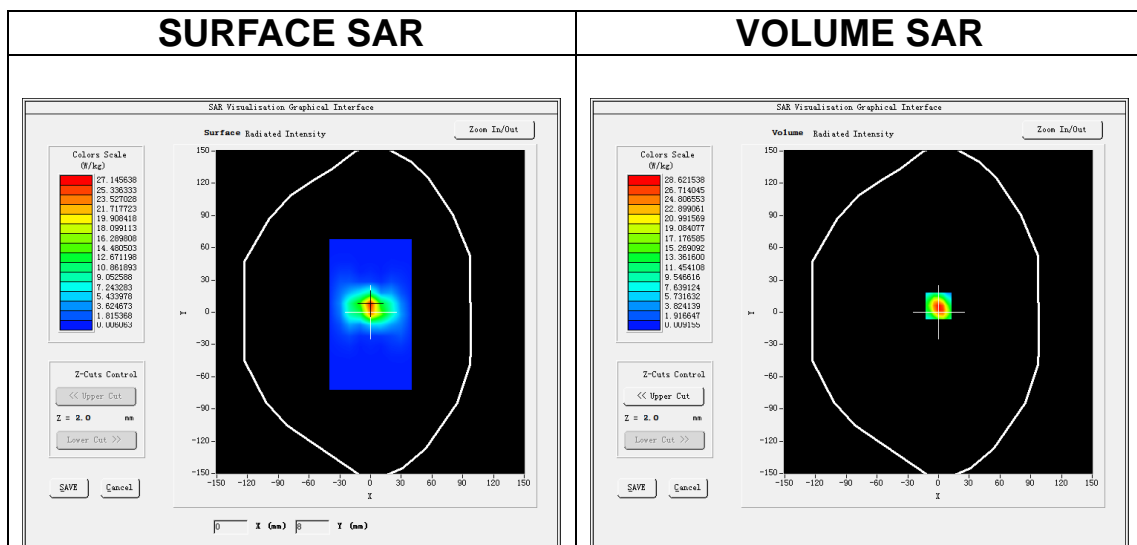

Maximum location: X=0.00, Y=6.00

SAR Peak: 51.30 W/kg

SAR 10g (W/Kg)	5.743184
SAR 1g (W/Kg)	16.886052

Z (m)	0.00	2.00	4.00	6.00	8.00	10.00	12.00	14.00	16.00	18.00	20.00	22.00
SAR (W/Kg)	48.3472	28.6209	14.6589	7.4039	3.6857	1.8335	0.9318	0.4760	0.2513	0.1308	0.0783	0.0522

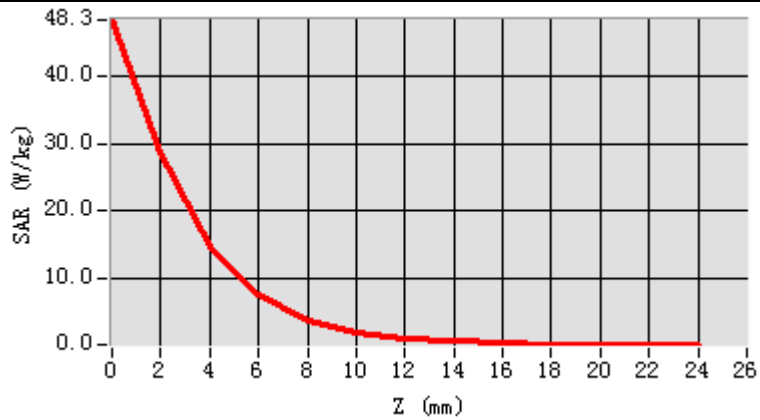

3D screen shot

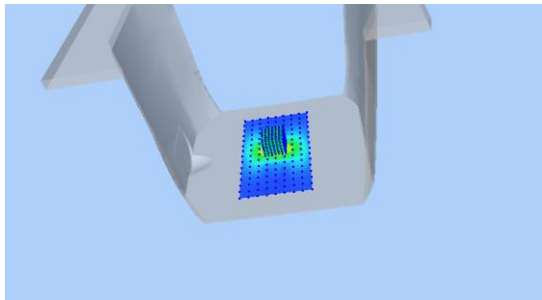

Hot spot position

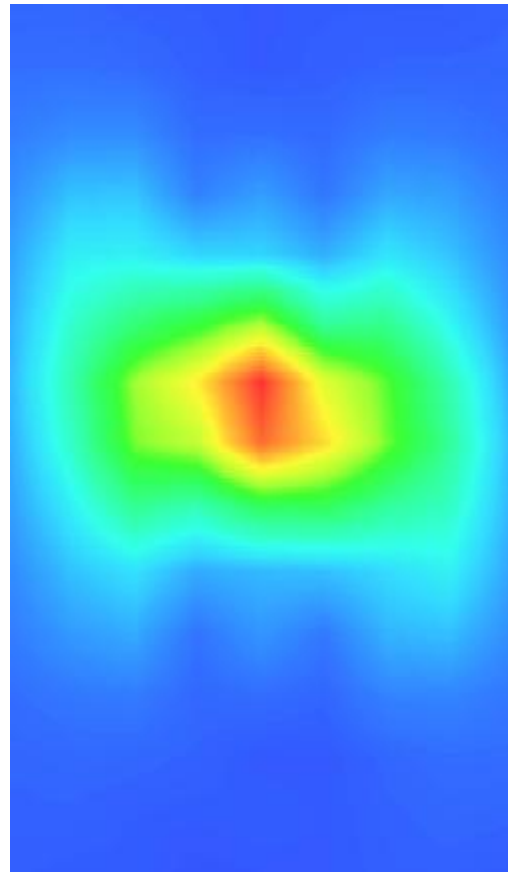

13. Appendix C. Plots of High SAR Measurement

Table of contents
MEASUREMENT 1 WLAN 5.2G Body
MEASUREMENT 2 WLAN 5.8G Body
MEASUREMENT 3 WLAN 5.3G Body
MEASUREMENT 4 WLAN 5.6G Body
MEASUREMENT 5 WLAN 2.4G Body

MEASUREMENT 1

Date of measurement: 24/12/2020

A. Experimental conditions.

Area Scan	<u>dx=10mm dy=10mm, h= 2.00 mm</u>
ZoomScan	<u>7x7x12,dx=4mm dy=4mm dz=2mm</u>
Phantom	<u>Validation plane</u>
Device Position	<u>Body</u>
Band	<u>IEEE 802.11a U-NII</u>
Channels	<u>Middle</u>
Signal	<u>IEEE802.11a (Crest factor: 1.0)</u>

B. SAR Measurement Results

Frequency (MHz)	5200.000000
Relative permittivity (real part)	50.256229
Relative permittivity (imaginary part)	18.477774
Conductivity (S/m)	5.338023
Variation (%)	-1.120000

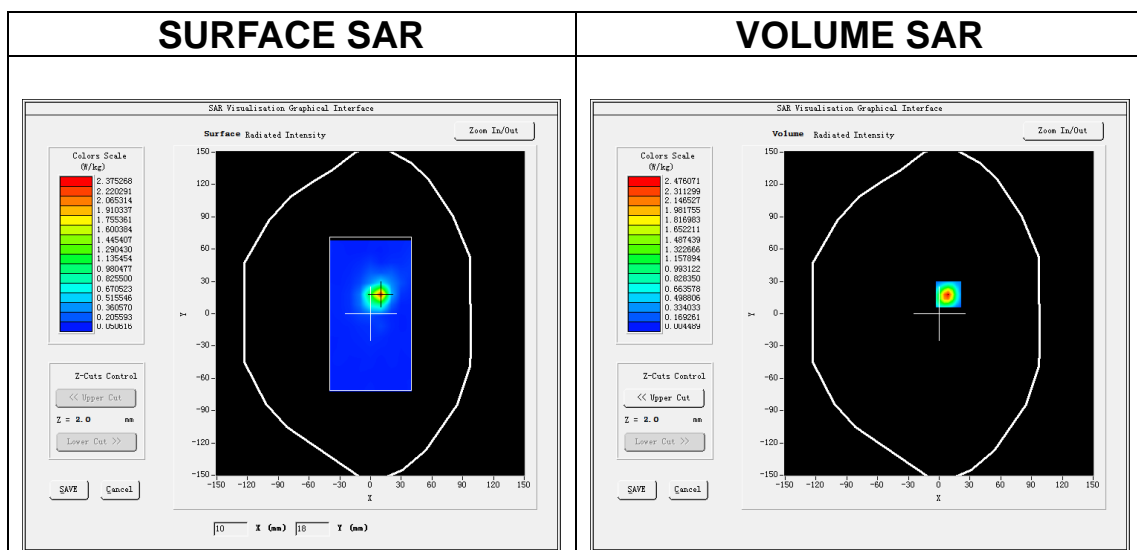

Maximum location: X=9.00, Y=18.00

SAR Peak: 4.28 W/kg

SAR 10g (W/Kg)	0.403995
SAR 1g (W/Kg)	1.303171

Z (m m)	0.00	2.00	4.00	6.00	8.00	10.0	12.0	14.0	16.0	18.0	20.0	22.0
SAR R (W/ Kg)	4.03	2.47	1.34	0.74	0.41	0.24	0.13	0.09	0.05	0.07	0.06	0.05
	79	61	36	44	18	31	92	77	34	34	26	98

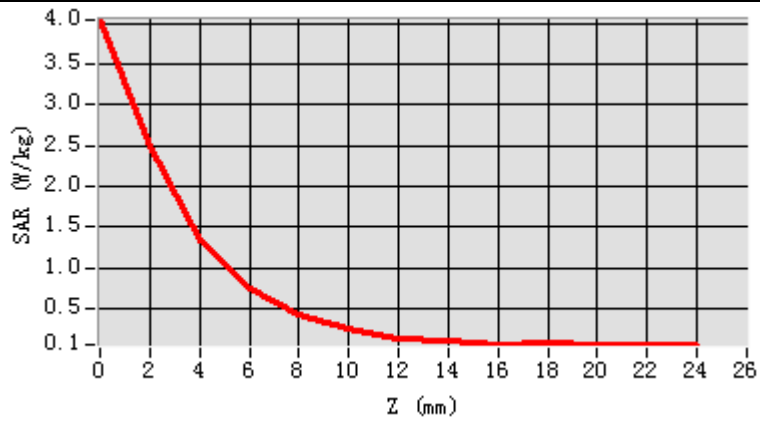

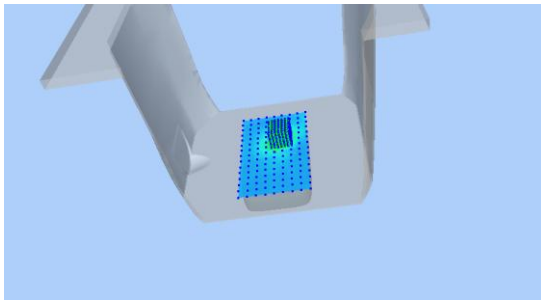
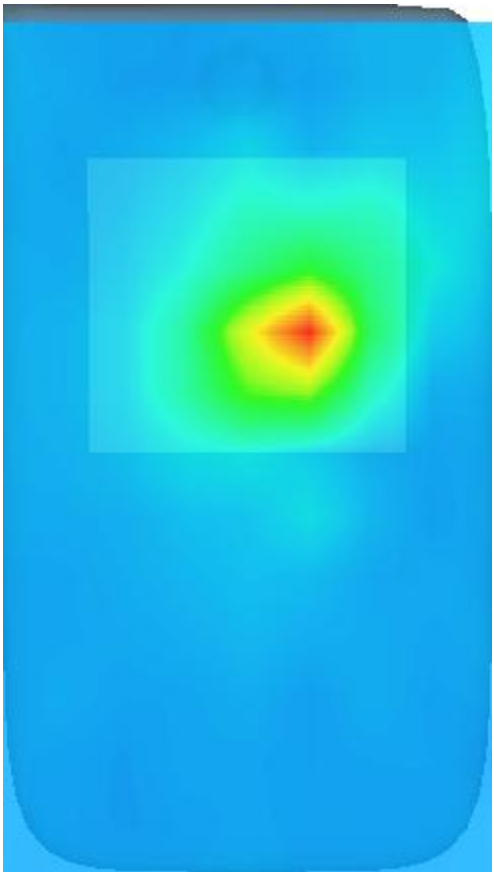
3D screen shot	Hot spot position
	

MEASUREMENT 2

Date of measurement: 24/12/2020

A. Experimental conditions.

Area Scan	<u>dx=10mm dy=10mm, h= 2.00 mm</u>
ZoomScan	<u>7x7x12,dx=4mm dy=4mm dz=2mm</u>
Phantom	<u>Validation plane</u>
Device Position	<u>Body</u>
Band	<u>IEEE 802.11a U-NII</u>
Channels	<u>Middle</u>
Signal	<u>IEEE802.11a (Crest factor: 1.0)</u>

B. SAR Measurement Results

Frequency (MHz)	5785.000000
Relative permittivity (real part)	48.783165
Relative permittivity (imaginary part)	18.656767
Conductivity (S/m)	5.996077
Variation (%)	-1.630000

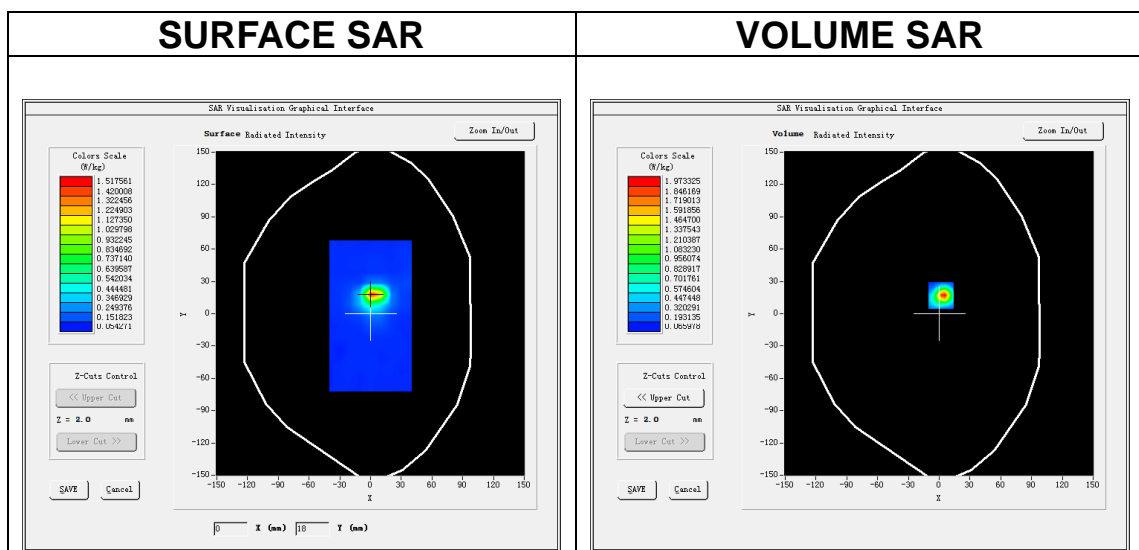

Maximum location: X=2.00, Y=17.00

SAR Peak: 3.60 W/kg

SAR 10g (W/Kg)	0.308695
SAR 1g (W/Kg)	1.010030

Z (m)	0.00	2.00	4.00	6.00	8.00	10.00	12.00	14.00	16.00	18.00	20.00	22.00
SAR (W/Kg)	3.4321	1.9733	0.6693	0.5292	0.2260	0.1776	0.1044	0.0944	0.0851	0.0828	0.0787	0.0724

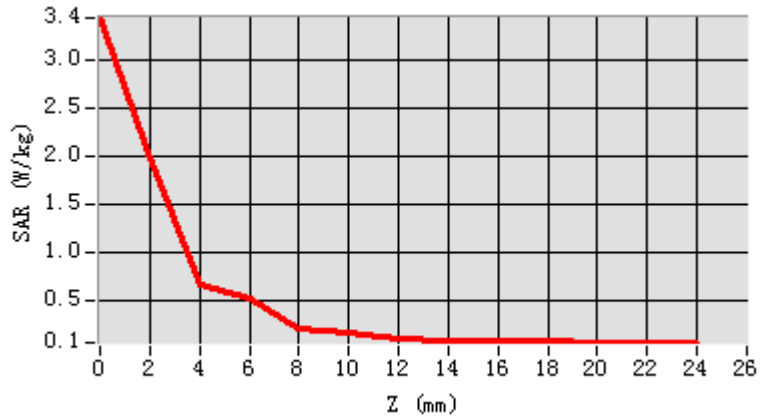

3D screen shot

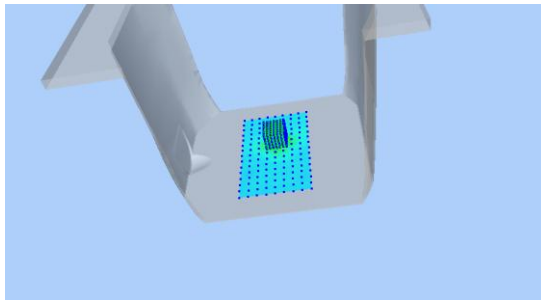

Hot spot position

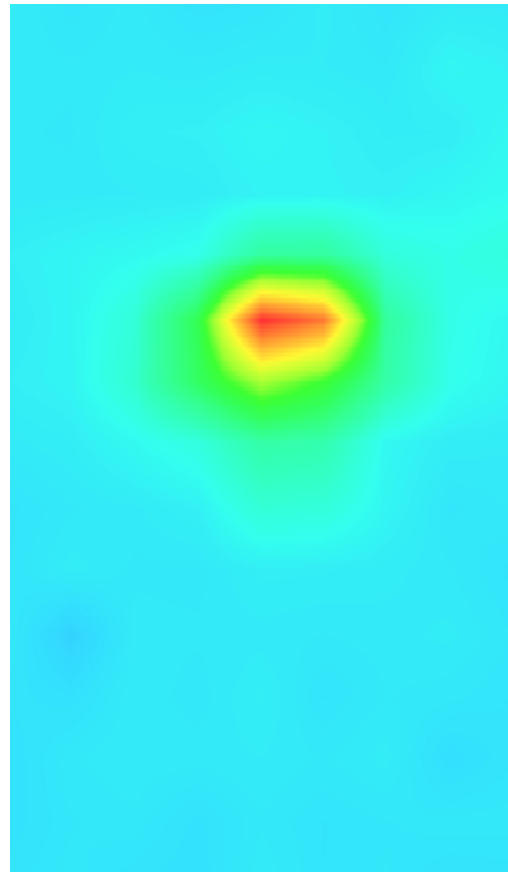

MEASUREMENT 3

Date of measurement: 17/12/2020

A. Experimental conditions.

Area Scan	<u>dx=10mm dy=10mm, h= 2.00 mm</u>
ZoomScan	<u>7x7x12,dx=4mm dy=4mm dz=2mm</u>
Phantom	<u>Validation plane</u>
Device Position	<u>Body</u>
Band	<u>IEEE 802.11a U-NII</u>
Channels	<u>Middle</u>
Signal	<u>IEEE802.11a (Crest factor: 1.0)</u>

B. SAR Measurement Results

Frequency (MHz)	5280.000000
Relative permittivity (real part)	49.203465
Relative permittivity (imaginary part)	18.665712
Conductivity (S/m)	5.475276
Variation (%)	-1.100000

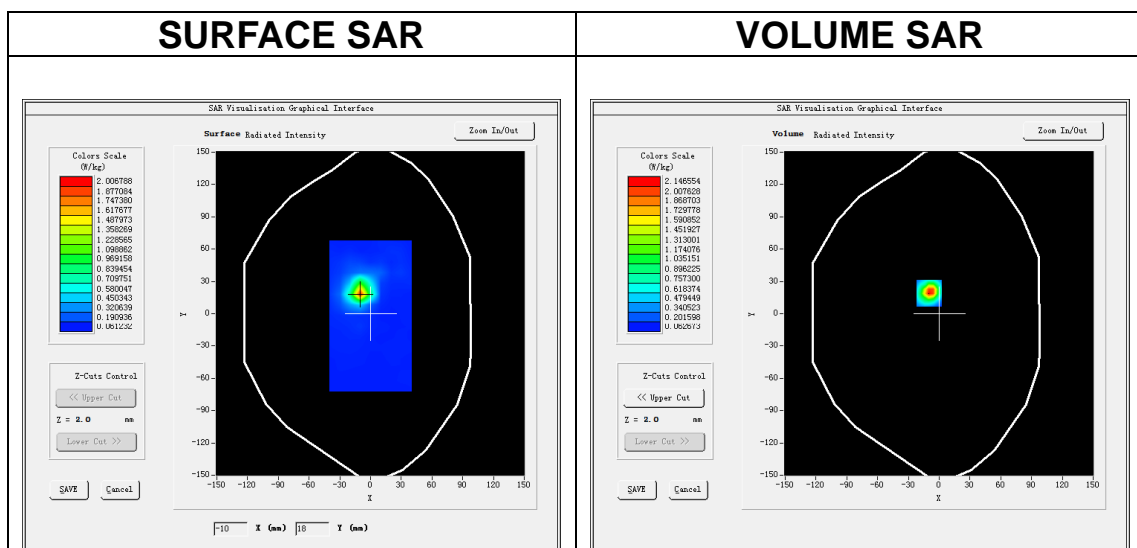

Maximum location: X=-10.00, Y=19.00

SAR Peak: 3.85 W/kg

SAR 10g (W/Kg)	0.381563
SAR 1g (W/Kg)	1.183296

Z (m)	0.00	2.00	4.00	6.00	8.00	10.00	12.00	14.00	16.00	18.00	20.00	22.00
SAR (W/Kg)	3.5189	2.1466	1.1673	0.6450	0.3704	0.2237	0.1462	0.1072	0.0900	0.0753	0.0733	0.0743

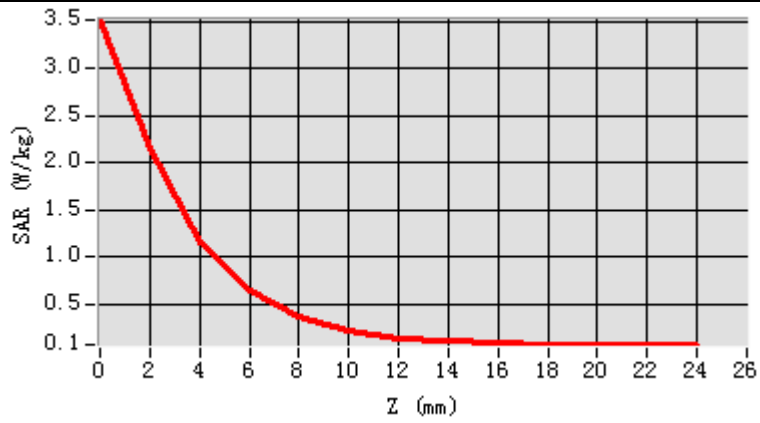

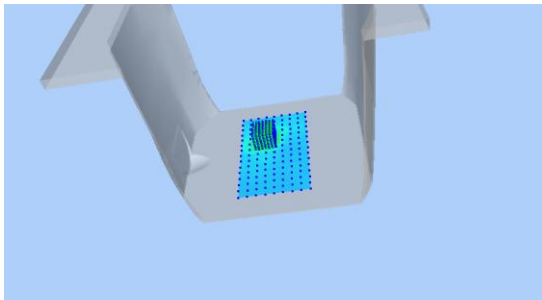
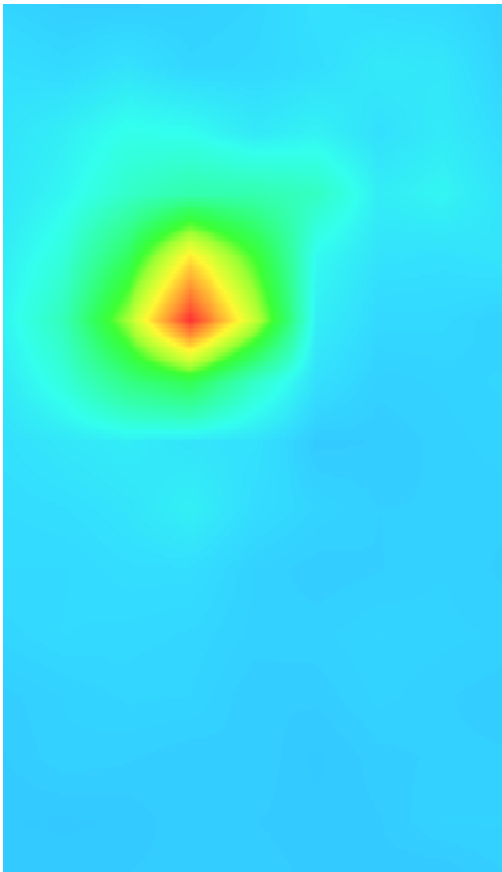
3D screen shot	Hot spot position
	

MEASUREMENT 4

Date of measurement: 24/12/2020

A. Experimental conditions.

Area Scan	<u>dx=10mm dy=10mm, h= 2.00 mm</u>
ZoomScan	<u>7x7x12,dx=4mm dy=4mm dz=2mm</u>
Phantom	<u>Validation plane</u>
Device Position	<u>Body</u>
Band	<u>IEEE 802.11a U-NII</u>
Channels	<u>High</u>
Signal	<u>IEEE802.11a (Crest factor: 1.0)</u>

B. SAR Measurement Results

Frequency (MHz)	5720.000000
Relative permittivity (real part)	48.941495
Relative permittivity (imaginary part)	18.811054
Conductivity (S/m)	5.977735
Variation (%)	0.210000

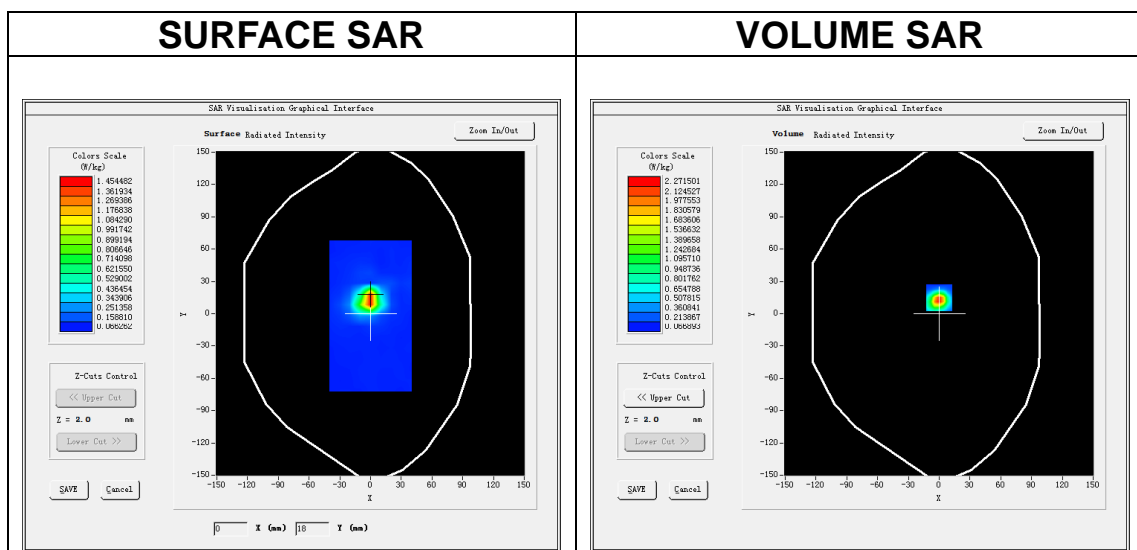

Maximum location: X=0.00, Y=15.00

SAR Peak: 4.19 W/kg

SAR 10g (W/Kg)	0.364600
SAR 1g (W/Kg)	1.188864

Z (m m)	0.00	2.00	4.00	6.00	8.00	10.00	12.00	14.00	16.00	18.00	20.00	22.00
SAR (W/Kg)	3.9894	2.2715	0.6160	0.6239	0.2061	0.2248	0.1036	0.1062	0.0815	0.0878	0.0756	0.0797

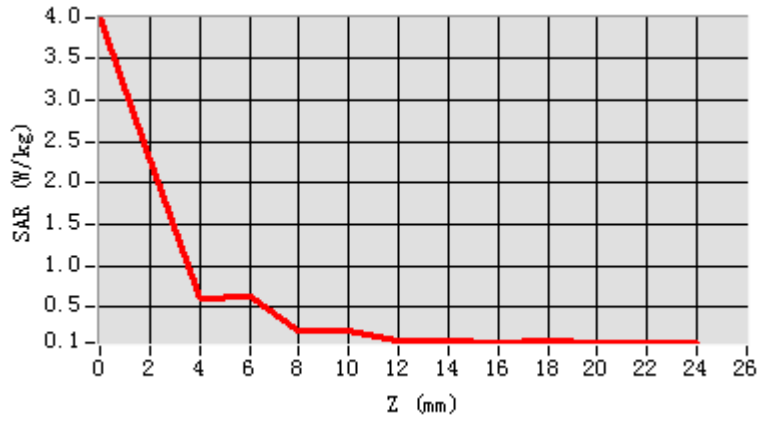

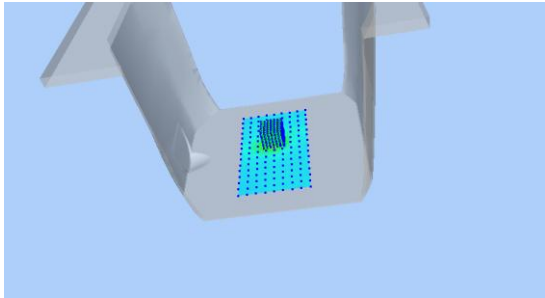
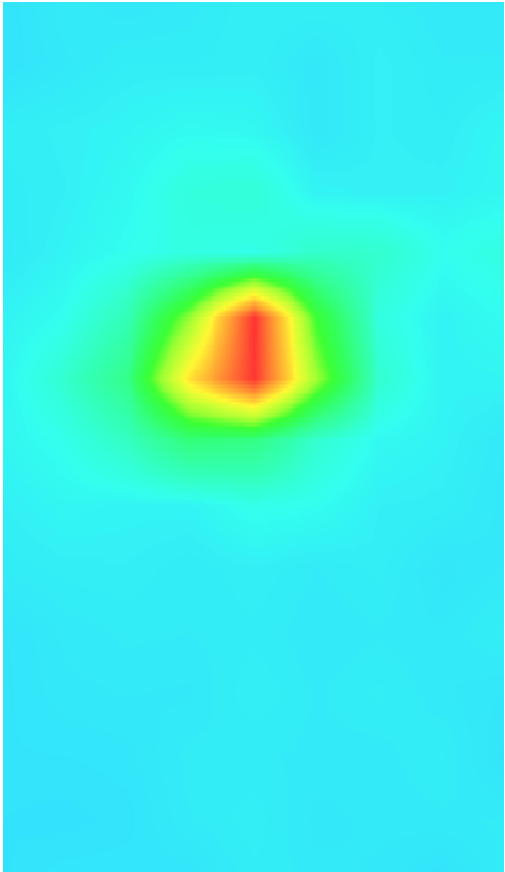
3D screen shot	Hot spot position
	

MEASUREMENT 5

Date of measurement: 23/12/2020

A. Experimental conditions.

Area Scan	<u>dx=12mm dy=12mm, h= 5.00 mm</u>
ZoomScan	<u>7x7x7, dx=5mm dy=5mm dz=5mm</u>
Phantom	<u>Validation plane</u>
Device Position	<u>Body</u>
Band	<u>IEEE 802.11b ISM</u>
Channels	<u>High</u>
Signal	<u>IEEE802.11b (Crest factor: 1.0)</u>

B. SAR Measurement Results

Frequency (MHz)	2462.000000
Relative permittivity (real part)	52.229210
Relative permittivity (imaginary part)	14.178457
Conductivity (S/m)	1.939298
Variation (%)	2.470000

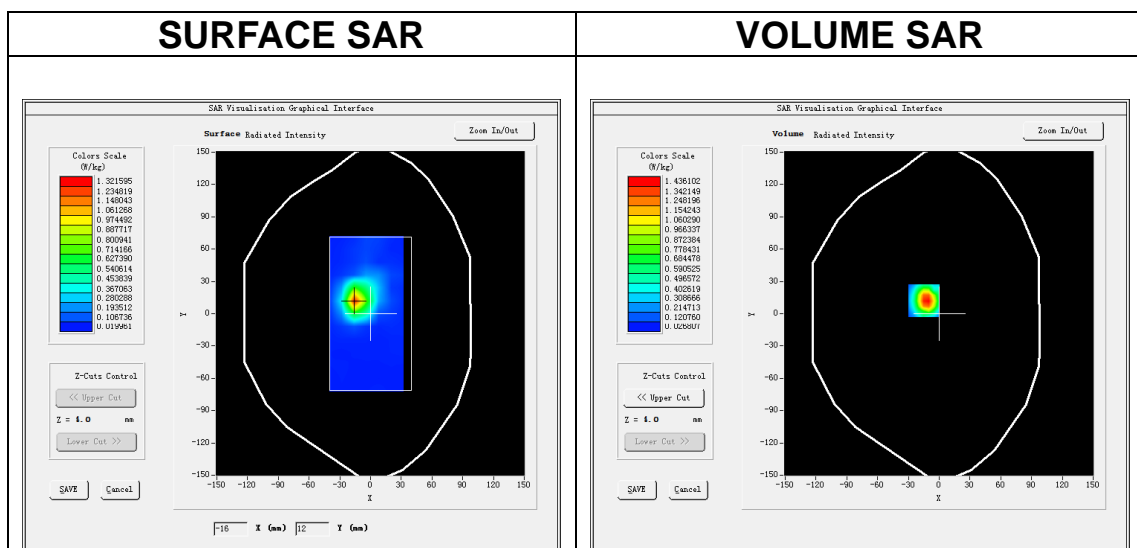

Maximum location: X=-15.00, Y=12.00

SAR Peak: 2.58 W/kg

SAR 10g (W/Kg)	0.551082
SAR 1g (W/Kg)	1.323216

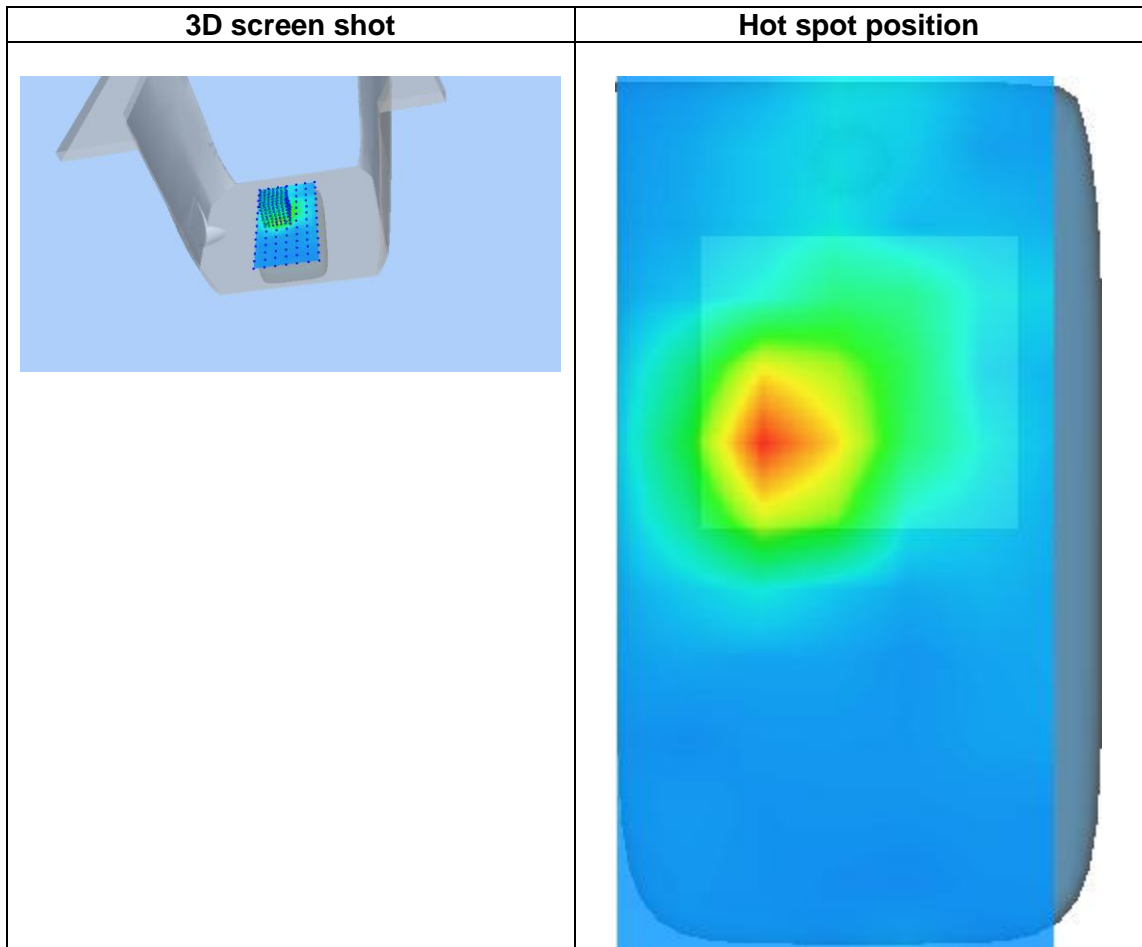
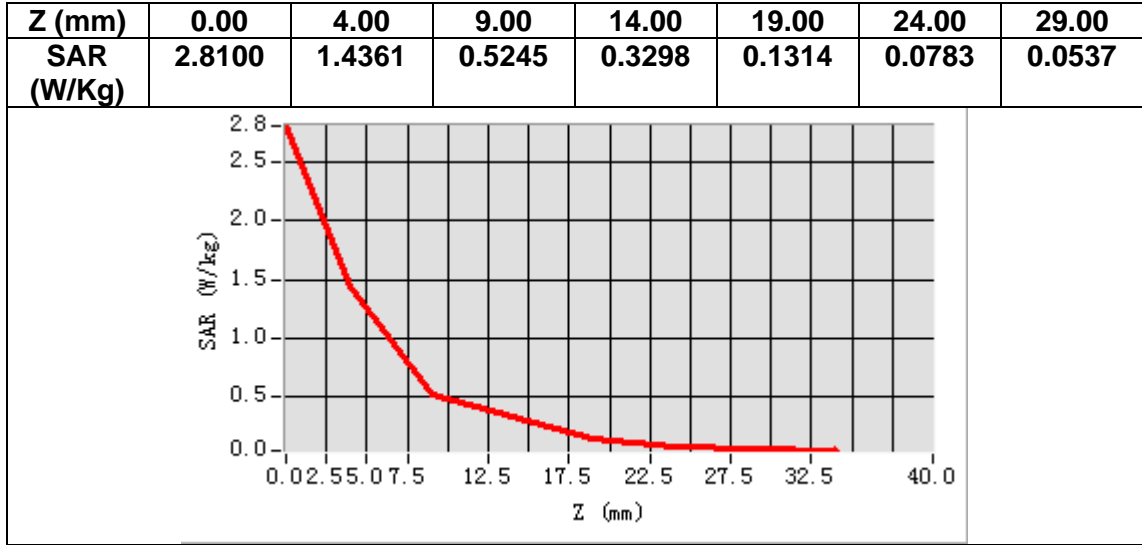

14. Appendix D. Calibration Certificate

Table of contents
E Field Probe - SN 08/16 EPGO287
2450 MHz Dipole - SN 03/15 DIP 2G450-352
5000-6000 MHz Dipole - SN 13/14 WGA 33
Extended Calibration Certificate



COMOSAR E-Field Probe Calibration Report

Ref : ACR.260.1.18.SATU.A

**SHENZHEN NTEK TESTING TECHNOLOGY
CO., LTD.**

**BUILDING E, FENDA SCIENCE PARK, SANWEI
COMMUNITY, XIXIANG STREET,
BAO'AN DISTRICT, SHENZHEN GUANGDONG, CHINA**

**MVG COMOSAR DOSIMETRIC E-FIELD PROBE
SERIAL NO.: SN 08/16 EPGO287**

Calibrated at MVG US

2105 Barrett Park Dr. - Kennesaw, GA 30144



Calibration Date: 12/27/2019

Summary:

This document presents the method and results from an accredited COMOSAR Dosimetric E-Field Probe calibration performed in MVG USA using the CALISAR / CALIBAIR test bench, for use with a COMOSAR system only. All calibration results are traceable to national metrology institutions.



COMOSAR E-FIELD PROBE CALIBRATION REPORT

Ref: ACR.260.1.18.SATU.A

	<i>Name</i>	<i>Function</i>	<i>Date</i>	<i>Signature</i>
<i>Prepared by :</i>	Jérôme LUC	Product Manager	12/27/2019	<i>[Signature]</i>
<i>Checked by :</i>	Jérôme LUC	Product Manager	12/27/2019	<i>[Signature]</i>
<i>Approved by :</i>	Kim RUTKOWSKI	Quality Manager	12/27/2019	<i>Kim Rutkowski</i>

	<i>Customer Name</i>
<i>Distribution :</i>	SHENZHEN NTEK TESTING TECHNOLOGY CO., LTD.

<i>Issue</i>	<i>Date</i>	<i>Modifications</i>
A	12/27/2019	Initial release



COMOSAR E-FIELD PROBE CALIBRATION REPORT

Ref: ACR.260.1.18.SATU.A

TABLE OF CONTENTS

1 Device Under Test 4

2 Product Description 4

 2.1 General Information 4

3 Measurement Method 4

 3.1 Linearity 4

 3.2 Sensitivity 5

 3.3 Lower Detection Limit 5

 3.4 Isotropy 5

 3.5 Boundary Effect 5

4 Measurement Uncertainty 5

5 Calibration Measurement Results 6

 5.1 Sensitivity in air 6

 5.2 Linearity 7

 5.3 Sensitivity in liquid 7

 5.4 Isotropy 8

6 List of Equipment 10



COMOSAR E-FIELD PROBE CALIBRATION REPORT

Ref: ACR.260.1.18.SATU.A

1 DEVICE UNDER TEST

Device Under Test	
Device Type	COMOSAR DOSIMETRIC E FIELD PROBE
Manufacturer	MVG
Model	SSE2
Serial Number	SN 08/16 EPGO287
Product Condition (new / used)	Used
Frequency Range of Probe	0.15 GHz-6GHz
Resistance of Three Dipoles at Connector	Dipole 1: R1=0.209 MΩ Dipole 2: R2=0.196 MΩ Dipole 3: R3=0.197 MΩ

A yearly calibration interval is recommended.

2 PRODUCT DESCRIPTION

2.1 GENERAL INFORMATION

MVG’s COMOSAR E field Probes are built in accordance to the IEEE 1528, OET 65 Bulletin C and CEI/IEC 62209 standards.



Figure 1 – MVG COMOSAR Dosimetric E field Dipole

Probe Length	330 mm
Length of Individual Dipoles	2 mm
Maximum external diameter	8 mm
Probe Tip External Diameter	2.5 mm
Distance between dipoles / probe extremity	1 mm

3 MEASUREMENT METHOD

The IEEE 1528, OET 65 Bulletin C, CENELEC EN50361 and CEI/IEC 62209 standards provide recommended practices for the probe calibrations, including the performance characteristics of interest and methods by which to assess their affect. All calibrations / measurements performed meet the fore mentioned standards.

3.1 LINEARITY

The evaluation of the linearity was done in free space using the waveguide, performing a power sweep to cover the SAR range 0.01W/kg to 100W/kg.



COMOSAR E-FIELD PROBE CALIBRATION REPORT

Ref: ACR.260.1.18.SATU.A

3.2 SENSITIVITY

The sensitivity factors of the three dipoles were determined using a two step calibration method (air and tissue simulating liquid) using waveguides as outlined in the standards.

3.3 LOWER DETECTION LIMIT

The lower detection limit was assessed using the same measurement set up as used for the linearity measurement. The required lower detection limit is 10 mW/kg.

3.4 ISOTROPY

The axial isotropy was evaluated by exposing the probe to a reference wave from a standard dipole with the dipole mounted under the flat phantom in the test configuration suggested for system validations and checks. The probe was rotated along its main axis from 0 - 360 degrees in 15 degree steps. The hemispherical isotropy is determined by inserting the probe in a thin plastic box filled with tissue-equivalent liquid, with the plastic box illuminated with the fields from a half wave dipole. The dipole is rotated about its axis (0°–180°) in 15° increments. At each step the probe is rotated about its axis (0°–360°).

3.5 BOUNDARY EFFECT

The boundary effect is defined as the deviation between the SAR measured data and the expected exponential decay in the liquid when the probe is oriented normal to the interface. To evaluate this effect, the liquid filled flat phantom is exposed to fields from either a reference dipole or waveguide. With the probe normal to the phantom surface, the peak spatial average SAR is measured and compared to the analytical value at the surface.

4 MEASUREMENT UNCERTAINTY

The guidelines outlined in the IEEE 1528, OET 65 Bulletin C, CENELEC EN50361 and CEI/IEC 62209 standards were followed to generate the measurement uncertainty associated with an E-field probe calibration using the waveguide technique. All uncertainties listed below represent an expanded uncertainty expressed at approximately the 95% confidence level using a coverage factor of k=2, traceable to the Internationally Accepted Guides to Measurement Uncertainty.

Uncertainty analysis of the probe calibration in waveguide					
ERROR SOURCES	Uncertainty value (%)	Probability Distribution	Divisor	ci	Standard Uncertainty (%)
Incident or forward power	3.00%	Rectangular	$\sqrt{3}$	1	1.732%
Reflected power	3.00%	Rectangular	$\sqrt{3}$	1	1.732%
Liquid conductivity	5.00%	Rectangular	$\sqrt{3}$	1	2.887%
Liquid permittivity	4.00%	Rectangular	$\sqrt{3}$	1	2.309%
Field homogeneity	3.00%	Rectangular	$\sqrt{3}$	1	1.732%
Field probe positioning	5.00%	Rectangular	$\sqrt{3}$	1	2.887%
Field probe linearity	3.00%	Rectangular	$\sqrt{3}$	1	1.732%
Combined standard uncertainty					5.831%
Expanded uncertainty 95 % confidence level k = 2					12.0%



COMOSAR E-FIELD PROBE CALIBRATION REPORT

Ref: ACR.260.1.18.SATU.A

5 CALIBRATION MEASUREMENT RESULTS

Calibration Parameters	
Liquid Temperature	21 °C
Lab Temperature	21 °C
Lab Humidity	45 %

5.1 SENSITIVITY IN AIR

Normx dipole 1 ($\mu\text{V}/(\text{V}/\text{m})^2$)	Normy dipole 2 ($\mu\text{V}/(\text{V}/\text{m})^2$)	Normz dipole 3 ($\mu\text{V}/(\text{V}/\text{m})^2$)
0.66	0.75	0.58

DCP dipole 1 (mV)	DCP dipole 2 (mV)	DCP dipole 3 (mV)
93	93	98

Calibration curves $e_i=f(V)$ ($i=1,2,3$) allow to obtain H-field value using the formula:

$$E = \sqrt{E_1^2 + E_2^2 + E_3^2}$$

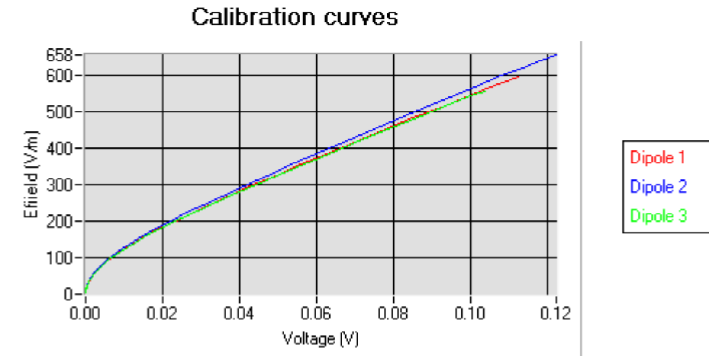



COMOSAR E-FIELD PROBE CALIBRATION REPORT

Ref: ACR.260.1.18.SATU.A

5.2 LINEARITY

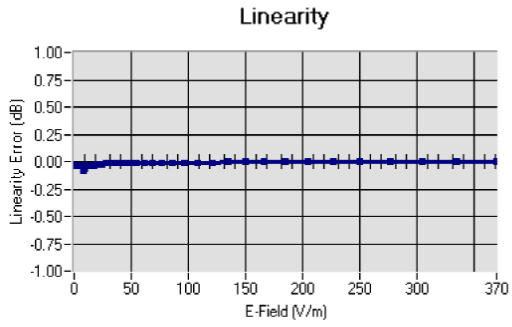

Linearity: $\pm 1.89\%$ ($\pm 0.08\text{dB}$)

5.3 SENSITIVITY IN LIQUID

Liquid	Frequency (MHz +/- 100MHz)	Permittivity	Epsilon (S/m)	ConvF
HL750	750	40.03	0.93	1.45
BL750	750	56.83	1.00	1.49
HL850	835	42.19	0.90	1.50
BL850	835	54.67	1.01	1.56
HL900	900	42.08	1.01	1.51
HL1800	1800	41.68	1.46	1.71
BL1800	1800	53.86	1.46	1.77
HL1900	1900	38.45	1.45	2.03
BL1900	1900	53.32	1.56	2.07
HL2000	2000	38.26	1.38	1.76
HL2450	2450	37.50	1.80	2.00
BL2450	2450	53.22	1.89	2.08
HL2600	2600	39.80	1.99	2.12
BL2600	2600	52.52	2.23	2.19
HL5200	5200	35.64	4.67	2.55
BL5200	5200	48.64	5.51	2.62
HL5400	5400	36.44	4.87	2.53
BL5400	5400	46.52	5.77	2.59
HL5600	5600	36.66	5.17	2.64
BL5600	5600	46.79	5.77	2.73
HL5800	5800	35.31	5.31	2.72
BL5800	5800	47.04	6.10	2.81

LOWER DETECTION LIMIT: 7mW/kg



COMOSAR E-FIELD PROBE CALIBRATION REPORT

Ref: ACR.260.1.18.SATU.A

5.4 ISOTROPY

HL900 MHz

- Axial isotropy: 0.04 dB
- Hemispherical isotropy: 0.07 dB

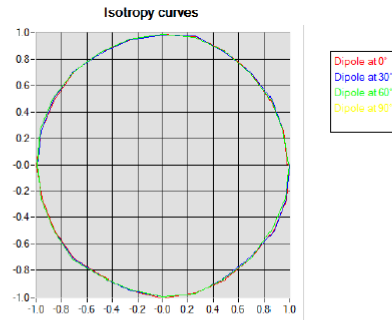

HL1800 MHz

- Axial isotropy: 0.06 dB
- Hemispherical isotropy: 0.08 dB

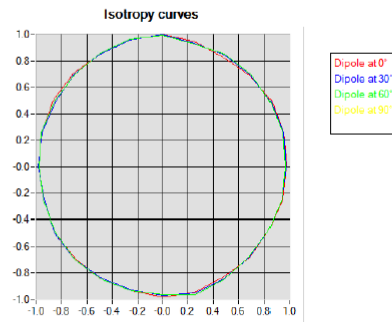



COMOSAR E-FIELD PROBE CALIBRATION REPORT

Ref: ACR.260.1.18.SATU.A

HL5600 MHz

- Axial isotropy: 0.06 dB
- Hemispherical isotropy: 0.08 dB

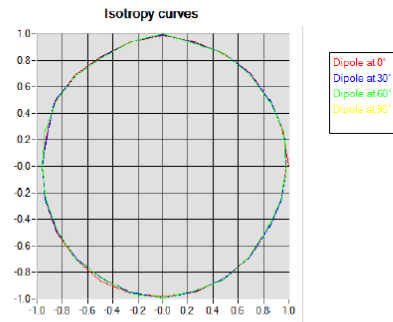



COMOSAR E-FIELD PROBE CALIBRATION REPORT

Ref: ACR.260.1.18.SATU.A

6 LIST OF EQUIPMENT

Equipment Summary Sheet				
Equipment Description	Manufacturer / Model	Identification No.	Current Calibration Date	Next Calibration Date
Flat Phantom	MVG	SN-20/09-SAM71	Validated. No cal required.	Validated. No cal required.
COMOSAR Test Bench	Version 3	NA	Validated. No cal required.	Validated. No cal required.
Network Analyzer	Rhode & Schwarz ZVA	SN100132	02/2019	02/2022
Reference Probe	MVG	EP 94 SN 37/08	10/2019	10/2020
Multimeter	Keithley 2000	1188656	01/2017	01/2020
Signal Generator	Agilent E4438C	MY49070581	01/2017	01/2020
Amplifier	Aethercomm	SN 046	Characterized prior to test. No cal required.	Characterized prior to test. No cal required.
Power Meter	HP E4418A	US38261498	01/2017	01/2020
Power Sensor	HP ECP-E26A	US37181460	01/2017	01/2020
Directional Coupler	Narda 4216-20	01386	Characterized prior to test. No cal required.	Characterized prior to test. No cal required.
Waveguide	Mega Industries	069Y7-158-13-712	Validated. No cal required.	Validated. No cal required.
Waveguide Transition	Mega Industries	069Y7-158-13-701	Validated. No cal required.	Validated. No cal required.
Waveguide Termination	Mega Industries	069Y7-158-13-701	Validated. No cal required.	Validated. No cal required.
Temperature / Humidity Sensor	Control Company	150798832	11/2017	11/2020



SAR Reference Dipole Calibration Report

Ref : ACR.109.7.18.SATU.A

SHENZHEN NTEK TESTING TECHNOLOGY CO., LTD.

BUILDING E, FENDA SCIENCE PARK, SANWEI
COMMUNITY, XIXIANG STREET,
BAO'AN DISTRICT, SHENZHEN GUANGDONG, CHINA

MVG COMOSAR REFERENCE DIPOLE

FREQUENCY: 2450 MHZ

SERIAL NO.: SN 03/15 DIP 2G450-352

Calibrated at MVG US

2105 Barrett Park Dr. - Kennesaw, GA 30144



Calibration Date: 04/19/2018

Summary:

This document presents the method and results from an accredited SAR reference dipole calibration performed in MVG USA using the COMOSAR test bench. All calibration results are traceable to national metrology institutions.



SAR REFERENCE DIPOLE CALIBRATION REPORT

Ref: ACR.109.7.18.SATU.A

	<i>Name</i>	<i>Function</i>	<i>Date</i>	<i>Signature</i>
<i>Prepared by :</i>	Jérôme LUC	Product Manager	4/19/2018	<i>JL</i>
<i>Checked by :</i>	Jérôme LUC	Product Manager	4/19/2018	<i>JL</i>
<i>Approved by :</i>	Kim RUTKOWSKI	Quality Manager	4/19/2018	<i>Kim Rutkowski</i>

	<i>Customer Name</i>
<i>Distribution :</i>	SHENZHEN NTEK TESTING TECHNOLOGY CO., LTD.

<i>Issue</i>	<i>Date</i>	<i>Modifications</i>
A	4/19/2018	Initial release



SAR REFERENCE DIPOLE CALIBRATION REPORT

Ref: ACR.109.7.18.SATU.A

TABLE OF CONTENTS

1 Introduction 4

2 Device Under Test 4

3 Product Description 4

 3.1 General Information 4

4 Measurement Method 5

 4.1 Return Loss Requirements 5

 4.2 Mechanical Requirements 5

5 Measurement Uncertainty 5

 5.1 Return Loss 5

 5.2 Dimension Measurement 5

 5.3 Validation Measurement 5

6 Calibration Measurement Results 6

 6.1 Return Loss and Impedance In Head Liquid 6

 6.2 Return Loss and Impedance In Body Liquid 6

 6.3 Mechanical Dimensions 6

7 Validation measurement 7

 7.1 Head Liquid Measurement 7

 7.2 SAR Measurement Result With Head Liquid 8

 7.3 Body Liquid Measurement 9

 7.4 SAR Measurement Result With Body Liquid 10

8 List of Equipment 11



SAR REFERENCE DIPOLE CALIBRATION REPORT

Ref: ACR.109.7.18.SATU.A

1 INTRODUCTION

This document contains a summary of the requirements set forth by the IEEE 1528, FCC KDBs and CEI/IEC 62209 standards for reference dipoles used for SAR measurement system validations and the measurements that were performed to verify that the product complies with the fore mentioned standards.

2 DEVICE UNDER TEST

Device Under Test	
Device Type	COMOSAR 2450 MHz REFERENCE DIPOLE
Manufacturer	MVG
Model	SID2450
Serial Number	SN 03/15 DIP 2G450-352
Product Condition (new / used)	Used

A yearly calibration interval is recommended.

3 PRODUCT DESCRIPTION

3.1 GENERAL INFORMATION

MVG’s COMOSAR Validation Dipoles are built in accordance to the IEEE 1528, FCC KDBs and CEI/IEC 62209 standards. The product is designed for use with the COMOSAR test bench only.



Figure 1 – MVG COMOSAR Validation Dipole



SAR REFERENCE DIPOLE CALIBRATION REPORT

Ref: ACR.109.7.18.SATU.A

4 MEASUREMENT METHOD

The IEEE 1528, FCC KDBs and CEI/IEC 62209 standards provide requirements for reference dipoles used for system validation measurements. The following measurements were performed to verify that the product complies with the fore mentioned standards.

4.1 RETURN LOSS REQUIREMENTS

The dipole used for SAR system validation measurements and checks must have a return loss of -20 dB or better. The return loss measurement shall be performed against a liquid filled flat phantom, with the phantom constructed as outlined in the fore mentioned standards.

4.2 MECHANICAL REQUIREMENTS

The IEEE Std. 1528 and CEI/IEC 62209 standards specify the mechanical components and dimensions of the validation dipoles, with the dimensions frequency and phantom shell thickness dependent. The COMOSAR test bench employs a 2 mm phantom shell thickness therefore the dipoles sold for use with the COMOSAR test bench comply with the requirements set forth for a 2 mm phantom shell thickness.

5 MEASUREMENT UNCERTAINTY

All uncertainties listed below represent an expanded uncertainty expressed at approximately the 95% confidence level using a coverage factor of k=2, traceable to the Internationally Accepted Guides to Measurement Uncertainty.

5.1 RETURN LOSS

The following uncertainties apply to the return loss measurement:

Frequency band	Expanded Uncertainty on Return Loss
400-6000MHz	0.1 dB

5.2 DIMENSION MEASUREMENT

The following uncertainties apply to the dimension measurements:

Length (mm)	Expanded Uncertainty on Length
3 - 300	0.05 mm

5.3 VALIDATION MEASUREMENT

The guidelines outlined in the IEEE 1528, FCC KDBs, CENELEC EN50361 and CEI/IEC 62209 standards were followed to generate the measurement uncertainty for validation measurements.

Scan Volume	Expanded Uncertainty
1 g	20.3 %



SAR REFERENCE DIPOLE CALIBRATION REPORT

Ref: ACR.109.7.18.SATU.A

10 g	20.1 %
------	--------

6 CALIBRATION MEASUREMENT RESULTS

6.1 RETURN LOSS AND IMPEDANCE IN HEAD LIQUID

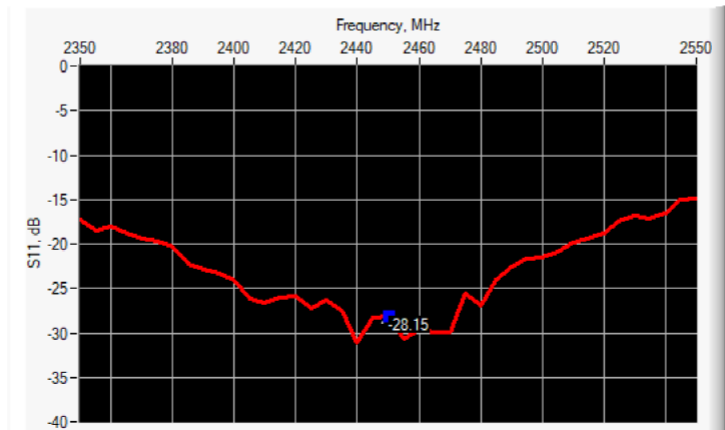

Frequency (MHz)	Return Loss (dB)	Requirement (dB)	Impedance
2450	-28.15	-20	53.9 Ω + 0.3 jΩ

6.2 RETURN LOSS AND IMPEDANCE IN BODY LIQUID

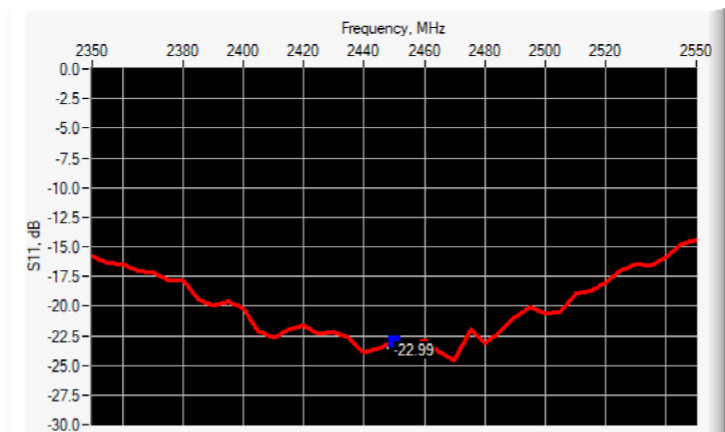

Frequency (MHz)	Return Loss (dB)	Requirement (dB)	Impedance
2450	-22.99	-20	57.6 Ω - 0.8 jΩ

6.3 MECHANICAL DIMENSIONS

Frequency MHz	L mm		h mm		d mm	
	required	measured	required	measured	required	measured
300	420.0 ±1 %		250.0 ±1 %		6.35 ±1 %	