

Regulatory WWAN + WiFi, Main + Aux Antenna Information

Platform	
Platform Owner	Acer Incorporated
Brand Name	Acer Incorporated
Model Name	JM12-MS (ZE8)
ODM	Quanta computer Inc.
Target Launch Date	
Antenna	
Brand Name	Wistron Neweb Corp.
Part Number	<input checked="" type="checkbox"/> WWAN Main Antenna: DQ6T15GCV00
	<input checked="" type="checkbox"/> WWAN Aux Antenna: DQ6T15GCV00
	<input checked="" type="checkbox"/> WiFi Main Antenna: DQ6T15GCV00
	<input checked="" type="checkbox"/> WiFi Aux Antenna: DQ6T15GCV00
Module	
With WLAN Module	<input type="checkbox"/> 533ANX Family
(Check Box)	<input type="checkbox"/> 533AN Family
	<input type="checkbox"/> 512AN Family
	<input type="checkbox"/> 512ANX Family
	<input type="checkbox"/> RTL8192E
	<input type="checkbox"/> AR5BxB92
	<input type="checkbox"/> AR5BHB92

Antenna Sample / Antenna Data Requirements for worldwide regulatory approval

Section	Description of Required OEM / ODM Antenna Information	US / IC	EU	Japan	Taiwan	S.Korea
1A	Part Number for Antenna only	Required	Required	Required	Required	Required
1B	Antenna Manufacturer Name	Required	Required	Required	Required	Required
1C	Description of Antenna Type	Required	N/A	N/A	N/A	N/A
1D	Part number of Antenna Assembly / cable impedance, length & diameter.	Required	Desired	Desired	Desired	Desired
1E	Tx1, Tx2 & Tx3 antenna (Peak Gain W/ cable loss) *	Required	Required	Required	Required	Required
	1E OR 1F, 1G, 1H					
1F	Tx1, Tx2 & Tx3 antenna (Peak Gain only) *	Required	Required	Required	Required	Required
1G	VSWR of cable including connector	Required	Required	Required	Required	Required
1H	Tx1, Tx2 & Tx3 antenna (Cable loss W/ connector) *	Required	Required	Required	Required	Required
2	Dimensioned Photographs and Drawings of Tx1, Tx2, and Tx3 (or Rx3) antennas	Required	Required	Required	Required	Required
3	Radiation patterns of antennas loaded in the host platform.	Required	Desired	Required	N/A	Required
4	Platform model name / number - correlated to antenna manufacturer and antenna part number	Required	Required	Desired	Required	Desired
5	Photograph(s) or Drawings showing location of antennas in platform. (S. Korea requires photographs of antennas for approval submission). Taiwan requires pictures of each antenna type shown in the system.	Required	Required	Desired	Required (Photos)	Required (Photos)
6	Mech. drawings / photos with dimensions of antenna locations and distance from end-user (For evaluation of SAR testing requirement).	Required	N/A	N/A	N/A	N/A
7	Photograph(s) or Drawings showing the location of all antennas (WLAN, other) and distance between those transmitting antennas. Information will be used to evaluate whether co-location testing is required.	Required	N/A	N/A	N/A	N/A
8	Local representative contact information for LMA/ PARS process.	Required	N/A	N/A	N/A	N/A

NOTE:

(*) if 3rd antenna is Rx only (e.g. receive only for 4965AGN) then peak gain and cable loss not required

Antenna Information

Section 1. Antenna Assembly Specifications

Antenna Assembly Summary:

WWAN

1A Antenna Part Number	1B Manufacture	1C Antenna Type	1D Cable Assembly Part Number and Information	1E Peak Gain W/ Cable loss (dBi)	1F Peak Gain w/o Cable Loss (dBi)	1G VSWR	1H Cable Loss (dBi)
WWAN Main Antenna P/N: DQ6T15GCV00	Quanta Computer Inc	PIFA	P/N: 60.EJT04.045 50 ohm Coaxial. length: 655 mm diameter: 1.13 mm Connector: IPEX	824-894MHz	824-894MHz	824-894MHz	824-894MHz
				-2.39 dBi (peak)	-3.42 dBi (peak)	3.0 max	-1.03 dBi (peak)
				869-894MHz	869-894MHz	869-894MHz	869-894MHz
				-2.39 dBi (peak)	-3.42 dBi (peak)	3.0 max	-1.03 dBi (peak)
				900-925MHz	900-925MHz	900-925MHz	900-925MHz
				-1.80 dBi (peak)	-2.83 dBi (peak)	3.0 max	-1.03 dBi (peak)
				940-960MHz	940-960MHz	940-960MHz	940-960MHz
				-2.19 dBi (peak)	-3.22 dBi (peak)	3.0 max	-1.03 dBi (peak)
				1710~1805MHz	1710~1805MHz	1710~1805MHz	1710~1805MHz
1.37 dBi (peak)	-0.04 dBi (peak)	3.0 max	-1.41 dBi (peak)				
1840~1910MHz	1840~1910MHz	1840~1910MHz	1840~1910MHz				
1.63 dBi (peak)	0.21 dBi (peak)	3.0 max	-1.41 dBi (peak)				
1920~1950MHz	1920~1950MHz	1920~1950MHz	1920~1950MHz				
1.24 dBi (peak)	-0.18 dBi (peak)	3.0 max	-1.41 dBi (peak)				
1960~1990MHz	1960~1990MHz	1960~1990MHz	1960~1990MHz				
1.12 dBi (peak)	-0.29 dBi (peak)	3.0 max	-1.41 dBi (peak)				
2110~2170MHz	2110~2170MHz	2110~2170MHz	2110~2170MHz				
0.95 dBi (peak)	-0.46 dBi (peak)	3.0 max	-1.41 dBi (peak)				
1A Antenna Part Number	1B Manufacture	1C Antenna Type	1D Cable Assembly Part Number and Information	1E Peak Gain W/ Cable loss (dBi)	1F Peak Gain w/o Cable Loss (dBi)	1G VSWR	1H Cable Loss (dBi)
WWAN Aux Antenna P/N: DQ6T15GCV00	Quanta Computer Inc	PIFA	P/N: 60.EJT04.045 50 ohm Coaxial. length: 686 mm diameter: 1.13 mm Connector: IPEX	869-894MHz	869-894MHz	869-894MHz	869-894MHz
				-3.05 dBi (peak)	-4.08 dBi (peak)	3.0 max	-1.03 dBi (peak)
				1920~1950MHz	1920~1950MHz	1920~1950MHz	1920~1950MHz
				1.24 dBi (peak)	-0.18 dBi (peak)	3.0 max	-1.41 dBi (peak)
				1960~1990MHz	1960~1990MHz	1960~1990MHz	1960~1990MHz
1.58 dBi (peak)	0.17 dBi (peak)	3.0 max	-1.41 dBi (peak)				
2110~2170MHz	2110~2170MHz	2110~2170MHz	2110~2170MHz				
1.15 dBi (peak)	-0.26 dBi (peak)	3.0 max	-1.41 dBi (peak)				

WiFi

1A Antenna Part Number	1B Manufacture	1C Antenna Type	1D Cable Assembly Part Number and Information	1E Peak Gain W/ Cable loss (dBi)	1F Peak Gain w/o Cable Loss (dBi)	1G VSWR	1H Cable Loss (dBi)
WiFi Main Antenna P/N: DQ6T15GCV00	Quanta Computer Inc	PIFA	P/N: 60.EGM04.045 50 ohm Coaxial. length: 601 mm diameter: 1.13 mm Connector: IPEX	2400-2450MHz	2400-2450MHz	2400-2450MHz	2400-2450MHz
				-1.77 dBi (peak)	0.34 dBi (peak)	2.0 max	2.12 dBi (peak)
				2450-2500MHz	2450-2500MHz	2450-2500MHz	2450-2500MHz
				-1.77 dBi (peak)	0.34 dBi (peak)	2.0 max	2.12 dBi (peak)
				5150-5350MHz	5150-5470MHz	5150-5470MHz	5150-5470MHz
				-0.30 dBi (peak)	3.06 dBi (peak)	2.0 max	3.36 dBi (peak)
5470-5725MHz	5150-5470MHz	5150-5470MHz	5150-5470MHz				
-0.13 dBi (peak)	0.67 dBi (peak)	2.0 max	0.80 dBi (peak)				
5725-5850MHz	5600-5750MHz	5600-5750MHz	5600-5750MHz				
0.00 dBi (peak)	3.56 dBi (peak)	2.0 max	3.56 dBi (peak)				

WiFi aux Antenna P/N: DQ6T15GCV00	Quanta Computer Inc	PIFA	P/N: 60.EGM04.045 50 ohm Coaxial. length: 675 mm diameter: 1.13 mm Connector: IPEX	2400-2450MHz	2400-2450MHz	2400-2450MHz	2400-2450MHz
				0.30 dBi (peak)	2.41 dBi (peak)	2.0 max	2.12 dBi (peak)
				2450-2500MHz	2450-2500MHz	2450-2500MHz	2450-2500MHz
				0.11 dBi (peak)	2.23 dBi (peak)	2.0 max	2.12 dBi (peak)
				5150-5350MHz	5150-5470MHz	5150-5470MHz	5150-5470MHz
0.48 dBi (peak)	3.85 dBi (peak)	2.0 max	3.36 dBi (peak)				
				5470-5725MHz	5150-5470MHz	5150-5470MHz	5150-5470MHz
				0.74 dBi (peak)	1.54 dBi (peak)	2.0 max	0.80 dBi (peak)
				5725-5850MHz	5600-5750MHz	5600-5750MHz	5600-5750MHz
				0.48 dBi (peak)	4.04 dBi (peak)	2.0 max	3.56 dBi (peak)

Antenna Peak Gain Table: WWAN MAIN

Main antenna Gain						
Frequency (MHz)	Max value			Average		
	H-pol (dBi)	V pol (dBi)	Total(dBi) (H-pol+V-pol)	H-pol (dBi)	V pol (dBi)	Total(dBi) (H-pol+V-pol)
824	-5.82	-4.24	-2.73	-10.51	-6.92	-5.14
836	-4.87	-3.69	-2.03	-9.66	-6.29	-4.44
849	-4.25	-3.88	-2.04	-9.37	-6.39	-4.40
869	-3.39	-4.52	-1.63	-8.33	-6.46	-4.07
880	-2.80	-4.04	-1.33	-7.23	-6.06	-3.33
894	-2.39	-4.17	-1.60	-7.39	-6.66	-3.68
900	-2.17	-4.18	-1.45	-7.38	-6.81	-3.74
915	-1.80	-4.45	-1.21	-7.21	-7.46	-3.96
925	-1.89	-5.41	-1.38	-7.44	-8.02	-4.35
940	-2.19	-5.81	-1.78	-7.45	-8.68	-4.61
960	-2.67	-7.15	-2.30	-7.66	-9.55	-5.05
1710	0.66	-2.11	1.79	-6.64	-8.04	-3.79
1750	1.02	-1.36	2.23	-6.57	-7.82	-3.60
1785	1.22	-0.75	2.61	-6.15	-7.33	-3.13
1805	1.37	-0.80	2.72	-5.97	-7.31	-3.01
1840	1.29	-0.73	2.70	-6.46	-7.53	-3.39
1850	1.63	-0.47	2.96	-5.95	-6.72	-2.73
1880	1.27	-0.47	2.61	-5.89	-6.92	-2.76
1910	1.24	-0.76	2.48	-6.02	-7.01	-2.88
1920	1.05	-0.70	2.46	-5.63	-6.50	-2.45
1930	0.99	-0.61	2.44	-5.59	-6.47	-2.41
1950	0.83	-0.79	2.21	-5.66	-6.87	-2.63
1960	1.12	-1.62	1.96	-5.49	-7.19	-2.76
1980	0.57	-2.61	1.50	-5.57	-7.61	-3.01
1990	0.51	-2.21	1.47	-8.00	-12.53	-4.92
2110	0.29	-4.70	0.91	-5.71	-7.41	-3.12
2140	0.95	-4.39	1.54	-5.34	-7.34	-2.84
2170	0.92	-3.07	1.43	-4.91	-7.20	-2.46

WWAN AUX

Aux antenna Gain						
Frequency (MHz)	Max value			Average		
	H-pol (dBi)	V pol (dBi)	Total(dBi) (H-pol+V-pol)	H-pol (dBi)	V pol (dBi)	Total(dBi) (H-pol+V-pol)
869	-3.50	-3.90	-2.23	-9.37	-8.04	-5.34
880	-3.05	-3.12	-1.14	-7.83	-7.13	-4.15
894	-3.95	-4.03	-1.55	-7.70	-7.54	-4.30

1930	0.85	-1.97	2.25	-6.96	-6.40	-3.29
1950	0.97	-1.42	2.38	-6.83	-6.20	-3.12
1960	1.56	-0.49	2.86	-6.06	-5.76	-2.52
1980	1.58	-0.56	2.84	-6.10	-5.89	-2.61
1990	1.15	-1.59	2.20	-10.11	-9.73	-5.03
2110	-0.11	-1.54	1.21	-8.87	-7.46	-4.65
2140	-1.34	-3.40	-0.30	-9.69	-8.38	-5.54
2170	-2.83	-4.64	-1.73	0.00	0.00	0.00

- Antenna Peak Gain required being test in system basis.
- 1E frame contend absolutely peak antenna gain include H/ V/ H+V.
-

WiFi

WiFi main antenna Gain						
Frequency (MHz)	Max value			Average		
	H-pol (dBi)	V pol (dBi)	Total(dBi) (H-pol+V-pol)	H-pol (dBi)	V pol (dBi)	Total(dBi) (H-pol+V-pol)
2400	-2.94	-3.57	-0.45	-7.64	-6.81	-3.79
2450	-1.77	-2.03	-1.54	-6.59	-8.88	-3.89
2500	-3.35	-3.98	-1.01	-8.23	-6.53	-3.72
5150	-1.64	-1.67	-0.29	-7.36	-8.43	-4.43
5250	-0.30	-2.97	-0.07	-7.54	-8.13	-4.32
5350	-0.70	-2.78	0.42	-7.82	-7.43	-4.05
5470	-0.13	-2.86	-0.08	-7.70	-8.24	-4.53
5600	-0.26	-2.43	1.22	-7.79	-8.46	-4.73
5725	-1.55	-2.14	-0.44	-9.28	-7.74	-4.93
5850	-0.32	-2.23	0.47	-7.34	-8.75	-4.61

WiFi aux antenna Gain						
Frequency (MHz)	Max value			Average		
	H-pol (dBi)	V pol (dBi)	Total(dBi) (H-pol+V-pol)	H-pol (dBi)	V pol (dBi)	Total(dBi) (H-pol+V-pol)
2400	0.30	-3.79	1.16	-6.89	-8.03	-3.97
2450	0.11	-5.01	0.74	-6.87	-9.51	-3.52
2500	-0.49	-5.11	-0.06	-7.72	-11.77	-3.81
5150	0.48	-0.35	1.66	-7.01	-6.76	-3.44
5250	0.30	-1.25	1.59	-7.28	-7.13	-3.75
5350	-0.41	-1.85	1.05	-7.53	-7.15	-3.89
5470	0.74	-3.13	1.56	-7.61	-7.70	-4.16
5600	-0.50	-1.94	-0.19	-7.98	-7.45	-4.16
5725	0.48	-0.02	0.82	-7.75	-7.52	-4.02
5850	0.31	-0.45	0.55	-7.15	-7.54	-3.65

Section 2. Dimensioned Photos or Drawings of Antennas

Include a dimensioned photo and dimensioned drawing of main antenna here.
WWAN + WiFi , Main + Aux Antenna Dimensioned Drawing:

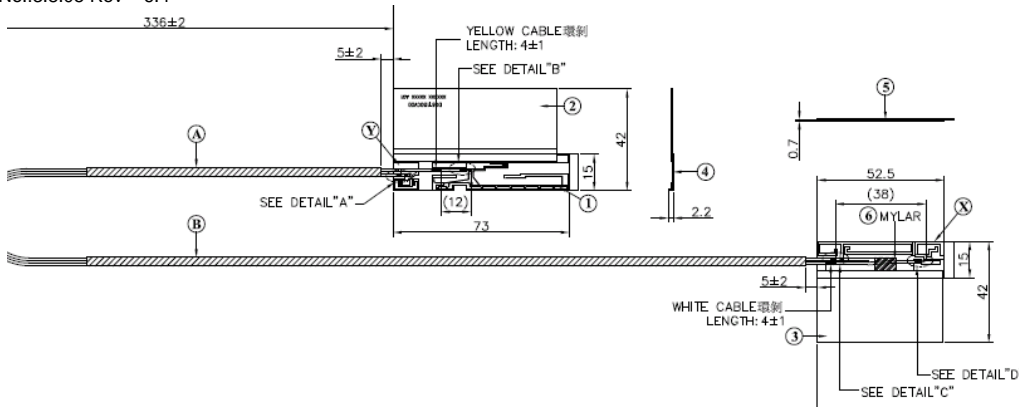

WWAN Main Antenna Photo:



WiFi Main Antenna Photo:



WWAN Aux Antenna Photo:

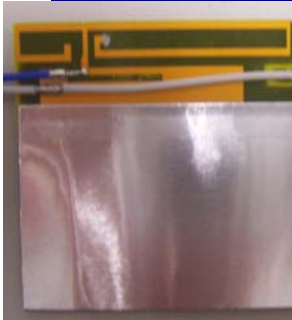

WiFi Aux Antenna Photo:



Section 3. Radiation characteristics of antennae Loaded in Host Platform

WWAN MAIN

WWAN Main antenna: 824 MHz

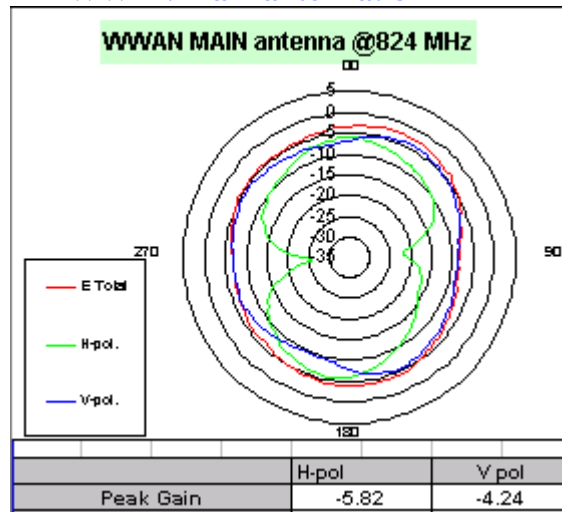

WWAN Main antenna: 836 MHz

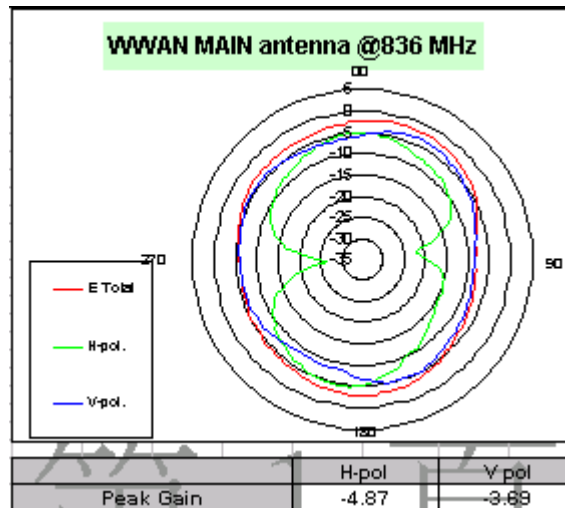

WWAN Main antenna: 849 MHz

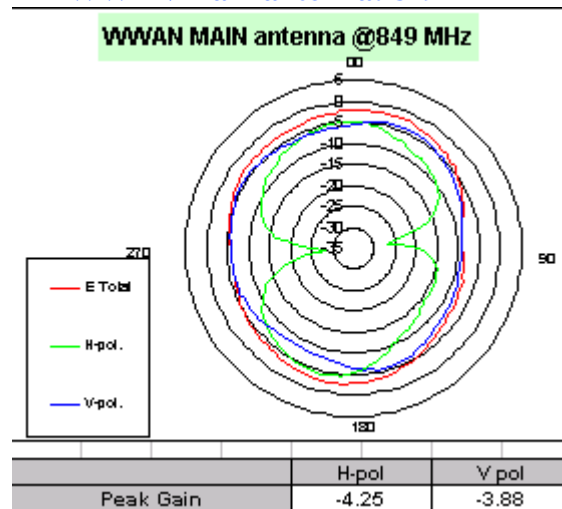

WWAN Main antenna: 869 MHz

WWAN MAIN antenna @869 MHz

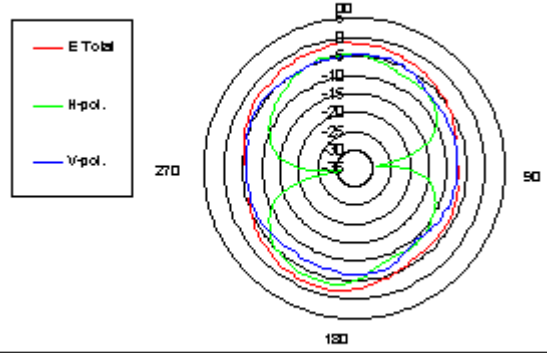

	H-pol	V-pol
Peak Gain	-3.39	-4.52

WWAN Main antenna: 880 MHz

WWAN MAIN antenna @880 MHz

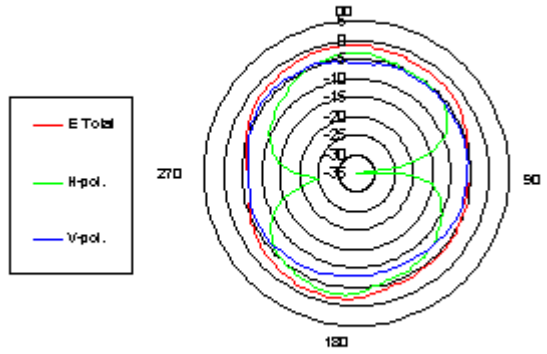

	H-pol	V-pol
Peak Gain	-2.80	-4.04

WWAN Main antenna: 894 MHz

WWAN MAIN antenna @894 MHz

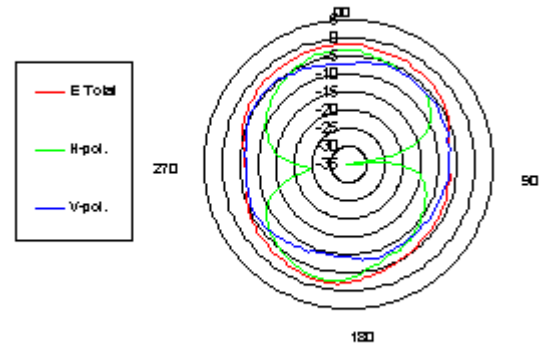

	H-pol	V-pol
Peak Gain	-2.39	-4.17

WWAN Main antenna: 900 MHz

WWAN MAIN antenna @900 MHz

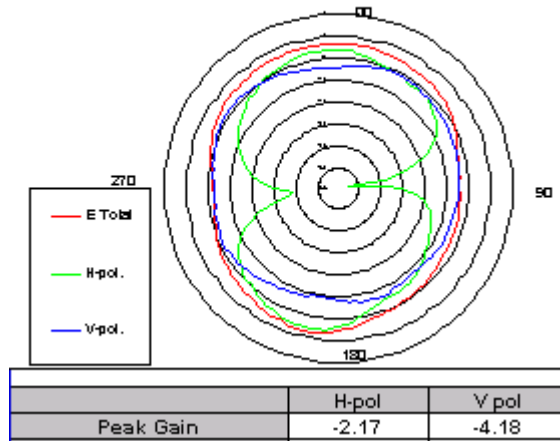

WWAN Main antenna: 915 MHz

WWAN MAIN antenna @915 MHz

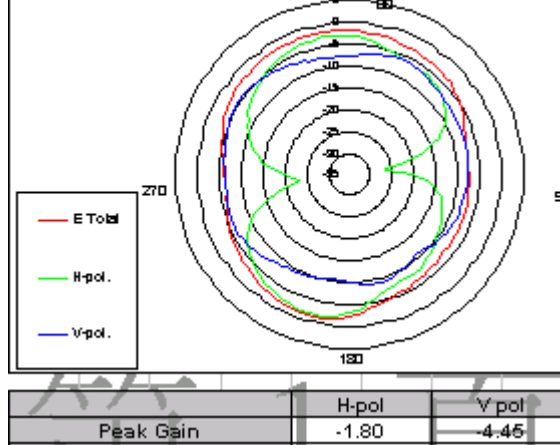

WWAN Main antenna: 925 MHz

WWAN MAIN antenna @925 MHz

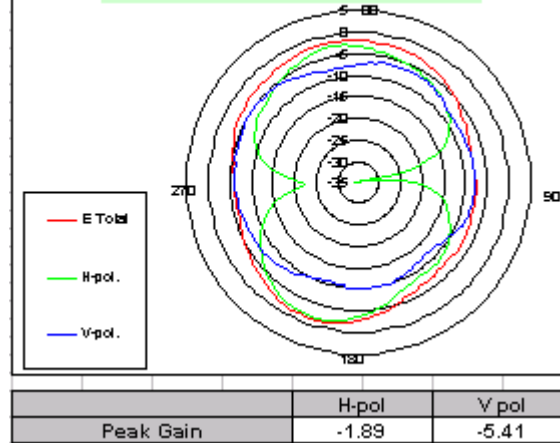

WWAN Main antenna: 940 MHz

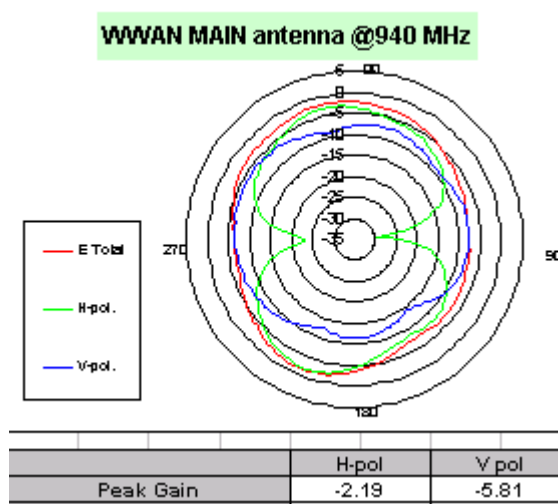

WWAN Main antenna: 960 MHz

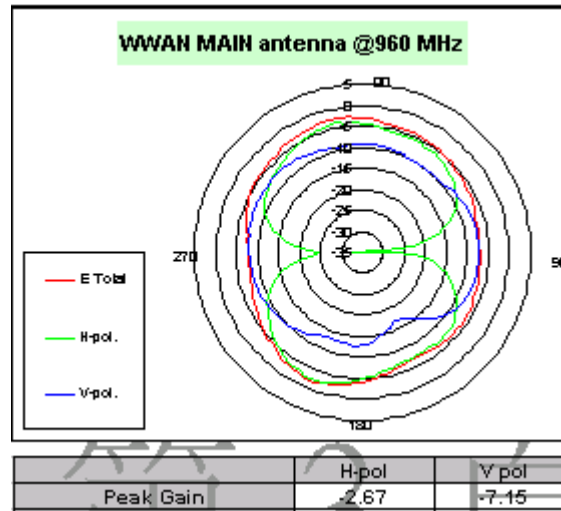

WWAN Main antenna: 1710 MHz

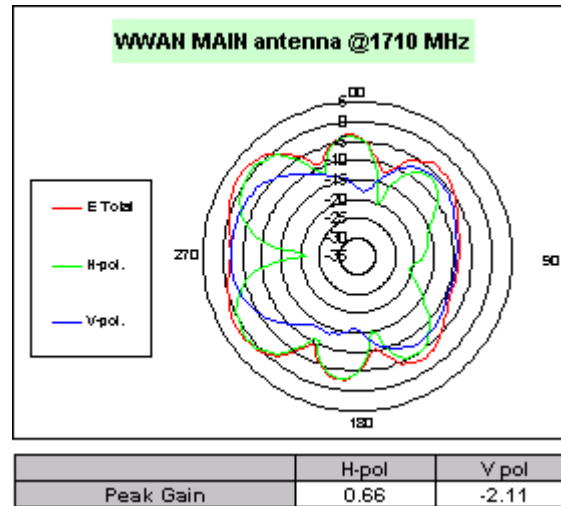

WWAN Main antenna: 1750 MHz

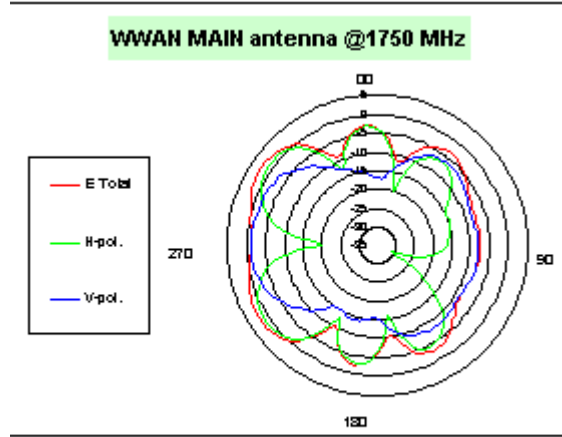

	H-pol	V-pol
Peak Gain	1.02	-1.36

WWAN Main antenna: 1785 MHz

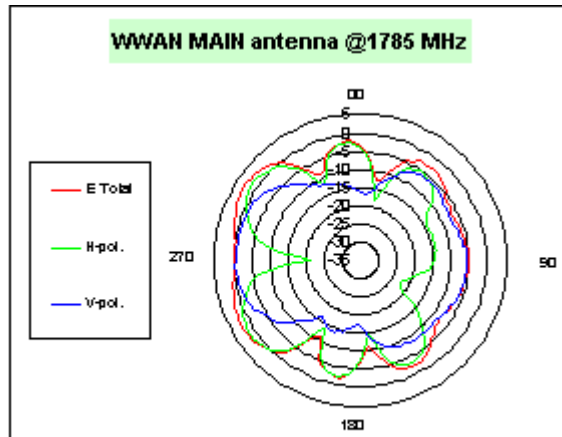

	H-pol	V-pol
Peak Gain	1.22	-0.75

WWAN Main antenna: 1805 MHz

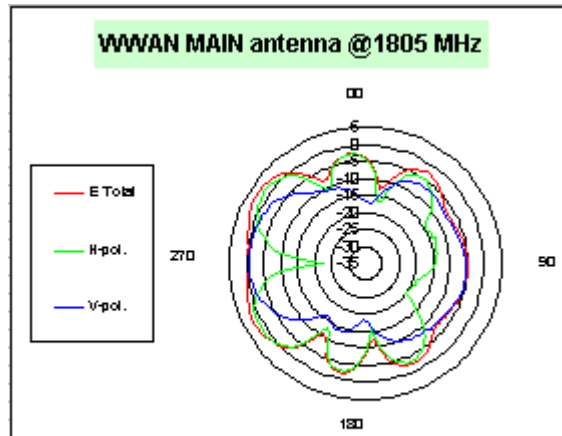

	H-pol	V-pol
Peak Gain	1.37	-0.80

WWAN Main antenna: 1840 MHz

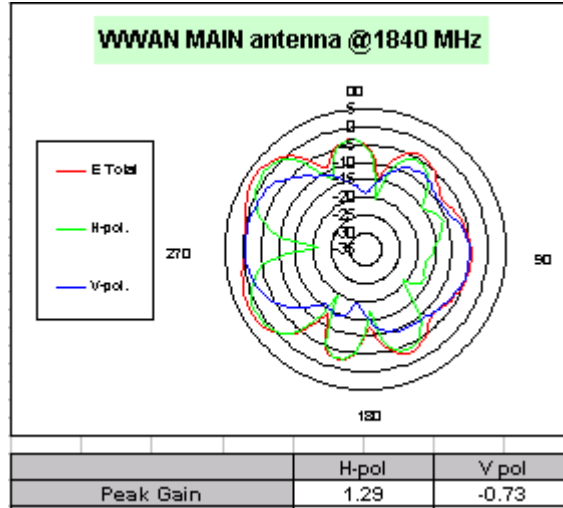

WWAN Main antenna: 1880 MHz

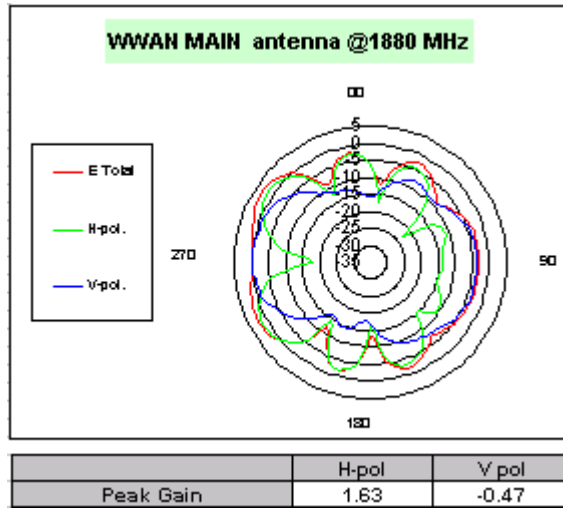

WWAN Main antenna: 1910 MHz

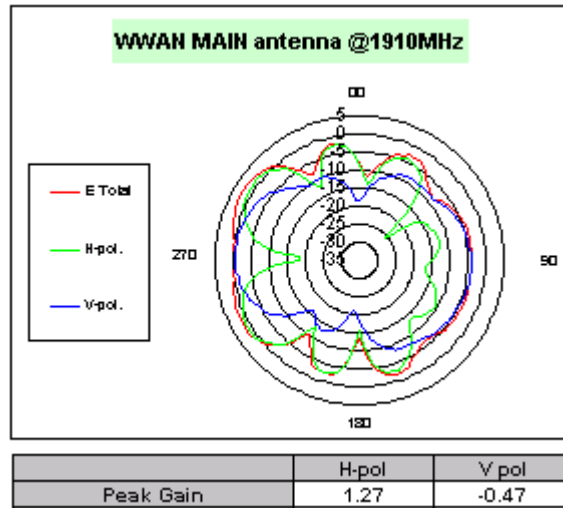

WWAN Main antenna: 1920 MHz

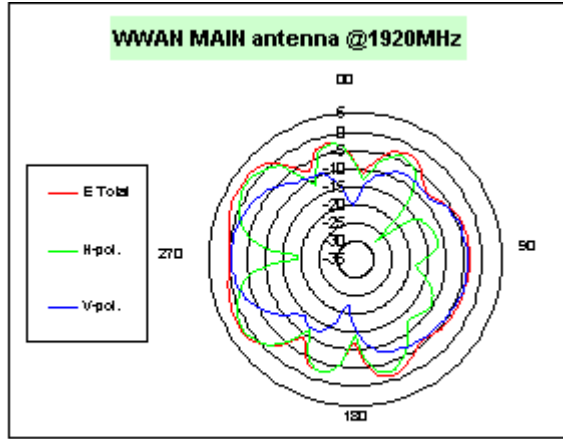

	H-pol	V-pol
Peak Gain	1.24	-0.76

WWAN Main antenna: 1930 MHz

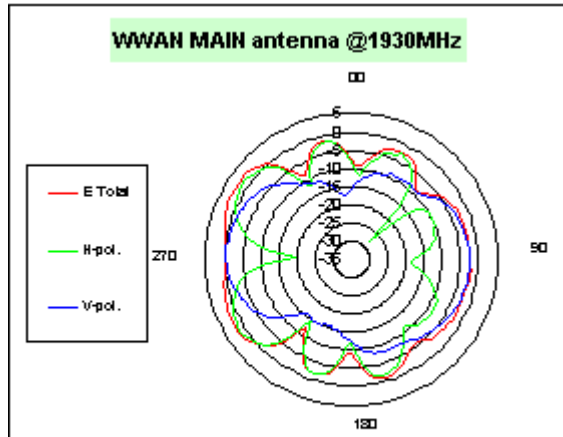

	H-pol	V-pol
Peak Gain	1.05	-0.70

WWAN Main antenna: 1960 MHz

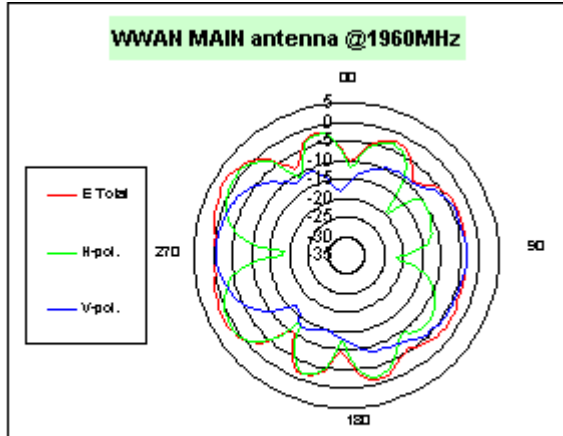

	H-pol	V-pol
Peak Gain	0.83	-0.79

WWAN Main antenna: 1990 MHz

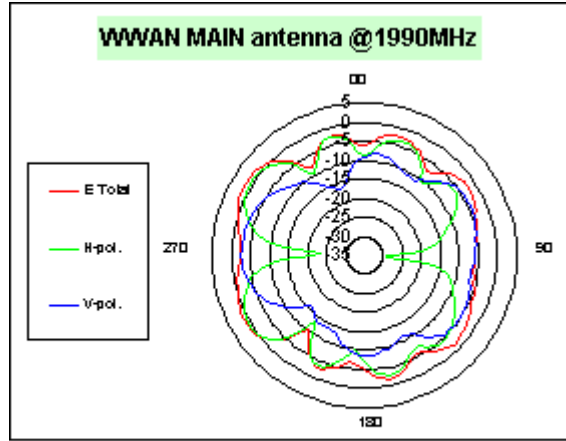

	H-pol	V pol
Peak Gain	0.57	-2.61

WWAN Main antenna: 2110 MHz

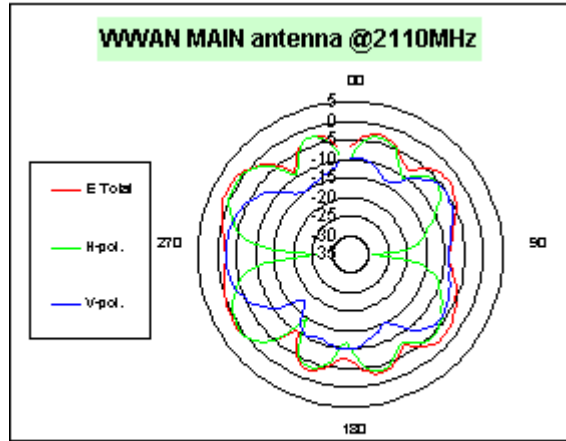

	H-pol	V pol
Peak Gain	0.51	-2.21

WWAN Main antenna: 2140 MHz

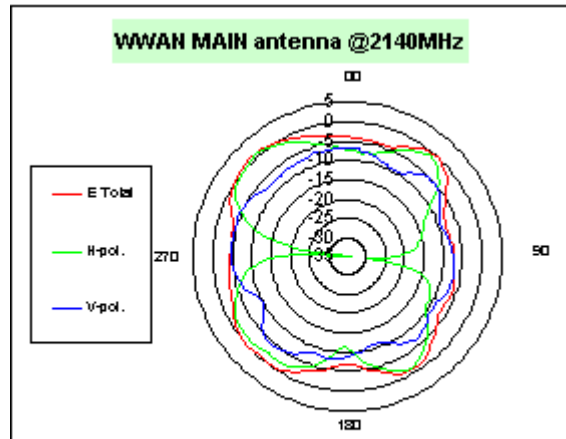

	H-pol	V pol
Peak Gain	0.29	-4.70

WWAN Main antenna: 2170 MHz

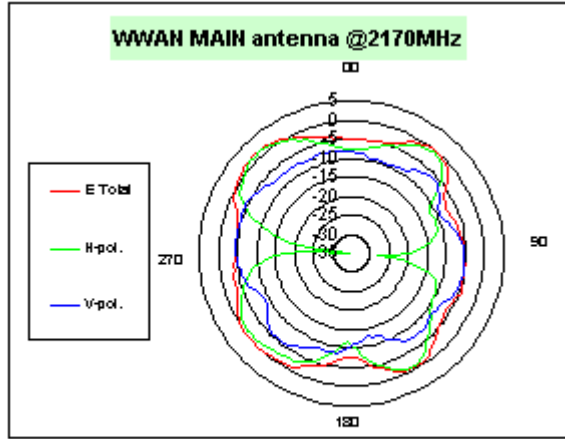

	H-pol	V-pol
Peak Gain	0.95	-4.39

WWAN AUX

WWAN Aux antenna: 869 MHz

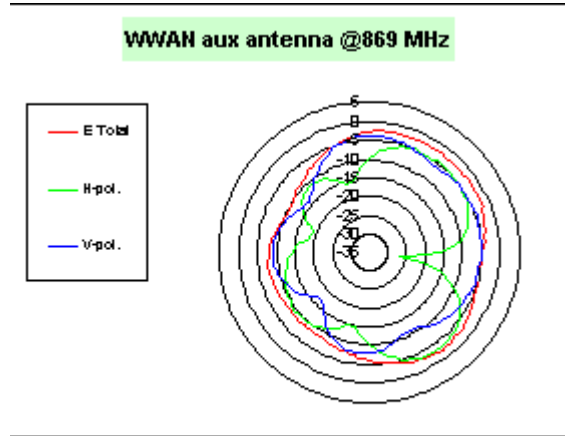

	H-pol	V-pol
Peak Gain	-3.50	-3.90

WWAN Aux antenna: 880 MHz

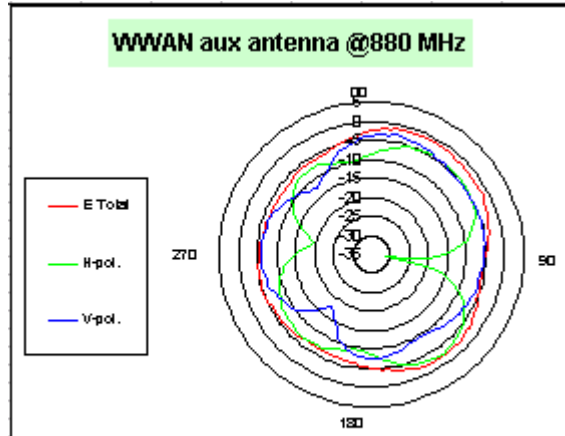

	H-pol	V-pol
Peak Gain	-3.05	-3.12

WWAN Aux antenna: 894 MHz

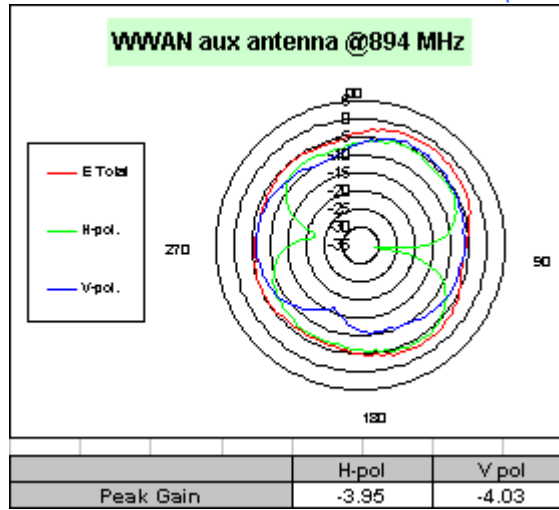

WWAN Aux antenna: 1930 MHz

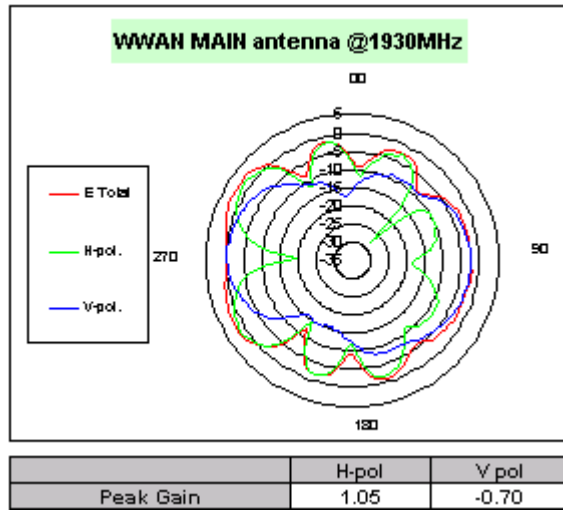

WWAN Aux antenna: 1960 MHz

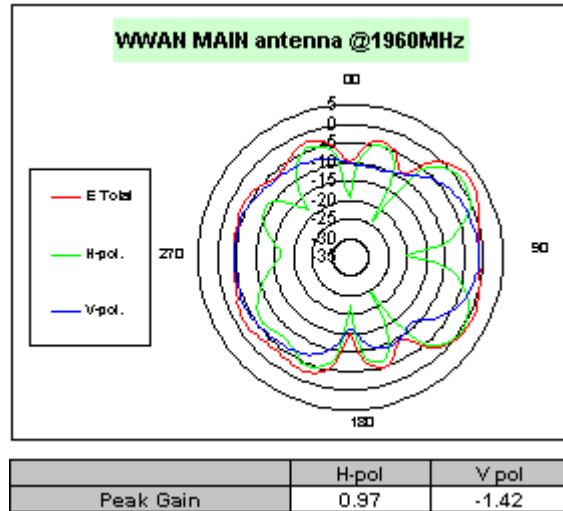

WWAN Aux antenna: 1990 MHz

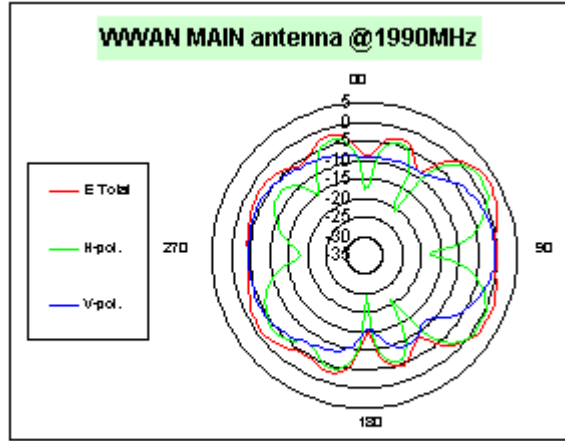

	H-pol	V pol
Peak Gain	1.58	-0.56

WWAN Aux antenna: 2110 MHz

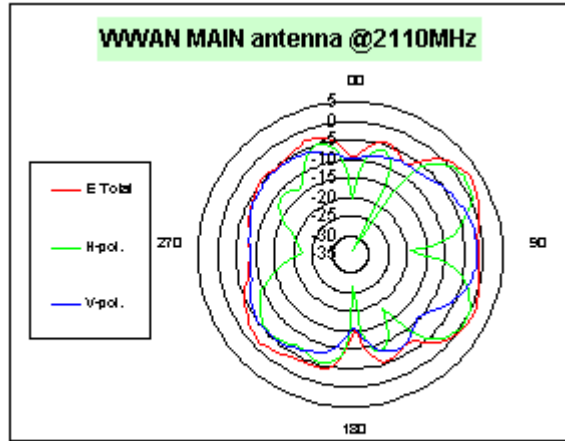

	H-pol	V pol
Peak Gain	1.15	-1.59

WWAN Aux antenna: 2140 MHz

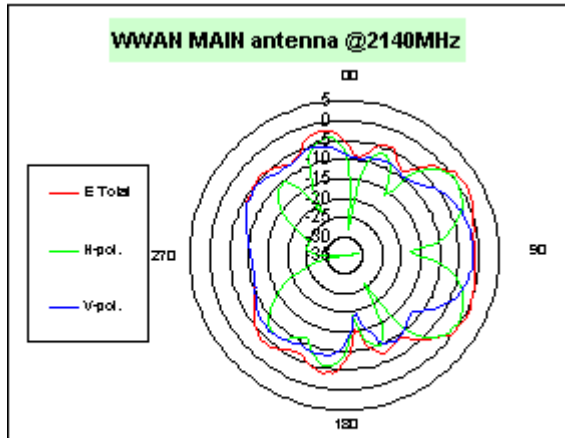

	H-pol	V pol
Peak Gain	-0.11	-1.54

WWAN Aux antenna: 2170 MHz

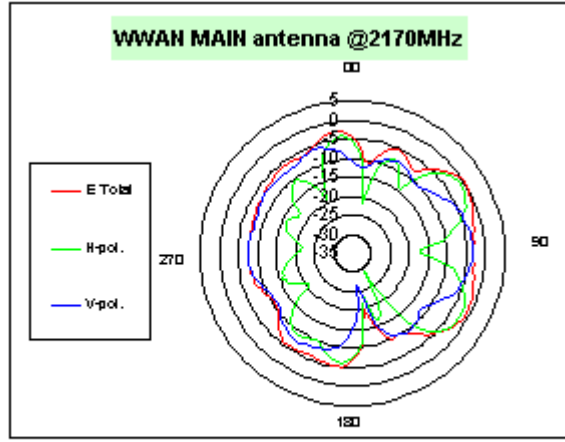

	H-pol	V pol
Peak Gain	-1.34	-3.40

WIFI MAIN

WIFI MAIN antenna: 2400 MHz

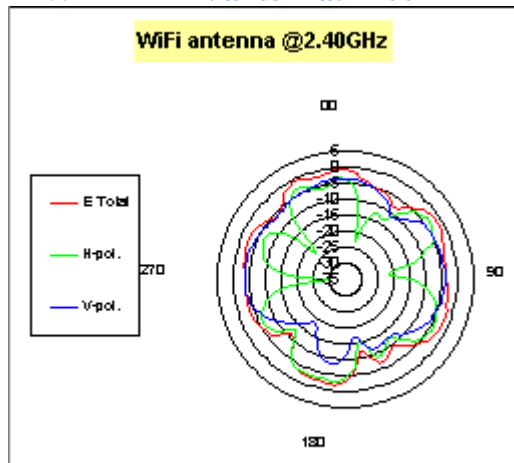

	Total	H-pol	V pol
Peak Gain	-0.45	-2.94	-3.57

WIFI MAIN antenna: 2450 MHz

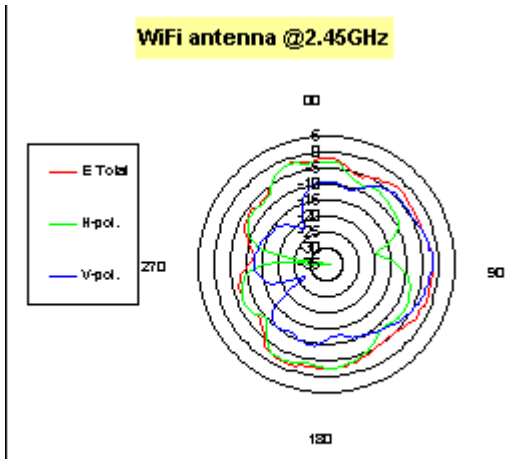

	Total	H-pol	V pol
Peak Gain	-1.54	-1.77	-2.03

WiFi MAIN antenna: 2500 MHz

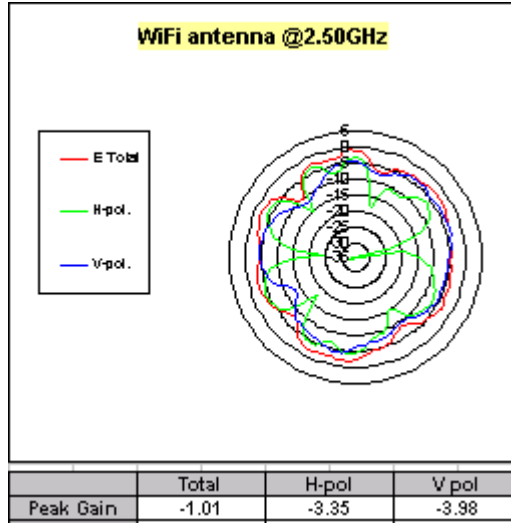

WiFi MAIN antenna: 5150 MHz

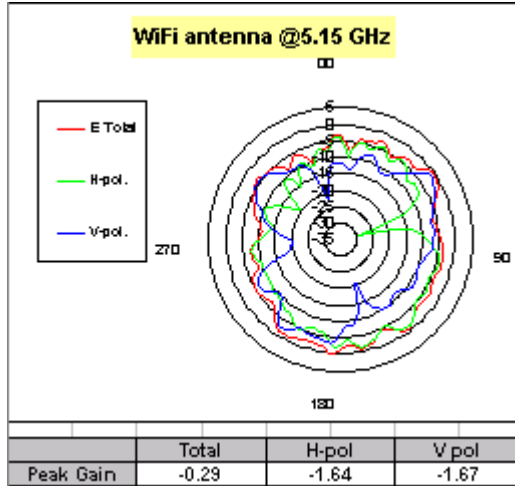

WiFi MAIN antenna: 5250 MHz

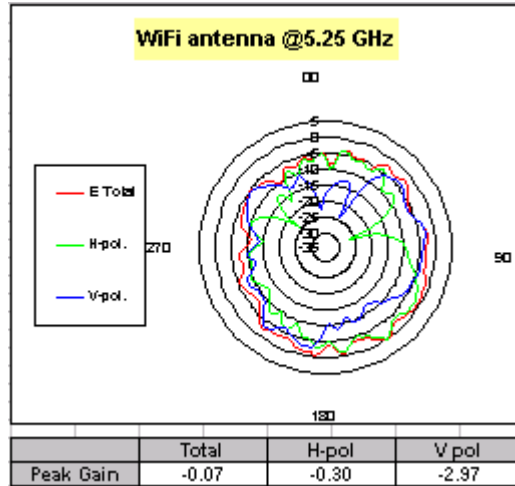

WiFi MAIN antenna: 5350 MHz

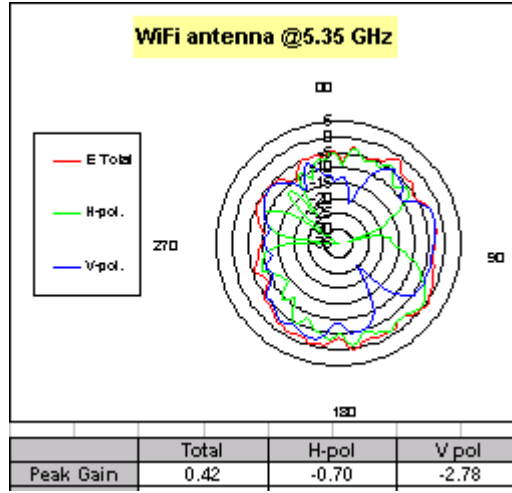

WiFi MAIN antenna: 5470 MHz

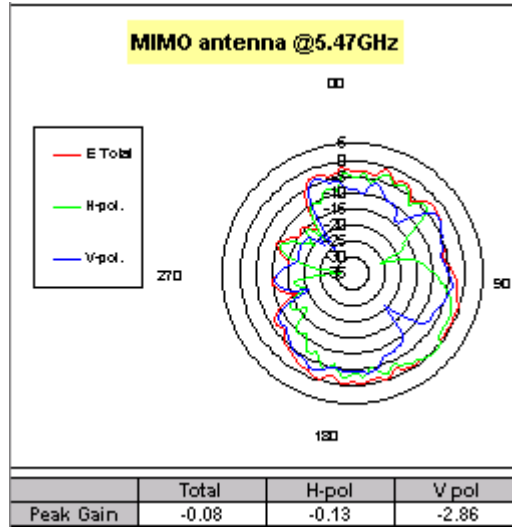

WiFi MAIN antenna: 5600 MHz

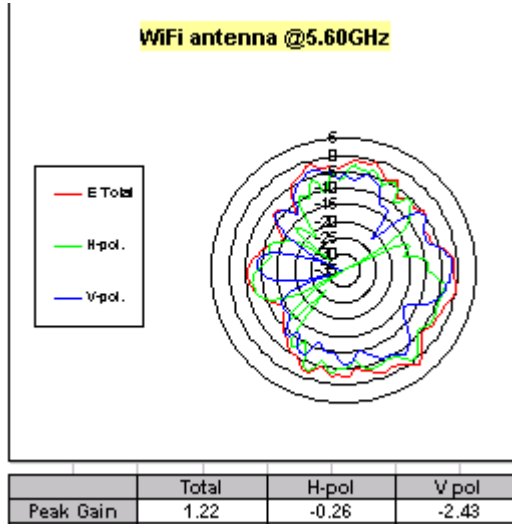

WiFi MAIN antenna: 5725 MHz

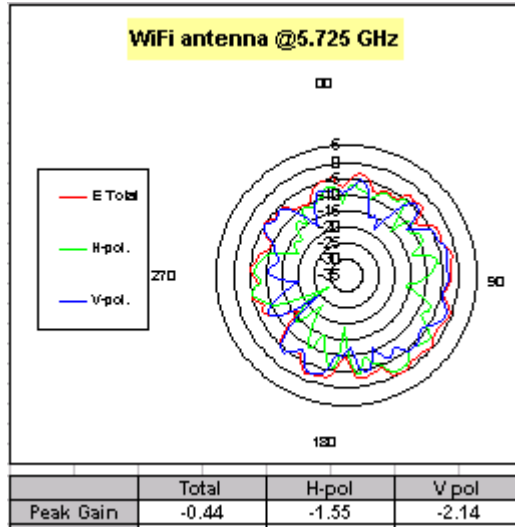

WiFi MAIN antenna: 5850 MHz

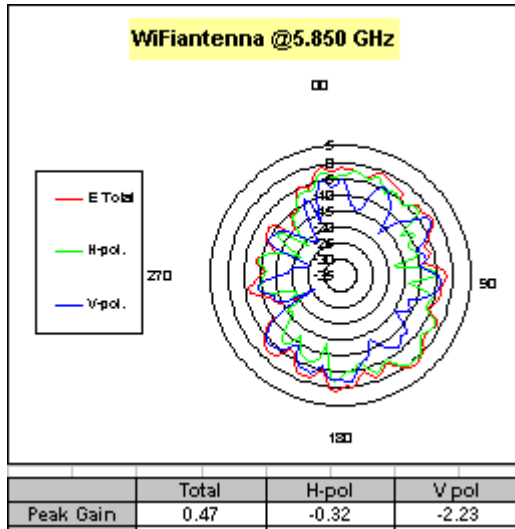

WLAN AUX

WiFi AUX antenna: 2400 MHz

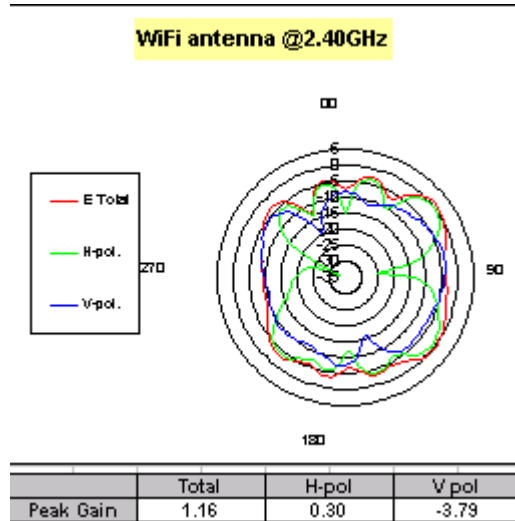

WiFi AUX antenna: 2450 MHz

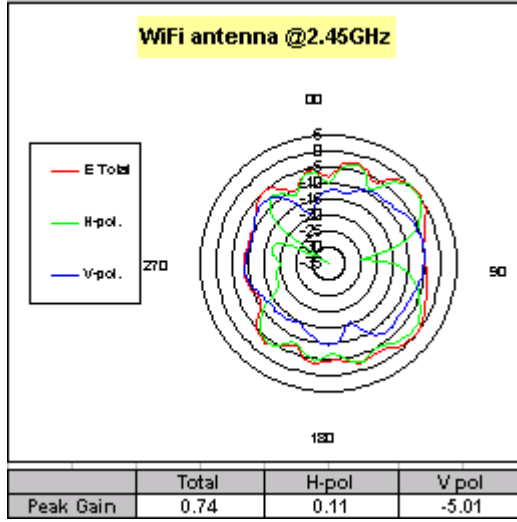

WiFi AUX antenna: 2500 MHz

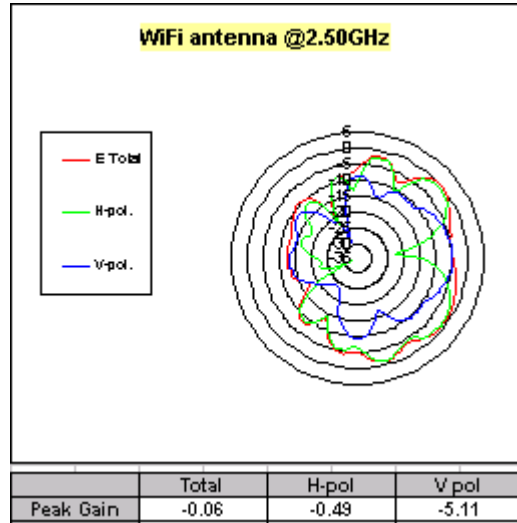

WiFi AUX antenna: 5150 MHz

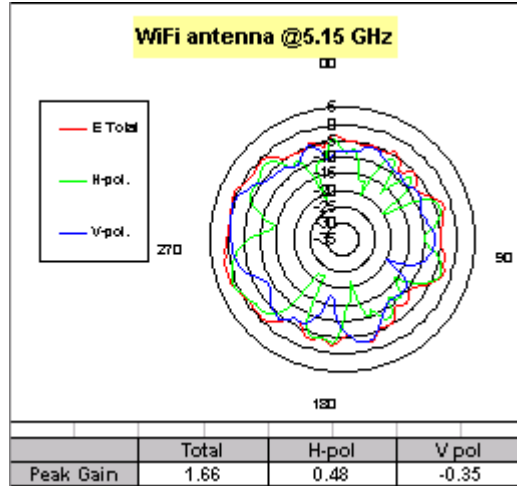

WiFi AUX antenna: 5250 MHz

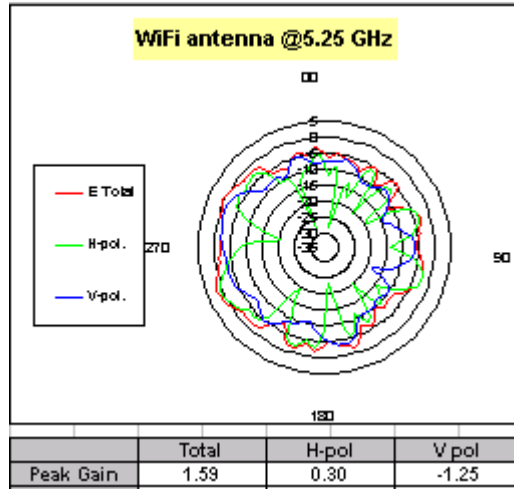

WiFi AUX antenna: 5350 MHz

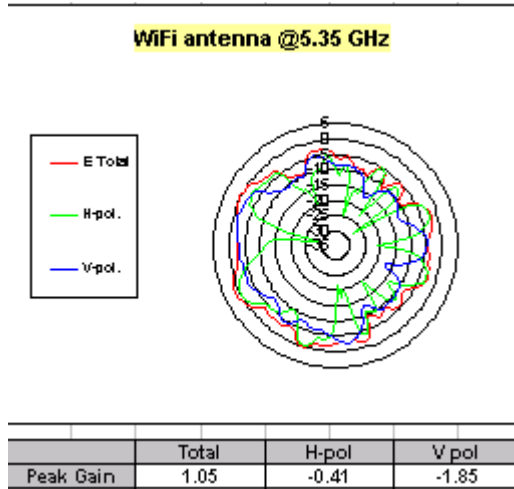

WiFi AUX antenna: 5470 MHz

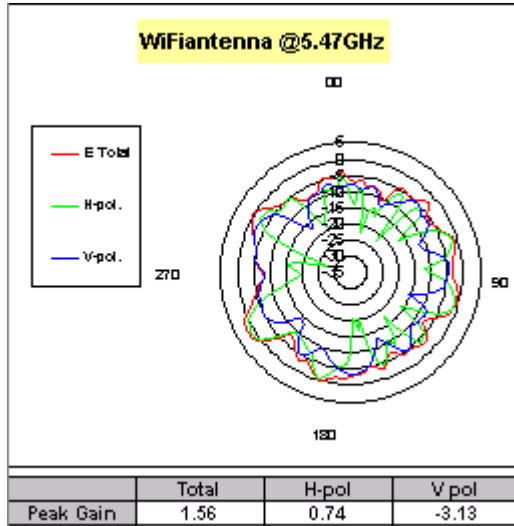

WiFi AUX antenna: 5600 MHz

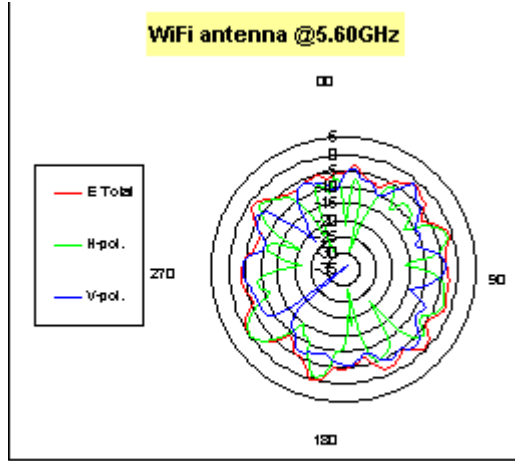

	Total	H-pol	V-pol
Peak Gain	-0.19	-0.50	-1.94

WiFi AUX antenna: 5725 MHz

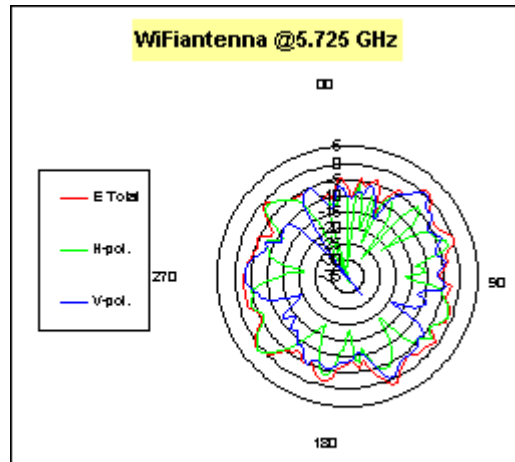

	Total	H-pol	V-pol
Peak Gain	0.82	0.48	-0.02

WiFi AUX antenna: 5850 MHz

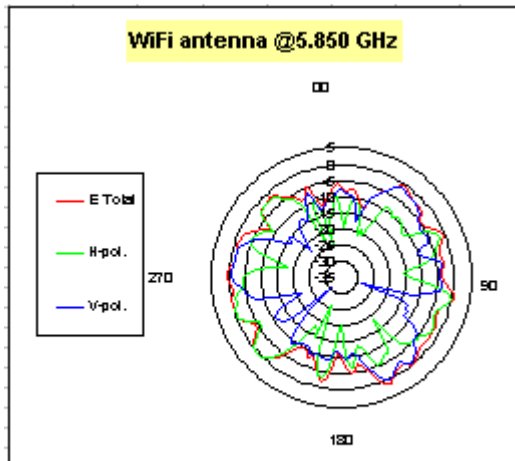

	Total	H-pol	V-pol
Peak Gain	0.55	0.31	-0.45