



A Test Lab Techno Corp.

Changan Lab : No. 140 -1, Changan Street, Bade City, Taoyuan County, Taiwan R.O.C.

Tel : 886-3-271-0188 / Fax : 886-3-271-0190

SAR EVALUATION REPORT



Test Report No.	: 0911FS12-01
Applicant	: Acer Incorporated
Product Type	: WLAN Module
Trade Name	: acer
Model Number	: 112BNHMW
Serial No.	: ZE90SK01C19391A23B2500
Dates of Test	: Nov. 05, 2009
Test Environment	: Ambient Temperature : $22 \pm 2^{\circ} \text{C}$ Relative Humidity : 40 - 70 %
Test Specification	: Standard C95.1-2005 IEEE Std. 1528-2003 2.1093;FCC/OET Bulletin 65 Supplement C [July 2001] KDB 248227 D01 SAR meas for 802.11 a b g v01r02 RSS-102 Issue 3 (June 2009) KDB 447498 "RF Exposure Procedures and Equipment Authorization Policies"
Max. SAR	: 0.339 W/kg Body SAR
Test Lab Location	: Chang-an Lab



1. The test operations have to be performed with cautious behavior, the test results are as attached.
2. The test results are under chamber environment of A Test Lab Techno Corp. A Test Lab Techno Corp. does not assume responsibility for any conclusions and generalizations drawn from the test results with regard to other specimens or samples.
3. The measurement report has to be written approval of A Test Lab Techno Corp. It may only be reproduced or published in full. This report shall not be reproduced except in full, without the written approval of A Test Lab Techno Corp.
4. This document may be altered or revised by A Test Lab Techno Corp. personnel only, and shall be noted in the revision section of the document.

Sam Chuang
Approve Signer

20091119

Alex Wu
Testing Engineer

20091119



Contents

1. Description of Equipment Under Test (EUT)	3
2. Introduction	4
3. SAR Definition	4
4. SAR Measurement Setup	5
5. System Components	7
6. Test Equipment List	15
7. Tissue Simulating Liquids	16
8. Measurement Process	19
9. Measurement Uncertainty	25
10. SAR Test Results Summary	27
11. Conclusion	33
12. References	33
Appendix A - System Performance Check	34
Appendix B - SAR Measurement Data	36
Appendix C - Calibration	43



1. **Description of Equipment Under Test (EUT)**

Applicant	:	Acer Incorporated
Applicant Address	:	8F, 88, Sec.1, Hsin Tai Wu Rd. Hsichih, Taipei Hsien 221 Taiwan, R.O.C.
Manufacturer	:	Quanta Computer Inc.
Manufacturer Address	:	No.211, Wen Hwa 2nd Rd., Kuei Shan Hsiang, Tao Yuan Shien, Taiwan, R.O.C.
Product Type	:	WLAN Module
Trade Name	:	acer
Model Number	:	112BNHMW
Serial No.	:	ZE90SK01C19391A23B2500
FCC ID	:	HLZ112BNH
IC ID	:	1754F-112BNH
Test Device	:	Production Unit
Tx Frequency	:	IEEE 802.11b / IEEE 802.11g: 2412MHz~2462MHz Draft 802.11n 2.4GHz Standard-20MHz: 2412MHz~2462MHz Draft 802.11n 2.4GHz Wide-40MHz: 2422MHz~2452MHz
RF Conducted Power (Avg.)	:	IEEE 802.11b: 0.044W (16.47 dBm) IEEE 802.11g: 0.046 W (16.60 dBm) Draft 802.11n 2.4GHz Standard-20MHz: 0.043 W (16.38 dBm) Draft 802.11n 2.4GHz Wide-40MHz: 0.016 W (11.95 dBm)
Max. SAR Measurement	:	0.339 W/kg Body SAR
HW Version	:	D2A
SW Version	:	V0.2103
Antenna Type	:	PIFA Type
Antenna Gain	:	IEEE 802.11b / IEEE 802.11g: -1.77 dBi Draft 802.11n Standard-20MHz: -1.77 dBi Draft 802.11n Wide-40MHz: -1.77 dBi
Device Category	:	Portable
RF Exposure Environment	:	General Population / Uncontrolled
Battery Option	:	Standard
Application Type	:	Certification
Host Laptop PC	:	Trade Name: acer, Gateway, Packard Bell Model Number: ZE8

This wireless portable device has been shown to be capable of compliance for localized specific absorption rate (SAR) for uncontrolled environment / general population exposure limits specified in Standard C95.1-2005 / RSS-102 Issue 3 (June 2009) and had been tested in accordance with the measurement procedures specified in IEEE Std. 1528-2003.



2. Introduction

The A Test Lab Techno Corp. has performed measurements of the maximum potential exposure to the user of **Acer Incorporated Trade Name : acer Model(s) : 112BNHMW**. The test procedures, as described in American National Standards, Institute C95.1 - 2005 [1] , FCC/OET Bulletin 65 Supplement C [July 2001] and RSS-102 Issue 3 (June 2009) were employed and they specify the maximum exposure limit of 1.6mW/g as averaged over any 1 gram of tissue for portable devices being used within 20cm between user and EUT in the uncontrolled environment. A description of the product and operating configuration, detailed summary of the test results, methodology and procedures used in the equipment used are included within this test report.

3. SAR Definition

Specific Absorption Rate (SAR) is defined as the time derivative (rate) of the incremental energy (dw) absorbed by (dissipated in) an incremental mass (dm) contained in a volume element (dv) of a given density (ρ). It is also defined as the rate of RF energy absorption per unit mass at a point in an absorbing body (see Figure 2).

$$SAR = \frac{d}{dt} \left(\frac{dw}{dm} \right) = \frac{d}{dt} \left(\frac{dw}{\rho dv} \right)$$

Figure 2. SAR Mathematical Equation

SAR is expressed in units of Watts per kilogram (W/kg)

$$SAR = \frac{\sigma E^2}{\rho}$$

Where :

σ = conductivity of the tissue (S/m)

ρ = mass density of the tissue (kg/m³)

E = RMS electric field strength (V/m)

* **Note** :

The primary factors that control rate of energy absorption were found to be the wavelength of the incident field in relations to the dimensions and geometry of the irradiated organism, the orientation of the organism in relation to the polarity of field vectors, the presence of reflecting surfaces, and whether conductive contact is made by the organism with a ground plane [2]



4. SAR Measurement Setup

These measurements were performed with the automated near-field scanning system DASY5 from Schmid & Partner Engineering AG (SPEAG). The system is based on a high precision robot (working range greater than 0.9m) which positions the probes with a positional repeatability of better than $\pm 0.02\text{mm}$. Special E- and H-field probes have been developed for measurements close to material discontinuity, the sensors of which are directly loaded with a Schottky diode and connected via highly resistive lines (length = 300mm) to the data acquisition unit.

A cell controller system contains the power supply, robot controller, teach pendant (Joystick), and remote control, is used to drive the robot motors. The Measurement Server is based on a PC/104 CPU board with a 400MHz intel ULV Celeron, 128MB chipdisk and 128MB RAM. The necessary circuits for communication with either the DAE4 (or DAE3) electronic box as well as the 16-bit AD-converter system for optical detection and digital I/O interface are contained on the DASY5 I/O-board, which is directly connected to the PC/104 bus of the CPU board. The PC consists of the Intel Core(TM)2 CPU @1.86GHz computer with Windows XP system and SAR Measurement Software DASY5, Post Processor SEMCAD, monitor, mouse, and keyboard. The Staubli Robot is connected to the cell controller to allow software manipulation of the robot. A data acquisition electronic (DAE) circuit performs the signal amplification, signal multiplexing, AD-conversion, offset measurements, mechanical surface detection, collision detection...etc. is connected to the Electro-optical converter (EOC). The EOC performs the conversion from the optical into digital electric signal of the DAE and transfers data to the Measurement Server.

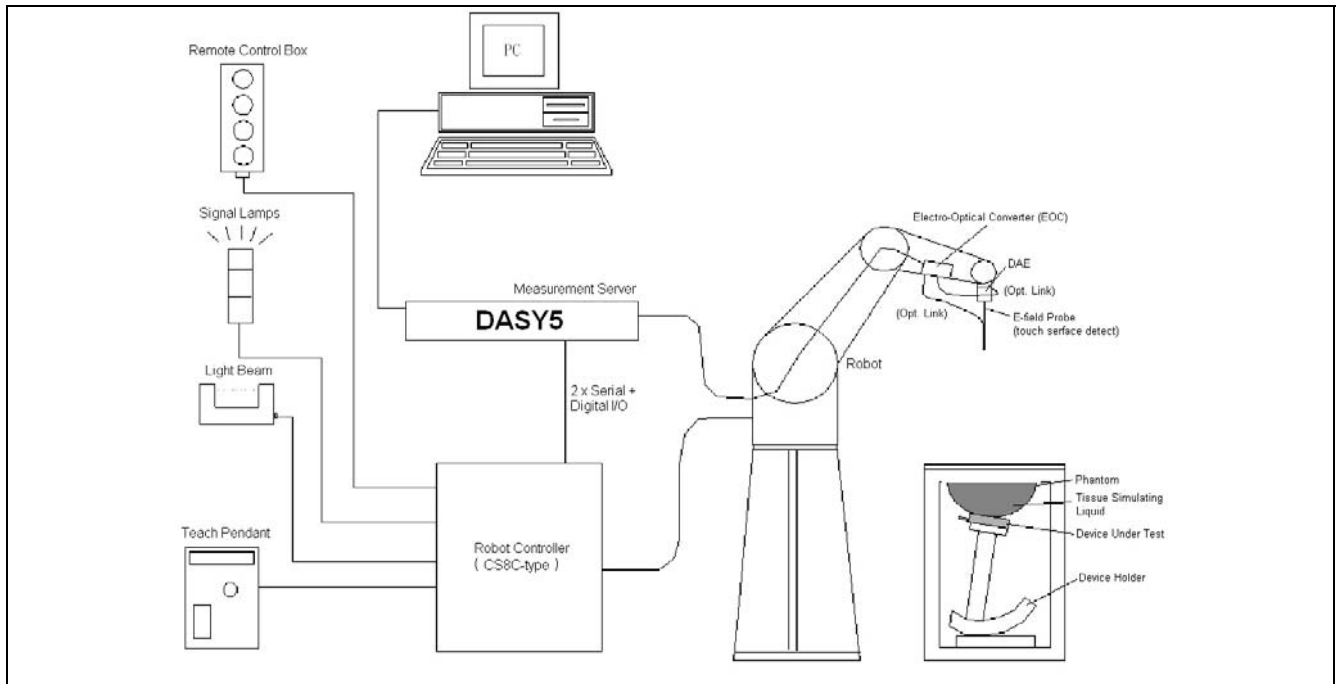

Figure 3. SAR Lab Test Measurement Setup

The DAE4 (or DAE3) consists of a highly sensitive electrometer-grade preamplifier with auto-zeroing, a channel and gain-switching multiplexer, a fast 16 bit AD-converter and a command decoder and control logic unit. Transmission to the PC-card is accomplished through an optical downlink for data and status information and an optical uplink for commands and clock lines. The mechanical probe mounting device includes two different sensor systems for frontal and sidewise probe contacts. They are also used for mechanical surface detection and probe collision detection. The robot uses its own controller with a built in VME-bus computer. The system is described in detail in [3] .



5. System Components

5.1 DASYS E-Field Probe System

The SAR measurements were conducted with the dosimetric probe ES3DV3 or ET3DV6 (manufactured by SPEAG), designed in the classical triangular configuration [3] and optimized for dosimetric evaluation. The probe is constructed using the thick film technique; with printed resistive lines on ceramic substrates. The probe is equipped with an optical multi-fiber line ending at the front of the probe tip. It is connected to the EOC box on the robot arm and provides an automatic detection of the phantom surface. Half of the fibers are connected to a pulsed infrared transmitter, the other half to a synchronized receiver. As the probe approaches the surface, the reflection from the surface produces a coupling from the transmitting to the receiving fibers. This reflection increases first during the approach, reaches maximum and then decreases. If the probe is flatly touching the surface, the coupling is zero. The distance of the coupling maximum to the surface is independent of the surface reflectivity and largely independent of the surface to probe angle. The DASYS software reads the reflection during a software approach and looks for the maximum using a 2nd order fitting. The approach is stopped when reaching the maximum.

5.1.1 E-Field Probe Specification

Construction	<p>Symmetrical design with triangular core</p> <p>Built-in optical fiber for surface detection System</p> <p>Built-in shielding against static charges</p> <p>PEEK enclosure material</p> <p>(resistant to organic solvents, e.q., glycol)</p>
Calibration	<p>In air from 10 MHz to 6 GHz</p> <p>In brain and muscle simulating tissue at frequencies of 2450MHz (accuracy $\pm 8\%$)</p> <p>Calibration for other liquids and frequencies upon request</p>
Frequency	<p>10 MHz to > 6 GHz; Linearity: ± 0.2 dB</p> <p>(30 MHz to 3 GHz)</p>
Directivity	<p>± 0.3 dB in brain tissue (rotation around probe axis)</p> <p>± 0.5 dB in brain tissue (rotation normal probe axis)</p>
Dynamic Range	<p>10 μ W/g to > 100mW/g; Linearity: ± 0.2dB</p>
Surface Detection	<p>± 0.2 mm repeatability in air and clear liquids over diffuse reflecting surface</p>
Dimensions	<p>Overall length: 330mm</p> <p>Tip length: 20mm</p> <p>Body diameter: 12mm</p> <p>Tip diameter: 2.5mm</p> <p>Distance from probe tip to dipole centers: 1.0mm</p>
Application	<p>General dosimetry up to 6GHz</p> <p>Compliance tests of mobile phones</p> <p>Fast automatic scanning in arbitrary phantoms</p>



Figure 4. E-field Probe



Figure 5. Probe setup on robot



5.1.2 E-Field Probe Calibration

Each probe is calibrated according to a dosimetric assessment procedure described in [4] with accuracy better than $\pm 10\%$. The spherical isotropy was evaluated with the procedure described in [5] and found to be better than $\pm 0.25\text{dB}$. The sensitivity parameters (NormX, NormY, and NormZ), the diode compression parameter (DCP) and the conversion factor (ConvF) of the probe are tested.

The free space E-field from amplified probe outputs is determined in a test chamber. This is performed in a TEM cell for frequencies below 1GHz, and in a wave guide above 1GHz for free space. For the free space calibration, the probe is placed in the volumetric center of the cavity and at the proper orientation with the field. The probe is then rotated 360 degrees.

E-field temperature correlation calibration is performed in a flat phantom filled with the appropriate simulated brain tissue. The measured free space E-field in the medium correlates to temperature rise in a dielectric medium. For temperature correlation calibration a RF transparent thermistor-based temperature probe is used in conjunction with the E-field probe.

$$\text{SAR} = C \frac{\Delta T}{\Delta t}$$

Where :

Δt = Exposure time (30 seconds),

C = Heat capacity of tissue (head or body),

ΔT = Temperature increase due to RF exposure.

Or

$$\text{SAR} = \frac{|E|^2 \sigma}{\rho}$$

Where :

σ = Simulated tissue conductivity,

ρ = Tissue density (kg/m^3).



5.2 Data Acquisition Electronic (DAE) System

Cell Controller

Processor : Intel Core(TM)2 CPU
Clock Speed : @ 1.86GHz
Operating System : Windows XP Professional

Data Converter

Features : Signal Amplifier, multiplexer, A/D converter, and control logic
Software : DASY5 v5.0 (Build 125) & SEMCAD X Version 13.4 Build 125
Connecting Lines : Optical downlink for data and status info
Optical uplink for commands and clock

5.3 Robot

Positioner : Stäubli Unimation Corp. Robot Model: TX90XL
Repeatability : ± 0.02 mm
No. of Axis : 6

5.4 Measurement Server

Processor : PC/104 with a 400MHz intel ULV Celeron
I/O-board : Link to DAE4(or DAE3)
16-bit A/D converter for surface detection system
Digital I/O interface
Serial link to robot
Direct emergency stop output for robot

5.5 Device Holder for Transmitters

In combination with the SAM Twin Phantom V4.0, the Mounting Device (POM) enables the rotation of the mounted transmitter in spherical coordinates whereby the rotation points is the ear opening. The devices can be easily, accurately, and repeat ably positioned according to the IEEE SCC34-SC2 and CENELEC specifications. The device holder can be locked at different phantom locations (left head, right head, and flat phantom).

***Note :** A simulating human hand is not used due to the complex anatomical and geometrical structure of the hand that may produced infinite number of configurations [6] . To produce the worst-case condition (the hand absorbs antenna output power), the hand is omitted during the tests.

Larger DUT cannot be tested using this device holder. Instead a support of bigger polystyrene cubes and thin polystyrene plates is used to position the DUT in all relevant positions to find and measure spots with maximum SAR values. Therefore those devices are normally only tested at the flat part of the SAM.



Figure 6. Device Holder

5.6 Phantom - SAM v4.0

The shell corresponds to the specifications of the Specific Anthropomorphic Mannequin (SAM) phantom defined in IEEE 1528-2003, CENELEC 50361 and IEC 62209. It enables the dosimetric evaluation of left and right hand phone usage as well as body mounted usage at the flat phantom region. A cover prevents evaporation of the liquid. Reference markings on the phantom allow the complete setup of all predefined phantom positions and measurement grids by manually teaching three points with the robot.

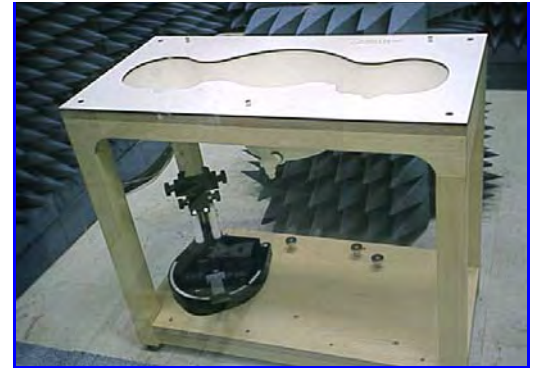

Figure 7. SAM Twin Phantom

Shell Thickness	2 ±0.2 mm
Filling Volume	Approx. 25 liters
Dimensions	810×1000×500 mm (H×L×W)

Table 1. Specification of SAM v4.0

5.7 Data Storage and Evaluation

5.7.1 Data Storage

The DASY5 software stores the assessed data from the data acquisition electronics as raw data (in microvolt readings from the probe sensors), together with all the necessary software parameters for the data evaluation (probe calibration data, liquid parameters and device frequency and modulation data) in measurement files with the extension .DA4. The post processing software evaluates the desired unit and format for output each time the data is visualized or exported. This allows verification of the complete software setup even after the measurement and allows correction of erroneous parameter settings. For example, if a measurement has been performed with an incorrect crest factor parameter in the device setup, the parameter can be corrected afterwards and the data can be reevaluated.

5.7.2 Data Evaluation

The DASY5 post processing software (SEMCAD) automatically executes the following procedures to calculate the field units from the microvolt readings at the probe connector. The parameters used in the evaluation are stored in the configuration modules of the software :

Probe parameters :	- Sensitivity	Normi, ai0, ai1, ai2
	- Conversion factor	ConvFi
	- Diode compression point	dcp _i
Device parameters :	- Frequency	f
	- Crest factor	cf
Media parameters :	- Conductivity	σ
	- Density	ρ

These parameters must be set correctly in the software. They can be found in the component documents or they can be imported into the software from the configuration files issued for the DASY components. In the direct measuring mode of the multimeter option, the parameters of the actual system setup are used. In the scan visualization and export modes, the parameters stored in the corresponding document files are used.

The first step of the evaluation is a linearization of the filtered input signal to account for the compression characteristics of the detector diode. The compensation depends on the input signal, the diode type and the DC-transmission factor from the diode to the evaluation electronics. If the exciting field is pulsed, the crest factor of the signal must be known to correctly compensate for peak power. The formula for each channel can be given as :

$$V_i = U_i + U_i^2 \cdot \frac{cf}{dcp_i}$$

- with
- V_i = compensated signal of channel i ($i = x, y, z$)
 - U_i = input signal of channel i ($i = x, y, z$)
 - cf = crest factor of exciting field (DASY parameter)
 - dcp_i = diode compression point (DASY parameter)

From the compensated input signals the primary field data for each channel can be evaluated :

E-field probes :

$$E_i = \sqrt{\frac{V_i}{Norm_i \cdot ConvF}}$$



H-field probes :

$$H_i = \sqrt{V_i} \cdot \frac{a_{i0} + a_{i1}f + a_{i2}f^2}{f}$$

- with V_i = compensated signal of channel i ($i = x, y, z$)
 $Norm_i$ = sensor sensitivity of channel i ($i = x, y, z$)
 $\mu V/(V/m)^2$ for E-field Probes
 $ConvF$ = sensitivity enhancement in solution
 a_{ij} = sensor sensitivity factors for H-field probes
 f = carrier frequency [GHz]
 E_i = electric field strength of channel i in V/m
 Hi = magnetic field strength of channel i in A/m

The RSS value of the field components gives the total field strength (Hermitian magnitude) :

$$E_{tot} = \sqrt{E_x^2 + E_y^2 + E_z^2}$$

The primary field data are used to calculate the derived field units.

$$SAR = E_{tot}^2 \cdot \frac{\sigma}{\rho \cdot 1000}$$

- with SAR = local specific absorption rate in mW/g
 E_{tot} = total field strength in V/m
 σ = conductivity in [mho/m] or [Siemens/m]
 ρ = equivalent tissue density in g/cm^3

***Note :** That the density is set to 1, to account for actual head tissue density rather than the density of the tissue simulating liquid.

The power flow density is calculated assuming the excitation field to be a free space field.

$$P_{pwe} = \frac{E_{tot}^2}{3770} \quad \text{or} \quad P_{pwe} = \frac{H_{tot}^2}{37.7}$$

- with P_{pwe} = equivalent power density of a plane wave in mW/cm^2
 E_{tot} = total electric field strength in V/m
 H_{tot} = total magnetic field strength in A/m



6. Test Equipment List

Manufacturer	Name of Equipment	Type/Model	Serial Number	Calibration	
				Last Cal.	Due Date
SPEAG	Dosimetric E-Field Probe	ES3DV3	3150	Jan. 20, 2009	Jan. 20, 2010
SPEAG	2450MHz System Validation Kit	D2450V2	712	Feb. 11, 2009	Feb. 11, 2010
SPEAG	Data Acquisition Electronics	DAE4	779	Nov. 11, 2008	Nov. 11, 2009
SPEAG	Device Holder	N/A	N/A	NCR	NCR
SPEAG	Phantom	SAM V4.0	TP-1150	NCR	NCR
SPEAG	Robot	Staubli TX90XL	F07/564ZA1/C/01	NCR	NCR
SPEAG	Software	DASY5 V5.0 Build 125	N/A	NCR	NCR
SPEAG	Software	SEMCAD X V13.4 Build 125	N/A	NCR	NCR
SPEAG	Measurement Server	SE UMS 011 AA	1025	NCR	NCR
R&S	Wireless Communication Test Set	CMU200	112387	Oct. 31, 2009	Oct. 31, 2010
Agilent	Wireless Communication Test Set	E5515C	GB47020167	May 25, 2009	May 25, 2010
Agilent	ENA Series Network Analyzer	E5071B	MY42402996	Nov. 04, 2008	Nov. 04, 2010
Agilent	Dielectric Probe Kit	85070C	US99360094	NCR	NCR
R&S	Power Sensor	NRP-Z22	100179	May 17, 2009	May 17, 2010
Agilent	Signal Generator	E8257D	MY44320425	Mar. 09, 2009	Mar. 09, 2010
Agilent	Dual Directional Coupler	778D	50334	NCR	NCR
Mini-Circuits	Power Amplifier	ZHL-42W-SMA	D111103#5	NCR	NCR
Mini-Circuits	Power Amplifier	ZVE-8G-SMA	D042005 671800514	NCR	NCR

Table 2. Test Equipment List



7. Tissue Simulating Liquids

The mixture is calibrated to obtain proper dielectric constant (permittivity) and conductivity of the tissue.

The dielectric parameters of the liquids were verified prior to the SAR evaluation using an 85070C Dielectric Probe Kit and an 8720ES Network Analyzer.

IEEE SCC-34/SC-2 in 1528 recommended Tissue Dielectric Parameters

The head tissue dielectric parameters recommended by the IEEE SCC-34/SC-2 in 1528 have been incorporated in the following table. These head parameters are derived from planar layer models simulating the highest expected SAR for the dielectric properties and tissue thickness variations in human head. Other head and body tissue parameters that have not been specified in 1528 are derived from the tissue dielectric parameters computed from the 4-Cole-Cole equation and extrapolated according to the head parameter specified in 1528.

Target Frequency	Head		Body	
(MHz)	ϵ_r	σ (S/m)	ϵ_r	σ (S/m)
150	52.3	0.76	61.9	0.80
300	45.3	0.87	58.2	0.92
450	43.5	0.87	56.7	0.94
835	41.5	0.90	55.2	0.97
900	41.5	0.97	55.0	1.05
915	41.5	0.98	55.0	1.06
1450	40.5	1.20	54.0	1.30
1610	40.3	1.29	53.8	1.40
1800 - 2000	40.0	1.40	53.3	1.52
2450	39.2	1.80	52.7	1.95
3000	38.5	2.40	52.0	2.73
5800	35.3	5.27	48.2	6.00

(ϵ_r = relative permittivity, σ = conductivity and $\rho = 1000 \text{ kg/m}^3$)

Table 3. Tissue dielectric parameters for head and body phantoms



7.1 Ingredients

The following ingredients are used:

- Water: deionized water (pure H₂O), resistivity $\geq 16 \text{ M } \Omega$ -as basis for the liquid
- Sugar: refined white sugar (typically 99.7 % sucrose, available as crystal sugar in food shops)
-to reduce relative permittivity
- Salt: pure NaCl -to increase conductivity
- Cellulose: Hydroxyethyl-cellulose, medium viscosity (75-125 mPa.s, 2% in water, 20 °C), CAS # 54290 -to increase viscosity and to keep sugar in solution.
- Preservative: Preventol D-7 Bayer AG, D-51368 Leverkusen, CAS # 55965-84-9 -to prevent the spread of bacteria and molds
- DGBE: Diethylenglycol-monobutyl ether (DGBE), Fluka Chemie GmbH, CAS # 112-34-5 -to reduce relative permittivity

7.2 Recipes

The following tables give the recipes for tissue simulating liquids to be used in different frequency bands.

Note: The goal dielectric parameters (at 22 °C) must be achieved within a tolerance of $\pm 5\%$ for ϵ and $\pm 5\%$ for σ .

Liquid type	MSL 2450-B	
Ingredient	Weight (g)	Weight (%)
Water	686.35	68.64
DGBE	313.65	31.37
Salt	-	0.00
Total amount	1,000.00	100.00
Goal dielectric parameters		
Frequency [MHz]	2450	
Relative Permittivity	52.7	
Conductivity [S/m]	1.95	

7.3 Liquid Confirmation

7.3.1 Parameters

Liquid Verify								
Ambient Temperature : 22 ± 2 °C ; Relative Humidity : 40 -70%								
Liquid Type	Frequency	Temp (°C)	Parameters	Target Value	Measured Value	Deviation (%)	Limit (%)	Measured Date
2450MHz Body	2400MHz	22.0	ϵ_r	52.7	50.9	-3.42 %	± 5	Nov. 05, 2009
			σ	1.95	1.88	-3.59 %	± 5	
	2450MHz	22.0	ϵ_r	52.7	50.9	-3.42 %	± 5	
			σ	1.95	1.95	0.00 %	± 5	
	2500MHz	22.0	ϵ_r	52.7	50.6	-3.98 %	± 5	
			σ	1.95	2.00	2.56 %	± 5	

Table 4. Measured Tissue dielectric parameters for head and body phantoms

7.3.2 Liquid Depth

The liquid level was during measurement 15cm ±0.5cm.

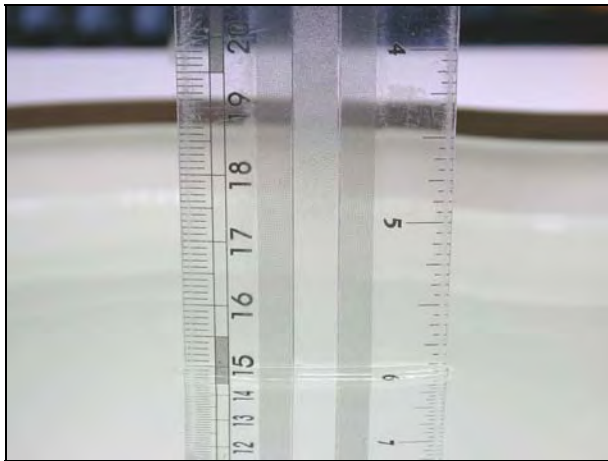

Figure 8. Head-Tissue-Simulating-Liquid

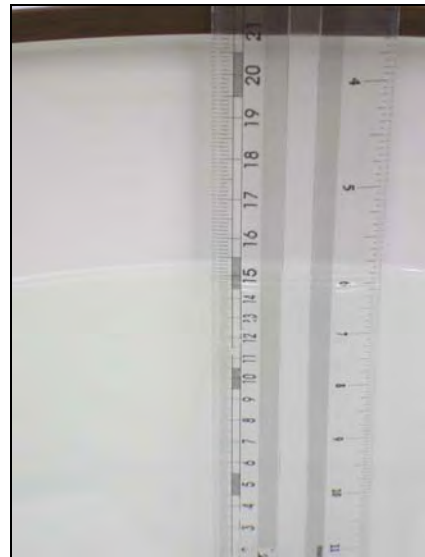

Figure 9. Body-Tissue-Simulating-Liquid



8. Measurement Process

8.1 Device and Test Conditions

The Test Device was provided by **Acer Incorporated** for this evaluation. The spatial peak SAR values were assessed for the lowest, middle and highest channels defined by **WLAN 802.11b / 802.11g / 802.11n_HT20** (#1=2412MHz, #6=2437MHz, #11=2462MHz) systems and **WLAN 802.11n_HT40** (#1=2422MHz, #6=2437MHz, #11=2452MHz) systems.

Usage:	Operates with a test mode by client (802.11b/802.11g//802.11n)
Simulating human Head/Body:	Body
EUT Battery:	Fully-charged with Li-ion batteries.
Comment:	The SAR test mode is chosen by the max conducted power.

8.2 Test mode Description

(1) Laptop Mode: Lap-held with the display open at 90° to the keyboard

Note: WLAN main antenna is more than 20(cm) from phantom for laptop mode, so SAR test is not required.

(2) Tablet Mode: The SAR value is LCD Tip Close Body>Right Side Close Body>Bottom Close Body. Only test LCD Tip Close Body Mode

(3) Tablet Mode – LCD Tip Close Body Mode: The 1g- SAR value is 0.339mw/g of 802.11g ch6 rate: 6MHz. The Lowest and Highest are not required of channels.

(4) The Intel Corporation model 112BNHMW is a PCI express form factor (half-mini) card that is designed to provide a 1x2 802.11 bgn interface for host systems such as laptop PCs. Therefore, the left side antenna is receiver only and left side test is not required.

(5) Choose the maximum Avg. Power to test SAR in each band:

2450MHz						
Band	Data Rate	CH	Frequency (MHz)	Average Conducted power (dBm)		Worst Case
				Before	After	
802.11 b	1M	1	2412.0	16.43	16.39	<input type="checkbox"/>
		6	2437.0	16.47	16.42	<input checked="" type="checkbox"/>
		11	2462.0	16.30	16.28	<input type="checkbox"/>
802.11 g	6M	1	2412.0	12.30	12.28	<input type="checkbox"/>
		6	2437.0	16.60	16.58	<input checked="" type="checkbox"/>
		11	2462.0	11.30	11.27	<input type="checkbox"/>
802.11n_HT20	6.5M	1	2412.0	11.80	11.77	<input type="checkbox"/>
		6	2437.0	16.38	16.36	<input checked="" type="checkbox"/>
		11	2462.0	10.90	10.86	<input type="checkbox"/>
802.11n_HT40	13.5M	3	2422.0	10.70	10.69	<input type="checkbox"/>
		6	2437.0	11.95	11.92	<input checked="" type="checkbox"/>
		9	2452.0	9.60	9.58	<input type="checkbox"/>

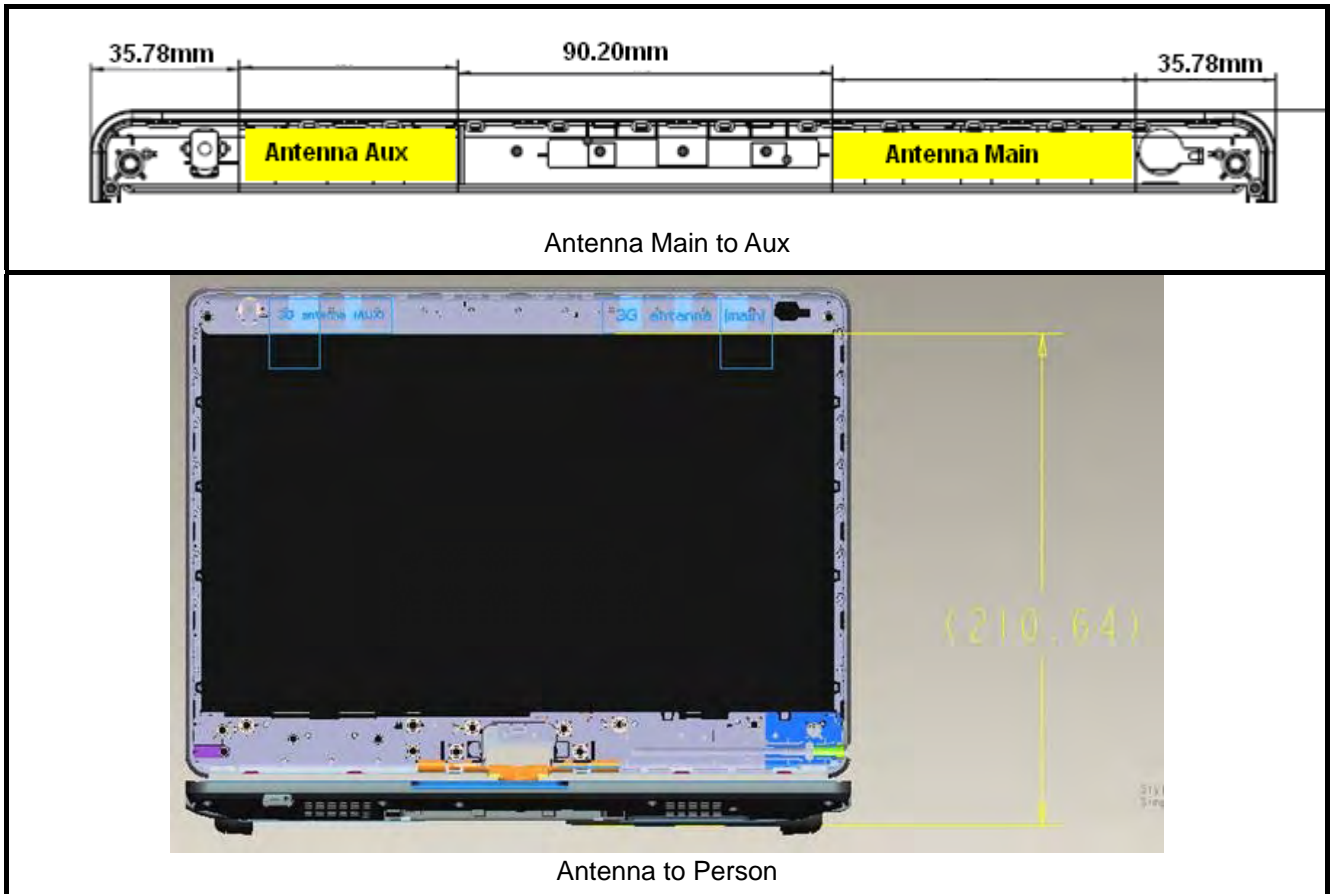

8.3 System Performance Check

8.3.1 Symmetric Dipoles for System Validation

Construction	Symmetrical dipole with 1/4 balun enables measurement of feed point impedance with NWA matched for use near flat phantoms filled with head simulating solutions Includes distance holder and tripod adaptor Calibration Calibrated SAR value for specified position and input power at the flat phantom in head simulating solutions.
Frequency	2450 MHz
Return Loss	> 20 dB at specified validation position
Power Capability	> 100 W (f < 1GHz); > 40 W (f > 1GHz)
Options	Dipoles for other frequencies or solutions and other calibration conditions are available upon request
Dimensions	D2450V2 : dipole length 51.5 mm; overall height 300 mm



Figure 10. Validation Kit



8.3.2 Validation

Prior to the assessment, the system validation kit was used to test whether the system was operating within its specifications of $\pm 7\%$. The validation was performed at 2450 MHz.

Validation kit		Mixture Type	SAR _{1g} [mW/g]		SAR _{10g} [mW/g]		Date of Calibration
D2450V2-SN712		Body	52.8		24.72		Feb. 11, 2009
Frequency (MHz)	Power (dBm)	SAR _{1g} (mW/g)	SAR _{10g} (mW/g)	Drift (dB)	Difference percentage		Date
					1g	10g	
2450 (Body)	250mW	13.4	6.22	-0.065	1.5 %	0.6 %	Nov. 05, 2009
	Normalize to 1 Watt	53.6	24.88				

Z-axis Plot of System Performance Check

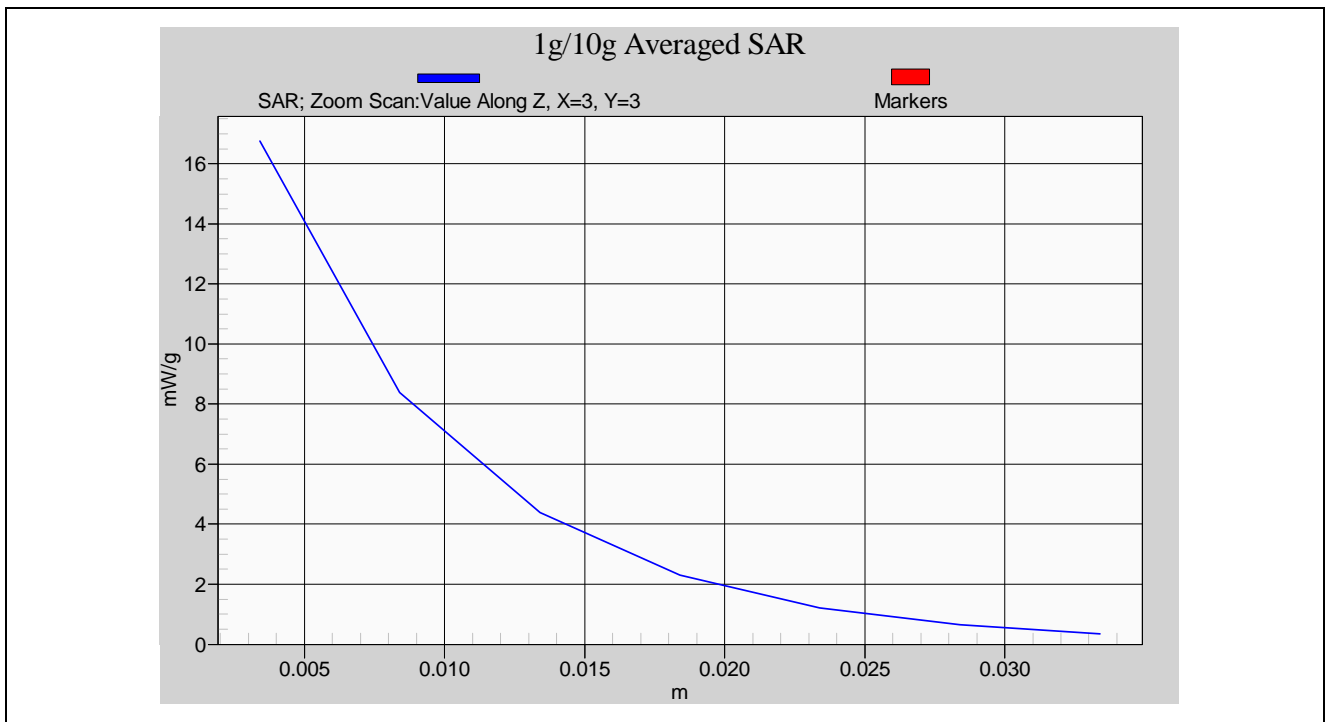

Body-Tissue-Simulating-Liquid 2450MHz_ 11/05/2009



8.4 Dosimetric Assessment Setup

8.4.1 Body Test Position

Body - Worn Configuration

Body - Worn operating configurations should be tested with the belt-clips and holsters attached to the device and positioned against a flat phantom in normal use configurations. Devices with a headset output should be tested with a headset connected to the device.

Body - Worn accessories may not always be supplied or available as options for some devices that are intended to be authorized for body-worn use. A separation distance of 15 mm between the back of the device and a flat phantom is recommended for testing body-worn SAR compliance under such circumstances.

For this test :

- The EUT is placed into the holster/belt clip and the holster is positioned against the surface of the phantom in a normal operating position.

- Since this EUT doesn't supply any body-worn accessory to the end user, for **WLAN 802.11b / WLAN 802.11g / WLAN 802.11n** the distance of **2mm** was tested to confirm the necessary "minimum SAR separation distance".
(* Note : This distance includes the 2 mm phantom shell thickness.)



8.4.2 Measurement Procedures

The evaluation was performed with the following procedures :

- Surface Check :** A surface checks job gathers data used with optical surface detection. It determines the distance from the phantom surface where the reflection from the optical detector has its peak. Any following measurement jobs using optical surface detection will then rely on this value. The surface check performs its search a specified number of times, so that the repeatability can be verified. The probe tip distance is 1.3mm to phantom inner surface during scans.
- Reference :** The reference job measures the field at a specified reference position, at 4 mm from the selected section's grid reference point.
- Area Scan :** The area scan is used as a fast scan in two dimensions to find the area of high field values, before doing a finer measurement around the hot spot. The sophisticated interpolation routines can find the maximum locations even in relatively coarse grids. When an area scan has measured all reachable points, it computes the field maxima found in the scanned area, within a range of the global maximum. Any following zoom scan within the same procedure will then perform fine scans around these maxima. The area covered the entire dimension of the EUT and the horizontal grid spacing was 15 mm x 15 mm.
- Zoom Scan :** Zoom scans are used to assess the highest averaged SAR for cubic averaging volumes with 1 g and 10 g of simulated tissue. The zoom scan measures 7 x 7 x 9 points in a 30 x 30 x 24 mm cube whose base faces are centered around the maxima returned from a preceding area scan within the same procedure.
- Drift :** The drift job measures the field at the same location as the most recent reference job within the same procedure, with the same settings. The drift measurement gives the field difference in dB from the last reference measurement. Several drift measurements are possible for each reference measurement. This allows monitoring of the power drift of the device in the batch process. If the value changed by more than 5%, the evaluation was repeated.



8.5 Spatial Peak SAR Evaluation

The DASY5 software includes all numerical procedures necessary to evaluate the spatial peak SAR values. Based on the Draft: SCC-34, SC-2, WG-2 - Computational Dosimetry, IEEE P1529/D0.0 (Draft Recommended Practice for Determining the Spatial-Peak Specific Absorption Rate (SAR) Associated with the Use of Wireless Handsets - Computational Techniques), a new algorithm has been implemented. The spatial-peak SAR can be computed over any required mass.

The base for the evaluation is a "cube" measurement in a volume of $(32 \times 32 \times 30) \text{mm}^3$ ($5 \times 5 \times 7$ points). The measured volume must include the 1g and 10g cubes with the highest averaged SAR values. For that purpose, the center of the measured volume is aligned to the interpolated peak SAR value of a previously performed area scan. If the 10g cube or both cubes are not entirely inside the measured volumes, the system issues a warning regarding the evaluated spatial peak values within the Postprocessing engine (SEMCAD). This means that if the measured volume is shifted, higher values might be possible. To get the correct values you can use a finer measurement grid for the area scan. In complicated field distributions, a large grid spacing for the area scan might miss some details and give an incorrectly interpolated peak location.

The entire evaluation of the spatial peak values is performed within the Postprocessing engine (SEMCAD). The system always gives the maximum values for the 1g and 10g cubes. The algorithm to find the cube with highest averaged SAR is divided into three stages:

Interpolation and Extrapolation

The probe is calibrated at the center of the dipole sensors which is located 1 to 2.7mm away from the probe tip. During measurements, the probe stops shortly above the phantom surface, depending on the probe and the surface detecting system. Both distances are included as parameters in the probe configuration file. The software always knows exactly how far away the measured point is from the surface. As the probe cannot directly measure at the surface, the values between the deepest measured point and the surface must be extrapolated.

In DASY5, the choice of the coordinate system defining the location of the measurement points has no influence on the uncertainty of the interpolation, Maxima Search and SAR extrapolation routines. The interpolation, Maxima Search and extrapolation routines are all based on the modified Quadratic Shepard's method [7].



9. Measurement Uncertainty

Measurement uncertainties in SAR measurements are difficult to quantify due to several variables including biological, physiological, and environmental. However, we estimate the measurement uncertainties in SAR to be less than $\pm 21.9\%$ [8] .

According to Std. C95.3 [9] , the overall uncertainties are difficult to assess and will vary with the type of meter and usage situation. However, accuracy's of ± 1 to 3 dB can be expected in practice, with greater uncertainties in near-field situations and at higher frequencies (shorter wavelengths), or areas where large reflecting objects are present. Under optimum measurement conditions, SAR measurement uncertainties of at least ± 2 dB can be expected.

According to CENELEC [10] , typical worst-case uncertainty of field measurements is ± 5 dB. For well-defined modulation characteristics the uncertainty can be reduced to ± 3 dB.



Error Description	Uncertainty value	Prob. Dist.	Div.	(c _i) 1g	(c _i) 10g	Std. Unc. (1g)	Std. Unc. (10g)	(v _i) v _{eff}
Measurement System								
Probe Calibration	± 5.9 %	N	1	1	1	± 5.9 %	± 5.9 %	
Axial Isotropy	± 4.7 %	R		0.7	0.7	± 1.9 %	± 1.9 %	∞
Hemispherical Isotropy	± 9.6 %	R	√3	0.7	0.7	± 3.9 %	± 3.9 %	∞
Boundary Effects	± 1.0 %	R	√3	1	1	± 0.6 %	± 0.6 %	∞
Linearity	± 4.7 %	R	√3	1	1	± 2.7 %	± 2.7 %	∞
System Detection Limits	± 1.0 %	R	√3	1	1	± 0.6 %	± 0.6 %	∞
Readout Electronics	± 0.3 %	N	1	1	1	± 0.3 %	± 0.3 %	∞
Response Time	± 0.8 %	R	√3	1	1	± 0.5 %	± 0.5 %	∞
Integration Time	± 2.6 %	R	√3	1	1	± 1.5 %	± 1.5 %	∞
RF Ambient Noise	± 3.0 %	R	√3	1	1	± 1.7 %	± 1.7 %	∞
RF Ambient Reflections	± 3.0 %	R	√3	1	1	± 1.7 %	± 1.7 %	∞
Probe Positioner	± 0.4 %	R	√3	1	1	± 0.2 %	± 0.2 %	∞
Probe Positioning	± 2.9 %	R	√3	1	1	± 1.7 %	± 1.7 %	∞
Max. SAR Eval.	± 1.0 %	R	√3	1	1	± 0.6 %	± 0.6 %	∞
Test Sample Related								
Device Positioning	± 2.9 %	N	1	1	1	± 2.9 %	± 2.9 %	145
Device Holder	± 3.6 %	N	1	1	1	± 3.6 %	± 3.6 %	5
Power Drift	± 5.0 %	R	√3	1	1	± 2.9 %	± 2.9 %	∞
Phantom and Setup								
Phantom Uncertainty	± 4.0 %	R	√3	1	1	± 2.3 %	2.3 %	∞
Liquid Conductivity (target)	± 5.0 %	R	√3	0.64	0.43	± 1.8 %	1.2 %	∞
Liquid Conductivity (meas.)	± 2.5 %	N	1	0.64	0.43	± 1.6 %	1.1 %	∞
Liquid Permittivity (target)	± 5.0 %	R	√3	0.6	0.49	± 1.7 %	1.4 %	∞
Liquid Permittivity (meas.)	± 2.5 %	N	1	0.6	0.49	± 1.5 %	1.2 %	∞
Combined Std. Uncertainty						± 10.9 %	± 10.7 %	387
Expanded STD Uncertainty						± 21.9 %	± 21.4 %	

Table 5. Uncertainty Budget of DASY



10. SAR Test Results Summary

10.1 WLAN 802.11b - Body SAR

Ambient :

Temperature (°C) : 22 ± 2 Relative HUMIDITY (%) : 40-70

Liquid :

Mixture Type : MSL2450 Liquid Temperature (°C) : 22.0
 Depth of liquid (cm) : 15

Measurement :

Duty Cycle : 1:1 Probe S/N : 3150

Frequency		Rate	Power (dBm)	Phantom Position	Antenna Position	Accessory	SAR _{1g} [mW/g]	Power Drift (dB)	Remark
MHz	CH								
2437	6	1M	16.47	Flat	PIFA	N/A	0.303	0.121	Tablet Mode LCD Tip Close Body
Std. C95.1-2005 - Safety Limit RSS-102-2009 - Safety Limit Spatial Peak Uncontrolled Exposure/General Population						1.6 W/kg (mW/g) Averaged over 1 gram			

Detail results see Appendix B.

Z-axis Plot of SAR Measurement

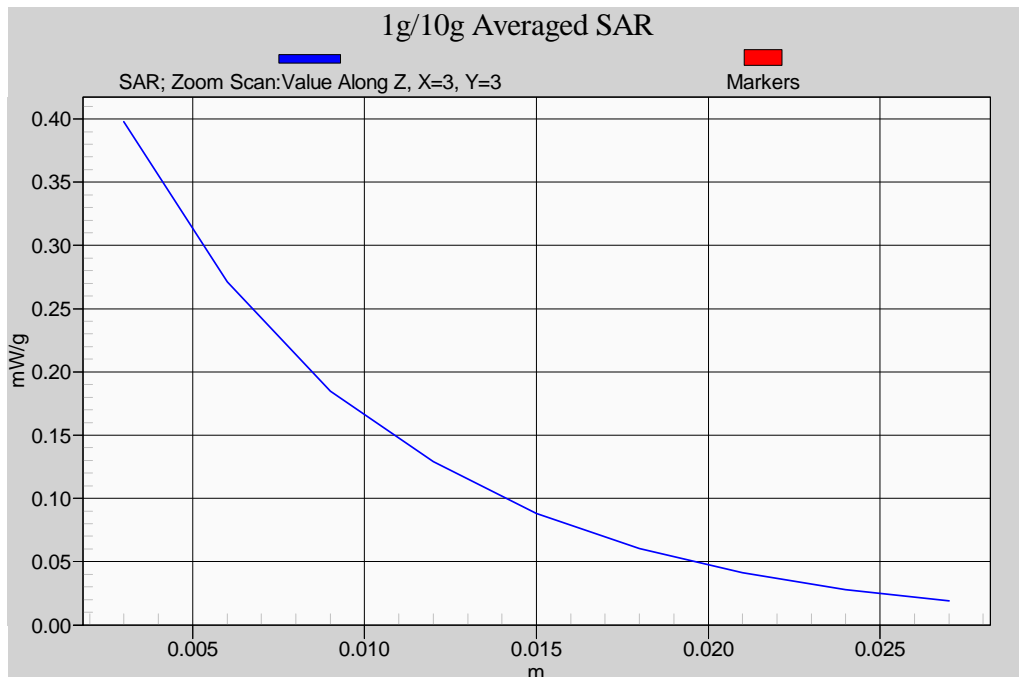

Z-axis Plot of Flat WLAN 802.11b CH 6 (Rate 1M)



10.2 WLAN 802.11g - Body SAR

Ambient :

Temperature (°C) : 22 ± 2 Relative HUMIDITY (%) : 40-70

Liquid :

Mixture Type : MSL2450 Liquid Temperature (°C) : 22.0
 Depth of liquid (cm) : 15

Measurement :

Duty Cycle : 1:1 Probe S/N : 3150

Frequency		Rate	Power (dBm)	Phantom Position	Antenna Position	Accessory	SAR _{1g} [mW/g]	Power Drift (dB)	Remark
MHz	CH								
2437	6	6M	16.60	Flat	PIFA	N/A	0.066	-0.050	Tablet Mode LCD Right side Close Body
2437	6	6M	16.60	Flat	PIFA	N/A	0.014	0.134	Tablet Mode Bottom Close Body
2437	6	6M	16.60	Flat	PIFA	N/A	0.339	-0.152	Tablet Mode LCD Tip Close Body
Std. C95.1-2005 - Safety Limit RSS-102-2009 - Safety Limit Spatial Peak Uncontrolled Exposure/General Population						1.6 W/kg (mW/g) Averaged over 1 gram			

Detail results see Appendix B.



Z-axis Plot of SAR Measurement

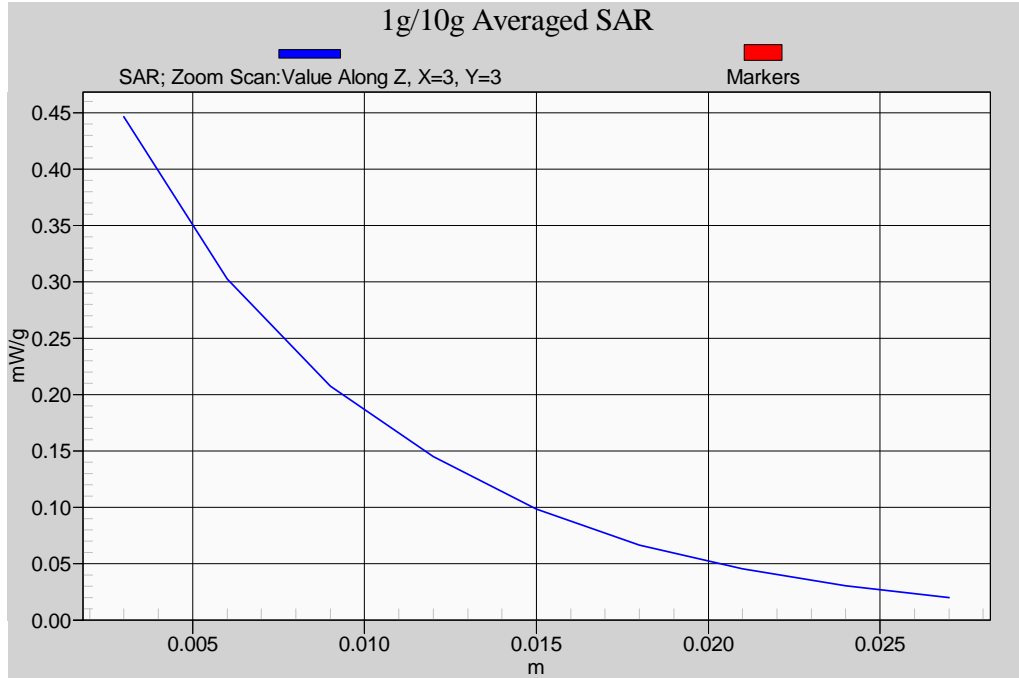

Z-axis Plot of Flat WLAN 802.11g CH 6 (Rate 6M)



10.3 WLAN 802.11n (2.4G)_HT20 Body SAR

Ambient :

Temperature (°C) : 22 ± 2 Relative HUMIDITY (%) : 40-70

Liquid :

Mixture Type : MSL2450 Liquid Temperature (°C) : 22.0
 Depth of liquid (cm) : 15

Measurement :

Duty Cycle : 1:1 Probe S/N : 3150

Frequency		Rate	Power (dBm)	Phantom Position	Antenna Position	Accessory	SAR _{1g} [mW/g]	Power Drift (dB)	Remark
MHz	CH								
2437	6	6.5M	16.38	Flat	PIFA	N/A	0.290	0.149	Tablet Mode LCD Tip Close Body
Std. C95.1-2005 - Safety Limit RSS-102-2009 - Safety Limit Spatial Peak Uncontrolled Exposure/General Population						1.6 W/kg (mW/g) Averaged over 1 gram			

Detail results see Appendix B.

Z-axis Plot of SAR Measurement

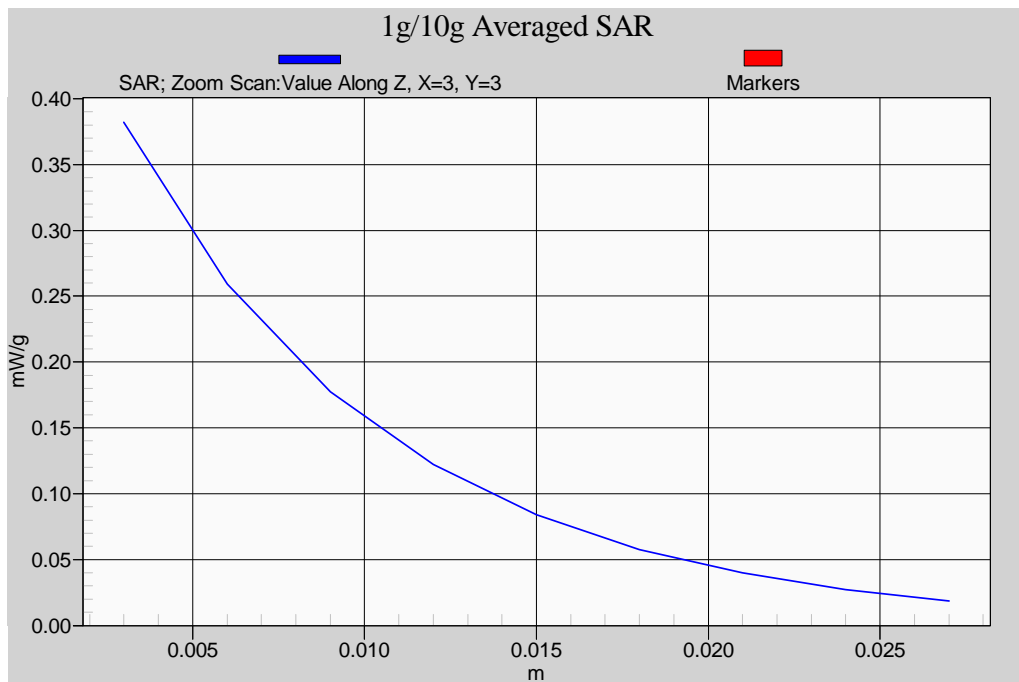

Z-axis Plot of Flat WLAN 802.11n CH 6 (Rate 6.5M)



10.4 WLAN 802.11n (2.4G)_HT40 Body SAR

Ambient :

Temperature (°C) : 22 ± 2 Relative HUMIDITY (%) : 40-70

Liquid :

Mixture Type : MSL2450 Liquid Temperature (°C) : 22.0
 Depth of liquid (cm) : 15

Measurement :

Duty Cycle : 1:1 Probe S/N : 3150

Frequency		Rate	Power (dBm)	Phantom Position	Antenna Position	Accessory	SAR _{1g} [mW/g]	Power Drift (dB)	Remark
MHz	CH								
2437	6	13.5M	11.95	Flat	PIFA	N/A	0.101	-0.129	Tablet Mode LCD Tip Close Body
Std. C95.1-2005 - Safety Limit RSS-102-2009 - Safety Limit Spatial Peak Uncontrolled Exposure/General Population						1.6 W/kg (mW/g) Averaged over 1 gram			

Detail results see Appendix B.

Z-axis Plot of SAR Measurement

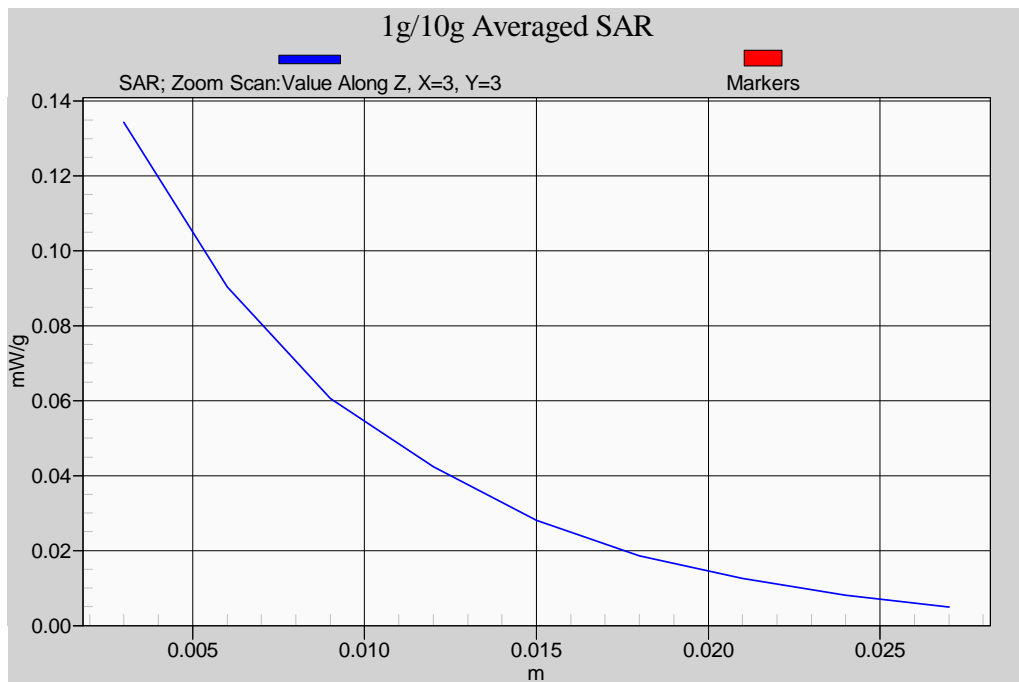

Z-axis Plot of Flat WLAN 802.11n CH 6 (Rate 13.5M)



10.5 Std. C95.1-2005 RF Exposure Limit

Human Exposure	Population Uncontrolled Exposure (W/kg) or (mW/g)	Occupational Controlled Exposure (W/kg) or (mW/g)
Spatial Peak SAR* (head)	1.60	8.00
Spatial Peak SAR** (Whole Body)	0.08	0.40
Spatial Peak SAR*** (Partial-Body)	1.60	8.00
Spatial Peak SAR**** (Hands / Feet / Ankle / Wrist)	4.00	20.00

Table 6. Safety Limits for Partial Body Exposure

Notes :

- * The Spatial Peak value of the SAR averaged over any 1 gram of tissue.
(defined as a tissue volume in the shape of a cube) and over the appropriate averaging time.
- ** The Spatial Average value of the SAR averaged over the whole – body.
- *** The Spatial Average value of the SAR averaged over the partial – body.
- **** The Spatial Peak value of the SAR averaged over any 10 grams of tissue.
(defined as a tissue volume in the shape of a cube) and over the appropriate averaging time.

Population / Uncontrolled Environments : are defined as locations where there is the exposure of individuals who have no knowledge or control of their exposure.

Occupational / Controlled Environments : are defined as locations where there is exposure that may be incurred by persons who are aware of the potential for exposure, (i.e. as a result of employment or occupation).



11. Conclusion

The SAR test values found for the portable mobile phone **Acer Incorporated Trade Name : acer Model(s) : 112BNHMW** is below the maximum recommended level of 1.6 W/kg (mW/g).

12. References

- [1] Std. C95.1-2005, "American National Standard safety levels with respect to human exposure to radio frequency electromagnetic fields, 300KHz to 100GHz", New York.
- [2] NCRP, National Council on Radiation Protection and Measurements, "Biological Effects and Exposure Criteria for Radio frequency Electromagnetic Fields", NCRP report NO. 86, 1986.
- [3] T. Schmid, O. Egger, and N. Kuster, "Automatic E-field scanning system for dosimetric assessments", IEEE Transactions on Microwave Theory and Techniques, vol. 44, pp. 105-113, Jan. 1996.
- [4] K. Poković, T. Schmid, and N. Kuster, "Robust setup for precise calibration of E-field probes in tissue simulating liquids at mobile communications frequency", in ICECOM'97, Dubrovnik, October 15-17, 1997, pp.120-124.
- [5] K. Poković, T. Schmid, and N. Kuster, "E-field probe with improved isotropy in brain simulating liquids", in Proceedings of the ELMAR, Zadar, Croatia, 23-25 June, 1996, pp.172-175.
- [6] N. Kuster, and Q. Balzano, "Energy absorption mechanism by biological bodies in the near field of dipole antennas above 300MHz", IEEE Transaction on Vehicular Technology, vol. 41, no. 1, Feb. 1992, pp. 17-23.
- [7] Robert J. Renka, "Multivariate Interpolation Of Large Sets Of Scattered Data", University of North Texas ACM Transactions on Mathematical Software, vol. 14, no. 2, June 1988 , pp. 139-148.
- [8] N. Kuster, R. Kastle, T. Schmid, *Dosimetric evaluation of mobile communications equipment with known precision*, IEEE Transaction on Communications, vol. E80-B, no. 5, May 1997, pp. 645-652.
- [9] Std. C95.3-1991, "IEEE Recommended Practice for the Measurement of Potentially Hazardous Electromagnetic Fields – RF and Microwave, New York: IEEE, Aug. 1992.
- [10] CENELEC CLC/SC111B, European Prestandard (prENV 50166-2), *Human Exposure to Electromagnetic Fields High-frequency. 10KHz-300GHz*, Jan. 1995.
- [11] RSS-102, Issue 3 (June 2009), Radio Standards Specification 102.



Appendix A - System Performance Check

See following Attached Pages for System Performance Check.

Test Laboratory: A Test Lab Techno Corp.

Date/Time: 11/5/2009 4:47:19 AM

System Performance Check at 2450MHz_20091105_Body

DUT: Dipole 2450 MHz; Type: D2450V2; Serial: D2450V2 - SN:712

Communication System: CW; Frequency: 2450 MHz; Duty Cycle: 1:1

Medium parameters used: $f = 2450 \text{ MHz}$; $\sigma = 1.95 \text{ mho/m}$; $\epsilon_r = 50.9$; $\rho = 1000 \text{ kg/m}^3$

Phantom section: Flat Section

Measurement Standard: DASYS (IEEE/IEC)

DASY5 Configuration:

- Probe: ES3DV3 - SN3150; ConvF(4.23, 4.23, 4.23); Calibrated: 1/20/2009
- Sensor-Surface: 3.4mm (Mechanical Surface Detection)
- Electronics: DAE4 Sn779; Calibrated: 11/11/2008
- Phantom: ELI 4.0; Type: QDOVA001BB; Serial: 1036
- Measurement SW: DASYS, V5.0 Build 125; SEMCAD X Version 13.4 Build 125

System Performance Check at 2450MHz/Area Scan (61x61x1):

Measurement grid: $dx=15\text{mm}$, $dy=15\text{mm}$

Maximum value of SAR (interpolated) = 17.1 mW/g

System Performance Check at 2450MHz/Zoom Scan (7x7x7)/Cube 0:

Measurement grid: $dx=5\text{mm}$, $dy=5\text{mm}$, $dz=5\text{mm}$

Reference Value = 95.1 V/m; Power Drift = -0.065 dB

Peak SAR (extrapolated) = 28 W/kg

SAR(1 g) = 13.4 mW/g; SAR(10 g) = 6.22 mW/g

Maximum value of SAR (measured) = 16.8 mW/g

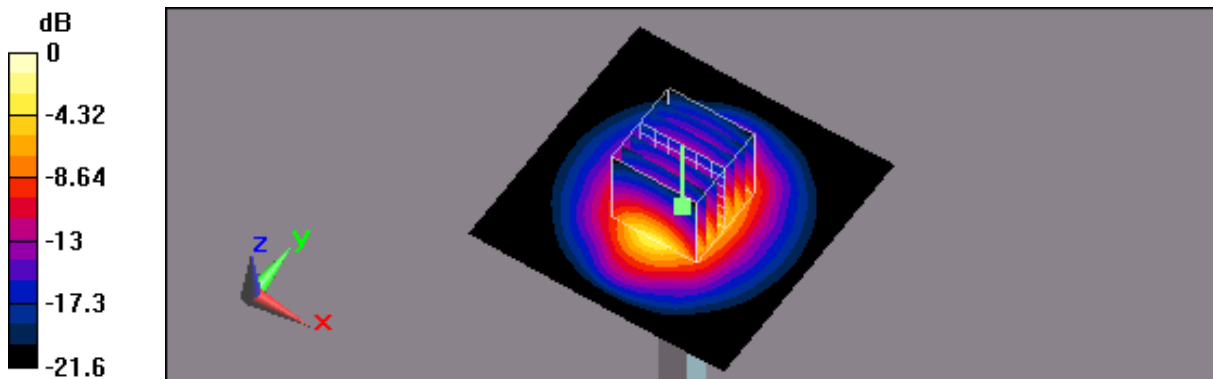

0 dB = 16.8mW/g



Appendix B - SAR Measurement Data

See following Attached Pages for SAR Measurement Data.

Test Laboratory: A Test Lab Techno Corp.

Date/Time: 11/5/2009 10:09:04 AM

Flat_802.11b CH6_1M_Tablet Mode LCD Tip Close Body

DUT:112BNHMW_Tablet mode_LCD Tip; Type: WLAN Module;

Serial: ZE90SK01C19391A23B2500

Communication System: IEEE 802.11b; Frequency: 2437 MHz;Duty Cycle: 1:1

Medium parameters used: $f = 2437 \text{ MHz}$; $\sigma = 1.93 \text{ mho/m}$; $\epsilon_r = 50.9$; $\rho = 1000 \text{ kg/m}^3$

Phantom section: Flat Section

Measurement Standard: DASYS (IEEE/IEC)

DASY5 Configuration:

- Probe: ES3DV3 - SN3150; ConvF(4.23, 4.23, 4.23); Calibrated: 1/20/2009
- Sensor-Surface: 3mm (Mechanical Surface Detection)
- Electronics: DAE4 Sn779; Calibrated: 11/11/2008
- Phantom: ELI 4.0; Type: QDOVA001BB; Serial: 1036
- Measurement SW: DASYS, V5.0 Build 125;SEMCAD X Version 13.4 Build 125

Flat/Area Scan (61x111x1):

Measurement grid: $dx=15\text{mm}$, $dy=15\text{mm}$

Maximum value of SAR (interpolated) = 0.398 mW/g

Flat/Zoom Scan (7x7x9)/Cube 0:

Measurement grid: $dx=5\text{mm}$, $dy=5\text{mm}$, $dz=3\text{mm}$

Reference Value = 1.15 V/m; Power Drift = 0.121 dB

Peak SAR (extrapolated) = 0.600 W/kg

SAR(1 g) = 0.303 mW/g; SAR(10 g) = 0.140 mW/g

Maximum value of SAR (measured) = 0.398 mW/g

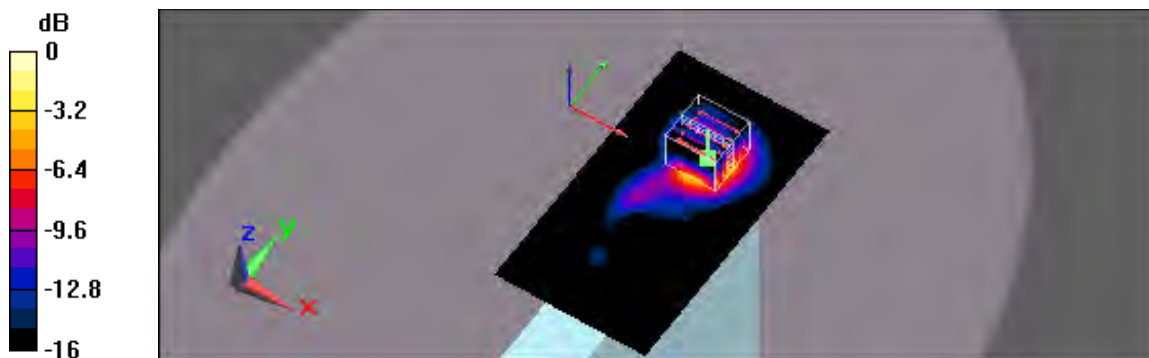

0 dB = 0.398mW/g

Test Laboratory: A Test Lab Techno Corp.

Date/Time: 11/5/2009 12:21:31 PM

Flat_802.11g CH6_6M_Tablet Mode LCD Right side Close Body

DUT: 112BNHMW_Tablet Mode LCD Right side; Type: WLAN Module;

Serial: ZE90SK01C19391A23B2500

Communication System: IEEE 802.11g; Frequency: 2437 MHz; Duty Cycle: 1:1
Medium parameters used: $f = 2437 \text{ MHz}$; $\sigma = 1.93 \text{ mho/m}$; $\epsilon_r = 50.9$; $\rho = 1000 \text{ kg/m}^3$
Phantom section: Flat Section
Measurement Standard: DASYS (IEEE/IEC)

DASY5 Configuration:

- Probe: ES3DV3 - SN3150; ConvF(4.23, 4.23, 4.23); Calibrated: 1/20/2009
- Sensor-Surface: 3mm (Mechanical Surface Detection)
- Electronics: DAE4 Sn779; Calibrated: 11/11/2008
- Phantom: ELI 4.0; Type: QDOVA001BB; Serial: 1036
- Measurement SW: DASYS, V5.0 Build 125; SEMCAD X Version 13.4 Build 125

Flat/Area Scan (81x111x1):

Measurement grid: $dx=15\text{mm}$, $dy=15\text{mm}$
Maximum value of SAR (interpolated) = 0.067 mW/g

Flat/Zoom Scan (7x7x9)/Cube 0:

Measurement grid: $dx=5\text{mm}$, $dy=5\text{mm}$, $dz=3\text{mm}$
Reference Value = 2.52 V/m; Power Drift = -0.050 dB
Peak SAR (extrapolated) = 0.159 W/kg
SAR(1 g) = 0.066 mW/g; SAR(10 g) = 0.030 mW/g
Maximum value of SAR (measured) = 0.087 mW/g

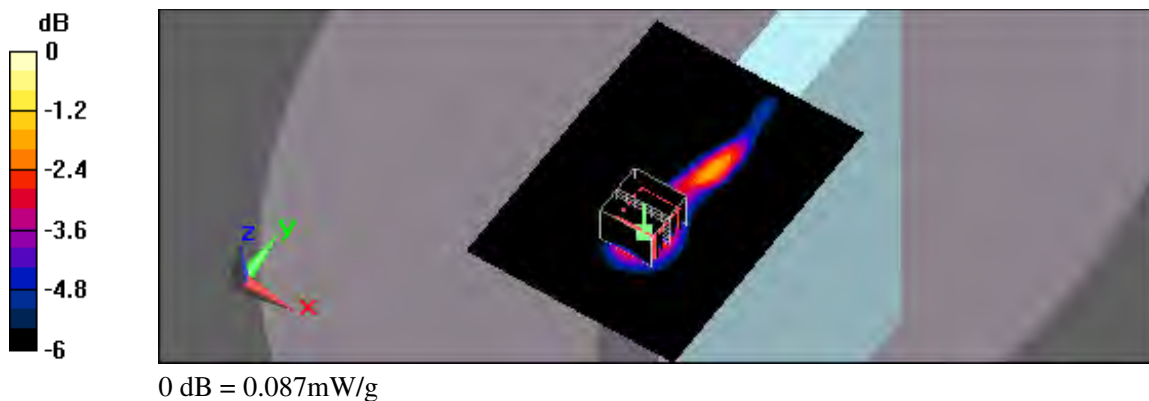

Test Laboratory: A Test Lab Techno Corp.

Date/Time: 11/5/2009 1:03:35 PM

Flat_802.11g CH6_6M_Tablet Mode Bottom Close Body

DUT: 112BNHMW_Tablet mode_Bottom; Type: WLAN Module;

Serial: ZE90SK01C19391A23B2500

Communication System: IEEE 802.11g; Frequency: 2437 MHz; Duty Cycle: 1:1
Medium parameters used: $f = 2437$ MHz; $\sigma = 1.93$ mho/m; $\epsilon_r = 50.9$; $\rho = 1000$ kg/m³
Phantom section: Flat Section
Measurement Standard: DASYS (IEEE/IEC)

DASY5 Configuration:

- Probe: ES3DV3 - SN3150; ConvF(4.23, 4.23, 4.23); Calibrated: 1/20/2009
- Sensor-Surface: 3mm (Mechanical Surface Detection)
- Electronics: DAE4 Sn779; Calibrated: 11/11/2008
- Phantom: ELI 4.0; Type: QDOVA001BB; Serial: 1036
- Measurement SW: DASY5, V5.0 Build 125; SEMCAD X Version 13.4 Build 125

Flat/Area Scan (81x111x1):

Measurement grid: dx=15mm, dy=15mm
Maximum value of SAR (interpolated) = 0.018 mW/g

Flat/Zoom Scan (7x7x9)/Cube 0:

Measurement grid: dx=5mm, dy=5mm, dz=3mm
Reference Value = 0.600 V/m; Power Drift = 0.134 dB
Peak SAR (extrapolated) = 0.031 W/kg
SAR(1 g) = 0.014 mW/g; SAR(10 g) = 0.00747 mW/g
Maximum value of SAR (measured) = 0.018 mW/g

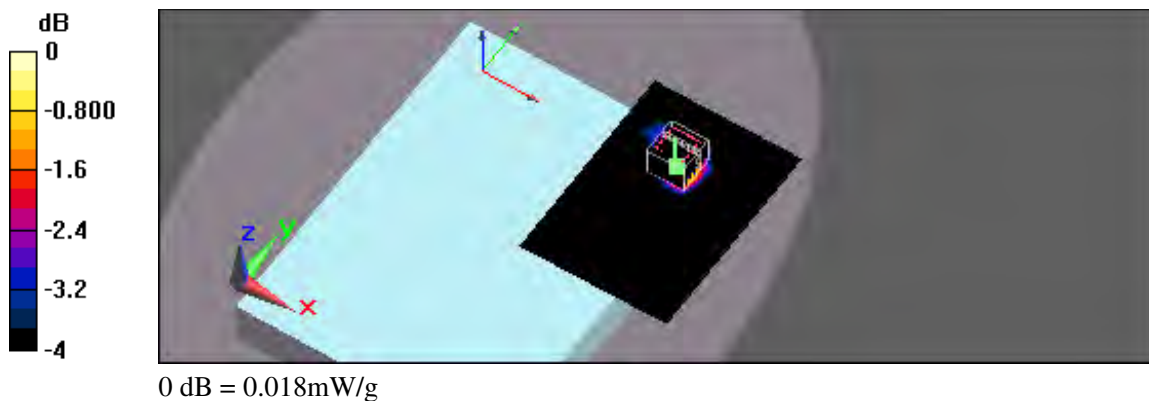

Test Laboratory: A Test Lab Techno Corp.

Date/Time: 11/5/2009 10:42:07 AM

Flat_802.11g CH6_6M_Tablet Mode LCD Tip Close Body

DUT: 112BNHMW_Tablet mode_LCD Tip; Type: WLAN Module;

Serial: ZE90SK01C19391A23B2500

Communication System: IEEE 802.11g; Frequency: 2437 MHz;Duty Cycle: 1:1
 Medium parameters used: $f = 2437 \text{ MHz}$; $\sigma = 1.93 \text{ mho/m}$; $\epsilon_r = 50.9$; $\rho = 1000 \text{ kg/m}^3$
 Phantom section: Flat Section
 Measurement Standard: DASYS (IEEE/IEC)

DASY5 Configuration:

- Probe: ES3DV3 - SN3150; ConvF(4.23, 4.23, 4.23); Calibrated: 1/20/2009
- Sensor-Surface: 3mm (Mechanical Surface Detection)
- Electronics: DAE4 Sn779; Calibrated: 11/11/2008
- Phantom: ELI 4.0; Type: QDOVA001BB; Serial: 1036
- Measurement SW: DASYS, V5.0 Build 125;SEMCAD X Version 13.4 Build 125

Flat/Area Scan (61x111x1):

Measurement grid: $dx=15\text{mm}$, $dy=15\text{mm}$
 Maximum value of SAR (interpolated) = 0.449 mW/g

Flat/Zoom Scan (7x7x9)/Cube 0:

Measurement grid: $dx=5\text{mm}$, $dy=5\text{mm}$, $dz=3\text{mm}$
 Reference Value = 1.31 V/m; Power Drift = -0.152 dB
 Peak SAR (extrapolated) = 0.674 W/kg
SAR(1 g) = 0.339 mW/g; SAR(10 g) = 0.156 mW/g
 Maximum value of SAR (measured) = 0.447 mW/g

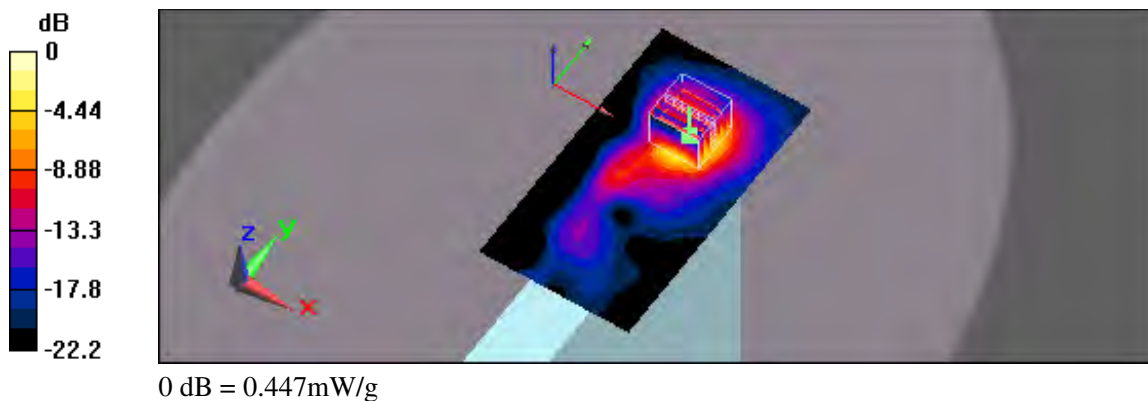

Test Laboratory: A Test Lab Techno Corp.

Date/Time: 11/5/2009 11:22:19 AM

Flat_802.11n(2.4GHz) CH6_6.5M_HT20_Tablet Mode LCD Tip Close Body

DUT: 112BNHMW_Tablet mode_LCD Tip; Type: WLAN Module;

Serial: ZE90SK01C19391A23B2500

Communication System: IEEE 802.11n(2.4GHz); Frequency: 2437 MHz; Duty Cycle: 1:1

Medium parameters used: $f = 2437 \text{ MHz}$; $\sigma = 1.93 \text{ mho/m}$; $\epsilon_r = 50.9$; $\rho = 1000 \text{ kg/m}^3$

Phantom section: Flat Section

Measurement Standard: DASYS (IEEE/IEC)

DASY5 Configuration:

- Probe: ES3DV3 - SN3150; ConvF(4.23, 4.23, 4.23); Calibrated: 1/20/2009
- Sensor-Surface: 3mm (Mechanical Surface Detection)
- Electronics: DAE4 Sn779; Calibrated: 11/11/2008
- Phantom: ELI 4.0; Type: QDOVA001BB; Serial: 1036
- Measurement SW: DASYS, V5.0 Build 125; SEMCAD X Version 13.4 Build 125

Flat/Area Scan (61x111x1):

Measurement grid: $dx=15\text{mm}$, $dy=15\text{mm}$

Maximum value of SAR (interpolated) = 0.383 mW/g

Flat/Zoom Scan (7x7x9)/Cube 0:

Measurement grid: $dx=5\text{mm}$, $dy=5\text{mm}$, $dz=3\text{mm}$

Reference Value = 1.16 V/m; Power Drift = 0.149 dB

Peak SAR (extrapolated) = 0.573 W/kg

SAR(1 g) = 0.290 mW/g; SAR(10 g) = 0.133 mW/g

Maximum value of SAR (measured) = 0.382 mW/g

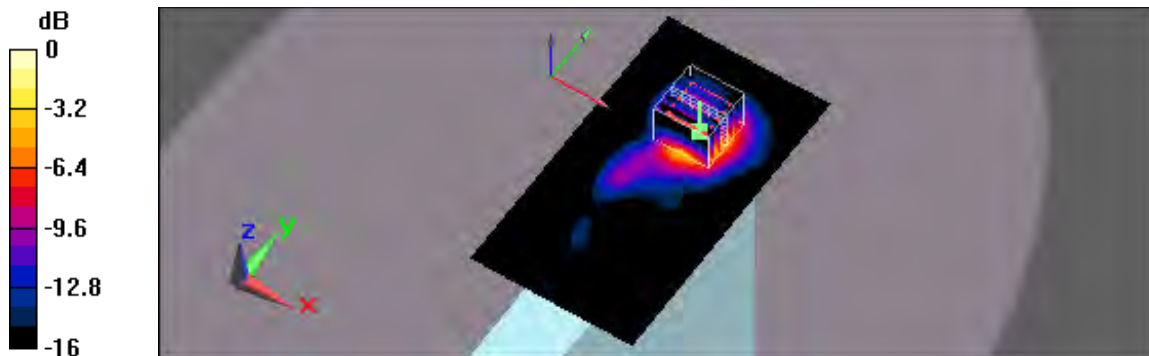

0 dB = 0.382mW/g

Test Laboratory: A Test Lab Techno Corp.

Date/Time: 11/5/2009 11:49:20 AM

Flat_802.11n(2.4GHz) CH6_13.5M_HT40_Tablet Mode LCD Tip Close Body

DUT: 112BNHMW_Tablet mode_LCD Tip; Type: WLAN Module;

Serial: ZE90SK01C19391A23B2500

Communication System: IEEE 802.11n(2.4GHz); Frequency: 2437 MHz; Duty Cycle: 1:1

Medium parameters used: $f = 2437 \text{ MHz}$; $\sigma = 1.93 \text{ mho/m}$; $\epsilon_r = 50.9$; $\rho = 1000 \text{ kg/m}^3$

Phantom section: Flat Section

Measurement Standard: DASYS (IEEE/IEC)

DASY5 Configuration:

- Probe: ES3DV3 - SN3150; ConvF(4.23, 4.23, 4.23); Calibrated: 1/20/2009
- Sensor-Surface: 3mm (Mechanical Surface Detection)
- Electronics: DAE4 Sn779; Calibrated: 11/11/2008
- Phantom: ELI 4.0; Type: QDOVA001BB; Serial: 1036
- Measurement SW: DASYS, V5.0 Build 125; SEMCAD X Version 13.4 Build 125

Flat/Area Scan (61x111x1):

Measurement grid: $dx=15\text{mm}$, $dy=15\text{mm}$

Maximum value of SAR (interpolated) = 0.134 mW/g

Flat/Zoom Scan (7x7x9)/Cube 0:

Measurement grid: $dx=5\text{mm}$, $dy=5\text{mm}$, $dz=3\text{mm}$

Reference Value = 0.926 V/m; Power Drift = -0.129 dB

Peak SAR (extrapolated) = 0.202 W/kg

SAR(1 g) = 0.101 mW/g; SAR(10 g) = 0.046 mW/g

Maximum value of SAR (measured) = 0.134 mW/g

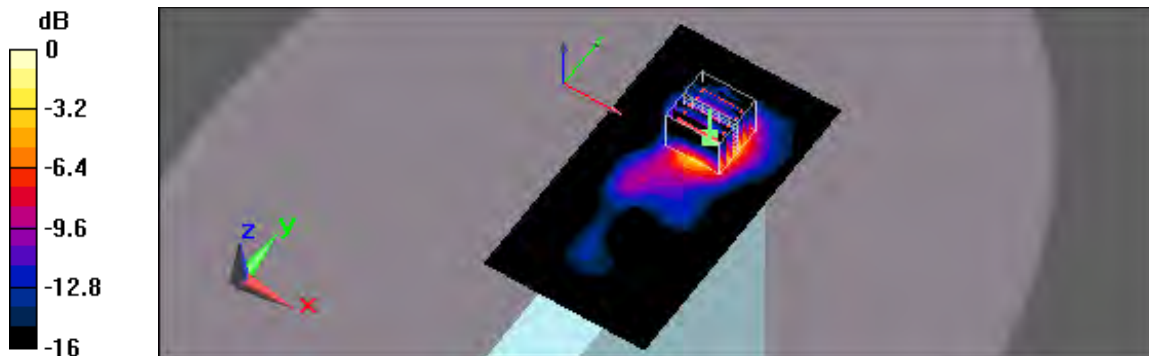

0 dB = 0.134mW/g



Appendix C - Calibration

All of the instruments Calibration information are listed below.

- Dipole _ D2450V2 SN:712 Calibration No.D2450V2-712_Feb09
- Probe _ ES3DV3 SN:3150 Calibration No.ES3-3150_Jan09
- DAE _ DAE4 SN:779 Calibration No.DAE4-779_ Nov08



**Calibration Laboratory of
Schmid & Partner
Engineering AG**
Zeughausstrasse 43, 8004 Zurich, Switzerland



S Schweizerischer Kalibrierdienst
S Service suisse d'étalonnage
C Servizio svizzero di taratura
S Swiss Calibration Service

Accredited by the Swiss Accreditation Service (SAS)
The Swiss Accreditation Service is one of the signatories to the EA
Multilateral Agreement for the recognition of calibration certificates

Accreditation No.: **SCS 108**

Client **ATL (Auden)**

Certificate No: **D2450V2-712_Feb09**

CALIBRATION CERTIFICATE

Object **D2450V2 - SN: 712**

Calibration procedure(s) **QA CAL-05.v7
Calibration procedure for dipole validation kits**

Calibration date: **February 11, 2009**

Condition of the calibrated item **In Tolerance**

This calibration certificate documents the traceability to national standards, which realize the physical units of measurements (SI).
The measurements and the uncertainties with confidence probability are given on the following pages and are part of the certificate.

All calibrations have been conducted in the closed laboratory facility: environment temperature (22 ± 3)°C and humidity < 70%.

Calibration Equipment used (M&TE critical for calibration)

Primary Standards	ID #	Cal Date (Certificate No.)	Scheduled Calibration
Power meter EPM-442A	GB37480704	08-Oct-08 (No. 217-00898)	Oct-09
Power sensor HP 8481A	US37292783	08-Oct-08 (No. 217-00898)	Oct-09
Reference 20 dB Attenuator	SN: S5086 (20g)	01-Jul-08 (No. 217-00864)	Jul-09
Type-N mismatch combination	SN: 5047.2 / 06327	01-Jul-08 (No. 217-00867)	Jul-09
Reference Probe ES3DV2	SN: 3025	28-Apr-08 (No. ES3-3025_Apr08)	Apr-09
DAE4	SN: 601	14-Mar-08 (No. DAE4-601_Mar08)	Mar-09
Secondary Standards	ID #	Check Date (in house)	Scheduled Check
Power sensor HP 8481A	MY41092317	18-Oct-02 (in house check Oct-07)	In house check: Oct-09
RF generator R&S SMT-06	100005	4-Aug-99 (in house check Oct-07)	In house check: Oct-09
Network Analyzer HP 8753E	US37390585 S4206	18-Oct-01 (in house check Oct-08)	In house check: Oct-09

	Name	Function	Signature
Calibrated by:	Mike Meili	Laboratory Technician	
Approved by:	Katja Pokovic	Technical Manager	

Issued: February 11, 2009

This calibration certificate shall not be reproduced except in full without written approval of the laboratory.

**Calibration Laboratory of
Schmid & Partner
Engineering AG**
Zeughausstrasse 43, 8004 Zurich, Switzerland



S Schweizerischer Kalibrierdienst
C Service suisse d'étalonnage
S Servizio svizzero di taratura
S Swiss Calibration Service

Accredited by the Swiss Accreditation Service (SAS)

The Swiss Accreditation Service is one of the signatories to the EA
Multilateral Agreement for the recognition of calibration certificates

Accreditation No.: **SCS 108**

Glossary:

TSL	tissue simulating liquid
ConvF	sensitivity in TSL / NORM x,y,z
N/A	not applicable or not measured

Calibration is Performed According to the Following Standards:

- IEEE Std 1528-2003, "IEEE Recommended Practice for Determining the Peak Spatial-Averaged Specific Absorption Rate (SAR) in the Human Head from Wireless Communications Devices: Measurement Techniques", December 2003
- IEC 62209-1, "Procedure to measure the Specific Absorption Rate (SAR) for hand-held devices used in close proximity to the ear (frequency range of 300 MHz to 3 GHz)", February 2005
- Federal Communications Commission Office of Engineering & Technology (FCC OET), "Evaluating Compliance with FCC Guidelines for Human Exposure to Radiofrequency Electromagnetic Fields; Additional Information for Evaluating Compliance of Mobile and Portable Devices with FCC Limits for Human Exposure to Radiofrequency Emissions", Supplement C (Edition 01-01) to Bulletin 65

Additional Documentation:

- DASY4/5 System Handbook

Methods Applied and Interpretation of Parameters:

- Measurement Conditions:** Further details are available from the Validation Report at the end of the certificate. All figures stated in the certificate are valid at the frequency indicated.
- Antenna Parameters with TSL:** The dipole is mounted with the spacer to position its feed point exactly below the center marking of the flat phantom section, with the arms oriented parallel to the body axis.
- Feed Point Impedance and Return Loss:** These parameters are measured with the dipole positioned under the liquid filled phantom. The impedance stated is transformed from the measurement at the SMA connector to the feed point. The Return Loss ensures low reflected power. No uncertainty required.
- Electrical Delay:** One-way delay between the SMA connector and the antenna feed point. No uncertainty required.
- SAR measured:** SAR measured at the stated antenna input power.
- SAR normalized:** SAR as measured, normalized to an input power of 1 W at the antenna connector.
- SAR for nominal TSL parameters:** The measured TSL parameters are used to calculate the nominal SAR result.

Measurement Conditions

DASY system configuration, as far as not given on page 1.

DASY Version	DASY5	V5.0
Extrapolation	Advanced Extrapolation	
Phantom	Modular Flat Phantom V5.0	
Distance Dipole Center - TSL	10 mm	with Spacer
Zoom Scan Resolution	dx, dy, dz = 5 mm	
Frequency	2450 MHz ± 1 MHz	

Head TSL parameters

The following parameters and calculations were applied.

	Temperature	Permittivity	Conductivity
Nominal Head TSL parameters	22.0 °C	39.2	1.80 mho/m
Measured Head TSL parameters	(22.0 ± 0.2) °C	38.0 ± 6 %	1.82 mho/m ± 6 %
Head TSL temperature during test	(22.0 ± 0.2) °C	----	----

SAR result with Head TSL

SAR averaged over 1 cm³ (1 g) of Head TSL	Condition	
SAR measured	250 mW input power	13.1 mW / g
SAR normalized	normalized to 1W	52.4 mW / g
SAR for nominal Head TSL parameters ¹	normalized to 1W	51.8 mW /g ± 17.0 % (k=2)

SAR averaged over 10 cm³ (10 g) of Head TSL	condition	
SAR measured	250 mW input power	6.13 mW / g
SAR normalized	normalized to 1W	24.5 mW / g
SAR for nominal Head TSL parameters ¹	normalized to 1W	24.3 mW /g ± 16.5 % (k=2)

¹ Correction to nominal TSL parameters according to d), chapter "SAR Sensitivities"



Body TSL parameters

The following parameters and calculations were applied.

	Temperature	Permittivity	Conductivity
Nominal Body TSL parameters	22.0 °C	52.7	1.95 mho/m
Measured Body TSL parameters	(22.0 ± 0.2) °C	53.9 ± 6 %	2.00 mho/m ± 6 %
Body TSL temperature during test	(21.1 ± 0.2) °C	----	----

SAR result with Body TSL

SAR averaged over 1 cm ³ (1 g) of Body TSL	Condition	
SAR measured	250 mW input power	13.2 mW / g
SAR normalized	normalized to 1W	52.8 mW / g
SAR for nominal Body TSL parameters ²	normalized to 1W	52.3 mW /g ± 17.0 % (k=2)

SAR averaged over 10 cm ³ (10 g) of Body TSL	condition	
SAR measured	250 mW input power	6.18 mW / g
SAR normalized	normalized to 1W	24.7 mW / g
SAR for nominal Body TSL parameters ²	normalized to 1W	24.7 mW /g ± 16.5 % (k=2)

² Correction to nominal TSL parameters according to d), chapter "SAR Sensitivities"



Appendix

Antenna Parameters with Head TSL

Impedance, transformed to feed point	$55.7 \Omega + 1.1 j\Omega$
Return Loss	- 25.2 dB

Antenna Parameters with Body TSL

Impedance, transformed to feed point	$50.5 \Omega + 5.0 j\Omega$
Return Loss	- 26.0 dB

General Antenna Parameters and Design

Electrical Delay (one direction)	1.158 ns
----------------------------------	----------

After long term use with 100W radiated power, only a slight warming of the dipole near the feedpoint can be measured.

The dipole is made of standard semirigid coaxial cable. The center conductor of the feeding line is directly connected to the second arm of the dipole. The antenna is therefore short-circuited for DC-signals.

No excessive force must be applied to the dipole arms, because they might bend or the soldered connections near the feedpoint may be damaged.

Additional EUT Data

Manufactured by	SPEAG
Manufactured on	July 5, 2002

DASY5 Validation Report for Head TSL

Date/Time: 04.02.2009 12:44:28

Test Laboratory: SPEAG, Zurich, Switzerland

DUT: Dipole 2450 MHz; Type: D2450V2; Serial: D2450V2 - SN712

Communication System: CW; Frequency: 2450 MHz; Duty Cycle: 1:1

Medium: HSL U10 BB

Medium parameters used: $f = 2450$ MHz; $\sigma = 1.82$ mho/m; $\epsilon_r = 38$; $\rho = 1000$ kg/m³

Phantom section: Flat Section

Measurement Standard: DASY5 (IEEE/IEC)

DASY5 Configuration:

- Probe: ES3DV2 - SN3025; ConvF(4.4, 4.4, 4.4); Calibrated: 28.04.2008
- Sensor-Surface: 3.4mm (Mechanical Surface Detection)
- Electronics: DAE4 Sn601; Calibrated: 14.03.2008
- Phantom: Flat Phantom 5.0 (front); Type: QD000P50AA; Serial: 1001
- Measurement SW: DASY5, V5.0 Build 120; SEMCAD X Version 13.4 Build 45

Pin = 250 mW; d = 10 mm/Zoom Scan (7x7x7)/Cube 0:

Measurement grid: dx=5mm, dy=5mm, dz=5mm

Reference Value = 95.6 V/m; Power Drift = 0.00522 dB

Peak SAR (extrapolated) = 27.5 W/kg

SAR(1 g) = 13.1 mW/g; SAR(10 g) = 6.13 mW/g

Maximum value of SAR (measured) = 15.8 mW/g

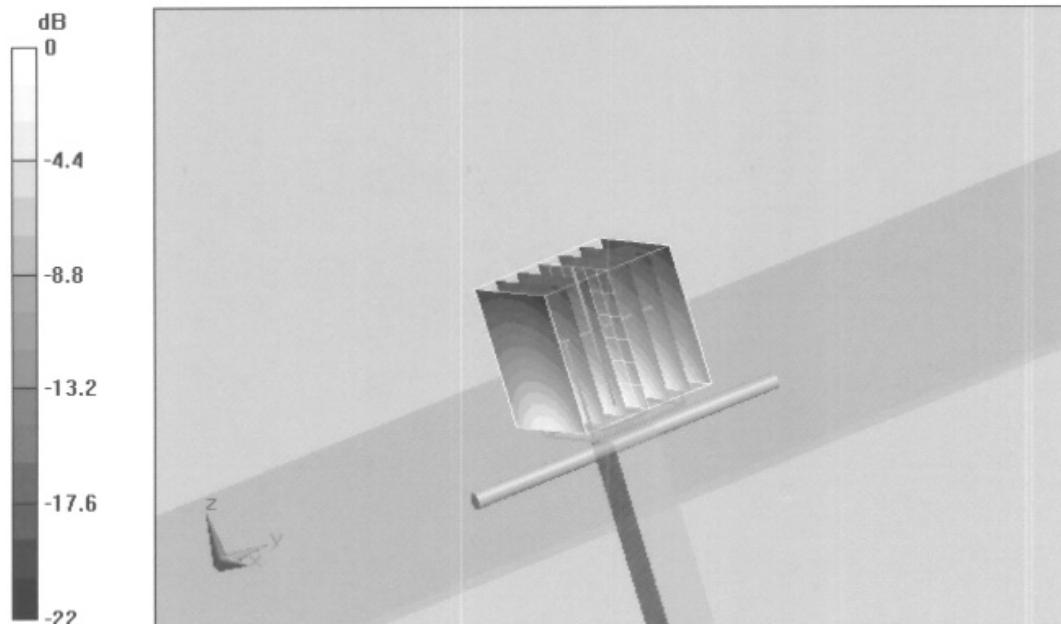

0 dB = 15.8mW/g



Impedance Measurement Plot for Head TSL

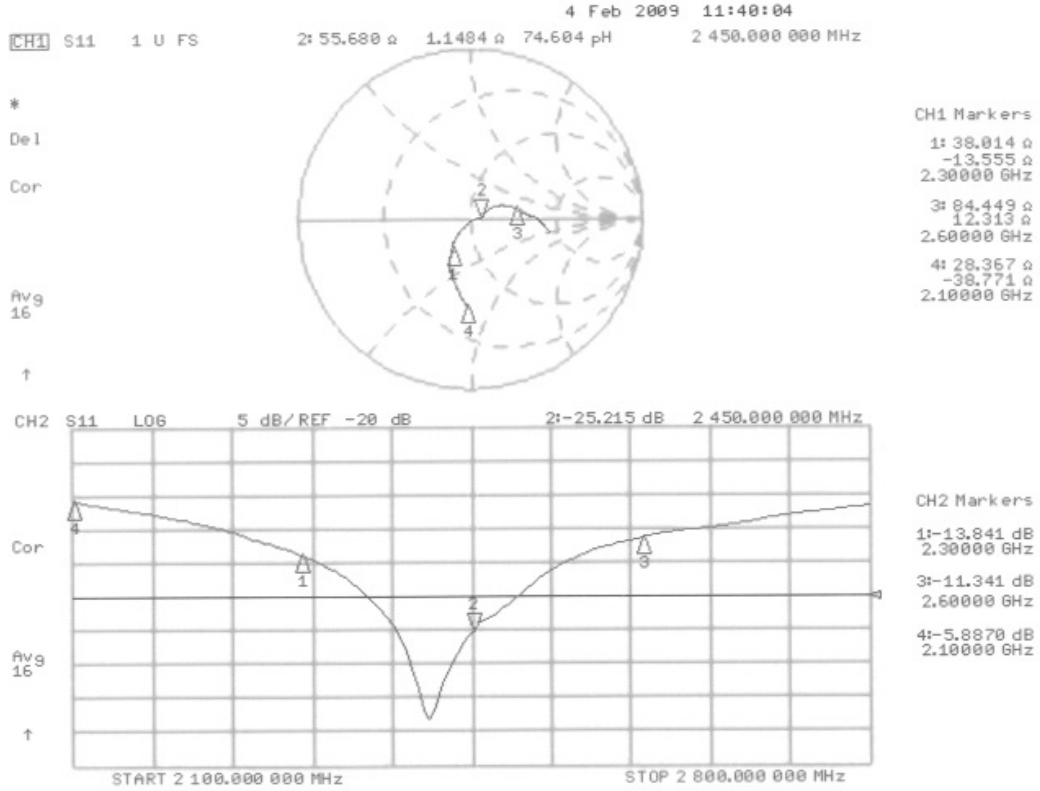

DASY5 Validation Report for Body TSL

Date/Time: 11.02.2009 11:51:07

Test Laboratory: SPEAG, Zurich, Switzerland

DUT: Dipole 2450 MHz; Type: D2450V2; Serial: D2450V2 - SN:712

Communication System: CW; Frequency: 2450 MHz; Duty Cycle: 1:1

Medium: MSL U10 BB

Medium parameters used: $f = 2450 \text{ MHz}$; $\sigma = 2.01 \text{ mho/m}$; $\epsilon_r = 54$; $\rho = 1000 \text{ kg/m}^3$

Phantom section: Flat Section

Measurement Standard: DASY5 (IEEE/IEC)

DASY5 Configuration:

- Probe: ES3DV2 - SN3025; ConvF(4.07, 4.07, 4.07); Calibrated: 28.04.2008
- Sensor-Surface: 3.4mm (Mechanical Surface Detection)
- Electronics: DAE4 Sn601; Calibrated: 14.03.2008
- Phantom: Flat Phantom 5.0 (back); Type: QD000P50AA; Serial: 1002
- Measurement SW: DASY5, V5.0 Build 120; SEMCAD X Version 13.4 Build 45

Pin = 250 mW; d = 10 mm/Zoom Scan (7x7x7)/Cube 0:

Measurement grid: $dx=5\text{mm}$, $dy=5\text{mm}$, $dz=5\text{mm}$

Reference Value = 92.8 V/m; Power Drift = 0.00271 dB

Peak SAR (extrapolated) = 26.7 W/kg

SAR(1 g) = 13.2 mW/g; SAR(10 g) = 6.18 mW/g

Maximum value of SAR (measured) = 16.4 mW/g

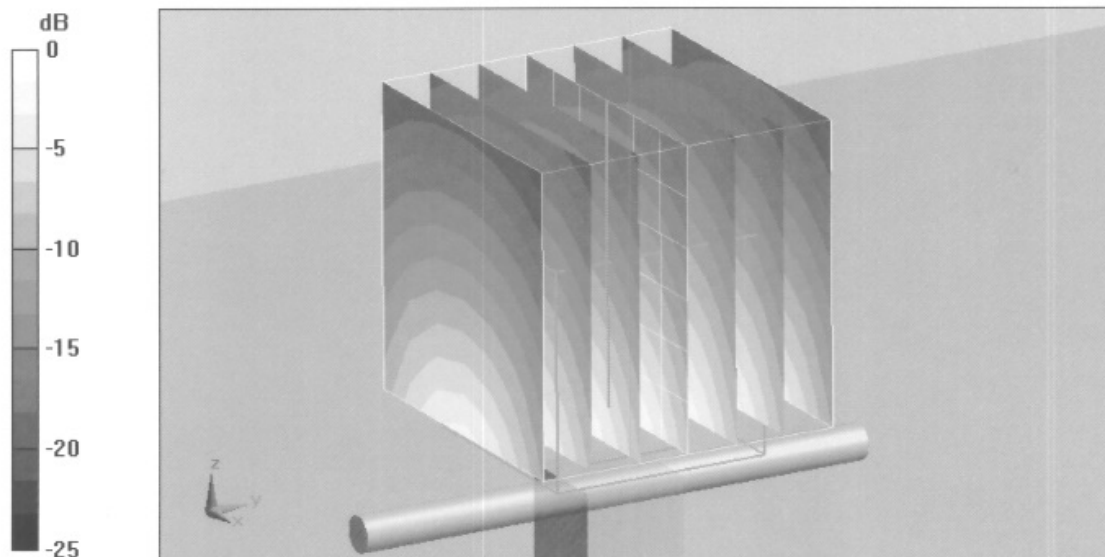

0 dB = 16.4mW/g



Impedance Measurement Plot for Body TSL

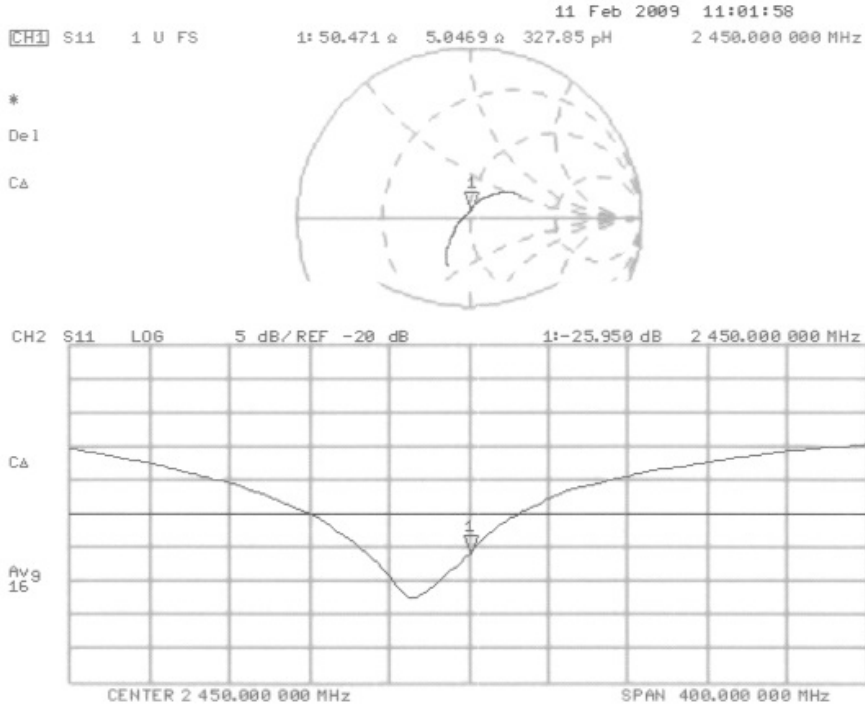



Calibration Laboratory of
Schmid & Partner
Engineering AG
 Zeughausstrasse 43, 8004 Zurich, Switzerland



S Schweizerischer Kalibrierdienst
S Service suisse d'étalonnage
S Servizio svizzero di taratura
S Swiss Calibration Service

Accredited by the Swiss Accreditation Service (SAS)
 The Swiss Accreditation Service is one of the signatories to the EA
 Multilateral Agreement for the recognition of calibration certificates

Accreditation No.: **SCS 108**

Client **ATL (Auden)**

Certificate No: **ES3-3150_Jan09**

CALIBRATION CERTIFICATE

Object **ES3DV3 - SN:3150**

Calibration procedure(s) **QA CAL-01.v6, QA CAL-12.v5 and QA CAL-23.v3
 Calibration procedure for dosimetric E-field probes**

Calibration date: **January 20, 2009**

Condition of the calibrated item **In Tolerance**

This calibration certificate documents the traceability to national standards, which realize the physical units of measurements (SI).
 The measurements and the uncertainties with confidence probability are given on the following pages and are part of the certificate.

All calibrations have been conducted in the closed laboratory facility: environment temperature (22 ± 3)°C and humidity < 70%.

Calibration Equipment used (M&TE critical for calibration)

Primary Standards	ID #	Cal Date (Certificate No.)	Scheduled Calibration
Power meter E4419B	GB41293874	1-Apr-08 (No. 217-00788)	Apr-09
Power sensor E4412A	MY41495277	1-Apr-08 (No. 217-00788)	Apr-09
Power sensor E4412A	MY41498087	1-Apr-08 (No. 217-00788)	Apr-09
Reference 3 dB Attenuator	SN: S5054 (3c)	1-Jul-08 (No. 217-00865)	Jul-09
Reference 20 dB Attenuator	SN: S5086 (20b)	31-Mar-08 (No. 217-00787)	Apr-09
Reference 30 dB Attenuator	SN: S5129 (30b)	1-Jul-08 (No. 217-00866)	Jul-09
Reference Probe ES3DV2	SN: 3013	2-Jan-09 (No. ES3-3013_Jan09)	Jan-10
DAE4	SN: 660	9-Sep-08 (No. DAE4-660_Sep08)	Sep-09

Secondary Standards	ID #	Check Date (in house)	Scheduled Check
RF generator HP 8648C	US3642U01700	4-Aug-99 (in house check Oct-07)	In house check: Oct-09
Network Analyzer HP 8753E	US37390585	18-Oct-01 (in house check Oct-08)	In house check: Oct-09

	Name	Function	Signature
Calibrated by:	Katja Pokovic	Technical Manager	
Approved by:	Niels Kuster	Quality Manager	

Issued: January 20, 2009

This calibration certificate shall not be reproduced except in full without written approval of the laboratory.

**Calibration Laboratory of
Schmid & Partner
Engineering AG**
Zeughausstrasse 43, 8004 Zurich, Switzerland



S Schweizerischer Kalibrierdienst
S Service suisse d'étalonnage
S Servizio svizzero di taratura
S Swiss Calibration Service

Accredited by the Swiss Accreditation Service (SAS)
The Swiss Accreditation Service is one of the signatories to the EA
Multilateral Agreement for the recognition of calibration certificates

Accreditation No.: **SCS 108**

Glossary:

TSL	tissue simulating liquid
NORM _{x,y,z}	sensitivity in free space
ConvF	sensitivity in TSL / NORM _{x,y,z}
DCP	diode compression point
Polarization ϕ	ϕ rotation around probe axis
Polarization ϑ	ϑ rotation around an axis that is in the plane normal to probe axis (at measurement center), i.e., $\vartheta = 0$ is normal to probe axis

Calibration is Performed According to the Following Standards:

- IEEE Std 1528-2003, "IEEE Recommended Practice for Determining the Peak Spatial-Averaged Specific Absorption Rate (SAR) in the Human Head from Wireless Communications Devices: Measurement Techniques", December 2003
- IEC 62209-1, "Procedure to measure the Specific Absorption Rate (SAR) for hand-held devices used in close proximity to the ear (frequency range of 300 MHz to 3 GHz)", February 2005

Methods Applied and Interpretation of Parameters:

- NORM_{x,y,z}**: Assessed for E-field polarization $\vartheta = 0$ ($f \leq 900$ MHz in TEM-cell; $f > 1800$ MHz: R22 waveguide). NORM_{x,y,z} are only intermediate values, i.e., the uncertainties of NORM_{x,y,z} does not effect the E²-field uncertainty inside TSL (see below *ConvF*).
- NORM(f)_{x,y,z}** = NORM_{x,y,z} * *frequency_response* (see Frequency Response Chart). This linearization is implemented in DASY4 software versions later than 4.2. The uncertainty of the frequency response is included in the stated uncertainty of *ConvF*.
- DCP_{x,y,z}**: DCP are numerical linearization parameters assessed based on the data of power sweep (no uncertainty required). DCP does not depend on frequency nor media.
- ConvF and Boundary Effect Parameters**: Assessed in flat phantom using E-field (or Temperature Transfer Standard for $f \leq 800$ MHz) and inside waveguide using analytical field distributions based on power measurements for $f > 800$ MHz. The same setups are used for assessment of the parameters applied for boundary compensation (alpha, depth) of which typical uncertainty values are given. These parameters are used in DASY4 software to improve probe accuracy close to the boundary. The sensitivity in TSL corresponds to NORM_{x,y,z} * *ConvF* whereby the uncertainty corresponds to that given for *ConvF*. A frequency dependent *ConvF* is used in DASY version 4.4 and higher which allows extending the validity from ± 50 MHz to ± 100 MHz.
- Spherical isotropy (3D deviation from isotropy)**: in a field of low gradients realized using a flat phantom exposed by a patch antenna.
- Sensor Offset**: The sensor offset corresponds to the offset of virtual measurement center from the probe tip (on probe axis). No tolerance required.



ES3DV3 SN:3150

January 20, 2009

Probe ES3DV3

SN:3150

Manufactured:	June 12, 2007
Last calibrated:	January 9, 2008
Recalibrated:	January 20, 2009

Calibrated for DASY Systems

(Note: non-compatible with DASY2 system!)



ES3DV3 SN:3150

January 20, 2009

DASY - Parameters of Probe: ES3DV3 SN:3150

Sensitivity in Free Space ^A			Diode Compression ^B	
NormX	1.25 ± 10.1%	$\mu\text{V}/(\text{V}/\text{m})^2$	DCP X	93 mV
NormY	1.26 ± 10.1%	$\mu\text{V}/(\text{V}/\text{m})^2$	DCP Y	95 mV
NormZ	1.25 ± 10.1%	$\mu\text{V}/(\text{V}/\text{m})^2$	DCP Z	94 mV

Sensitivity in Tissue Simulating Liquid (Conversion Factors)

Please see Page 8.

Boundary Effect

TSL **900 MHz** **Typical SAR gradient: 5 % per mm**

Sensor Center to Phantom Surface Distance		3.0 mm	4.0 mm
SAR _{be} [%]	Without Correction Algorithm	9.9	6.5
SAR _{be} [%]	With Correction Algorithm	0.8	0.4

TSL **1810 MHz** **Typical SAR gradient: 10 % per mm**

Sensor Center to Phantom Surface Distance		3.0 mm	4.0 mm
SAR _{be} [%]	Without Correction Algorithm	11.5	7.6
SAR _{be} [%]	With Correction Algorithm	0.8	0.5

Sensor Offset

Probe Tip to Sensor Center **2.0 mm**

The reported uncertainty of measurement is stated as the standard uncertainty of measurement multiplied by the coverage factor k=2, which for a normal distribution corresponds to a coverage probability of approximately 95%.

^A The uncertainties of NormX,Y,Z do not affect the E²-field uncertainty inside TSL (see Page 8).

^B Numerical linearization parameter: uncertainty not required.

Frequency Response of E-Field

(TEM-Cell:ifi110 EXX, Waveguide: R22)

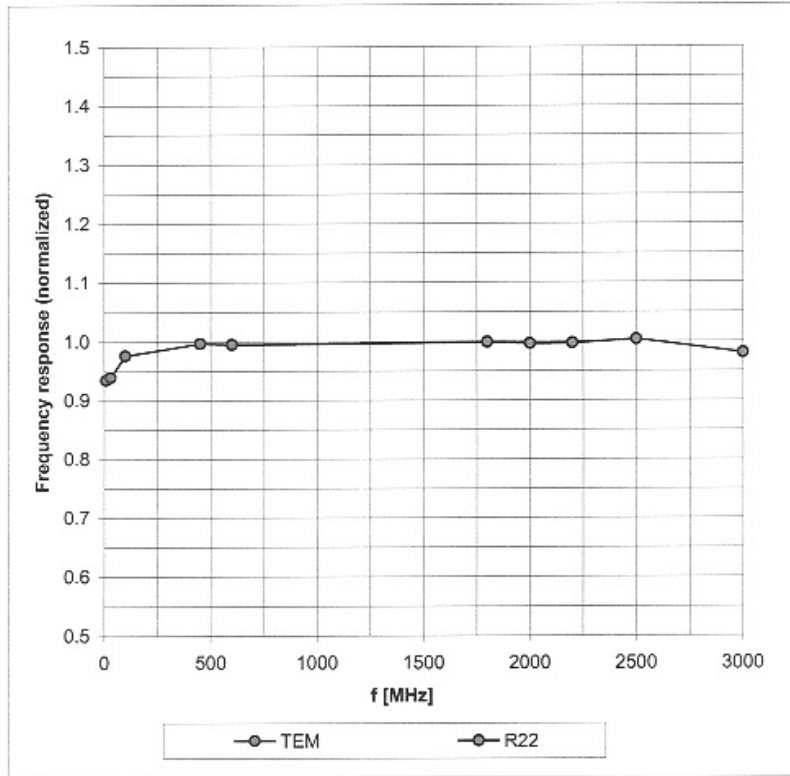

Uncertainty of Frequency Response of E-field: $\pm 6.3\%$ (k=2)

Receiving Pattern (ϕ), $\vartheta = 0^\circ$

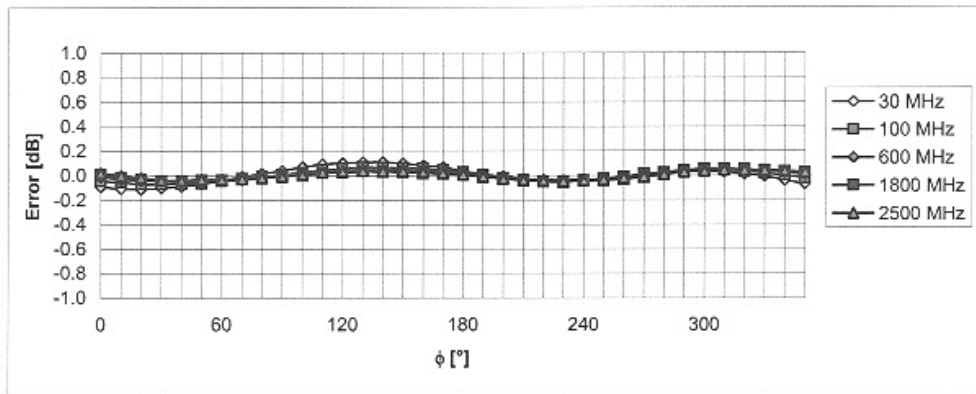
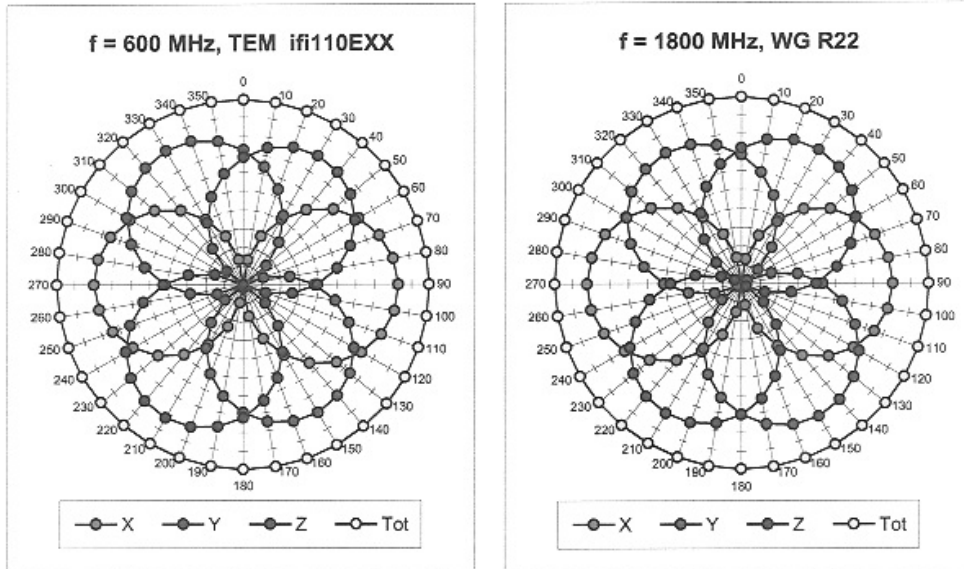

Uncertainty of Axial Isotropy Assessment: $\pm 0.5\%$ ($k=2$)

Dynamic Range f(SAR_{head}) (Waveguide R22, f = 1800 MHz)

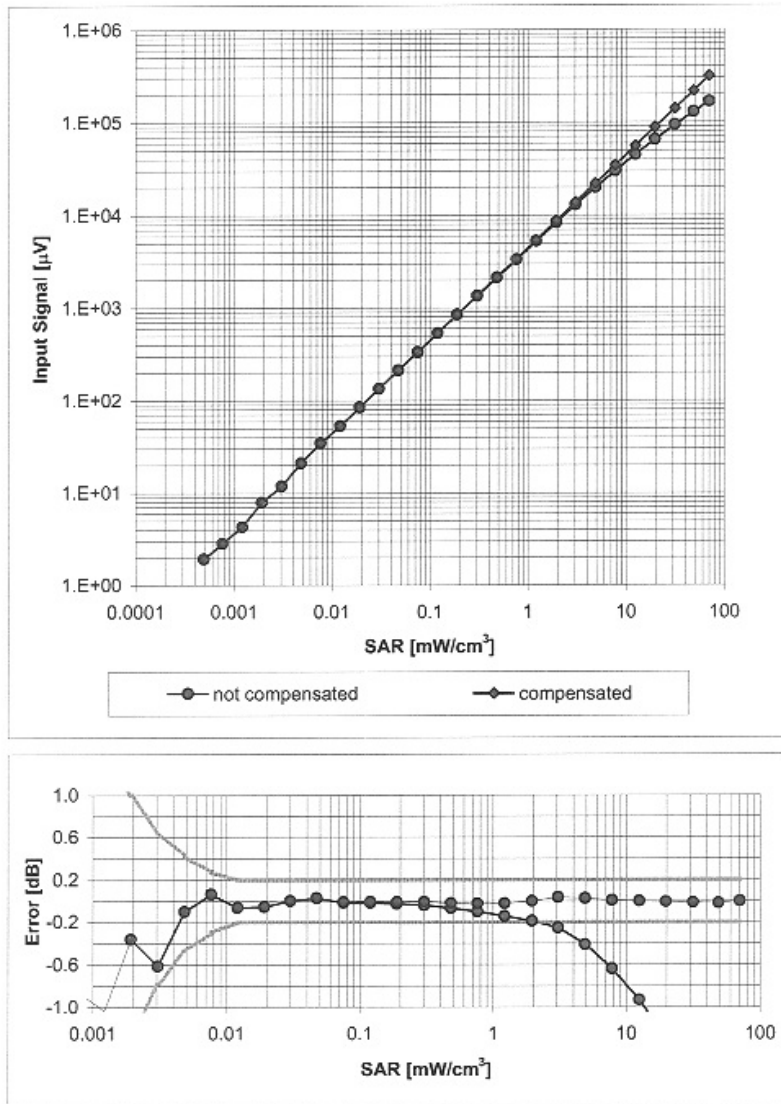

Uncertainty of Linearity Assessment: ± 0.6% (k=2)

Conversion Factor Assessment

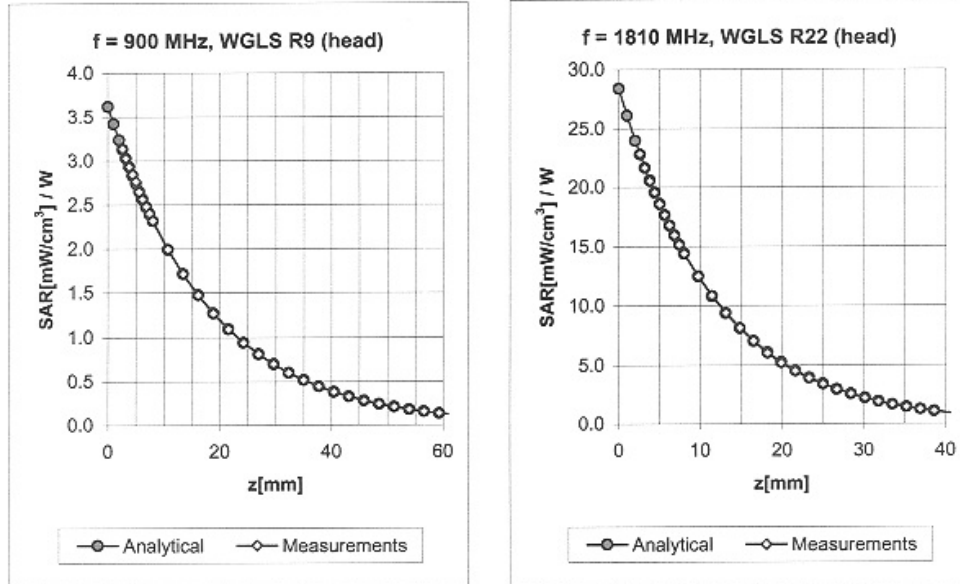

f [MHz]	Validity [MHz] ^c	TSL	Permittivity	Conductivity	Alpha	Depth	ConvF Uncertainty
450	± 50 / ± 100	Head	43.5 ± 5%	0.87 ± 5%	0.32	1.49	6.25 ± 13.3% (k=2)
900	± 50 / ± 100	Head	41.5 ± 5%	0.97 ± 5%	0.41	1.69	5.91 ± 11.0% (k=2)
1810	± 50 / ± 100	Head	40.0 ± 5%	1.40 ± 5%	0.39	2.06	5.04 ± 11.0% (k=2)
2000	± 50 / ± 100	Head	40.0 ± 5%	1.40 ± 5%	0.28	2.95	4.88 ± 11.0% (k=2)
2450	± 50 / ± 100	Head	39.2 ± 5%	1.80 ± 5%	0.36	2.44	4.59 ± 11.0% (k=2)
450	± 50 / ± 100	Body	56.7 ± 5%	0.94 ± 5%	0.24	1.23	6.75 ± 13.3% (k=2)
900	± 50 / ± 100	Body	55.0 ± 5%	1.05 ± 5%	0.99	1.09	5.91 ± 11.0% (k=2)
1810	± 50 / ± 100	Body	53.3 ± 5%	1.52 ± 5%	0.44	1.53	4.92 ± 11.0% (k=2)
2000	± 50 / ± 100	Body	53.3 ± 5%	1.52 ± 5%	0.35	1.78	4.77 ± 11.0% (k=2)
2450	± 50 / ± 100	Body	52.7 ± 5%	1.95 ± 5%	0.64	1.30	4.23 ± 11.0% (k=2)

^c The validity of ± 100 MHz only applies for DASY v4.4 and higher (see Page 2). The uncertainty is the RSS of the ConvF uncertainty at calibration frequency and the uncertainty for the indicated frequency band.

Deviation from Isotropy in HSL

Error (ϕ, ϑ), $f = 900$ MHz

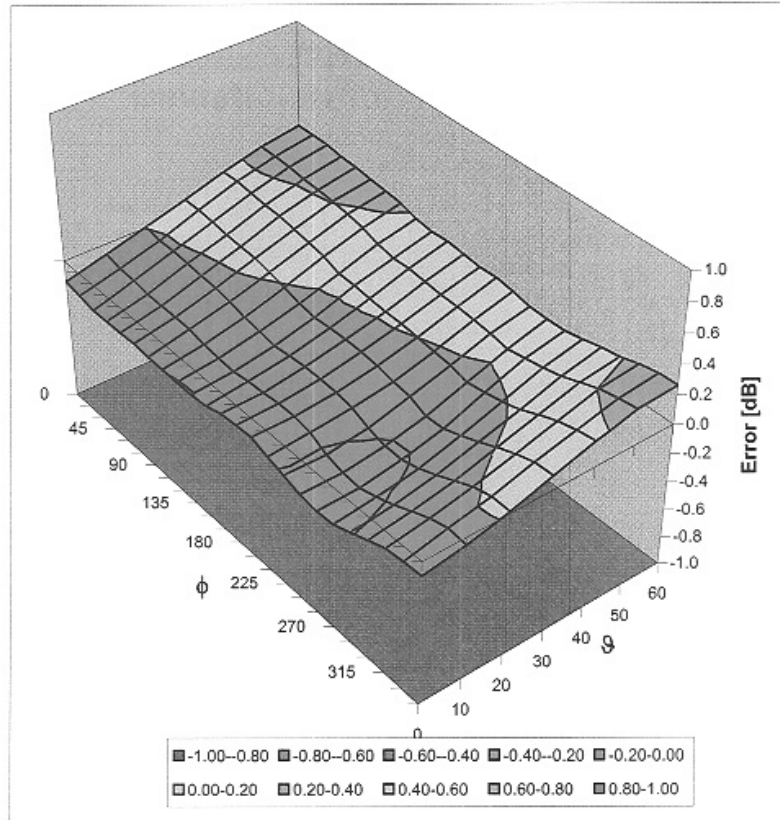

Uncertainty of Spherical Isotropy Assessment: $\pm 2.6\%$ (k=2)



**Calibration Laboratory of
Schmid & Partner
Engineering AG**
Zeughausstrasse 43, 8004 Zurich, Switzerland



S Schweizerischer Kalibrierdienst
C Service suisse d'étalonnage
S Servizio svizzero di taratura
S Swiss Calibration Service

Accredited by the Swiss Accreditation Service (SAS)
The Swiss Accreditation Service is one of the signatories to the EA
Multilateral Agreement for the recognition of calibration certificates

Accreditation No.: **SCS 108**

Client **ATL (Auden)**

Certificate No: **DAE4-779_Nov08**

CALIBRATION CERTIFICATE

Object **DAE4 - SD 000 D04 BJ - SN: 779**

Calibration procedure(s) **QA CAL-06.v12
Calibration procedure for the data acquisition electronics (DAE)**

Calibration date: **November 11, 2008**

Condition of the calibrated item **In Tolerance**

This calibration certificate documents the traceability to national standards, which realize the physical units of measurements (SI).
The measurements and the uncertainties with confidence probability are given on the following pages and are part of the certificate.

All calibrations have been conducted in the closed laboratory facility: environment temperature (22 ± 3)°C and humidity < 70%.

Calibration Equipment used (M&TE critical for calibration)

Primary Standards	ID #	Cal Date (Certificate No.)	Scheduled Calibration
Fluke Process Calibrator Type 702	SN: 6295803	30-Sep-08 (No: 7673)	Sep-09
Keithley Multimeter Type 2001	SN: 0810278	30-Sep-08 (No: 7670)	Sep-09
Secondary Standards	ID #	Check Date (in house)	Scheduled Check
Calibrator Box V1.1	SE UMS 006 AB 1004	06-Jun-08 (in house check)	In house check: Jun-09

	Name	Function	Signature
Calibrated by:	Daniel Hess	Technician	
Approved by:	Fin Bomholt	R&D Director	

Issued: November 11, 2008

This calibration certificate shall not be reproduced except in full without written approval of the laboratory.

Certificate No: DAE4-779_Nov08

Page 1 of 5

**Calibration Laboratory of
Schmid & Partner
Engineering AG**
Zeughausstrasse 43, 8004 Zurich, Switzerland



S Schweizerischer Kalibrierdienst
C Service suisse d'étalonnage
S Servizio svizzero di taratura
S Swiss Calibration Service

Accredited by the Swiss Accreditation Service (SAS)
The Swiss Accreditation Service is one of the signatories to the EA
Multilateral Agreement for the recognition of calibration certificates

Accreditation No.: **SCS 108**

Glossary

DAE data acquisition electronics
Connector angle information used in DASY system to align probe sensor X to the robot coordinate system.

Methods Applied and Interpretation of Parameters

- *DC Voltage Measurement:* Calibration Factor assessed for use in DASY system by comparison with a calibrated instrument traceable to national standards. The figure given corresponds to the full scale range of the voltmeter in the respective range.
- *Connector angle:* The angle of the connector is assessed measuring the angle mechanically by a tool inserted. Uncertainty is not required.
- The following parameters as documented in the Appendix contain technical information as a result from the performance test and require no uncertainty.
 - *DC Voltage Measurement Linearity:* Verification of the Linearity at +10% and -10% of the nominal calibration voltage. Influence of offset voltage is included in this measurement.
 - *Common mode sensitivity:* Influence of a positive or negative common mode voltage on the differential measurement.
 - *Channel separation:* Influence of a voltage on the neighbor channels not subject to an input voltage.
 - *AD Converter Values with inputs shorted:* Values on the internal AD converter corresponding to zero input voltage
 - *Input Offset Measurement:* Output voltage and statistical results over a large number of zero voltage measurements.
 - *Input Offset Current:* Typical value for information; Maximum channel input offset current, not considering the input resistance.
 - *Input resistance:* DAE input resistance at the connector, during internal auto-zeroing and during measurement.
 - *Low Battery Alarm Voltage:* Typical value for information. Below this voltage, a battery alarm signal is generated.
 - *Power consumption:* Typical value for information. Supply currents in various operating modes.



DC Voltage Measurement

A/D - Converter Resolution nominal

High Range: 1LSB = 6.1 μ V , full range = -100...+300 mV

Low Range: 1LSB = 61nV , full range = -1.....+3mV

DASY measurement parameters: Auto Zero Time: 3 sec; Measuring time: 3 sec

Calibration Factors	X	Y	Z
High Range	404.449 \pm 0.1% (k=2)	403.679 \pm 0.1% (k=2)	403.906 \pm 0.1% (k=2)
Low Range	3.97989 \pm 0.7% (k=2)	3.96584 \pm 0.7% (k=2)	3.96834 \pm 0.7% (k=2)

Connector Angle

Connector Angle to be used in DASY system	88 $^{\circ}$ \pm 1 $^{\circ}$
---	----------------------------------

Appendix

1. DC Voltage Linearity

High Range	Input (μV)	Reading (μV)	Error (%)
Channel X + Input	200000	200000.2	0.00
Channel X + Input	20000	20004.76	0.02
Channel X - Input	20000	-20000.46	0.00
Channel Y + Input	200000	199999.9	0.00
Channel Y + Input	20000	20004.23	0.02
Channel Y - Input	20000	-20000.37	0.00
Channel Z + Input	200000	200000.1	0.00
Channel Z + Input	20000	20003.22	0.02
Channel Z - Input	20000	-20000.98	0.00

Low Range	Input (μV)	Reading (μV)	Error (%)
Channel X + Input	2000	1999.9	0.00
Channel X + Input	200	199.15	-0.43
Channel X - Input	200	-200.23	0.11
Channel Y + Input	2000	2000	0.00
Channel Y + Input	200	198.78	-0.61
Channel Y - Input	200	-199.84	-0.08
Channel Z + Input	2000	2000.1	0.00
Channel Z + Input	200	199.55	-0.22
Channel Z - Input	200	-201.30	0.65

2. Common mode sensitivity

DASY measurement parameters: Auto Zero Time: 3 sec; Measuring time: 3 sec

	Common mode Input Voltage (mV)	High Range Average Reading (μV)	Low Range Average Reading (μV)
Channel X	200	-4.34	-5.11
	- 200	5.57	5.20
Channel Y	200	13.81	13.35
	- 200	-14.32	-13.88
Channel Z	200	2.61	2.32
	- 200	-4.14	-4.46

3. Channel separation

DASY measurement parameters: Auto Zero Time: 3 sec; Measuring time: 3 sec

	Input Voltage (mV)	Channel X (μV)	Channel Y (μV)	Channel Z (μV)
Channel X	200	-	2.09	0.14
Channel Y	200	-0.49	-	2.40
Channel Z	200	-1.47	0.22	-

4. AD-Converter Values with inputs shorted

DASY measurement parameters: Auto Zero Time: 3 sec; Measuring time: 3 sec

	High Range (LSB)	Low Range (LSB)
Channel X	15617	15330
Channel Y	15810	15565
Channel Z	16216	15563

5. Input Offset Measurement

DASY measurement parameters: Auto Zero Time: 3 sec; Measuring time: 3 sec

Input 10M Ω

	Average (μ V)	min. Offset (μ V)	max. Offset (μ V)	Std. Deviation (μ V)
Channel X	-0.13	-2.92	1.64	0.57
Channel Y	-0.83	-2.41	0.83	0.63
Channel Z	-1.03	-2.84	-0.06	0.42

6. Input Offset Current

Nominal Input circuitry offset current on all channels: <25fA

7. Input Resistance

	Zeroing (MOhm)	Measuring (MOhm)
Channel X	0.1999	202.2
Channel Y	0.1999	201.5
Channel Z	0.2000	201.5

8. Low Battery Alarm Voltage (verified during pre test)

Typical values	Alarm Level (VDC)
Supply (+ Vcc)	+7.9
Supply (- Vcc)	-7.6

9. Power Consumption (verified during pre test)

Typical values	Switched off (mA)	Stand by (mA)	Transmitting (mA)
Supply (+ Vcc)	+0.0	+6	+14
Supply (- Vcc)	-0.01	-8	-9