



MEASUREMENT REPORT

FCC PART 15.247 902MHz~928MHz

FCC ID: HLZ-AMM
APPLICANT: Acer Incorporated
Application Type: Certification
Product: Air Monitor MATE
Model No.: AMM
FCC Classification: (DTS) Digital Transmission System
FCC Rule Part(s): Part 15.247
Test Procedure(s): ANSI C63.10-2013
Received Date: June 10 ,2021
Test Date: July 8 ~ 17 ,2021

Tested By : *Peter Syu*
(Peter Syu)

Reviewed By : *Paddy Chen*
(Paddy Chen)

Approved By : *Chenz Ker*
(Chenz Ker)



The test results only relate to the tested sample.

This equipment has been shown to be capable of compliance with the applicable technical standards as indicated in the measurement report and was tested in accordance with the measurement procedures specified in ANSI C63.10. Test results reported herein relate only to the item(s) tested.

The test report shall not be reproduced except in full without the written approval of MRT Technology (Taiwan) Co., Ltd.

Revision History

Report No.	Version	Description	Issue Date	Note
2106TW0501-U4	1.0	Original Report	2021-08-20	

CONTENTS

Description	Page
§2.1033 General Information	5
1. INTRODUCTION	6
1.1. Scope	6
1.2. MRT Test Location.....	6
2. PRODUCT INFORMATION	7
2.1. Equipment Description	7
2.2. Product Specification Subjective to this Standard.....	8
2.3. Test Mode	8
2.4. Operation Frequency / Channel List	9
2.5. Test Configuration.....	11
2.6. Test Software.....	11
2.7. EMI Suppression Device(s)/Modifications.....	11
2.8. Labeling Requirements	11
3. DESCRIPTION of TEST	12
3.1. Evaluation Procedure.....	12
3.2. AC Line Conducted Emissions.....	12
3.3. Radiated Emissions	13
4. ANTENNA REQUIREMENTS	14
5. TEST EQUIPMENT CALIBRATION DATE	15
6. MEASUREMENT UNCERTAINTY	16
7. TEST RESULT	17
7.1. Summary.....	17
7.2. 6dB Bandwidth Measurement.....	18
7.2.1. Test Limit.....	18
7.2.2. Test Procedure used	18
7.2.3. Test Setting	18
7.2.4. Test Setup	18
7.2.5. Test Result	19
7.3. Output Power Measurement	20
7.3.1. Test Limit.....	20
7.3.2. Test Procedure Used.....	20
7.3.3. Test Setting	20
7.3.4. Test Setup	20
7.3.5. Test Result of Output Power	21
7.4. Power Spectral Density Measurement.....	22
7.4.1. Test Limit.....	22
7.4.2. Test Procedure Used.....	22
7.4.3. Test Setting	22
7.4.4. Test Setup	22
7.4.5. Test Result	23

7.5.	Out-of-Band Spurious Emissions Emissions Measurement.....	24
7.5.1.	Test Limit	24
7.5.2.	Test Procedure Used.....	24
7.5.3.	Test Settiting	24
7.5.4.	Test Setup	24
7.5.5.	Test Result	25
7.6.	Radiated Spurious Emission Measurement.....	27
7.6.1.	Test Limit	27
7.6.2.	Test Procedure Used.....	27
7.6.3.	Test Setting	27
7.6.4.	Test Setup	29
7.6.5.	Test Result	31
7.7.	Radiated Restricted Band Edge Measurement.....	43
7.7.1.	Test Limit	43
7.7.2.	Test Procedure Used.....	43
7.7.3.	Test Setting	43
7.7.4.	Test Setup	45
7.7.5.	Test Result	46
7.8.	AC Conducted Emissions Measurement	50
7.8.1.	Test Limit	50
7.8.2.	Test Setup	50
7.8.3.	Test Result	51
8.	CONCLUSION	55

§2.1033 General Information

Applicant	Acer Incorporated
Applicant Address	9F, 88, Sec. 1, Xintai 5th Rd., New Taipei City 221, Taiwan
Manufacturer	EcoBear Technology Corp.
Manufacturer Address	7F., No. 303, Sec. 4, Zhongxiao E. Rd., Da'an Dist., Taipei City 106, Taiwan (R.O.C.)
Test Site	MRT Technology (Taiwan) Co., Ltd
Test Site Address	No. 38, Fuxing Second Rd., Guishan Dist., Taoyuan City 333, Taiwan (R.O.C)
MRT FCC Registration No.	291082
FCC Rule Part(s)	Part 15.247
Test Device Serial No.	#1 <input type="checkbox"/> Production <input checked="" type="checkbox"/> Pre-Production <input type="checkbox"/> Engineering

Test Facility / Accreditations

1. MRT facility is a FCC registered (Reg. No. 291082) test facility with the site description report on file and is designated by the FCC as an Accredited Test Firm.
2. MRT facility is an IC registered (MRT Reg. No. 21723) test laboratory with the site description on file at Industry Canada.
3. MRT Lab is accredited to ISO 17025 by the Taiwan Accreditation Foundation (TAF Cert. No. 3261) in EMC, Telecommunications and Radio testing for FCC (Designation Number: TW3261), Industry Taiwan, EU and TELEC Rules.

1. INTRODUCTION

1.1. Scope

Measurement and determination of electromagnetic emissions (EMC) of radio frequency devices including intentional and/or unintentional radiators for compliance with the technical rules and regulations of the Federal Communications Commission and the Industry Canada Certification and Engineering Bureau.

1.2. MRT Test Location

The map below shows the location of the MRT LABORATORY, its proximity to the Taoyuan City. These measurement tests were conducted at the MRT Technology (Taiwan) Co., Ltd. Facility located at No.38, Fuxing 2nd Rd., Guishan Dist., Taoyuan City 33377, Taiwan (R.O.C).

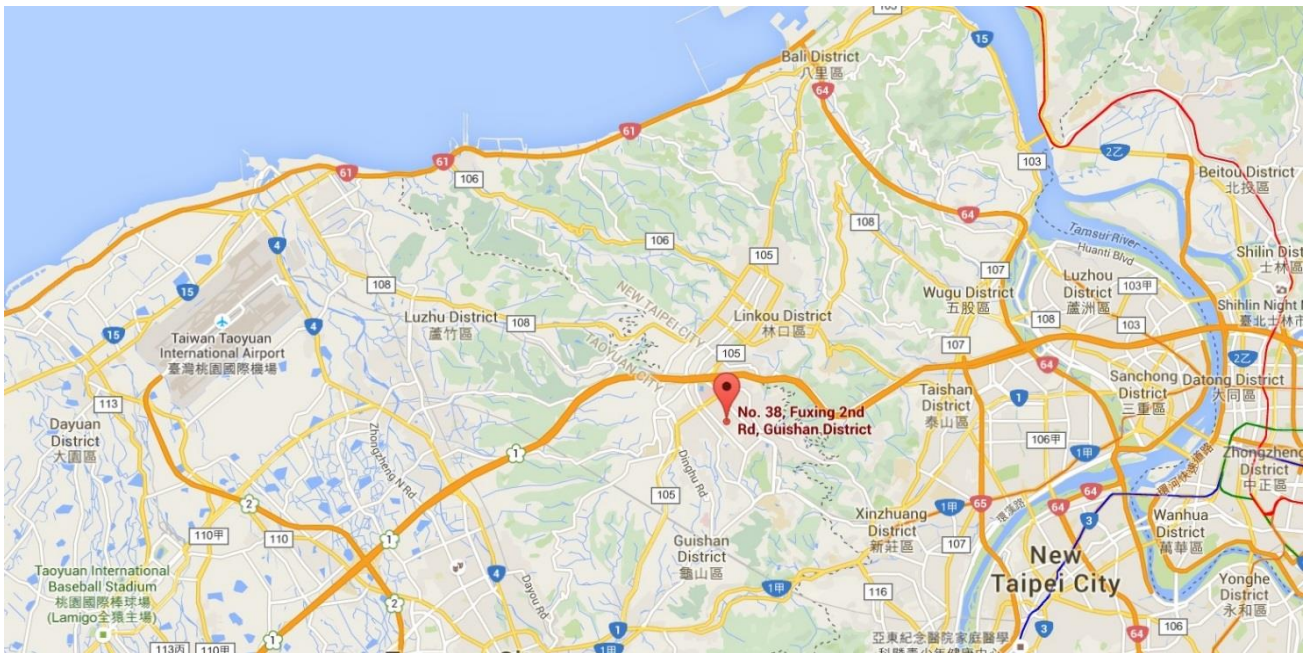

2. PRODUCT INFORMATION

2.1. Equipment Description

Product Name	Air Monitor MATE
Model No.	AMM
Trademark	acer
Supports Radios Spec.	2.4G: 802.11b/g/n-20/n-40 Bluetooth: V5.1 LE LoRa 902MHz~928MHz
LoRa Spec.	902MHz~928MHz
Maximum Power	17.353dBm
Accessory	
USB Cable	Brand: Ecobear Model No: 127-01210316+ Length: 0.2m (Shielded)
Power Adapter	Brand: BSY Model No: BSY01J3050200U U Input: AC 100-240V~ 50-60Hz,0.3A Output: DC 5V, 2A

2.2. Product Specification Subjective to this Standard

Operating Frequency	902MHz~928MHz
Type of modulation	GFSK

2.3. Test Mode

Test Mode	Mode 1: Transmit – by 902.4MHz Mode 2: Transmit – by 915.0MHz Mode 3: Transmit – by 927.6MHz
-----------	--

Note: Regarding to the operation frequency, the lowest, middle and highest frequency are selected to perform the test.

2.4. Operation Frequency / Channel List

Channel	Frequency	Channel	Frequency	Channel	Frequency
0	902.4	29	908.2	58	914
1	902.6	30	908.4	59	914.2
2	902.8	31	908.6	60	914.4
3	903	32	908.8	61	914.6
4	903.2	33	909	62	914.8
5	903.4	34	909.2	63	915
6	903.6	35	909.4	64	915.2
7	903.8	36	909.6	65	915.4
8	904	37	909.8	66	915.6
9	904.2	38	910	67	915.8
10	904.4	39	910.2	68	916
11	904.6	40	910.4	69	916.2
12	904.8	41	910.6	70	916.4
13	905	42	910.8	71	916.6
14	905.2	43	911	72	916.8
15	905.4	44	911.2	73	917
16	905.6	45	911.4	74	917.2
17	905.8	46	911.6	75	917.4
18	906	47	911.8	76	917.6
19	906.2	48	912	77	917.8
20	906.4	49	912.2	78	918
21	906.6	50	912.4	79	918.2
22	906.8	51	912.6	80	918.4
23	907	52	912.8	81	918.6
24	907.2	53	913	82	918.8
25	907.4	54	913.2	83	919
26	907.6	55	913.4	84	919.2
27	907.8	56	913.6	85	919.4
28	908	57	913.8	86	919.6

Channel	Frequency	Channel	Frequency	Channel	Frequency
87	919.8	101	922.6	115	925.4
88	920	102	922.8	116	925.6
89	920.2	103	923	117	925.8
90	920.4	104	923.2	118	926
91	920.6	105	923.4	119	926.2
92	920.8	106	923.6	120	926.4
93	921	107	923.8	121	926.6
94	921.2	108	924	122	926.8
95	921.4	109	924.2	123	927
96	921.6	110	924.4	124	927.2
97	921.8	111	924.6	125	927.4
98	922	112	924.8	126	927.6
99	922.2	113	925	--	--
100	922.4	114	925.2	--	--

2.5. Test Configuration

This device was tested per the guidance of ANSI C63.10-2013. ANSI C63.10-2013 was used to reference the appropriate EUT setup for radiated spurious emissions testing and AC line conducted testing.

2.6. Test Software

The test utility software used during testing was “SerialPort Test”.

2.7. EMI Suppression Device(s)/Modifications

No EMI suppression device(s) were added and/or no modifications were made during testing.

2.8. Labeling Requirements

Per 2.1074 & 15.19; Docket 95-19

The label shall be permanently affixed at a conspicuous location on the device; instruction manual or pamphlet supplied to the user and be readily visible to the purchaser at the time of purchase. However, when the device is so small wherein placement of the label with specified statement is not practical, only the FCC ID must be displayed on the device per Section 15.19(a)(5). Please see attachment for FCC ID label and label location.

3. DESCRIPTION of TEST

3.1. Evaluation Procedure

The measurement procedures described in the American National Standard for Testing Unlicensed Wireless Devices (ANSI C63.10-2013), and the guidance provided in KDB 558074 D01v05 were used in the measurement of the **Air Monitor MATE**.

Deviation from measurement procedure.....None

3.2. AC Line Conducted Emissions

The line-conducted facility is located inside an 9'x4'x3' shielded enclosure. A 1m x 2m wooden table 80cm high is placed 40cm away from the vertical wall and 80cm away from the sidewall of the shielded room. Two 10kHz-30MHz, 50Ω/50uH Line-Impedance Stabilization Networks (LISNs) are bonded to the shielded room floor. Power to the LISNs is filtered by external high-current high-insertion loss power line filters. These filters attenuate ambient signal noise from entering the measurement lines. These filters are also bonded to the shielded enclosure.

The EUT is powered from one LISN and the support equipment is powered from the second LISN. All interconnecting cables more than 1 meter were shortened to a 1 meter length by non-inductive bundling (serpentine fashion) and draped over the back edge of the test table. All cables were at least 40cm above the horizontal reference ground-plane. Power cables for support equipment were routed down to the second LISN while ensuring that that cables were not draped over the second LISN.

Sufficient time for the EUT, support equipment, and test equipment was allowed in order for them to warm up to their normal operating condition. The RF output of the LISN was connected to the receiver and exploratory measurements were made to determine the frequencies producing the maximum emission from the EUT. The receiver was scanned from 150kHz to 30MHz. The detector function was set to peak mode for exploratory measurements while the bandwidth of the analyzer was set to 9kHz. The EUT, support equipment, and interconnecting cables were arranged and manipulated to maximize each emission. Each emission was also maximized by varying: power lines, the mode of operation or data exchange speed, or support equipment which determined the worst-case emission. Once the worst case emissions have been identified, the one EUT cable configuration/arrangement and mode of operation that produced these emissions are used for final measurements on the same test site. The analyzer is set to CISPR quasi-peak and average detectors with a 9kHz resolution bandwidth for final measurements.

An extension cord was used to connect to a single LISN which powered by EUT. The extension cord was calibrated with LISN, the impedance and insertion loss are compliance with the requirements as stated in ANSI C63.10-2013.

Line conducted emissions test results are shown in Section 7.8.

3.3. Radiated Emissions

The radiated test facilities consisted of an indoor 3 meter semi-anechoic chamber used for final measurements and exploratory measurements, when necessary. The measurement area is contained within the semi-anechoic chamber which is shielded from any ambient interference. For measurements above 1GHz absorbers are arranged on the floor between the turn table and the antenna mast in such a way so as to maximize the reduction of reflections. For measurements below 1GHz, the absorbers are removed. A MF Model 210SS turntable is used for radiated measurement. It is a continuously rotatable, remote controlled, metallic turntable and 2 meters (6.56 ft.) in diameter. The turn table is flush with the raised floor of the chamber in order to maintain its function as a ground plane. An 80cm high PVC support structure is placed on top of the turntable.

For all measurements, the spectrum was scanned through all EUT azimuths and from 1 to 4 meter receive antenna height using a broadband antenna from 30MHz up to the upper frequency shown in 15.33(b)(1) depending on the highest frequency generated or used in the device or on which the device operates or tunes. For frequencies above 1GHz, linearly polarized double ridge horn antennas were used. For frequencies below 30MHz, a calibrated loop antenna was used. When exploratory measurements were necessary, they were performed at 1 meter test distance inside the semi-anechoic chamber using broadband antennas, broadband amplifiers, and spectrum analyzers to determine the frequencies and modes producing the maximum emissions. Sufficient time for the EUT, support equipment, and test equipment was allowed in order for them to warm up to their normal operating condition. The test set-up for frequencies below 1GHz was placed on top of the 0.8 meter high, 1 x 1.5 meter table; and test set-up for frequencies 1-40GHz was placed on top of the 1.5 meter high, 1 x 1.5 meter table. The EUT, support equipment, and interconnecting cables were arranged and manipulated to maximize each emission. Appropriate precaution was taken to ensure that all emissions from the EUT were maximized and investigated. The system configuration, clock speed, mode of operation or video resolution, if applicable, turntable azimuth, and receive antenna height was noted for each frequency found.

Final measurements were made in the semi-anechoic chamber using calibrated, linearly polarized broadband and horn antennas. The test setup was configured to the setup that produced the worst case emissions. The spectrum analyzer was set to investigate all frequencies required for testing to compare the highest radiated disturbances with respect to the specified limits. The turntable containing the EUT was rotated through 360 degrees and the height of the receive antenna was varied 1 to 4 meters and stopped at the azimuth and height producing the maximum emission. Each emission was maximized by changing the orientation of the EUT through three orthogonal planes and changing the polarity of the receive antenna, which produced the worst-case emissions. According to 3dB Beam-Width of horn antenna, the horn antenna should be always directed to the EUT when rising height.

Radiated emissions test results are shown in Section 7.6 & 7.7 .

4. ANTENNA REQUIREMENTS

Excerpt from §15.203 of the FCC Rules/Regulations:

“An intentional radiator antenna shall be designed to ensure that no antenna other than that furnished by the responsible party can be used with the device. The use of a permanently attached antenna or of an antenna that uses a unique coupling to the intentional radiator shall be considered sufficient to comply with the provisions of this section.”

- The antenna of the **Air Monitor MATE**, is permanently attached.
- There are no provisions for connection to an external antenna.

Conclusion:

The EUT unit complies with the requirement of §15.203.

Antenna List

No.	Brand	Part No.	Antenna Type	Peak Gain
1	acer	A0100205+A	PCB	-6.17dBi

5. TEST EQUIPMENT CALIBRATION DATE

Conducted Emissions – SR2

Instrument	Manufacturer	Type No.	Asset No.	Cali. Interval	Cali. Due Date
Two-Line V-Network	R&S	ENV216	MRTTWA00020	1 year	2022/4/28
Cable	Rosnol	N1C50-RG400-B 1C50-500CM	MRTTWE00013	1 year	2022/6/20
EMI Test Receiver	R&S	ESR3	MRTTWA00009	1 year	2022/3/24

Radiated Emissions – AC1

Instrument	Manufacturer	Type No.	Asset No.	Cali. Interval	Cali. Due Date
Broadband TRILOG Antenna	SCHWARZBECK	VULB 9162	MRTTWA00001	1 year	2021/10/5
EMI Test Receiver	R&S	ESR3	MRTTWA00009	1 year	2022/3/24
Active Loop Antenna	Schwarzbeck	FMZB 1519B	MRTTWA00002	1 year	2022/5/6
Broadband Horn antenna	SCHWARZBECK	BBHA 9120D	MRTTWA00003	1 year	2022/4/21
Breitband Hornantenna	Schwarzbeck	BBHA 9170	MRTTWA00004	1 year	2022/4/28
Broadband Amplifier	Schwarzbeck	BBV 9721	MRTTWA00006	1 year	2022/4/26
Broadband Preampfier	SCHWARZBECK	BBV 9718	MRTTWA00005	1 year	2022/4/21
Cable	HUBERSUHNER	SF106	MRTTWE00010	1 year	2022/6/15
Cable	Rosnol	K1K50-UP0264- K1K50-4M	MRTTWE00012	1 year	2022/6/20

Conducted Test Equipment – SR2

Instrument	Manufacturer	Type No.	Asset No.	Cali. Interval	Cali. Due Date
EXA Signal Analyzer	KEYSIGHT	N9010A	MRTTWA00012	1 year	2021/10/14
EXA Signal Analyzer	KEYSIGHT	N9010B	MRTTWA00074	1 year	2022/7/19
USB Wideband Power Sensor	KEYSIGHT	U2021XA	MRTTWA00015	1 year	2022/3/24

Test Software

Software	Version	Function
e3	9.160520a	EMI Test Software
EMI	V3	EMI Test Software

6. MEASUREMENT UNCERTAINTY

Where relevant, the following test uncertainty levels have been estimated for tests performed on the EUT as specified in CISPR 16-4-2. This uncertainty represents an expanded uncertainty expressed at approximately the 95% confidence level using a coverage factor of $k = 2$.

Conducted Emission- Power Line
Measuring Uncertainty for a Level of Confidence of 95% ($U=2Uc(y)$): 0.15MHz~30MHz: $\pm 2.53\text{dB}$
Radiated Spurious Emission
Measuring Uncertainty for a Level of Confidence of 95% ($U=2Uc(y)$): 9kHz~30MHz: $\pm 3.92\text{dB}$ 30MHz~1GHz: $\pm 4.25\text{dB}$ 1GHz~18GHz: $\pm 4.40\text{dB}$ 18GHz~40GHz: $\pm 4.45\text{dB}$
Frequency Error
Measuring Uncertainty for a Level of Confidence of 95% ($U=2Uc(y)$): $\pm 78.4\text{Hz}$
Conducted Power
Measuring Uncertainty for a Level of Confidence of 95% ($U=2Uc(y)$): $\pm 0.84\text{dB}$
Conducted Spurious Emission
Measuring Uncertainty for a Level of Confidence of 95% ($U=2Uc(y)$): $\pm 2.65\text{ dB}$
Occupied Bandwidth
Measuring Uncertainty for a Level of Confidence of 95% ($U=2Uc(y)$): 3.3%
Temp. / Humidity
Measuring Uncertainty for a Level of Confidence of 95% ($U=2Uc(y)$): $\pm 0.82^\circ\text{C}/ \pm 3\%$
DC Voltage
Measuring Uncertainty for a Level of Confidence of 95% ($U=2Uc(y)$): $\pm 0.3\%$

7. TEST RESULT

7.1. Summary

Product Name: Air Monitor MATE

FCC Classification: (DTS) Digital Transmission System

FCC Part Section(s)	Test Description	Test Limit	Test Condition	Test Result	Reference
15.247(a)(2)	6dB Bandwidth	$\geq 500\text{kHz}$	Conducted	Pass	Section 7.2
15.247(b)(3)	Output Power	$\leq 30.00\text{dBm}$		Pass	Section 7.3
15.247(e)	Power Spectral Density	$\leq 8.00\text{dBm}/3\text{kHz}$		Pass	Section 7.4
15.247(d)	Out-of-Band Emissions	Conducted $\geq 20\text{dBc}$		Pass	Section 7.5
15.205 15.209	Spurious Emission	< FCC 15.209 limits	Radiated	Pass	Section 7.6
15.205 15.209	Band Edge Measurement	$\leq 74\text{dBuV/m(Peak)}$ $\leq 54\text{dBuV/m(Average)}$		Pass	Section 7.7
15.207	AC Conducted Emissions 150kHz - 30MHz	< FCC 15.207 limits	Line Conducted	Pass	Section 7.8

Notes:

- 1) Determining compliance is based on the test results met the regulation limits or requirements declared by clients, and the test results don't take into account the value of measurement uncertainty.
- 2) All modes of operation and data rates were investigated. For radiated emission test, every axis (X, Y, Z) was also verified. The test results shown in the following sections represent the worst case emissions.
- 3) The analyzer plots shown in this section were all taken with a correction table loaded into the analyzer. The correction table was used to account for the losses of the cables and attenuators used as part of the system to connect the EUT to the analyzer at all frequencies of interest.
- 4) All antenna port conducted emissions testing was performed on a test bench with the antenna port of the EUT connected to the spectrum analyzer through calibrated cables and attenuators.

7.2. 6dB Bandwidth Measurement

7.2.1. Test Limit

The minimum 6dB bandwidth shall be at least 500 kHz.

7.2.2. Test Procedure used

KDB 558074 D01v05- Section 8.2 Option 2

7.2.3. Test Setting

1. The Spectrum's automatic bandwidth measurement capability was used to perform the 6dB bandwidth measurement. The "X" dB bandwidth parameter was set to $X = 6$. The bandwidth measurement was not influenced by any intermediate power nulls in the fundamental emission.
2. Set RBW = 100 kHz
3. $VBW \geq 3 \times RBW$
4. Detector = Peak
5. Trace mode = max hold
6. Sweep = auto couple
7. Allow the trace was allowed to stabilize

7.2.4. Test Setup

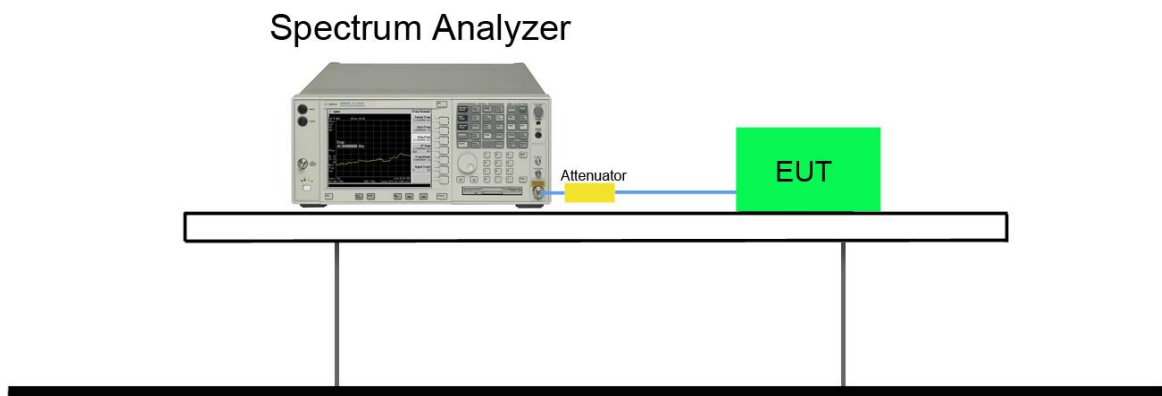

7.2.5. Test Result

Test Mode	Channel No.	Frequency (MHz)	6dB Bandwidth (kHz)	Limit (kHz)	Result
TX	0	902.4	618.30	>500	Pass
	63	915	613.00	>500	Pass
	126	927.6	621.80	>500	Pass

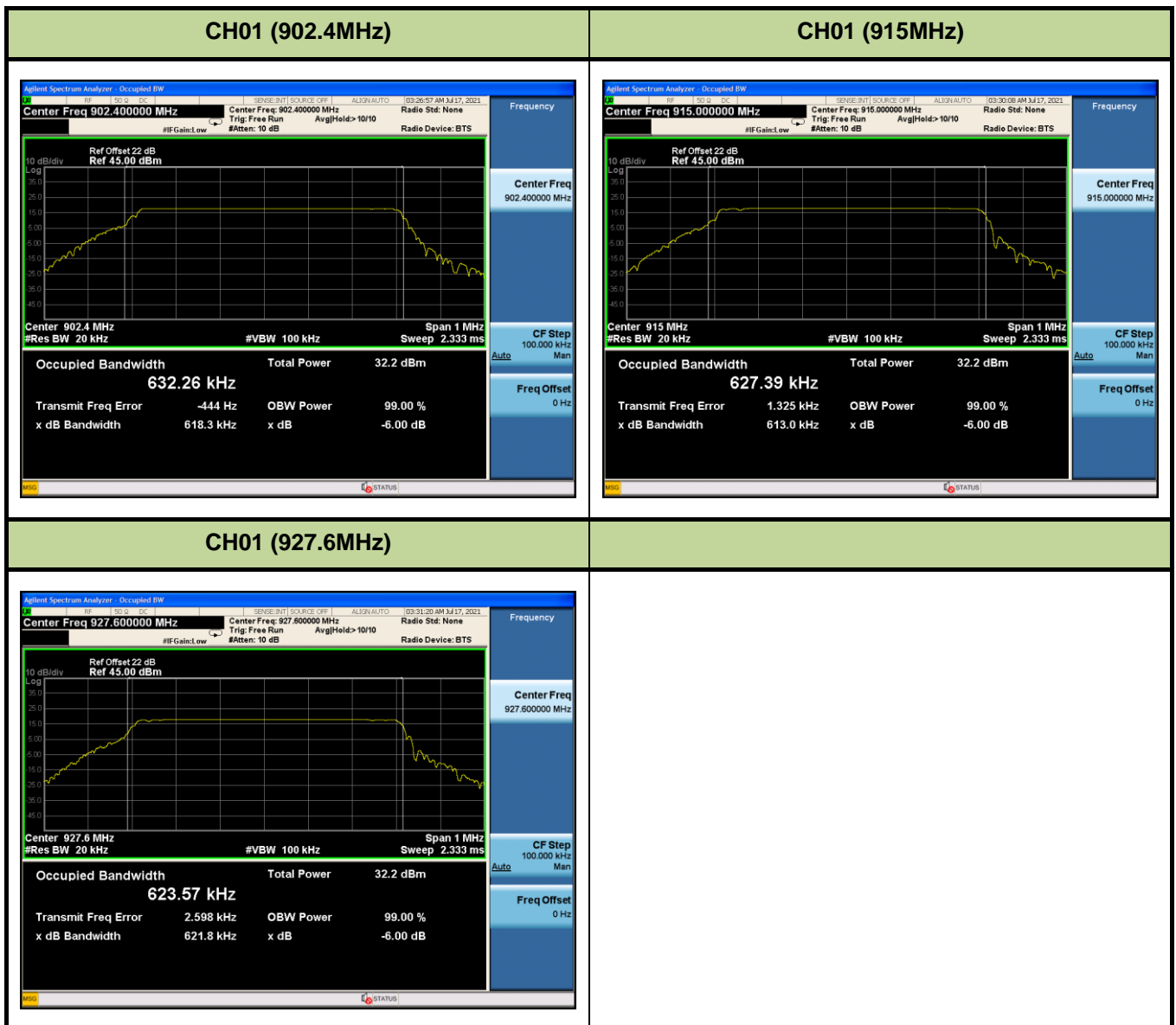

7.3. Output Power Measurement

7.3.1. Test Limit

The maximum out power shall be less 1 Watt (30dBm).

7.3.2. Test Procedure Used

KDB 558074 D01v05 - Section 9.1.2 & 9.2.3.2

7.3.3. Test Setting

Peak Power Measurement

The maximum peak conducted output power may be measured using a broadband peak RF power meter. The power meter shall have a video bandwidth that is greater than or equal to the DTS bandwidth and shall utilize a fast-responding diode detector.

Average Power Measurement

Average power measurements were performed only when the EUT was transmitting at its maximum power control level using a broadband power meter with a pulse sensor. The power meter implemented triggering and gating capabilities which were set up such that power measurements were recorded only during the ON time of the transmitter. The trace was averaged over 100 traces to obtain the final measured average power.

7.3.4. Test Setup



7.3.5. Test Result of Output Power

Test Mode	Frequency (MHz)	Peak Power (dBm)	EIRP (dBm)	Peak Power Limit (dBm)	EIRP Limit (dBm)
TX	902.4	17.311	13.611	< 30	< 36
	915	17.325	13.625	< 30	< 36
	927.6	17.353	13.653	< 30	< 36

Note:

1. Peak Power Output Value = Reading value on power meter (dBm) + cable loss (dBm).
2. E.I.R.P Power = Peak Power (dBm) + Antenna Gain (dBi).
3. Antenna Gain = -3.70dBi.

7.4. Power Spectral Density Measurement

7.4.1. Test Limit

The maximum permissible power spectral density is 8dBm in any 3 kHz band.

7.4.2. Test Procedure Used

KDB 558074 D01v05 - Section 10.2 Method PKPSD

7.4.3. Test Setting

This procedure shall be used if maximum peak conducted output power was used to demonstrate compliance, and is optional if the maximum conducted (average) output power was used to demonstrate compliance.

- a) Set analyzer center frequency to DTS channel center frequency.
- b) Set the span to 1.5 times the DTS bandwidth.
- c) Set the RBW to: 3 kHz.
- d) Set the VBW $\geq 3^*$ RBW.
- e) Detector = peak.
- f) Sweep time = auto couple.
- g) Trace mode = max hold.
- h) Allow trace to fully stabilize.
- i) Use the peak marker function to determine the maximum amplitude level within the RBW.

7.4.4. Test Setup

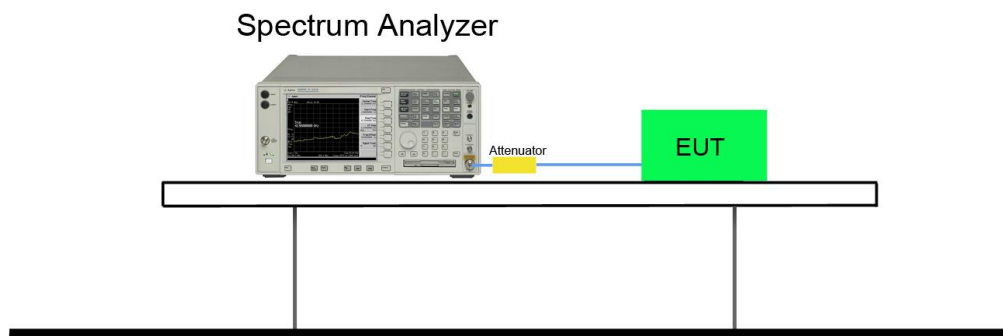

7.4.5. Test Result

Test Mode	Frequency (MHz)	PSD (dBm)	Limit (dBm)	Result
TX	902.4	7.844	≤ 8	Pass
	915	7.857	≤ 8	Pass
	927.6	7.452	≤ 8	Pass

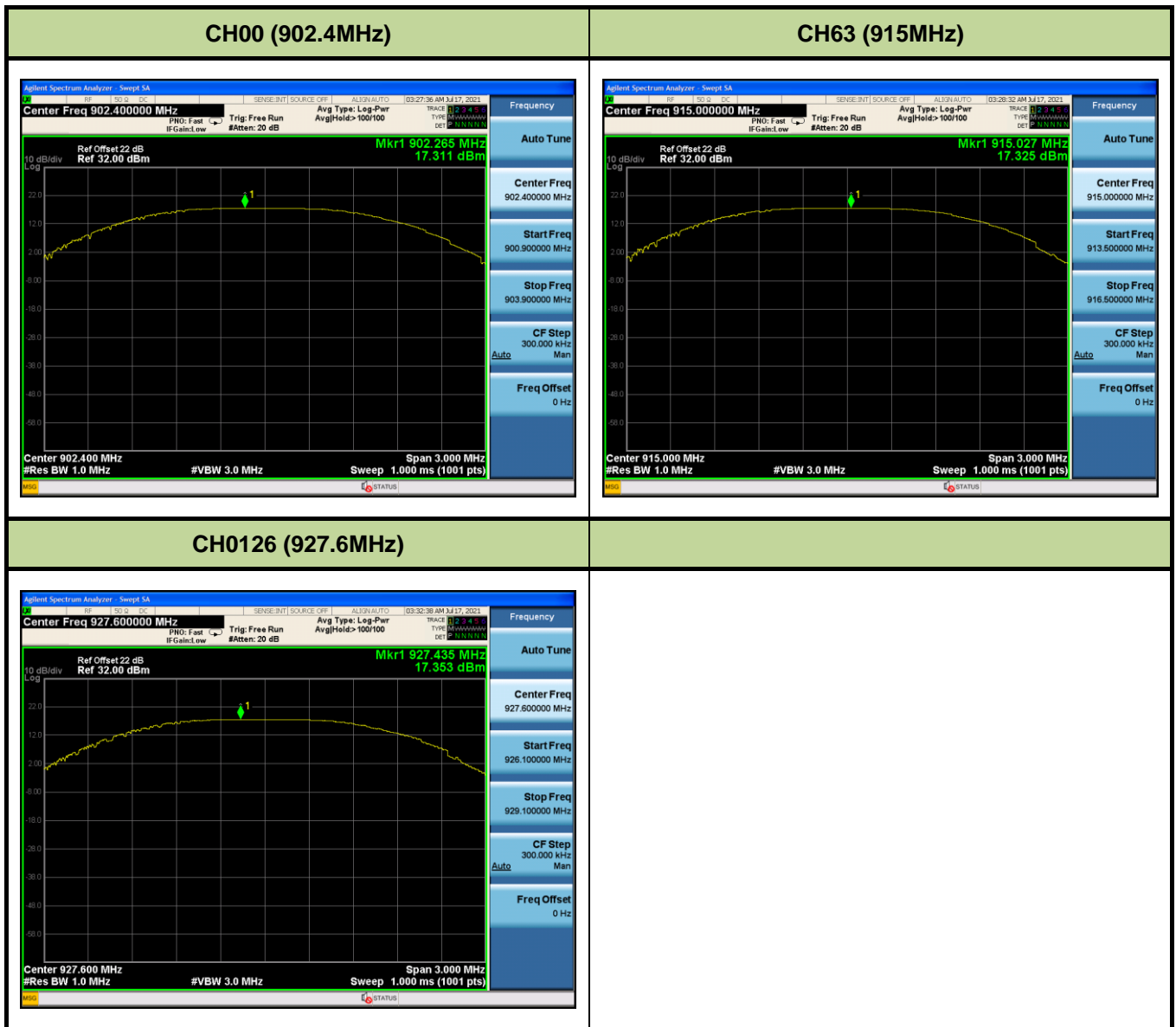

7.5. Out-of-Band Spurious Emissions Emissions Measurement

7.5.1. Test Limit

In any 100 kHz bandwidth outside the frequency band in which the spread spectrum or digitally modulated intentional radiator is operating, the radio frequency power that is produced by the intentional radiator shall be at least 20 dB below that in the 100 kHz bandwidth within the band that contains the highest level of the desired power, based on RF conducted measurement, provided the transmitter demonstrates compliance with the peak conducted power limits.

7.5.2. Test Procedure Used

KDB 558074 D01v05- Section 11.1 & 11.2

7.5.3. Test Settling

- (a) Set instrument center frequency to DTS channel center frequency
- (b) Set the span to ≥ 1.5 times the DTS bandwidth
- (c) Set the RBW = 100 kHz
- (d) Set the VBW $\geq 3 \times$ RBW
- (e) Detector = peak
- (f) Sweep time = auto couple
- (g) Trace mode = max hold
- (h) Allow trace to fully stabilize

7.5.4. Test Setup

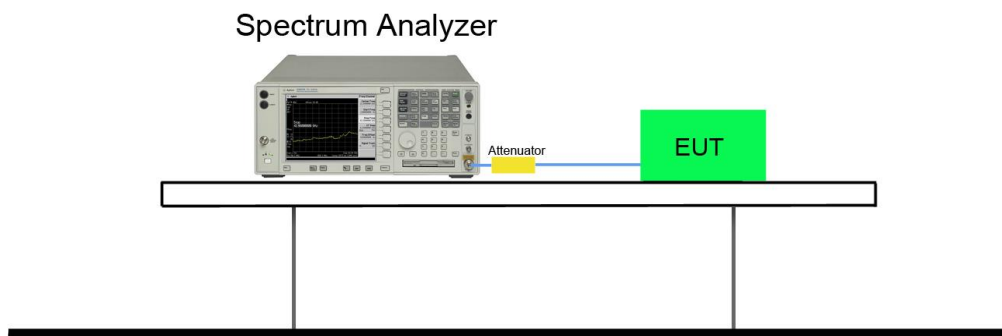

7.5.5. Test Result

Test Mode	Frequency (MHz)	Limit	Result
TX	902.4	20dBc	Pass
	915	20dBc	Pass
	927.6	20dBc	Pass

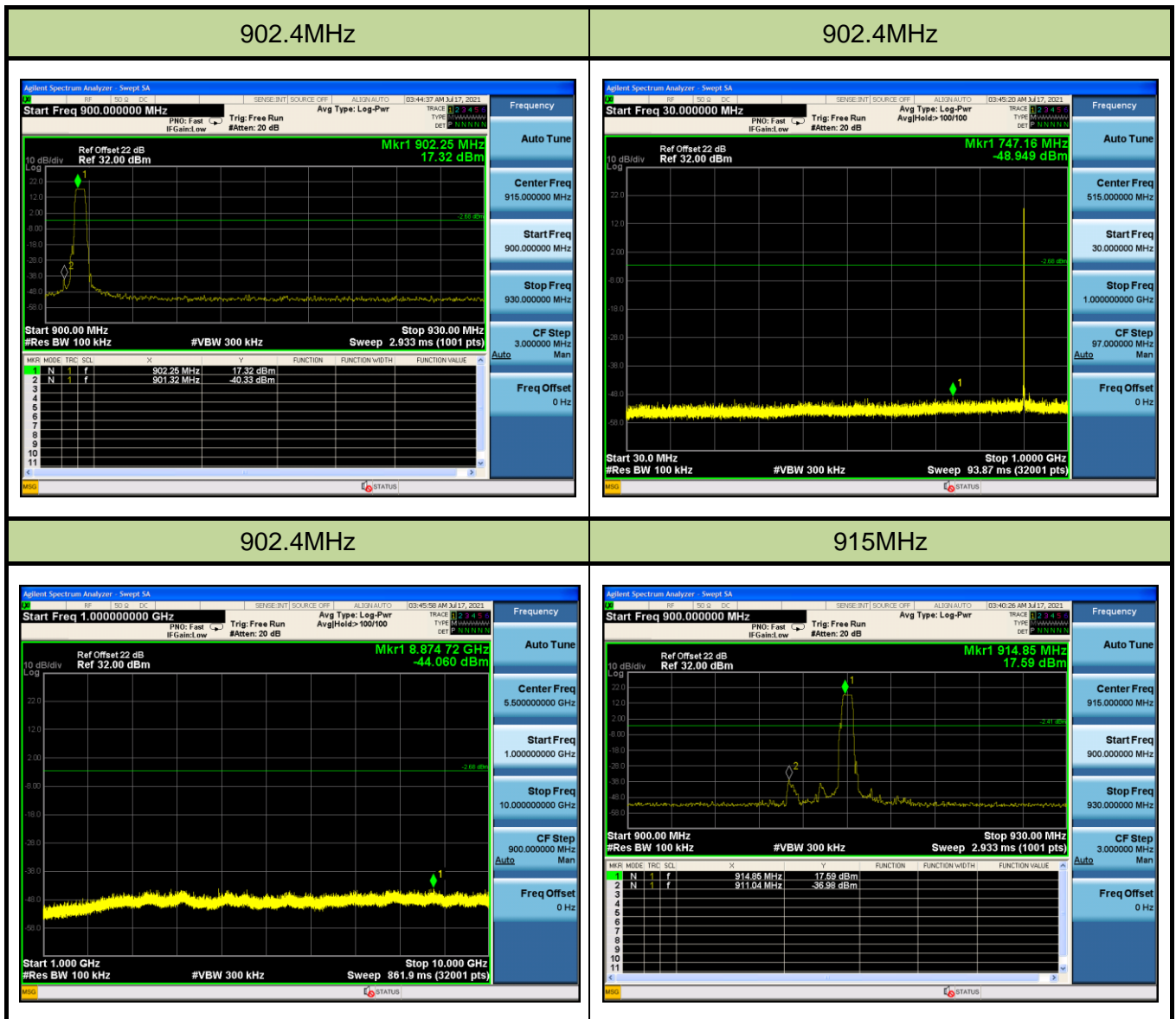

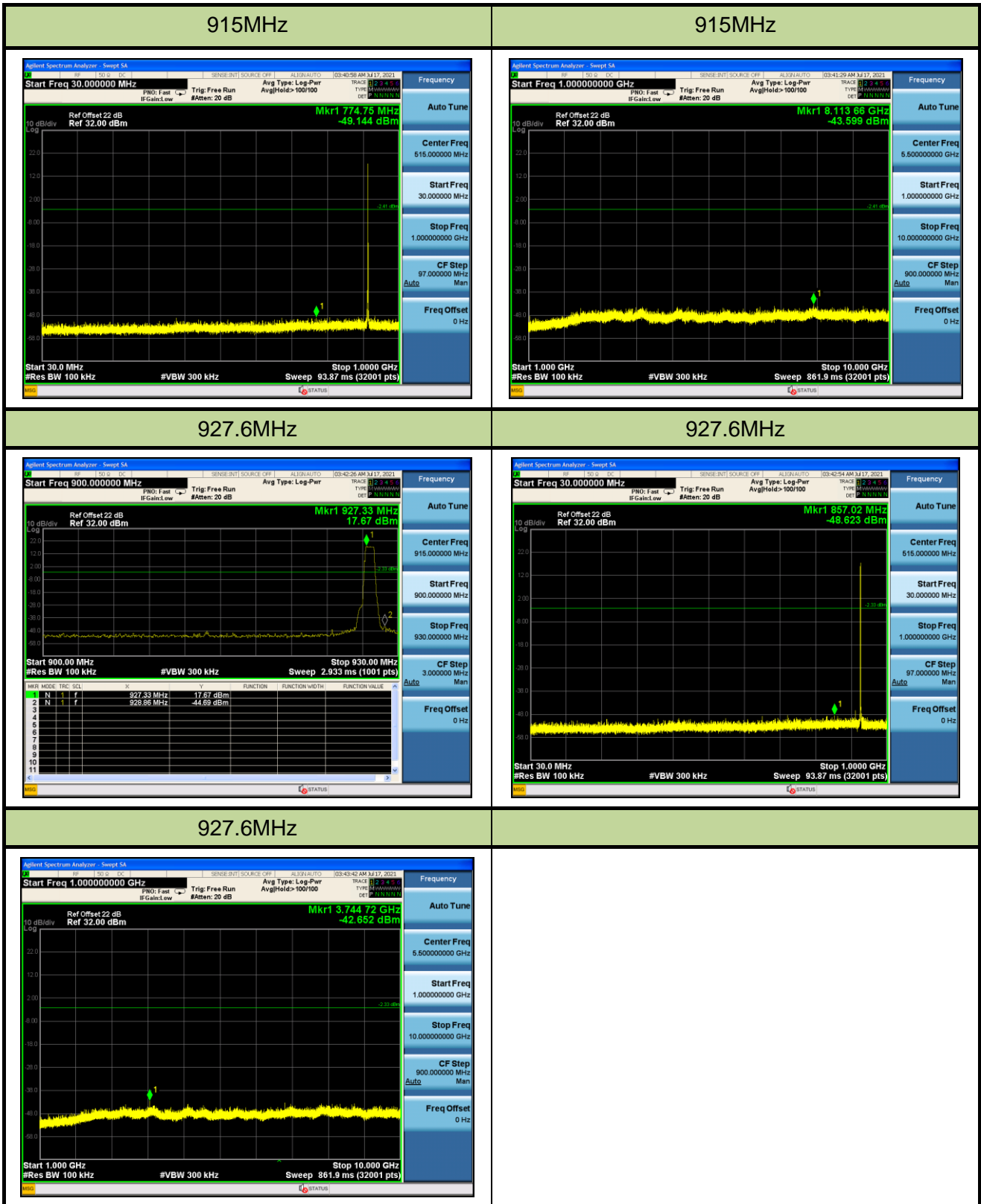

7.6. Radiated Spurious Emission Measurement

7.6.1. Test Limit

All out of band emissions appearing in a restricted band as specified in Section 15.205 of the Title 47 CFR must not exceed the limits shown in Table per Section 15.209.

FCC Part 15 Subpart C Paragraph 15.209		
Frequency [MHz]	Field Strength [V/m]	Measured Distance [Meters]
0.009 - 0.490	2400/F (kHz)	300
0.490 - 1.705	24000/F (kHz)	30
1.705 - 30	30	30
30 - 88	100	3
88 - 216	150	3
216 - 960	200	3
Above 960	500	3

7.6.2. Test Procedure Used

KDB 558074 D01v05- Section 12.2.3 (quasi-peak measurements)

KDB 558074 D01v05- Section 12.2.4 (peak power measurements)

KDB 558074 D01v05- Section 12.2.5 (average power measurements)

7.6.3. Test Setting

Peak Field Strength Measurements

1. Analyzer center frequency was set to the frequency of the radiated spurious emission of interest
2. RBW = as specified in Table 1
3. VBW = 3MHz
4. Detector = peak
5. Sweep time = auto couple

6. Trace mode = max hold

7. Trace was allowed to stabilize

Table 1 - RBW as a function of frequency

Frequency	RBW
9 ~ 150 kHz	200 ~ 300 Hz
0.15 ~ 30 MHz	9 ~ 10 kHz
30 ~ 1000 MHz	100 ~ 120 kHz
> 1000 MHz	1 MHz

Average Field Strength Measurements

1. Analyzer center frequency was set to the frequency of the radiated spurious emission of interest

2. RBW = 1MHz

3. VBW \geq 1/T

4. De As an alternative, the instrument may be set to linear detector mode. Ensure that video filtering is applied in linear voltage domain (rather than in a log or dB domain). Some instruments require linear display mode in order to accomplish this. Others have a setting for Average-VBW Type, which can be set to "Voltage" regardless of the display mode

5. Detector = Peak

6. Sweep time = auto

7. Trace mode = max hold

8. Allow max hold to run for at least 50 times (1/duty cycle) traces

7.6.4. Test Setup

9kHz ~ 30MHz Test Setup:

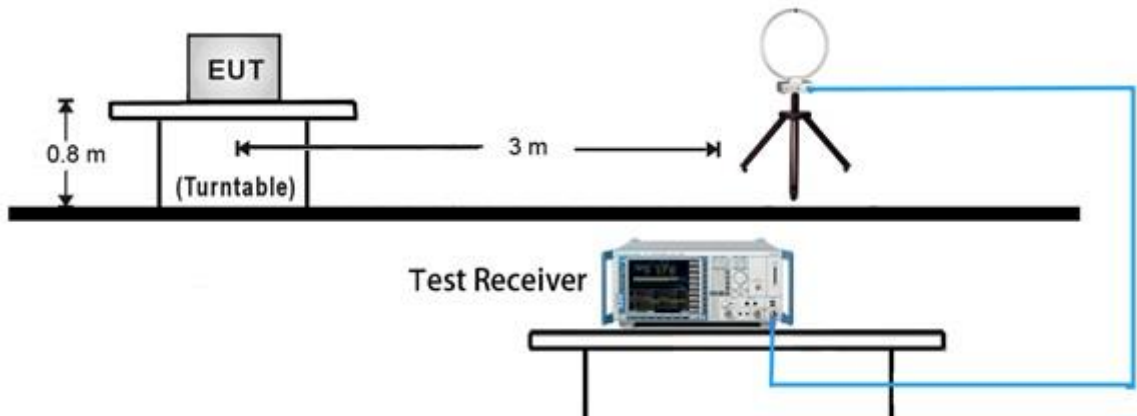

30MHz ~ 1GHz Test Setup:

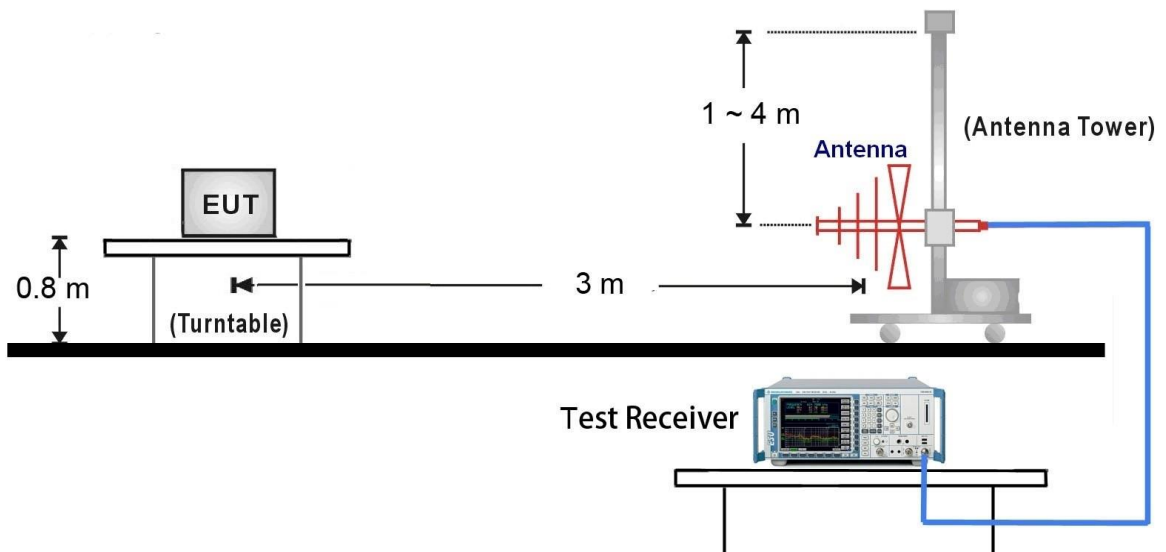

1GHz ~ 18GHz Test Setup:

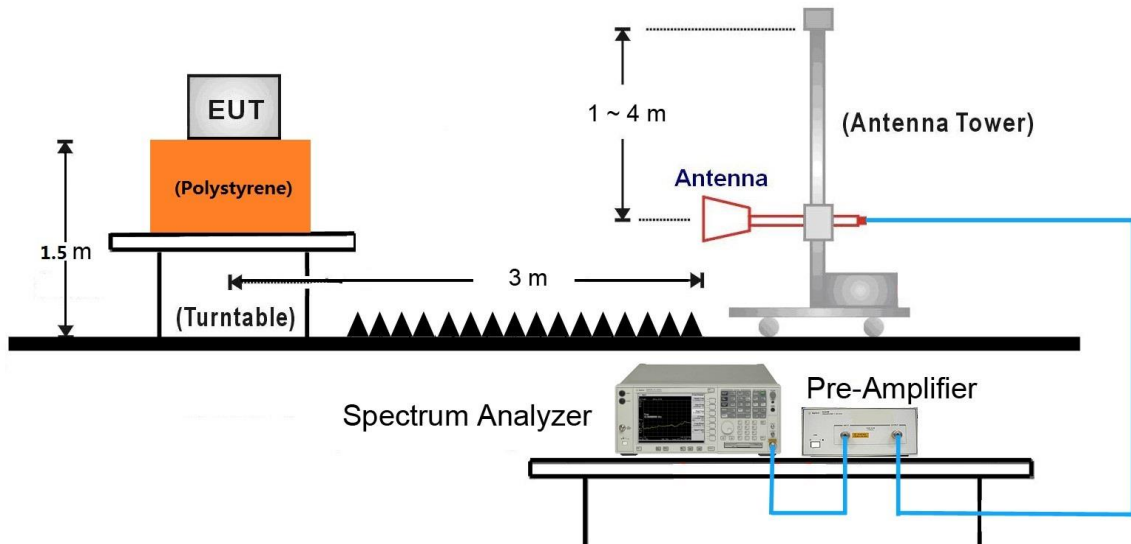

18GHz ~25GHz Test Setup:

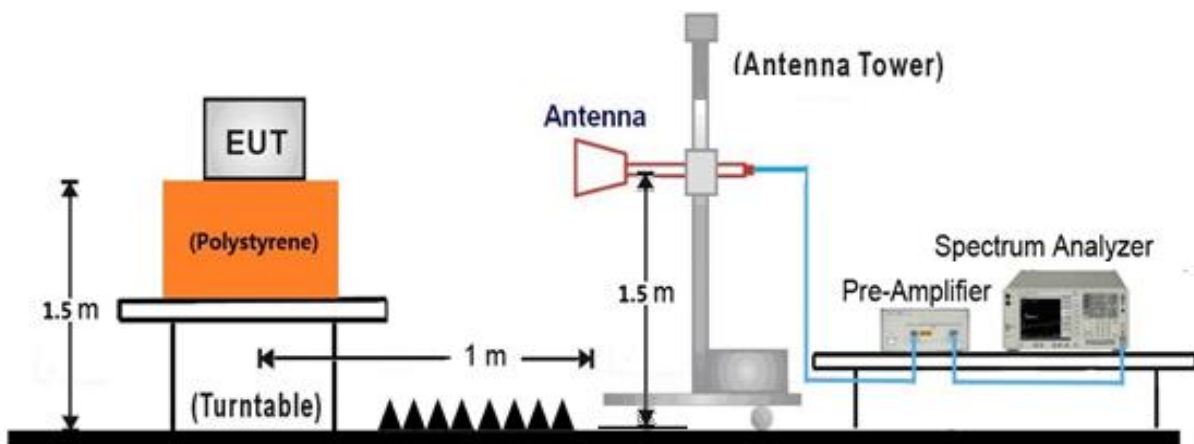

7.6.5. Test Result

EUT	Air Monitor MATE	Date of Test	2021-07-15
Factor	VULB 9162	Temp. / Humidity	24°C /57%
Polarity	Horizontal	Site / Test Engineer	AC1 / Kaunaz
Test Mode	TX-915MHz	Test Voltage	AC 120V/60Hz

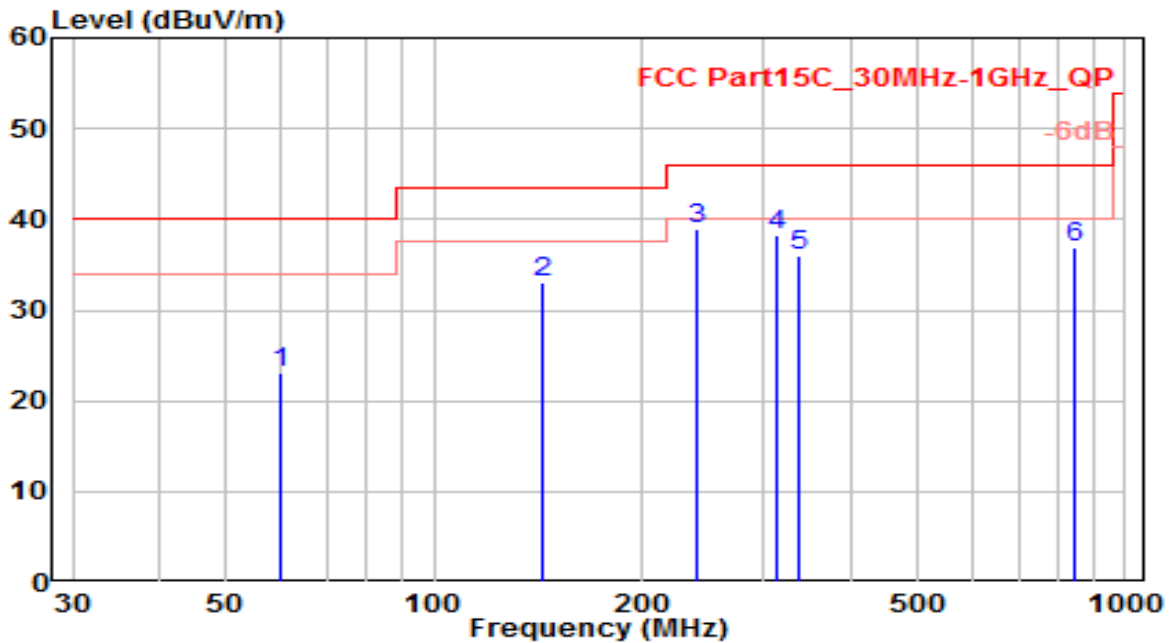

No	Frequency (MHz)	Reading (dBuV)	C.F (dB)	Measurement (dBuV/m)	Margin (dB)	Limit (dBuV/m)	Height (cm)	Angle (deg)	Remark (QP/PK/AV)
1	60.070	2.90	20.19	23.09	-16.91	40.00	100	225	Peak
2	143.490	16.93	16.01	32.94	-10.56	43.50	100	340	QP
3	* 239.520	18.71	20.18	38.88	-7.12	46.00	100	355	QP
4	312.270	16.38	21.92	38.31	-7.69	46.00	100	205	QP
5	336.520	13.19	22.76	35.96	-10.04	46.00	100	50	QP
6	844.800	5.54	31.38	36.92	-9.08	46.00	100	265	QP

Note:

1. " *", means this data is the worst emission level.
2. C.F (Correction Factor) = Antenna Factor (dB)+ Cable Loss (dB).
3. Measurement (dBuV/m) = Reading(dBuV) + C.F (Correction Factor).
4. The emission levels of other frequencies are very lower than the limit and not show in test report.

EUT	Air Monitor MATE	Date of Test	2021-07-15
Factor	VULB 9162	Temp. / Humidity	24°C /57%
Polarity	Vertical	Site / Test Engineer	AC1 / Kaunaz
Test Mode	TX-915MHz	Test Voltage	AC 120V/60Hz

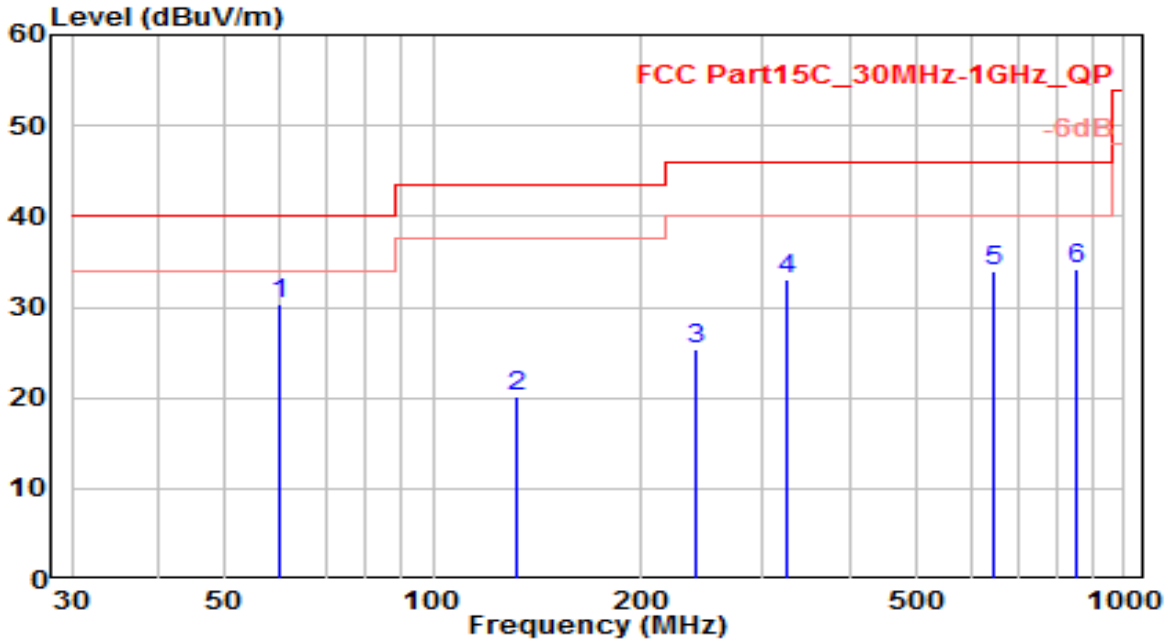

No	Frequency (MHz)	Reading (dBuV)	C.F (dB)	Measurement (dBuV/m)	Margin (dB)	Limit (dBuV/m)	Height (cm)	Angle (deg)	Remark (QP/PK/AV)
1	* 60.070	10.13	20.19	30.32	-9.68	40.00	100	55	QP
2	131.850	3.89	16.24	20.13	-23.37	43.50	100	260	QP
3	240.490	5.14	20.22	25.36	-20.64	46.00	100	140	QP
4	323.910	10.83	22.33	33.15	-12.85	46.00	100	305	QP
5	647.890	5.29	28.58	33.87	-12.13	46.00	100	280	QP
6	849.650	2.78	31.48	34.26	-11.74	46.00	100	290	QP

Note:

1. " *", means this data is the worst emission level.
2. C.F (Correction Factor) = Antenna Factor (dB)+ Cable Loss (dB).
3. Measurement (dBuV/m) = Reading(dBuV) + C.F (Correction Factor).
4. The emission levels of other frequencies are very lower than the limit and not show in test report.

EUT	Air Monitor MATE	Date of Test	2021-07-15
Factor	VULB 9162	Temp. / Humidity	24°C /57%
Polarity	Horizontal	Site / Test Engineer	AC1 / Kaunaz
Test Mode	RX-915MHz	Test Voltage	AC 120V/60Hz

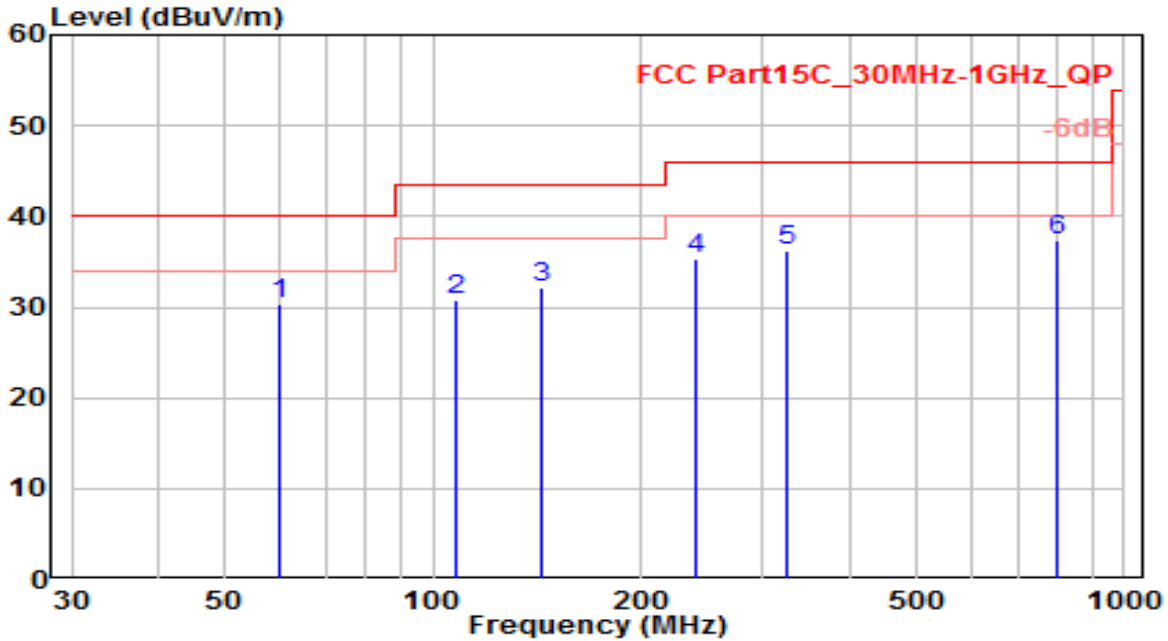

No	Frequency (MHz)	Reading (dBuV)	C.F (dB)	Measurement (dBuV/m)	Margin (dB)	Limit (dBuV/m)	Height (cm)	Angle (deg)	Remark (QP/PK/AV)
1	60.070	10.17	20.19	30.36	-9.64	40.00	100	240	QP
2	107.600	12.01	18.82	30.83	-12.67	43.50	100	350	QP
3	143.490	16.11	16.01	32.12	-11.38	43.50	100	125	Peak
4	239.520	15.08	20.18	35.26	-10.74	46.00	100	160	QP
5	323.910	13.97	22.33	36.30	-9.70	46.00	100	95	QP
6	* 796.300	6.84	30.47	37.31	-8.69	46.00	100	305	QP

Note:

1. " *", means this data is the worst emission level.
2. C.F (Correction Factor) = Antenna Factor (dB)+ Cable Loss (dB).
3. Measurement (dBuV/m) = Reading(dBuV) + C.F (Correction Factor).
4. The emission levels of other frequencies are very lower than the limit and not show in test report.

EUT	Air Monitor MATE	Date of Test	2021-07-15
Factor	VULB 9162	Temp. / Humidity	24°C /57%
Polarity	Vertical	Site / Test Engineer	AC1 / Kaunaz
Test Mode	RX-915MHz	Test Voltage	AC 120V/60Hz

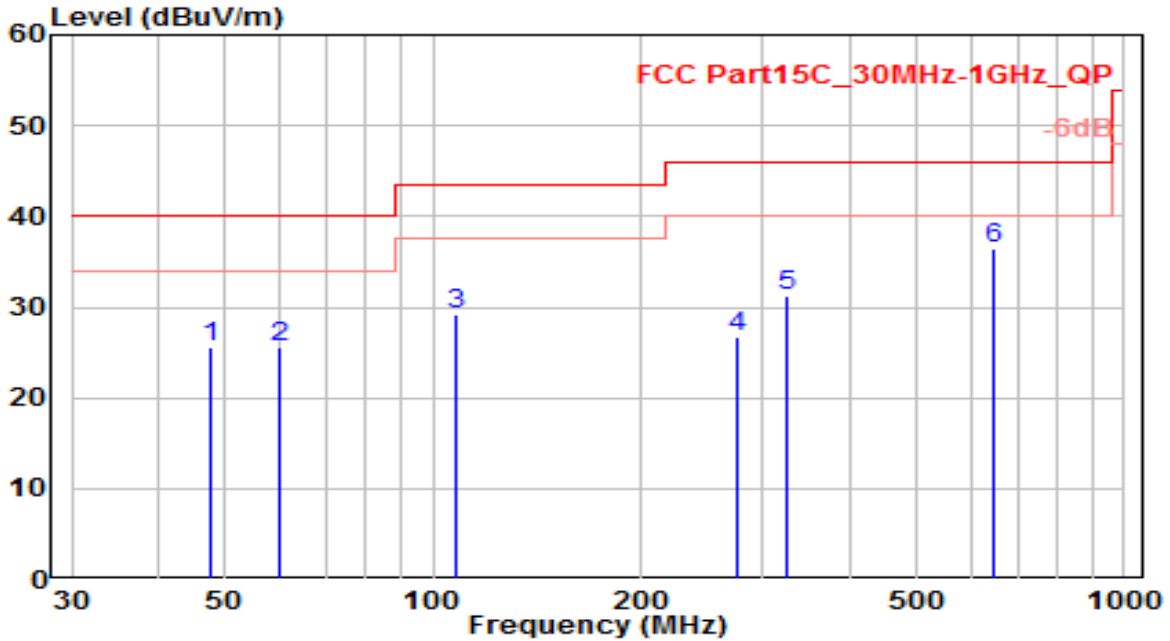

No	Frequency (MHz)	Reading (dBuV)	C.F (dB)	Measurement (dBuV/m)	Margin (dB)	Limit (dBuV/m)	Height (cm)	Angle (deg)	Remark (QP/PK/AV)
1	47.460	3.58	21.93	25.51	-14.49	40.00	100	155	QP
2	60.070	5.30	20.19	25.49	-14.51	40.00	100	360	QP
3	107.600	10.31	18.82	29.13	-14.37	43.50	100	340	QP
4	275.410	5.84	20.88	26.73	-19.27	46.00	100	190	QP
5	323.910	8.85	22.33	31.18	-14.82	46.00	100	175	QP
6	* 647.890	7.89	28.58	36.47	-9.53	46.00	100	20	QP

Note:

1. " *", means this data is the worst emission level.
2. C.F (Correction Factor) = Antenna Factor (dB)+ Cable Loss (dB).
3. Measurement (dBuV/m) = Reading(dBuV) + C.F (Correction Factor).
4. The emission levels of other frequencies are very lower than the limit and not show in test report.

EUT	Air Monitor MATE	Date of Test	2021-07-15
Factor	BBHA 9120D	Temp. / Humidity	24°C /57%
Polarity	Horizontal	Site / Test Engineer	AC1 / Kaunaz
Test Mode	TX-902.4MHz	Test Voltage	AC 120V/60Hz

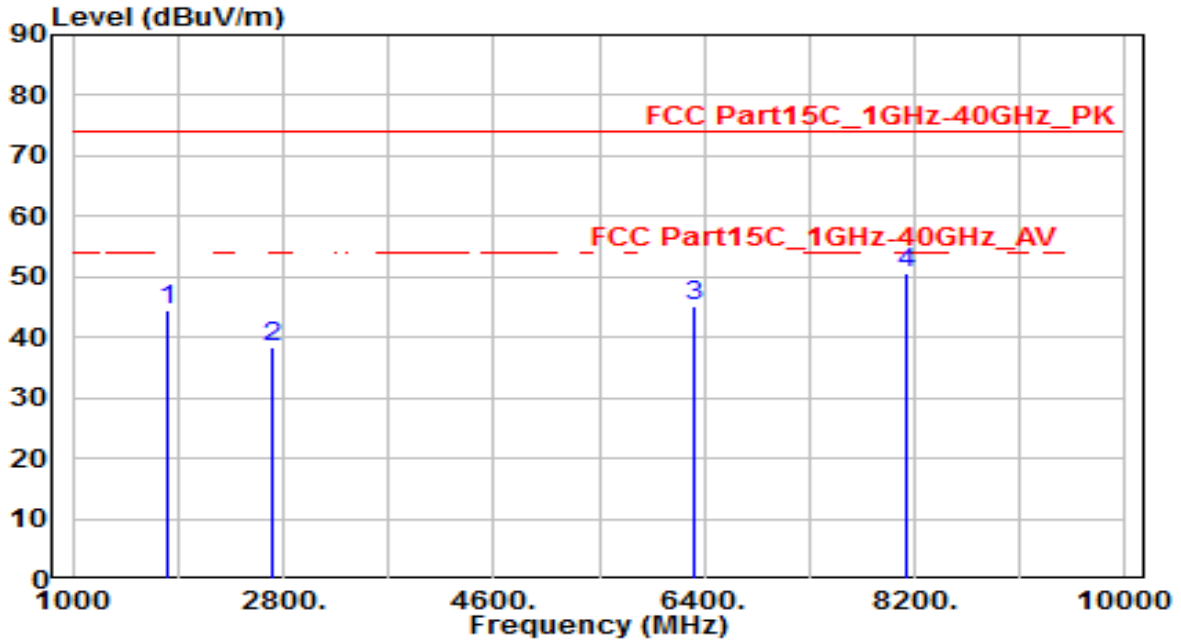

No	Frequency (MHz)	Reading (dBuV)	C.F (dB)	Measurement (dBuV/m)	Margin (dB)	Limit (dBuV/m)	Height (cm)	Angle (deg)	Remark (QP/PK/AV)
1	1804.656	48.67	-4.03	44.64	-29.36	74.00	100	360	Peak
2	2707.469	40.06	-1.67	38.39	-35.61	74.00	100	360	Peak
3	6317.313	37.40	7.93	45.33	-28.67	74.00	100	360	Peak
4	* 8123.500	37.15	13.49	50.64	-23.36	74.00	100	360	Peak

Note:

- "*", means this data is the worst emission level.
- C.F (Correction Factor) = Antenna Factor (dB)+ Cable Loss (dB) – Pre-amplifier(dB).
- Measurement (dBuV/m) = Reading(dBuV) + C.F (Correction Factor).
- The emission levels of other frequencies are very lower than the limit and not show in test report.

EUT	Air Monitor MATE	Date of Test	2021-07-15
Factor	BBHA 9120D	Temp. / Humidity	24°C /57%
Polarity	Vertical	Site / Test Engineer	AC1 / Kaunaz
Test Mode	TX-902.4MHz	Test Voltage	AC 120V/60Hz

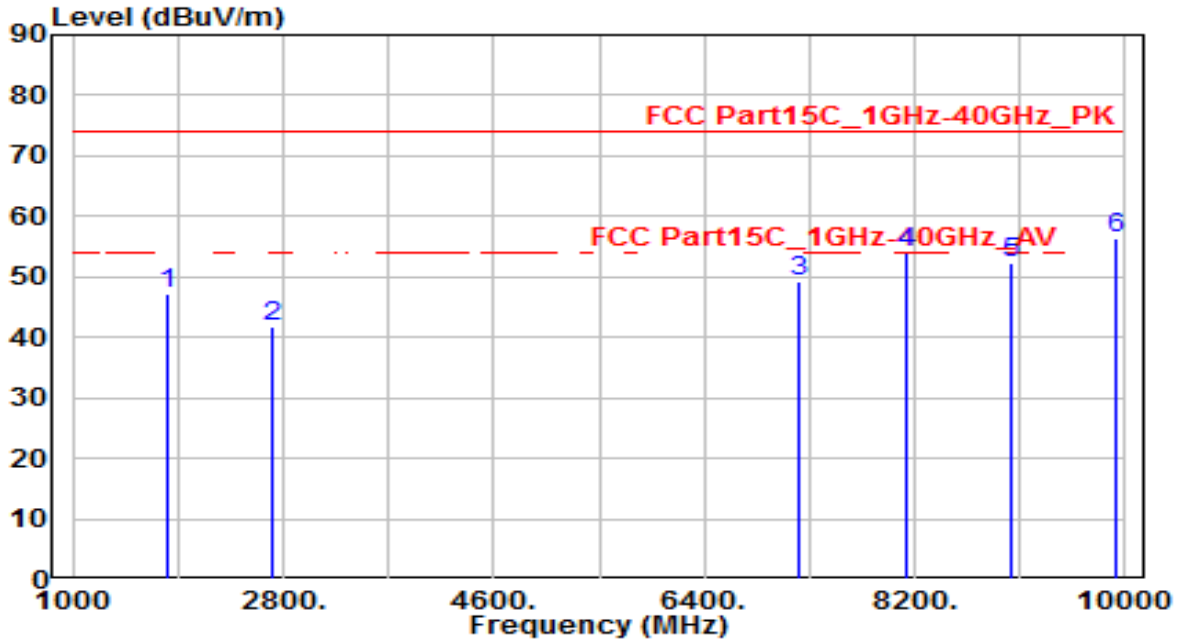

No	Frequency (MHz)	Reading (dBuV)	C.F (dB)	Measurement (dBuV/m)	Margin (dB)	Limit (dBuV/m)	Height (cm)	Angle (deg)	Remark (QP/PK/AV)
1	1804.938	51.11	-4.03	47.07	-26.93	74.00	100	360	Peak
2	2707.188	43.60	-1.67	41.93	-32.07	74.00	100	360	Peak
3	7220.969	37.32	11.78	49.10	-24.90	74.00	100	360	Peak
4	8123.500	40.46	13.49	53.95	-20.05	74.00	100	360	Peak
5	9022.938	37.42	14.92	52.34	-21.66	74.00	100	360	Peak
6	* 9926.875	39.99	16.44	56.42	-17.58	74.00	100	360	Peak

Note:

1. " *", means this data is the worst emission level.
2. C.F (Correction Factor) = Antenna Factor (dB)+ Cable Loss (dB) – Preamplifier(dB).
3. Measurement (dBuV/m) = Reading(dBuV) + C.F (Correction Factor).
4. The emission levels of other frequencies are very lower than the limit and not show in test report.

EUT	Air Monitor MATE	Date of Test	2021-07-15
Factor	BBHA 9120D	Temp. / Humidity	24°C /57%
Polarity	Horizontal	Site / Test Engineer	AC1 / Kaunaz
Test Mode	TX-915MHz	Test Voltage	AC 120V/60Hz

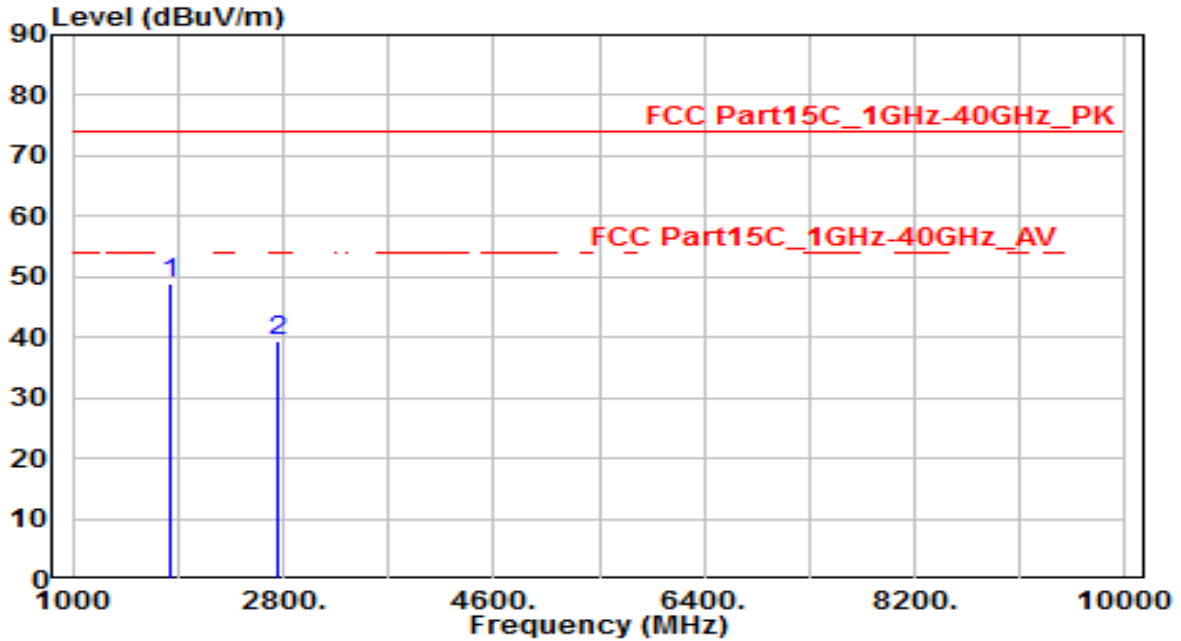

No	Frequency (MHz)	Reading (dBuV)	C.F (dB)	Measurement (dBuV/m)	Margin (dB)	Limit (dBuV/m)	Height (cm)	Angle (deg)	Remark (QP/PK/AV)
1	* 1830.531	52.98	-3.96	49.02	-24.98	74.00	150	360	Peak
2	2744.594	41.13	-1.67	39.46	-34.54	74.00	150	360	Peak

Note:

- "*" means this data is the worst emission level.
- C.F (Correction Factor) = Antenna Factor (dB)+ Cable Loss (dB) – Pre-amplifier(dB).
- Measurement (dBuV/m) = Reading(dBuV) + C.F (Correction Factor).
- The emission levels of other frequencies are very lower than the limit and not show in test report.

EUT	Air Monitor MATE	Date of Test	2021-07-15
Factor	BBHA 9120D	Temp. / Humidity	24°C /57%
Polarity	Vertical	Site / Test Engineer	AC1 / Kaunaz
Test Mode	TX-915MHz	Test Voltage	AC 120V/60Hz

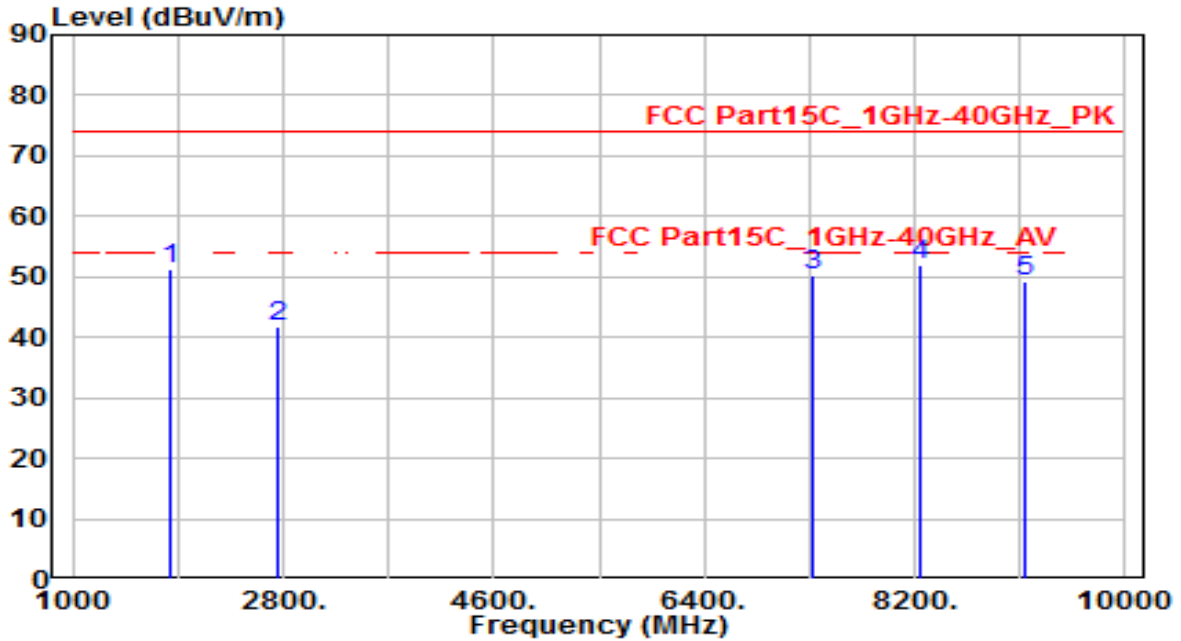

No	Frequency (MHz)	Reading (dBuV)	C.F (dB)	Measurement (dBuV/m)	Margin (dB)	Limit (dBuV/m)	Height (cm)	Angle (deg)	Remark (QP/PK/AV)
1	1829.688	55.21	-3.97	51.24	-22.76	74.00	150	360	Peak
2	2744.875	43.45	-1.67	41.78	-32.22	74.00	150	360	Peak
3	7318.844	38.10	12.21	50.31	-23.69	74.00	150	360	Peak
4	* 8236.000	38.38	13.54	51.92	-22.08	74.00	150	360	Peak
5	9152.875	34.07	15.14	49.21	-24.79	74.00	150	360	Peak

Note:

1. " *", means this data is the worst emission level.
2. C.F (Correction Factor) = Antenna Factor (dB)+ Cable Loss (dB) – Preamplifier(dB).
3. Measurement (dBuV/m) = Reading(dBuV) + C.F (Correction Factor).
4. The emission levels of other frequencies are very lower than the limit and not show in test report.

EUT	Air Monitor MATE	Date of Test	2021-07-15
Factor	BBHA 9120D	Temp. / Humidity	24°C /57%
Polarity	Horizontal	Site / Test Engineer	AC1 / Kaunaz
Test Mode	TX-927.6MHz	Test Voltage	AC 120V/60Hz

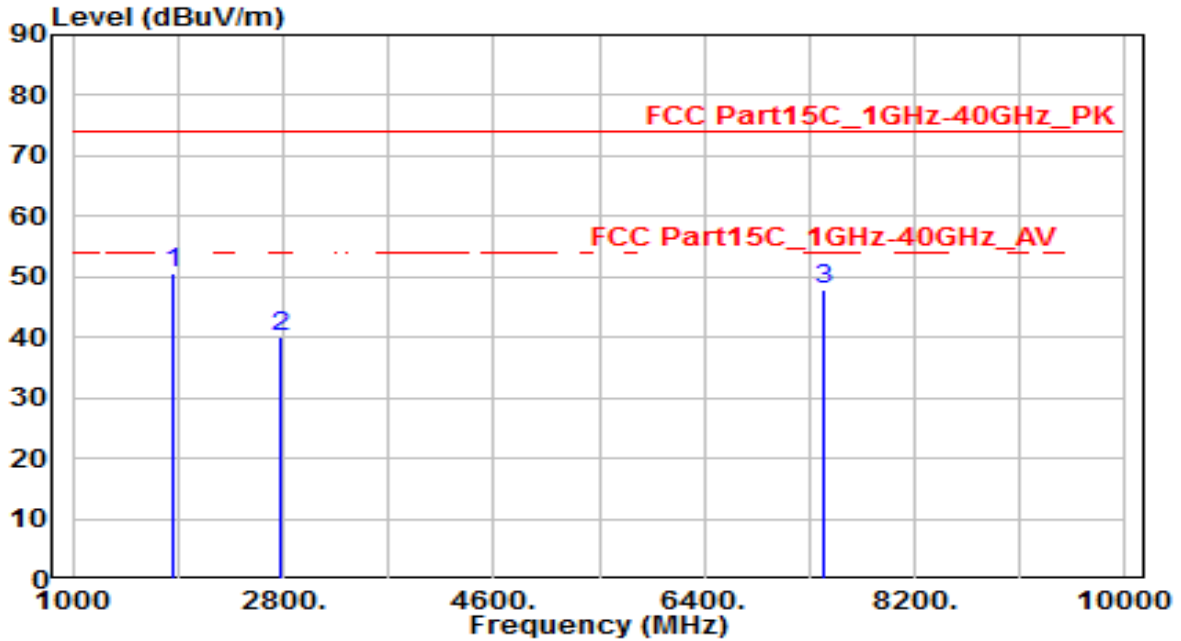

No	Frequency (MHz)	Reading (dBuV)	C.F (dB)	Measurement (dBuV/m)	Margin (dB)	Limit (dBuV/m)	Height (cm)	Angle (deg)	Remark (QP/PK/AV)
1	* 1855.000	54.58	-3.90	50.68	-23.32	74.00	100	360	Peak
2	2782.563	41.75	-1.68	40.07	-33.93	74.00	100	360	Peak
3	7419.531	35.19	12.66	47.85	-26.15	74.00	100	360	Peak

Note:

1. " *", means this data is the worst emission level.
2. C.F (Correction Factor) = Antenna Factor (dB)+ Cable Loss (dB) – Preamplifier(dB).
3. Measurement (dBuV/m) = Reading(dBuV) + C.F (Correction Factor).
4. The emission levels of other frequencies are very lower than the limit and not show in test report.

EUT	Air Monitor MATE	Date of Test	2021-07-15
Factor	BBHA 9120D	Temp. / Humidity	24°C /57%
Polarity	Vertical	Site / Test Engineer	AC1 / Kaunaz
Test Mode	TX-927.6MHz	Test Voltage	AC 120V/60Hz

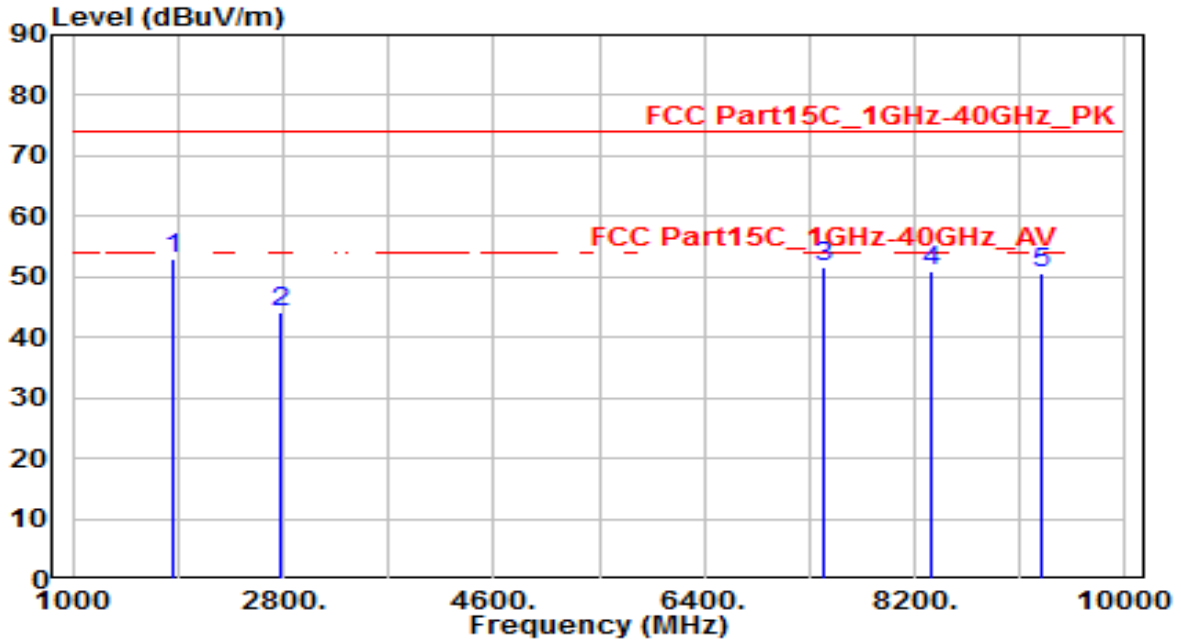

No	Frequency (MHz)	Reading (dBuV)	C.F (dB)	Measurement (dBuV/m)	Margin (dB)	Limit (dBuV/m)	Height (cm)	Angle (deg)	Remark (QP/PK/AV)
1	* 1855.281	57.04	-3.90	53.14	-20.86	74.00	100	360	Peak
2	2782.563	45.79	-1.68	44.11	-29.89	74.00	100	360	Peak
3	7419.813	39.00	12.66	51.66	-22.34	74.00	100	360	Peak
4	8349.625	37.31	13.59	50.90	-23.10	74.00	100	360	Peak
5	9278.031	35.13	15.35	50.47	-23.53	74.00	100	360	Peak

Note:

1. " *", means this data is the worst emission level.
2. C.F (Correction Factor) = Antenna Factor (dB)+ Cable Loss (dB) – Preamplifier(dB).
3. Measurement (dBuV/m) = Reading(dBuV) + C.F (Correction Factor).
4. The emission levels of other frequencies are very lower than the limit and not show in test report.

EUT	Air Monitor MATE	Date of Test	2021-07-15
Factor	BBHA 9120D	Temp. / Humidity	24°C /57%
Polarity	Horizontal	Site / Test Engineer	AC1 / Kaunaz
Test Mode	RX-915MHz	Test Voltage	AC 120V/60Hz

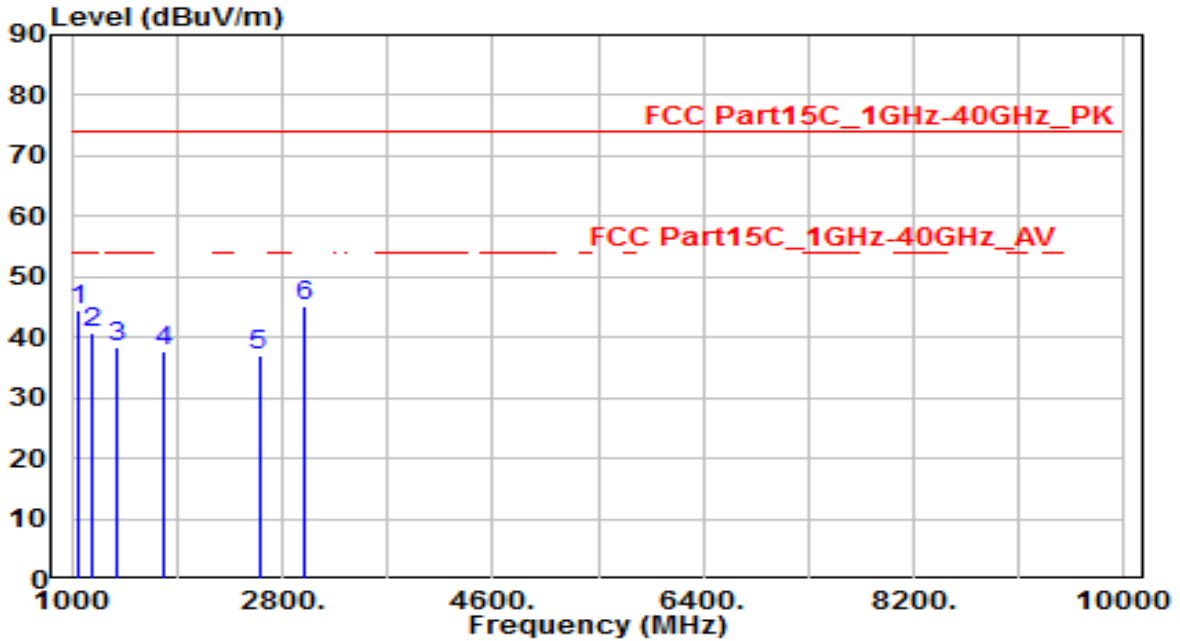

No	Frequency (MHz)	Reading (dBuV)	C.F (dB)	Measurement (dBuV/m)	Margin (dB)	Limit (dBuV/m)	Height (cm)	Angle (deg)	Remark (QP/PK/AV)
1	1056.214	50.77	-6.45	44.33	-29.67	74.00	100	360	Peak
2	1162.893	46.73	-6.06	40.67	-33.33	74.00	100	360	Peak
3	1396.254	43.72	-5.21	38.51	-35.49	74.00	100	360	Peak
4	1798.336	41.85	-4.05	37.80	-36.20	74.00	100	360	Peak
5	2600.842	38.56	-1.64	36.92	-37.08	74.00	100	360	Peak
6	* 2999.985	46.86	-1.73	45.13	-28.87	74.00	100	360	Peak

Note:

- "*", means this data is the worst emission level.
- C.F (Correction Factor) = Antenna Factor (dB)+ Cable Loss (dB) – Preamplifier(dB).
- Measurement (dBuV/m) = Reading(dBuV) + C.F (Correction Factor).
- The emission levels of other frequencies are very lower than the limit and not show in test report.

EUT	Air Monitor MATE	Date of Test	2021-07-15
Factor	BBHA 9120D	Temp. / Humidity	24°C /57%
Polarity	Vertical	Site / Test Engineer	AC1 / Kaunaz
Test Mode	RX-915MHz	Test Voltage	AC 120V/60Hz

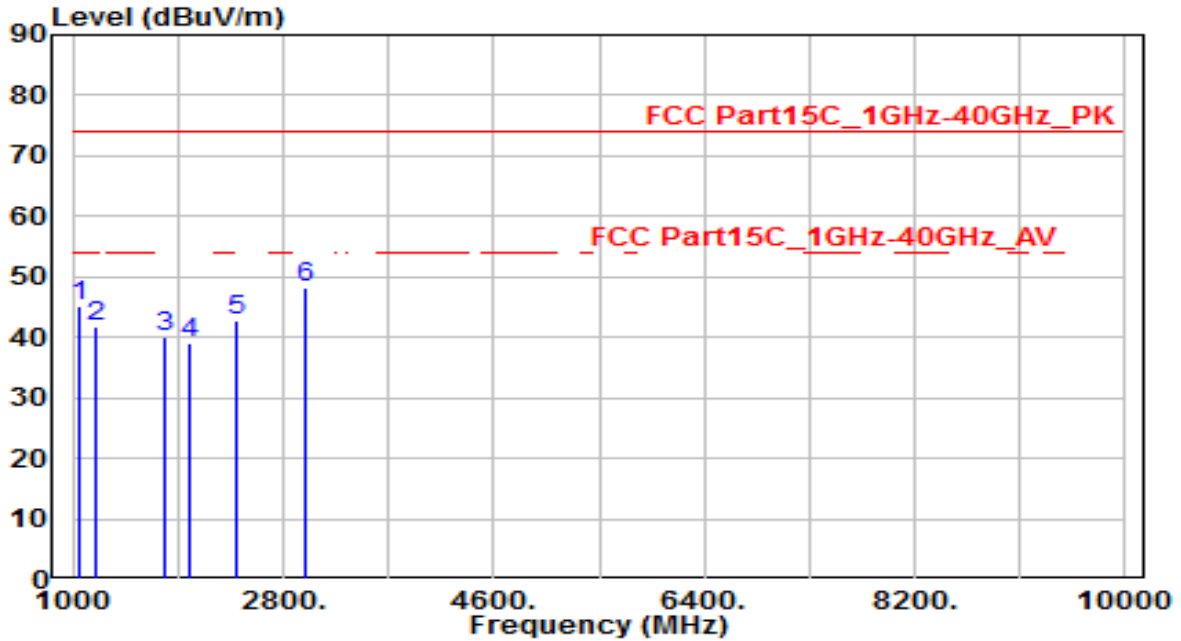

No	Frequency (MHz)	Reading (dBuV)	C.F (dB)	Measurement (dBuV/m)	Margin (dB)	Limit (dBuV/m)	Height (cm)	Angle (deg)	Remark (QP/PK/AV)
1	1061.115	51.62	-6.43	45.19	-28.81	74.00	100	360	Peak
2	1193.825	47.59	-5.94	41.64	-32.36	74.00	100	360	Peak
3	1797.635	44.22	-4.05	40.17	-33.83	74.00	100	360	Peak
4	1990.024	42.52	-3.55	38.97	-35.03	74.00	100	360	Peak
5	2391.987	44.69	-2.03	42.66	-31.34	74.00	100	360	Peak
6	* 2992.320	50.01	-1.73	48.28	-25.72	74.00	100	360	Peak

Note:

- " *", means this data is the worst emission level.
- C.F (Correction Factor) = Antenna Factor (dB)+ Cable Loss (dB) – Pre-amplifier(dB).
- Measurement (dBuV/m) = Reading(dBuV) + C.F (Correction Factor).
- The emission levels of other frequencies are very lower than the limit and not show in test report.

7.7. Radiated Restricted Band Edge Measurement

7.7.1. Test Limit

All out of band emissions appearing in a restricted band as specified in Section 15.205 of the Title 47 CFR must not exceed the limits shown in Table per Section 15.209.

FCC Part 15 Subpart C Paragraph 15.209		
Frequency [MHz]	Field Strength [V/m]	Measured Distance [Meters]
0.009 - 0.490	2400/F (kHz)	300
0.490 - 1.705	24000/F (kHz)	30
1.705 – 30	30	30
30 – 88	100	3
88 – 216	150	3
216 – 960	200	3
Above 960	500	3

7.7.2. Test Procedure Used

ANSI C63.10-2013 - Section 11.12.1

7.7.3. Test Setting

Peak Field Strength Measurements

1. Analyzer center frequency was set to the frequency of the radiated spurious emission of interest
2. RBW = as specified in Table 1
3. VBW = 3 * RBW
4. Detector = peak
5. Sweep time = auto couple
6. Trace mode = max hold
7. Trace was allowed to stabilize

Table 1 - RBW as a function of frequency

Frequency	RBW
9 ~ 150 kHz	200 ~ 300 Hz
0.15 ~ 30 MHz	9 ~ 10 kHz
30 ~ 1000 MHz	100 ~ 120 kHz
> 1000 MHz	1 MHz

Average Field Strength Measurements

1. Analyzer center frequency was set to the frequency of the radiated spurious emission of interest
2. RBW = 1MHz
3. VBW $\geq 1/T$
4. De As an alternative, the instrument may be set to linear detector mode. Ensure that video filtering is applied in linear voltage domain (rather than in a log or dB domain). Some instruments require linear display mode in order to accomplish this. Others have a setting for Average-VBW Type, which can be set to "Voltage" regardless of the display mode
5. Detector = Peak
6. Sweep time = auto
7. Trace mode = max hold
8. Allow max hold to run for at least 50 times (1/duty cycle) traces

7.7.4. Test Setup

1GHz ~ 18GHz Test Setup:

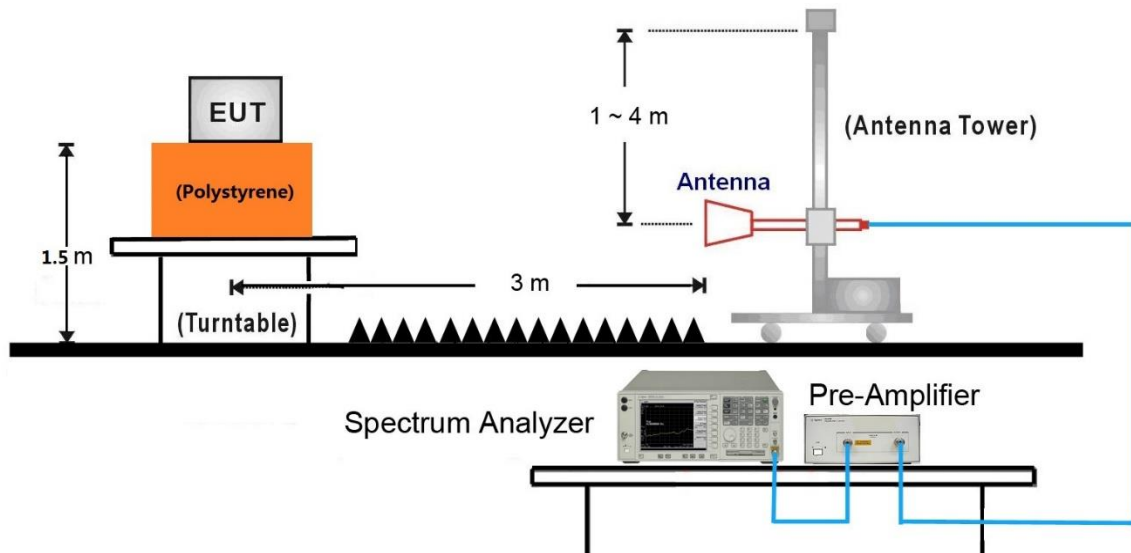

7.7.5. Test Result

EUT	Air Monitor MATE	Date of Test	2021-07-15
Factor	VULB 9162	Temp. / Humidity	24°C /57%
Polarity	Horizontal	Site / Test Engineer	AC1 / Kaunaz
Test Mode	TX-902.4MHz	Test Voltage	AC 120V/60Hz

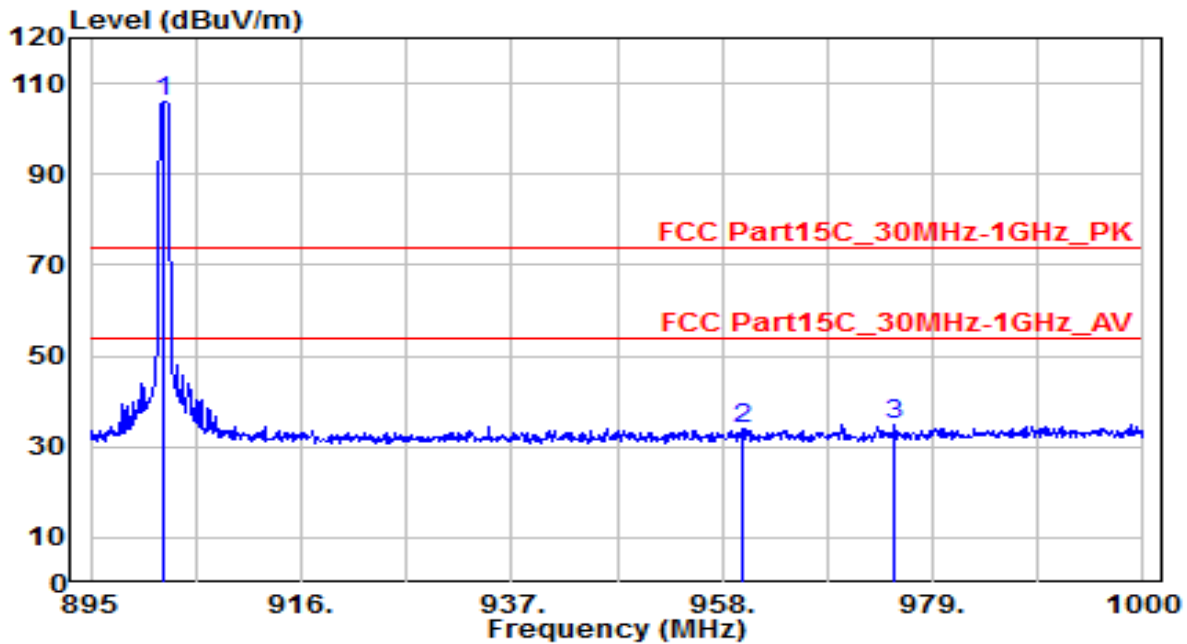

No	Frequency (MHz)	Reading (dBuV)	C.F (dB)	Measurement (dBuV/m)	Margin (dB)	Limit (dBuV/m)	Height (cm)	Angle (deg)	Remark (QP/PK/AV)	
1	*	902.245	74.18	31.79	105.97	31.97	74.00	100	30	Peak
2		959.995	1.49	32.32	33.81	-40.19	74.00	100	30	Peak
3		975.115	2.43	32.56	34.99	N/A	N/A	100	30	Peak

Note:

1. " *", means this data is the worst emission level.
2. C.F (Correction Factor) = Antenna Factor (dB)+ Cable Loss (dB).
3. Measurement (dBuV/m) = Reading(dBuV) + C.F (Correction Factor).
4. The emission levels of other frequencies are very lower than the limit and not show in test report.

EUT	Air Monitor MATE	Date of Test	2021-07-15
Factor	VULB 9162	Temp. / Humidity	24°C /57%
Polarity	Vertical	Site / Test Engineer	AC1 / Kaunaz
Test Mode	TX-902.4MHz	Test Voltage	AC 120V/60Hz

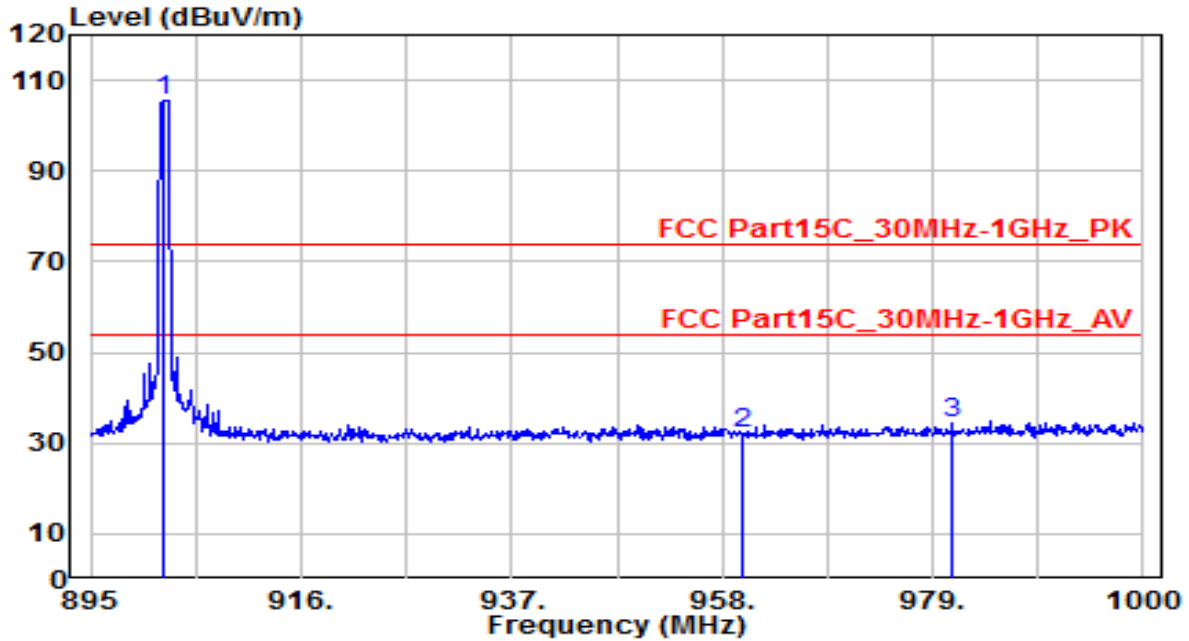

No	Frequency (MHz)	Reading (dBuV)	C.F (dB)	Measurement (dBuV/m)	Margin (dB)	Limit (dBuV/m)	Height (cm)	Angle (deg)	Remark (QP/PK/AV)
1	* 902.140	73.89	31.79	105.68	31.68	74.00	110	25	Peak
2	959.995	0.00	32.32	32.31	-41.69	74.00	110	25	Peak
3	980.890	1.78	32.65	34.42	N/A	N/A	110	25	Peak

Note:

1. " *", means this data is the worst emission level.
2. C.F (Correction Factor) = Antenna Factor (dB)+ Cable Loss (dB).
3. Measurement (dBuV/m) = Reading(dBuV) + C.F (Correction Factor).
4. The emission levels of other frequencies are very lower than the limit and not show in test report.

EUT	Air Monitor MATE	Date of Test	2021-07-15
Factor	VULB 9162	Temp. / Humidity	24°C /57%
Polarity	Horizontal	Site / Test Engineer	AC1 / Kaunaz
Test Mode	TX-927.6MHz	Test Voltage	AC 120V/60Hz

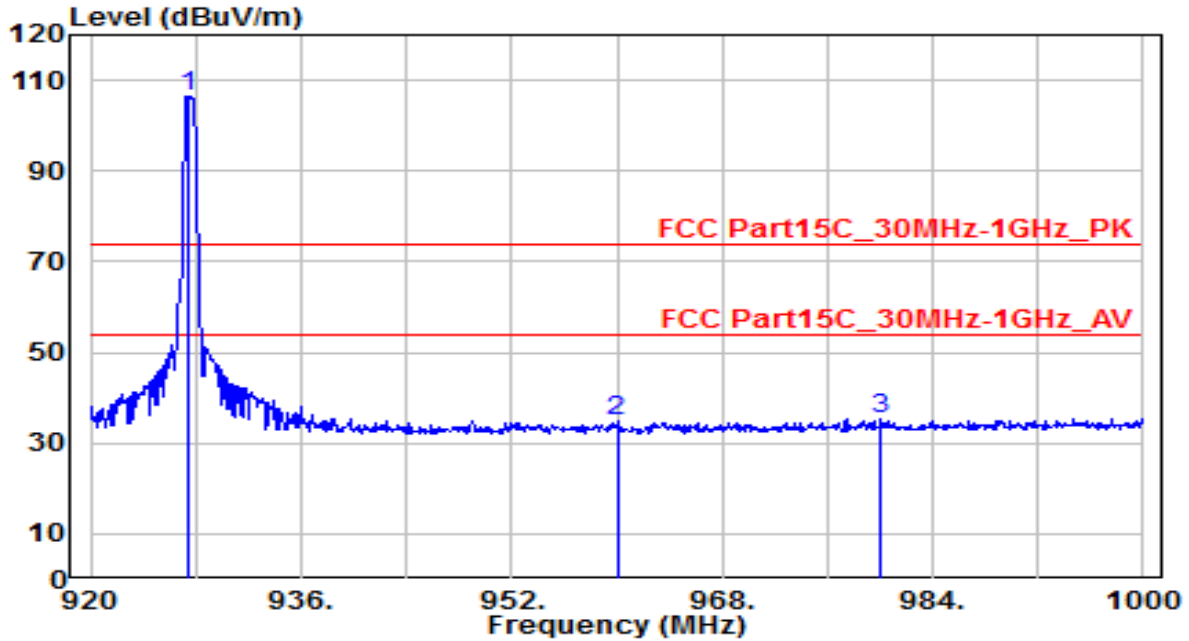

No	Frequency (MHz)	Reading (dBuV)	C.F (dB)	Measurement (dBuV/m)	Margin (dB)	Limit (dBuV/m)	Height (cm)	Angle (deg)	Remark (QP/PK/AV)
1	927.360	74.38	31.98	106.36	N/A	N/A	100	25	Peak
2	960.000	2.52	32.32	34.84	-39.16	74.00	100	25	Peak
3	* 980.000	2.76	32.63	35.39	-38.61	74.00	100	25	Peak

Note:

1. " *" , means this data is the worst emission level.
2. C.F (Correction Factor) = Antenna Factor (dB)+ Cable Loss (dB).
3. Measurement (dBuV/m) = Reading(dBuV) + C.F (Correction Factor).
4. The emission levels of other frequencies are very lower than the limit and not show in test report.

EUT	Air Monitor MATE	Date of Test	2021-07-15
Factor	VULB 9162	Temp. / Humidity	24°C /57%
Polarity	Vertical	Site / Test Engineer	AC1 / Kaunaz
Test Mode	TX-927.6MHz	Test Voltage	AC 120V/60Hz

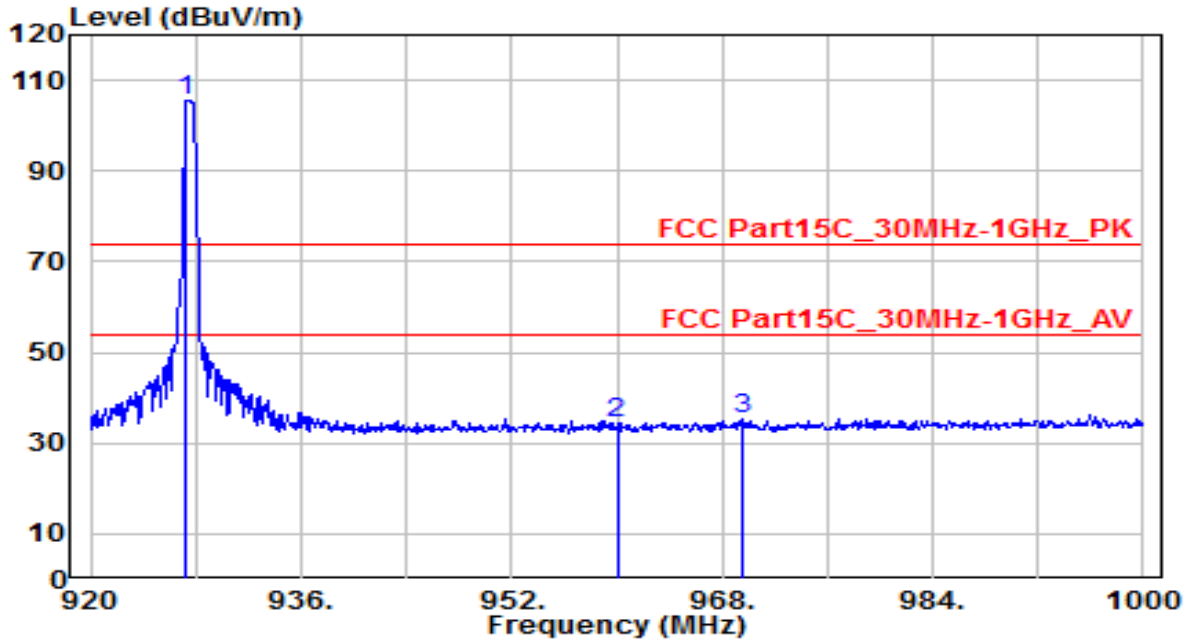

No	Frequency (MHz)	Reading (dBuV)	C.F (dB)	Measurement (dBuV/m)	Margin (dB)	Limit (dBuV/m)	Height (cm)	Angle (deg)	Remark (QP/PK/AV)
1	927.280	73.65	31.98	105.64	N/A	N/A	105	20	Peak
2	960.000	1.98	32.32	34.30	-39.70	74.00	105	20	Peak
3	* 969.600	3.00	32.47	35.47	-38.53	74.00	105	20	Peak

Note:

1. " *", means this data is the worst emission level.
2. C.F (Correction Factor) = Antenna Factor (dB)+ Cable Loss (dB).
3. Measurement (dBuV/m) = Reading(dBuV) + C.F (Correction Factor).
4. The emission levels of other frequencies are very lower than the limit and not show in test report.

7.8. AC Conducted Emissions Measurement

7.8.1. Test Limit

FCC Part 15 Subpart C Paragraph 15.207 / RSS-Gen Limits		
Frequency (MHz)	QP (dB μ V)	Average (dB μ V)
0.15 - 0.50	66 - 56	56 - 46
0.50 - 5.0	56	46
5.0 - 30	60	50

Note 1: The lower limit shall apply at the transition frequencies.

Note 2: The limit decreases linearly with the logarithm of the frequency in the range 0.15MHz to 0.5MHz.

7.8.2. Test Setup

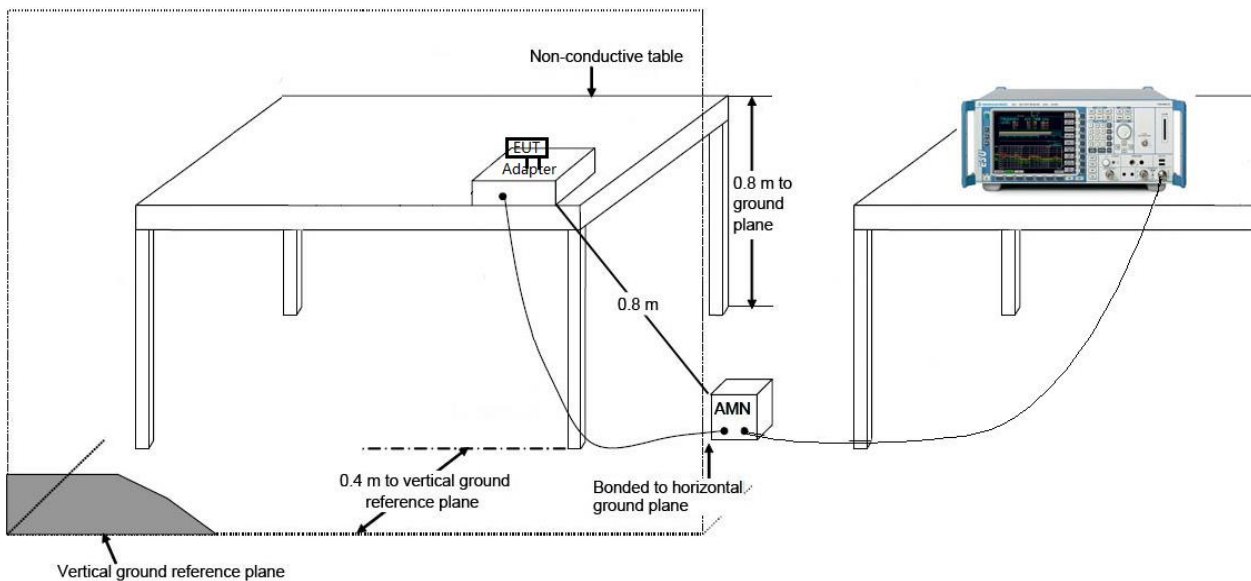

7.8.3. Test Result

EUT	Air Monitor MATE	Date of Test	2021-07-08
Factor	CE_ENV216-L1 (Filter ON)	Temp. / Humidity	26.9°C /54%
Polarity	Line1	Site / Test Engineer	SR2 / volvo
Test Mode	TX-915MHz	Test Voltage	AC 120V/60Hz

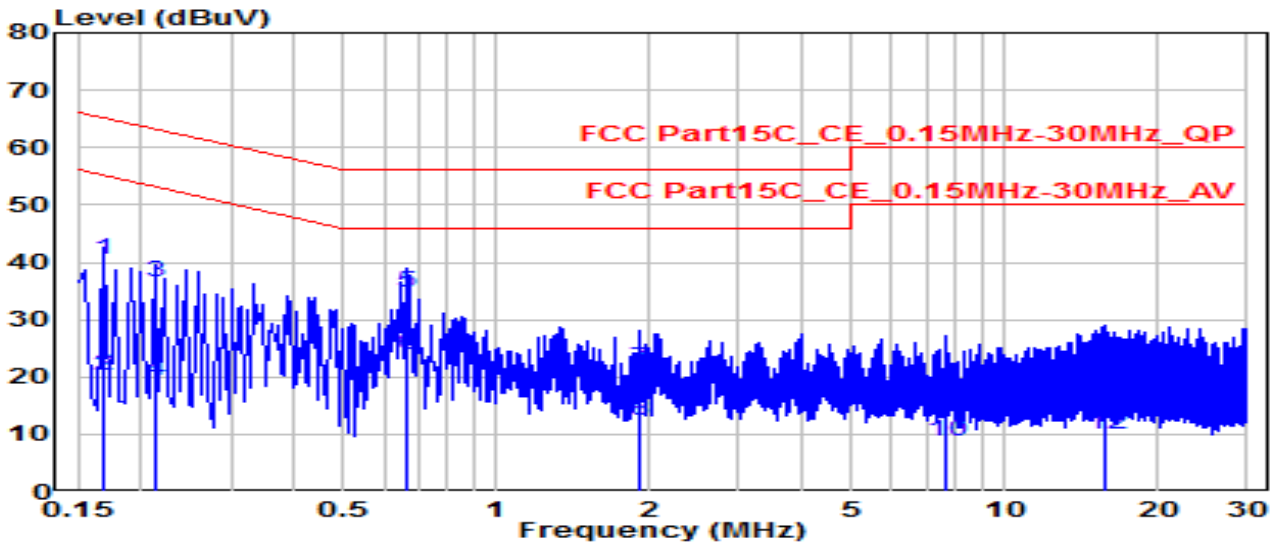

No	Frequency (MHz)	Reading (dBuV)	C.F (dB)	Measurement (dBuV/m)	Margin (dB)	Limit (dBuV/m)	Remark (QP/PK/AV)
1	0.168	30.76	9.61	40.37	-24.68	65.06	QP
2	0.168	10.61	9.61	20.23	-34.83	55.06	Average
3	0.213	26.79	9.61	36.40	-26.69	63.09	QP
4	0.213	9.67	9.61	19.28	-33.81	53.09	Average
5	* 0.663	25.10	9.64	34.74	-21.26	56.00	QP
6	* 0.663	14.11	9.64	23.75	-22.25	46.00	Average
7	1.905	11.86	9.69	21.55	-34.45	56.00	QP
8	1.905	2.84	9.69	12.52	-33.48	46.00	Average
9	7.687	4.61	9.81	14.42	-45.58	60.00	QP
10	7.687	-1.12	9.81	8.69	-41.31	50.00	Average
11	15.745	10.93	9.93	20.86	-39.14	60.00	QP
12	15.745	0.07	9.93	10.00	-40.00	50.00	Average

Note:

1. " *", means this data is the worst emission level.
2. C.F (Correction Factor) = Antenna Factor (dB)+ Cable Loss (dB).
3. Measurement (dBuV/m) = Reading(dBuV) + C.F (Correction Factor).

EUT	Air Monitor MATE	Date of Test	2021-07-08
Factor	CE_ENV216-N (Filter ON)	Temp. / Humidity	26.9°C /54%
Polarity	Neutral	Site / Test Engineer	SR2 / volvo
Test Mode	TX-915MHz	Test Voltage	AC 120V/60Hz

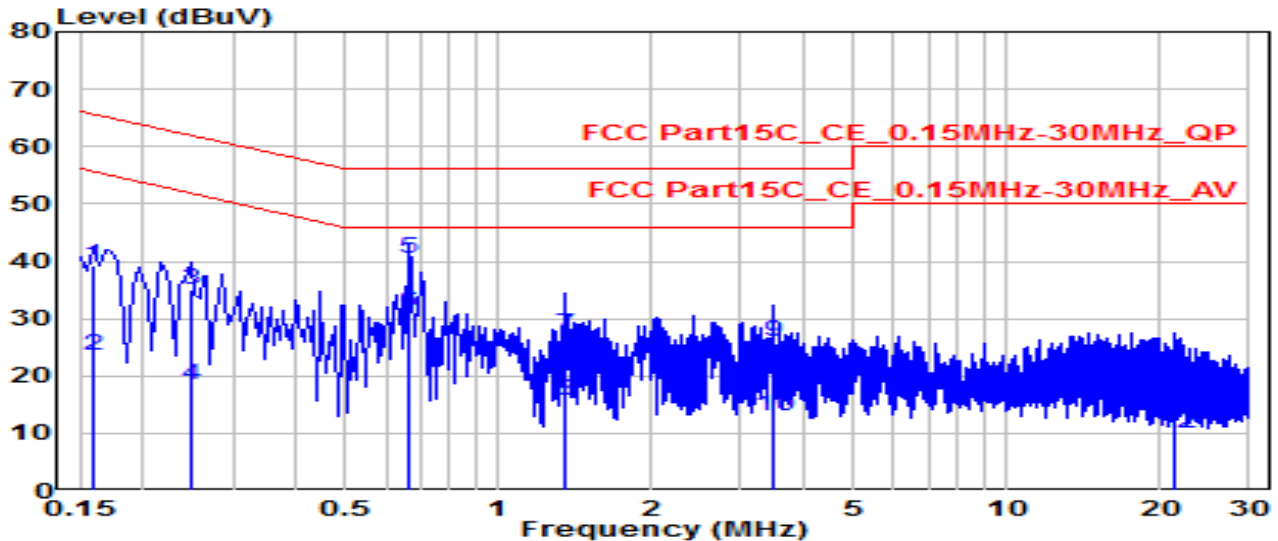

No	Frequency (MHz)	Reading (dBuV)	C.F (dB)	Measurement (dBuV/m)	Margin (dB)	Limit (dBuV/m)	Remark (QP/PK/AV)
1	0.159	29.74	9.62	39.35	-26.16	65.52	QP
2	0.159	13.78	9.62	23.40	-32.12	55.52	Average
3	0.249	25.38	9.62	35.00	-26.79	61.79	QP
4	0.249	8.90	9.62	18.51	-33.28	51.79	Average
5	* 0.667	30.81	9.65	40.46	-15.54	56.00	QP
6	* 0.667	21.60	9.65	31.24	-14.76	46.00	Average
7	1.351	17.41	9.68	27.09	-28.91	56.00	QP
8	1.351	5.99	9.68	15.67	-30.33	46.00	Average
9	3.466	16.14	9.72	25.86	-30.14	56.00	QP
10	3.466	3.13	9.72	12.85	-33.15	46.00	Average
11	21.428	7.29	10.06	17.35	-42.65	60.00	QP
12	21.428	-0.13	10.06	9.93	-40.07	50.00	Average

Note:

- "*", means this data is the worst emission level.
- C.F (Correction Factor) = Antenna Factor (dB)+ Cable Loss (dB).
- Measurement (dBuV/m) = Reading(dBuV) + C.F (Correction Factor).

EUT	Air Monitor MATE	Date of Test	2021-07-08
Factor	CE_ENV216-L1 (Filter ON)	Temp. / Humidity	26.9°C /54%
Polarity	Line1	Site / Test Engineer	SR2 / volvo
Test Mode	TX-915MHz	Test Voltage	AC 240V/60Hz

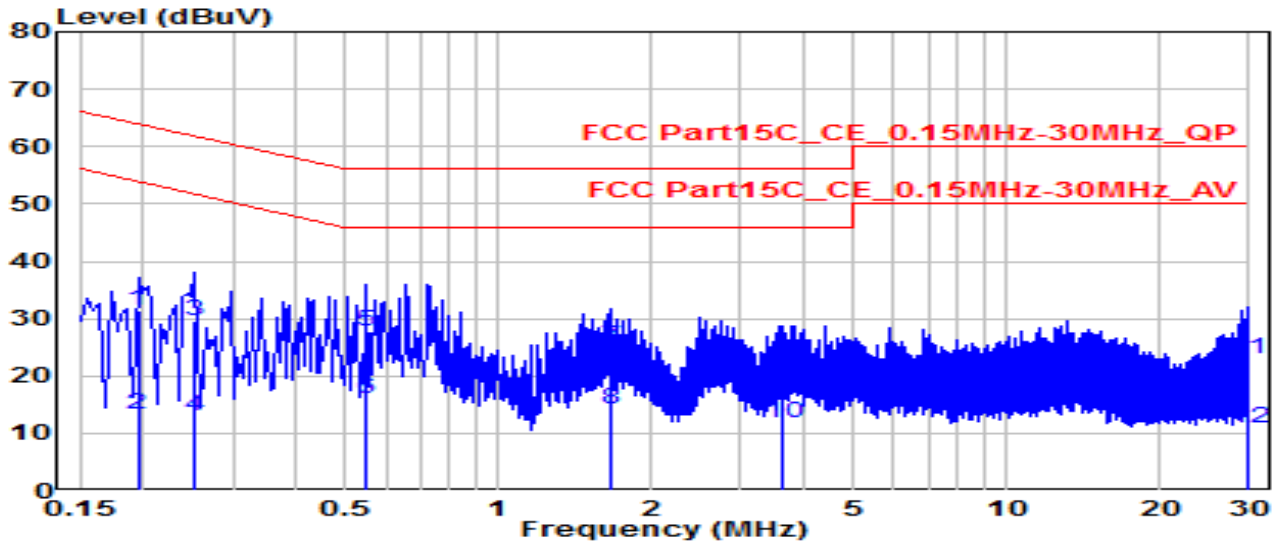

No	Frequency (MHz)	Reading (dBUV)	C.F (dB)	Measurement (dBUV/m)	Margin (dB)	Limit (dBUV/m)	Remark (QP/PK/AV)
1	0.195	21.74	9.61	31.35	-32.47	63.82	QP
2	0.195	3.65	9.61	13.26	-40.56	53.82	Average
3	0.253	19.88	9.62	29.49	-32.15	61.64	QP
4	0.253	3.48	9.62	13.10	-38.54	51.64	Average
5	* 0.550	18.09	9.63	27.72	-28.28	56.00	QP
6	* 0.550	6.37	9.63	16.00	-30.00	46.00	Average
7	1.675	15.44	9.68	25.12	-30.88	56.00	QP
8	1.675	4.49	9.68	14.18	-31.82	46.00	Average
9	3.615	11.14	9.71	20.85	-35.15	56.00	QP
10	3.615	2.13	9.71	11.85	-34.15	46.00	Average
11	29.757	12.77	10.06	22.83	-37.17	60.00	QP
12	29.757	0.73	10.06	10.79	-39.21	50.00	Average

Note:

1. " *", means this data is the worst emission level.
2. C.F (Correction Factor) = Antenna Factor (dB)+ Cable Loss (dB).
3. Measurement (dBUV/m) = Reading(dBUV) + C.F (Correction Factor).

EUT	Air Monitor MATE	Date of Test	2021-07-08
Factor	CE_ENV216-N (Filter ON)	Temp. / Humidity	26.9°C /54%
Polarity	Neutral	Site / Test Engineer	SR2 / volvo
Test Mode	TX-915MHz	Test Voltage	AC 240V/60Hz

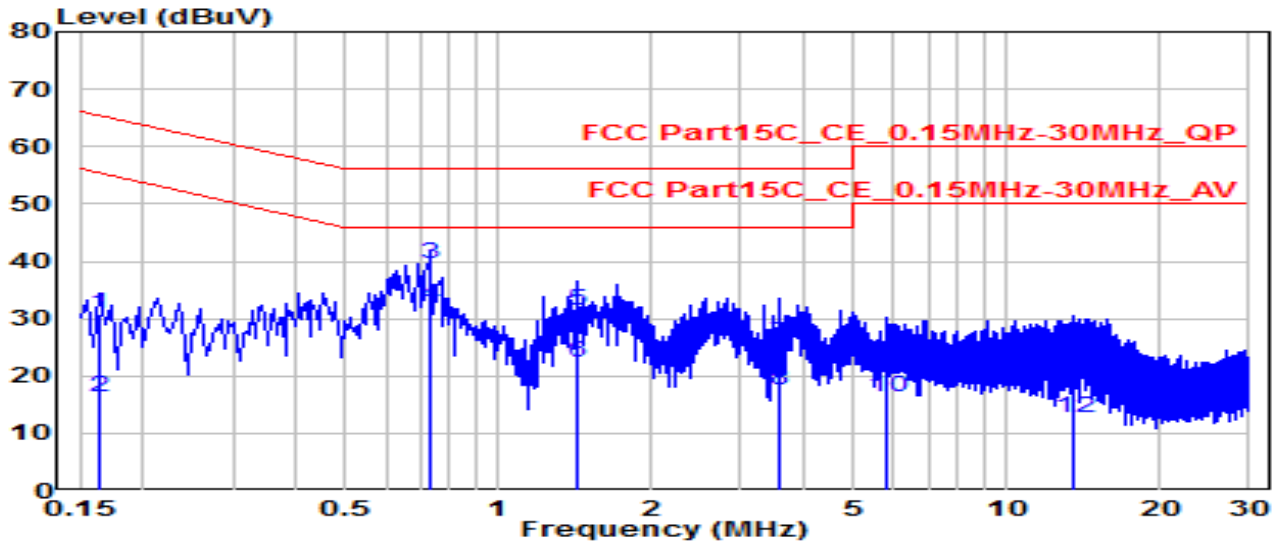

No	Frequency (MHz)	Reading (dBUV)	C.F (dB)	Measurement (dBUV/m)	Margin (dB)	Limit (dBUV/m)	Remark (QP/PK/AV)
1	0.163	21.22	9.62	30.84	-34.45	65.28	QP
2	0.163	6.81	9.62	16.43	-38.86	55.28	Average
3	* 0.735	30.04	9.65	39.70	-16.30	56.00	QP
4	* 0.735	22.71	9.65	32.36	-13.64	46.00	Average
5	1.428	21.71	9.68	31.39	-24.61	56.00	QP
6	1.428	12.76	9.68	22.44	-23.56	46.00	Average
7	3.588	15.82	9.72	25.54	-30.46	56.00	QP
8	3.588	7.68	9.72	17.40	-28.60	46.00	Average
9	5.828	12.55	9.77	22.32	-37.68	60.00	QP
10	5.828	6.50	9.77	16.27	-33.73	50.00	Average
11	13.622	13.48	9.94	23.43	-36.57	60.00	QP
12	13.622	2.81	9.94	12.75	-37.25	50.00	Average

Note:

1. " *", means this data is the worst emission level.
2. C.F (Correction Factor) = Antenna Factor (dB)+ Cable Loss (dB).
3. Measurement (dBUV/m) = Reading(dBUV) + C.F (Correction Factor).

8. CONCLUSION

The data collected relate only the item(s) tested and show that the **Air Monitor MATE** is in compliance with Part 15C of the FCC Rules.

————— The End —————