

TEST REPORT

Product Name : Rugged Tablet Computer
Model Number : TB170
FCC ID : HLETB170BTNL

Prepared for : Unitech Electronics Co., Ltd.
Address : 5F, No. 136, Lane 235, Pao-Chiao Rd., Hsin-Tien Dist.,
New Taipei City, Taiwan

Prepared by : EMTEK (SHENZHEN) CO., LTD.
Address : Building 69, Majialong Industry Zone, Nanshan District,
Shenzhen, Guangdong, China

Tel: (0755) 26954280
Fax: (0755) 26954282

Report Number : ENS2307140091W00104R
Date(s) of Tests : December 25, 2020 to March 26, 2021
Date of Issue : July 28, 2023

TABLE OF CONTENTS

1 TEST RESULT CERTIFICATION	4
2 EUT TECHNICAL DESCRIPTION	5
3 SUMMARY OF TEST RESULT	7
4 TEST METHODOLOGY	8
4.1 GENERAL DESCRIPTION OF APPLIED STANDARDS.....	8
4.2 MEASUREMENT EQUIPMENT USED.....	8
4.3 DESCRIPTION OF TEST MODES.....	9
5 FACILITIES AND ACCREDITATIONS	14
5.1 FACILITIES.....	14
5.2 LABORATORY ACCREDITATIONS AND LISTINGS.....	14
6 TEST SYSTEM UNCERTAINTY	15
7 SETUP OF EQUIPMENT UNDER TEST	16
7.1 RADIO FREQUENCY TEST SETUP.....	16
7.2 RADIO FREQUENCY TEST SETUP.....	16
7.3 CONDUCTED EMISSION TEST SETUP.....	18
7.4 BLOCK DIAGRAM CONFIGURATION OF TEST SYSTEM.....	19
7.5 SUPPORT EQUIPMENT.....	19
8 TEST REQUIREMENTS	20
8.1 BANDWIDTH MEASUREMENT.....	20
8.2 MAXIMUM CONDUCTED OUTPUT POWER.....	146
8.3 MAXIMUM PEAK POWER DENSITY.....	160
8.4 FREQUENCY STABILITY.....	234
8.5 UNDESIRABLE RADIATED SPURIOUS EMISSION.....	243
8.6 POWER LINE CONDUCTED EMISSIONS.....	272
8.7 ANTENNA APPLICATION.....	275

Modified Information

Version	Report No.	Revision Date	Summary
Ver.1.0	ENS2307140091W00104R	/	Original Report

1 TEST RESULT CERTIFICATION

Applicant : Unitech Electronics Co., Ltd.
 Address : 5F, No. 136, Lane 235, Pao-Chiao Rd., Hsin-Tien Dist., New Taipei City, Taiwan
 Manufacturer : Unitech Electronics Co., Ltd.
 Address : 5F, No. 136, Lane 235, Pao-Chiao Rd., Hsin-Tien Dist., New Taipei City, Taiwan
 EUT : Rugged Tablet Computer
 Model Name : TB170
 Trademark : unitech

Measurement Procedure Used:

APPLICABLE STANDARDS	
STANDARD	TEST RESULT
FCC 47 CFR Part 2, Subpart J FCC 47 CFR Part 15, Subpart E	PASS

The above equipment was tested by EMTEK (SHENZHEN) CO., LTD. The test data, data evaluation, test procedures, and equipment configurations shown in this report were made in accordance with the procedures given in ANSI C63.10 (2013) and the energy emitted by the sample EUT tested as described in this report is in compliance with the requirements of FCC Rules Part 2 and Part 15.407.

The test results of this report relate only to the tested sample identified in this report.

Date of Test : December 25, 2020 to March 26, 2021

Prepared by : 
 Una Yu/Editor

Reviewer : 
 Joe Xia/Supervisor

Approved & Authorized Signer : 
 Lisa Wang/Manager



2 EUT TECHNICAL DESCRIPTION

Characteristics	Description
Product	Rugged Tablet Computer
Model Number	TB170
Wifi Type	<input checked="" type="checkbox"/> UNII-1: 5150MHz-5250MHz Band <input checked="" type="checkbox"/> UNII-2A: with 5250MHz-5350MHz Band <input checked="" type="checkbox"/> UNII-2C: with 5470MHz-5725MHz Band <input checked="" type="checkbox"/> UNII-3: with 5725MHz-5850MHz Band
WLAN Supported	<input checked="" type="checkbox"/> 802.11a <input checked="" type="checkbox"/> 802.11n(20MHz channel bandwidth) <input checked="" type="checkbox"/> 802.11n(40MHz channel bandwidth) <input checked="" type="checkbox"/> 802.11ac(20MHz channel bandwidth) <input checked="" type="checkbox"/> 802.11ac(40MHz channel bandwidth) <input checked="" type="checkbox"/> 802.11ac(80MHz channel bandwidth) <input checked="" type="checkbox"/> 802.11ac(160MHz channel bandwidth)
Data Rate	802.11a:54/48/36/24/18/12/9/6Mbps 802.11n:up to 600 Mbps 802.11ac:up to 1.733Gbps
Modulation	<input checked="" type="checkbox"/> OFDM with BPSK/QPSK/16QAM/64QAM for 802.11a/n <input checked="" type="checkbox"/> OFDM with BPSK/QPSK/16QAM/64QAM/256QAM for 802.11ac
Frequency Range	<input checked="" type="checkbox"/> UNII-1: 5150MHz-5250MHz Band <input checked="" type="checkbox"/> 5180-5240MHz for 802.11a <input checked="" type="checkbox"/> 5180-5240MHz for 802.11n(HT20) <input checked="" type="checkbox"/> 5180-5240MHz for 802.11ac(HT20)
	<input checked="" type="checkbox"/> 5190-5230MHz for 802.11n(HT40) <input checked="" type="checkbox"/> 5190-5230MHz for 802.11ac(HT40) <input checked="" type="checkbox"/> 5210MHz for 802.11ac(HT80) <input checked="" type="checkbox"/> 5250MHz for 802.11ac(HT160)
	<input checked="" type="checkbox"/> UNII-2A: with 5250MHz-5350MHz Band <input checked="" type="checkbox"/> 5260-5320MHz for 802.11a <input checked="" type="checkbox"/> 5260-5320MHz for 802.11n(HT20) <input checked="" type="checkbox"/> 5260-5320MHz for 802.11ac(HT20)
	<input checked="" type="checkbox"/> 5270-5310MHz for 802.11n(HT40) <input checked="" type="checkbox"/> 5270-5310MHz for 802.11ac(HT40) <input checked="" type="checkbox"/> 5290MHz for 802.11ac(HT80)
	<input checked="" type="checkbox"/> UNII-2C: with 5470MHz-5725MHz Band <input checked="" type="checkbox"/> 5500-5700MHz for 802.11a <input checked="" type="checkbox"/> 5500-5700MHz for 802.11n(HT20) <input checked="" type="checkbox"/> 5500-5700MHz for 802.11ac(HT20)
	<input checked="" type="checkbox"/> 5510-5670MHz for 802.11n(HT40) <input checked="" type="checkbox"/> 5510-5670MHz for 802.11ac(HT40) <input checked="" type="checkbox"/> 5530-5610MHz for 802.11ac(HT80)
Frequency Range	<input checked="" type="checkbox"/> UNII-3 with 5725MHz-5850MHz Band <input checked="" type="checkbox"/> 5745-5825MHz for 802.11a <input checked="" type="checkbox"/> 5745-5825MHz for 802.11n(HT20) <input checked="" type="checkbox"/> 5745-5825MHz for 802.11ac(HT20)
	<input checked="" type="checkbox"/> 5755-5795MHz for 802.11n(HT40) <input checked="" type="checkbox"/> 5755-5795MHz for 802.11ac(HT40) <input checked="" type="checkbox"/> 5775MHz for 802.11ac(HT80)
TPC Function	<input type="checkbox"/> Applicable <input checked="" type="checkbox"/> Not Applicable
Antenna Type	PIFA Antenna
Antenna Gain	Main(Antenna 1) AUX(Antenna 2)

	5150-5350: 3.4 dBi 5500-5700: 3.8 dBi 5725-5825: 3.8 dBi	5150-5350: 2.0 dBi 5500-5700: 4.9 dBi 5725-5825: 4.9 dBi
Power Supply	<p>Battery 1: Model: IP575399-2S Rating: DC 7.6V, 4800mAh, 36.5Wh</p> <p>Battery 2: Model: TBB-MA1 Rating: DC 7.68V, 4170mAh, 32.0Wh</p> <p>Adapter 1: Model: ADP-65JH HB INPUT: 100-240V~1.5A, 50-60Hz OUTPUT: DC 19V, 3.42A</p> <p>Adapter 2: Model: A18-065N3A INPUT: 100-240V~1.7A, 50-60Hz OUTPUT: DC 19V, 3.42A</p>	
Temperature Range	-20°C ~ +60°C	

Note: for more details, please refer to the user's manual of the EUT.

3 SUMMARY OF TEST RESULT

FCC Part Clause	Test Parameter	Verdict	Remark
15.407 (a), 15.407 (e)	99%, 6dB and 26dB Bandwidth	PASS	
15.407 (a)	Maximum Conducted Output Power	PASS	
15.407 (a)	Peak Power Spectral Density	PASS	
15.407 (b)	Radiated Spurious Emission	PASS	
15.407(g)	Frequency Stability	PASS	
15.407 (b)(6), 15.207	Power Line Conducted Emission	PASS	
15.407(a), 15.203	Antenna Application	PASS	

NOTE1: N/A (Not Applicable)

NOTE2: According to FCC OET KDB 789033 D2 General UNII Test Procedures New Rules v02r01, In addition, the radiated test is also performed to ensure the emissions emanating from the device cabinet also comply with the applicable limits.

NOTE3: This report only updates the battery2 information, it has been verified that the FCC Part 15B EMC testing to ensure compliance, and find that the EMC parameter is not degradation. This change do not affect this 5G WiFi report test results, so the test data refer to original report No.ENS2205200174W00304R.

RELATED SUBMITTAL(S) / GRANT(S):

This submittal(s) (test report) is intended for FCC ID: HLETB170BTNL filing to comply with Section 15.407 of the FCC Part 15, Subpart E Rules.

4 TEST METHODOLOGY

4.1 GENERAL DESCRIPTION OF APPLIED STANDARDS

According to its specifications, the EUT must comply with the requirements of the following standards:

FCC 47 CFR Part 2, Subpart J

FCC 47 CFR Part 15, Subpart E

FCC KDB 789033 D2 General UNII Test Procedures New Rules v02r01

FCC KDB 662911 D01 Multiple Transmitter Output v02r01

4.2 MEASUREMENT EQUIPMENT USED

For Spurious Emissions Test

Equipment	Manufacturer	Model No.	Serial No.	Last Cal.	Cal. Interval
EMI Test Receiver	Rohde & Schwarz	ESU 26	100154	May 17, 2020	1 Year
Pre-Amplifier	Lunar EM	LNA30M3G-25	J10100000070	May 17, 2020	1 Year
Bilog Antenna	Schwarzbeck	VULB9163	659	Sep 22, 2019	2 Year
Horn antenna	Schwarzbeck	BBHA9120D	9120D-1177	May 17, 2020	2 Year
Pre-Amplifier	SKET	LNPA_0118G-45	SK2019051801	May 17, 2020	1 Year
Loop Antenna	Schwarzbeck	FMZB1519	1519-012	July 14, 2019	2 Year
Spectrum Analyzer	Rohde & Schwarz	FSV40	100967	May 17, 2020	1 Year
Horn antenna	Schwarzbeck	BBHA9120D	9120D-1198	May 17, 2020	2 Year
Bilog Antenna	Schwarzbeck	VULB9163	660	July 16, 2019	2 Year
Cable	H+B	NmSm-05-C15052	N/A	May 17, 2020	1 Year
Cable	H+B	NmSm-2-C15201	N/A	May 17, 2020	1 Year
Cable	H+B	NmNm-7-C15702	N/A	May 17, 2020	1 Year
Cable	H+B	SAC-40G-1	414	May 17, 2020	1 Year
Cable	H+B	SUCOFLEX104	MY14871/4	May 17, 2020	
Cable	H+B	BLU18A-NmSm-6500	D8501	May 17, 2020	1 Year
Band reject Filter(50dB)	WI/DE	WRCGV-2400(2400-2485MHz)	2	May 17, 2020	1 Year

For Other Test Items

Equipment	Manufacturer	Model No.	Serial No.	Last Cal.	Cal. Interval
Vector Signal Generator	Agilent	N5182B	My53050553	May 17, 2020	1 Year
Analog Signal Generator	Agilent	N5171B	My53050878	May 17, 2020	1 Year
Signal Analyzer	Agilent	N9010A	My53470879	May 17, 2020	1 Year
Power Analyzer	Agilent	PS-X10-200	N/A	May 17, 2020	1 Year
Wideband Radio Communication Tester	R&S	CMW500	1201.0002K50-140822zk	May 17, 2020	1 Year
Test Accessories	Agilent	PS-X10-100	N/A	May 17, 2020	1 Year
Temperature&Humidity test chamber	ESPEC	EL-02KA	12107166	May 17, 2020	1 Year
Blocking Box	Agilent	AD211	N/A	May 17, 2020	1 Year

4.3 DESCRIPTION OF TEST MODES

The EUT has been tested under its typical operating condition.

The EUT configuration for testing is installed on RF field strength measurement to meet the Commissions requirement and operating in a manner which intends to maximize its emission characteristics in a continuous normal application.

The Transmitter was operated in the normal operating mode. The TX frequency was fixed which was for the purpose of the measurements.

Test of channel included the lowest and middle and highest frequency to perform the test, then record on this report.

Pre-defined engineering program for regulatory testing used to control the EUT for staying in continuous transmitting and receiving mode is programmed.

The 5G WIFI has two antennas and support Multiple Outputs for 802.11n/ac; mode for this report; U-NII-1 and U-NII-2A Antenna 1 Gain is 3.4dBi; U-NII-2C and U-NII-3 Antenna 1 Gain is 3.8dBi; U-NII-1 and U-NII-2A Antenna 2 Gain is 2.0dBi; U-NII-2C and U-NII-3 Antenna 2 Gain is 4.9dBi; For this function is belong to Correlated Categorization equipment

According to KDB 662911, for Unequal antenna gains,

U-NII-1 and U-NII-2A

Directional gain = $10 \log[(10^{3.4/20} + 10^{2.0/20})^2/2]$ dBi=5.75 dBi

U-NII-2C and U-NII-3

Directional gain = $10 \log[(10^{2.0/20} + 10^{4.9/20})^2/2]$ dBi= 6.59dBi

Wifi 5G with 5150-5250MHz

Frequency and Channels list for 802.11a/n(20)/802.11ac(20):

Channel	Frequency (MHz)	Channel	Frequency (MHz)	Channel	Frequency (MHz)
36	5180	44	5220		
40	5200	48	5240		

Frequency and Channels list for 802.11n (40)/802.11ac(40):

Channel	Frequency (MHz)	Channel	Frequency (MHz)	Channel	Frequency (MHz)
38	5190				
46	5230				

Frequency and Channel list for 802.11ac(80):

Channel	Frequency (MHz)	Channel	Frequency (MHz)	Channel	Frequency (MHz)
42	5210				

Frequency and Channels list for 802.11ac(160):

Channel	Frequency (MHz)	Channel	Frequency (MHz)	Channel	Frequency (MHz)
50	5250				

Test Frequency and Channels for 802.11a/n(20)/802.11ac(20):

Lowest Frequency		Middle Frequency		Highest Frequency	
Channel	Frequency (MHz)	Channel	Frequency (MHz)	Channel	Frequency (MHz)
36	5180	40	5200	48	5240

Test Frequency and channels for 802.11n (40)/ 802.11ac:

Lowest Frequency		Middle Frequency		Highest Frequency	
Channel	Frequency (MHz)	Channel	Frequency (MHz)	Channel	Frequency (MHz)
38	5190	N/A	N/A	46	5230

Test Frequency and channels for 802.11ac(80):

Lowest Frequency		Middle Frequency		Highest Frequency	
Channel	Frequency (MHz)	Channel	Frequency (MHz)	Channel	Frequency (MHz)
42	5210	N/A	N/A	N/A	N/A

Test Frequency and channels for 802.11ac(160):

Channel	Frequency (MHz)	Channel	Frequency (MHz)	Channel	Frequency (MHz)
50	5250				

Wifi 5G with 5250-5350MHz

Frequency and Channels list for 802.11a/n(20)/802.11ac(20):

Channel	Frequency (MHz)	Channel	Frequency (MHz)	Channel	Frequency (MHz)
52	5260	60	5300		
56	5280	64	5320		

Frequency and Channels list for 802.11n (40)/ 802.11ac(40):

Channel	Frequency (MHz)	Channel	Frequency (MHz)	Channel	Frequency (MHz)
54	5270				
62	5310				

Frequency and Channels list for 802.11ac(80):

Channel	Frequency (MHz)	Channel	Frequency (MHz)	Channel	Frequency (MHz)
58	5290				

Test Frequency and Channels for 802.11a/n(20)/802.11ac(20):

Lowest Frequency		Middle Frequency		Highest Frequency	
Channel	Frequency (MHz)	Channel	Frequency (MHz)	Channel	Frequency (MHz)
52	5260	56	5280	64	5320

Test Frequency and channels for 802.11n(40)/ 802.11ac(40):

Lowest Frequency		Middle Frequency		Highest Frequency	
Channel	Frequency (MHz)	Channel	Frequency (MHz)	Channel	Frequency (MHz)
54	5270	N/A	N/A	62	5310

Test Frequency and channels for 802.11ac(80):

Lowest Frequency		Middle Frequency		Highest Frequency	
Channel	Frequency (MHz)	Channel	Frequency (MHz)	Channel	Frequency (MHz)
58	5290				

Wifi 5G with 5470-5725MHz

Frequency and Channels list for 802.11a/n(20)/802.11ac(20):

Channel	Frequency (MHz)	Channel	Frequency (MHz)	Channel	Frequency (MHz)
100	5500	116	5580	132	5660
104	5520	120	5600	136	5680
108	5540	124	5620	140	5700
112	5560	128	5640		

Frequency and Channels list for 802.11n(40)/ 802.11ac(40):

Channel	Frequency (MHz)	Channel	Frequency (MHz)	Channel	Frequency (MHz)
102	5510	118	5590	134	5670
110	5550	126	5630		

Frequency and Channels list for 802.11ac(80):

Channel	Frequency (MHz)	Channel	Frequency (MHz)	Channel	Frequency (MHz)
106	5530	122	5610		

Test Frequency and Channels for 802.11a/n(20)/802.11ac(20):

Lowest Frequency		Middle Frequency		Highest Frequency	
Channel	Frequency (MHz)	Channel	Frequency (MHz)	Channel	Frequency (MHz)
100	5500	116	5580	140	5700

Test Frequency and channels for 802.11n(40)/ 802.11ac(40):

Lowest Frequency		Middle Frequency		Highest Frequency	
Channel	Frequency (MHz)	Channel	Frequency (MHz)	Channel	Frequency (MHz)
102	5510			134	5670

Test Frequency and channels for 802.11ac(80):

Lowest Frequency		Middle Frequency		Highest Frequency	
Channel	Frequency (MHz)	Channel	Frequency (MHz)	Channel	Frequency (MHz)
106	5530	122	5610		

Wifi 5G with 5725MHz-5850MHz

Frequency and Channels list for 802.11a/n(20)/802.11ac(20):

Channel	Frequency (MHz)	Channel	Frequency (MHz)	Channel	Frequency (MHz)
149	5745	157	5785	165	5825
153	5765	161	5805		

Frequency and Channels list for 802.11n (40)/ 802.11ac:

Channel	Frequency (MHz)	Channel	Frequency (MHz)	Channel	Frequency (MHz)
151	5755				
159	5795				

Frequency and Channels list for 802.11ac(80):

Channel	Frequency (MHz)	Channel	Frequency (MHz)	Channel	Frequency (MHz)
155	5775				

Test Frequency and Channels for 802.11a/n(20)/802.11ac(20):

Lowest Frequency		Middle Frequency		Highest Frequency	
Channel	Frequency (MHz)	Channel	Frequency (MHz)	Channel	Frequency (MHz)
149	5745	157	5785	165	5825

Test Frequency and channels for 802.11n (40)/ 802.11ac:

Lowest Frequency		Middle Frequency		Highest Frequency	
Channel	Frequency (MHz)	Channel	Frequency (MHz)	Channel	Frequency (MHz)
151	5755			159	5795

Test Frequency and channels for 802.11ac(80):

Lowest Frequency		Middle Frequency		Highest Frequency	
Channel	Frequency (MHz)	Channel	Frequency (MHz)	Channel	Frequency (MHz)
155	5775				

5 FACILITIES AND ACCREDITATIONS

5.1 FACILITIES

All measurement facilities used to collect the measurement data are located at

Building 69, Majialong Industry Zone District, Nanshan District, Shenzhen, China

The sites are constructed in conformance with the requirements of ANSI C63.7, ANSI C63.10 and CISPR Publication 22.

5.2 LABORATORY ACCREDITATIONS AND LISTINGS

Site Description

EMC Lab.

: **Accredited by CNAS**

The Certificate Registration Number is L2291

The Laboratory has been assessed and proved to be in compliance with CNAS-CL01 (identical to ISO/IEC 17025:2017)

Accredited by FCC

Designation Number: CN1204

Test Firm Registration Number: 882943

Accredited by A2LA

The Certificate Number is 4321.01

Accredited by Industry Canada

The Conformity Assessment Body Identifier is CN0008

Name of Firm

: EMTEK (SHENZHEN) CO., LTD.

Site Location

: Building 69, Majialong Industry Zone, Nanshan District, Shenzhen, Guangdong, China

6 TEST SYSTEM UNCERTAINTY

The following measurement uncertainty levels have been estimated for tests performed on the apparatus:

Parameter	Uncertainty
Radio Frequency	$\pm 1 \times 10^{-5}$
Maximum Peak Output Power Test	$\pm 1.0\text{dB}$
Conducted Emissions Test	$\pm 2.0\text{dB}$
Radiated Emission Test	$\pm 2.0\text{dB}$
Power Density	$\pm 2.0\text{dB}$
Occupied Bandwidth Test	$\pm 1.0\text{dB}$
Band Edge Test	$\pm 3\text{dB}$
All emission, radiated	$\pm 3\text{dB}$
Antenna Port Emission	$\pm 3\text{dB}$
Temperature	$\pm 0.5^\circ\text{C}$
Humidity	$\pm 3\%$

Measurement Uncertainty for a level of Confidence of 95%



7 SETUP OF EQUIPMENT UNDER TEST

7.1 RADIO FREQUENCY TEST SETUP

The WLAN component's antenna ports(s) of the EUT are connected to the measurement instrument per an appropriate attenuator. The EUT is controlled by PC/software to emit the specified signals for the purpose of measurements.

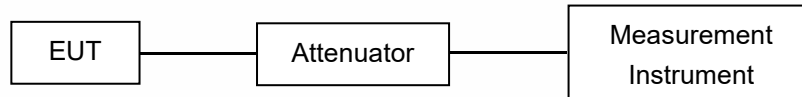

7.2 RADIO FREQUENCY TEST SETUP

The test site semi-anechoic chamber has met the requirement of NSA tolerance 4 dB according to the standards: ANSI C63.10. The test distance is 3m. The setup is according to the requirements in Section 13.1.4.1 of ANSI C63.10-2013 and CAN/CSA-CEI/IEC CISPR 22.

Below 30MHz:

The EUT is placed on a turntable 0.8 meters above the ground in the chamber, 3 meter away from the antenna (loop antenna). The Antenna should be positioned with its plane vertical at the specified distance from the EUT and rotated about its vertical axis for maximum response at each azimuth about the EUT. The center of the loop shall be 1 m above the ground. For certain applications, the loop antenna plane may also need to be positioned horizontally at the specified distance from the EUT.

Above 30MHz:

The EUT is placed on a turntable 0.8 meters above the ground in the chamber, 3 meter away from the antenna. The maximal emission value is acquired by adjusting the antenna height, polarisation and turntable azimuth. Normally, the height range of antenna is 1 m to 4 m, the azimuth range of turntable is 0° to 360°, and the receive antenna has two polarizations Vertical (V) and Horizontal (H).

Above 1GHz:

(Note: the FCC's permission to use 1.5m as an alternative per TCBC Conf call of Dec. 2, 2014.)

The EUT is placed on a turntable 1.5 meters above the ground in the chamber, 3 meter away from the antenna. The maximal emission value is acquired by adjusting the antenna height, polarisation and turntable azimuth. Normally, the height range of antenna is 1 m to 4 m, the azimuth range of turntable is 0° to 360°, and the receive antenna has two polarizations Vertical (V) and Horizontal (H).

(a) Radiated Emission Test Set-Up, Frequency Below 30MHz

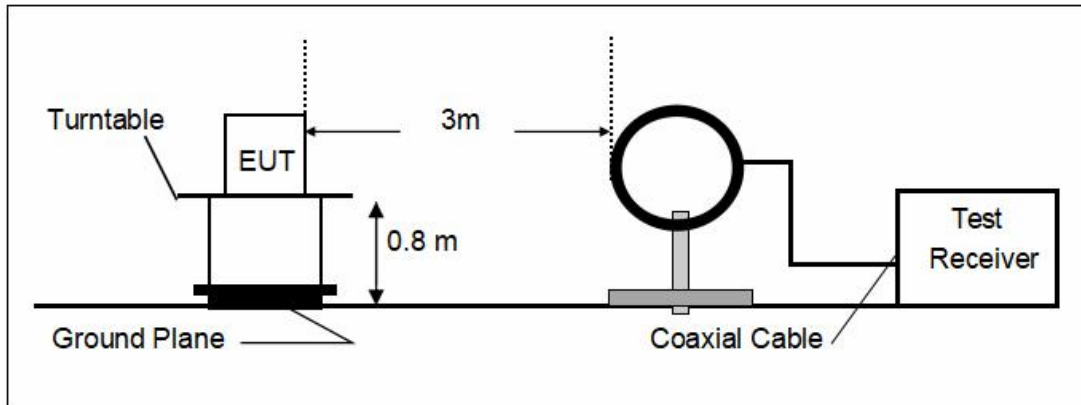

(b) Radiated Emission Test Set-Up, Frequency Below 1000MHz

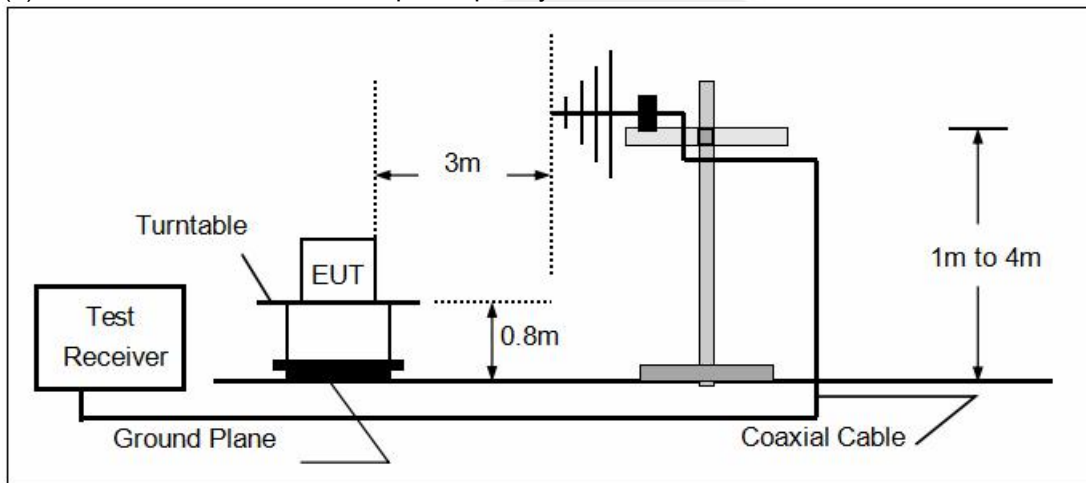

(c) Radiated Emission Test Set-Up, Frequency above 1000MHz

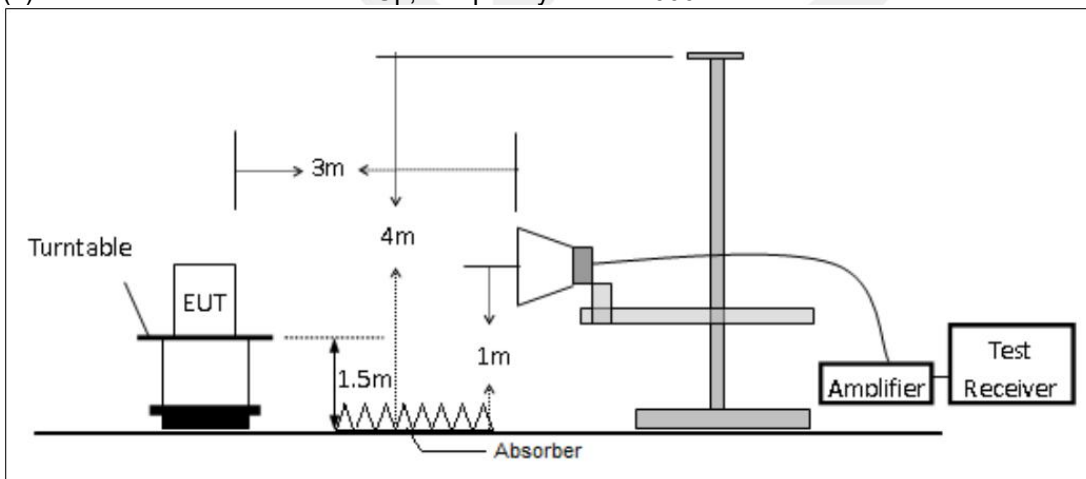

7.3 CONDUCTED EMISSION TEST SETUP

The mains cable of the EUT (maybe per AC/DC Adapter) must be connected to LISN. The LISN shall be placed 0.8 m from the boundary of EUT and bonded to a ground reference plane for LISN mounted on top of the ground reference plane. This distance is between the closest points of the LISN and the EUT. All other units of the EUT and associated equipment shall be at least 0.8m from the LISN. Ground connections, where required for safety purposes, shall be connected to the reference ground point of the LISN and, where not otherwise provided or specified by the manufacturer, shall be of same length as the mains cable and run parallel to the mains connection at a separation distance of not more than 0.1 m.

According to the requirements in Section 13.1.4.1 of ANSI C63.10-2013 Conducted emissions from the EUT measured in the frequency range between 0.15 MHz and 30 MHz using CISPR Quasi-Peak and average detector mode.

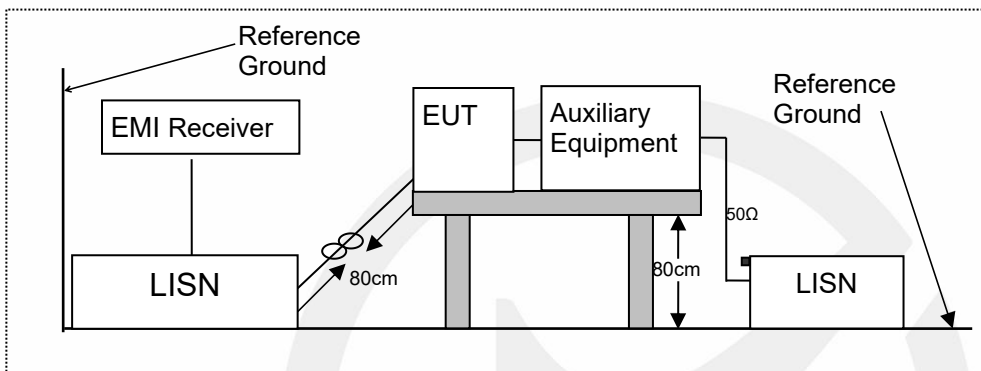

7.4 BLOCK DIAGRAM CONFIGURATION OF TEST SYSTEM

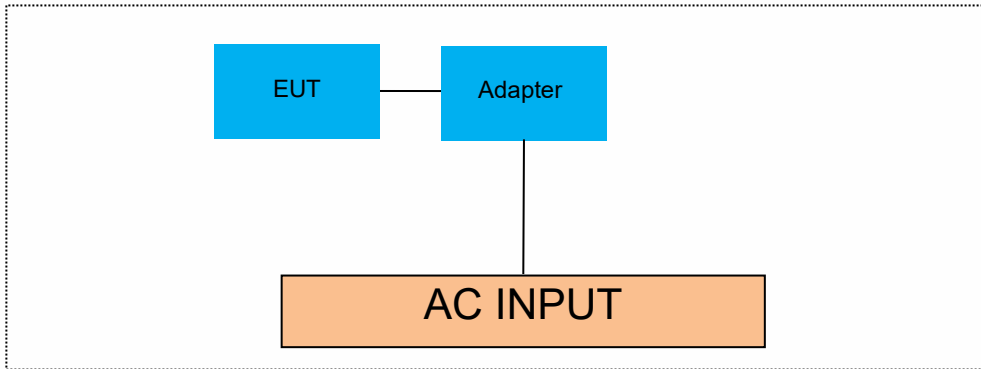

7.5 SUPPORT EQUIPMENT

Item	Equipment	Mfr/Brand	Model/Type No.	FCC ID	Series No.	Note

Notes:

- 1.All the equipment/cables were placed in the worst-case configuration to maximize the emission during the test.
- 2.Grounding was established in accordance with the manufacturer's requirements and conditions for the intended use.

8 TEST REQUIREMENTS

8.1 BANDWIDTH MEASUREMENT

8.1.1 Applicable Standard

According to FCC Part 15.407(a)(1) for UNII Band I
According to FCC Part 15.407(a)(2) for UNII Band II-A and UNII Band II-C
According to FCC Part 15.407(a)(3) for UNII Band III
According to FCC Part 15.407(e) for UNII Band III
According to 789033 D02 Section II(C)
According to 789033 D02 Section II(D)

8.1.2 Conformance Limit

(1) For the band 5.15-5.25 GHz.

(iv) For mobile and portable client devices in the 5.15-5.25 GHz band, the maximum conducted output power over the frequency band of operation shall not exceed 250 mW provided the maximum antenna gain does not exceed 6 dBi. In addition, the maximum power spectral density shall not exceed 11 dBm in any 1 megahertz band. If transmitting antennas of directional gain greater than 6 dBi are used, both the maximum conducted output power and the maximum power spectral density shall be reduced by the amount in dB that the directional gain of the antenna exceeds 6 dBi.

(2) For the 5.25-5.35 GHz and 5.47-5.725 GHz bands, the maximum conducted output power over the frequency bands of operation shall not exceed the lesser of 250 mW or $11 \text{ dBm} + 10 \log B$, where B is the 26 dB emission bandwidth in megahertz. In addition, the maximum power spectral density shall not exceed 11 dBm in any 1 megahertz band. If transmitting antennas of directional gain greater than 6 dBi are used, both the maximum conducted output power and the maximum power spectral density shall be reduced by the amount in dB that the directional gain of the antenna exceeds 6 dBi.

(3) For the band 5.725-5.85 GHz, the maximum conducted output power over the frequency band of operation shall not exceed 1 W. In addition, the maximum power spectral density shall not exceed 30 dBm in any 500-kHz band. If transmitting antennas of directional gain greater than 6 dBi are used, both the maximum conducted output power and the maximum power spectral density shall be reduced by the amount in dB that the directional gain of the antenna exceeds 6 dBi. However, fixed point-to-point U-NII devices operating in this band may employ transmitting antennas with directional gain greater than 6 dBi without any corresponding reduction in transmitter conducted power. Fixed, point-to-point operations exclude the use of point-to-multipoint systems, omnidirectional applications, and multiple collocated transmitters transmitting the same information. The operator of the U-NII device, or if the equipment is professionally installed, the installer, is responsible for ensuring that systems employing high gain directional antennas are used exclusively for fixed, point-to-point operations.

(e) Within the 5.725-5.85 GHz band, the minimum 6 dB bandwidth of U-NII devices shall be at least 500 kHz.

8.1.3 Test Configuration

Test according to clause 6.1 radio frequency test setup

8.1.4 Test Procedure

According to 789033 D02 v02r01 section C&D, the following is the measurement procedure.

1. Emission Bandwidth (EBW)

a) Set RBW = approximately 1% of the emission bandwidth.

b) Set the VBW > RBW.

c) Detector = Peak.

d) Trace mode = max hold.

e) Measure the maximum width of the emission that is 26 dB down from the maximum of the emission. Compare this with the RBW setting of the analyzer. Readjust RBW and repeat measurement as needed until the RBW/EBW ratio is approximately 1%.

2. Minimum Emission Bandwidth for the band 5.725-5.85 GHz

Section 15.407(e) specifies the minimum 6 dB emission bandwidth of at least 500 KHz for the band 5.715-5.85 GHz. The following procedure shall be used for measuring this bandwidth:

- a) Set RBW = 100 kHz.
- b) Set the video bandwidth (VBW) $\geq 3 \times$ RBW.
- c) Detector = Peak.
- d) Trace mode = max hold.
- e) Sweep = auto couple.
- f) Allow the trace to stabilize.
- g) Measure the maximum width of the emission that is constrained by the frequencies associated with the two outermost amplitude points (upper and lower frequencies) that are attenuated by 6 dB relative to the maximum level measured in the fundamental emission.

Note: The automatic bandwidth measurement capability of a spectrum analyzer or EMI receiver may be employed if it implements the functionality described above.

D. 99 Percent Occupied Bandwidth

The 99-percent occupied bandwidth is the frequency bandwidth such that, below its lower and above its upper frequency limits, the mean powers are each equal to 0.5 % of the total mean power of the given emission. Measurement of the 99-percent occupied bandwidth is required only as a condition for using the optional band-edge measurement techniques described in section II.G.3.d). Measurements of 99-percent occupied bandwidth may also optionally be used in lieu of the EBW to 789033 D02 v01r02 General UNII Test Procedures New Rules v01 define the minimum frequency range over which the spectrum is integrated when measuring maximum conducted output power as described in section II.E. However, the EBW must be measured to determine bandwidth dependent limits on maximum conducted output power in accordance with 15.407(a).

The following procedure shall be used for measuring (99 %) power bandwidth:

1. Set center frequency to the nominal EUT channel center frequency.
2. Set span = 1.5 times to 5.0 times the OBW.
3. Set RBW = 1 % to 5 % of the OBW
4. Set VBW $\geq 3 \cdot$ RBW
5. Video averaging is not permitted. Where practical, a sample detection and single sweep mode shall be used. Otherwise, peak detection and max hold mode (until the trace stabilizes) shall be used.
6. Use the 99 % power bandwidth function of the instrument (if available).
7. If the instrument does not have a 99 % power bandwidth function, the trace data points are recovered and directly summed in power units. The recovered amplitude data points, beginning at the lowest frequency, are placed in a running sum until 0.5 % of the total is reached; that frequency is recorded as the lower frequency. The process is repeated until 99.5 % of the total is reached; that frequency is recorded as the upper frequency. The 99% occupied bandwidth is the difference between these two frequencies.

8.1.5 Test Results

5150-5250MHz

Antenna 1

Test Mode	Test Channel MHz		26 dB Bandwidth MHz	99% Bandwidth MHz	Verdict
802.11a	CH36	5180	23.50	16.90	Pass
	CH40	5200	23.27	16.90	Pass
	CH48	5240	23.50	16.90	Pass
802.11n-HT20	CH36	5180	23.85	17.95	Pass
	CH40	5200	23.73	17.95	Pass
	CH48	5240	24.14	17.95	Pass
802.11ac(HT20)	CH36	5180	23.73	17.95	Pass
	CH40	5200	23.44	17.95	Pass
	CH48	5240	23.44	17.95	Pass
802.11n-HT40	CH38	5190	42.72	36.12	Pass
	CH46	5230	43.42	36.24	Pass
802.11ac(HT40)	CH38	5190	43.18	36.12	Pass
	CH46	5230	43.76	36.24	Pass
802.11ac(HT80)	CH42	5210	85.67	75.02	Pass
802.11ac(HT160)	CH50	5250	166.61	153.75	Pass

Antenna 2

Test Mode	Test Channel MHz		26 dB Bandwidth MHz	99% Bandwidth MHz	Verdict
802.11a	CH36	5180	22.92	16.96	Pass
	CH40	5200	22.69	16.96	Pass
	CH48	5240	23.50	16.96	Pass
802.11n-HT20	CH36	5180	23.97	17.95	Pass
	CH40	5200	23.79	17.95	Pass
	CH48	5240	24.14	17.95	Pass
802.11ac(HT20)	CH36	5180	23.39	17.95	Pass
	CH40	5200	23.79	17.95	Pass
	CH48	5240	23.56	17.95	Pass
802.11n-HT40	CH38	5190	42.60	36.12	Pass
	CH46	5230	43.99	36.24	Pass
802.11ac(HT40)	CH38	5190	43.30	36.12	Pass
	CH46	5230	43.42	36.24	Pass
802.11ac(HT80)	CH42	5210	86.83	75.02	Pass
802.11ac(HT160)	CH50	5250	167.18	153.75	Pass

A. 5150-5250MHz Antenna 1

26dB Emission Bandwidth
Test Model 802.11a

U-NII - 1
Frequency(MHz)

5180

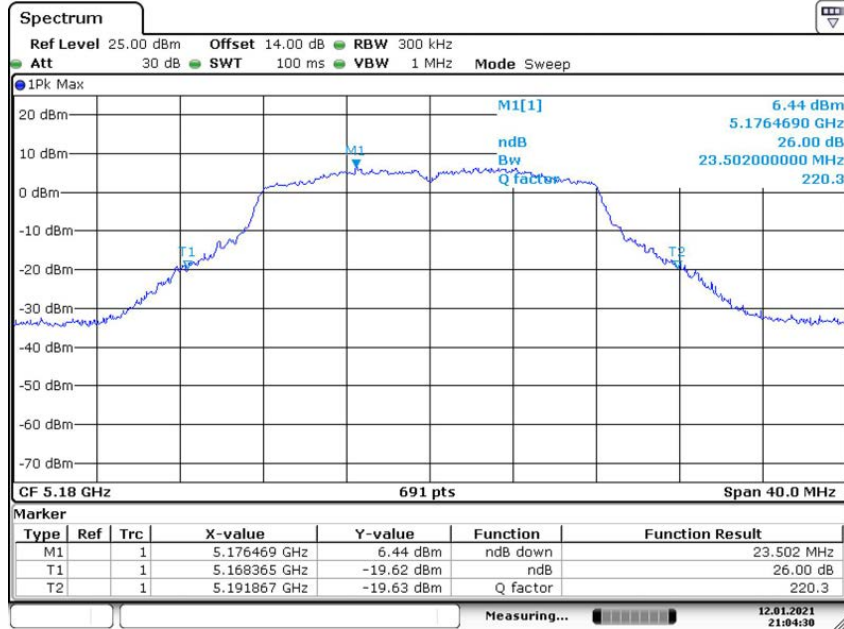

Date: 12.JAN.2021 21:04:30

26dB Emission Bandwidth
Test Model 802.11a

U-NII - 1
Frequency(MHz)

5200

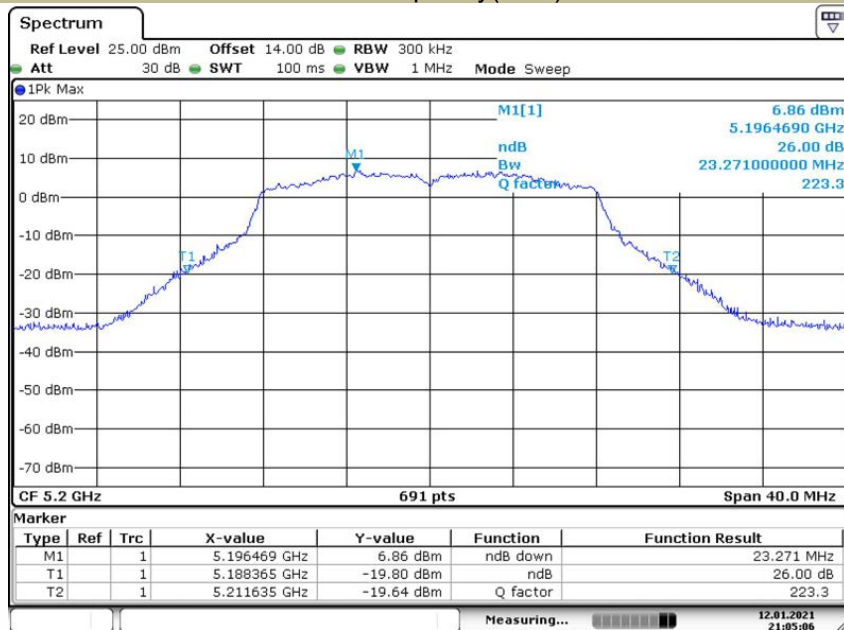

Date: 12.JAN.2021 21:05:06

26dB Emission Bandwidth U-NII - 1
 Test Model 802.11a Frequency(MHz) 5240

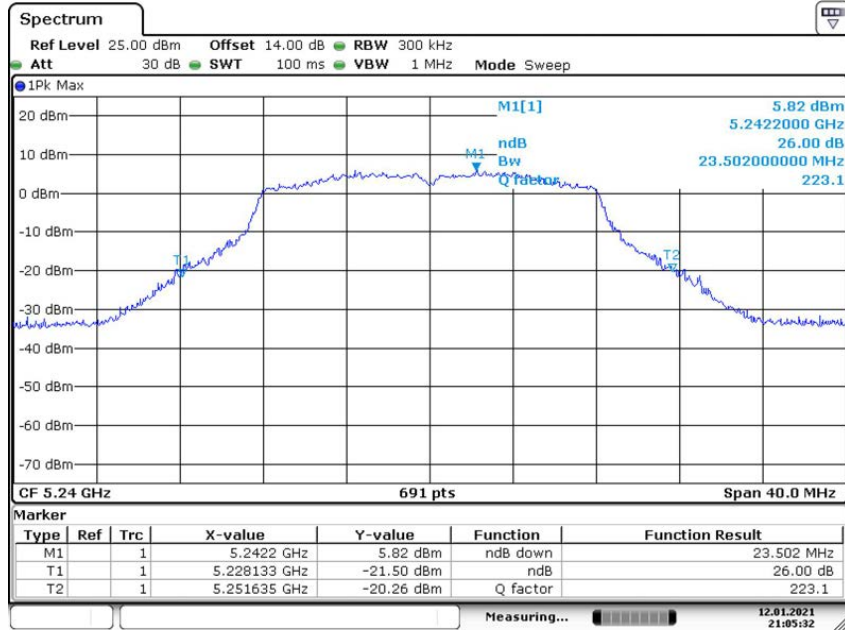

Date: 12.JAN.2021 21:05:32

26dB Emission Bandwidth U-NII - 1
 Test Model 802.11n-HT20 Frequency(MHz) 5180

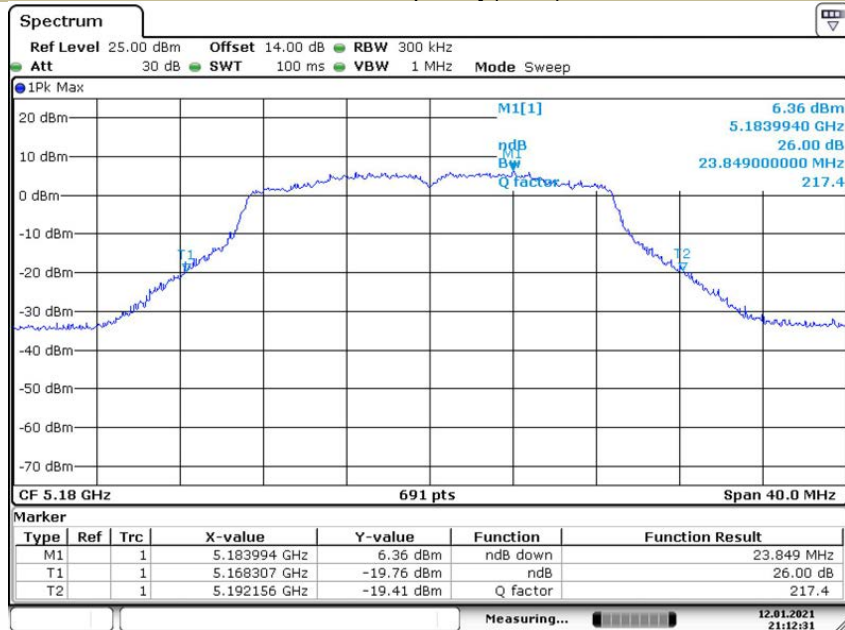

Date: 12.JAN.2021 21:12:32

26dB Emission Bandwidth U-NII - 1
 Test Model 802.11n-HT20 Frequency(MHz) 5200

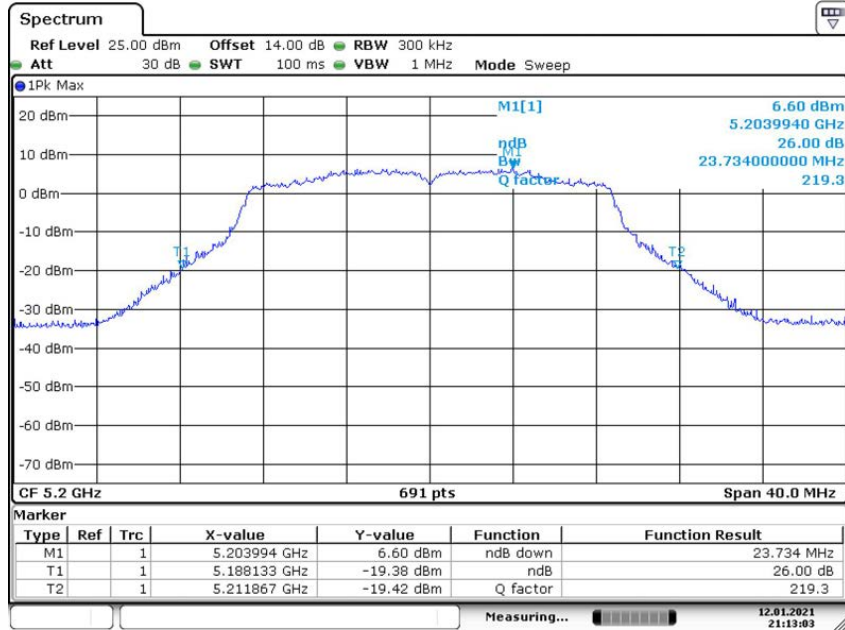

Date: 12.JAN.2021 21:13:04

26dB Emission Bandwidth U-NII - 1
 Test Model 802.11n-HT20 Frequency(MHz) 5240

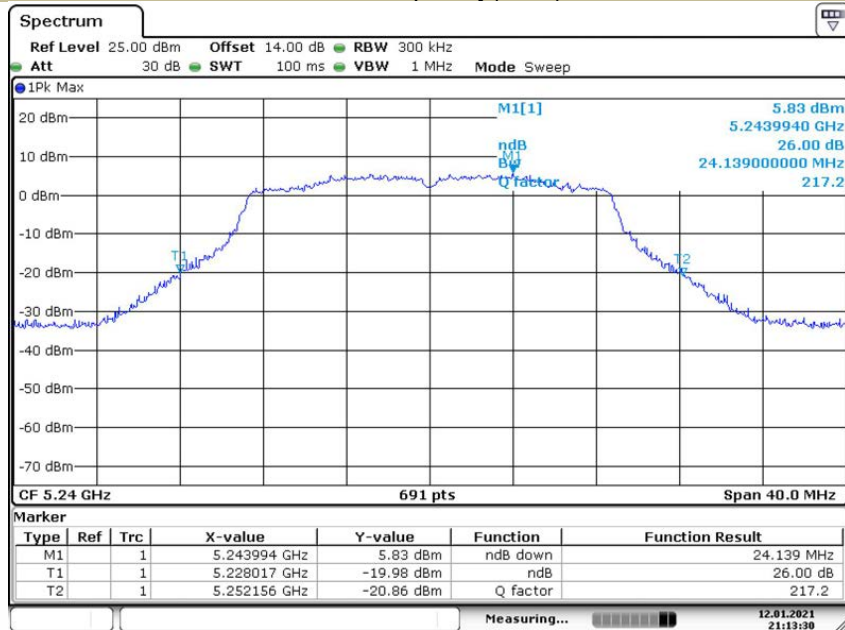

Date: 12.JAN.2021 21:13:30

26dB Emission Bandwidth U-NII - 1
 Test Model 802.11ac(HT20) Frequency(MHz) 5180

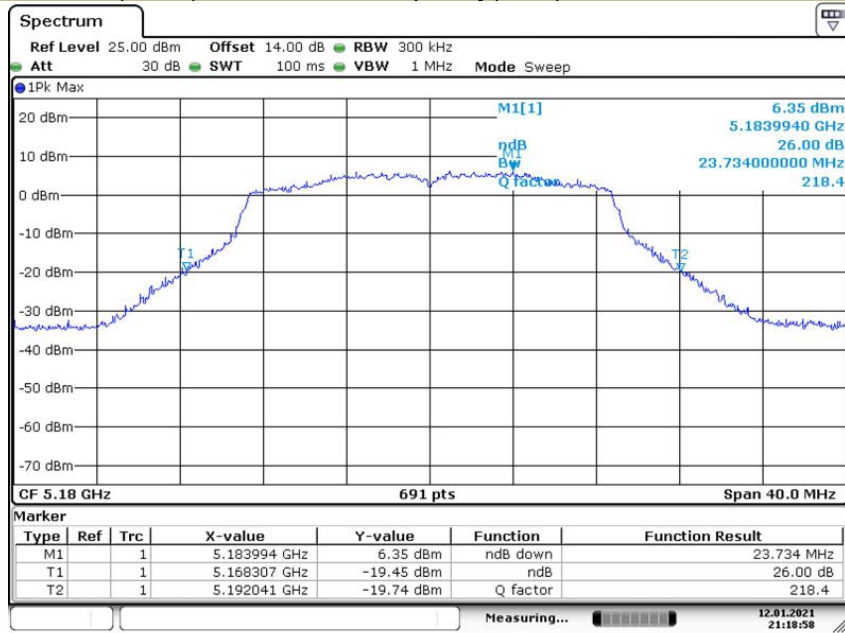

Date: 12.JAN.2021 21:18:59

26dB Emission Bandwidth U-NII - 1
 Test Model 802.11ac(HT20) Frequency(MHz) 5200

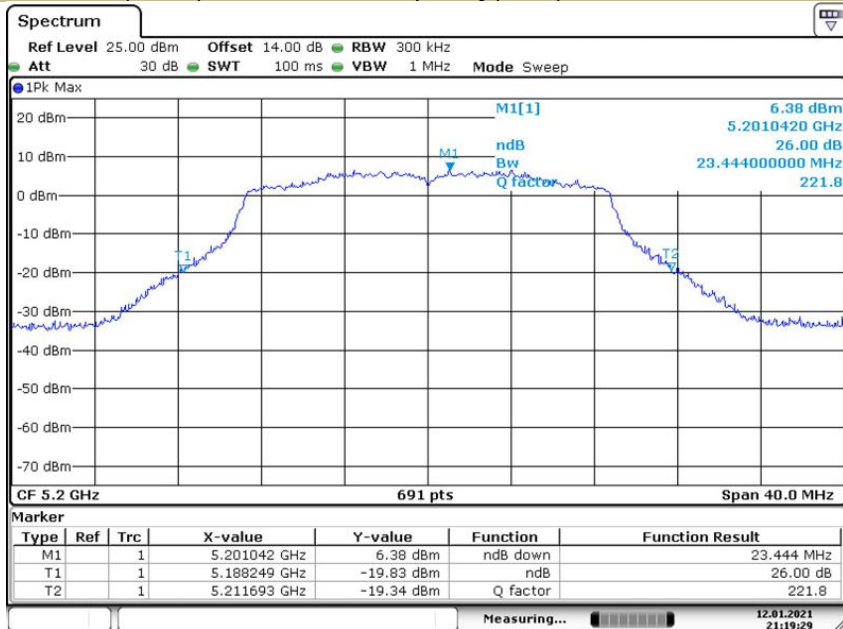

Date: 12.JAN.2021 21:19:29

26dB Emission Bandwidth U-NII - 1
 Test Model 802.11ac(HT20) Frequency(MHz) 5240

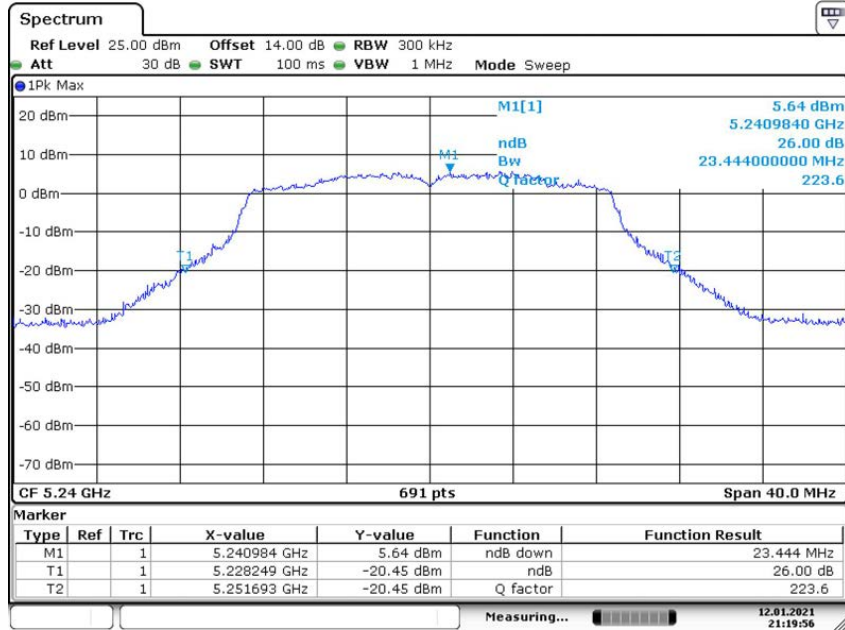

Date: 12.JAN.2021 21:19:57

26dB Emission Bandwidth U-NII - 1
 Test Model 802.11n-HT40 Frequency(MHz) 5190

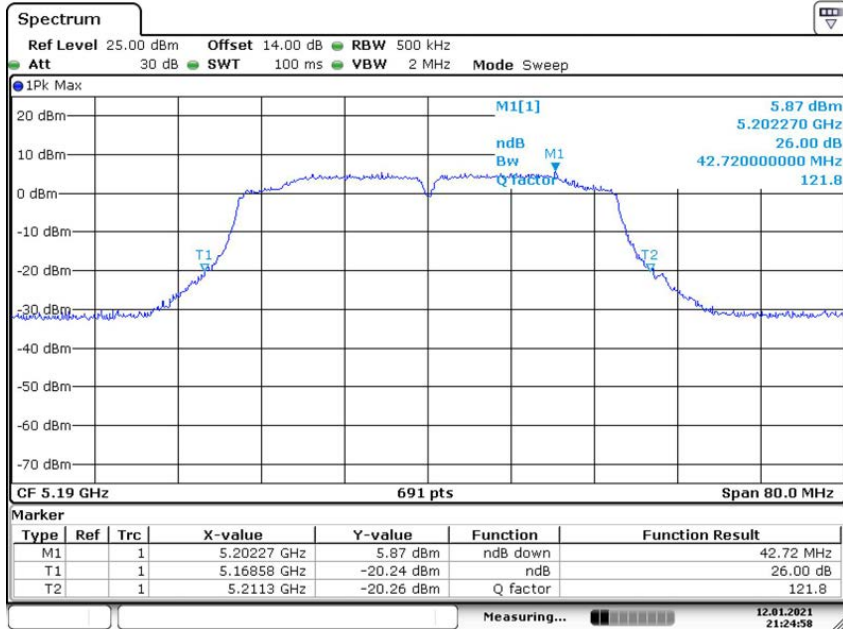

Date: 12.JAN.2021 21:24:58

26dB Emission Bandwidth U-NII - 1
 Test Model 802.11n-HT40 Frequency(MHz) 5230

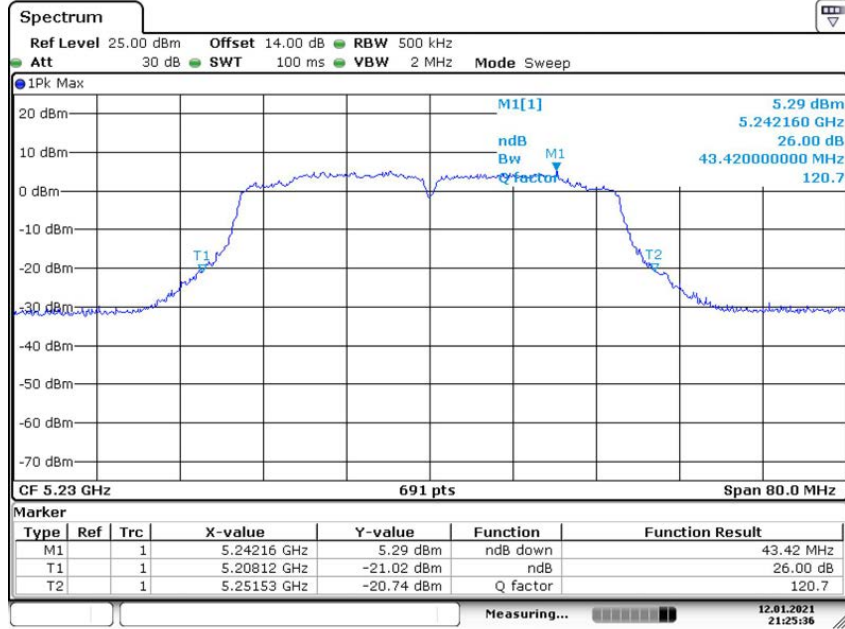

Date: 12.JAN.2021 21:25:36

26dB Emission Bandwidth U-NII - 1
 Test Model 802.11ac(HT40) Frequency(MHz) 5190

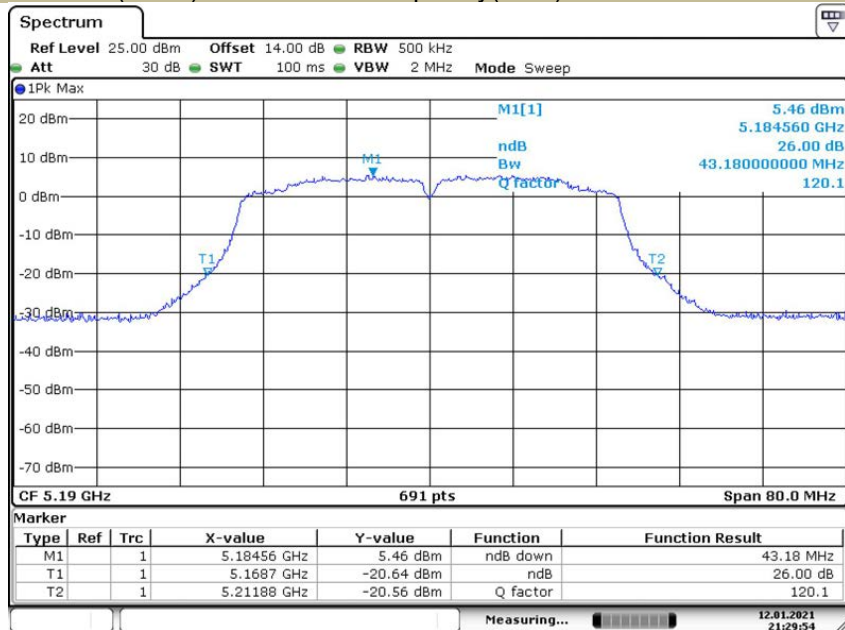

Date: 12.JAN.2021 21:29:54

26dB Emission Bandwidth U-NII - 1
 Test Model 802.11ac(HT40) Frequency(MHz) 5230

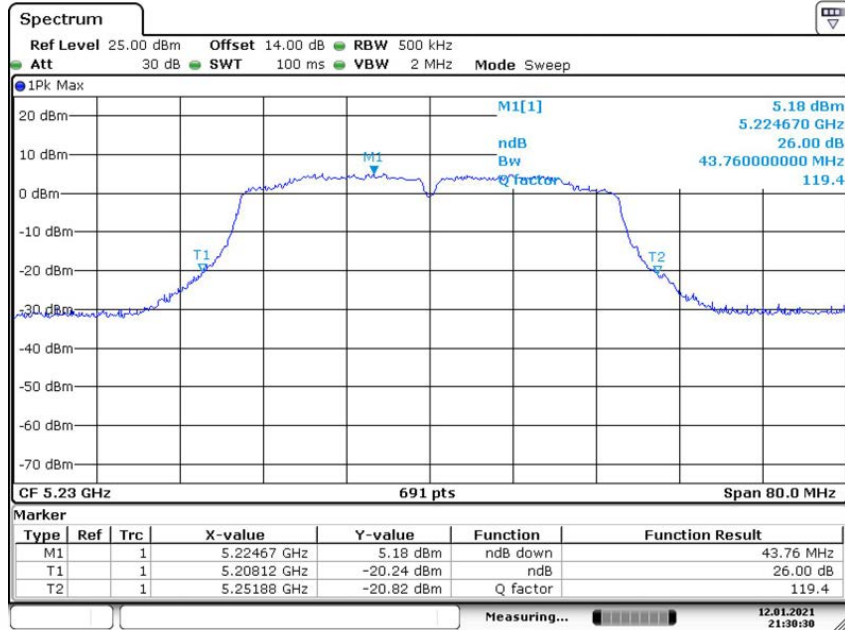

Date: 12.JAN.2021 21:30:30

26dB Emission Bandwidth U-NII - 1
 Test Model 802.11ac 80 Frequency(MHz) 5210

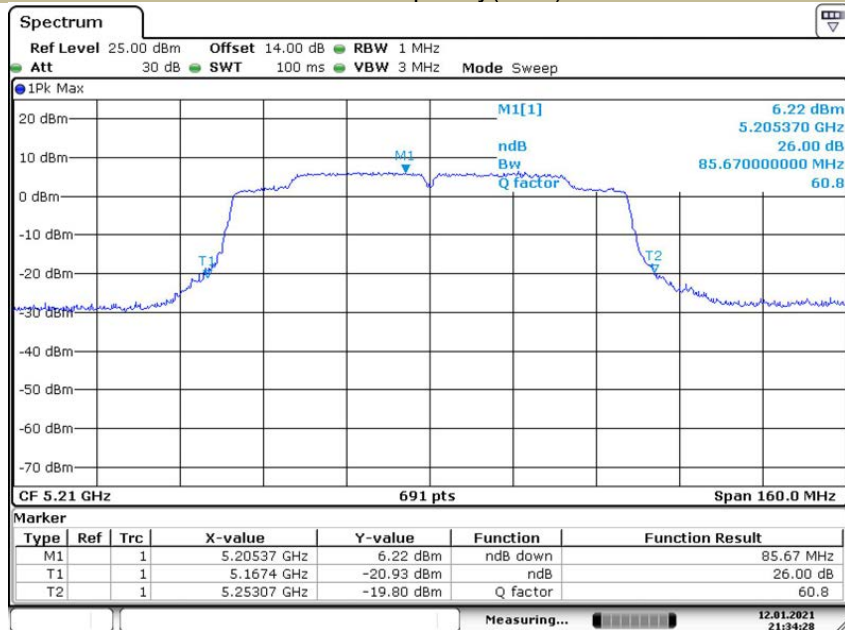

Date: 12.JAN.2021 21:34:28

26dB Emission Bandwidth U-NII - 1
 Test Model 802.11ac 160 Frequency(MHz) 5250

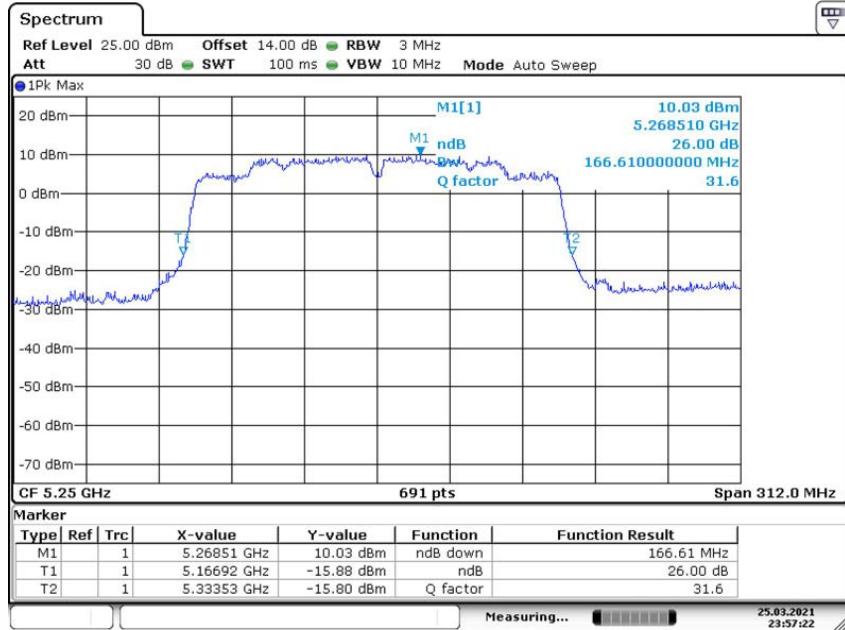

Date: 25.MAR.2021 23:57:22



Emission Bandwidth&99% Occupied Bandwidth U-NII - 1
 Test Model 802.11a Frequency(MHz) 5180

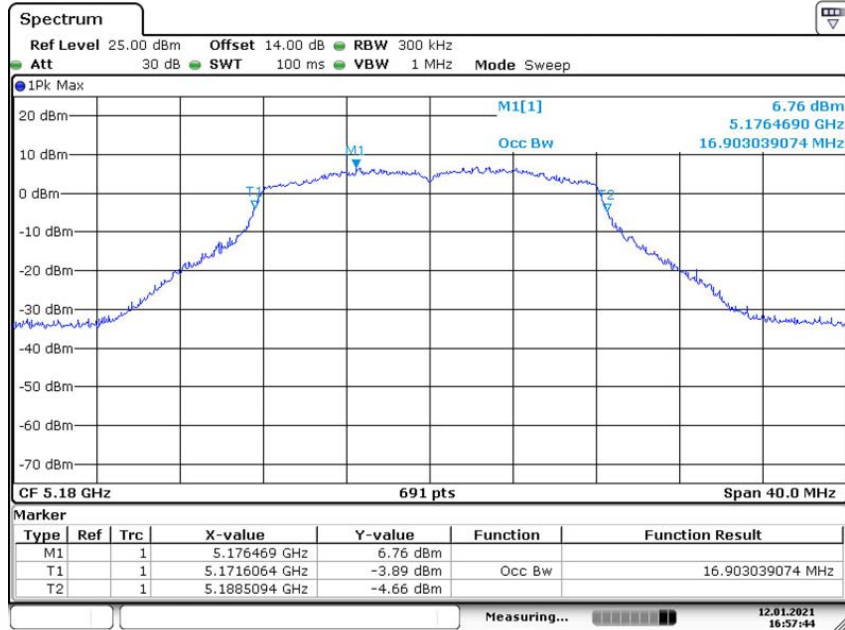

Date: 12.JAN.2021 16:57:45

Emission Bandwidth&99% Occupied Bandwidth U-NII - 1
 Test Model 802.11a Frequency(MHz) 5200

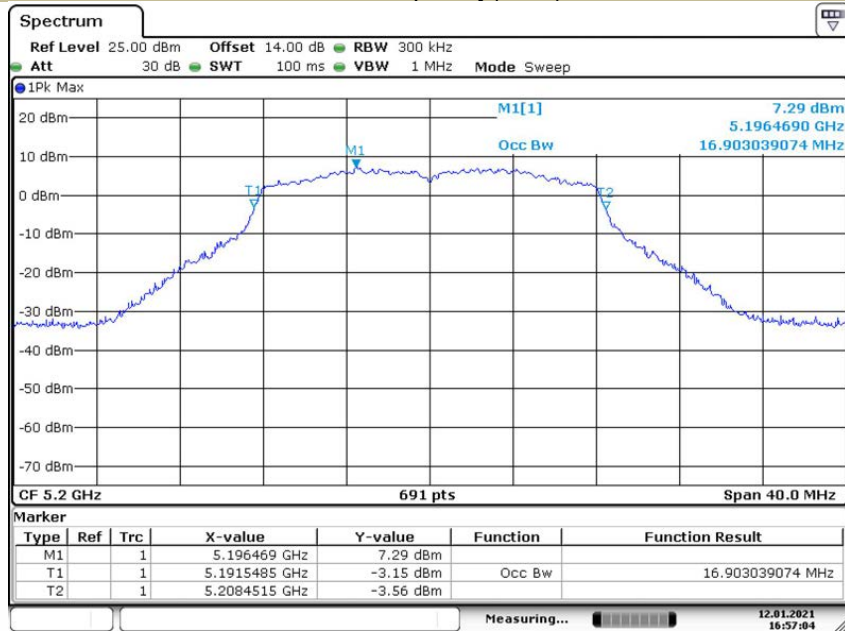

Date: 12.JAN.2021 16:57:04

Emission Bandwidth&99% Occupied Bandwidth U-NII - 1
 Test Model 802.11a Frequency(MHz) 5240

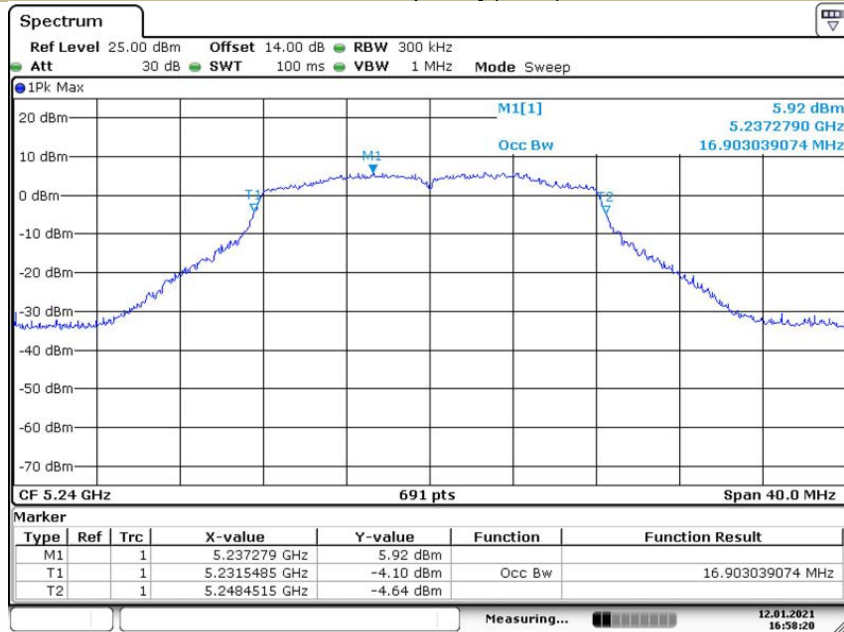

Date: 12.JAN.2021 16:58:20

Emission Bandwidth&99% Occupied Bandwidth U-NII - 1
 Test Model 802.11n-HT20 Frequency(MHz) 5180



Date: 12.JAN.2021 17:09:14

Emission Bandwidth&99% Occupied Bandwidth U-NII - 1
 Test Model 802.11n-HT20 Frequency(MHz) 5200

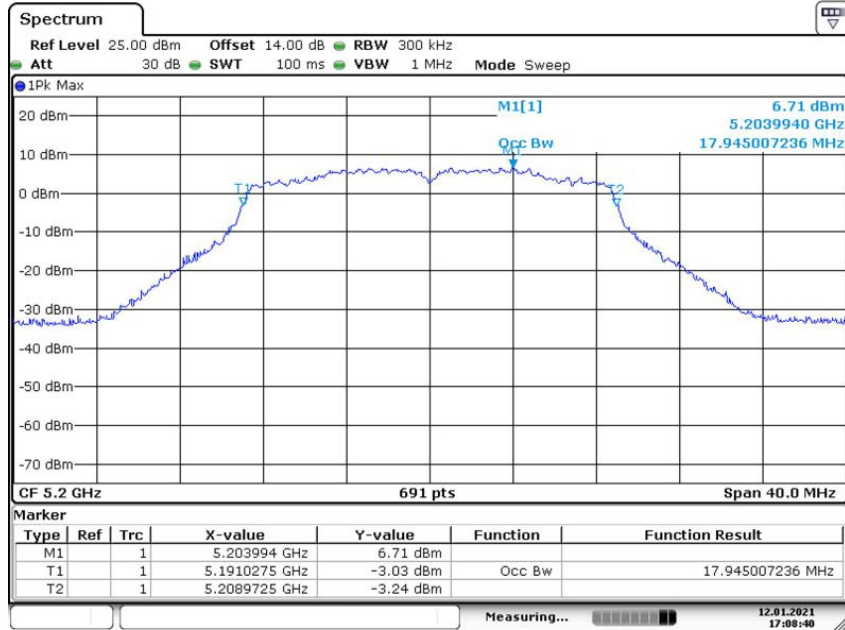

Date: 12.JAN.2021 17:08:39

Emission Bandwidth&99% Occupied Bandwidth U-NII - 1
 Test Model 802.11n-HT20 Frequency(MHz) 5240

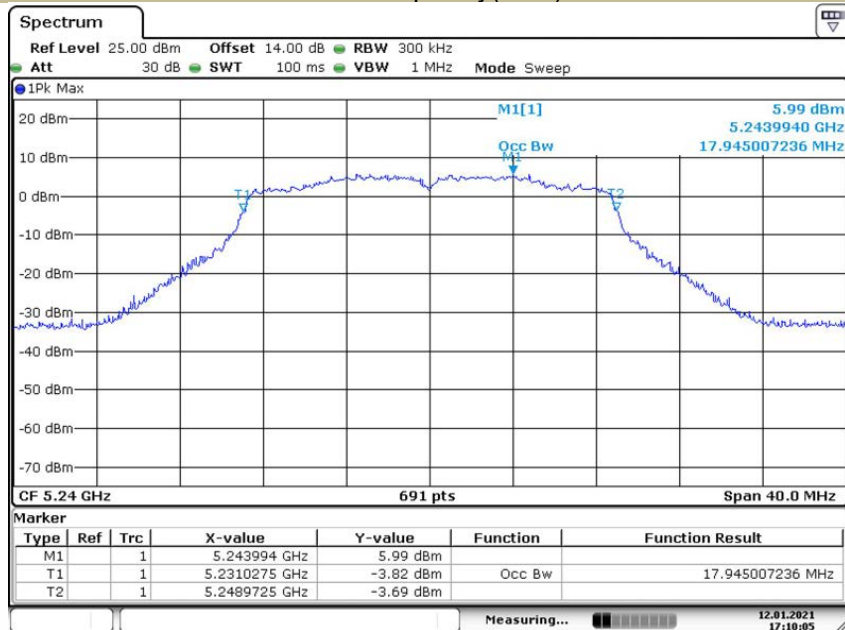

Date: 12.JAN.2021 17:10:04

Emission Bandwidth&99% Occupied Bandwidth U-NII - 1
 Test Model 802.11ac(HT20) Frequency(MHz) 5180

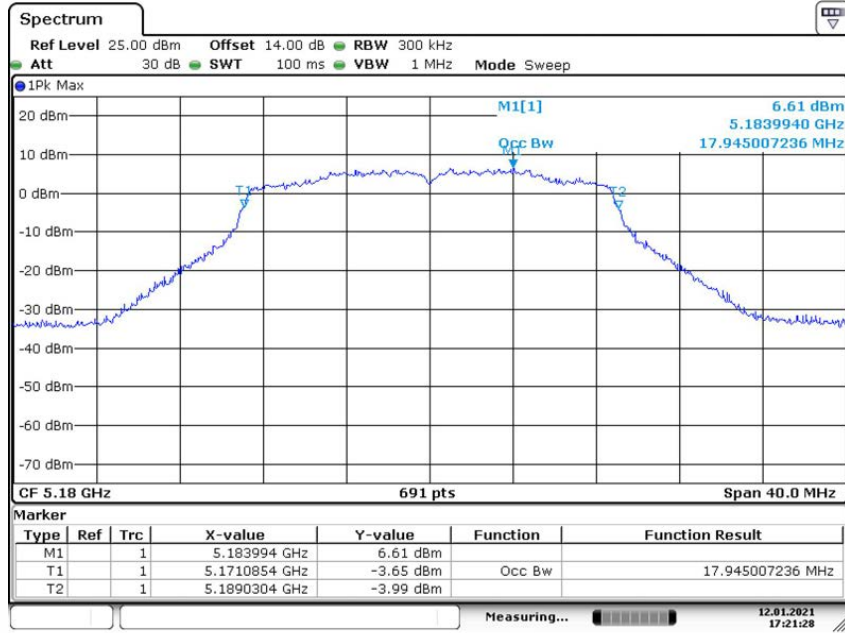

Date: 12.JAN.2021 17:21:29

Emission Bandwidth&99% Occupied Bandwidth U-NII - 1
 Test Model 802.11ac(HT20) Frequency(MHz) 5200

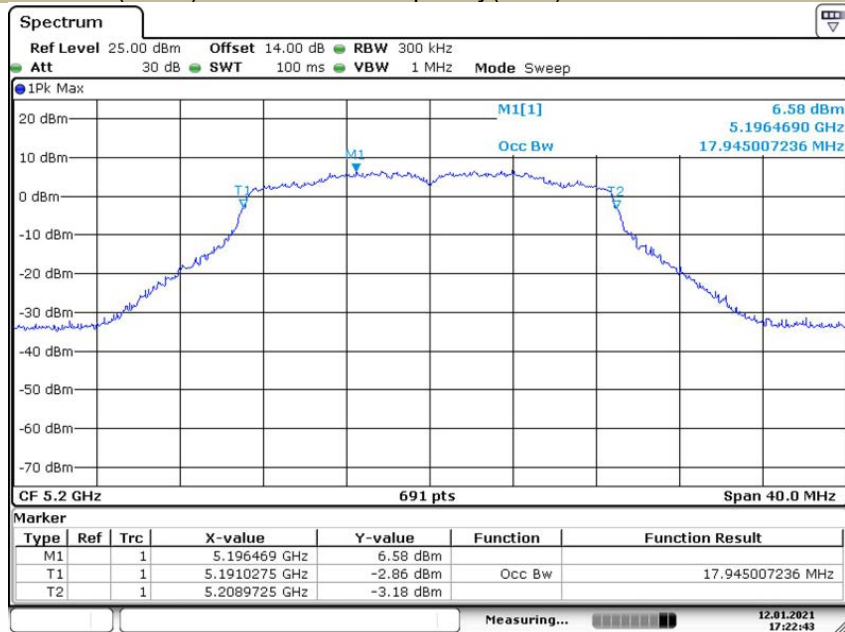

Date: 12.JAN.2021 17:22:43

Emission Bandwidth&99% Occupied Bandwidth U-NII - 1
 Test Model 802.11ac(HT20) Frequency(MHz) 5240

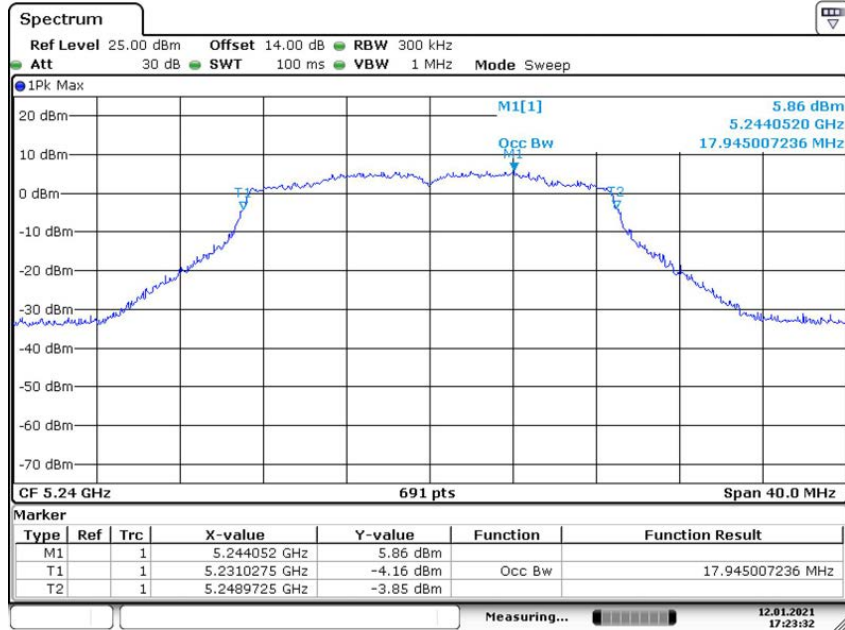

Date: 12.JAN.2021 17:23:32

Emission Bandwidth&99% Occupied Bandwidth U-NII - 1
 Test Model 802.11n-HT40 Frequency(MHz) 5190

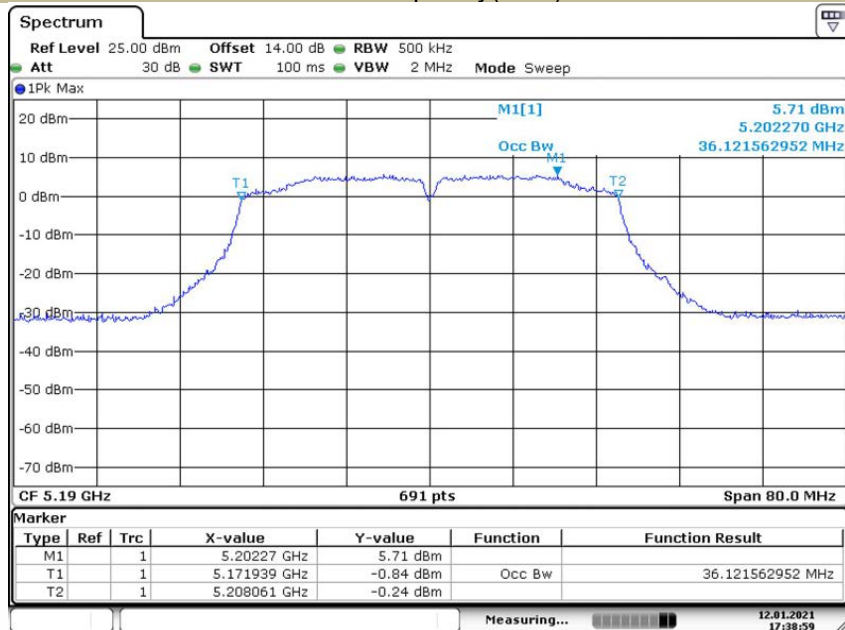

Date: 12.JAN.2021 17:38:58

Emission Bandwidth&99% Occupied Bandwidth U-NII - 1
Test Model 802.11n-HT40 Frequency(MHz) 5230

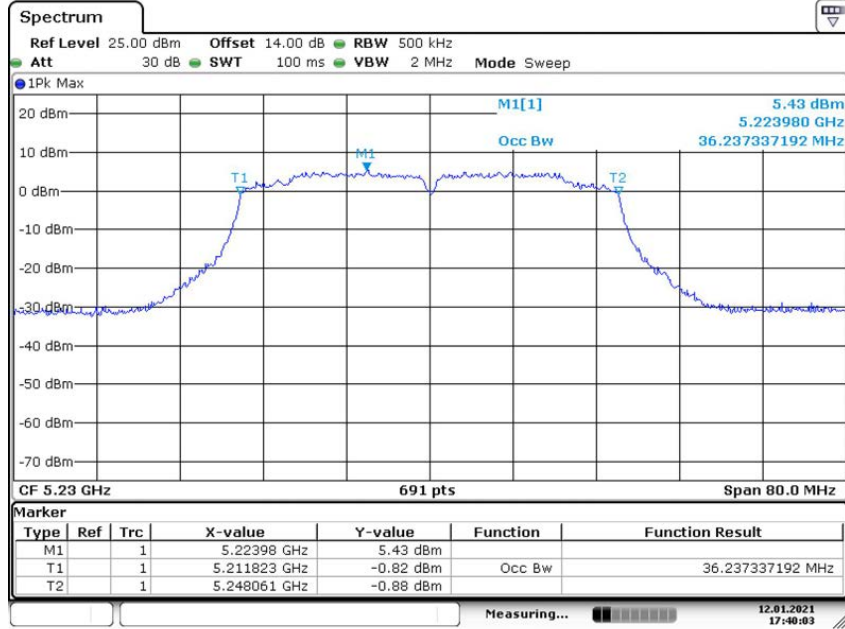

Date: 12.JAN.2021 17:40:03

Emission Bandwidth&99% Occupied Bandwidth U-NII - 1
Test Model 802.11ac(HT40) Frequency(MHz) 5190

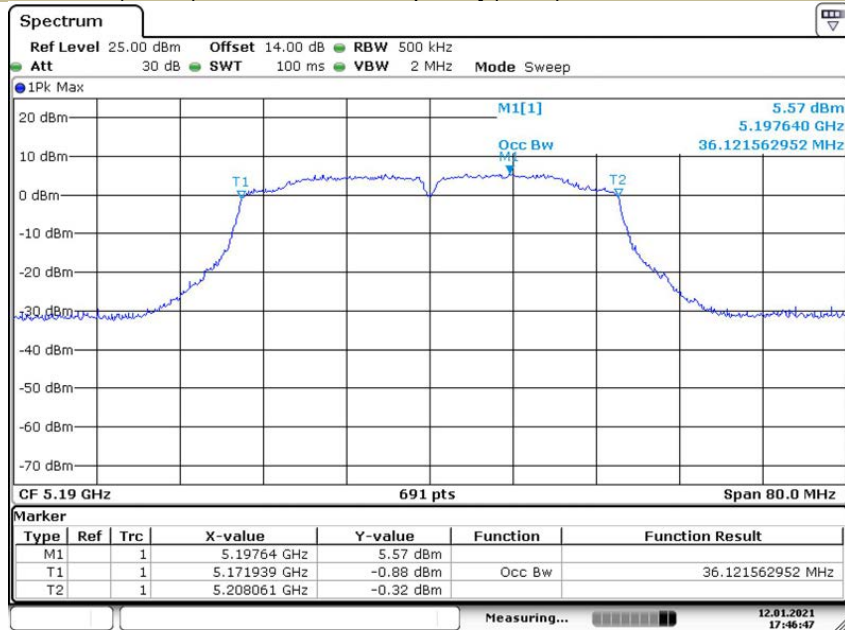

Date: 12.JAN.2021 17:46:48

Emission Bandwidth&99% Occupied Bandwidth U-NII - 1
 Test Model 802.11ac(HT40) Frequency(MHz) 5230

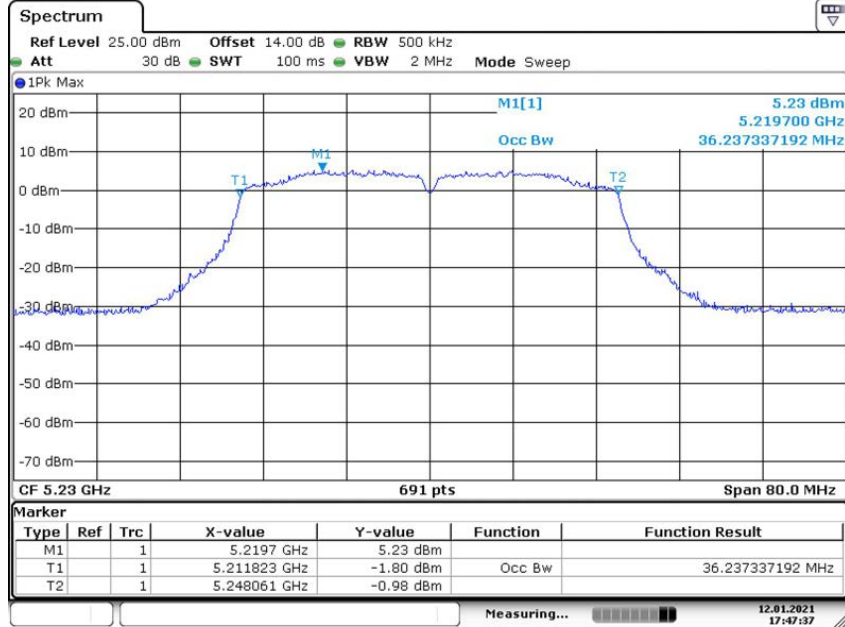

Date: 12.JAN.2021 17:47:37

Emission Bandwidth&99% Occupied Bandwidth U-NII - 1
 Test Model 802.11ac 80 Frequency(MHz) 5210

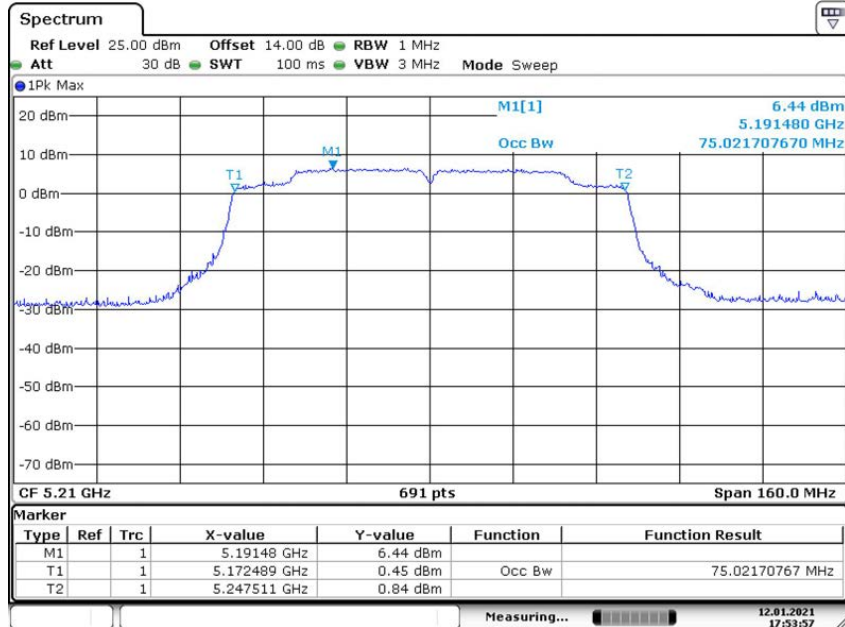

Date: 12.JAN.2021 17:53:57

Emission Bandwidth & 99% Occupied Bandwidth U-NII - 1
 Test Model 802.11ac 160 Frequency(MHz) 5250

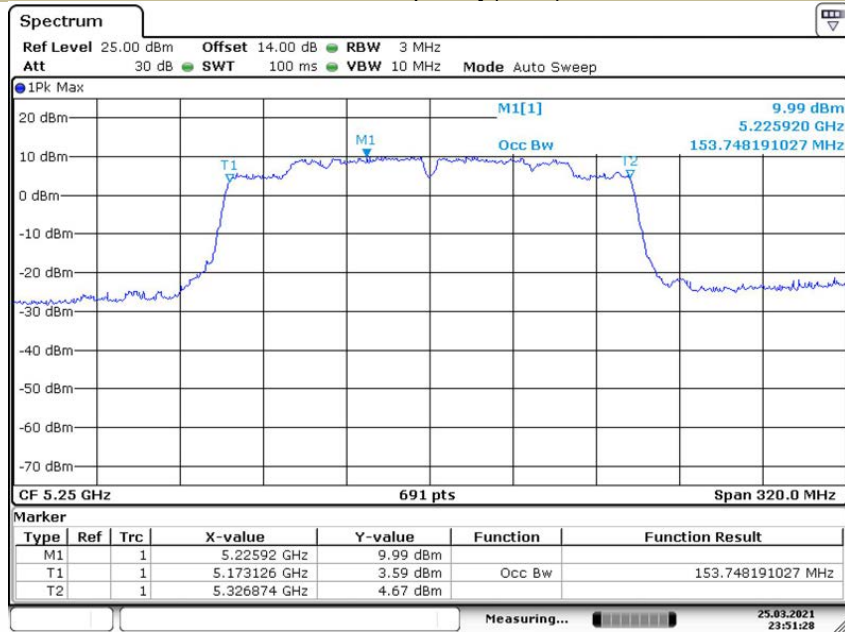

Date: 25.MAR.2021 23:51:28



B. 5150-5250MHz Antenna 2

26dB Emission Bandwidth

U-NII - 1

Test Model 802.11a

Frequency(MHz)

5180

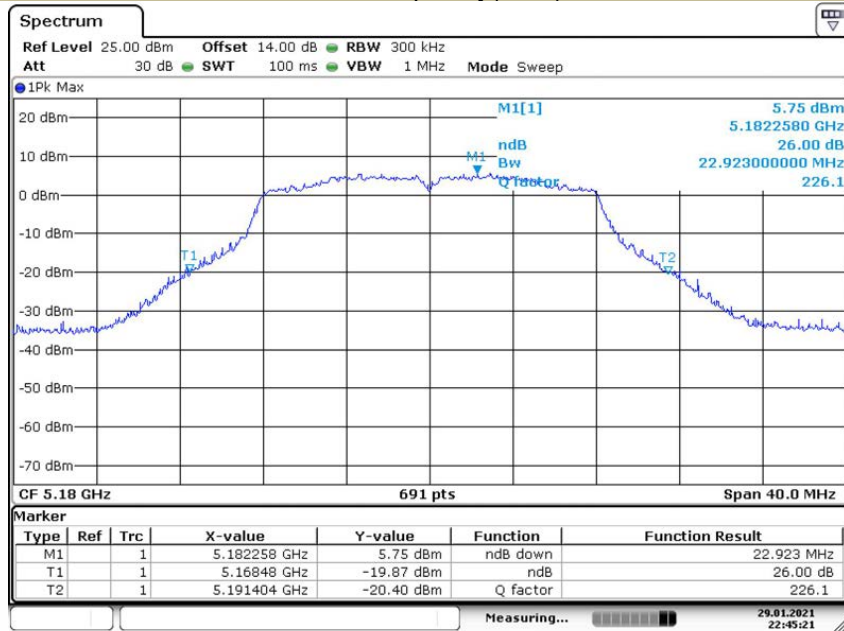

Date: 29.JAN.2021 22:45:21

26dB Emission Bandwidth

U-NII - 1

Test Model 802.11a

Frequency(MHz)

5200

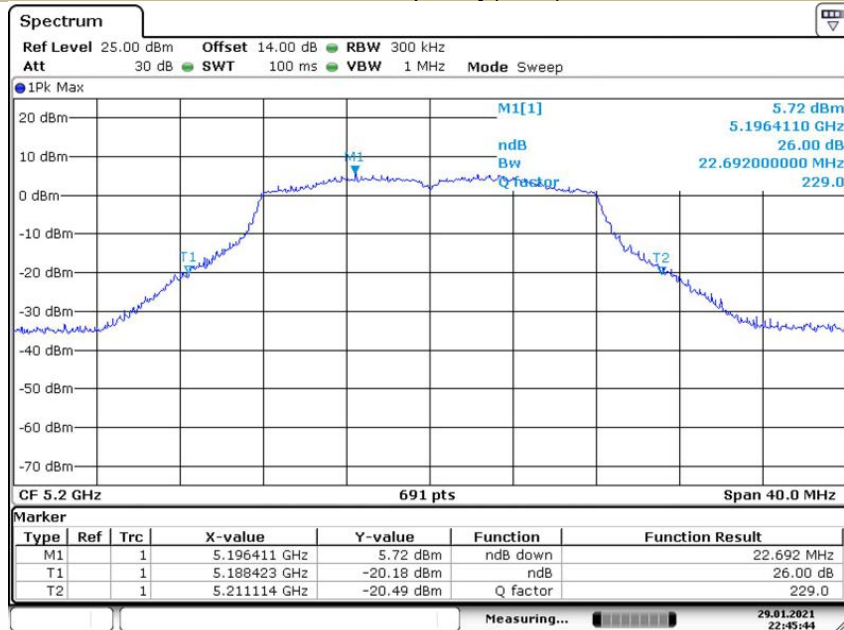

Date: 29.JAN.2021 22:45:45

26dB Emission Bandwidth U-NII - 1
 Test Model 802.11a Frequency(MHz) 5240

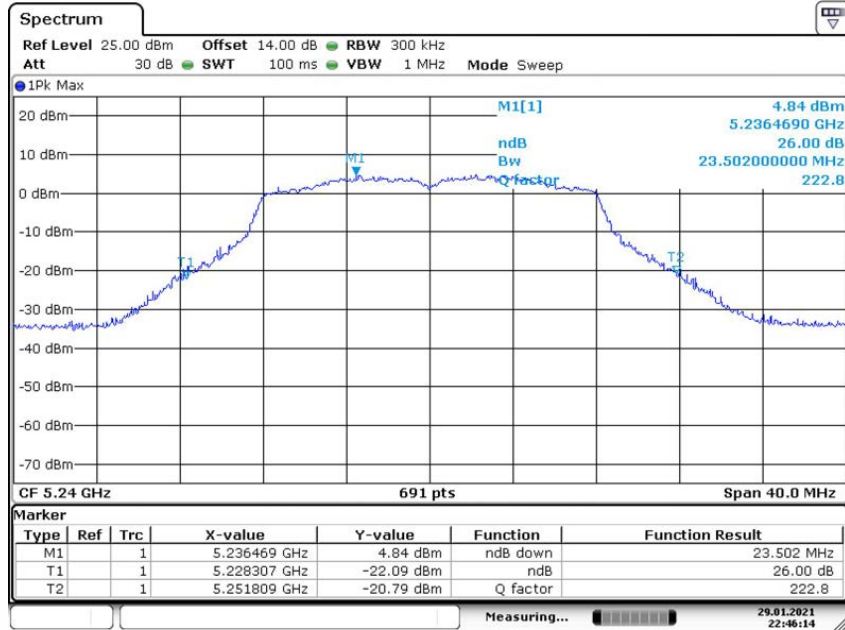

Date: 29.JAN.2021 22:46:13

26dB Emission Bandwidth U-NII - 1
 Test Model 802.11n-HT20 Frequency(MHz) 5180

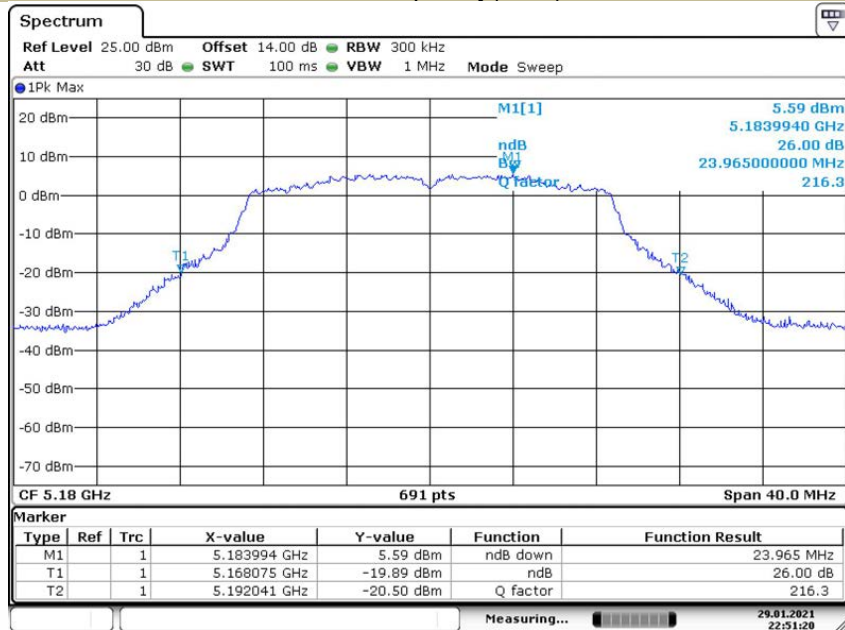

Date: 29.JAN.2021 22:51:21

26dB Emission Bandwidth U-NII - 1
 Test Model 802.11n-HT20 Frequency(MHz) 5200

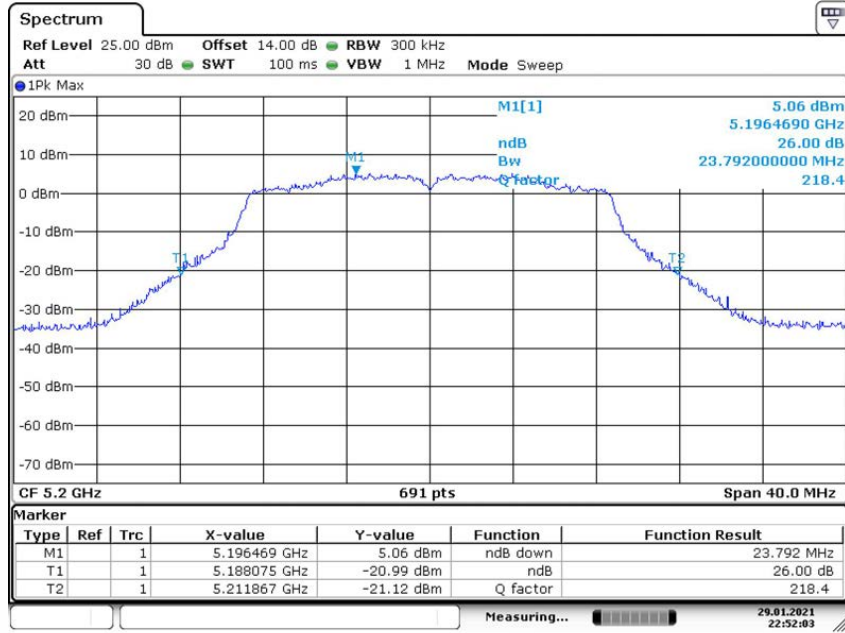

Date: 29.JAN.2021 22:52:03

26dB Emission Bandwidth U-NII - 1
 Test Model 802.11n-HT20 Frequency(MHz) 5240

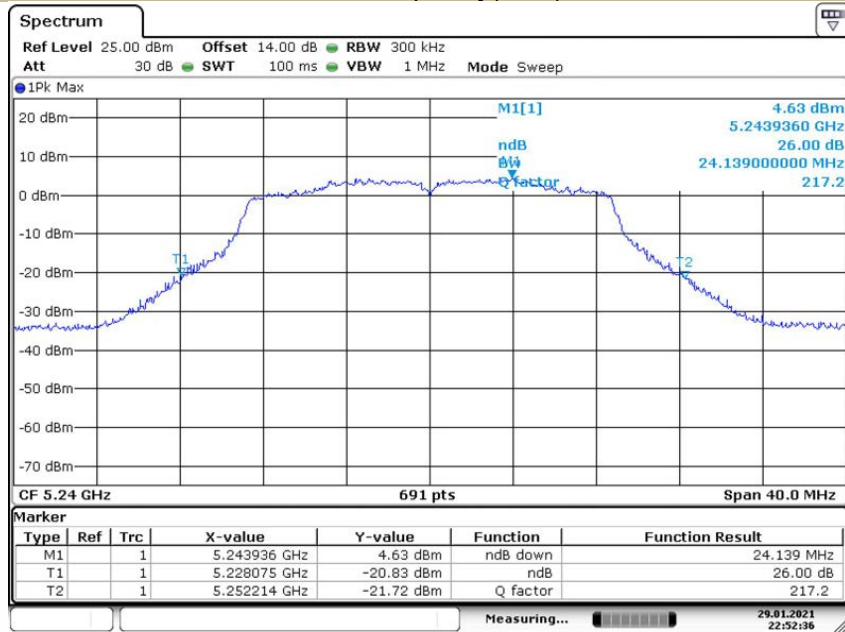

Date: 29.JAN.2021 22:52:36

26dB Emission Bandwidth U-NII - 1
 Test Model 802.11ac(HT20) Frequency(MHz) 5180

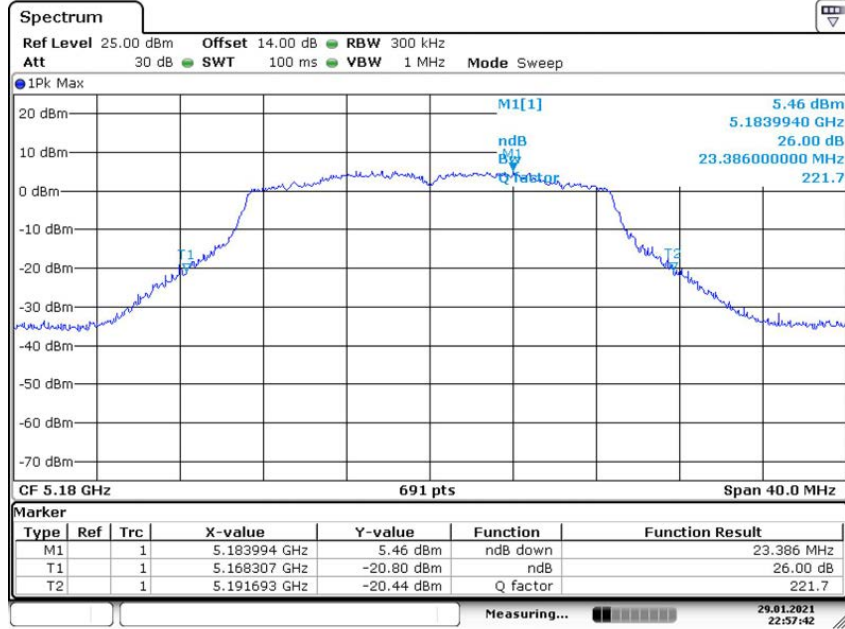

Date: 29.JAN.2021 22:57:42

26dB Emission Bandwidth U-NII - 1
 Test Model 802.11ac(HT20) Frequency(MHz) 5200

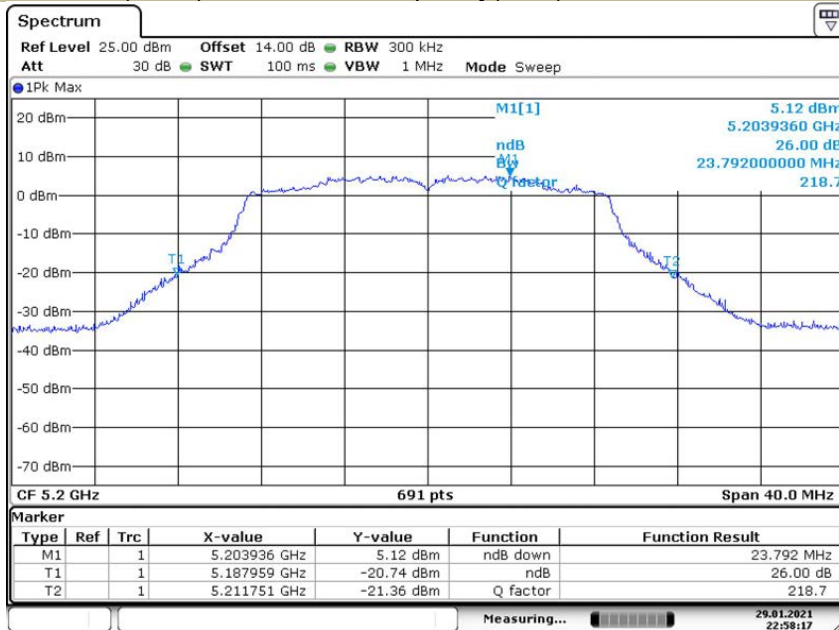

Date: 29.JAN.2021 22:58:17

26dB Emission Bandwidth U-NII - 1
 Test Model 802.11ac(HT20) Frequency(MHz) 5240

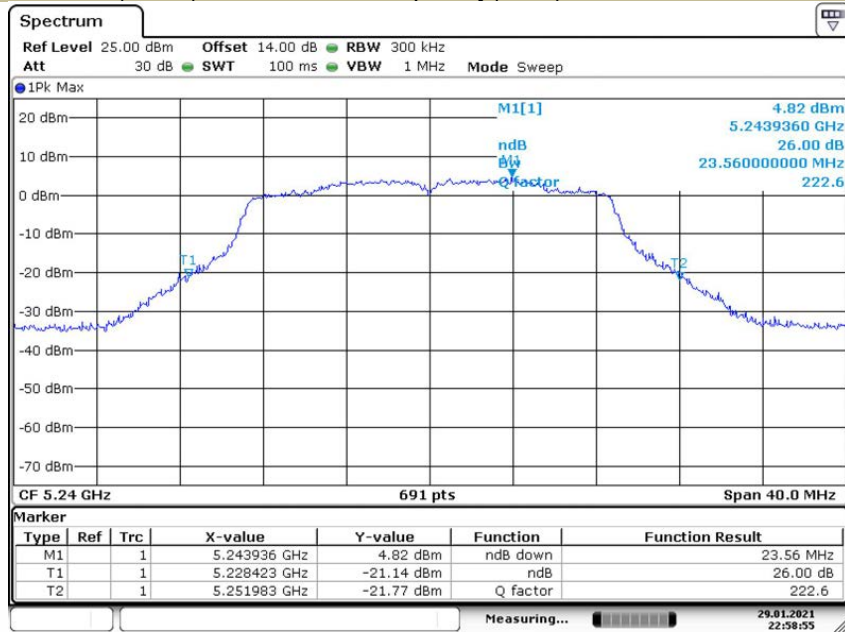

Date: 29.JAN.2021 22:58:56

26dB Emission Bandwidth U-NII - 1
 Test Model 802.11n-HT40 Frequency(MHz) 5190

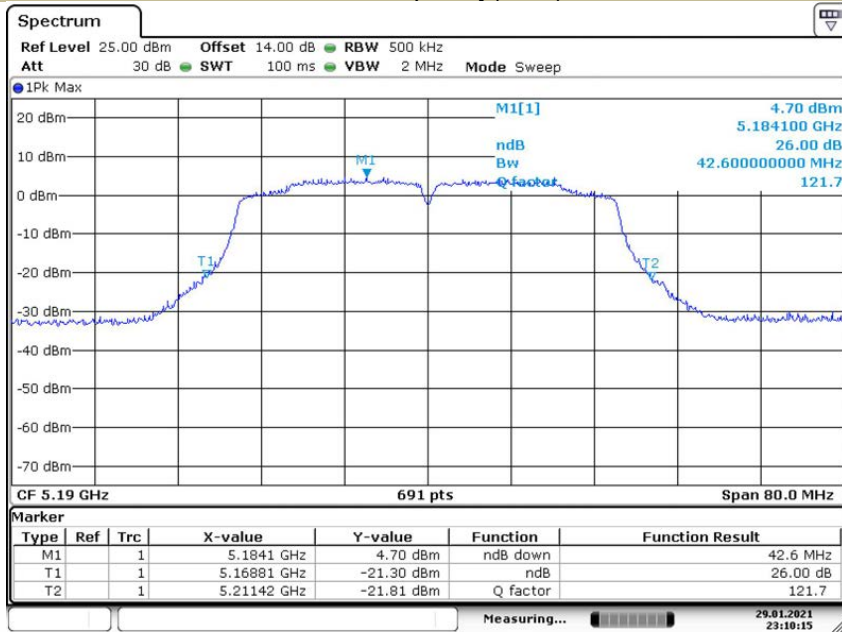

Date: 29.JAN.2021 23:10:15

26dB Emission Bandwidth U-NII - 1
 Test Model 802.11n-HT40 Frequency(MHz) 5230

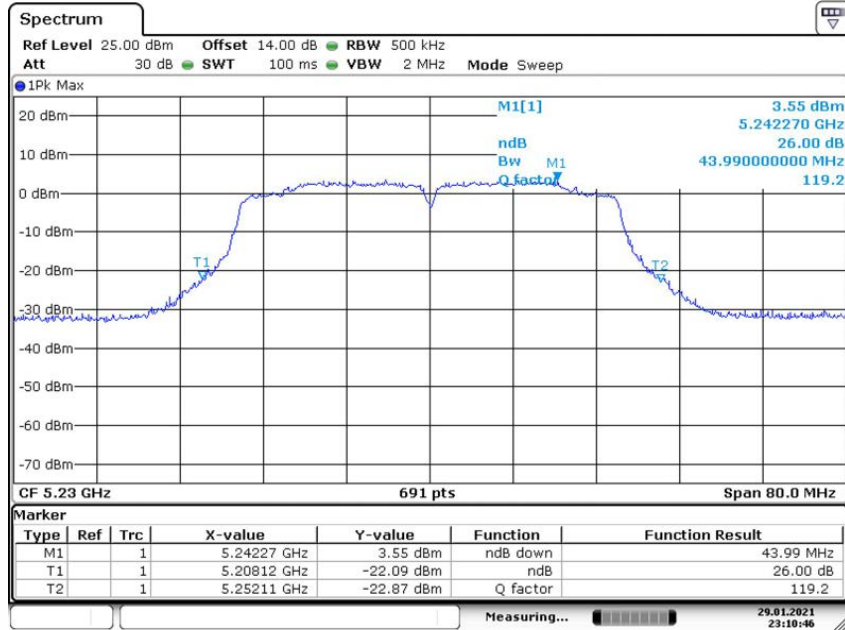

Date: 29.JAN.2021 23:10:46

26dB Emission Bandwidth U-NII - 1
 Test Model 802.11ac(HT40) Frequency(MHz) 5190

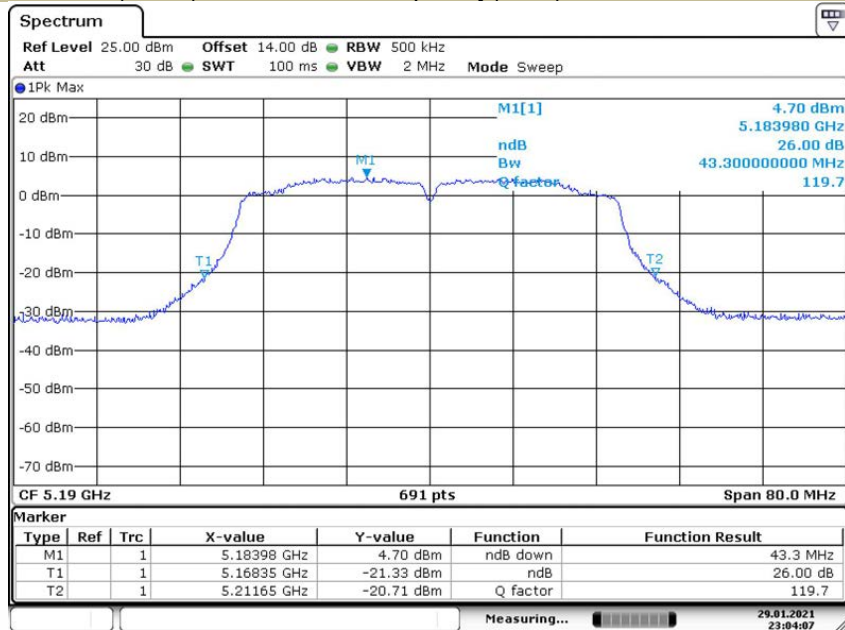

Date: 29.JAN.2021 23:04:07

26dB Emission Bandwidth **U-NII - 1**
Test Model 802.11ac(HT40) **Frequency(MHz)** **5230**

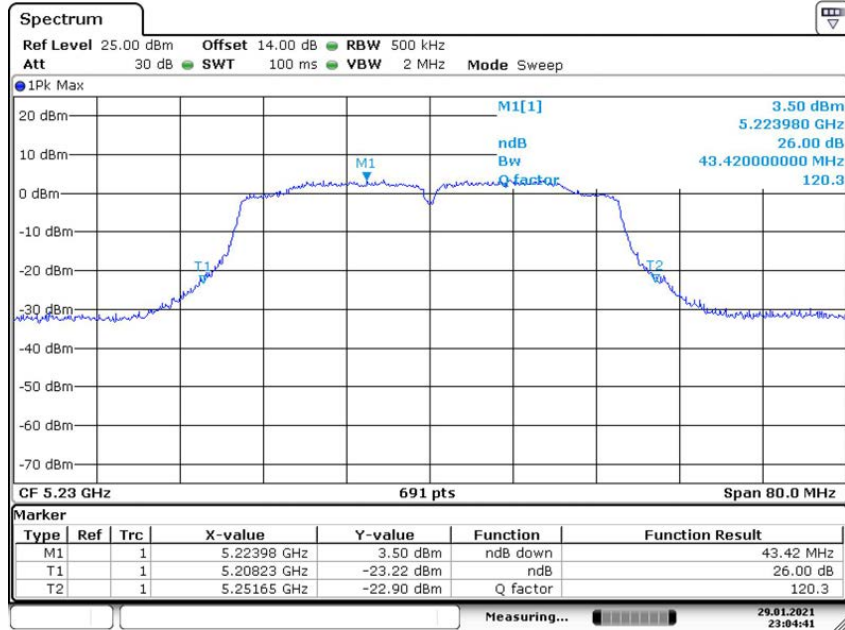

Date: 29.JAN.2021 23:04:41

26dB Emission Bandwidth **U-NII - 1**
Test Model 802.11ac 80 **Frequency(MHz)** **5210**

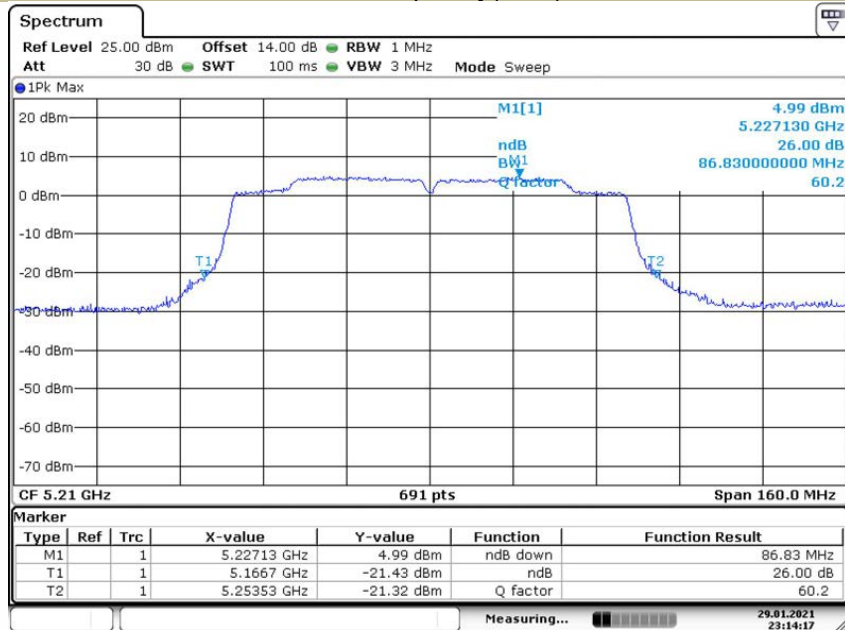

Date: 29.JAN.2021 23:14:17

26dB Emission Bandwidth U-NII - 1
 Test Model 802.11ac 160 Frequency(MHz) 5250

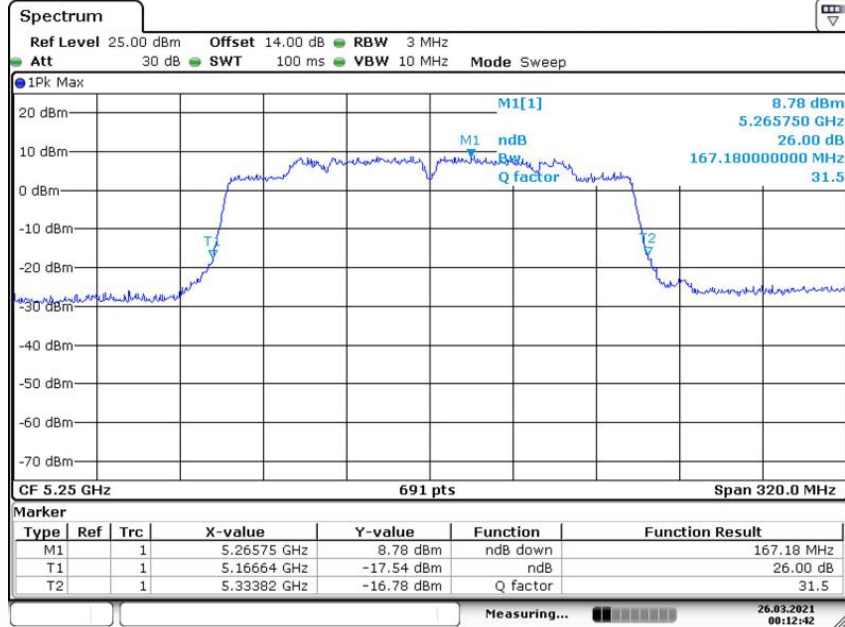

Date: 26.MAR.2021 00:12:42



Emission Bandwidth&99% Occupied Bandwidth U-NII - 1
 Test Model 802.11a Frequency(MHz) 5180

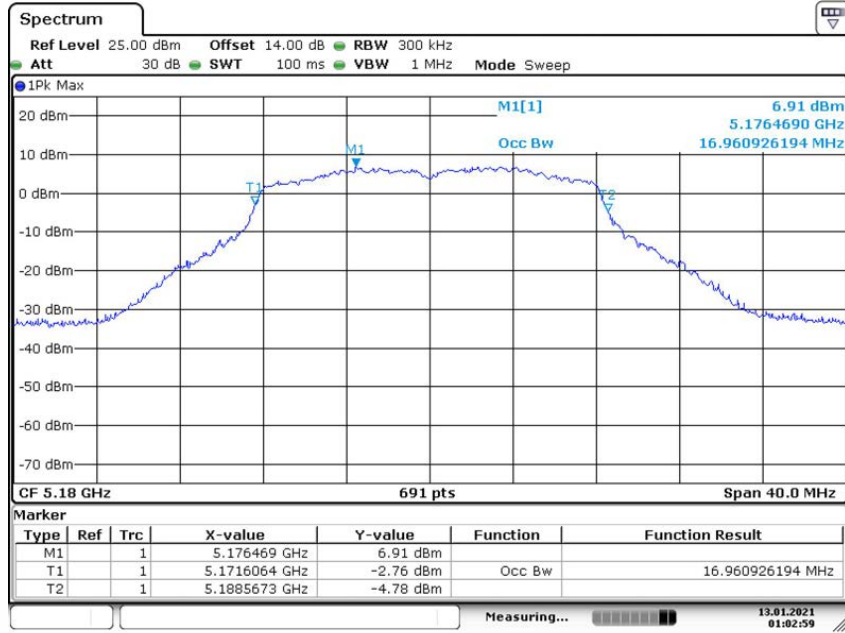

Date: 13.JAN.2021 01:02:59

Emission Bandwidth&99% Occupied Bandwidth U-NII - 1
 Test Model 802.11a Frequency(MHz) 5200

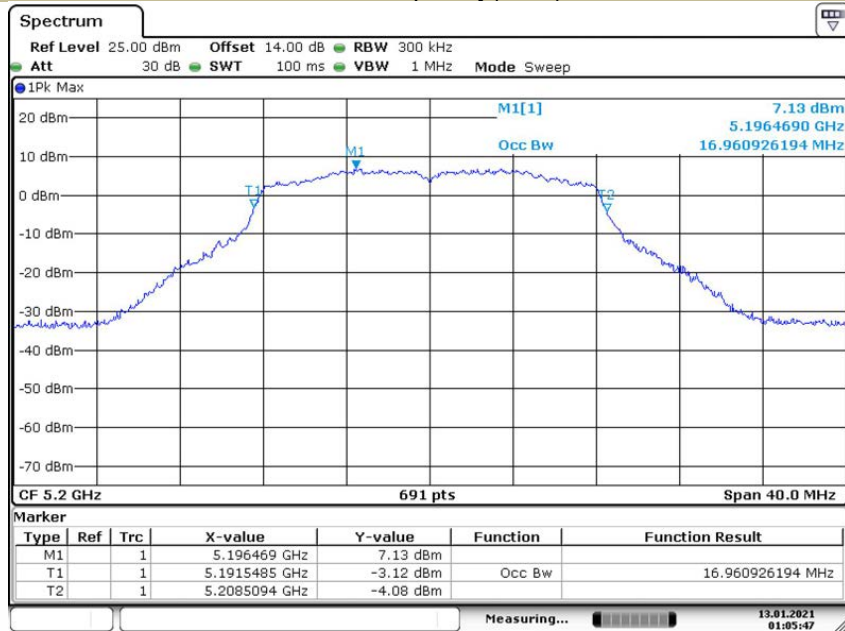

Date: 13.JAN.2021 01:05:47

Emission Bandwidth&99% Occupied Bandwidth U-NII - 1
 Test Model 802.11a Frequency(MHz) 5240

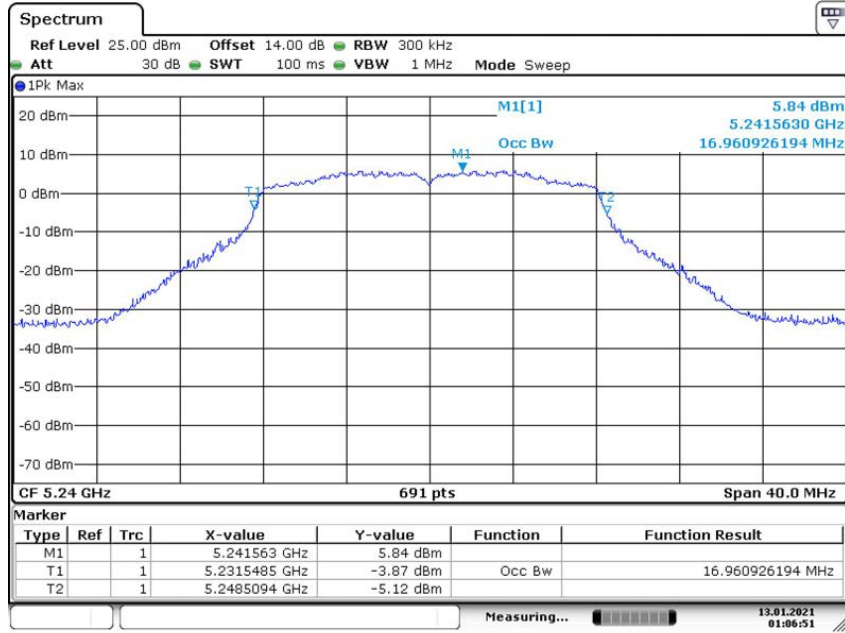

Date: 13.JAN.2021 01:06:52

Emission Bandwidth&99% Occupied Bandwidth U-NII - 1
 Test Model 802.11n-HT20 Frequency(MHz) 5180

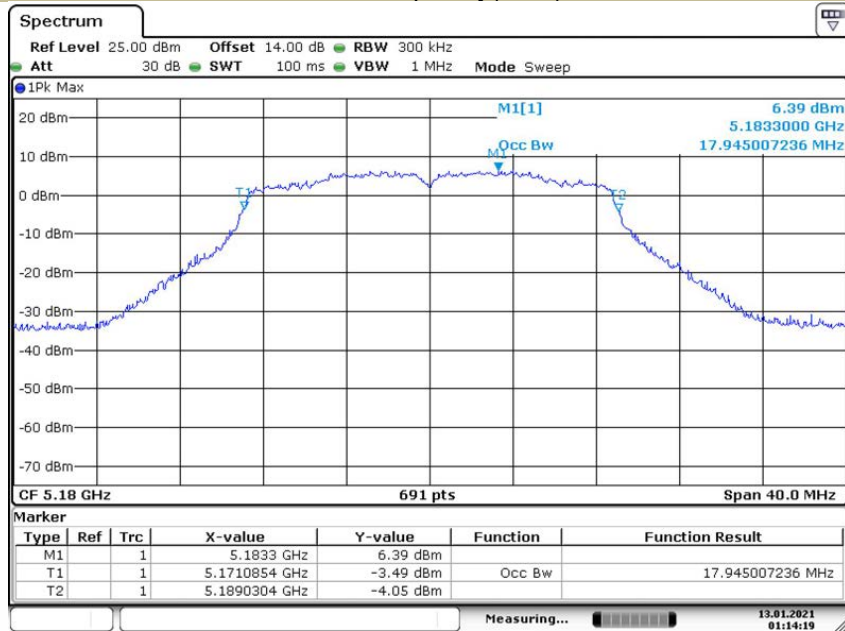

Date: 13.JAN.2021 01:14:20

Emission Bandwidth&99% Occupied Bandwidth U-NII - 1
 Test Model 802.11n-HT20 Frequency(MHz) 5200

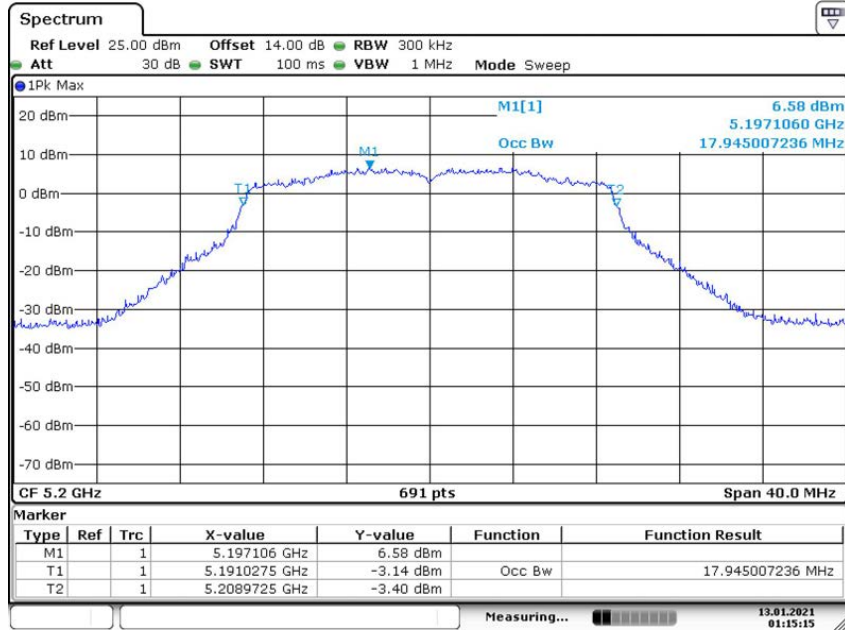

Date: 13.JAN.2021 01:15:16

Emission Bandwidth&99% Occupied Bandwidth U-NII - 1
 Test Model 802.11n-HT20 Frequency(MHz) 5240

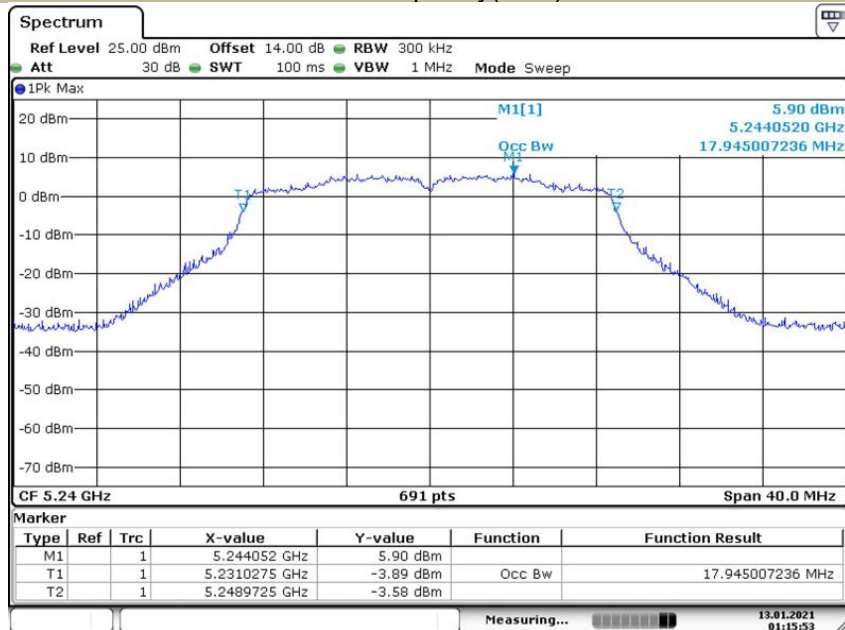

Date: 13.JAN.2021 01:15:52

Emission Bandwidth&99% Occupied Bandwidth U-NII - 1
 Test Model 802.11ac(HT20) Frequency(MHz) 5180

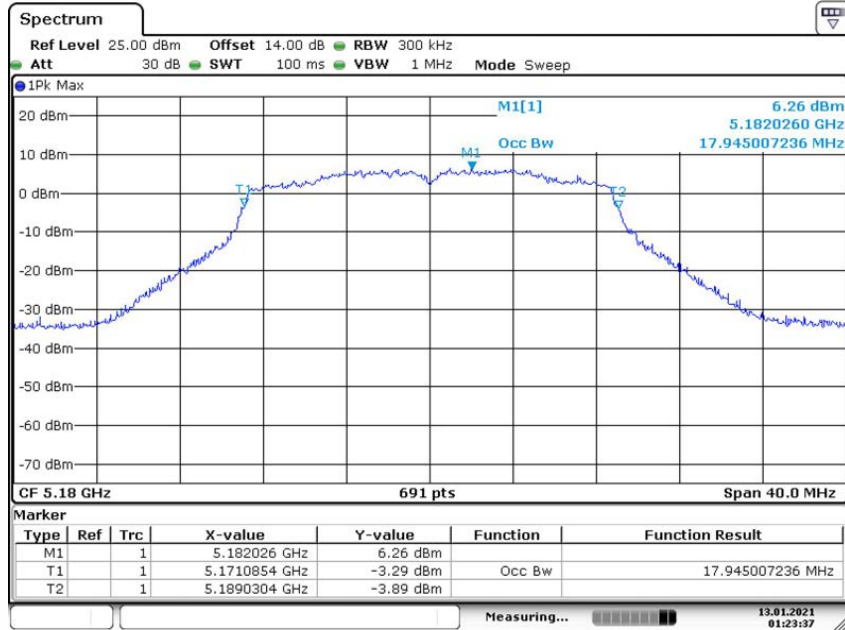

Date: 13.JAN.2021 01:23:37

Emission Bandwidth&99% Occupied Bandwidth U-NII - 1
 Test Model 802.11ac(HT20) Frequency(MHz) 5200

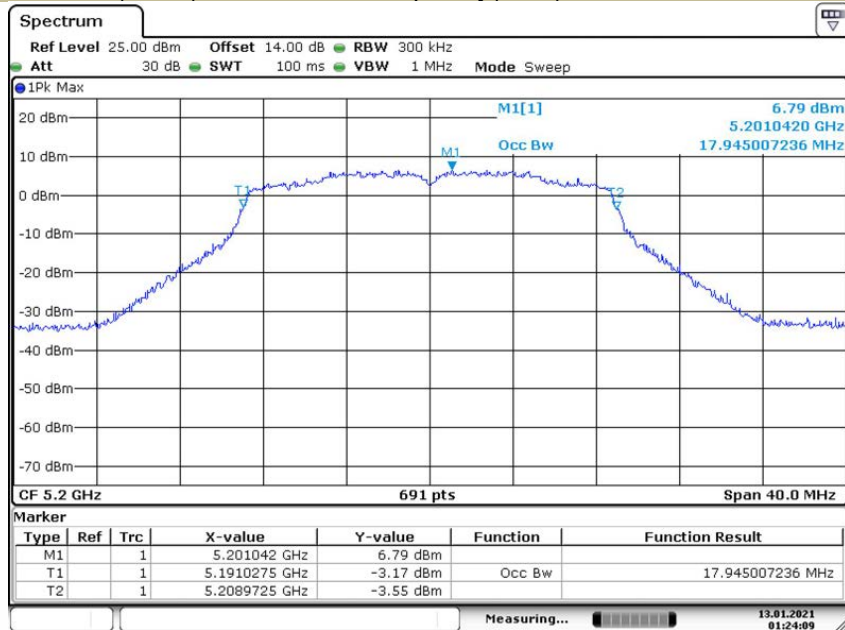

Date: 13.JAN.2021 01:24:09

Emission Bandwidth&99% Occupied Bandwidth U-NII - 1
 Test Model 802.11ac(HT20) Frequency(MHz) 5240

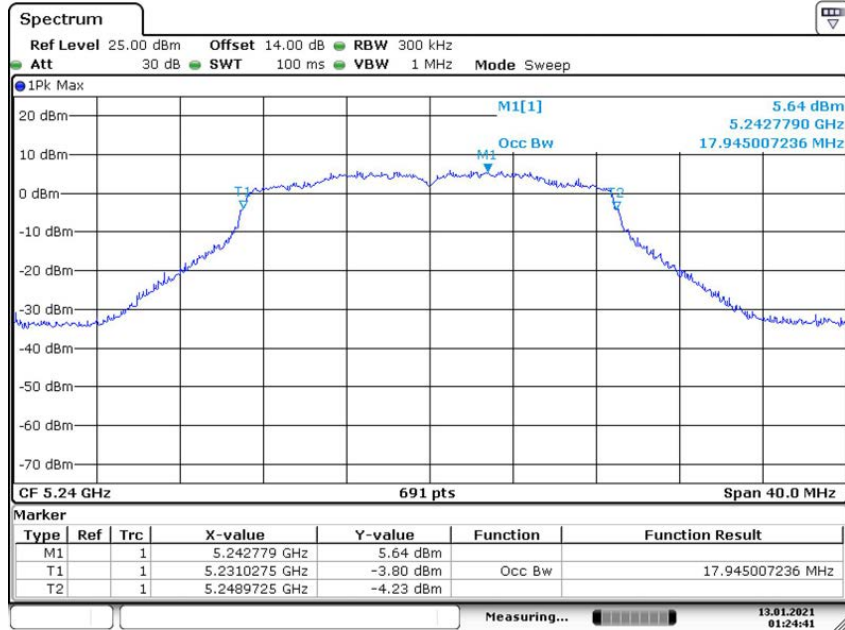

Date: 13.JAN.2021 01:24:41

Emission Bandwidth&99% Occupied Bandwidth U-NII - 1
 Test Model 802.11n-HT40 Frequency(MHz) 5190

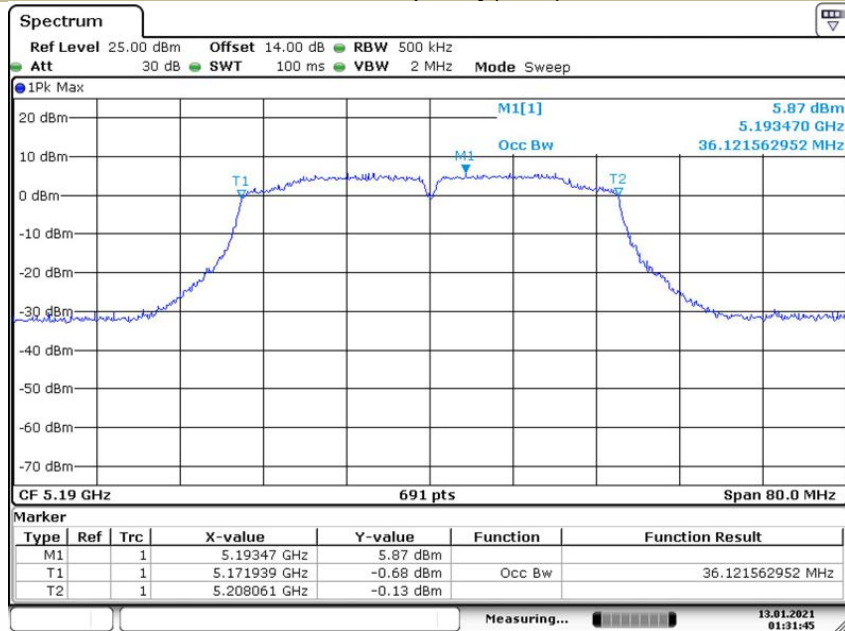

Date: 13.JAN.2021 01:31:44

Emission Bandwidth&99% Occupied Bandwidth U-NII - 1
 Test Model 802.11n-HT40 Frequency(MHz) 5230

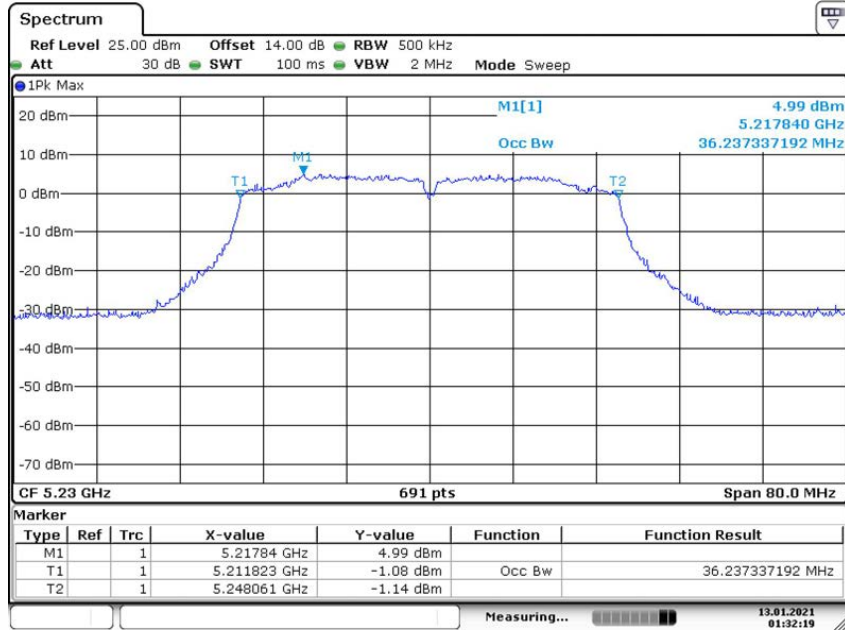

Date: 13.JAN.2021 01:32:20

Emission Bandwidth&99% Occupied Bandwidth U-NII - 1
 Test Model 802.11ac(HT40) Frequency(MHz) 5190

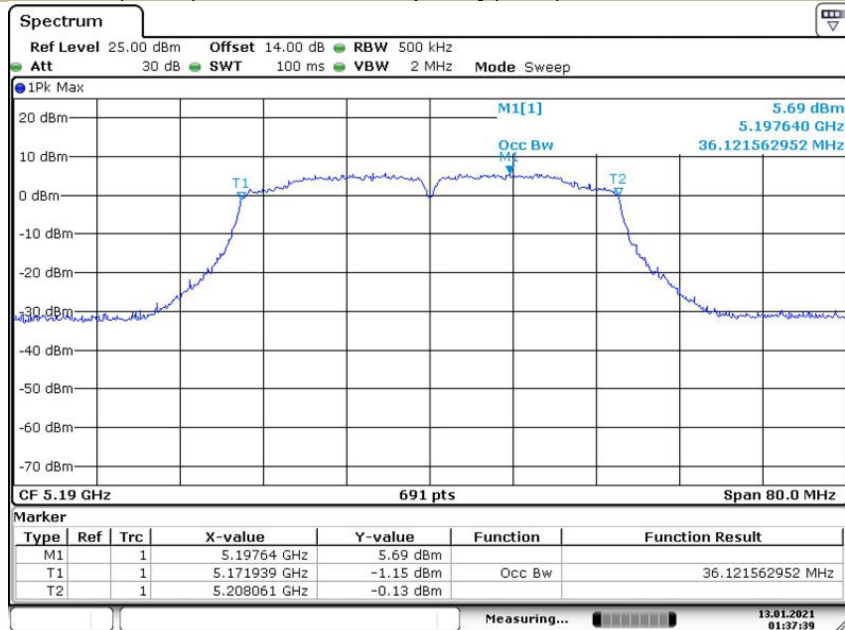

Date: 13.JAN.2021 01:37:38

Emission Bandwidth&99% Occupied Bandwidth U-NII - 1
 Test Model 802.11ac(HT40) Frequency(MHz) 5230

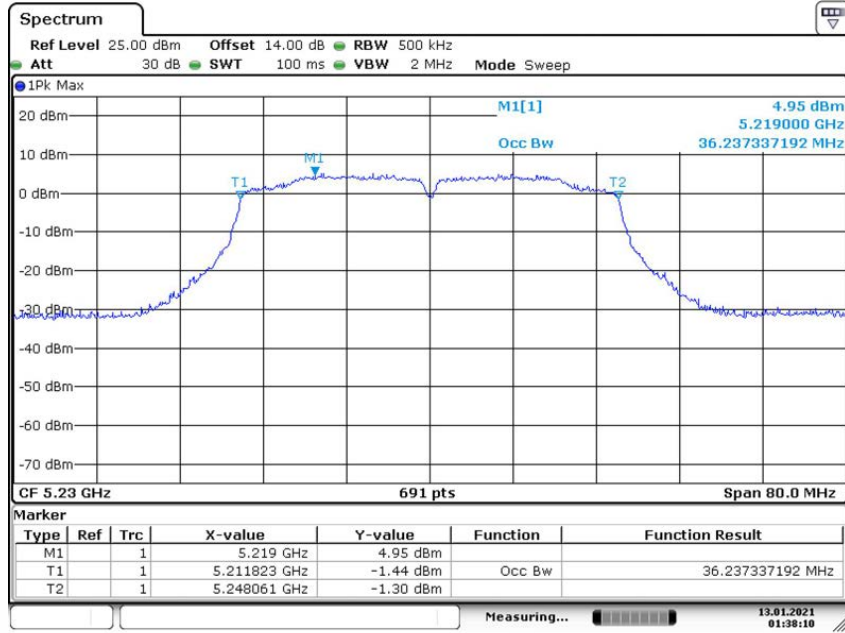

Date: 13.JAN.2021 01:38:10

Emission Bandwidth&99% Occupied Bandwidth U-NII - 1
 Test Model 802.11ac 80 Frequency(MHz) 5210

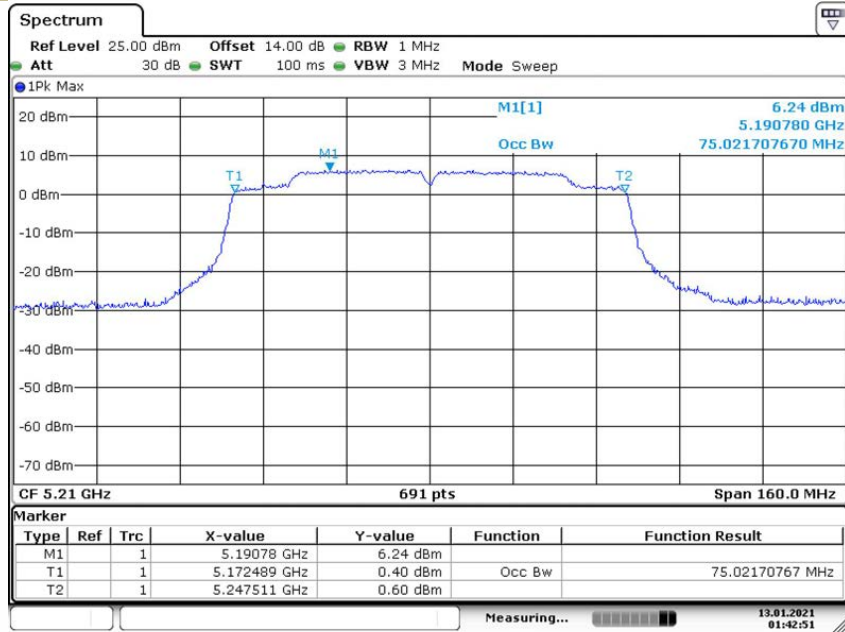

Date: 13.JAN.2021 01:42:51

Emission Bandwidth & 99% Occupied Bandwidth U-NII - 1
 Test Model 802.11ac 160 Frequency(MHz) 5250

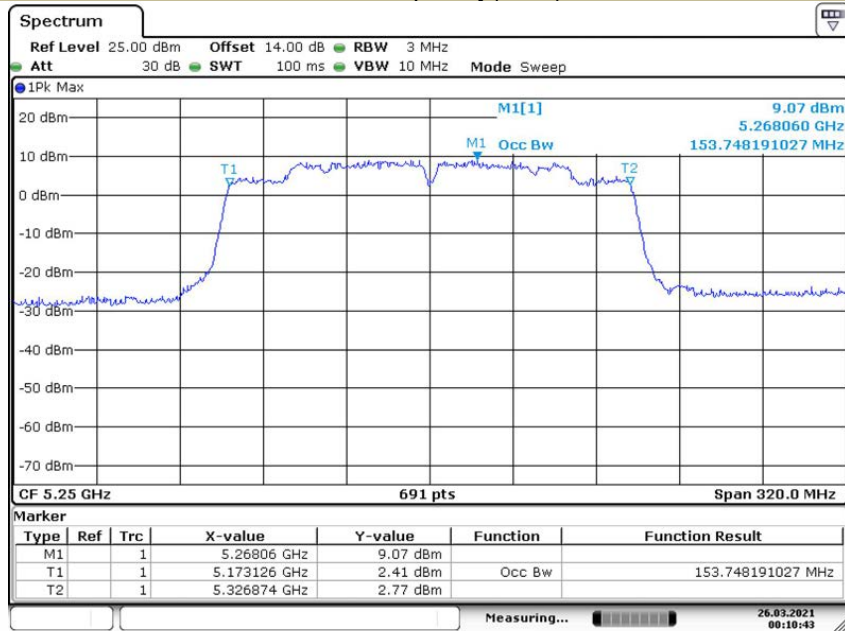

Date: 26.MAR.2021 00:10:43



**5250-5350MHz
Antenna 1**

Test Mode	Test Channel MHz		26 dB Bandwidth MHz	99% Bandwidth MHz	Verdict
	CH	Freq			
802.11a	CH52	5260	23.39	16.90	Pass
	CH56	5280	23.21	16.96	Pass
	CH64	5320	23.50	16.96	Pass
802.11n-HT20	CH52	5260	24.08	17.95	Pass
	CH56	5280	23.79	17.95	Pass
	CH64	5320	23.68	17.95	Pass
802.11ac(HT20)	CH52	5260	24.20	17.95	Pass
	CH56	5280	23.10	17.95	Pass
	CH64	5320	23.73	17.95	Pass
802.11n-HT40	CH54	5270	43.30	36.24	Pass
	CH62	5310	43.53	36.24	Pass
802.11ac(HT40)	CH54	5270	43.42	36.24	Pass
	CH62	5310	43.18	36.24	Pass
802.11ac(HT80)	CH58	5290	85.90	75.25	Pass

Antenna 2

Test Mode	Test Channel MHz		26 dB Bandwidth MHz	99% Bandwidth MHz	Verdict
	CH	Freq			
802.11a	CH52	5260	22.87	16.96	Pass
	CH56	5280	23.50	16.96	Pass
	CH64	5320	23.21	16.96	Pass
802.11n-HT20	CH52	5260	23.50	17.95	Pass
	CH56	5280	23.68	17.95	Pass
	CH64	5320	23.68	17.95	Pass
802.11ac(HT20)	CH52	5260	23.50	17.95	Pass
	CH56	5280	23.33	17.95	Pass
	CH64	5320	23.85	17.95	Pass
802.11n-HT40	CH54	5270	43.18	36.24	Pass
	CH62	5310	43.53	36.12	Pass
802.11ac(HT40)	CH54	5270	43.99	36.24	Pass
	CH62	5310	43.18	36.12	Pass
802.11ac(HT80)	CH58	5290	84.75	75.25	Pass

A.5250-5350MHz Antenna 1

26dB Emission Bandwidth

U-NII – 2A

Test Model 802.11a

Frequency(MHz)

5260

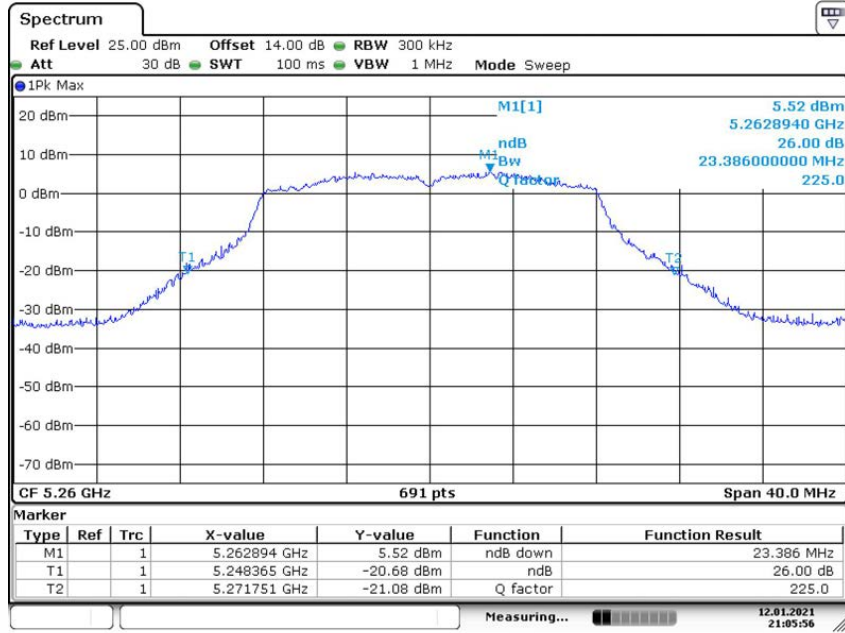

Date: 12.JAN.2021 21:05:56

26dB Emission Bandwidth

U-NII – 2A

Test Model 802.11a

Frequency(MHz)

5280

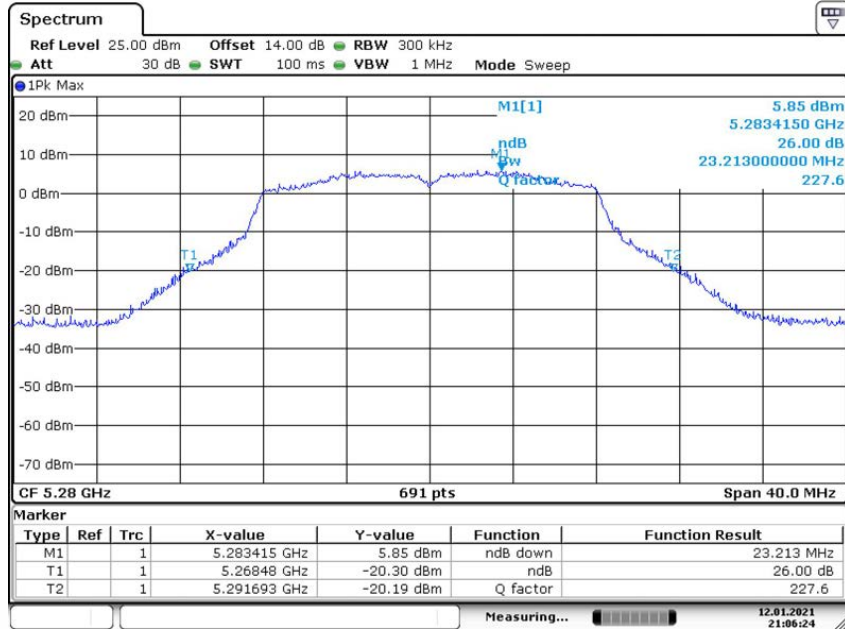

Date: 12.JAN.2021 21:06:24

26dB Emission Bandwidth U-NII – 2A
 Test Model 802.11a Frequency(MHz) 5320

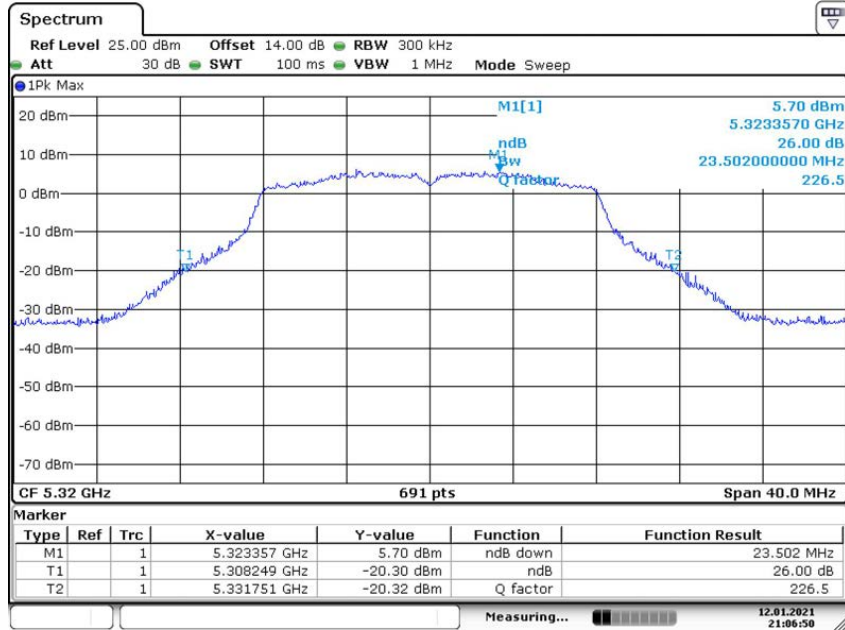

Date: 12.JAN.2021 21:06:50

26dB Emission Bandwidth U-NII – 2A
 Test Model 802.11n-HT20 Frequency(MHz) 5260

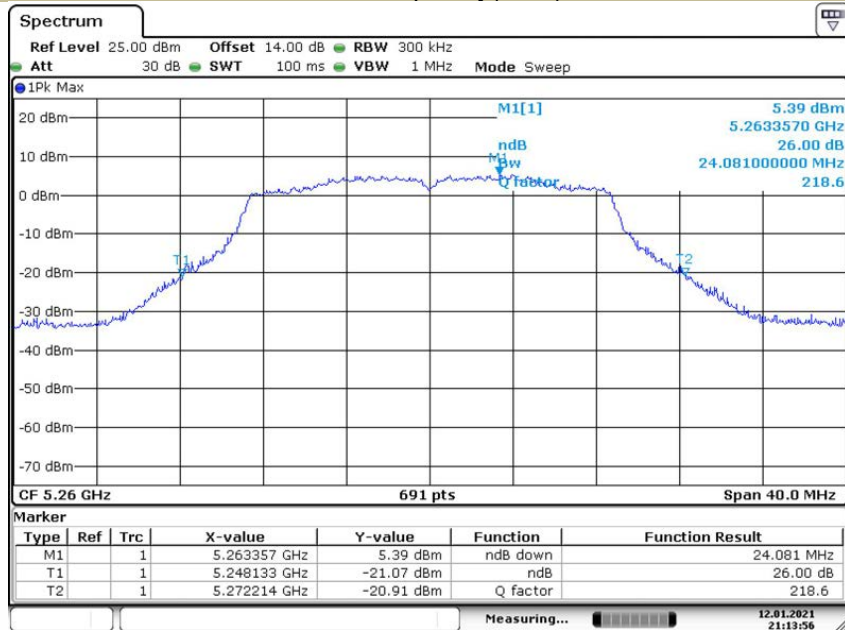

Date: 12.JAN.2021 21:13:57

26dB Emission Bandwidth U-NII – 2A
 Test Model 802.11n-HT20 Frequency(MHz) 5280

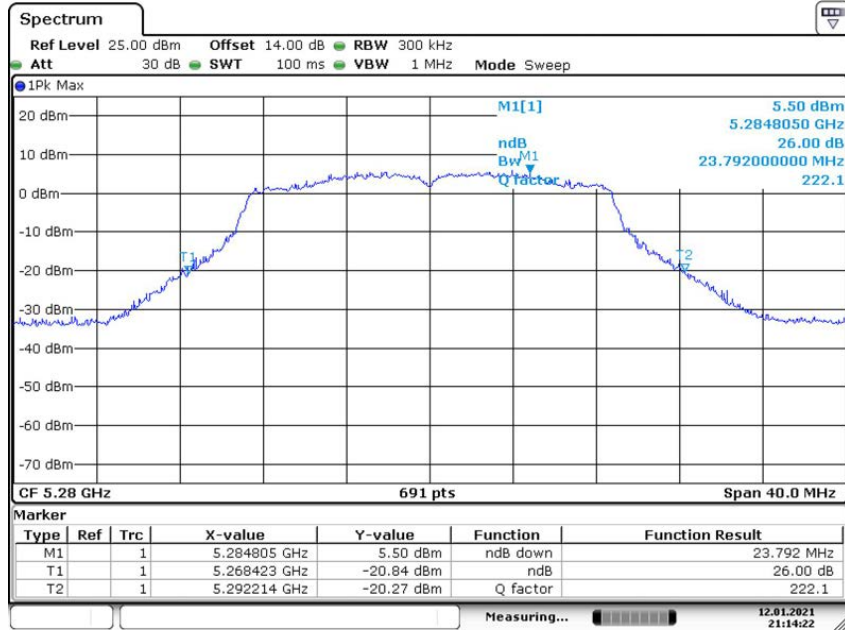

Date: 12.JAN.2021 21:14:22

26dB Emission Bandwidth U-NII – 2A
 Test Model 802.11n-HT20 Frequency(MHz) 5320

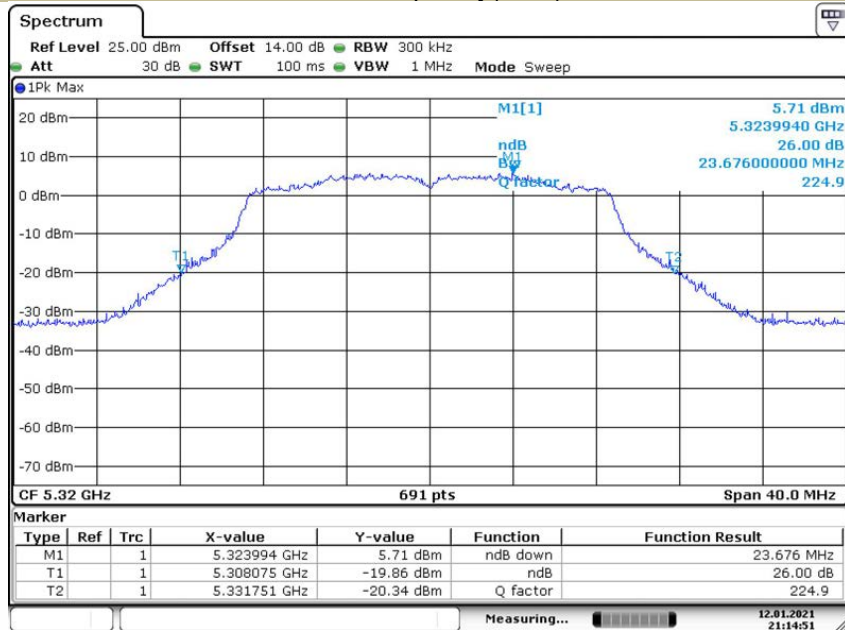

Date: 12.JAN.2021 21:14:51

26dB Emission Bandwidth U-NII – 2A
 Test Model 802.11ac(HT20) Frequency(MHz) 5260

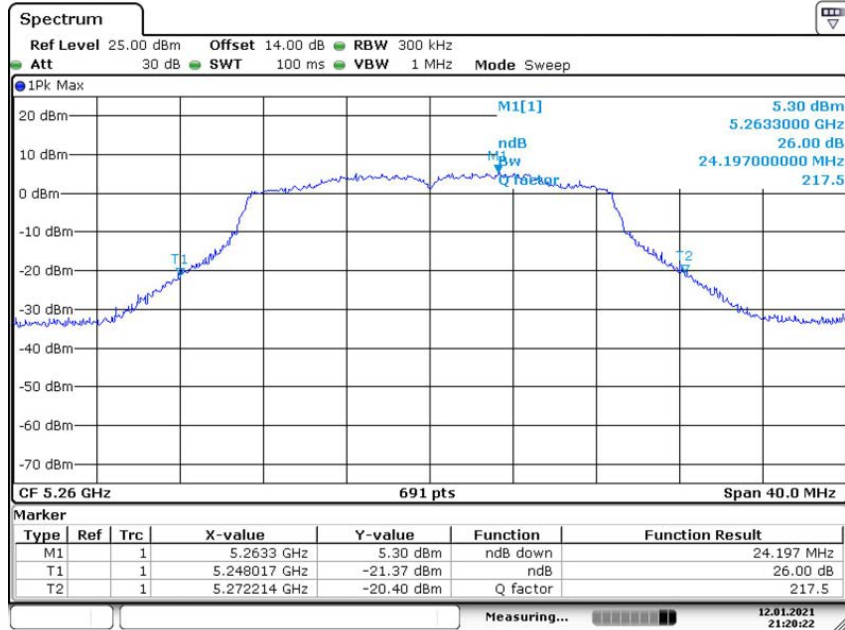

Date: 12.JAN.2021 21:20:21

26dB Emission Bandwidth U-NII – 2A
 Test Model 802.11ac(HT20) Frequency(MHz) 5280

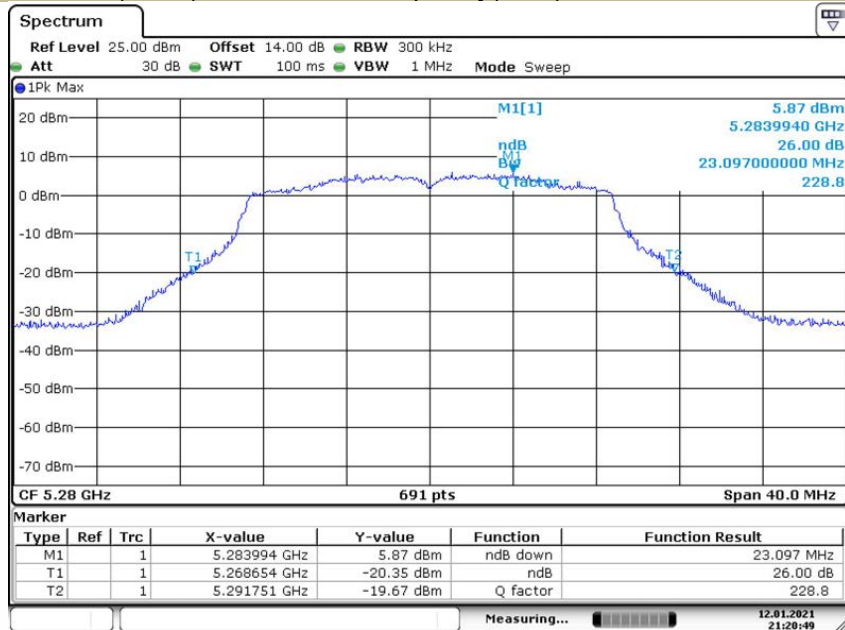

Date: 12.JAN.2021 21:20:49

26dB Emission Bandwidth U-NII – 2A
 Test Model 802.11ac(HT20) Frequency(MHz) 5320

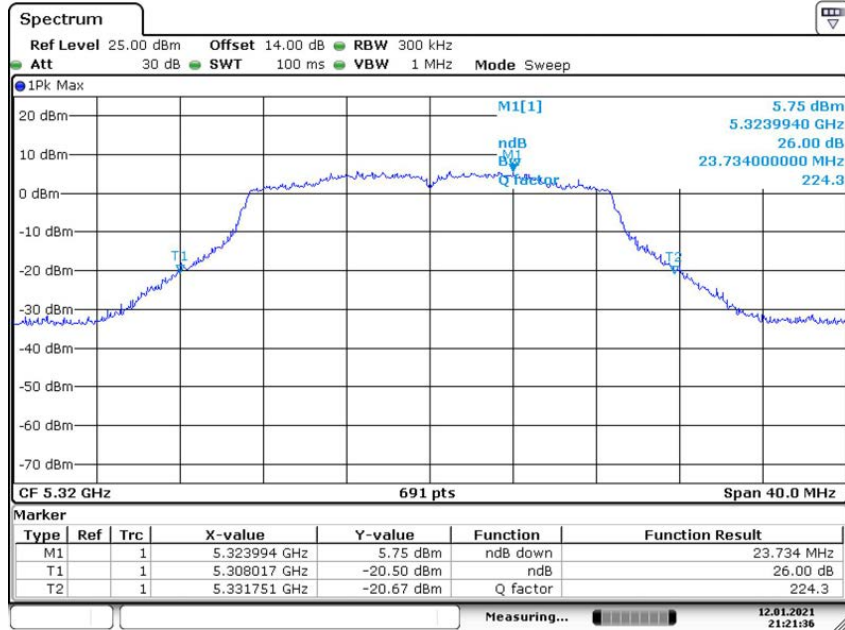

Date: 12.JAN.2021 21:21:35

26dB Emission Bandwidth U-NII – 2A
 Test Model 802.11n-HT40 Frequency(MHz) 5270

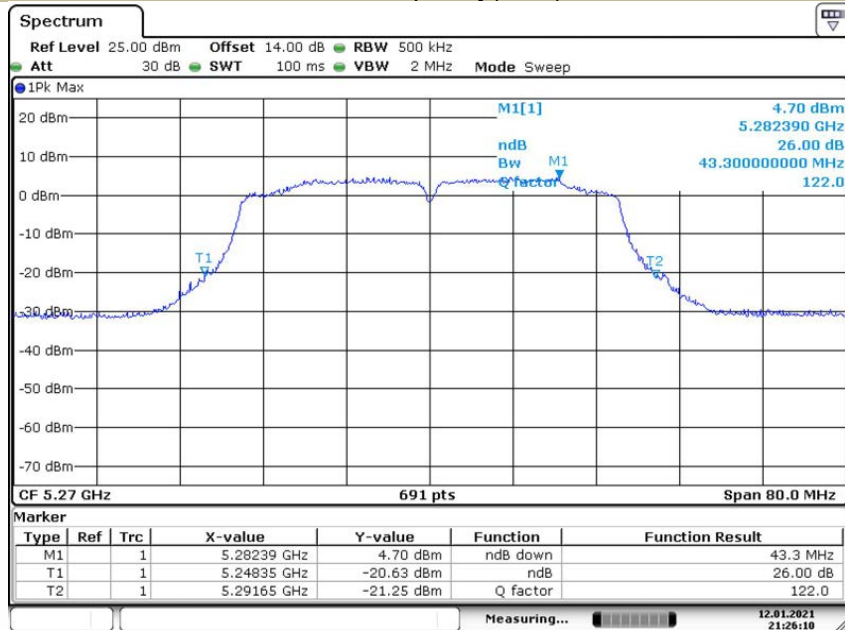

Date: 12.JAN.2021 21:26:11