



# A Test Lab Techno Corp.

Changan Lab : No. 140 -1, Changan Street, Bade City, Taoyuan County, Taiwan R.O.C.

Tel : 886-3-271-0188 / Fax : 886-3-271-0190



## SAR EVALUATION REPORT

Test Report No.	: 1510FS19
Applicant	: Unitech Electronics Co., Ltd.
Applicant Address	: 5F., No.136, Lane 235, Pao-Chiao Rd., Hsin-Tien Dist., New Taipei City, Taiwan 231, R.O.C.
Manufacture	: Unitech Electronics Co., Ltd.
Manufacture Address	: 5F., No.136, Lane 235, Pao-Chiao Rd., Hsin-Tien Dist., New Taipei City, Taiwan 231, R.O.C.
Product Type	: Rugged Handheld Computer
Trade Name	: unitech
Model Number	: PA820
Date of Received	: Oct. 16, 2015
Test Period	: Oct. 05 ~ Oct. 11, 2015
Date of Issued	: Oct. 30, 2015
Test Environment	: Ambient Temperature : $22 \pm 2^{\circ} \text{C}$ Relative Humidity : 40 - 70 %
Standard	: ANSI/IEEE C95.1-1999 / IEEE Std. 1528-2013 KDB 865664 D01 v01r04 / KDB 865664 D02 v01r01 KDB 447498 D01 v05r02 / KDB 941225 D01 v03 KDB 248227 D01 v02r01
Test Lab Location	: Chang-an Lab



1. The test operations have to be performed with cautious behavior, the test results are as attached.
2. The test results are under chamber environment of A Test Lab Techno Corp. A Test Lab Techno Corp. does not assume responsibility for any conclusions and generalizations drawn from the test results with regard to other specimens or samples.
3. The measurement report has to be written approval of A Test Lab Techno Corp. It may only be reproduced or published in full. This report shall not be reproduced except in full, without the written approval of A Test Lab Techno Corp. The test results in the report only apply to the tested sample.

Approved By : Bill Hu  
(Bill Hu)

Tested By : Sky Chou  
(Sky Chou)



# Contents

1. Summary of Maximum Reported SAR Value.....	1
2. Description of Equipment under Test (EUT) .....	1
3. Introduction.....	2
3.1 SAR Definition .....	2
4. SAR Measurement Setup .....	3
4.1 DASy E-Field Probe System.....	4
4.1.1 E-Field Probe Specification .....	5
4.1.2 E-Field Probe Calibration process .....	6
4.2 Data Acquisition Electronic (DAE) System.....	7
4.3 Robot.....	7
4.4 Measurement Server.....	7
4.5 Device Holder.....	8
4.6 Phantom - SAM v4.0 .....	8
4.7 Data Storage and Evaluation.....	9
4.7.1 Data Storage .....	9
4.7.2 Data Evaluation .....	10
5. Tissue Simulating Liquids .....	12
5.1 Ingredients.....	13
5.2 Recipes.....	13
5.3 Liquid Depth .....	14
6. SAR Testing with RF Transmitters.....	15
6.1 SAR Testing with GPRS/EGPRS Transmitters .....	15
6.2 SAR Testing with WCDMA Transmitters .....	15
6.3 SAR Testing with HSDPA Transmitters .....	15
6.4 SAR Testing with 802.11 Transmitters.....	18
6.5 Conducted Power.....	19
6.6 Antenna location.....	26
6.7 Stand-alone SAR Evaluate.....	28
6.8 Simultaneous Transmitting Evaluate.....	33
6.8.1 Estimated SAR.....	34
6.8.2 Sum of 1-g SAR of all simultaneously transmitting .....	36
6.8.3 SAR to peak location separation ratio (SPLSR).....	38
6.9 SAR test reduction according to KDB .....	38
7. System Verification and Validation.....	39
7.1 Symmetric Dipoles for System Verification .....	39
7.2 Liquid Parameters .....	40
7.3 Verification Summary .....	41
7.4 Validation Summary .....	42
8. Test Equipment List.....	43
9. Measurement Uncertainty.....	44



10. Measurement Procedure..... 47

    10.1 Spatial Peak SAR Evaluation ..... 47

    10.2 Area & Zoom Scan Procedures ..... 48

    10.3 Volume Scan Procedures..... 48

    10.4 SAR Averaged Methods ..... 48

    10.5 Power Drift Monitoring..... 48

11. SAR Test Results Summary..... 49

    11.1 Head Measurement SAR ..... 49

    11.2 Body Measurement SAR..... 50

    11.3 Hot-spot mode Measurement SAR ..... 51

    11.4 Extremity Measurement SAR ..... 51

    11.5 SAR Measurement Variability..... 51

    11.6 Std. C95.1-1999 RF Exposure Limit..... 52

12. Conclusion..... 53

13. References..... 53

Appendix A - System Performance Check..... 54

Appendix B - SAR Measurement Data..... 59

Appendix C - Calibration..... 87



## 1. Summary of Maximum Reported SAR Value

Equipment Class	Mode	Highest Reported
		Body-Worn stand alone SAR1g (0 cm) (W/kg)
PCE	GPRS / EGPRS 850	0.49
	GPRS / EGPRS 1900	0.43
	WCDMA / HSDPA / HSUPA Band II	1.37
	WCDMA / HSDPA / HSUPA Band V	0.66
DTS	2.4GHz WLAN_Antenna	0.15
U-NII	5GHz WLAN_Antenna	N/A
DSS	Bluetooth Antenna	N/A
<b>Highest Simultaneous Transmission SAR</b>		<b>Body-Worn Stand alone SAR1g (W/kg)</b>
PCE+ DSS at test position side4		1.44
DTS+DSS at test position side4		0.80

Note:1. The SAR limit (Head & Body: SAR1g 1.6 W/kg) for general population / uncontrolled exposure is specified in FCC 47 CFR part 2 (2.1093) and ANSI/IEEE C95.1-1999

Note:2. The WLAN(5GHz) and Bluetooth for Stand-alone SAR are not required, the Standalone SAR test exclusion considerations assessment results of section 6.7.



## 2. Description of Equipment under Test (EUT)

Product Type	Rugged Handheld Computer			
Trade Name	unitech			
Model Number	PA820			
FCC ID	HLEPA820BTNP			
IMEI No.	359998040102016			
RF Function	GPRS/EGPRS 850 GPRS/EGPRS 1900 WCDMA(RMC 12.2K) / HSDPA / HSUPA Band II WCDMA(RMC 12.2K) / HSDPA / HSUPA Band V IEEE 802.11b / 802.11g / 802.11n 2.4GHz 20MHz IEEE 802.11a / IEEE 802.11n 5GHz 20MHz Bluetooth BR/EDR			
Tx Frequency	Band	Operate Frequency (MHz)		
	GPRS/EGPRS 850	824.2 - 848.8		
	GPRS/EGPRS 1900	1850.2 - 1909.8		
	WCDMA(RMC 12.2K) / HSDPA / HSUPA Band II	1852.4 - 1907.6		
	WCDMA (RMC 12.2K) / HSDPA / HSUPA Band V	826.4 - 846.6		
	IEEE 802.11b / 802.11g / 802.11n 2.4GHz 20MHz	2412 - 2462		
	IEEE 802.11a U-NII Band I	5180 - 5240		
	IEEE 802.11a U-NII Band III	5180 - 5240		
	IEEE 802.11n 5GHz 20MHz U-NII Band I	5745 - 5825		
	IEEE 802.11n 5GHz 20MHz U-NII Band III	5745 - 5825		
	Bluetooth BR/EDR	2402 - 2480		
	*GPRS/EGPRS Multi Class: 12			
	RF Conducted Power	Band	Power	
W			dBm	
(Avg.)	GPRS/EGPRS 850	1.524	31.83	
	GPRS/EGPRS 1900	0.793	28.99	
	WCDMA(RMC 12.2K) / HSDPA / HSUPA Band II	0.160	22.04	
	WCDMA (RMC 12.2K) / HSDPA / HSUPA Band V	0.165	22.18	
	IEEE 802.11b	0.036	15.51	
	IEEE 802.11g	0.013	11.05	
	IEEE 802.11n 2.4GHz 20MHz	0.013	11.25	
	IEEE 802.11a U-NII Band I	0.008	8.77	
	IEEE 802.11a U-NII Band III	0.010	10.03	
	IEEE 802.11n 5GHz 20MHz U-NII Band I	0.008	9.19	
	IEEE 802.11n 5GHz 20MHz U-NII Band III	0.007	8.20	
	Bluetooth BR/EDR	0.002	2.95	
Antenna Type	WWAN : PIFA Antenna			
	WLAN : FPCB Antenna			
	Bluetooth : Chip Antenna			
Battery Option	Standard			
	Trade Name: WELLTECH ENERGY			
	Model: 1400-900001G Spec: DC 3.7V / 2200mAh			
Device Category	Portable Device			
Application Type	Certification			

Note: The above EUT's information was declared by manufacturer. Please refer to the specifications or user's manual for more detailed description.

### 3. Introduction

The A Test Lab Techno Corp. has performed measurements of the maximum potential exposure to the user of **Unitech Electronics Co., Ltd. Trade Name : unitech Model(s) : PA820**. The test procedures, as described in American National Standards, Institute C95.1-1999 [ 1 ] were employed and they specify the maximum exposure limit of 1.6mW/g as averaged over any 1 gram of tissue for portable devices being used within 20cm between user and EUT in the uncontrolled environment. A description of the product and operating configuration, detailed summary of the test results, methodology and procedures used in the equipment used are included within this test report.

#### 3.1 SAR Definition

Specific Absorption Rate (SAR) is defined as the time derivative (rate) of the incremental energy (dw) absorbed by (dissipated in) an incremental mass (dm) contained in a volume element (dv) of a given density ( $\rho$ ). It is also defined as the rate of RF energy absorption per unit mass at a point in an absorbing body (see Figure 2).

$$\text{SAR} = \frac{d}{dt} \left( \frac{dw}{dm} \right) = \frac{d}{dt} \left( \frac{dw}{\rho dv} \right)$$

Figure 2. SAR Mathematical Equation

SAR is expressed in units of Watts per kilogram (W/kg)

$$\text{SAR} = \frac{\sigma E^2}{\rho}$$

Where :

- $\sigma$  = conductivity of the tissue (S/m)
- $\rho$  = mass density of the tissue (kg/m<sup>3</sup>)
- $E$  = RMS electric field strength (V/m)

\*Note :

The primary factors that control rate of energy absorption were found to be the wavelength of the incident field in relations to the dimensions and geometry of the irradiated organism, the orientation of the organism in relation to the polarity of field vectors, the presence of reflecting surfaces, and whether conductive contact is made by the organism with a ground plane [ 2 ]

## 4. SAR Measurement Setup

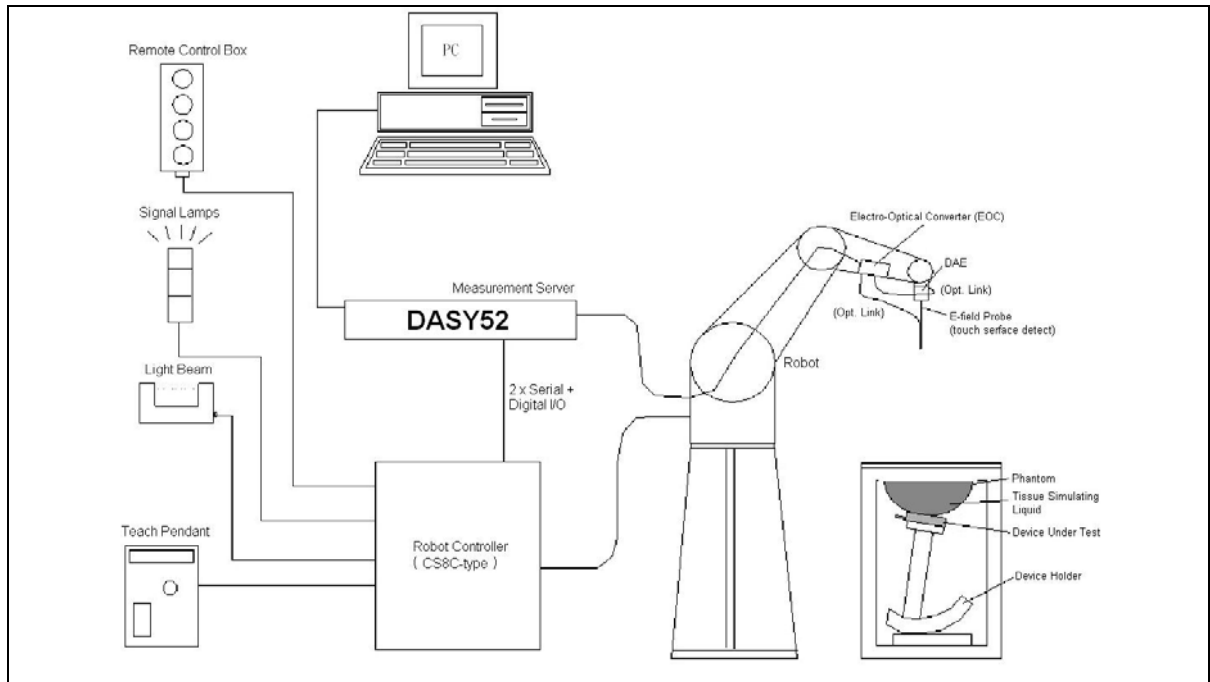

The DASY52 system for performing compliance tests consists of the following items:

1. A standard high precision 6-axis robot (Stäubli TX family) with controller, teach pendant and software. An arm extension for accommodating the data acquisition electronics (DAE).
2. A dosimetric probe, i.e., an isotropic E-field probe optimized and calibrated for usage in tissue simulating liquid. The probe is equipped with an optical surface detector system.
3. A data acquisition electronics (DAE) which performs the signal amplification, signal multiplexing, AD-conversion, offset measurements, mechanical surface detection, collision detection, etc. The unit is battery powered with standard or rechargeable batteries. The signal is optically transmitted to the EOC.
4. The function of the measurement server is to perform the time critical tasks such as signal filtering, control of the robot operation and fast movement interrupts.
5. A probe alignment unit which improves the (absolute) accuracy of the probe positioning.
6. A computer operating Windows 2000 or Windows XP.
7. DASY52 software.
8. Remote controls with teach pendant and additional circuitry for robot safety such as warning lamps, etc.
9. The SAM twin phantom enabling testing left-hand and right-hand usage.
10. The device holder for handheld mobile phones.
11. Tissue simulating liquid mixed according to the given recipes.
12. Validation dipole kits allowing validating the proper functioning of the system.



## 4.1 DASYS E-Field Probe System

The SAR measurements were conducted with the dosimetric probe (manufactured by SPEAG), designed in the classical triangular configuration [ 3 ] and optimized for dosimetric evaluation. The probe is constructed using the thick film technique; with printed resistive lines on ceramic substrates. The probe is equipped with an optical multi-fiber line ending at the front of the probe tip. It is connected to the EOC box on the robot arm and provides an automatic detection of the phantom surface. Half of the fibers are connected to a pulsed infrared transmitter, the other half to a synchronized receiver. As the probe approaches the surface, the reflection from the surface produces a coupling from the transmitting to the receiving fibers. This reflection increases first during the approach, reaches maximum and then decreases. If the probe is flatly touching the surface, the coupling is zero. The distance of the coupling maximum to the surface is independent of the surface reflectivity and largely independent of the surface to probe angle. The DASYS software reads the reflection during a software approach and looks for the maximum using a 2nd order fitting. The approach is stopped when reaching the maximum.



#### 4.1.1 E-Field Probe Specification

Construction	Symmetrical design with triangular core Built-in shielding against static charges PEEK enclosure material (resistant to organic solvents, e.g., DGBE)
Calibration	ISO/IEC 17025 calibration service available
Frequency	10 MHz to > 6 GHz Linearity: $\pm 0.2$ dB (30 MHz to 6 GHz)
Directivity	$\pm 0.3$ dB in brain tissue (rotation around probe axis) $\pm 0.5$ dB in brain tissue (rotation normal probe axis)
Dimensions	Overall length: 337 mm (Tip: 20 mm) Tip diameter: 2.5 mm (Body: 12 mm) Typical distance from probe tip to dipole centers: 1 mm



Figure 3. E-field Probe



Figure 4. Probe setup on robot



#### 4.1.2 E-Field Probe Calibration process

##### Dosimetric Assessment Procedure

Each E-Probe/Probe Amplifier combination has unique calibration parameters. A TEM cell calibration procedure is conducted to determine the proper amplifier settings to enter in the probe parameters. The amplifier settings are determined for a given frequency by subjecting the probe to a known E-field density (1 mW/cm<sup>2</sup>) using an RF Signal generator, TEM cell, and RF Power Meter.

##### Free Space Assessment

The free space E-field from amplified probe outputs is determined in a test chamber. This calibration can be performed in a TEM cell if the frequency is below 1 GHz and in a waveguide or other methodologies above 1 GHz for free space. For the free space calibration, the probe is placed in the volumetric center of the cavity and at the proper orientation with the field. The probe is rotated 360 degrees until the three channels show the maximum reading. The power density readings equates to 1 mW/cm<sup>2</sup>.

##### Temperature Assessment

E-field temperature correlation calibration is performed in a flat phantom filled with the appropriate simulated head tissue. The E-field in the medium correlates with the temperature rise in the dielectric medium. For temperature correlation calibration a RF transparent thermistor-based temperature probe is used in conjunction with the E-field probe.

$$SAR = C \frac{\Delta T}{\Delta t}$$

Where :

$\Delta t$  = Exposure time (30 seconds),

C = Heat capacity of tissue (head or body),

$\Delta T$  = Temperature increase due to RF exposure.

$$\text{Or } SAR = \frac{|E|^2 \sigma}{\rho}$$

Where :

$\sigma$  = Simulated tissue conductivity,

$\rho$  = Tissue density (kg/m<sup>3</sup>).



## 4.2 Data Acquisition Electronic (DAE) System

Model : DAE3, DAE4  
Construction : Signal amplifier, multiplexer, A/D converter and control logic. Serial optical link for communication with DASY4/5 embedded system (fully remote controlled). Two step probe touch detector for mechanical surface detection and emergency robot stop.  
Measurement Range : -100 to +300 mV (16 bit resolution and two range settings: 4mV, 400mV)  
Input Offset Voltage : < 5 $\mu$ V (with auto zero)  
Input Bias Current : < 50 fA  
Dimensions : 60 x 60 x 68 mm

## 4.3 Robot

Positioner : Stäubli Unimation Corp. Robot Model: TX90XL  
Repeatability :  $\pm$ 0.02 mm  
No. of Axis : 6

## 4.4 Measurement Server

Processor : PC/104 with a 400MHz intel ULV Celeron  
I/O-board : Link to DAE4 (or DAE3)  
16-bit A/D converter for surface detection system  
Digital I/O interface  
Serial link to robot  
Direct emergency stop output for robot

#### 4.5 Device Holder

The DASY device holder is constructed of low-loss POM material having the following dielectric parameters: relative permittivity  $\epsilon=3$  and loss tangent  $\delta=0.02$ . The amount of dielectric material has been reduced in the closest vicinity of the device, since measurements have suggested that the influence of the clamp on the test results could thus be lowered.

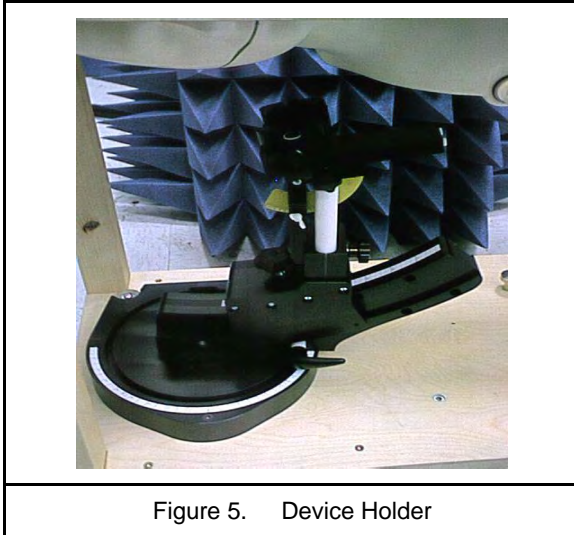

#### 4.6 Phantom - SAM v4.0

The shell corresponds to the specifications of the Specific Anthropomorphic Mannequin (SAM) phantom defined in IEEE 1528 and IEC 62209-1. It enables the dosimetric evaluation of left and right hand phone usage as well as body mounted usage at the flat phantom region. A cover prevents evaporation of the liquid. Reference markings on the phantom allow the complete setup of all predefined phantom positions and measurement grids by manually teaching three points with the robot.

Shell Thickness	2 ±0.2 mm
Filling Volume	Approx. 25 liters
Dimensions	1000x500 mm (LxW)
Table 1. Specification of SAM v4.0	



Figure 6. SAM Twin Phantom



## **4.7 Data Storage and Evaluation**

### **4.7.1 Data Storage**

The DASY software stores the assessed data from the data acquisition electronics as raw data (in microvolt readings from the probe sensors), together with all the necessary software parameters for the data evaluation (probe calibration data, liquid parameters and device frequency and modulation data) in measurement files with the extension DA4 or DA5. The post processing software evaluates the desired unit and format for output each time the data is visualized or exported. This allows verification of the complete software setup even after the measurement and allows correction of erroneous parameter settings. For example, if a measurement has been performed with an incorrect crest factor parameter in the device setup, the parameter can be corrected afterwards and the data can be reevaluated.



#### 4.7.2 Data Evaluation

The DASY post processing software (SEMCAD) automatically executes the following procedures to calculate the field units from the microvolt readings at the probe connector. The parameters used in the evaluation are stored in the configuration modules of the software :

- Probe parameters : - Sensitivity  $Norm_i, ai0, ai1, ai2$   
- Conversion factor  $ConvFi$   
- Diode compression point  $dcp_i$
- Device parameters : - Frequency  $f$   
- Crest factor  $cf$
- Media parameters : - Conductivity  $\sigma$   
- Density  $\rho$

These parameters must be set correctly in the software. They can be found in the component documents or they can be imported into the software from the configuration files issued for the DASY components. In the direct measuring mode of the multimeter option, the parameters of the actual system setup are used. In the scan visualization and export modes, the parameters stored in the corresponding document files are used.

The first step of the evaluation is a linearization of the filtered input signal to account for the compression characteristics of the detector diode. The compensation depends on the input signal, the diode type and the DC-transmission factor from the diode to the evaluation electronics. If the exciting field is pulsed, the crest factor of the signal must be known to correctly compensate for peak power. The formula for each channel can be given as :

$$V_i = U_i + U_i^2 \cdot \frac{cf}{dcp_i}$$

- With  $V_i$  = compensated signal of channel i (i = x, y, z)  
 $U_i$  = input signal of channel i (i = x, y, z)  
 $cf$  = crest factor of exciting field (DASY parameter)  
 $dcp_i$  = diode compression point (DASY parameter)

From the compensated input signals the primary field data for each channel can be evaluated :

E-field probes : 
$$E_i = \sqrt{\frac{V_i}{Norm_i \cdot ConvF}}$$



$$H_i = \sqrt{V_i} \cdot \frac{a_{i0} + a_{i1}f + a_{i2}f^2}{f}$$

H-field probes :

- with  $V_i$  = compensated signal of channel i (i = x, y, z)  
*Normi* = sensor sensitivity of channel i (i = x, y, z)  
 $\mu V/(V/m)^2$  for E-field Probes  
*ConvF* = sensitivity enhancement in solution  
 $a_{ij}$  = sensor sensitivity factors for H-field probes  
 $f$  = carrier frequency [GHz]  
 $E_i$  = electric field strength of channel i in V/m  
 $H_i$  = magnetic field strength of channel i in A/m

The RSS value of the field components gives the total field strength (Hermitian magnitude) :

$$E_{tot} = \sqrt{E_x^2 + E_y^2 + E_z^2}$$

The primary field data are used to calculate the derived field units.

$$SAR = E_{tot}^2 \cdot \frac{\sigma}{\rho \cdot 1000}$$

- with  $SAR$  = local specific absorption rate in mW/g  
 $E_{tot}$  = total field strength in V/m  
 $\sigma$  = conductivity in [mho/m] or [Siemens/m]  
 $\rho$  = equivalent tissue density in g/cm<sup>3</sup>

\* Note : That the density is set to 1, to account for actual head tissue density rather than the density of the tissue simulating liquid.

The power flow density is calculated assuming the excitation field to be a free space field.

$$P_{pwe} = \frac{E_{tot}^2}{3770} \quad \text{or} \quad P_{pwe} = \frac{H_{tot}^2}{37.7}$$

- with  $P_{pwe}$  = equivalent power density of a plane wave in mW/cm<sup>2</sup>  
 $E_{tot}$  = total electric field strength in V/m  
 $H_{tot}$  = total magnetic field strength in A/m



## 5. Tissue Simulating Liquids

The mixture is calibrated to obtain proper dielectric constant (permittivity) and conductivity of the tissue.

The dielectric parameters of the liquids were verified prior to the SAR evaluation using an 85070C Dielectric Probe Kit and an E5071B Network Analyzer.

### IEEE SCC-34/SC-2 in 1528 recommended Tissue Dielectric Parameters

The head tissue dielectric parameters recommended by the IEEE SCC-34/SC-2 in 1528 have been incorporated in the following table. These head parameters are derived from planar layer models simulating the highest expected SAR for the dielectric properties and tissue thickness variations in human head. Other head and body tissue parameters that have not been specified in 1528 are derived from the tissue dielectric parameters computed from the 4-Cole-Cole equation and extrapolated according to the head parameter specified in 1528.

Target Frequency	Head		Body	
(MHz)	$\epsilon_r$	$\sigma$ (S/m)	$\epsilon_r$	$\sigma$ (S/m)
150	52.3	0.76	61.9	0.80
300	45.3	0.87	58.2	0.92
450	43.5	0.87	56.7	0.94
835	41.5	0.90	55.2	0.97
900	41.5	0.97	55.0	1.05
915	41.5	0.98	55.0	1.06
1450	40.5	1.20	54.0	1.30
1610	40.3	1.29	53.8	1.40
1800 - 2000	40.0	1.40	53.3	1.52
2450	39.2	1.80	52.7	1.95
3000	38.5	2.40	52.0	2.73
5800	35.3	5.27	48.2	6.00
( $\epsilon_r$ = relative permittivity, $\sigma$ = conductivity and $\rho = 1000$ kg/m <sup>3</sup> )				

Table 2. Tissue dielectric parameters for head and body phantoms





## 5.1 Ingredients

The following ingredients are used:

- Water: deionized water (pure H<sub>2</sub>O), resistivity ≥ 16 M Ω -as basis for the liquid
- Sugar: refined white sugar (typically 99.7 % sucrose, available as crystal sugar in food shops)  
-to reduce relative permittivity
- Salt: pure NaCl -to increase conductivity
- Cellulose: Hydroxyethyl-cellulose, medium viscosity (75-125 mPa.s, 2% in water, 20 °C), CAS # 54290 -to increase viscosity and to keep sugar in solution.
- Preservative: Preventol D-7 Bayer AG, D-51368 Leverkusen, CAS # 55965-84-9 -to prevent the spread of bacteria and molds
- DGBE: Diethylenglycol-monobutyl ether (DGBE), Fluka Chemie GmbH, CAS # 112-34-5 -to reduce relative permittivity

## 5.2 Recipes

The following tables give the recipes for tissue simulating liquids to be used in different frequency bands.

Note: The goal dielectric parameters (at 22 °C) must be achieved within a tolerance of ±5% for ε and ±5% for σ.

Ingredients (% by weight)	Frequency (MHz)												Frequency (GHz)	
	750		835		1750		1900		2450		2600		5GHz	
Tissue Type	Head	Body	Head	Body	Head	Body	Head	Body	Head	Body	Head	Body	Head	Body
Water	39.28	51.30	41.45	52.40	54.50	40.20	54.90	40.40	62.70	73.20	60.30	71.40	65.5	78.6
Salt (NaCl)	1.47	1.42	1.45	1.50	0.17	0.49	0.18	0.50	0.50	0.10	0.60	0.20	0.00	0.00
Sugar	58.15	46.18	56.00	45.00	0.00	0.00	0.00	0.00	0.00	0.00	0.00	0.00	0.00	0.00
HEC	1.00	1.00	1.00	1.00	0.00	0.00	0.00	0.00	0.00	0.00	0.00	0.00	0.00	0.00
Bactericide	0.10	0.10	0.10	0.10	0.00	0.00	0.00	0.00	0.00	0.00	0.00	0.00	0.00	0.00
Triton X-100	0.00	0.00	0.00	0.00	0.00	0.00	0.00	0.00	0.00	0.00	0.00	0.00	17.2	10.7
DGBE	0.00	0.00	0.00	0.00	45.33	59.31	44.92	59.10	36.80	26.70	39.10	28.40	0.00	0.00
Dielectric Constant	41.88	54.60	42.54	56.10	40.10	53.60	39.90	54.00	39.80	52.50	39.80	52.50	0.00	0.00
Conductivity (S/m)	0.90	0.97	0.91	0.95	1.39	1.49	1.42	1.45	1.88	1.78	1.88	1.78	0.00	0.00
Diethylene Glycol Mono-hexlether	0.00	0.00	0.00	0.00	0.00	0.00	0.00	0.00	0.00	0.00	0.00	0.00	17.3	10.7

Salt: 99+% Pure Sodium Chloride

Sugar: 98+% Pure Sucrose

Water: De-ionized, 16 M Ω<sup>+</sup> resistivity

HEC: Hydroxyethyl Cellulose

DGBE: 99+% Di(ethylene glycol) butyl ether, [2-(2-butoxyethoxy)ethanol]

Triton X-100 (ultra pure): Polyethylene glycol mono [4-(1,1, 3, 3-tetramethylbutyl)phenyl]ether

### 5.3 Liquid Depth

According to KDB865664 ,the depth of tissue-equivalent liquid in a phantom must be  $\geq 15.0$  cm with  $\leq \pm 0.5$  cm variation for SAR measurements  $\leq 3$  GHz and  $\geq 10.0$  cm with  $\leq \pm 0.5$  cm variation for measurements  $> 3$  GHz.



Figure 7. Body-Position



## 6. SAR Testing with RF Transmitters

### 6.1 SAR Testing with GPRS/EGPRS Transmitters

Configure the basestation to support GMSK and 8PSK call respectively, and set timeslot transmission for GMSK GPRS and 8PSK EDGE. Measure and record power outputs for both modulations, that test is applicable.

### 6.2 SAR Testing with WCDMA Transmitters

The following tests were completed according to the test requirements outlined in section 5.2 of the 3GPP TS34.121-1 specification. The DUT supports power Class 3, which has a nominal maximum output power of 24 dBm (+1.7/-3.7).

- Step 1: set a Test Mode 1 loop back with a 12.2kbps Reference Measurement Channel (RMC).
- Step 2: set and send continuously up power control commands to the device.
- Step 3: measure the power at the device antenna connector using the power meter with average detector and test SAR

### 6.3 SAR Testing with HSDPA Transmitters

#### HSDPA Date Devices setup for SAR Measurement

HSDPA should be configured according to the UE category of a test device. The number of HS-DSCH/HS-PDSCHs, HARQ processes, minimum inter-TTI interval, transport block sizes and RV coding sequence are defined by the H-set. To maintain a consistent test configuration and stable transmission conditions, QPSK is used in the H-set for SAR testing. HS-DPCCH should be configured with a CQI feedback cycle of 4 ms with a CQI repetition factor of 2 to maintain a constant rate of active CQI slots. DPCCH and DPDCH gain factors( $\beta_c$ ,  $\beta_d$ ), and HS-DPCCH power offset parameters ( $\Delta_{ACK}$ ,  $\Delta_{NACK}$ ,  $\Delta_{CQI}$ ) should be set according to values indicated in the Table below. The CQI value is determined by the UE category, transport block size, number of HS-PDSCHs and modulation used in the H-set.

Setup for Release 5 HSDPA							
Sub-test	$\beta_c$	$\beta_d$	$\beta_d$ (SF)	$\beta_c/\beta_d$	$\beta_{hs}^{(1,2)}$	CM <sup>(3)</sup> (dB)	MRP <sup>(3)</sup> (dB)
1	2/15	15/15	64	2/15	4/15	0.0	0.0
2	12/15(4)	15/15(4)	64	12/15(4)	24/15	1.0	0.0
3	15/15	8/15	64	15/8	30/15	1.5	0.5
4	15/15	4/15	64	15/4	30/15	1.5	0.5

Note

1.  $\Delta_{ACK}$ ,  $\Delta_{NACK}$  and  $\Delta_{CQI} = 8 \Leftrightarrow A_{hs} = \beta_{hs}/\beta_c = 30/15 \Leftrightarrow \beta_{hs} = 30/15 * \beta_c$
2. For the HS-DPCCH power mask requirement test in clause 5.2C, 5.7A, and the Error Vector Magnitude(EVM) with HS-DPCCH test in clause 5.13.1A and HSDPA EVM with phase discontinuity in clause 5.13.1AA,  $\Delta_{ACK}$  and  $\Delta_{NACK} = 30/15$  with  $\beta_{hs} = 30/15 * \beta_c$  and  $\Delta_{CQI} = 24/15$  with  $\beta_{hs} = 24/15 * \beta_c$
3. CM = 1 for  $\beta_c/\beta_d = 12/15$ ,  $\beta_{hs}/\beta_c = 24/15$ . For all other combinations of DPDCH, DPCCH and HS-DPCCH the MPR is based on the relative CM difference. This is applicable for only UEs that support HSDPA in release 6 and later releases.
4. For subtest 2 the  $\beta_c/\beta_d$  ratio of 12/15 for the TFC during the measurement period (TF1, TF0) is achieved by setting the signaled gain factors for the reference TFC (TF1, TF1) to  $\beta_c = 11/15$  and  $\beta_d = 15/15$ .



### **HSPA Data Devices setup for SAR Measurement.**

The following procedures are applicable to HSPA (HSUPA/HSDPA) data devices operating under 3GPP Release 6. Body exposure conditions generally apply to these devices, including handsets and data modems operating in various electronic devices. HSUPA operates in conjunction with WCDMA and HSDPA. SAR is initially measured in WCDMA test configurations without HSPA. The default test configuration is to establish a radio link between the DUT and a communication test set to configure a 12.2 kbps RMC (reference measurement channel) in Test Loop Mode 1. SAR for HSPA is selectively measured with HS-DPCCH, EDPCCH and E-DPDCH, all enabled, along with a 12.2 kbps RMC using the highest SAR configuration in WCDMA with 12.2 kbps RMC only. An FRC is configured according to HSDPCCH Sub-test 1 using H-set 1 and QPSK. HSPA is configured according to E-DCH Subtest 5 requirements. SAR for other HSPA sub-test configurations is also confirmed selectively according to output power, exposure conditions and E-DCH UE Category. Maximum output power is verified according to procedures in applicable versions of 3GPP TS 34.121 and SAR must be measured according to these maximum output conditions. The UE Categories for HSDPCCH and HSPA should be clearly identified in the SAR report. The following procedures are applicable only if Maximum Power Reduction (MPR) is implemented according to Cubic Metric (CM) requirements.

When voice transmission and head exposure conditions are applicable to a WCDMA/HSPA data device, head exposure is measured according to the 'Head SAR Measurements' procedures in the 'WCDMA Handsets' section of this document. SAR for body exposure configurations are measured according to the 'Body SAR Measurements' procedures in the 'WCDMA Handsets' section of this document. In addition, body SAR is also measured for HSPA when the maximum average output of each RF channel with HSPA active is at least ¼ dB higher than that measured without HSPA using 12.2 kbps RMC or the maximum SAR for 12.2 kbps RMC is above 75% of the SAR limit. Body SAR for HSPA is measured with E-DCH Sub-test 5, using H-Set 1 and QPSK for FRC and a 12.2 kbps RMC configured in Test Loop Mode 1 with power control algorithm 2, according to the highest body SAR configuration in 12.2 kbps RMC without HSPA. When VOIP is applicable for head exposure, SAR is not required when the maximum output of each RF channel with HSPA is less than ¼ dB higher than that measured using 12.2 kbps RMC; otherwise, the same HSPA configuration used for body measurements should be used to test for head exposure.

Due to inner loop power control requirements in HSPA, a commercial communication test set should be used for the output power and SAR tests. The 12.2 kbps RMC, FRC H-set 1 and E-DCH configurations for HSPA should be configured according to the  $\beta$  values indicated below as well as other applicable procedures described in the 'WCDMA Handset' and 'Release 5 HSDPA Data Devices' sections of this document.



The highest body SAR measured in Antenna Extended & Retracted configurations on a channel in 12.2 kbps RMC. The possible channels are the High, Middle & Low channel. Contact the FCC Laboratory for test and approval requirements if the maximum output power measured in E-DCH Sub-test 2 - 4 is higher than Sub-test 5.

Setup for Release 6 HSPA / Release 7 HSPA+													
Sub-test	$\beta_c$	$\beta_d$	$\beta_d$ (SF)	$\beta_c/\beta_d$	$\beta_{hs}^{(1)}$	$\beta_{ec}$	$\beta_{ed}$	Bed (SF)	Bed (codes)	CM <sup>(2)</sup> (dB)	MPR (dB)	AG <sup>(4)</sup> Index	E-TFCI
1	11/15 <sup>(3)</sup>	15/15 <sup>(3)</sup>	64	11/15 <sup>(3)</sup>	22/15	209/225	1039/225	4	1	1.0	0.0	20	75
2	6/15	15/15	64	6/15	12/15	12/15	94/75	4	1	3.0	2.0	12	67
3	15/15	9/15	64	15/9	30/15	30/15	$\beta_{ed1}: 47/15$ $\beta_{ed2}: 47/15$	4	2	2.0	1.0	15	92
4	2/15	15/15	64	2/15	4/15	2/15	56/75	4	1	3.0	2.0	17	71
5	15/15 <sup>(4)</sup>	15/15 <sup>(4)</sup>	64	15/15 <sup>(4)</sup>	30/15	24/15	134/15	4	1	1.0	0.0	21	81

Note

- $\Delta_{ACK}, \Delta_{NACK}$  and  $\Delta_{CQI} = 8 \Leftrightarrow A_{hs} = \beta_{hs}/\beta_c = 30/15 \Leftrightarrow \beta_{hs} = 30/15 * \beta_c$ .
- CM = 1 for  $\beta_c/\beta_d = 12/15, \beta_{hs}/\beta_c = 24/15$ . For all other combinations of DPDCH, DPCCH, HS-DPCCH, E-DPDCH and E-DPCCH the MPR is based on the relative CM difference.
- For subtest 1 the  $\beta_c/\beta_d$  ratio of 11/15 for the TFC during the measurement period (TF1, TF0) is achieved by setting the signaled gain factors for the reference TFC (TF1, TF1) to  $\beta_c = 10/15$  and  $\beta_d = 15/15$ .
- For subtest 5 the  $\beta_c/\beta_d$  ratio of 15/15 for the TFC during the measurement period (TF1, TF0) is achieved by setting the signaled gain factors for the reference TFC (TF1, TF1) to  $\beta_c = 14/15$  and  $\beta_d = 15/15$ .
- Testing UE using E-DPDCH Physical Layer category 1 Sub-test 3 is not required according to TS 25.306 Table 5.1g.
- $\beta_{ed}$  can not be set directly; it is set by Absolute Grant Value.



## 6.4 SAR Testing with 802.11 Transmitters

SAR test reduction for 802.11 Wi-Fi transmission mode configurations are considered separately for DSSS and OFDM. An initial test position is determined to reduce the number of tests required for certain exposure configurations with multiple test positions. An initial test configuration is determined for each frequency band and aggregated band according to maximum output power, channel bandwidth, wireless mode configurations and other operating parameters to streamline the measurement requirements. For 2.4 GHz DSSS, either the initial test position or DSSS procedure is applied to reduce the number of SAR tests; these are mutually exclusive. For OFDM, an initial test position is only applicable to next to the ear, UMPC mini-tablet and hotspot mode configurations, which is tested using the initial test configuration to facilitate test reduction. For other exposure conditions with a fixed test position, SAR test reduction is determined using only the initial test configuration.

The multiple test positions require SAR measurements in head, hotspot mode or UMPC mini-tablet configurations may be reduced according to the highest reported SAR determined using the initial test position(s) by applying the DSSS or OFDM SAR measurement procedures in the required wireless mode test configuration(s). The initial test position(s) is measured using the highest measured maximum output power channel in the required wireless mode test configuration(s). When the reported SAR for the initial test position is:

- $\leq 0.4$  W/kg, further SAR measurement is not required for the other test positions in that exposure configuration and wireless mode combination within the frequency band or aggregated band. DSSS and OFDM configurations are considered separately according to the required SAR procedures.
- $> 0.4$  W/kg, SAR is repeated using the same wireless mode test configuration tested in the initial test position to measure the subsequent next closet/smallest test separation distance and maximum coupling test position, on the highest maximum output power channel, until the reported SAR is  $\leq 0.8$  W/kg or all required test positions are tested.
  - For subsequent test positions with equivalent test separation distance or when exposure is dominated by coupling conditions, the position for maximum coupling condition should be tested.
  - When it is unclear, all equivalent conditions must be tested.
- For all positions/configurations tested using the initial test position and subsequent test positions, when the reported SAR is  $> 0.8$  W/kg, measure the SAR for these positions/configurations on the subsequent next highest measured output power channel(s) until the reported SAR is  $\leq 1.2$  W/kg or all required test channels are considered.
  - The additional power measurements required for this step should be limited to those necessary for identifying subsequent highest output power channels to apply the test reduction.
- When the specified maximum output power is the same for both UNII 1 and UNII 2A, begin SAR measurements in UNII 2A with the channel with the highest measured output power. If the reported SAR for UNII 2A is  $\leq 1.2$  W/kg, SAR is not required for UNII 1; otherwise treat the remaining bands separately and test them independently for SAR.
- When the specified maximum output power is different between UNII 1 and UNII 2A, begin SAR with the band that has the higher specified maximum output. If the highest reported SAR for the band with the highest specified power is  $\leq 1.2$  W/kg, testing for the band with the lower specified output power is not required; otherwise test the remaining bands independently for SAR.

To determine the initial test position, Area Scans were performed to determine the position with the Maximum Value of SAR (measured). The position that produced the highest Maximum Value of SAR is considered the worst case position; thus used as the initial test position.



## 6.5 Conducted Power

Band	Modulation	Data Rate	CH	Frequency (MHz)	Average Power (dBm)			
					Time Average	Burst Average		
GPRS 850 Multi Class :12 Max Up:4 Max Down:4 Sum:5	GMSK	4Down1Up Duty factor 1/8	Lowest	824.2	22.80	31.83		
			Middle	836.6	22.79	31.82		
			Highest	848.8	22.77	31.80		
		3Down2Up Duty factor 2/8	Lowest	824.2	24.25	30.27		
			Middle	836.6	24.24	30.26		
			Highest	848.8	24.22	30.24		
		2Down3Up Duty factor 3/8	Lowest	824.2	24.15	28.41		
			Middle	836.6	24.14	28.40		
			Highest	848.8	24.12	28.38		
		1Down4Up Duty factor 4/8	Lowest	824.2	23.63	26.64		
			Middle	836.6	23.62	26.63		
			Highest	848.8	23.60	26.61		
		EGPRS 850 Multi Class :12 Max Up:4 Max Down:4 Sum:5	8PSK	4Down1Up Duty factor 1/8	Lowest	824.2	17.56	26.59
					Middle	836.6	17.51	26.54
					Highest	848.8	17.44	26.47
3Down2Up Duty factor 2/8	Lowest			824.2	18.65	24.67		
	Middle			836.6	18.60	24.62		
	Highest			848.8	18.53	24.55		
2Down3Up Duty factor 3/8	Lowest			824.2	18.43	22.69		
	Middle			836.6	18.38	22.64		
	Highest			848.8	18.31	22.57		
1Down4Up Duty factor 4/8	Lowest			824.2	18.12	21.13		
	Middle			836.6	18.07	21.08		
	Highest			848.8	18.00	21.01		

Note: 1. Time Average power slot duty cycle factor calculate:

1up: Average burst power+10\*LOG(1/8)

2up: Average burst power+10\*LOG(2/8)

3up: Average burst power+10\*LOG(3/8)

4up: Average burst power+10\*LOG(4/8)



Band	Modulation	Data Rate	CH	Frequency (MHz)	Average Power (dBm)	
					Time Average	Burst Average
GPRS 1900 Multi Class :12 Max Up:4 Max Down:4 Sum:5	GMSK	4Down1Up Duty factor 1/8	Lowest	1850.2	19.96	28.99
			Middle	1880.0	19.88	28.91
			Highest	1909.8	19.85	28.88
		3Down2Up Duty factor 2/8	Lowest	1850.2	21.38	27.40
			Middle	1880.0	21.30	27.32
			Highest	1909.8	21.27	27.29
		2Down3Up Duty factor 3/8	Lowest	1850.2	21.31	25.57
			Middle	1880.0	21.23	25.49
			Highest	1909.8	21.20	25.46
		1Down4Up Duty factor 4/8	Lowest	1850.2	20.77	23.78
			Middle	1880.0	20.69	23.70
			Highest	1909.8	20.66	23.67
EGPRS 1900 Multi Class :12 Max Up:4 Max Down:4 Sum:5	8PSK	4Down1Up Duty factor 1/8	Lowest	1850.2	16.51	25.54
			Middle	1880.0	16.43	25.46
			Highest	1909.8	16.40	25.43
		3Down2Up Duty factor 2/8	Lowest	1850.2	17.93	23.95
			Middle	1880.0	17.85	23.87
			Highest	1909.8	17.82	23.84
		2Down3Up Duty factor 3/8	Lowest	1850.2	17.86	22.12
			Middle	1880.0	17.78	22.04
			Highest	1909.8	17.75	22.01
		1Down4Up Duty factor 4/8	Lowest	1850.2	17.32	20.33
			Middle	1880.0	17.24	20.25
			Highest	1909.8	17.21	20.22

Note: 1. Time Average power slot duty cycle factor calculate:

- 1up: Average burst power+10\*LOG(1/8)
- 2up: Average burst power+10\*LOG(2/8)
- 3up: Average burst power+10\*LOG(3/8)
- 4up: Average burst power+10\*LOG(4/8)





Band	Modulation	Sub-test	CH	Frequency (MHz)	Average Power (dBm)
WCDMA Band II	RMC12.2K	---	Lowest	1852.4	21.95
			Middle	1880.0	22.01
			Highest	1907.6	22.04
HSDPA Band II	QPSK	1	Lowest	1852.4	21.33
			Middle	1880.0	21.40
			Highest	1907.6	21.45
		2	Lowest	1852.4	21.24
			Middle	1880.0	21.32
			Highest	1907.6	21.39
		3	Lowest	1852.4	20.76
			Middle	1880.0	20.84
			Highest	1907.6	20.92
		4	Lowest	1852.4	20.70
			Middle	1880.0	20.79
			Highest	1907.6	20.87
HSUPA Band II	QPSK	1	Lowest	1852.4	20.85
			Middle	1880.0	20.95
			Highest	1907.6	21.02
		2	Lowest	1852.4	18.79
			Middle	1880.0	18.90
			Highest	1907.6	19.00
		3	Lowest	1852.4	19.76
			Middle	1880.0	19.89
			Highest	1907.6	19.99
		4	Lowest	1852.4	18.73
			Middle	1880.0	18.86
			Highest	1907.6	18.95
		5	Lowest	1852.4	20.73
			Middle	1880.0	20.86
			Highest	1907.6	20.96



Band	Modulation	Sub-test	CH	Frequency (MHz)	Average Power (dBm)
WCDMA Band V	RMC12.2K	---	Lowest	826.4	21.72
			Middle	836.6	22.15
			Highest	846.6	22.18
HSDPA Band V	QPSK	1	Lowest	826.4	21.13
			Middle	836.6	21.59
			Highest	846.6	21.65
		2	Lowest	826.4	21.04
			Middle	836.6	21.51
			Highest	846.6	21.60
		3	Lowest	826.4	20.56
			Middle	836.6	21.03
			Highest	846.6	21.12
		4	Lowest	826.4	20.48
			Middle	836.6	20.96
			Highest	846.6	21.07
HSUPA Band V	QPSK	1	Lowest	826.4	20.63
			Middle	836.6	21.11
			Highest	846.6	21.22
		2	Lowest	826.4	18.54
			Middle	836.6	19.03
			Highest	846.6	19.19
		3	Lowest	826.4	19.49
			Middle	836.6	20.00
			Highest	846.6	20.15
		4	Lowest	826.4	18.47
			Middle	836.6	18.97
			Highest	846.6	19.13
		5	Lowest	826.4	20.47
			Middle	836.6	20.99
			Highest	846.6	21.15



Band	Data Rate	CH	Frequency (MHz)	Average Power (dBm)
IEEE 802.11b	1M	1	2412.0	15.51
		6	2437.0	15.31
		11	2462.0	15.20
	2M	6	2437.0	15.28
	5.5M	6	2437.0	15.25
	11M	6	2437.0	15.21
IEEE 802.11g	6M	1	2412.0	11.05
		6	2437.0	10.83
		11	2462.0	10.44
	9M	6	2437.0	10.81
	12M	6	2437.0	10.79
	18M	6	2437.0	10.78
	24M	6	2437.0	10.75
	36M	6	2437.0	10.72
	48M	6	2437.0	10.70
	54M	6	2437.0	10.67
IEEE 802.11n 2.4 GHz 20MHz	6.5M	1	2412.0	11.25
		6	2437.0	11.17
		11	2462.0	10.91
	13M	6	2437.0	11.09
	19.5M	6	2437.0	10.97
	26M	6	2437.0	10.66
	39M	6	2437.0	9.84
	52M	6	2437.0	9.80
	58.5M	6	2437.0	9.75
	65M	6	2437.0	9.59



Band	Data Rate	CH	Frequency (MHz)	Average Power (dBm)
IEEE 802.11a	6M	36	5180.0	8.77
		40	5200.0	8.48
		44	5220.0	8.05
		48	5240.0	8.50
		149	5745.0	10.03
		153	5765.0	9.75
		157	5785.0	9.55
		161	5805.0	9.08
	165	5825.0	9.06	
	54M	36	5180.0	8.69
		40	5200.0	8.45
		44	5220.0	7.96
		48	5240.0	8.47
		149	5745.0	9.96
		153	5765.0	9.70
		157	5785.0	9.49
161		5805.0	9.02	
165	5825.0	8.99		
IEEE 802.11n 5GHz 20MHz	6.5M	36	5180.0	9.19
		40	5200.0	8.96
		44	5220.0	9.17
		48	5240.0	9.08
		149	5745.0	8.17
		153	5765.0	8.20
		157	5785.0	7.68
		161	5805.0	7.60
	165	5825.0	7.23	
	65M	36	5180.0	9.11
		40	5200.0	8.91
		44	5220.0	9.13
		48	5240.0	9.05
		149	5745.0	8.09
		153	5765.0	8.11
		157	5785.0	7.62
161		5805.0	7.55	
165	5825.0	7.15		



Band	CH	Frequency (MHz)	Packet Type	Average Power (dBm)
Bluetooth BR GFSK	0	2402	DH5	1.33
	39	2441	DH5	2.27
	78	2480	DH5	2.78
Bluetooth EDR $\pi/4$ -DQPSK	0	2402	2DH5	1.46
	39	2441	2DH5	2.40
	78	2480	2DH5	2.93
Bluetooth EDR 8DPSK	0	2402	3DH5	1.49
	39	2441	3DH5	2.43
	78	2480	3DH5	2.95

## 6.6 Antenna location

Antenna-User					
Distance of WWAN_Antenna to edge		Distance of WLAN_Antenna to edge		Distance of Bluetooth_Antenna to edge	
WWAN_Antenna to Side 1	18mm	WLAN_Antenna to Side 1	21mm	Bluetooth_Antenna to Side 1	16mm
WWAN_Antenna to Side 2	11mm	WLAN_Antenna to Side 2	12mm	Bluetooth_Antenna to Side 2	20mm
WWAN_Antenna to Side 3	92mm	WLAN_Antenna to Side 3	44mm	Bluetooth_Antenna to Side 3	13mm
WWAN_Antenna to Side 4	14mm	WLAN_Antenna to Side 4	84mm	Bluetooth_Antenna to Side 4	136mm
WWAN_Antenna to Side 5	62mm	WLAN_Antenna to Side 5	16mm	Bluetooth_Antenna to Side 5	72mm
WWAN_Antenna to Side 6	8mm	WLAN_Antenna to Side 6	37mm	Bluetooth_Antenna to Side 6	6mm
Antenna-Antenna					
Antenna account			Distance (mm)		
WWAN to WLAN_Antenna			26mm		
WWAN to Bluetooth_Antenna			63mm		

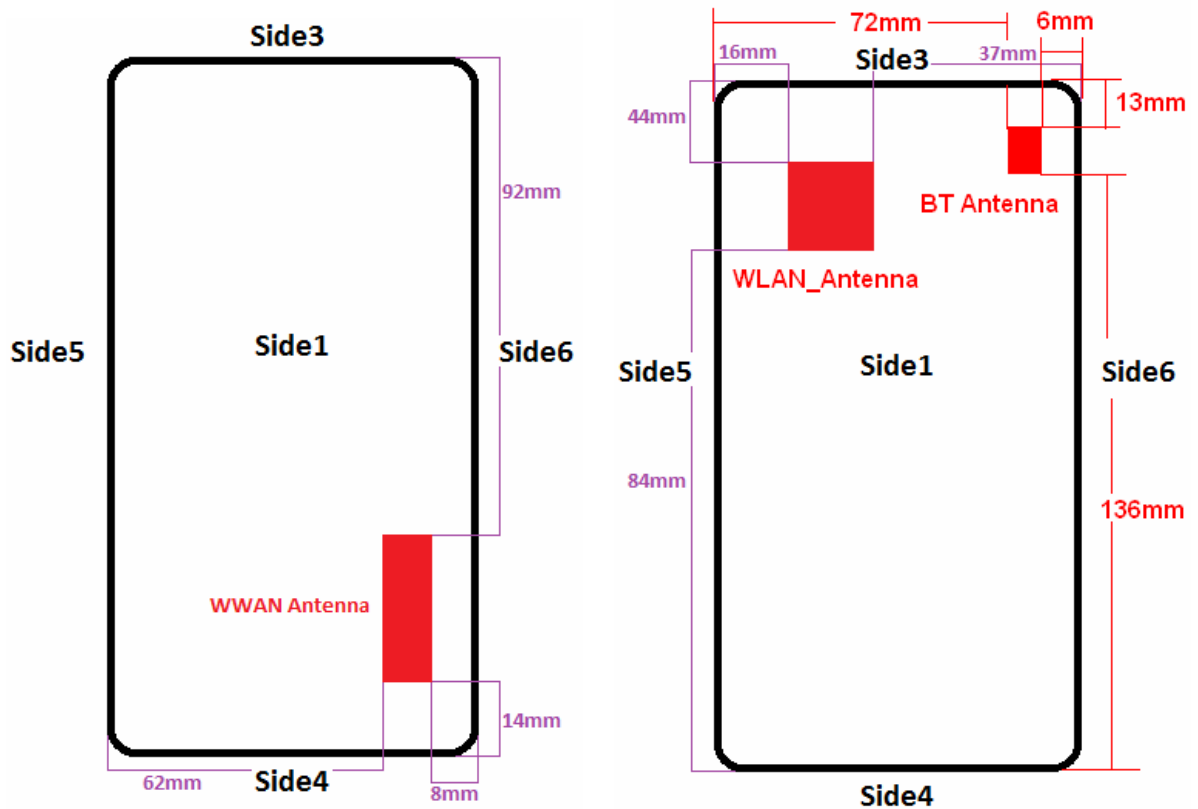

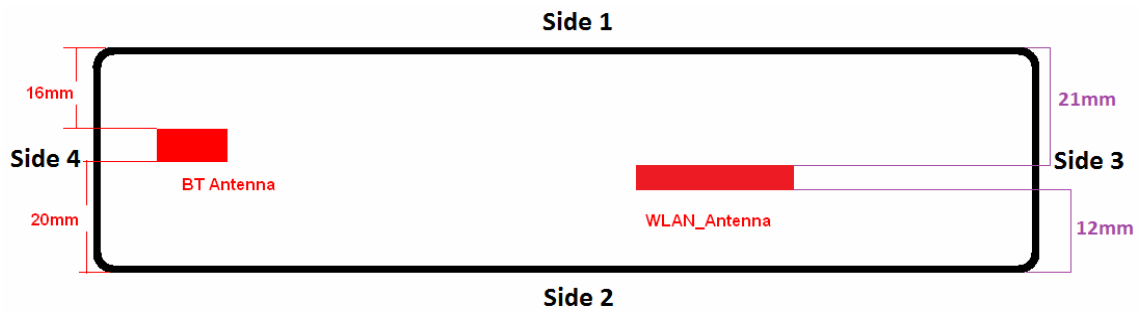
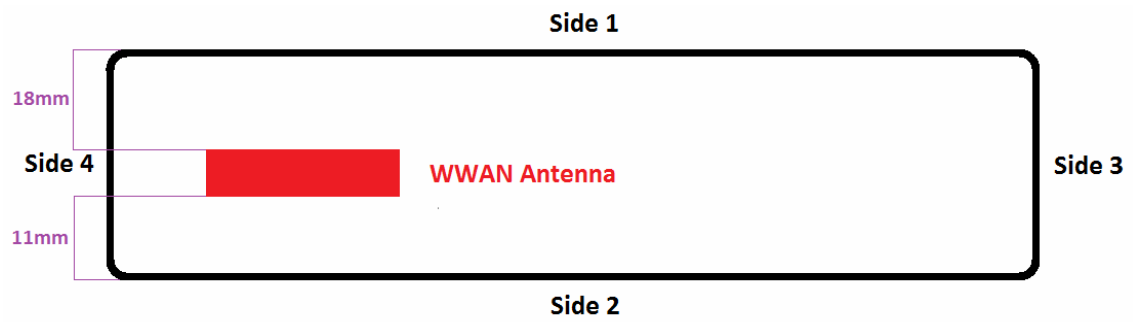
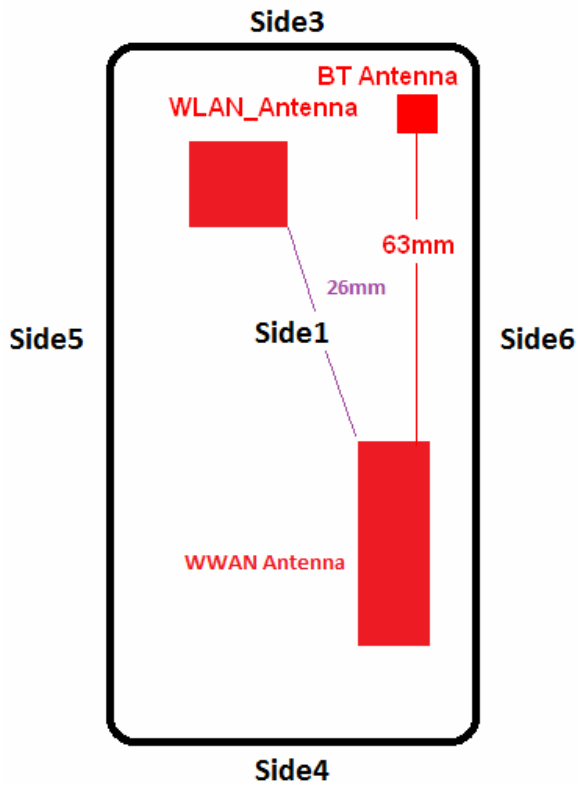



## 6.7 Stand-alone SAR Evaluate

Transmitter and antenna implementation as below:

Band	WWAN Antenna	WLAN Antenna	Bluetooth Antenna
WWAN	V	-	-
WLAN	-	V	-
Bluetooth	-	-	V

Stand-alone transmission configurations as below:

Band	Side 1	Side 2	Side 3	Side 4	Side 5	Side 6
GPRS/EGPRS 850	V	V	-	V	V	V
GPRS/EGPRS 1900	V	V	-	V	-	V
WCDMA/HSDPA/HSUPA Band II	V	V	-	V	-	V
WCDMA/HSDPA/HSUPA Band V	V	V	-	V	-	V
IEEE 802.11b	-	V	-	-	V	-
IEEE 802.11g	-	-	-	-	-	-
IEEE 802.11n 2.4GHz 20MHz	-	-	-	-	-	-
IEEE 802.11a	-	-	-	-	-	-
IEEE 802.11n 5GHz 20MHz	-	-	-	-	-	-
Bluetooth BR/EDR	-	-	-	-	-	-

Note: 1. Stand-alone SAR is required when SAR must be measured for all sides and surfaces with a transmitting antenna located within 25 mm from that surface or edge, detail refer antenna location.

2. The "-" on behalf of Stand-alone SAR is not required (Refer to KDB447498 D01 v05r02 4.3.1 for the Standalone SAR test exclusion considerations)





≤ 50 mm										
Antenna	Side	Band	Channel	Power (dBm)	Frequency (GHz)	Distance (mm)	Power (mW)	Result	Limit	Exclusion Considerations SAR <sup>19</sup>
WWAN Antenna	1	GPRS 850	190	24.5	0.837	18	282	14.3	3	SAR is required
		GPRS 1900	661	21.5	1.880	18	141	10.7	3	SAR is required
		WCDMA Band II	9400	22.5	1.880	18	178	13.6	3	SAR is required
		WCDMA Band V	4183	23.0	0.837	18	200	10.2	3	SAR is required
WLAN Antenna		IEEE 802.11b	1	16.0	2.412	21	40	3.0	3	SAR is not required
		IEEE 802.11g	1	12.0	2.412	21	16	1.2	3	SAR is not required
		IEEE 802.11n 2.4GHz 20MHz	1	11.5	2.412	21	14	1.0	3	SAR is not required
		IEEE 802.11a	36	9.0	5.180	21	8	0.9	3	SAR is not required
		IEEE 802.11a	149	11.0	5.745	21	13	1.5	3	SAR is not required
		IEEE 802.11n 5GHz 20MHz	36	10.0	5.180	21	10	1.1	3	SAR is not required
		IEEE 802.11n 5GHz 20MHz	153	9.0	5.765	21	8	0.9	3	SAR is not required
Bluetooth Antenna	Bluetooth BR/EDR	78	3.0	2.480	16	2	0.2	3	SAR is not required	
WWAN Antenna	2	GPRS 850	190	24.5	0.837	11	282	23.4	3	SAR is required
		GPRS 1900	661	21.5	1.880	11	141	17.6	3	SAR is required
		WCDMA Band II	9400	22.5	1.880	11	178	22.2	3	SAR is required
		WCDMA Band V	4183	23.0	0.837	11	200	16.6	3	SAR is required
WLAN Antenna		IEEE 802.11b	1	16.0	2.412	12	40	5.2	3	SAR is required
		IEEE 802.11g	1	12.0	2.412	12	16	2.1	3	SAR is not required
		IEEE 802.11n 2.4GHz 20MHz	1	11.5	2.412	12	14	1.8	3	SAR is not required
		IEEE 802.11a	36	9.0	5.180	12	8	1.5	3	SAR is not required
		IEEE 802.11a	149	11.0	5.745	12	13	2.6	3	SAR is not required
		IEEE 802.11n 5GHz 20MHz	36	10.0	5.180	12	10	1.9	3	SAR is not required
		IEEE 802.11n 5GHz 20MHz	153	9.0	5.765	12	8	1.6	3	SAR is not required
Bluetooth Antenna	Bluetooth BR/EDR	78	3.0	2.480	20	2	0.2	3	SAR is not required	



≤ 50 mm										
Antenna	Side	Band	Channel	Power (dBm)	Frequency (GHz)	Distance (mm)	Power (mW)	Result	Limit	Exclusion Considerations SAR <sup>19</sup>
WLAN Bluetooth Antenna	3	IEEE 802.11b	1	16.0	2.412	44	40	1.4	3	SAR is not required
WLAN Antenna		IEEE 802.11g	1	12.0	2.412	44	16	0.6	3	SAR is not required
		IEEE 802.11n 2.4GHz 20MHz	1	11.5	2.412	44	14	0.5	3	SAR is not required
		IEEE 802.11a	36	9.0	5.180	44	8	0.4	3	SAR is not required
		IEEE 802.11a	149	11.0	5.745	44	13	0.7	3	SAR is not required
		IEEE 802.11n 5GHz 20MHz	36	10.0	5.180	44	10	0.5	3	SAR is not required
		IEEE 802.11n 5GHz 20MHz	153	9.0	5.765	44	8	0.4	3	SAR is not required
Bluetooth Antenna		Bluetooth BR/EDR	78	3.0	2.480	13	2	0.2	3	SAR is not required
WWAN Antenna	4	GPRS 850	190	24.5	0.837	14	282	18.4	3	SAR is required
		GPRS 1900	661	21.5	1.880	14	141	13.8	3	SAR is required
		WCDMA Band II	9400	22.5	1.880	14	178	17.4	3	SAR is required
		WCDMA Band V	4183	23.0	0.837	14	200	13.1	3	SAR is required
WLAN Antenna	5	IEEE 802.11b	1	16.0	2.412	16	40	3.9	3	SAR is required
		IEEE 802.11g	1	12.0	2.412	16	16	1.6	3	SAR is not required
		IEEE 802.11n 2.4GHz 20MHz	1	11.5	2.412	16	14	1.4	3	SAR is not required
		IEEE 802.11a	36	9.0	5.180	16	8	1.1	3	SAR is not required
		IEEE 802.11a	149	11.0	5.745	16	13	1.9	3	SAR is not required
		IEEE 802.11n 5GHz 20MHz	36	10.0	5.180	16	10	1.4	3	SAR is not required
		IEEE 802.11n 5GHz 20MHz	153	9.0	5.765	16	8	1.2	3	SAR is not required



≤ 50 mm										
Antenna	Side	Band	Channel	Power (dBm)	Frequency (GHz)	Distance (mm)	Power (mW)	Result	Limit	Exclusion Considerations SAR <sup>19</sup>
WWAN Antenna	6	GPRS 850	190	24.5	0.837	8	282	32.2	3	SAR is required
		GPRS 1900	661	21.5	1.880	8	141	24.2	3	SAR is required
		WCDMA Band II	9400	22.5	1.880	8	178	30.5	3	SAR is required
		WCDMA Band V	4183	23.0	0.837	8	200	22.9	3	SAR is required
WLAN Antenna		IEEE 802.11b	1	16.0	2.412	37	40	1.7	3	SAR is not required
		IEEE 802.11g	1	12.0	2.412	37	16	0.7	3	SAR is not required
		IEEE 802.11n 2.4GHz 20MHz	1	11.5	2.412	37	14	0.6	3	SAR is not required
		IEEE 802.11a	36	9.0	5.180	37	8	0.5	3	SAR is not required
		IEEE 802.11a	149	11.0	5.745	37	13	0.8	3	SAR is not required
		IEEE 802.11n 5GHz 20MHz	36	10.0	5.180	37	10	0.6	3	SAR is not required
		IEEE 802.11n 5GHz 20MHz	153	9.0	5.765	37	8	0.5	3	SAR is not required
		Bluetooth Antenna	Bluetooth BR/EDR	78	3.0	2.480	37	2	0.1	3

Note: The test reduction for distance less than 50mm. Use the max power to make sure minimum distance by evaluated for SAR testing.



> 50 mm <200mm									
Antenna	Side	Band	Channel	Power (dBm)	Frequency (GHz)	Distance (mm)	Power (mW)	Power Thresholds SAR <sup>19</sup> (mW)	Exclusion Considerations SAR <sup>19</sup>
WWAN Antenna	3	GPRS 850	190	24.5	0.837	92	282	398	SAR is not required
		GPRS 1900	661	21.5	1.880	92	141	529	SAR is not required
		WCDMA Band II	9400	22.5	1.880	92	178	529	SAR is not required
		WCDMA Band V	4183	23.0	0.837	92	200	398	SAR is not required
WLAN Bluetooth Antenna	4	IEEE 802.11b	1	16.0	2.412	84	40	437	SAR is not required
		IEEE 802.11g	1	12.0	2.412	84	16	437	SAR is not required
		IEEE 802.11n 2.4GHz 20MHz	1	11.5	2.412	84	14	437	SAR is not required
		IEEE 802.11a	36	9.0	5.180	84	8	406	SAR is not required
		IEEE 802.11a	149	11.0	5.745	84	13	403	SAR is not required
		IEEE 802.11n 5GHz 20MHz	36	10.0	5.180	84	10	406	SAR is not required
		IEEE 802.11n 5GHz 20MHz	153	9.0	5.765	84	8	402	SAR is not required
Bluetooth Antenna		Bluetooth BR/EDR	78	3.0	2.480	84	2	435	SAR is not required
WWAN Antenna	5	GPRS 850	190	24.5	0.837	62	282	231	SAR is required
		GPRS 1900	661	21.5	1.880	62	141	229	SAR is not required
		WCDMA Band II	9400	22.5	1.880	62	178	229	SAR is not required
		WCDMA Band V	4183	23.0	0.837	62	200	231	SAR is not required
Bluetooth Antenna		Bluetooth BR/EDR	78	3.0	2.480	136	2	955	SAR is not required

Note: 1.The test reduction for distance more than 50mm. Use the max power to make sure minimum distance by evaluated for SAR testing.

2.For antenna to edge more than 50 mm that sar test is not required when the minimun distance(worst case) evaluated by results of above.



## 6.8 Simultaneous Transmitting Evaluate

Simultaneous transmission configurations as below:

Condition	Side	Frequency Band		
		WWAN	WLAN	Bluetooth
1	1	V	-	V
2	2	V	-	V
3	3	V	-	V
4	4	V	-	V
5	5	V	-	V
6	6	V	-	V

Condition	Side	Frequency Band		
		WWAN	WLAN	Bluetooth
1	1	-	V	V
2	2	-	V	V
3	3	-	V	V
4	4	-	V	V
5	5	-	V	V
6	6	-	V	V



### 6.8.1 Estimated SAR

≤ 50 mm								
Antenna	Side	Band	Channel	Power-Tune up (dBm)	Frequency (GHz)	Distance (mm)	Power (mW)	Estimated SAR <sup>19</sup> (W/Kg)
WLAN Antenna	1	IEEE 802.11b	1	16.0	2.412	21	40	0.39
		IEEE 802.11g	1	12.0	2.412	21	16	0.16
		IEEE 802.11n 2.4GHz 20MHz	1	11.5	2.412	21	14	0.14
		IEEE 802.11a	36	9.0	5.180	21	8	0.12
		IEEE 802.11a	149	11.0	5.745	21	13	0.20
		IEEE 802.11n 5GHz 20MHz	36	10.0	5.180	21	10	0.15
		IEEE 802.11n 5GHz 20MHz	153	9.0	5.765	21	8	0.12
Bluetooth Antenna		Bluetooth BR/EDR	78	3.0	2.480	16	2	0.03
WLAN Antenna	2	IEEE 802.11g	1	12.0	2.412	12	16	0.28
		IEEE 802.11n 2.4GHz 20MHz	1	11.5	2.412	12	14	0.24
		IEEE 802.11a	36	9.0	5.180	12	8	0.20
		IEEE 802.11a	149	11.0	5.745	12	13	0.35
		IEEE 802.11n 5GHz 20MHz	36	10.0	5.180	12	10	0.25
		IEEE 802.11n 5GHz 20MHz	153	9.0	5.765	12	8	0.21
Bluetooth Antenna		Bluetooth BR/EDR	78	3.0	2.480	20	2	0.02
WLAN Antenna	3	IEEE 802.11b	1	16.0	2.412	44	40	0.19
		IEEE 802.11g	1	12.0	2.412	44	16	0.08
		IEEE 802.11n 2.4GHz 20MHz	1	11.5	2.412	44	14	0.07
		IEEE 802.11a	36	9.0	5.180	44	8	0.06
		IEEE 802.11a	149	11.0	5.745	44	13	0.09
		IEEE 802.11n 5GHz 20MHz	36	10.0	5.180	44	10	0.07
		IEEE 802.11n 5GHz 20MHz	153	9.0	5.765	44	8	0.06
Bluetooth Antenna		Bluetooth BR/EDR	78	3.0	2.480	13	2	0.03



≤ 50 mm								
Antenna	Side	Band	Channel	Power-Tune up (dBm)	Frequency (GHz)	Distance (mm)	Power (mW)	Estimated SAR <sup>19</sup> (W/Kg)
WLAN Antenna	5	IEEE 802.11g	1	12.0	2.412	16	16	0.21
		IEEE 802.11n 2.4GHz 20MHz	1	11.5	2.412	16	14	0.18
		IEEE 802.11a	36	9.0	5.180	16	8	0.15
		IEEE 802.11a	149	11.0	5.745	16	13	0.26
		IEEE 802.11n 5GHz 20MHz	36	10.0	5.180	16	10	0.19
		IEEE 802.11n 5GHz 20MHz	153	9.0	5.765	16	8	0.16
WLAN Antenna	6	IEEE 802.11b	1	16.0	2.412	37	40	0.22
		IEEE 802.11g	1	12.0	2.412	37	16	0.09
		IEEE 802.11n 2.4GHz 20MHz	1	11.5	2.412	37	14	0.08
		IEEE 802.11a	36	9.0	5.180	37	8	0.07
		IEEE 802.11a	149	11.0	5.745	37	13	0.11
		IEEE 802.11n 5GHz 20MHz	36	10.0	5.180	37	10	0.08
		IEEE 802.11n 5GHz 20MHz	153	9.0	5.765	37	8	0.07
Bluetooth Antenna		Bluetooth BR/EDR	78	3.0	2.480	6	2	0.07

> 50 mm			
Antenna	Side	Band	Estimated SAR <sup>19</sup> (W/Kg)
WWAN Antenna	3	GPRS 850	0.4
		GPRS 1900	0.4
		WCDMA Band II	0.4
		WCDMA Band V	0.4
WLAN Bluetooth Antenna	4	IEEE 802.11b	0.4
		IEEE 802.11g	0.4
		IEEE 802.11n 2.4GHz 20MHz	0.4
		IEEE 802.11a	0.4
		IEEE 802.11n 5GHz 20MHz	0.4
Bluetooth Antenna		Bluetooth BR/EDR	0.4
WWAN Antenna	5	GPRS 1900	0.4
		WCDMA Band II	0.4
		WCDMA Band V	0.4
Bluetooth Antenna		Bluetooth BR/EDR	0.4



### 6.8.2 Sum of 1-g SAR of all simultaneously transmitting

When the sum of 1-g SAR of all simultaneously transmitting antennas in and operating mode and exposure condition combination is within the SAR limit, SAR test exclusion applies to that simultaneous transmission configuration.

Sum of 1-g SAR of summary as below:

Phantom Position	Spacing (mm)	ASSY	WWAN Antenna		Bluetooth Antenna		$\Sigma$ SAR <sup>1g</sup> (W/kg)	Event	
			Band	SAR <sup>1g</sup> (W/kg)	Band	SAR <sup>1g</sup> (W/kg)			
Flat	Side 1	0	N/A	GPRS 850	0.42	Bluetooth BR/EDR	*0.03	0.45	<1.6
		0	N/A	GPRS 1900	0.23	Bluetooth BR/EDR	*0.03	0.26	<1.6
		0	N/A	WCDMA Band II	0.30	Bluetooth BR/EDR	*0.03	0.33	<1.6
		0	N/A	WCDMA Band V	0.59	Bluetooth BR/EDR	*0.03	0.62	<1.6
Flat	Side 2	0	N/A	GPRS 850	0.46	Bluetooth BR/EDR	*0.02	0.48	<1.6
		0	N/A	GPRS 1900	0.38	Bluetooth BR/EDR	*0.02	0.40	<1.6
		0	N/A	WCDMA Band II	0.76	Bluetooth BR/EDR	*0.02	0.78	<1.6
		0	N/A	WCDMA Band V	0.66	Bluetooth BR/EDR	*0.02	0.68	<1.6
Flat	Side 3	0	N/A	GPRS 850	**0.4	Bluetooth BR/EDR	*0.03	0.43	<1.6
		0	N/A	GPRS 1900	**0.4	Bluetooth BR/EDR	*0.03	0.43	<1.6
		0	N/A	WCDMA Band II	**0.4	Bluetooth BR/EDR	*0.03	0.43	<1.6
		0	N/A	WCDMA Band V	**0.4	Bluetooth BR/EDR	*0.03	0.43	<1.6
Flat	Side 4	0	N/A	GPRS 850	0.29	Bluetooth BR/EDR	**0.4	0.69	<1.6
		0	N/A	GPRS 1900	0.43	Bluetooth BR/EDR	**0.4	0.83	<1.6
		0	N/A	WCDMA Band II	1.03	Bluetooth BR/EDR	**0.4	1.43	<1.6
		0	N/A	WCDMA Band V	0.48	Bluetooth BR/EDR	**0.4	0.88	<1.6
Flat	Side 5	0	N/A	GPRS 850	0.24	Bluetooth BR/EDR	**0.4	0.64	<1.6
		0	N/A	GPRS 1900	**0.4	Bluetooth BR/EDR	**0.4	0.80	<1.6
		0	N/A	WCDMA Band II	**0.4	Bluetooth BR/EDR	**0.4	0.80	<1.6
		0	N/A	WCDMA Band V	**0.4	Bluetooth BR/EDR	**0.4	0.80	<1.6
Flat	Side 6	0	N/A	GPRS 850	0.49	Bluetooth BR/EDR	*0.07	0.56	<1.6
		0	N/A	GPRS 1900	0.18	Bluetooth BR/EDR	*0.07	0.25	<1.6
		0	N/A	WCDMA Band II	1.37	Bluetooth BR/EDR	*0.07	1.44	<1.6
		0	N/A	WCDMA Band V	0.54	Bluetooth BR/EDR	*0.07	0.61	<1.6





Phantom Position		Spacing (mm)	ASSY	WWAN Antenna		Bluetooth Antenna		$\Sigma$ SAR <sup>1g</sup> (W/kg)	Event
				Band	SAR <sup>1g</sup> (W/kg)	Band	SAR <sup>1g</sup> (W/kg)		
Flat	Side 1	0	N/A	IEEE 802.11b	*0.39	Bluetooth BR/EDR	*0.03	0.42	<1.6
		0	N/A	IEEE 802.11b	*0.39	Bluetooth BR/EDR	*0.03	0.42	<1.6
		0	N/A	IEEE 802.11b	*0.39	Bluetooth BR/EDR	*0.03	0.42	<1.6
		0	N/A	IEEE 802.11b	*0.39	Bluetooth BR/EDR	*0.03	0.42	<1.6
Flat	Side 2	0	N/A	IEEE 802.11b	0.02	Bluetooth BR/EDR	*0.02	0.04	<1.6
		0	N/A	IEEE 802.11b	0.02	Bluetooth BR/EDR	*0.02	0.04	<1.6
		0	N/A	IEEE 802.11b	0.02	Bluetooth BR/EDR	*0.02	0.04	<1.6
		0	N/A	IEEE 802.11b	0.02	Bluetooth BR/EDR	*0.02	0.04	<1.6
Flat	Side 3	0	N/A	IEEE 802.11b	*0.19	Bluetooth BR/EDR	*0.03	0.22	<1.6
		0	N/A	IEEE 802.11b	*0.19	Bluetooth BR/EDR	*0.03	0.22	<1.6
		0	N/A	IEEE 802.11b	*0.19	Bluetooth BR/EDR	*0.03	0.22	<1.6
		0	N/A	IEEE 802.11b	*0.19	Bluetooth BR/EDR	*0.03	0.22	<1.6
Flat	Side 4	0	N/A	IEEE 802.11b	**0.4	Bluetooth BR/EDR	**0.4	0.80	<1.6
		0	N/A	IEEE 802.11b	**0.4	Bluetooth BR/EDR	**0.4	0.80	<1.6
		0	N/A	IEEE 802.11b	**0.4	Bluetooth BR/EDR	**0.4	0.80	<1.6
		0	N/A	IEEE 802.11b	**0.4	Bluetooth BR/EDR	**0.4	0.80	<1.6
Flat	Side 5	0	N/A	IEEE 802.11b	0.15	Bluetooth BR/EDR	**0.4	0.55	<1.6
		0	N/A	IEEE 802.11b	0.15	Bluetooth BR/EDR	**0.4	0.55	<1.6
		0	N/A	IEEE 802.11b	0.15	Bluetooth BR/EDR	**0.4	0.55	<1.6
		0	N/A	IEEE 802.11b	0.15	Bluetooth BR/EDR	**0.4	0.55	<1.6
Flat	Side 6	0	N/A	IEEE 802.11b	*0.22	Bluetooth BR/EDR	*0.07	0.29	<1.6
		0	N/A	IEEE 802.11b	*0.22	Bluetooth BR/EDR	*0.07	0.29	<1.6
		0	N/A	IEEE 802.11b	*0.22	Bluetooth BR/EDR	*0.07	0.29	<1.6
		0	N/A	IEEE 802.11b	*0.22	Bluetooth BR/EDR	*0.07	0.29	<1.6

Note :1. \*=Estimated SAR

2. \*\*The Estimated SAR 0.4W/Kg , test separation distances is > 50 mm



### 6.8.3 SAR to peak location separation ratio (SPLSR)

When the sum of SAR is larger than the limit, SAR test exclusion is determined by the SAR to peak location separation ratio. The ratio is determined by  $(SAR1 + SAR2)^{1.5}/R_i$ , rounded to two decimal digits, and must be  $\leq 0.04$  for all antenna pairs in the configuration to qualify for 1-g SAR test exclusion.

**All of sum of SAR < 1.6 W/kg, therefore SPLSR is not required.**

### 6.9 SAR test reduction according to KDB

General:

- The test data reported are the worst-case SAR value with the position set in a typical configuration. Test procedures used were according to FCC, Supplement C [June 2001], IEEE1528-2013.
- All modes of operation were investigated, and worst-case results are reported.
- Tissue parameters and temperatures are listed on the SAR plots.
- Batteries are fully charged for all readings.
- When the Channel's SAR 1g of maximum conducted power is > 0.8 mW/g, low, middle and high channel are supposed to be tested.

KDB 447498:

- The test data reported are the worst-case SAR value with the position set in a typical configuration. Test procedures used were according to IEEE1528-2013.

KDB 865664:

- Repeated measurement is not required when the original highest measured SAR is < 0.80 W/kg.
- When the original highest measured SAR is  $\geq 0.80$  W/kg, repeat that measurement once.
- Perform a second repeated measurement only if the ratio of largest to smallest SAR for the original and first repeated measurements is > 1.20 or when the original or repeated measurement is  $\geq 1.45$  W/kg.
- Perform a third repeated measurement only if the original, first or second repeated measurement is  $\geq 1.5$  W/kg and the ratio of largest to smallest SAR for the original, first and second repeated measurements is > 1.20.

KDB 941225:

- In order to qualify for the above test reduction, the maximum burst-averaged output power for each mode (GMS/GPRS/EDGE) and the corresponding multi-slot class must be clearly identified in the SAR report for each frequency band. We perform worst case SAR with maximum time-average power on GMS/GPRS/EDGE mode.
- When HSDPA & (HSUPA / HSPA+ uplink with QPSK) power are not more than WCDMA 12.2K RMC 0.25dB and the SAR value of WCDMA BII/BV < 1.2 mW/g, therefore HSDPA & HSUPA / HSPA+ Stand-alone SAR is not required.

KDB 248227:

- Refer 6.4 SAR Testing with 802.11 Transmitters

## 7. System Verification and Validation

### 7.1 Symmetric Dipoles for System Verification

Construction	Symmetrical dipole with 1/4 balun enables measurement of feed point impedance with NWA matched for use near flat phantoms filled with head simulating solutions Includes distance holder and tripod adaptor Calibration Calibrated SAR value for specified position and input power at the flat phantom in head simulating solutions.
Frequency	835, 1900 and 2450 MHz
Return Loss	> 20 dB at specified verification position
Power Capability	> 100 W (f < 1GHz); > 40 W (f > 1GHz)
Options	Dipoles for other frequencies or solutions and other calibration conditions are available upon request
Dimensions	D835V2: dipole length 161 mm; overall height 340 mm D1900V2: dipole length 67.7 mm; overall height 300 mm D2450V2: dipole length 51.5 mm; overall height 300 mm

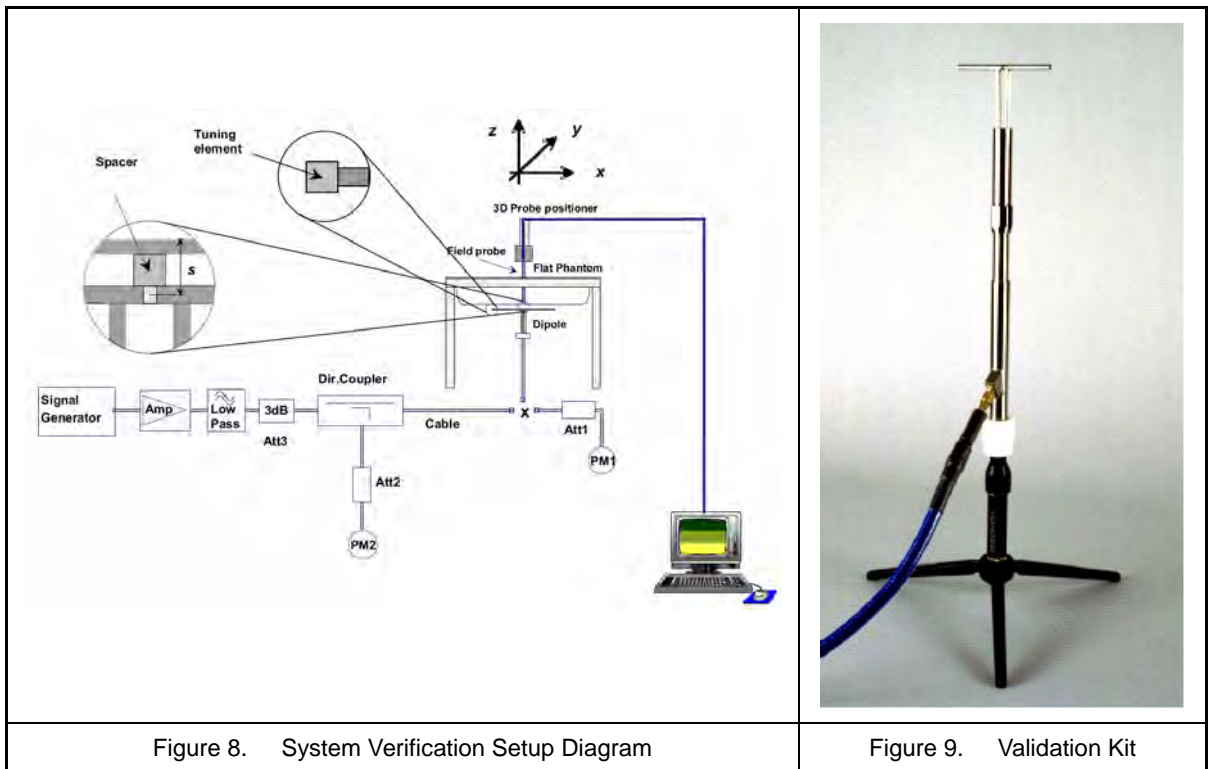



## 7.2 Liquid Parameters

Liquid Verify								
Ambient Temperature : 22 ± 2 °C ; Relative Humidity : 40 -70%								
Liquid Type	Frequency	Temp (°C)	Parameters	Target Value	Measured Value	Deviation (%)	Limit (%)	Measured Date
835MHz (Body)	820MHz	22.0	$\epsilon_r$	55.26	54.73	-0.96%	± 5	2015/10/6
			$\sigma$	0.969	0.961	-0.83%	± 5	
	835MHz	22.0	$\epsilon_r$	55.20	54.85	-0.63%	± 5	
			$\sigma$	0.970	0.979	0.93%	± 5	
	850MHz	22.0	$\epsilon_r$	55.15	54.87	-0.51%	± 5	
			$\sigma$	0.988	0.999	1.11%	± 5	
1900MHz (Body)	1850MHz	22.0	$\epsilon_r$	53.30	54.61	2.46%	± 5	2015/10/6
			$\sigma$	1.520	1.460	-3.95%	± 5	
	1900MHz	22.0	$\epsilon_r$	53.30	54.36	1.99%	± 5	
			$\sigma$	1.520	1.502	-1.18%	± 5	
	1950MHz	22.0	$\epsilon_r$	53.30	54.51	2.27%	± 5	
			$\sigma$	1.520	1.574	3.55%	± 5	
1900MHz (Body)	1850MHz	22.0	$\epsilon_r$	53.30	54.61	2.46%	± 5	2015/10/8
			$\sigma$	1.520	1.460	-3.95%	± 5	
	1900MHz	22.0	$\epsilon_r$	53.30	54.36	1.99%	± 5	
			$\sigma$	1.520	1.502	-1.18%	± 5	
	1950MHz	22.0	$\epsilon_r$	53.30	54.51	2.27%	± 5	
			$\sigma$	1.520	1.574	3.55%	± 5	
1900MHz (Body)	1850MHz	22.0	$\epsilon_r$	53.30	54.61	2.46%	± 5	2015/10/11
			$\sigma$	1.520	1.460	-3.95%	± 5	
	1900MHz	22.0	$\epsilon_r$	53.30	54.36	1.99%	± 5	
			$\sigma$	1.520	1.502	-1.18%	± 5	
	1950MHz	22.0	$\epsilon_r$	53.30	54.51	2.27%	± 5	
			$\sigma$	1.520	1.574	3.55%	± 5	
2450MHz (Body)	2400MHz	22.0	$\epsilon_r$	52.77	51.25	-2.88%	± 5	2015/10/5
			$\sigma$	1.902	1.882	-1.05%	± 5	
	2450MHz	22.0	$\epsilon_r$	52.70	51.18	-2.88%	± 5	
			$\sigma$	1.950	1.962	0.62%	± 5	
	2500MHz	22.0	$\epsilon_r$	52.64	50.99	-3.13%	± 5	
			$\sigma$	2.021	2.020	-0.05%	± 5	

Table 3. Measured Tissue dielectric parameters for body phantoms -1



### 7.3 Verification Summary

Prior to the assessment, the system validation kit was used to test whether the system was operating within its specifications of  $\pm 7\%$ . The verification was performed at 835, 1900 and 2450MHz.

Mixture Type	Frequency (MHz)	Power	SAR <sub>1g</sub> (W/Kg)	SAR <sub>10g</sub> (W/Kg)	Drift (dB)	Difference percentage		Probe Model / Serial No.	Dipole Model / Serial No.	1W Target		Date
						1g	10g			SAR <sub>1g</sub> (mW/g)	SAR <sub>10g</sub> (mW/g)	
Body	835	250 mW	2.37	1.55	-0.01	-3.00%	-4.00%	EX3DV4-SN3847	D835V2-SN4d082	9.77	6.46	Oct. 06, 2015
		Normalize to 1 Watt	9.48	6.20								
Body	1900	250 mW	9.95	5.07	0.03	-0.70%	-3.90%	EX3DV4-SN3847	D1900V2-SN5d111	40.10	21.10	Oct. 06, .2015
		Normalize to 1 Watt	39.80	20.28								
Body	1900	250 mW	9.99	5.15	-0.04	-0.30%	-2.40%	EX3DV4-SN3847	D1900V2-SN5d111	40.10	21.10	Oct. 08, 2015
		Normalize to 1 Watt	39.96	20.60								
Body	1900	250 mW	9.81	5.03	-0.06	-2.10%	-4.60%	EX3DV4-SN3847	D1900V2-SN5d111	40.10	21.10	Oct.11, 2015
		Normalize to 1 Watt	39.24	20.12								
Body	2450	250 mW	13.50	6.29	-0.02	2.10%	3.10%	EX3DV4-SN3847	D2450V2-SN712	52.90	24.40	Oct. 05, 2015
		Normalize to 1 Watt	54.00	25.16								



## 7.4 Validation Summary

Per FCC KDB 865664 D02v01r01, SAR system validation status should be documented to confirm measurement accuracy. The SAR systems (including SAR probes, system components and software versions) used for this device were validated against its performance specifications prior to the SAR measurements. Reference dipoles were used with the required tissue- equivalent media for system validation, according to the procedures outlined in IEEE 1528-2013 and FCC KDB 865664 D01v01r04. Since SAR probe calibrations are frequency dependent, each probe calibration point was validated at a frequency within the valid frequency range of the probe calibration point, using the system that normally operates with the probe for routine SAR measurements and according to the required tissue-equivalent media.

A tabulated summary of the system validation status including the validation date(s), measurement frequencies, SAR probes and tissue dielectric parameters as below.

Probe Type Model / Serial No.	Prob Cal. Point (MHz)	Head / Body	Cond.	Perm.	CW Validation			Mod. Validation			Date
			$\epsilon_r$	$\sigma$	Sensitivity	Probe	Probe	Mod. Type	Duty Factor	PAR	
						Linearity	Isotropy				
EX3DV4- SN3847	835	Body	54.85	0.979	Pass	Pass	Pass	GMSK.RMC- 12.2K	Pass	N/A	Oct. 06, 2015
EX3DV4- SN3847	1900	Body	54.36	1.502	Pass	Pass	Pass	RMC-12.2K	Pass	N/A	Oct. 06, 2015
EX3DV4- SN3847	1900	Body	54.36	1.502	Pass	Pass	Pass	RMC-12.2K	Pass	N/A	Oct. 08, 2015
EX3DV4- SN3847	1900	Body	54.36	1.502	Pass	Pass	Pass	GMSK.RMC- 12.2K	Pass	N/A	Oct. 11, 2015
EX3DV4- SN3847	2450	Body	51.18	1.962	Pass	Pass	Pass	DSSS	N/A	Pass	Oct. 05, 2015



## 8. Test Equipment List

Manufacturer	Name of Equipment	Type/Model	Serial Number	Calibration	
				Last Cal.	Due Date
SPEAG	835MHz System Validation Kit	D835V2	4d082	Jul. 06, 2015	Jul. 06, 2016
SPEAG	1900MHz System Validation Kit	D1900V2	5d111	Jul. 07, 2015	Jul. 07, 2016
SPEAG	2450MHz System Validation Kit	D2450V2	712	Mar. 12, 2015	Mar. 12, 2016
SPEAG	Dosimetric E-Field Probe	EX3DV4	3847	Jan. 30, 2015	Jan. 30, 2016
SPEAG	Data Acquisition Electronics	DAE4	541	Feb. 03, 2015	Feb. 03, 2016
SPEAG	Device Holder	N/A	N/A	NCR	
SPEAG	Measurement Server	SE UMS 011 AA	1025	NCR	
SPEAG	Phantom	SAM V4.0	TP-1150	NCR	
SPEAG	Robot	Staubli TX90XL	F07/564ZA1/C/01	NCR	
SPEAG	Software	DASY52 V52.8 (8)	N/A	NCR	
SPEAG	Software	SEMCAD X V14.6.10 (7331)	N/A	NCR	
Agilent	Dielectric Probe Kit	85070C	US99360094	NCR	
Agilent	ENA Series Network Analyzer	E5071B	MY42404655	Apr. 10, 2015	Apr. 10, 2016
R&S	Power Sensor	NRP-Z22	100179	Jun. 01, 2015	Jun. 01, 2016
Agilent	Power Sensor	8481H	3318A20779	Jun. 15, 2015	Jun. 15, 2016
Agilent	Power Meter	EDM Series E4418B	GB40206143	Jun. 15, 2015	Jun. 15, 2016
Anritsu	Power Meter	ML2495A	1135009	Aug. 24, 2015	Aug. 24, 2016
Agilent	MXF-G-B RF Vector Signal Generator	N5182B	MY53050382	May 28, 2015	May 28, 2016
Agilent	Dual Directional Coupler	778D	50334	NCR	
Mini-Circuits	Power Amplifier	ZHL-42W-SMA	D111103#5	NCR	
Mini-Circuits	Power Amplifier	ZVE-8G-SMA	D042005 671800514	NCR	
Aisi	Attenuator	IEAT 3dB	N/A	NCR	

Table 4. Test Equipment List



## 9. **Measurement Uncertainty**

Measurement uncertainties in SAR measurements are difficult to quantify due to several variables including biological, physiological, and environmental. However, we estimate the measurement uncertainties in SAR<sup>19</sup> to be less than  $\pm 21.76\%$  for 300MHz ~3GHz and 3GHz ~ 6GHz  $\pm 25.68\%$  [ 8 ] .

According to Std. C95.3 [ 9 ] , the overall uncertainties are difficult to assess and will vary with the type of meter and usage situation. However, accuracy's of  $\pm 1$  to 3 dB can be expected in practice, with greater uncertainties in near-field situations and at higher frequencies (shorter wavelengths), or areas where large reflecting objects are present. Under optimum measurement conditions, SAR measurement uncertainties of at least  $\pm 2$ dB can be expected.





Uncertainty of a Measure SAR of EUT with DASY System

Item	Uncertainty Component	Uncertainty Value	Prob. Dist	Div.	$c_i$ (1g)	$c_i$ (10g)	Std. Unc. (1-g)	Std. Unc. (10-g)	$V_i$ or $V_{eff}$
Measurement System									
u1	Probe Calibration ( $k=1$ )	±6.0%	Normal	1	1	1	±6.0%	±6.0%	∞
u2	Axial Isotropy	±4.7%	Rectangular	$\sqrt{3}$	0.7	0.7	±1.9%	±1.9%	∞
u3	Hemispherical Isotropy	±9.6%	Rectangular	$\sqrt{3}$	0.7	0.7	±3.9%	±3.9%	
u4	Boundary Effect	±1.0%	Rectangular	$\sqrt{3}$	1	1	±0.6%	±0.6%	∞
u5	Linearity	±4.7%	Rectangular	$\sqrt{3}$	1	1	±2.7%	±2.7%	∞
u6	System Detection Limit	±1.0%	Rectangular	$\sqrt{3}$	1	1	±0.6%	±0.6%	∞
u7	Readout Electronics	±0.3%	Normal	1	1	1	±0.3%	±0.3%	∞
u8	Response Time	±0.8%	Rectangular	$\sqrt{3}$	1	1	±0.5%	±0.5%	∞
u9	Integration Time	±1.9%	Rectangular	$\sqrt{3}$	1	1	±1.1%	±1.1%	∞
u10	RF Ambient Conditions	±3.0%	Rectangular	$\sqrt{3}$	1	1	±1.7%	±1.7%	∞
u11	RF Ambient Reflections	±3.0%	Rectangular	$\sqrt{3}$	1	1	±1.7%	±1.7%	∞
u12	Probe Positioner Mechanical Tolerance	±0.4%	Rectangular	$\sqrt{3}$	1	1	±0.2%	±0.2%	∞
u13	Probe Positioning with respect to Phantom Shell	±2.9%	Rectangular	$\sqrt{3}$	1	1	±1.7%	±1.7%	∞
u14	Extrapolation, interpolation and integration Algorithms for Max. SAR Evaluation	±1.0%	Rectangular	$\sqrt{3}$	1	1	±0.6%	±0.6%	∞
Test sample Related									
u15	Test sample Positioning	±3.6%	Normal	1	1	1	±3.6%	±3.6%	89
u16	Device Holder Uncertainty	±2.7%	Normal	1	1	1	±2.7%	±2.7%	5
u17	Output Power Variation - SAR drift measurement	±5.0%	Rectangular	$\sqrt{3}$	1	1	±2.9%	±2.9%	∞
Phantom and Tissue Parameters									
u18	Phantom Uncertainty ( shape and thickness tolerances)	±4.0%	Rectangular	$\sqrt{3}$	1	1	±2.3%	±2.3%	∞
u19	Liquid Conductivity - deviation from target values	±5.0%	Rectangular	$\sqrt{3}$	0.64	0.43	±1.8%	±1.2%	∞
u20	Liquid Conductivity - measurement uncertainty	±2.5%	Normal	1	0.64	0.43	±1.6%	±1.08%	69
u21	Liquid Permittivity - deviation from target values	±5.0%	Rectangular	$\sqrt{3}$	0.6	0.49	±1.7%	±1.4%	∞
u22	Liquid Permittivity - measurement uncertainty	±2.5%	Normal	1	0.6	0.49	±1.5%	±1.23%	69
Combined standard uncertainty			RSS				±10.88%	±10.66%	313
Expanded uncertainty (95% CONFIDENCE LEVEL )			$k=2$				±21.76%	±21.31%	

Table 5. Uncertainty Budget for frequency range 300MHz to 3GHz



Uncertainty of a Measure SAR of EUT with DASY System

Item	Uncertainty Component	Uncertainty Value	Prob. Dist	Div.	$c_i$ (1g)	$c_i$ (10g)	Std. Unc. (1-g)	Std. Unc. (10-g)	$V_i$ or $V_{eff}$
Measurement System									
u1	Probe Calibration ( $k=1$ )	±6.5%	Normal	1	1	1	±6.5%	±6.5%	∞
u2	Axial Isotropy	±4.7%	Rectangular	$\sqrt{3}$	0.7	0.7	±1.9%	±1.9%	∞
u3	Hemispherical Isotropy	±9.6%	Rectangular	$\sqrt{3}$	0.7	0.7	±3.9%	±3.9%	
u4	Boundary Effect	±2.0%	Rectangular	$\sqrt{3}$	1	1	±1.2%	±1.2%	∞
u5	Linearity	±4.7%	Rectangular	$\sqrt{3}$	1	1	±2.7%	±2.7%	∞
u6	System Detection Limit	±1.0%	Rectangular	$\sqrt{3}$	1	1	±0.6%	±0.6%	∞
u7	Readout Electronics	±0.0%	Normal	1	1	1	±0.0%	±0.0%	∞
u8	Response Time	±0.8%	Rectangular	$\sqrt{3}$	1	1	±0.5%	±0.5%	∞
u9	Integration Time	±2.8%	Rectangular	$\sqrt{3}$	1	1	±2.8%	±2.8%	∞
u10	RF Ambient Conditions	±3.0%	Rectangular	$\sqrt{3}$	1	1	±1.7%	±1.7%	∞
u11	RF Ambient Reflections	±3.0%	Rectangular	$\sqrt{3}$	1	1	±1.7%	±1.7%	∞
u12	Probe Positioner Mechanical Tolerance	±0.7%	Rectangular	$\sqrt{3}$	1	1	±0.7%	±0.7%	∞
u13	Probe Positioning with respect to Phantom Shell	±9.9%	Rectangular	$\sqrt{3}$	1	1	±5.7%	±5.7%	∞
u14	Extrapolation, interpolation and integration Algorithms for Max. SAR Evaluation	±3.0%	Rectangular	$\sqrt{3}$	1	1	±1.7%	±1.7%	∞
Test sample Related									
u15	Test sample Positioning	±3.6%	Normal	1	1	1	±3.6%	±3.6%	89
u16	Device Holder Uncertainty	±2.7%	Normal	1	1	1	±2.7%	±2.7%	5
u17	Output Power Variation - SAR drift measurement	±5.0%	Rectangular	$\sqrt{3}$	1	1	±2.9%	±2.9%	∞
Phantom and Tissue Parameters									
u18	Phantom Uncertainty ( shape and thickness tolerances)	±4.0%	Rectangular	$\sqrt{3}$	1	1	±2.3%	±2.3%	∞
u19	Liquid Conductivity - deviation from target values	±5.0%	Rectangular	$\sqrt{3}$	0.64	0.43	±1.8%	±1.2%	∞
u20	Liquid Conductivity - measurement uncertainty	±2.5%	Normal	1	0.64	0.43	±1.6%	±1.08%	69
u21	Liquid Permittivity - deviation from target values	±5.0%	Rectangular	$\sqrt{3}$	0.6	0.49	±1.7%	±1.4%	∞
u22	Liquid Permittivity - measurement uncertainty	±2.5%	Normal	1	0.6	0.49	±1.5%	±1.23%	69
Combined standard uncertainty			RSS				±12.84%	±12.65%	313
Expanded uncertainty (95% CONFIDENCE LEVEL )			$k=2$				±25.68%	±25.29%	

Table 6. Uncertainty Budget for frequency range 3GHz to 6GHz



## 10. Measurement Procedure

The measurement procedures are as follows:

1. For WLAN function, engineering testing software installed on Notebook can provide continuous transmitting signal.
2. Measure output power through RF cable and power meter
3. Set scan area, grid size and other setting on the DASY software
4. Find out the largest SAR result on these testing positions of each band
5. Measure SAR results for other channels in worst SAR testing position if the SAR of highest power channel is larger than 0.8 W/kg

According to the test standard, the recommended procedure for assessing the peak spatial-average SAR value consists of the following steps:

1. Power reference measurement
2. Area scan
3. Zoom scan
4. Power drift measurement

### 10.1 Spatial Peak SAR Evaluation

The procedure for spatial peak SAR evaluation has been implemented according to the test standard. It can be conducted for 1g and 10g, as well as for user-specific masses. The DASY software includes all numerical procedures necessary to evaluate the spatial peak SAR value.

The base for the evaluation is a "cube" measurement. The measured volume must include the 1g and 10g cubes with the highest averaged SAR values. For that purpose, the center of the measured volume is aligned to the interpolated peak SAR value of a previously performed area scan.

The entire evaluation of the spatial peak values is performed within the post-processing engine (SEMCAD). The system always gives the maximum values for the 1g and 10g cubes. The algorithm to find the cube with highest averaged SAR is divided into the following stages

1. Extraction of the measured data (grid and values) from the Zoom Scan
2. Calculation of the SAR value at every measurement point based on all stored data (A/D values and measurement parameters)
3. Generation of a high-resolution mesh within the measured volume
4. Interpolation of all measured values from the measurement grid to the high-resolution grid
5. Extrapolation of the entire 3-D field distribution to the phantom surface over the distance from sensor to surface
6. Calculation of the averaged SAR within masses of 1g and 10g



## 10.2 Area & Zoom Scan Procedures

First Area Scan is used to locate the approximate location(s) of the local peak SAR value(s). The measurement grid within an Area Scan is defined by the grid extent, grid step size and grid offset. Next, in order to determine the EM field distribution in a three-dimensional spatial extension, Zoom Scan is required. The Zoom Scan measures points and step size follow as below. The Zoom Scan is performed around the highest E-field value to determine the averaged SAR-distribution over 10 g.

Grid Type	Frequency		Step size (mm)			X*Y*Z (Point)	Cube size			Step size		
			X	Y	Z		X	Y	Z	X	Y	Z
uniform grid	≤ 3GHz	≤ 2GHz	≤ 8	≤ 8	≤ 5	5*5*7	32	32	30	8	8	5
		2G - 3G	≤ 5	≤ 5	≤ 5	7*7*7	30	30	30	5	5	5
	3 - 6GHz	3 - 4GHz	≤ 5	≤ 5	≤ 4	7*7*8	30	30	28	5	5	4
		4 - 5GHz	≤ 4	≤ 4	≤ 3	8*8*10	28	28	27	4	4	3
		5 - 6GHz	≤ 4	≤ 4	≤ 2	8*8*12	28	28	22	4	4	2

(Our measure settings are refer KDB Publication 865664 D01v01r04)

## 10.3 Volume Scan Procedures

The volume scan is used for assess overlapping SAR distributions for antennas transmitting in different frequency bands. It is equivalent to an oversized zoom scan used in standalone measurements. The measurement volume will be used to enclose all the simultaneous transmitting antennas. For antennas transmitting simultaneously in different frequency bands, the volume scan is measured separately in each frequency band. In order to sum correctly to compute the 1g aggregate SAR, the DUT remain in the same test position for all measurements and all volume scan use the same spatial resolution and grid spacing. When all volume scan were completed, the software, SEMCAD postprocessor can combine and subsequently superpose these measurement data to calculating the multiband SAR.

## 10.4 SAR Averaged Methods

In DASYS, the interpolation and extrapolation are both based on the modified Quadratic Shepard's method. The interpolation scheme combines a least-square fitted function method and a weighted average method which are the two basic types of computational interpolation and approximation. Extrapolation routines are used to obtain SAR values between the lowest measurement points and the inner phantom surface. The extrapolation distance is determined by the surface detection distance and the probe sensor offset. The uncertainty increases with the extrapolation distance. To keep the uncertainty within 1% for the 1 g and 10 g cubes, the extrapolation distance should not be larger than 5 mm.

## 10.5 Power Drift Monitoring

All SAR testing is under the DUT install full charged battery and transmit maximum output power. In DASYS measurement software, the power reference measurement and power drift measurement procedures are used for monitoring the power drift of DUT during SAR test. Both these procedures measure the field at a specified reference position before and after the SAR testing. The software will calculate the field difference in dB. If the power drift more than 5%, the SAR will be retested.



## 11. SAR Test Results Summary

- Note: 1. According KDB 447498 D01 V05r02 section 4.1.4, the “Reported” explanation as below:  
“When SAR or MPE is measured at or scaled to the maximum tune-up tolerance limit, the results are referred to as reported.”
2. If actual power less than tune-up power that Scaling SAR is required.
  3. The formula of Reported SAR, that represent as below:  
$$\text{Reported SAR} = \text{Original SAR} * 10^{[(\text{Tune-up power} - \text{Actual power})/10]}$$
  4. If the WWAN Band Channel's Reported SAR 1g of the position is > 0.8 W/Kg, low, middle and high channel are supposed to be tested.(2G/3G).
  5. When the maximum output power in HSUPA / HSUPA mode is  $\leq \frac{1}{4}$  dB higher than the WCDMA mode or when the highest reported SAR of the WCDMA mode is scaled by the ratio of specified maximum output power and tune-up tolerance of HSUPA / HSUPA to WCDMA mode and the adjusted SAR is  $\leq 1.2$  W/kg, SAR measurement is not required for the HSUPA / HSUPA mode.
  6. Require the middle channel to be tested first,if the maximum output power variation across the required test channels is >  $\frac{1}{2}$  dB, instead of the middle channel, the highest output power channel must be used(2G/3G).
  7. When the reported SAR of the highest measured maximum output power channel is  $\leq 0.8$  W/kg, no further SAR testing is required for 802.11b DSSS.
  8. When KDB Publication 447498 SAR test exclusion is applies , SAR is not required for OFDM configuration.
  9. SAR for the initial test configuration(WLAN) is measured using the highest maximum output power channel.

### 11.1 Head Measurement SAR

Evaluated head SAR is not available.



## 11.2 Body Measurement SAR

Index.	Position	Band	Ch.	Data Rate or Sub-Test	Test Position	Spacing (mm)	SAR <sub>1g</sub> (W/kg)	Power Drift	Source-Time-Avg power (dBm)	Time-Avg Tune-Up	Reported SAR <sub>1g</sub> (W/kg)
#4	Flat	GPRS 850	190	836.6	1	0	0.395	0.00	24.24	24.50	0.42
#5	Flat	GPRS 850	190	836.6	2	0	0.435	0.06	24.24	24.50	0.46
#6	Flat	GPRS 850	190	836.6	4	0	0.275	0.00	24.24	24.50	0.29
#7	Flat	GPRS 850	190	836.6	5	0	0.221	0.02	24.24	24.50	0.24
#8	Flat	GPRS 850	190	836.6	6	0	0.459	-0.09	24.24	24.50	0.49
#31	Flat	GPRS 1900	661	1880.0	1	0	0.218	0.08	21.30	21.50	0.23
#30	Flat	GPRS 1900	661	1880.0	2	0	0.360	0.08	21.30	21.50	0.38
#29	Flat	GPRS 1900	661	1880.0	4	0	0.414	0.00	21.30	21.50	0.43
#28	Flat	GPRS 1900	661	1880.0	6	0	0.168	0.02	21.30	21.50	0.18

Index.	Position	Band	Ch.	Data Rate or Sub-Test	Test Position	Spacing (mm)	SAR <sub>1g</sub> (W/kg)	Power Drift	Avg Power	Max tune-up	Reported SAR <sub>1g</sub> (W/kg)
#13	Flat	WCDMA Band II	9400	RMC12.2K	1	0	0.270	0.05	22.01	22.50	0.30
#14	Flat	WCDMA Band II	9400	RMC12.2K	2	0	0.681	0.06	22.01	22.50	0.76
#19	Flat	WCDMA Band II	9262	RMC12.2K	4	0	0.911	-0.16	21.95	22.50	1.03
#15	Flat	WCDMA Band II	9400	RMC12.2K	4	0	0.818	-0.11	22.01	22.50	0.92
#20	Flat	WCDMA Band II	9538	RMC12.2K	4	0	0.771	-0.05	22.04	22.50	0.86
#21	Flat	WCDMA Band II	9262	RMC12.2K	6	0	1.200	0.18	21.95	22.50	1.36
#16	Flat	WCDMA Band II	9400	RMC12.2K	6	0	0.933	0.18	22.01	22.50	1.04
#22	Flat	WCDMA Band II	9538	RMC12.2K	6	0	0.886	0.10	22.04	22.50	0.99
#25	Flat	HSDPA Band II	9262	QPSK_Sub-test1	6	0	1.170	0.13	21.33	22.00	1.37
#24	Flat	HSDPA Band II	9400	QPSK_Sub-test1	6	0	0.937	0.09	21.40	22.00	1.08
#23	Flat	HSDPA Band II	9538	QPSK_Sub-test1	6	0	0.827	0.00	21.45	22.00	0.94
#26	Flat	HSUPA Band II	9538	QPSK_Sub-test1	6	0	0.181	0.11	21.02	22.00	0.23
#9	Flat	WCDMA Band V	4183	RMC12.2K	1	0	0.485	-0.16	22.15	23.00	0.59
#10	Flat	WCDMA Band V	4183	RMC12.2K	2	0	0.544	0.08	22.15	23.00	0.66
#11	Flat	WCDMA Band V	4183	RMC12.2K	4	0	0.392	0.09	22.15	23.00	0.48
#12	Flat	WCDMA Band V	4183	RMC12.2K	6	0	0.444	-0.02	22.15	23.00	0.54

Index.	Position	Band	Ch.	Data Rate or Sub-Test	Test Position	Spacing (mm)	SAR <sub>1g</sub> (W/kg)	Power Drift	Avg Power	Max tune-up	Reported SAR <sub>1g</sub> (W/kg)
#2	Flat	IEEE 802.11b	1	1M	2	0	0.013	0.14	15.51	16.00	0.02
#3	Flat	IEEE 802.11b	1	1M	5	0	0.135	0.04	15.51	16.00	0.15



### 11.3 Hot-spot mode Measurement SAR

Evaluated Hot-spot mode Measurement SAR is not available.

### 11.4 Extremity Measurement SAR

Evaluated extremity SAR is not available.

### 11.5 SAR Measurement Variability

Detailed evaluations please refer KDB 865664 on "SAR test reduction according to KDB" section.

Index.	Position	Band	Ch.	Test Position	Spacing (mm)	SAR <sub>1g</sub> (W/kg)	Power Drift	Burst Avg Power	Max tune-up	Reported SAR <sub>1g</sub> (W/kg)	Repeated measurement Ratio	Note
#27	Flat	HSDPA Band II	9262	6	0	1.060	-0.14	21.33	22.00	1.237	1.1 < 1.2	original #25_ measurement _once

- Note:
1. According KDB 447498 D01 V05r02 section 4.1.4, the "Reported" explanation as below:  
"When SAR or MPE is measured at or scaled to the maximum tune-up tolerance limit, the results are referred to as reported."
  2. If actual power less than tune-up power that Scaling SAR is required.
  3. The formula of Reported SAR, that represent as below:  
Reported SAR = Original SAR \* 10<sup>[(Tune-up power - Actual power)/10]</sup>
  4. The original highest measured Reported SAR 1g is ≥ 0.80 W/kg, repeat that measurement once.
  5. Perform a second repeated measurement the ratio of largest to smallest SAR for the original and first repeated measurements is < 1.2,the original or repeated measurement is ≥ 1.45 W/kg (~ 10% from the 1-g SAR limit).



## 11.6 Std. C95.1-1999 RF Exposure Limit

Human Exposure	Population Uncontrolled Exposure ( W/kg ) or (mW/g)	Occupational Controlled Exposure ( W/kg ) or (mW/g)
Spatial Peak SAR* (head)	1.60	8.00
Spatial Peak SAR** (Whole Body)	0.08	0.40
Spatial Peak SAR*** (Partial-Body)	1.60	8.00
Spatial Peak SAR**** (Hands / Feet / Ankle / Wrist )	4.00	20.00

Table 7. Safety Limits for Partial Body Exposure

### Notes :

- \* The Spatial Peak value of the SAR averaged over any 1 gram of tissue.  
( defined as a tissue volume in the shape of a cube ) and over the appropriate averaging time.
- \*\* The Spatial Average value of the SAR averaged over the whole – body.
- \*\*\* The Spatial Average value of the SAR averaged over the partial – body.
- \*\*\*\* The Spatial Peak value of the SAR averaged over any 10 grams of tissue.  
( defined as a tissue volume in the shape of a cube ) and over the appropriate averaging time.

**Population / Uncontrolled Environments** : are defined as locations where there is the exposure of individuals who have no knowledge or control of their exposure.

**Occupational / Controlled Environments** : are defined as locations where there is exposure that may be incurred by persons who are aware of the potential for exposure, (i.e. as a result of employment or occupation).





## 12. Conclusion

The SAR test values found for the portable mobile phone **Unitech Electronics Co., Ltd. Trade Name : unitech Model(s) : PA820** is below the maximum recommended level of 1.6 W/kg (mW/g).

## 13. References

- [1] Std. C95.1-1999, "American National Standard safety levels with respect to human exposure to radio frequency electromagnetic fields, 300KHz to 100GHz", New York.
- [2] NCRP, National Council on Radiation Protection and Measurements, "Biological Effects and Exposure Criteria for Radio frequency Electromagnetic Fields", NCRP report NO. 86, 1986.
- [3] T. Schmid, O. Egger, and N. Kuster, "Automatic E-field scanning system for dosimetric assessments", IEEE Transactions on Microwave Theory and Techniques, vol. 44, pp, 105-113, Jan. 1996.
- [4] K. Pokovi<sup>c</sup>, T. Schmid, and N. Kuster, "Robust setup for precise calibration of E-field probes in tissue simulating liquids at mobile communications frequency", in ICECOM'97, Dubrovnik, October 15-17, 1997, pp.120-124.
- [5] K. Pokovi<sup>c</sup>, T. Schmid, and N. Kuster, "E-field probe with improved isotropy in brain simulating liquids", in Proceedings of the ELMAR, Zadar, Croatia, 23-25 June, 1996, pp.172-175.
- [6] N. Kuster, and Q. Balzano, "Energy absorption mechanism by biological bodies in the near field of dipole antennas above 300MHz", IEEE Transaction on Vehicular Technology, vol. 41, no. 1, Feb. 1992, pp. 17-23.
- [7] Robert J. Renka, "Multivariate Interpolation Of Large Sets Of Scattered Data", University of North Texas ACM Transactions on Mathematical Software, vol. 14, no. 2, June 1988 , pp. 139-148.
- [8] N. Kuster, R. Kastle, T. Schmid, Dosimetric evaluation of mobile communications equipment with known precision, IEEE Transaction on Communications, vol. E80-B, no. 5, May 1997, pp. 645-652.
- [9] Std. C95.3-1991, "IEEE Recommended Practice for the Measurement of Potentially Hazardous Electromagnetic Fields – RF and Microwave, New York: IEEE, Aug. 1992.
- [10] CENELEC CLC/SC111B, European Prestandard (prENV 50166-2), Human Exposure to Electromagnetic Fields High-frequency: 10KHz-300GHz, Jan. 1995.
- [11] IEEE Std 1528™-2013 - IEEE Recommended Practice for Determining the Peak Spatial-Average Specific Absorption Rate (SAR) in the Human Head From Wireless Communications Devices: Measurement Techniques

## Appendix A - System Performance Check

Test Laboratory: A Test Lab Techno Corp.

Date: 2015/10/6 Time: AM 10:08:11

### System Performance Check at 835MHz\_20151006\_Body

**DUT: Dipole 835 MHz; Type: D835V2; Serial: D835V2 - SN:4d082**

Communication System: UID 0, CW (0); Frequency: 835 MHz; Duty Cycle: 1:1

Medium parameters used:  $f = 835 \text{ MHz}$ ;  $\sigma = 0.979 \text{ S/m}$ ;  $\epsilon_r = 54.845$ ;  $\rho = 1000 \text{ kg/m}^3$

Phantom section: Flat Section

Measurement Standard: DASYS5 (IEEE/IEC/ANSI C63.19-2011)

DASY Configuration:

- Area Scan setting - Find Secondary Maximum Within: 2.0dB and with a peak SAR value greater than 0.5 W/Kg
- Probe: EX3DV4 - SN3847; ConvF(9.42, 9.42, 9.42); Calibrated: 2015/1/30;
- Sensor-Surface: 2mm (Mechanical Surface Detection)
- Electronics: DAE4 Sn541; Calibrated: 2015/2/3
- Phantom: SAM with CRP; Type: SAM; Serial: TP-1150 and higher
- Measurement SW: DASYS52, Version 52.8 (8); SEMCAD X Version 14.6.10 (7331)

### System Performance Check at 835MHz/Area Scan (61x121x1):

Interpolated grid:  $dx=1.500 \text{ mm}$ ,  $dy=1.500 \text{ mm}$

Maximum value of SAR (interpolated) = 3.02 W/kg

### System Performance Check at 835MHz/Zoom Scan (7x7x7)/Cube 0:

Measurement grid:  $dx=5\text{mm}$ ,  $dy=5\text{mm}$ ,  $dz=5\text{mm}$

Reference Value = 56.38 V/m; Power Drift = -0.01 dB

Peak SAR (extrapolated) = 3.52 W/kg

**SAR(1 g) = 2.37 W/kg; SAR(10 g) = 1.55 W/kg**

Maximum value of SAR (measured) = 3.00 W/kg

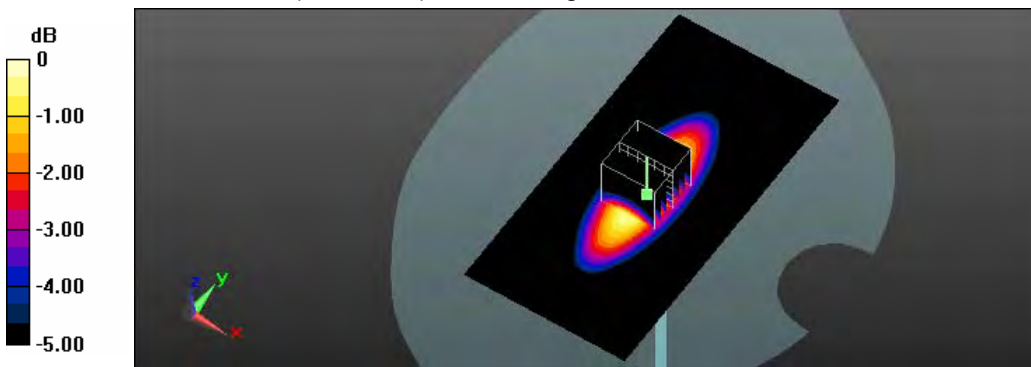

0 dB = 3.00 W/kg = 4.77 dBW/kg

Test Laboratory: A Test Lab Techno Corp.

Date: 2015/10/6 Time: PM 10:42:15

**System Performance Check at 1900MHz\_20151006\_Body**

**DUT: Dipole D1900V2\_SN5d111; Type: D1900V2; Serial: D1900V2 - SN:5d111**

Communication System: UID 0, CW (0); Frequency: 1900 MHz; Duty Cycle: 1:1

Medium parameters used:  $f = 1900$  MHz;  $\sigma = 1.502$  S/m;  $\epsilon_r = 54.362$ ;  $\rho = 1000$  kg/m<sup>3</sup>

Phantom section: Flat Section

Measurement Standard: DASY5 (IEEE/IEC/ANSI C63.19-2011)

DASY Configuration:

- Area Scan setting - Find Secondary Maximum Within: 2.0dB and with a peak SAR value greater than 0.5 W/Kg
- Probe: EX3DV4 - SN3847; ConvF(7.46, 7.46, 7.46); Calibrated: 2015/1/30;
- Sensor-Surface: 2mm (Mechanical Surface Detection)
- Electronics: DAE4 Sn541; Calibrated: 2015/2/3
- Phantom: SAM with CRP; Type: SAM; Serial: TP-1150 and higher
- Measurement SW: DASY52, Version 52.8 (8); SEMCAD X Version 14.6.10 (7331)

**System Performance Check at 1900MHz/Area Scan (61x61x1):**

Interpolated grid: dx=1.500 mm, dy=1.500 mm

Maximum value of SAR (interpolated) = 14.6 W/kg

**System Performance Check at 1900MHz/Zoom Scan (7x7x7)/Cube 0:**

Measurement grid: dx=5mm, dy=5mm, dz=5mm

Reference Value = 98.10 V/m; Power Drift = 0.03 dB

Peak SAR (extrapolated) = 18.5 W/kg

**SAR(1 g) = 9.95 W/kg; SAR(10 g) = 5.07 W/kg**

Maximum value of SAR (measured) = 14.5 W/kg

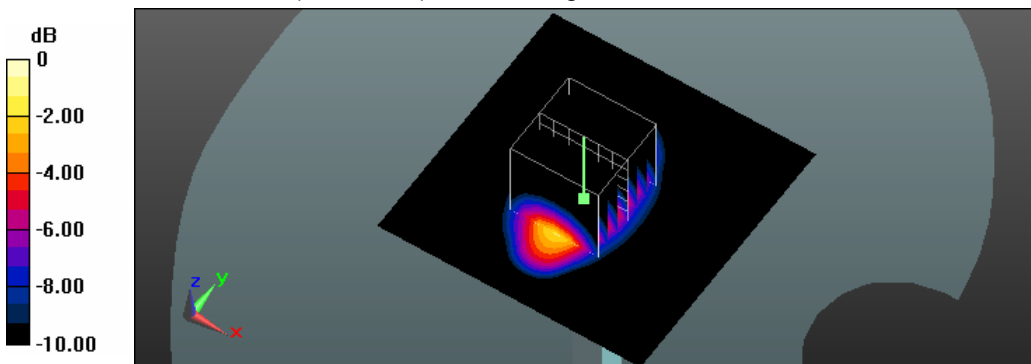

0 dB = 14.5 W/kg = 11.61 dBW/kg

Test Laboratory: A Test Lab Techno Corp.

Date: 2015/10/8 Time: PM 10:13:54

**System Performance Check at 1900MHz\_20151008\_Body**

**DUT: Dipole D1900V2\_SN5d111; Type: D1900V2; Serial: D1900V2 - SN:5d111**

Communication System: UID 0, CW (0); Frequency: 1900 MHz; Duty Cycle: 1:1

Medium parameters used:  $f = 1900 \text{ MHz}$ ;  $\sigma = 1.502 \text{ S/m}$ ;  $\epsilon_r = 54.362$ ;  $\rho = 1000 \text{ kg/m}^3$

Phantom section: Flat Section

Measurement Standard: DASY5 (IEEE/IEC/ANSI C63.19-2011)

DASY Configuration:

- Area Scan setting - Find Secondary Maximum Within: 2.0dB and with a peak SAR value greater than 0.5 W/Kg
- Probe: EX3DV4 - SN3847; ConvF(7.46, 7.46, 7.46); Calibrated: 2015/1/30;
- Sensor-Surface: 2mm (Mechanical Surface Detection)
- Electronics: DAE4 Sn541; Calibrated: 2015/2/3
- Phantom: SAM with CRP; Type: SAM; Serial: TP-1150 and higher
- Measurement SW: DASY52, Version 52.8 (8); SEMCAD X Version 14.6.10 (7331)

**System Performance Check at 1900MHz/Area Scan (61x61x1):**

Interpolated grid:  $dx=1.500 \text{ mm}$ ,  $dy=1.500 \text{ mm}$

Maximum value of SAR (interpolated) = 14.6 W/kg

**System Performance Check at 1900MHz/Zoom Scan (7x7x7)/Cube 0:**

Measurement grid:  $dx=5\text{mm}$ ,  $dy=5\text{mm}$ ,  $dz=5\text{mm}$

Reference Value = 98.73 V/m; Power Drift = -0.04 dB

Peak SAR (extrapolated) = 18.3 W/kg

**SAR(1 g) = 9.99 W/kg; SAR(10 g) = 5.15 W/kg**

Maximum value of SAR (measured) = 14.4 W/kg

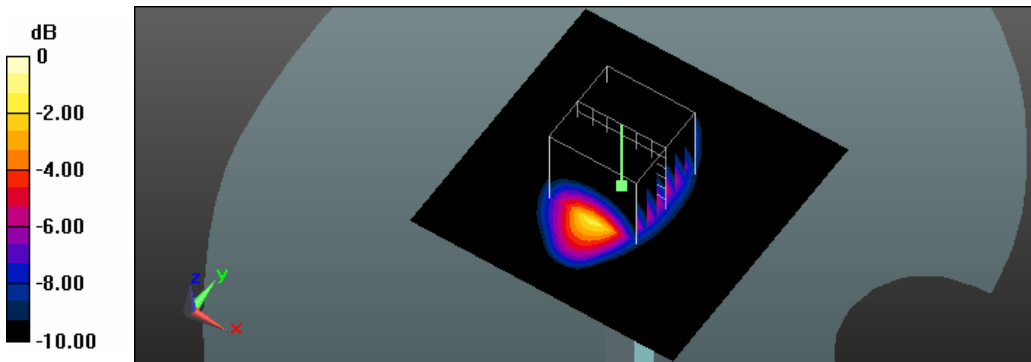

0 dB = 14.4 W/kg = 11.58 dBW/kg

Test Laboratory: A Test Lab Techno Corp.

Date: 2015/10/11 Time: AM 09:59:18

**System Performance Check at 1900MHz\_20151011\_Body**

**DUT: Dipole D1900V2\_SN5d111; Type: D1900V2; Serial: D1900V2 - SN:5d111**

Communication System: UID 0, CW (0); Frequency: 1900 MHz; Duty Cycle: 1:1

Medium parameters used:  $f = 1900 \text{ MHz}$ ;  $\sigma = 1.502 \text{ S/m}$ ;  $\epsilon_r = 54.362$ ;  $\rho = 1000 \text{ kg/m}^3$

Phantom section: Flat Section

Measurement Standard: DASY5 (IEEE/IEC/ANSI C63.19-2011)

DASY Configuration:

- Area Scan setting - Find Secondary Maximum Within: 2.0dB and with a peak SAR value greater than 0.5 W/Kg
- Probe: EX3DV4 - SN3847; ConvF(7.46, 7.46, 7.46); Calibrated: 2015/1/30;
- Sensor-Surface: 2mm (Mechanical Surface Detection)
- Electronics: DAE4 Sn541; Calibrated: 2015/2/3
- Phantom: SAM with CRP; Type: SAM; Serial: TP-1150 and higher
- Measurement SW: DASY52, Version 52.8 (8); SEMCAD X Version 14.6.10 (7331)

**System Performance Check at 1900MHz/Area Scan (61x61x1):**

Interpolated grid:  $dx=1.500 \text{ mm}$ ,  $dy=1.500 \text{ mm}$

Maximum value of SAR (interpolated) = 14.3 W/kg

**System Performance Check at 1900MHz/Zoom Scan (7x7x7)/Cube 0:**

Measurement grid:  $dx=5\text{mm}$ ,  $dy=5\text{mm}$ ,  $dz=5\text{mm}$

Reference Value = 99.07 V/m; Power Drift = -0.06 dB

Peak SAR (extrapolated) = 18.1 W/kg

**SAR(1 g) = 9.81 W/kg; SAR(10 g) = 5.03 W/kg**

Maximum value of SAR (measured) = 14.2 W/kg

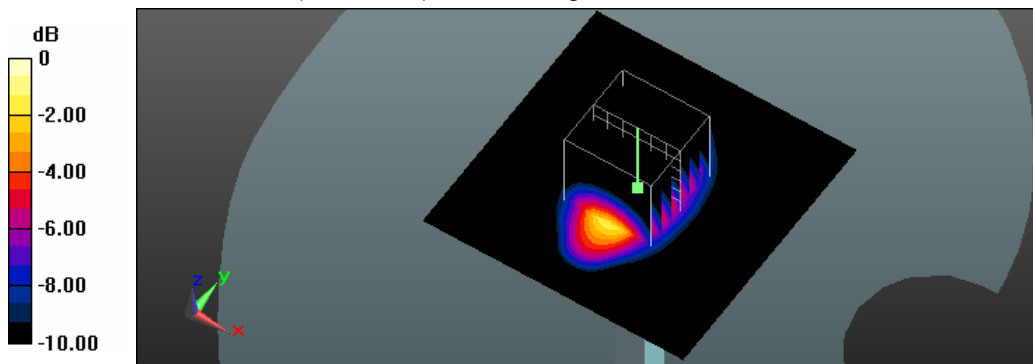

0 dB = 14.2 W/kg = 11.52 dBW/kg

Test Laboratory: A Test Lab Techno Corp.

Date: 2014/10/5 Time: PM 03:47:29

**System Performance Check at 2450MHz\_20151005\_Body**

**DUT: Dipole 2450 MHz; Type: D2450V2; Serial: D2450V2 - SN:712**

Communication System: UID 0, CW (0); Frequency: 2450 MHz; Duty Cycle: 1:1

Medium parameters used:  $f = 2450 \text{ MHz}$ ;  $\sigma = 1.962 \text{ S/m}$ ;  $\epsilon_r = 51.178$ ;  $\rho = 1000 \text{ kg/m}^3$

Phantom section: Flat Section

Measurement Standard: DASY5 (IEEE/IEC/ANSI C63.19-2011)

DASY Configuration:

- Area Scan setting - Find Secondary Maximum Within: 2.0dB and with a peak SAR value greater than 0.5 W/Kg
- Probe: EX3DV4 - SN3847; ConvF(7.29, 7.29, 7.29); Calibrated: 2015/1/30;
- Sensor-Surface: 2mm (Mechanical Surface Detection)
- Electronics: DAE4 Sn541; Calibrated: 2015/2/3
- Phantom: SAM with CRP; Type: SAM; Serial: TP-1150 and higher
- Measurement SW: DASY52, Version 52.8 (8); SEMCAD X Version 14.6.10 (7331)

**System Performance Check at 2450MHz/Area Scan (61x61x1):**

Interpolated grid:  $dx=1.500 \text{ mm}$ ,  $dy=1.500 \text{ mm}$

Maximum value of SAR (interpolated) = 19.9 W/kg

**System Performance Check at 2450MHz/Zoom Scan (7x7x7)/Cube 0:**

Measurement grid:  $dx=5\text{mm}$ ,  $dy=5\text{mm}$ ,  $dz=5\text{mm}$

Reference Value = 103.9 V/m; Power Drift = -0.02 dB

Peak SAR (extrapolated) = 26.3 W/kg

**SAR(1 g) = 13.5 W/kg; SAR(10 g) = 6.29 W/kg**

Maximum value of SAR (measured) = 20.1 W/kg

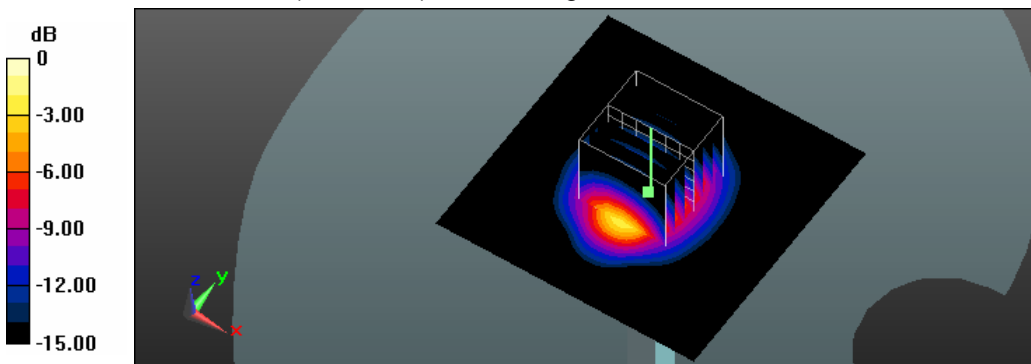

0 dB = 20.1 W/kg = 13.03 dBW/kg

## Appendix B - SAR Measurement Data

Test Laboratory: A Test Lab Techno Corp.

Date: 2015/10/6 Time: PM 05:01:27

### 4\_GPRS 850 CH190\_3D2U\_Side 1\_0mm

**DUT: PA820; Type: Rugged Handheld Computer; Serial: 359998040102016**

Communication System: UID 0, GPRS 850 (3Down, 2Up) (0); Frequency: 836.6 MHz; Duty Cycle: 1:4  
 Medium parameters used:  $f = 837$  MHz;  $\sigma = 0.981$  S/m;  $\epsilon_r = 54.873$ ;  $\rho = 1000$  kg/m<sup>3</sup>

Phantom section: Flat Section

Measurement Standard: DASYS5 (IEEE/IEC/ANSI C63.19-2011)

DASY Configuration:

- Area Scan setting - Find Secondary Maximum Within: 2.0dB and with a peak SAR value greater than 0.5 W/Kg
- Probe: EX3DV4 - SN3847; ConvF(9.42, 9.42, 9.42); Calibrated: 2015/1/30;
- Sensor-Surface: 2mm (Mechanical Surface Detection)
- Electronics: DAE4 Sn541; Calibrated: 2015/2/3
- Phantom: SAM with CRP; Type: SAM; Serial: TP-1150 and higher
- Measurement SW: DASYS52, Version 52.8 (8); SEMCAD X Version 14.6.10 (7331)

**Flat/Area Scan (81x131x1):** Interpolated grid: dx=1.500 mm, dy=1.500 mm

Maximum value of SAR (interpolated) = 0.504 W/kg

**Flat/Zoom Scan (5x5x7)/Cube 0:** Measurement grid: dx=8mm, dy=8mm, dz=5mm

Reference Value = 23.01 V/m; Power Drift = -0.00 dB

Peak SAR (extrapolated) = 0.598 W/kg

**SAR(1 g) = 0.395 W/kg; SAR(10 g) = 0.249 W/kg**

Maximum value of SAR (measured) = 0.500 W/kg

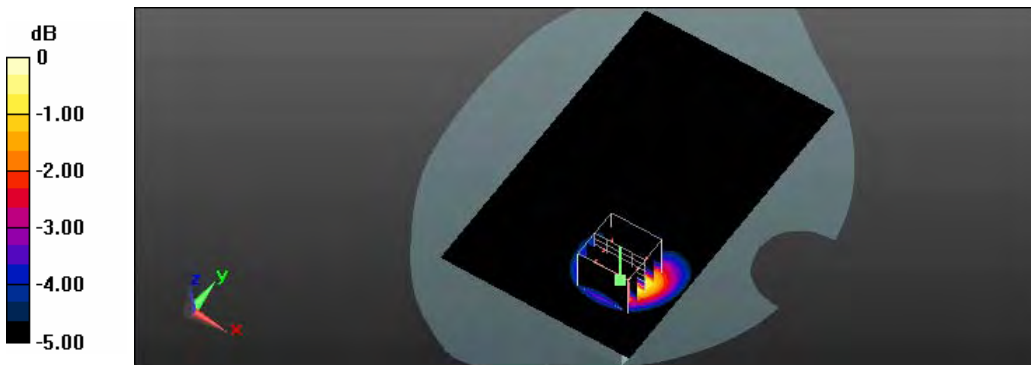

0 dB = 0.500 W/kg = -3.01 dBW/kg

Test Laboratory: A Test Lab Techno Corp.

Date: 2015/10/6 Time: PM 04:30:11

**5\_GPRS 850 CH190\_3D2U\_Side 2\_0mm**

**DUT: PA820; Type: Rugged Handheld Computer; Serial: 359998040102016**

Communication System: UID 0, GPRS 850 (3Down, 2Up) (0); Frequency: 836.6 MHz; Duty Cycle: 1:4

Medium parameters used:  $f = 837$  MHz;  $\sigma = 0.981$  S/m;  $\epsilon_r = 54.873$ ;  $\rho = 1000$  kg/m<sup>3</sup>

Phantom section: Flat Section

Measurement Standard: DASY5 (IEEE/IEC/ANSI C63.19-2011)

DASY Configuration:

- Area Scan setting - Find Secondary Maximum Within: 2.0dB and with a peak SAR value greater than 0.5 W/Kg
- Probe: EX3DV4 - SN3847; ConvF(9.42, 9.42, 9.42); Calibrated: 2015/1/30;
- Sensor-Surface: 2mm (Mechanical Surface Detection)
- Electronics: DAE4 Sn541; Calibrated: 2015/2/3
- Phantom: SAM with CRP; Type: SAM; Serial: TP-1150 and higher
- Measurement SW: DASY52, Version 52.8 (8); SEMCAD X Version 14.6.10 (7331)

**Flat/Area Scan (81x131x1):** Interpolated grid: dx=1.500 mm, dy=1.500 mm

Maximum value of SAR (interpolated) = 0.519 W/kg

**Flat/Zoom Scan (5x5x7)/Cube 0:** Measurement grid: dx=8mm, dy=8mm, dz=5mm

Reference Value = 23.10 V/m; Power Drift = 0.06 dB

Peak SAR (extrapolated) = 0.596 W/kg

**SAR(1 g) = 0.435 W/kg; SAR(10 g) = 0.313 W/kg**

Maximum value of SAR (measured) = 0.527 W/kg

**Flat/Zoom Scan (5x5x7)/Cube 1:** Measurement grid: dx=8mm, dy=8mm, dz=5mm

Reference Value = 23.10 V/m; Power Drift = 0.06 dB

Peak SAR (extrapolated) = 0.554 W/kg

**SAR(1 g) = 0.434 W/kg; SAR(10 g) = 0.324 W/kg**

Maximum value of SAR (measured) = 0.503 W/kg

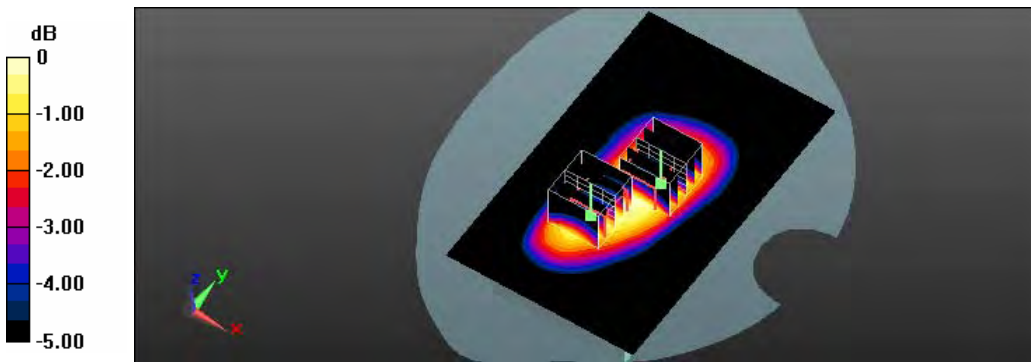

0 dB = 0.503 W/kg = -2.98 dBW/kg



Test Laboratory: A Test Lab Techno Corp.

Date: 2015/10/6 Time: PM 04:11:05

**6\_GPRS 850 CH190\_3D2U\_Side 4\_0mm**

**DUT: PA820; Type: Rugged Handheld Computer; Serial: 359998040102016**

Communication System: UID 0, GPRS 850 (3Down, 2Up) (0); Frequency: 836.6 MHz; Duty Cycle: 1:4

Medium parameters used:  $f = 837 \text{ MHz}$ ;  $\sigma = 0.981 \text{ S/m}$ ;  $\epsilon_r = 54.873$ ;  $\rho = 1000 \text{ kg/m}^3$

Phantom section: Flat Section

Measurement Standard: DASY5 (IEEE/IEC/ANSI C63.19-2011)

DASY Configuration:

- Area Scan setting - Find Secondary Maximum Within: 2.0dB and with a peak SAR value greater than 0.5 W/Kg
- Probe: EX3DV4 - SN3847; ConvF(9.42, 9.42, 9.42); Calibrated: 2015/1/30;
- Sensor-Surface: 2mm (Mechanical Surface Detection)
- Electronics: DAE4 Sn541; Calibrated: 2015/2/3
- Phantom: SAM with CRP; Type: SAM; Serial: TP-1150 and higher
- Measurement SW: DASY52, Version 52.8 (8); SEMCAD X Version 14.6.10 (7331)

**Flat/Area Scan (51x91x1):** Interpolated grid:  $dx=1.500 \text{ mm}$ ,  $dy=1.500 \text{ mm}$

Maximum value of SAR (interpolated) = 0.364 W/kg

**Flat/Zoom Scan (5x5x7)/Cube 0:** Measurement grid:  $dx=8\text{mm}$ ,  $dy=8\text{mm}$ ,  $dz=5\text{mm}$

Reference Value = 18.99 V/m; Power Drift = -0.00 dB

Peak SAR (extrapolated) = 0.437 W/kg

**SAR(1 g) = 0.275 W/kg; SAR(10 g) = 0.173 W/kg**

Maximum value of SAR (measured) = 0.359 W/kg

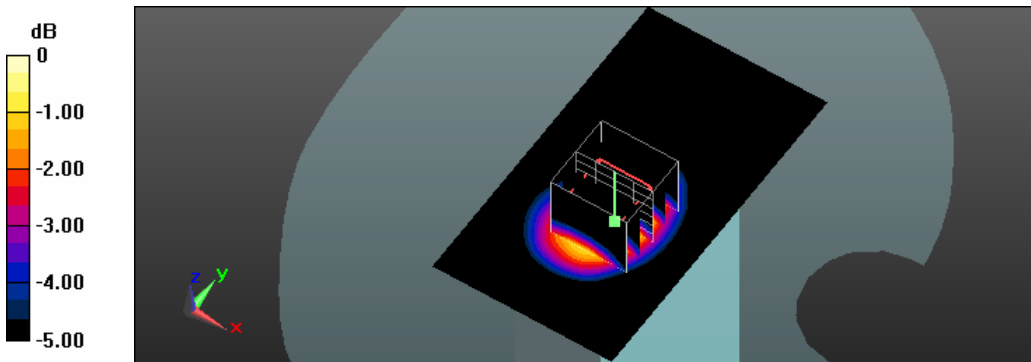

0 dB = 0.359 W/kg = -4.45 dBW/kg

Test Laboratory: A Test Lab Techno Corp.

Date: 2015/10/6 Time: PM 05:26:16

**7\_GPRS 850 CH190\_3D2U\_Side 5\_0mm**

**DUT: PA820; Type: Rugged Handheld Computer; Serial: 359998040102016**

Communication System: UID 0, GPRS 850 (3Down, 2Up) (0); Frequency: 836.6 MHz; Duty Cycle: 1:4

Medium parameters used:  $f = 837$  MHz;  $\sigma = 0.981$  S/m;  $\epsilon_r = 54.873$ ;  $\rho = 1000$  kg/m<sup>3</sup>

Phantom section: Flat Section

Measurement Standard: DASY5 (IEEE/IEC/ANSI C63.19-2011)

DASY Configuration:

- Area Scan setting - Find Secondary Maximum Within: 2.0dB and with a peak SAR value greater than 0.5 W/Kg
- Probe: EX3DV4 - SN3847; ConvF(9.42, 9.42, 9.42); Calibrated: 2015/1/30;
- Sensor-Surface: 2mm (Mechanical Surface Detection)
- Electronics: DAE4 Sn541; Calibrated: 2015/2/3
- Phantom: SAM with CRP; Type: SAM; Serial: TP-1150 and higher
- Measurement SW: DASY52, Version 52.8 (8); SEMCAD X Version 14.6.10 (7331)

**Flat/Area Scan (51x141x1):** Interpolated grid: dx=1.500 mm, dy=1.500 mm

Maximum value of SAR (interpolated) = 0.272 W/kg

**Flat/Zoom Scan (5x5x7)/Cube 0:** Measurement grid: dx=8mm, dy=8mm, dz=5mm

Reference Value = 16.64 V/m; Power Drift = 0.02 dB

Peak SAR (extrapolated) = 0.303 W/kg

**SAR(1 g) = 0.221 W/kg; SAR(10 g) = 0.157 W/kg**

Maximum value of SAR (measured) = 0.265 W/kg

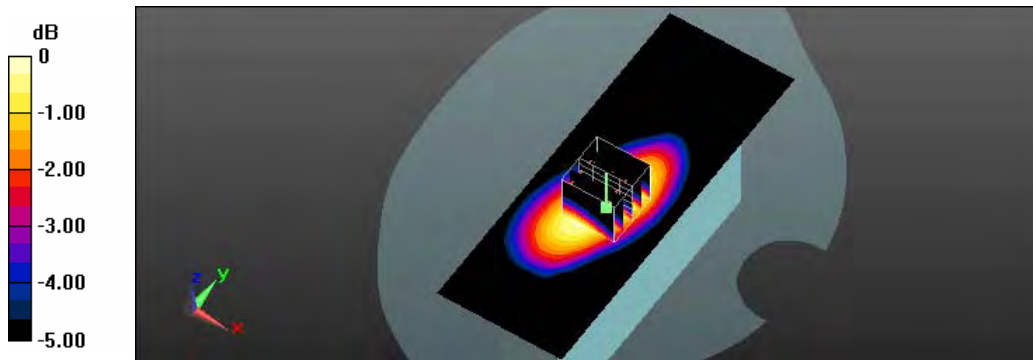

0 dB = 0.265 W/kg = -5.77 dBW/kg

Test Laboratory: A Test Lab Techno Corp.

Date: 2015/10/6 Time: PM 05:47:07

**8\_GPRS 850 CH190\_3D2U\_Side 6\_0mm**

**DUT: PA820; Type: Rugged Handheld Computer; Serial: 359998040102016**

Communication System: UID 0, GPRS 850 (3Down, 2Up) (0); Frequency: 836.6 MHz; Duty Cycle: 1:4

Medium parameters used:  $f = 837 \text{ MHz}$ ;  $\sigma = 0.981 \text{ S/m}$ ;  $\epsilon_r = 54.873$ ;  $\rho = 1000 \text{ kg/m}^3$

Phantom section: Flat Section

Measurement Standard: DASY5 (IEEE/IEC/ANSI C63.19-2011)

DASY Configuration:

- Area Scan setting - Find Secondary Maximum Within: 2.0dB and with a peak SAR value greater than 0.5 W/Kg
- Probe: EX3DV4 - SN3847; ConvF(9.42, 9.42, 9.42); Calibrated: 2015/1/30;
- Sensor-Surface: 2mm (Mechanical Surface Detection)
- Electronics: DAE4 Sn541; Calibrated: 2015/2/3
- Phantom: SAM with CRP; Type: SAM; Serial: TP-1150 and higher
- Measurement SW: DASY52, Version 52.8 (8); SEMCAD X Version 14.6.10 (7331)

**Flat/Area Scan (51x141x1):** Interpolated grid:  $dx=1.500 \text{ mm}$ ,  $dy=1.500 \text{ mm}$

Maximum value of SAR (interpolated) = 0.593 W/kg

**Flat/Zoom Scan (5x5x7)/Cube 0:** Measurement grid:  $dx=8\text{mm}$ ,  $dy=8\text{mm}$ ,  $dz=5\text{mm}$

Reference Value = 24.89 V/m; Power Drift = -0.09 dB

Peak SAR (extrapolated) = 0.817 W/kg

**SAR(1 g) = 0.459 W/kg; SAR(10 g) = 0.262 W/kg**

Maximum value of SAR (measured) = 0.612 W/kg

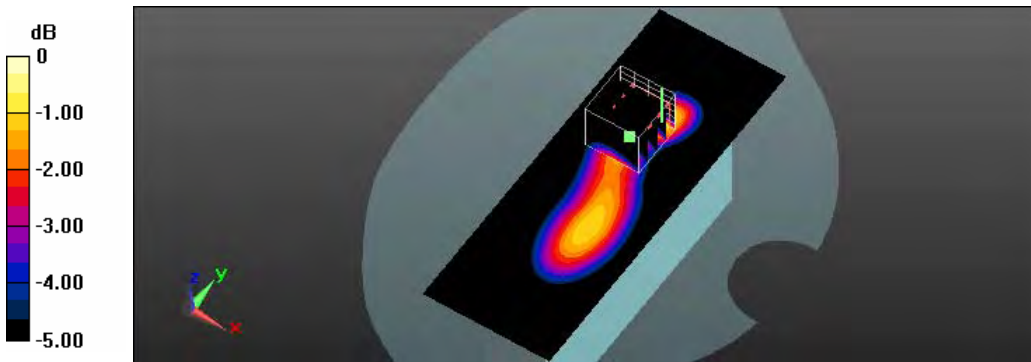

0 dB = 0.612 W/kg = -2.13 dBW/kg

Test Laboratory: A Test Lab Techno Corp.

Date: 2015/10/11 Time: PM 03:28:56

**31\_GPRS 1900 CH661\_3D2U\_Side 1\_0mm**

**DUT: PA820; Type: Rugged Handheld Computer; Serial: 359998040102016**

Communication System: UID 0, GPRS PCS (3Down,2Up) (0); Frequency: 1880 MHz; Duty Cycle: 1:4

Medium parameters used:  $f = 1880 \text{ MHz}$ ;  $\sigma = 1.48 \text{ S/m}$ ;  $\epsilon_r = 54.534$ ;  $\rho = 1000 \text{ kg/m}^3$

Phantom section: Flat Section

Measurement Standard: DASY5 (IEEE/IEC/ANSI C63.19-2011)

DASY Configuration:

- Area Scan setting - Find Secondary Maximum Within: 2.0dB and with a peak SAR value greater than 0.5 W/Kg
- Probe: EX3DV4 - SN3847; ConvF(7.46, 7.46, 7.46); Calibrated: 2015/1/30;
- Sensor-Surface: 2mm (Mechanical Surface Detection)
- Electronics: DAE4 Sn541; Calibrated: 2015/2/3
- Phantom: SAM with CRP; Type: SAM; Serial: TP-1150 and higher
- Measurement SW: DASY52, Version 52.8 (8); SEMCAD X Version 14.6.10 (7331)

**Flat/Area Scan (81x131x1):** Interpolated grid:  $dx=1.500 \text{ mm}$ ,  $dy=1.500 \text{ mm}$

Maximum value of SAR (interpolated) = 0.251 W/kg

**Flat/Zoom Scan (5x5x7)/Cube 0:** Measurement grid:  $dx=8\text{mm}$ ,  $dy=8\text{mm}$ ,  $dz=5\text{mm}$

Reference Value = 13.43 V/m; Power Drift = 0.08 dB

Peak SAR (extrapolated) = 0.337 W/kg

**SAR(1 g) = 0.218 W/kg; SAR(10 g) = 0.136 W/kg**

Maximum value of SAR (measured) = 0.275 W/kg

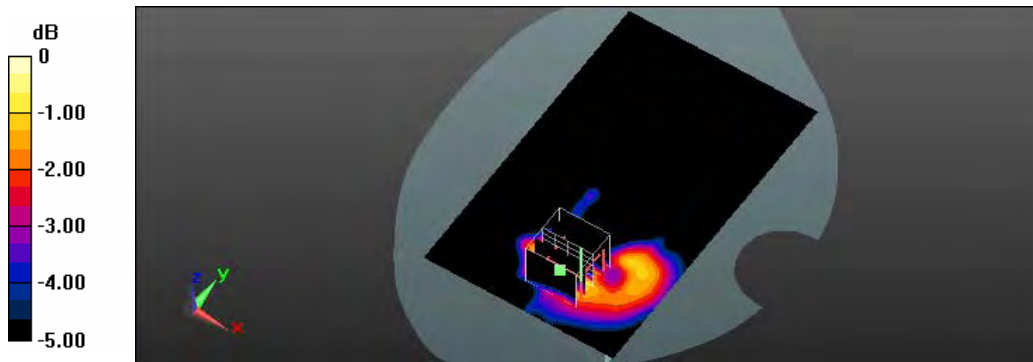

0 dB = 0.275 W/kg = -5.61 dBW/kg

Test Laboratory: A Test Lab Techno Corp.

Date: 2015/10/11 Time: PM 03:06:59

**30\_GPRS 1900 CH661\_3D2U\_Side 2\_0mm**

**DUT: PA820; Type: Rugged Handheld Computer; Serial: 359998040102016**

Communication System: UID 0, GPRS PCS (3Down,2Up) (0); Frequency: 1880 MHz; Duty Cycle: 1:4

Medium parameters used:  $f = 1880 \text{ MHz}$ ;  $\sigma = 1.48 \text{ S/m}$ ;  $\epsilon_r = 54.534$ ;  $\rho = 1000 \text{ kg/m}^3$

Phantom section: Flat Section

Measurement Standard: DASY5 (IEEE/IEC/ANSI C63.19-2011)

DASY Configuration:

- Area Scan setting - Find Secondary Maximum Within: 2.0dB and with a peak SAR value greater than 0.5 W/Kg
- Probe: EX3DV4 - SN3847; ConvF(7.46, 7.46, 7.46); Calibrated: 2015/1/30;
- Sensor-Surface: 2mm (Mechanical Surface Detection)
- Electronics: DAE4 Sn541; Calibrated: 2015/2/3
- Phantom: SAM with CRP; Type: SAM; Serial: TP-1150 and higher
- Measurement SW: DASY52, Version 52.8 (8); SEMCAD X Version 14.6.10 (7331)

**Flat/Area Scan (81x131x1):** Interpolated grid:  $dx=1.500 \text{ mm}$ ,  $dy=1.500 \text{ mm}$

Maximum value of SAR (interpolated) = 0.433 W/kg

**Flat/Zoom Scan (5x5x7)/Cube 0:** Measurement grid:  $dx=8\text{mm}$ ,  $dy=8\text{mm}$ ,  $dz=5\text{mm}$

Reference Value = 16.82 V/m; Power Drift = 0.08 dB

Peak SAR (extrapolated) = 0.581 W/kg

**SAR(1 g) = 0.360 W/kg; SAR(10 g) = 0.213 W/kg**

Maximum value of SAR (measured) = 0.485 W/kg

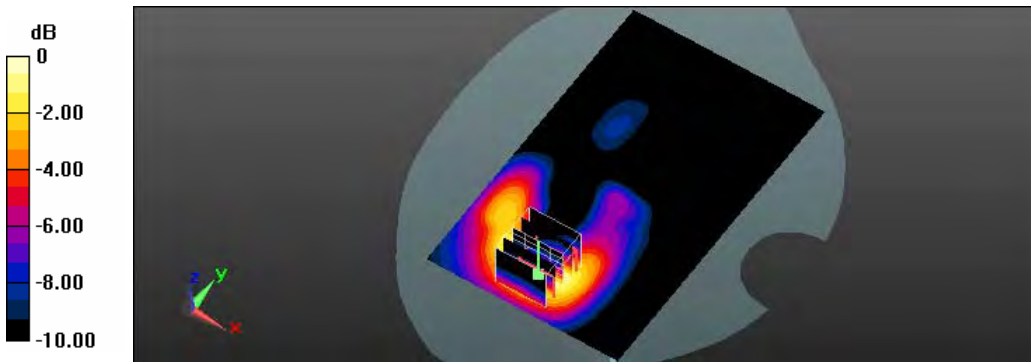

0 dB = 0.485 W/kg = -3.14 dBW/kg

Test Laboratory: A Test Lab Techno Corp.

Date: 2015/10/11 Time: PM 02:48:02

**29\_GPRS 1900 CH661\_3D2U\_Side 4\_0mm**

**DUT: PA820; Type: Rugged Handheld Computer; Serial: 359998040102016**

Communication System: UID 0, GPRS PCS (3Down,2Up) (0); Frequency: 1880 MHz; Duty Cycle: 1:4

Medium parameters used:  $f = 1880 \text{ MHz}$ ;  $\sigma = 1.48 \text{ S/m}$ ;  $\epsilon_r = 54.534$ ;  $\rho = 1000 \text{ kg/m}^3$

Phantom section: Flat Section

Measurement Standard: DASY5 (IEEE/IEC/ANSI C63.19-2011)

DASY Configuration:

- Area Scan setting - Find Secondary Maximum Within: 2.0dB and with a peak SAR value greater than 0.5 W/Kg
- Probe: EX3DV4 - SN3847; ConvF(7.46, 7.46, 7.46); Calibrated: 2015/1/30;
- Sensor-Surface: 2mm (Mechanical Surface Detection)
- Electronics: DAE4 Sn541; Calibrated: 2015/2/3
- Phantom: SAM with CRP; Type: SAM; Serial: TP-1150 and higher
- Measurement SW: DASY52, Version 52.8 (8); SEMCAD X Version 14.6.10 (7331)

**Flat/Area Scan (51x91x1):** Interpolated grid:  $dx=1.500 \text{ mm}$ ,  $dy=1.500 \text{ mm}$

Maximum value of SAR (interpolated) = 0.579 W/kg

**Flat/Zoom Scan (5x5x7)/Cube 0:** Measurement grid:  $dx=8\text{mm}$ ,  $dy=8\text{mm}$ ,  $dz=5\text{mm}$

Reference Value = 18.47 V/m; Power Drift = 0.00 dB

Peak SAR (extrapolated) = 0.704 W/kg

**SAR(1 g) = 0.414 W/kg; SAR(10 g) = 0.241 W/kg**

Maximum value of SAR (measured) = 0.557 W/kg

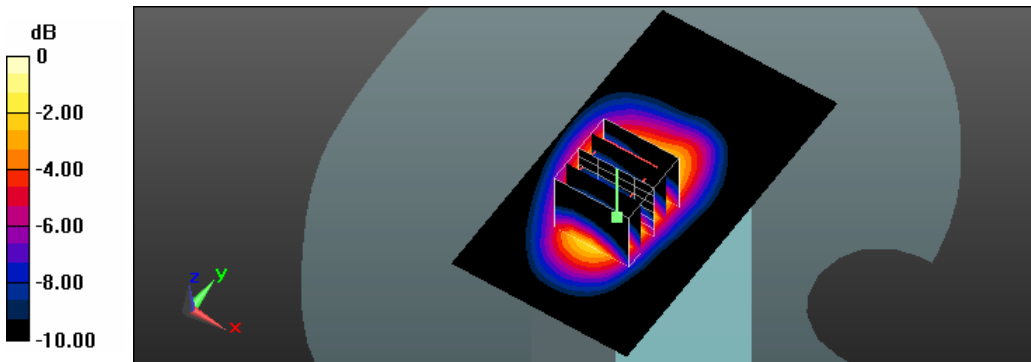

0 dB = 0.557 W/kg = -2.54 dBW/kg

Test Laboratory: A Test Lab Techno Corp.

Date: 2015/10/11 Time: PM 02:28:36

**28\_GPRS 1900 CH661\_3D2U\_Side 6\_0mm**

**DUT: PA820; Type: Rugged Handheld Computer; Serial: 359998040102016**

Communication System: UID 0, GPRS PCS (3Down,2Up) (0); Frequency: 1880 MHz; Duty Cycle: 1:4

Medium parameters used:  $f = 1880 \text{ MHz}$ ;  $\sigma = 1.48 \text{ S/m}$ ;  $\epsilon_r = 54.534$ ;  $\rho = 1000 \text{ kg/m}^3$

Phantom section: Flat Section

Measurement Standard: DASY5 (IEEE/IEC/ANSI C63.19-2011)

DASY Configuration:

- Area Scan setting - Find Secondary Maximum Within: 2.0dB and with a peak SAR value greater than 0.5 W/Kg
- Probe: EX3DV4 - SN3847; ConvF(7.46, 7.46, 7.46); Calibrated: 2015/1/30;
- Sensor-Surface: 2mm (Mechanical Surface Detection)
- Electronics: DAE4 Sn541; Calibrated: 2015/2/3
- Phantom: SAM with CRP; Type: SAM; Serial: TP-1150 and higher
- Measurement SW: DASY52, Version 52.8 (8); SEMCAD X Version 14.6.10 (7331)

**Flat/Area Scan (51x141x1):** Interpolated grid:  $dx=1.500 \text{ mm}$ ,  $dy=1.500 \text{ mm}$

Maximum value of SAR (interpolated) = 0.191 W/kg

**Flat/Zoom Scan (5x5x7)/Cube 0:** Measurement grid:  $dx=8\text{mm}$ ,  $dy=8\text{mm}$ ,  $dz=5\text{mm}$

Reference Value = 10.78 V/m; Power Drift = 0.02 dB

Peak SAR (extrapolated) = 0.303 W/kg

**SAR(1 g) = 0.168 W/kg; SAR(10 g) = 0.086 W/kg**

Maximum value of SAR (measured) = 0.242 W/kg

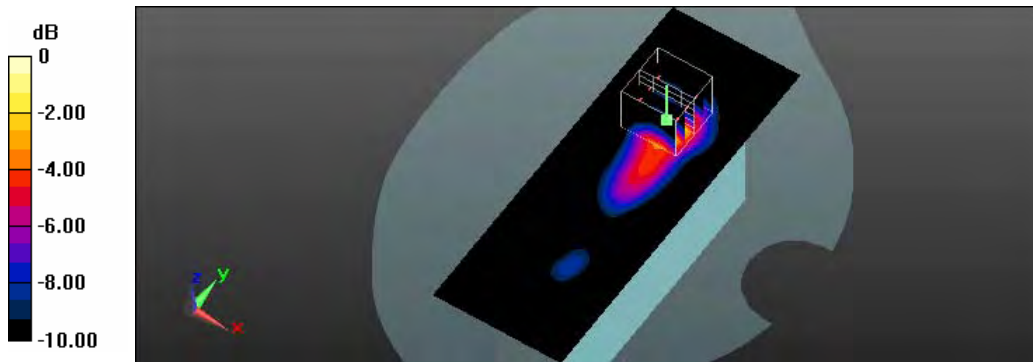

0 dB = 0.242 W/kg = -6.16 dBW/kg

Test Laboratory: A Test Lab Techno Corp.

Date: 2015/10/6 Time: PM 11:36:36

**13\_WCDMA Band II CH9400\_RMC-12.2K\_Side 1\_0mm**

**DUT: PA820; Type: Rugged Handheld Computer; Serial: 359998040102016**

Communication System: UID 0, WCDMA Band II (0); Frequency: 1880 MHz; Duty Cycle: 1:1

Medium parameters used:  $f = 1880 \text{ MHz}$ ;  $\sigma = 1.48 \text{ S/m}$ ;  $\epsilon_r = 54.534$ ;  $\rho = 1000 \text{ kg/m}^3$

Phantom section: Flat Section

Measurement Standard: DASY5 (IEEE/IEC/ANSI C63.19-2011)

DASY Configuration:

- Area Scan setting - Find Secondary Maximum Within: 2.0dB and with a peak SAR value greater than 0.5 W/Kg
- Probe: EX3DV4 - SN3847; ConvF(7.46, 7.46, 7.46); Calibrated: 2015/1/30;
- Sensor-Surface: 2mm (Mechanical Surface Detection)
- Electronics: DAE4 Sn541; Calibrated: 2015/2/3
- Phantom: SAM with CRP; Type: SAM; Serial: TP-1150 and higher
- Measurement SW: DASY52, Version 52.8 (8); SEMCAD X Version 14.6.10 (7331)

**Flat/Area Scan (81x131x1):** Interpolated grid:  $dx=1.500 \text{ mm}$ ,  $dy=1.500 \text{ mm}$

Maximum value of SAR (interpolated) = 0.345 W/kg

**Flat/Zoom Scan (5x5x7)/Cube 0:** Measurement grid:  $dx=8\text{mm}$ ,  $dy=8\text{mm}$ ,  $dz=5\text{mm}$

Reference Value = 15.34 V/m; Power Drift = 0.05 dB

Peak SAR (extrapolated) = 0.413 W/kg

**SAR(1 g) = 0.270 W/kg; SAR(10 g) = 0.171 W/kg**

Maximum value of SAR (measured) = 0.352 W/kg

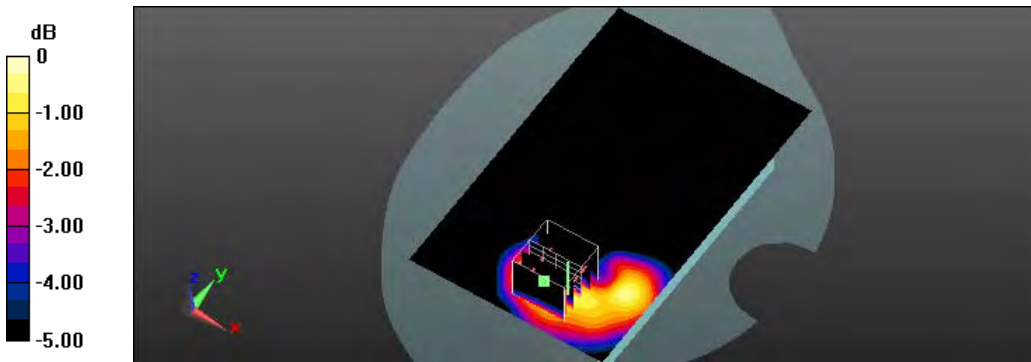

0 dB = 0.352 W/kg = -4.53 dBW/kg



Test Laboratory: A Test Lab Techno Corp.

Date: 2015/10/7 Time: AM 12:23:35

**14\_WCDMA Band II CH9400\_RMC-12.2K\_Side 2\_0mm**

**DUT: PA820; Type: Rugged Handheld Computer; Serial: 359998040102016**

Communication System: UID 0, WCDMA Band II (0); Frequency: 1880 MHz; Duty Cycle: 1:1

Medium parameters used:  $f = 1880$  MHz;  $\sigma = 1.48$  S/m;  $\epsilon_r = 54.534$ ;  $\rho = 1000$  kg/m<sup>3</sup>

Phantom section: Flat Section

Measurement Standard: DASY5 (IEEE/IEC/ANSI C63.19-2011)

DASY Configuration:

- Area Scan setting - Find Secondary Maximum Within: 2.0dB and with a peak SAR value greater than 0.5 W/Kg
- Probe: EX3DV4 - SN3847; ConvF(7.46, 7.46, 7.46); Calibrated: 2015/1/30;
- Sensor-Surface: 2mm (Mechanical Surface Detection)
- Electronics: DAE4 Sn541; Calibrated: 2015/2/3
- Phantom: SAM with CRP; Type: SAM; Serial: TP-1150 and higher
- Measurement SW: DASY52, Version 52.8 (8); SEMCAD X Version 14.6.10 (7331)

**Flat/Area Scan (81x131x1):** Interpolated grid: dx=1.500 mm, dy=1.500 mm

Maximum value of SAR (interpolated) = 0.862 W/kg

**Flat/Zoom Scan (5x5x7)/Cube 0:** Measurement grid: dx=8mm, dy=8mm, dz=5mm

Reference Value = 22.47 V/m; Power Drift = 0.06 dB

Peak SAR (extrapolated) = 1.05 W/kg

**SAR(1 g) = 0.681 W/kg; SAR(10 g) = 0.412 W/kg**

Maximum value of SAR (measured) = 0.876 W/kg

**Flat/Zoom Scan (5x5x7)/Cube 1:** Measurement grid: dx=8mm, dy=8mm, dz=5mm

Reference Value = 22.47 V/m; Power Drift = 0.06 dB

Peak SAR (extrapolated) = 0.970 W/kg

**SAR(1 g) = 0.525 W/kg; SAR(10 g) = 0.264 W/kg**

Maximum value of SAR (measured) = 0.795 W/kg

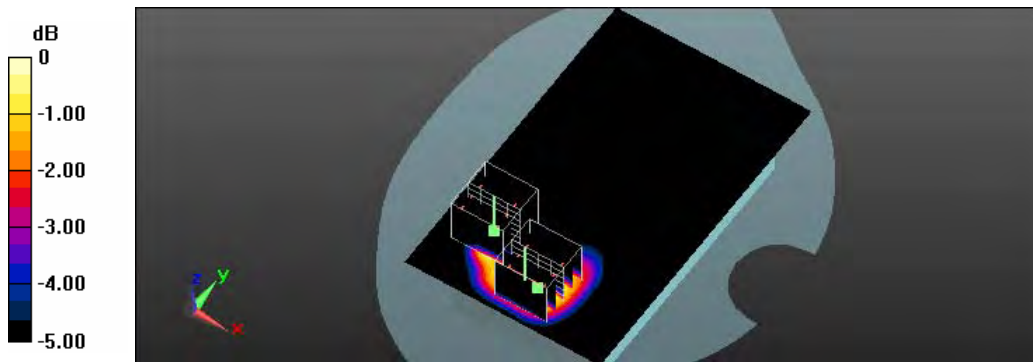

0 dB = 0.795 W/kg = -1.00 dBW/kg

Test Laboratory: A Test Lab Techno Corp.

Date: 2015/10/8 Time: PM 11:05:18

**19\_WCDMA Band II CH9262\_RMC-12.2K\_Side 4\_0mm**

**DUT: PA820; Type: Rugged Handheld Computer; Serial: 359998040102016**

Communication System: UID 0, WCDMA Band II (0); Frequency: 1852.4 MHz; Duty Cycle: 1:1

Medium parameters used:  $f = 1852.4 \text{ MHz}$ ;  $\sigma = 1.462 \text{ S/m}$ ;  $\epsilon_r = 54.612$ ;  $\rho = 1000 \text{ kg/m}^3$

Phantom section: Flat Section

Measurement Standard: DASY5 (IEEE/IEC/ANSI C63.19-2011)

DASY Configuration:

- Area Scan setting - Find Secondary Maximum Within: 2.0dB and with a peak SAR value greater than 0.5 W/Kg
- Probe: EX3DV4 - SN3847; ConvF(7.46, 7.46, 7.46); Calibrated: 2015/1/30;
- Sensor-Surface: 2mm (Mechanical Surface Detection)
- Electronics: DAE4 Sn541; Calibrated: 2015/2/3
- Phantom: SAM with CRP; Type: SAM; Serial: TP-1150 and higher
- Measurement SW: DASY52, Version 52.8 (8); SEMCAD X Version 14.6.10 (7331)

**Flat/Area Scan (51x91x1):** Interpolated grid:  $dx=1.500 \text{ mm}$ ,  $dy=1.500 \text{ mm}$

Maximum value of SAR (interpolated) = 1.29 W/kg

**Flat/Zoom Scan (5x5x7)/Cube 0:** Measurement grid:  $dx=8\text{mm}$ ,  $dy=8\text{mm}$ ,  $dz=5\text{mm}$

Reference Value = 29.04 V/m; Power Drift = -0.16 dB

Peak SAR (extrapolated) = 1.55 W/kg

**SAR(1 g) = 0.911 W/kg; SAR(10 g) = 0.482 W/kg**

Maximum value of SAR (measured) = 1.17 W/kg

**Flat/Zoom Scan (5x5x7)/Cube 1:** Measurement grid:  $dx=8\text{mm}$ ,  $dy=8\text{mm}$ ,  $dz=5\text{mm}$

Reference Value = 29.04 V/m; Power Drift = -0.16 dB

Peak SAR (extrapolated) = 1.52 W/kg

**SAR(1 g) = 0.902 W/kg; SAR(10 g) = 0.526 W/kg**

Maximum value of SAR (measured) = 1.22 W/kg

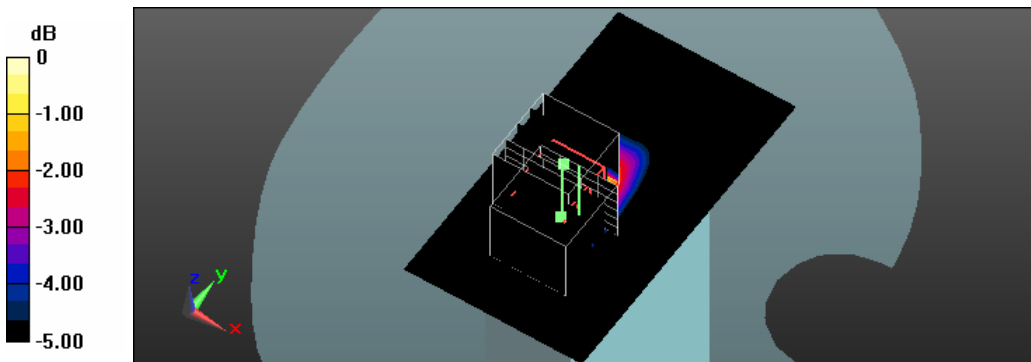

0 dB = 1.22 W/kg = 0.86 dBW/kg

Test Laboratory: A Test Lab Techno Corp.

Date: 2015/10/8 Time: PM 10:47:56

**15\_WCDMA Band II CH9400\_RMC-12.2K\_Side 4\_0mm**

**DUT: PA820; Type: Rugged Handheld Computer; Serial: 359998040102016**

Communication System: UID 0, WCDMA Band II (0); Frequency: 1880 MHz; Duty Cycle: 1:1

Medium parameters used:  $f = 1880 \text{ MHz}$ ;  $\sigma = 1.48 \text{ S/m}$ ;  $\epsilon_r = 54.534$ ;  $\rho = 1000 \text{ kg/m}^3$

Phantom section: Flat Section

Measurement Standard: DASY5 (IEEE/IEC/ANSI C63.19-2011)

DASY Configuration:

- Area Scan setting - Find Secondary Maximum Within: 2.0dB and with a peak SAR value greater than 0.5 W/Kg
- Probe: EX3DV4 - SN3847; ConvF(7.46, 7.46, 7.46); Calibrated: 2015/1/30;
- Sensor-Surface: 2mm (Mechanical Surface Detection)
- Electronics: DAE4 Sn541; Calibrated: 2015/2/3
- Phantom: SAM with CRP; Type: SAM; Serial: TP-1150 and higher
- Measurement SW: DASY52, Version 52.8 (8); SEMCAD X Version 14.6.10 (7331)

**Flat/Area Scan (51x91x1):** Interpolated grid:  $dx=1.500 \text{ mm}$ ,  $dy=1.500 \text{ mm}$

Maximum value of SAR (interpolated) = 1.17 W/kg

**Flat/Zoom Scan (5x5x7)/Cube 0:** Measurement grid:  $dx=8\text{mm}$ ,  $dy=8\text{mm}$ ,  $dz=5\text{mm}$

Reference Value = 26.99 V/m; Power Drift = -0.11 dB

Peak SAR (extrapolated) = 1.38 W/kg

**SAR(1 g) = 0.818 W/kg; SAR(10 g) = 0.480 W/kg**

Maximum value of SAR (measured) = 1.07 W/kg

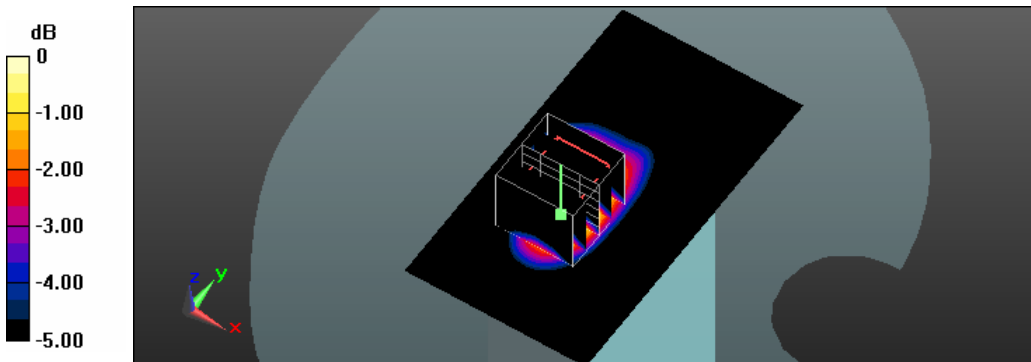

0 dB = 1.07 W/kg = 0.29 dBW/kg

Test Laboratory: A Test Lab Techno Corp.

Date: 2015/10/8 Time: PM 11:25:23

**20\_WCDMA Band II CH9538\_RMC-12.2K\_Side 4\_0mm**

**DUT: PA820; Type: Rugged Handheld Computer; Serial: 359998040102016**

Communication System: UID 0, WCDMA Band II (0); Frequency: 1907.6 MHz; Duty Cycle: 1:1

Medium parameters used:  $f = 1908 \text{ MHz}$ ;  $\sigma = 1.514 \text{ S/m}$ ;  $\epsilon_r = 54.324$ ;  $\rho = 1000 \text{ kg/m}^3$

Phantom section: Flat Section

Measurement Standard: DASY5 (IEEE/IEC/ANSI C63.19-2011)

DASY Configuration:

- Area Scan setting - Find Secondary Maximum Within: 2.0dB and with a peak SAR value greater than 0.5 W/Kg
- Probe: EX3DV4 - SN3847; ConvF(7.46, 7.46, 7.46); Calibrated: 2015/1/30;
- Sensor-Surface: 2mm (Mechanical Surface Detection)
- Electronics: DAE4 Sn541; Calibrated: 2015/2/3
- Phantom: SAM with CRP; Type: SAM; Serial: TP-1150 and higher
- Measurement SW: DASY52, Version 52.8 (8); SEMCAD X Version 14.6.10 (7331)

**Flat/Area Scan (51x91x1):** Interpolated grid:  $dx=1.500 \text{ mm}$ ,  $dy=1.500 \text{ mm}$

Maximum value of SAR (interpolated) = 1.07 W/kg

**Flat/Zoom Scan (5x5x7)/Cube 0:** Measurement grid:  $dx=8\text{mm}$ ,  $dy=8\text{mm}$ ,  $dz=5\text{mm}$

Reference Value = 25.83 V/m; Power Drift = -0.05 dB

Peak SAR (extrapolated) = 1.29 W/kg

**SAR(1 g) = 0.771 W/kg; SAR(10 g) = 0.456 W/kg**

Maximum value of SAR (measured) = 1.02 W/kg

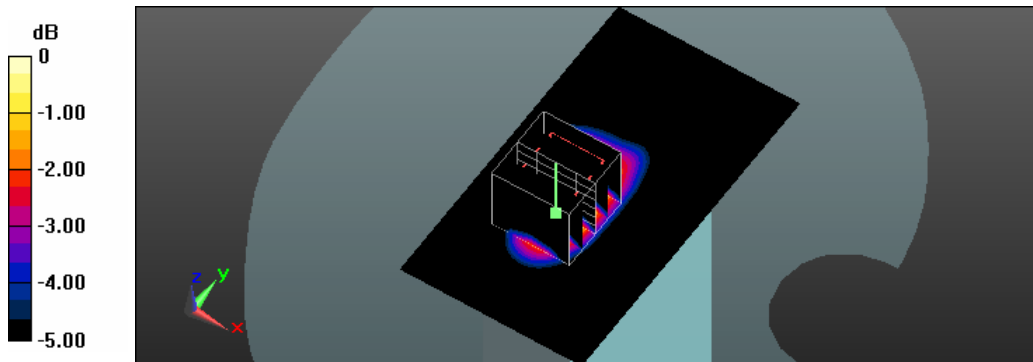

0 dB = 1.02 W/kg = 0.09 dBW/kg

Test Laboratory: A Test Lab Techno Corp.

Date: 2015/10/11 Time: AM 11:09:28

**21\_WCDMA Band II CH9262\_RMC-12.2K\_Side 6\_0mm**

**DUT: PA820; Type: Rugged Handheld Computer; Serial: 359998040102016**

Communication System: UID 0, WCDMA Band II (0); Frequency: 1852.4 MHz; Duty Cycle: 1:1

Medium parameters used:  $f = 1852.4 \text{ MHz}$ ;  $\sigma = 1.462 \text{ S/m}$ ;  $\epsilon_r = 54.612$ ;  $\rho = 1000 \text{ kg/m}^3$

Phantom section: Flat Section

Measurement Standard: DASY5 (IEEE/IEC/ANSI C63.19-2011)

DASY Configuration:

- Area Scan setting - Find Secondary Maximum Within: 2.0dB and with a peak SAR value greater than 0.5 W/Kg
- Probe: EX3DV4 - SN3847; ConvF(7.46, 7.46, 7.46); Calibrated: 2015/1/30;
- Sensor-Surface: 2mm (Mechanical Surface Detection)
- Electronics: DAE4 Sn541; Calibrated: 2015/2/3
- Phantom: SAM with CRP; Type: SAM; Serial: TP-1150 and higher
- Measurement SW: DASY52, Version 52.8 (8); SEMCAD X Version 14.6.10 (7331)

**Flat/Area Scan (51x141x1):** Interpolated grid:  $dx=1.500 \text{ mm}$ ,  $dy=1.500 \text{ mm}$

Maximum value of SAR (interpolated) = 1.64 W/kg

**Flat/Zoom Scan (5x5x7)/Cube 0:** Measurement grid:  $dx=8\text{mm}$ ,  $dy=8\text{mm}$ ,  $dz=5\text{mm}$

Reference Value = 28.77 V/m; Power Drift = 0.18 dB

Peak SAR (extrapolated) = 2.18 W/kg

**SAR(1 g) = 1.2 W/kg; SAR(10 g) = 0.607 W/kg**

Maximum value of SAR (measured) = 1.74 W/kg

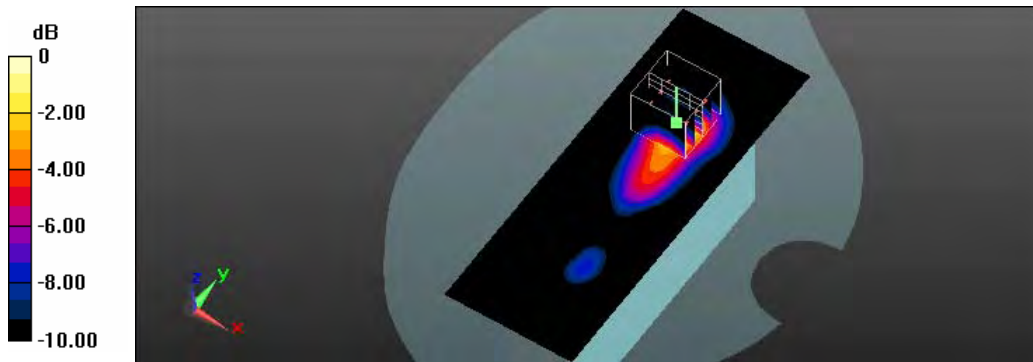

0 dB = 1.74 W/kg = 2.41 dBW/kg

Test Laboratory: A Test Lab Techno Corp.

Date: 2015/10/11 Time: AM 11:37:30

**16\_WCDMA Band II CH9400\_RMC-12.2K\_Side 6\_0mm**

**DUT: PA820; Type: Rugged Handheld Computer; Serial: 359998040102016**

Communication System: UID 0, WCDMA Band II (0); Frequency: 1880 MHz; Duty Cycle: 1:1

Medium parameters used:  $f = 1880 \text{ MHz}$ ;  $\sigma = 1.48 \text{ S/m}$ ;  $\epsilon_r = 54.534$ ;  $\rho = 1000 \text{ kg/m}^3$

Phantom section: Flat Section

Measurement Standard: DASY5 (IEEE/IEC/ANSI C63.19-2011)

DASY Configuration:

- Area Scan setting - Find Secondary Maximum Within: 2.0dB and with a peak SAR value greater than 0.5 W/Kg
- Probe: EX3DV4 - SN3847; ConvF(7.46, 7.46, 7.46); Calibrated: 2015/1/30;
- Sensor-Surface: 2mm (Mechanical Surface Detection)
- Electronics: DAE4 Sn541; Calibrated: 2015/2/3
- Phantom: SAM with CRP; Type: SAM; Serial: TP-1150 and higher
- Measurement SW: DASY52, Version 52.8 (8); SEMCAD X Version 14.6.10 (7331)

**Flat/Area Scan (51x141x1):** Interpolated grid:  $dx=1.500 \text{ mm}$ ,  $dy=1.500 \text{ mm}$

Maximum value of SAR (interpolated) = 1.24 W/kg

**Flat/Zoom Scan (5x5x7)/Cube 0:** Measurement grid:  $dx=8\text{mm}$ ,  $dy=8\text{mm}$ ,  $dz=5\text{mm}$

Reference Value = 25.79 V/m; Power Drift = 0.18 dB

Peak SAR (extrapolated) = 1.70 W/kg

**SAR(1 g) = 0.933 W/kg; SAR(10 g) = 0.471 W/kg**

Maximum value of SAR (measured) = 1.36 W/kg

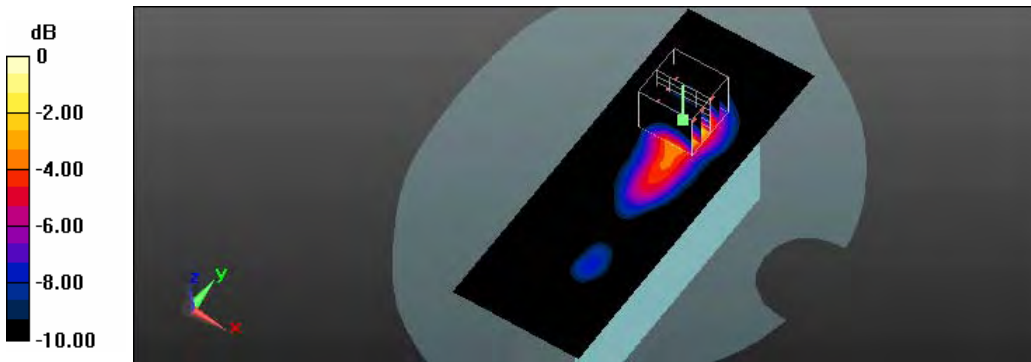

0 dB = 1.36 W/kg = 1.34 dBW/kg

Test Laboratory: A Test Lab Techno Corp.

Date: 2015/10/11 Time: AM 11:54:37

**22\_WCDMA Band II CH9538\_RMC-12.2K\_Side 6\_0mm**

**DUT: PA820; Type: Rugged Handheld Computer; Serial: 359998040102016**

Communication System: UID 0, WCDMA Band II (0); Frequency: 1907.6 MHz; Duty Cycle: 1:1

Medium parameters used:  $f = 1908 \text{ MHz}$ ;  $\sigma = 1.514 \text{ S/m}$ ;  $\epsilon_r = 54.324$ ;  $\rho = 1000 \text{ kg/m}^3$

Phantom section: Flat Section

Measurement Standard: DASY5 (IEEE/IEC/ANSI C63.19-2011)

DASY Configuration:

- Area Scan setting - Find Secondary Maximum Within: 2.0dB and with a peak SAR value greater than 0.5 W/Kg
- Probe: EX3DV4 - SN3847; ConvF(7.46, 7.46, 7.46); Calibrated: 2015/1/30;
- Sensor-Surface: 2mm (Mechanical Surface Detection)
- Electronics: DAE4 Sn541; Calibrated: 2015/2/3
- Phantom: SAM with CRP; Type: SAM; Serial: TP-1150 and higher
- Measurement SW: DASY52, Version 52.8 (8); SEMCAD X Version 14.6.10 (7331)

**Flat/Area Scan (51x141x1):** Interpolated grid:  $dx=1.500 \text{ mm}$ ,  $dy=1.500 \text{ mm}$

Maximum value of SAR (interpolated) = 1.18 W/kg

**Flat/Zoom Scan (5x5x7)/Cube 0:** Measurement grid:  $dx=8\text{mm}$ ,  $dy=8\text{mm}$ ,  $dz=5\text{mm}$

Reference Value = 25.27 V/m; Power Drift = 0.10 dB

Peak SAR (extrapolated) = 1.62 W/kg

**SAR(1 g) = 0.886 W/kg; SAR(10 g) = 0.446 W/kg**

Maximum value of SAR (measured) = 1.28 W/kg

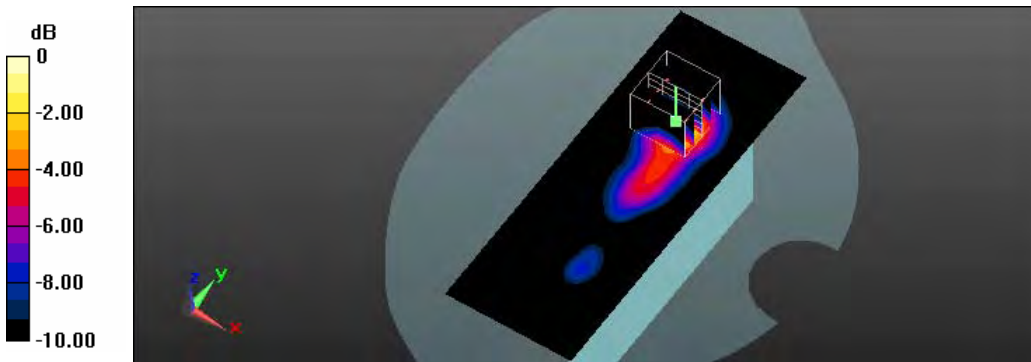

0 dB = 1.28 W/kg = 1.07 dBW/kg

Test Laboratory: A Test Lab Techno Corp.

Date: 2015/10/11 Time: PM 01:21:14

**25\_HSDPA Band II CH9262\_QPSK\_Sub-test1\_Side 6\_0mm**

**DUT: PA820; Type: Rugged Handheld Computer; Serial: 359998040102016**

Communication System: UID 0, HSDPA Band II (0); Frequency: 1852.4 MHz; Duty Cycle: 1:1

Medium parameters used:  $f = 1852.4$  MHz;  $\sigma = 1.462$  S/m;  $\epsilon_r = 54.612$ ;  $\rho = 1000$  kg/m<sup>3</sup>

Phantom section: Flat Section

Measurement Standard: DASY5 (IEEE/IEC/ANSI C63.19-2011)

DASY Configuration:

- Area Scan setting - Find Secondary Maximum Within: 2.0dB and with a peak SAR value greater than 0.5 W/Kg
- Probe: EX3DV4 - SN3847; ConvF(7.46, 7.46, 7.46); Calibrated: 2015/1/30;
- Sensor-Surface: 2mm (Mechanical Surface Detection)
- Electronics: DAE4 Sn541; Calibrated: 2015/2/3
- Phantom: SAM with CRP; Type: SAM; Serial: TP-1150 and higher
- Measurement SW: DASY52, Version 52.8 (8); SEMCAD X Version 14.6.10 (7331)

**Flat/Area Scan (51x141x1):** Interpolated grid: dx=1.500 mm, dy=1.500 mm

Maximum value of SAR (interpolated) = 1.59 W/kg

**Flat/Zoom Scan (5x5x7)/Cube 0:** Measurement grid: dx=8mm, dy=8mm, dz=5mm

Reference Value = 28.67 V/m; Power Drift = 0.13 dB

Peak SAR (extrapolated) = 2.11 W/kg

**SAR(1 g) = 1.17 W/kg; SAR(10 g) = 0.593 W/kg**

Maximum value of SAR (measured) = 1.69 W/kg

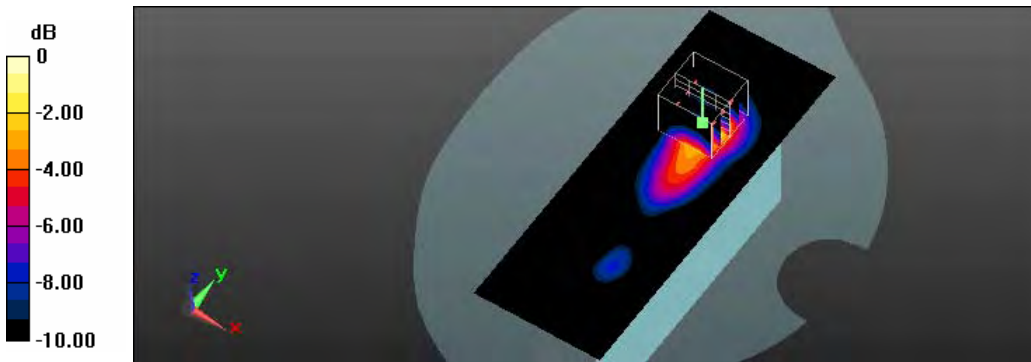

0 dB = 1.69 W/kg = 2.28 dBW/kg



Test Laboratory: A Test Lab Techno Corp.

Date: 2015/10/11 Time: PM 01:03:44

**24\_HSDPA Band II CH9400\_QPSK\_Sub-test1\_Side 6\_0mm**

**DUT: PA820; Type: Rugged Handheld Computer; Serial: 359998040102016**

Communication System: UID 0, HSDPA Band II (0); Frequency: 1880 MHz; Duty Cycle: 1:1

Medium parameters used:  $f = 1880$  MHz;  $\sigma = 1.48$  S/m;  $\epsilon_r = 54.534$ ;  $\rho = 1000$  kg/m<sup>3</sup>

Phantom section: Flat Section

Measurement Standard: DASY5 (IEEE/IEC/ANSI C63.19-2011)

DASY Configuration:

- Area Scan setting - Find Secondary Maximum Within: 2.0dB and with a peak SAR value greater than 0.5 W/Kg
- Probe: EX3DV4 - SN3847; ConvF(7.46, 7.46, 7.46); Calibrated: 2015/1/30;
- Sensor-Surface: 2mm (Mechanical Surface Detection)
- Electronics: DAE4 Sn541; Calibrated: 2015/2/3
- Phantom: SAM with CRP; Type: SAM; Serial: TP-1150 and higher
- Measurement SW: DASY52, Version 52.8 (8); SEMCAD X Version 14.6.10 (7331)

**Flat/Area Scan (51x141x1):** Interpolated grid: dx=1.500 mm, dy=1.500 mm

Maximum value of SAR (interpolated) = 1.19 W/kg

**Flat/Zoom Scan (5x5x7)/Cube 0:** Measurement grid: dx=8mm, dy=8mm, dz=5mm

Reference Value = 25.58 V/m; Power Drift = 0.09 dB

Peak SAR (extrapolated) = 1.71 W/kg

**SAR(1 g) = 0.937 W/kg; SAR(10 g) = 0.471 W/kg**

Maximum value of SAR (measured) = 1.36 W/kg

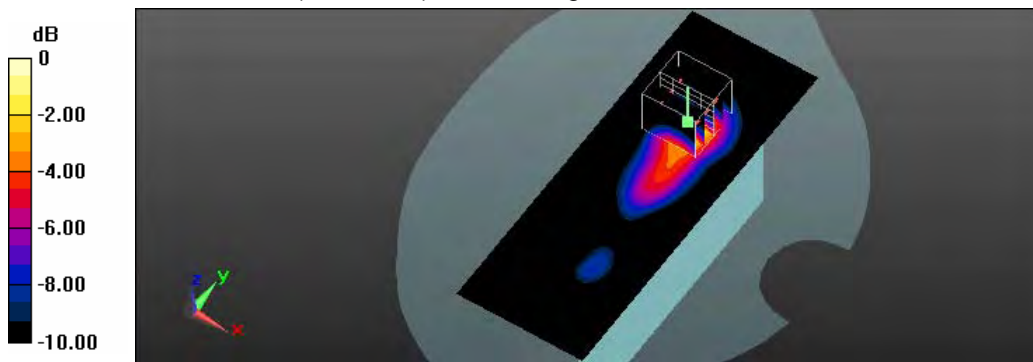

0 dB = 1.36 W/kg = 1.34 dBW/kg

Test Laboratory: A Test Lab Techno Corp.

Date: 2015/10/11 Time: PM 12:44:12

**23\_HSDPA Band II CH9538\_QPSK\_Sub-test1\_Side 6\_0mm**

**DUT: PA820; Type: Rugged Handheld Computer; Serial: 359998040102016**

Communication System: UID 0, HSDPA Band II (0); Frequency: 1907.6 MHz; Duty Cycle: 1:1

Medium parameters used:  $f = 1908 \text{ MHz}$ ;  $\sigma = 1.514 \text{ S/m}$ ;  $\epsilon_r = 54.324$ ;  $\rho = 1000 \text{ kg/m}^3$

Phantom section: Flat Section

Measurement Standard: DASY5 (IEEE/IEC/ANSI C63.19-2011)

DASY Configuration:

- Area Scan setting - Find Secondary Maximum Within: 2.0dB and with a peak SAR value greater than 0.5 W/Kg
- Probe: EX3DV4 - SN3847; ConvF(7.46, 7.46, 7.46); Calibrated: 2015/1/30;
- Sensor-Surface: 2mm (Mechanical Surface Detection)
- Electronics: DAE4 Sn541; Calibrated: 2015/2/3
- Phantom: SAM with CRP; Type: SAM; Serial: TP-1150 and higher
- Measurement SW: DASY52, Version 52.8 (8); SEMCAD X Version 14.6.10 (7331)

**Flat/Area Scan (51x141x1):** Interpolated grid:  $dx=1.500 \text{ mm}$ ,  $dy=1.500 \text{ mm}$

Maximum value of SAR (interpolated) = 1.12 W/kg

**Flat/Zoom Scan (5x5x7)/Cube 0:** Measurement grid:  $dx=8\text{mm}$ ,  $dy=8\text{mm}$ ,  $dz=5\text{mm}$

Reference Value = 24.75 V/m; Power Drift = 0.00 dB

Peak SAR (extrapolated) = 1.51 W/kg

**SAR(1 g) = 0.827 W/kg; SAR(10 g) = 0.413 W/kg**

Maximum value of SAR (measured) = 1.20 W/kg

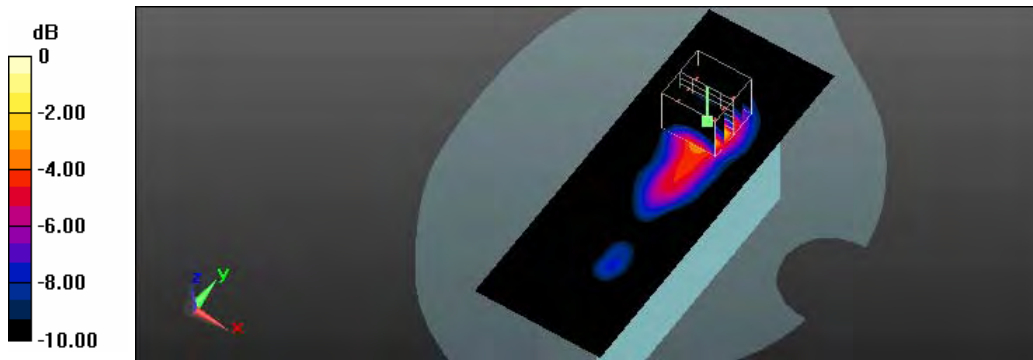

0 dB = 1.20 W/kg = 0.79 dBW/kg

Test Laboratory: A Test Lab Techno Corp.

Date: 2015/10/11 Time: PM 01:42:24

**26\_HSUPA Band II CH9538\_QPSK\_Sub-test1\_Side 6\_0mm**

**DUT: PA820; Type: Rugged Handheld Computer; Serial: 359998040102016**

Communication System: UID 0, HSUPA Band II (0); Frequency: 1907.6 MHz; Duty Cycle: 1:1

Medium parameters used:  $f = 1908 \text{ MHz}$ ;  $\sigma = 1.514 \text{ S/m}$ ;  $\epsilon_r = 54.324$ ;  $\rho = 1000 \text{ kg/m}^3$

Phantom section: Flat Section

Measurement Standard: DASY5 (IEEE/IEC/ANSI C63.19-2011)

DASY Configuration:

- Area Scan setting - Find Secondary Maximum Within: 2.0dB and with a peak SAR value greater than 0.5 W/Kg
- Probe: EX3DV4 - SN3847; ConvF(7.46, 7.46, 7.46); Calibrated: 2015/1/30;
- Sensor-Surface: 2mm (Mechanical Surface Detection)
- Electronics: DAE4 Sn541; Calibrated: 2015/2/3
- Phantom: SAM with CRP; Type: SAM; Serial: TP-1150 and higher
- Measurement SW: DASY52, Version 52.8 (8); SEMCAD X Version 14.6.10 (7331)

**Flat/Area Scan (51x141x1):** Interpolated grid:  $dx=1.500 \text{ mm}$ ,  $dy=1.500 \text{ mm}$

Maximum value of SAR (interpolated) = 0.260 W/kg

**Flat/Zoom Scan (5x5x7)/Cube 0:** Measurement grid:  $dx=8\text{mm}$ ,  $dy=8\text{mm}$ ,  $dz=5\text{mm}$

Reference Value = 8.152 V/m; Power Drift = 0.11 dB

Peak SAR (extrapolated) = 0.339 W/kg

**SAR(1 g) = 0.181 W/kg; SAR(10 g) = 0.083 W/kg**

Maximum value of SAR (measured) = 0.256 W/kg

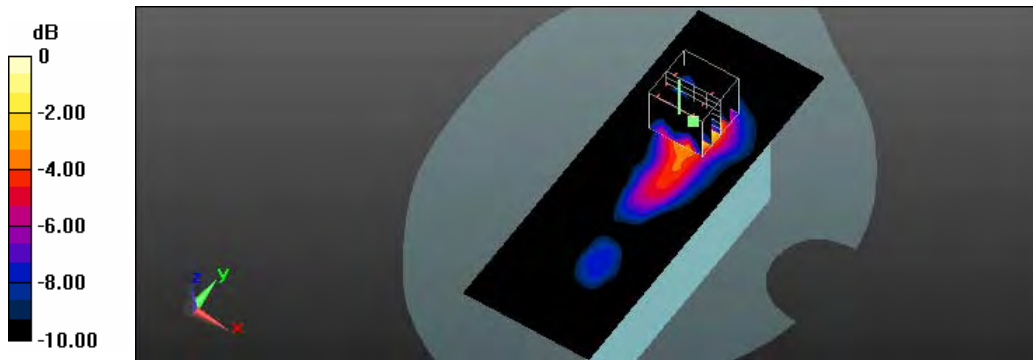

0 dB = 0.256 W/kg = -5.92 dBW/kg

Test Laboratory: A Test Lab Techno Corp.

Date: 2015/10/6 Time: PM 07:29:12

**9\_WCDMA Band V CH4183\_RMC-12.2K\_Side 1\_0mm**

**DUT: PA820; Type: Rugged Handheld Computer; Serial: 359998040102016**

Communication System: UID 0, WCDMA Band V (0); Frequency: 836.6 MHz; Duty Cycle: 1:1

Medium parameters used:  $f = 837 \text{ MHz}$ ;  $\sigma = 0.981 \text{ S/m}$ ;  $\epsilon_r = 54.873$ ;  $\rho = 1000 \text{ kg/m}^3$

Phantom section: Flat Section

Measurement Standard: DASY5 (IEEE/IEC/ANSI C63.19-2011)

DASY Configuration:

- Area Scan setting - Find Secondary Maximum Within: 2.0dB and with a peak SAR value greater than 0.5 W/Kg
- Probe: EX3DV4 - SN3847; ConvF(9.42, 9.42, 9.42); Calibrated: 2015/1/30;
- Sensor-Surface: 2mm (Mechanical Surface Detection)
- Electronics: DAE4 Sn541; Calibrated: 2015/2/3
- Phantom: SAM with CRP; Type: SAM; Serial: TP-1150 and higher
- Measurement SW: DASY52, Version 52.8 (8); SEMCAD X Version 14.6.10 (7331)

**Flat/Area Scan (81x131x1):** Interpolated grid:  $dx=1.500 \text{ mm}$ ,  $dy=1.500 \text{ mm}$

Maximum value of SAR (interpolated) = 0.608 W/kg

**Flat/Zoom Scan (5x5x7)/Cube 0:** Measurement grid:  $dx=8\text{mm}$ ,  $dy=8\text{mm}$ ,  $dz=5\text{mm}$

Reference Value = 25.51 V/m; Power Drift = -0.16 dB

Peak SAR (extrapolated) = 0.755 W/kg

**SAR(1 g) = 0.485 W/kg; SAR(10 g) = 0.307 W/kg**

Maximum value of SAR (measured) = 0.633 W/kg

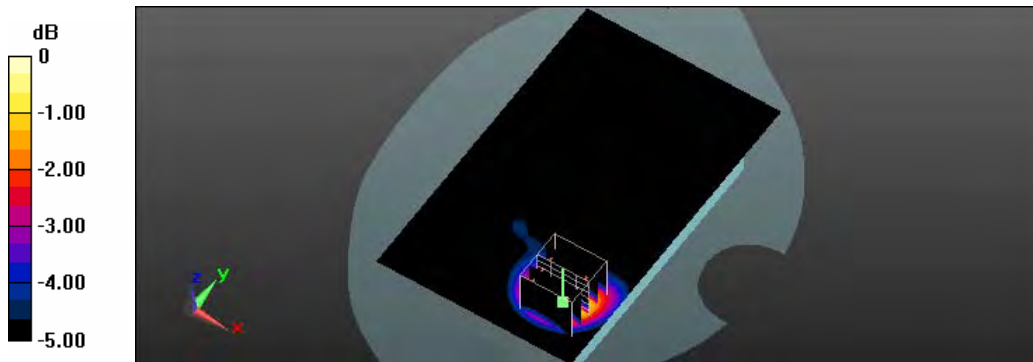

0 dB = 0.633 W/kg = -1.99 dBW/kg

Test Laboratory: A Test Lab Techno Corp.

Date: 2015/10/6 Time: PM 08:01:09

**10\_WCDMA Band V CH4183\_RMC-12.2K\_Side 2\_0mm**

**DUT: PA820; Type: Rugged Handheld Computer; Serial: 359998040102016**

Communication System: UID 0, WCDMA Band V (0); Frequency: 836.6 MHz; Duty Cycle: 1:1

Medium parameters used:  $f = 837$  MHz;  $\sigma = 0.981$  S/m;  $\epsilon_r = 54.873$ ;  $\rho = 1000$  kg/m<sup>3</sup>

Phantom section: Flat Section

Measurement Standard: DASY5 (IEEE/IEC/ANSI C63.19-2011)

DASY Configuration:

- Area Scan setting - Find Secondary Maximum Within: 2.0dB and with a peak SAR value greater than 0.5 W/Kg
- Probe: EX3DV4 - SN3847; ConvF(9.42, 9.42, 9.42); Calibrated: 2015/1/30;
- Sensor-Surface: 2mm (Mechanical Surface Detection)
- Electronics: DAE4 Sn541; Calibrated: 2015/2/3
- Phantom: SAM with CRP; Type: SAM; Serial: TP-1150 and higher
- Measurement SW: DASY52, Version 52.8 (8); SEMCAD X Version 14.6.10 (7331)

**Flat/Area Scan (81x131x1):** Interpolated grid: dx=1.500 mm, dy=1.500 mm

Maximum value of SAR (interpolated) = 0.632 W/kg

**Flat/Zoom Scan (5x5x7)/Cube 0:** Measurement grid: dx=8mm, dy=8mm, dz=5mm

Reference Value = 24.50 V/m; Power Drift = 0.08 dB

Peak SAR (extrapolated) = 0.680 W/kg

**SAR(1 g) = 0.535 W/kg; SAR(10 g) = 0.401 W/kg**

Maximum value of SAR (measured) = 0.617 W/kg

**Flat/Zoom Scan (5x5x7)/Cube 1:** Measurement grid: dx=8mm, dy=8mm, dz=5mm

Reference Value = 24.50 V/m; Power Drift = 0.08 dB

Peak SAR (extrapolated) = 0.745 W/kg

**SAR(1 g) = 0.544 W/kg; SAR(10 g) = 0.390 W/kg**

Maximum value of SAR (measured) = 0.654 W/kg

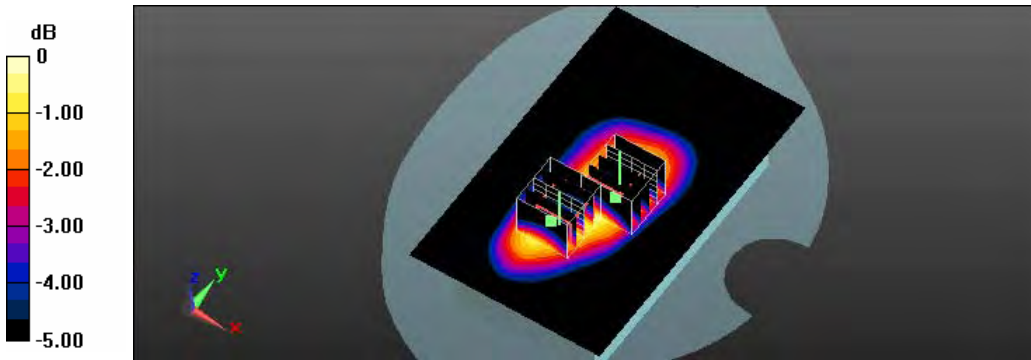

0 dB = 0.654 W/kg = -1.84 dBW/kg

Test Laboratory: A Test Lab Techno Corp.

Date: 2015/10/6 Time: PM 08:54:52

**11\_WCDMA Band V CH4183\_RMC-12.2K\_Side 4\_0mm**

**DUT: PA820; Type: Rugged Handheld Computer; Serial: 359998040102016**

Communication System: UID 0, WCDMA Band V (0); Frequency: 836.6 MHz; Duty Cycle: 1:1

Medium parameters used:  $f = 837$  MHz;  $\sigma = 0.981$  S/m;  $\epsilon_r = 54.873$ ;  $\rho = 1000$  kg/m<sup>3</sup>

Phantom section: Flat Section

Measurement Standard: DASY5 (IEEE/IEC/ANSI C63.19-2011)

DASY Configuration:

- Area Scan setting - Find Secondary Maximum Within: 2.0dB and with a peak SAR value greater than 0.5 W/Kg
- Probe: EX3DV4 - SN3847; ConvF(9.42, 9.42, 9.42); Calibrated: 2015/1/30;
- Sensor-Surface: 2mm (Mechanical Surface Detection)
- Electronics: DAE4 Sn541; Calibrated: 2015/2/3
- Phantom: SAM with CRP; Type: SAM; Serial: TP-1150 and higher
- Measurement SW: DASY52, Version 52.8 (8); SEMCAD X Version 14.6.10 (7331)

**Flat/Area Scan (51x91x1):** Interpolated grid: dx=1.500 mm, dy=1.500 mm

Maximum value of SAR (interpolated) = 0.497 W/kg

**Flat/Zoom Scan (5x5x7)/Cube 0:** Measurement grid: dx=8mm, dy=8mm, dz=5mm

Reference Value = 21.72 V/m; Power Drift = 0.09 dB

Peak SAR (extrapolated) = 0.631 W/kg

**SAR(1 g) = 0.392 W/kg; SAR(10 g) = 0.245 W/kg**

Maximum value of SAR (measured) = 0.515 W/kg

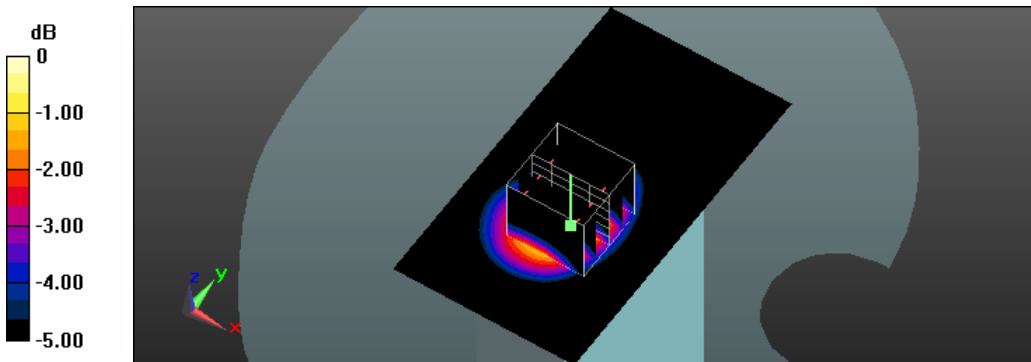

0 dB = 0.515 W/kg = -2.88 dBW/kg

Test Laboratory: A Test Lab Techno Corp.

Date: 2015/10/6 Time: PM 06:35:21

**12\_WCDMA Band V CH4183\_RMC-12.2K\_Side 6\_0mm**

**DUT: PA820; Type: Rugged Handheld Computer; Serial: 359998040102016**

Communication System: UID 0, WCDMA Band V (0); Frequency: 836.6 MHz; Duty Cycle: 1:1

Medium parameters used:  $f = 837$  MHz;  $\sigma = 0.981$  S/m;  $\epsilon_r = 54.873$ ;  $\rho = 1000$  kg/m<sup>3</sup>

Phantom section: Flat Section

Measurement Standard: DASY5 (IEEE/IEC/ANSI C63.19-2011)

DASY Configuration:

- Area Scan setting - Find Secondary Maximum Within: 2.0dB and with a peak SAR value greater than 0.5 W/Kg
- Probe: EX3DV4 - SN3847; ConvF(9.42, 9.42, 9.42); Calibrated: 2015/1/30;
- Sensor-Surface: 2mm (Mechanical Surface Detection)
- Electronics: DAE4 Sn541; Calibrated: 2015/2/3
- Phantom: SAM with CRP; Type: SAM; Serial: TP-1150 and higher
- Measurement SW: DASY52, Version 52.8 (8); SEMCAD X Version 14.6.10 (7331)

**Flat/Area Scan (51x141x1):** Interpolated grid: dx=1.500 mm, dy=1.500 mm

Maximum value of SAR (interpolated) = 0.583 W/kg

**Flat/Zoom Scan (5x5x7)/Cube 0:** Measurement grid: dx=8mm, dy=8mm, dz=5mm

Reference Value = 24.32 V/m; Power Drift = -0.02 dB

Peak SAR (extrapolated) = 0.778 W/kg

**SAR(1 g) = 0.444 W/kg; SAR(10 g) = 0.260 W/kg**

Maximum value of SAR (measured) = 0.620 W/kg

**Flat/Zoom Scan (5x5x7)/Cube 1:** Measurement grid: dx=8mm, dy=8mm, dz=5mm

Reference Value = 24.32 V/m; Power Drift = -0.02 dB

Peak SAR (extrapolated) = 0.571 W/kg

**SAR(1 g) = 0.401 W/kg; SAR(10 g) = 0.274 W/kg**

Maximum value of SAR (measured) = 0.495 W/kg

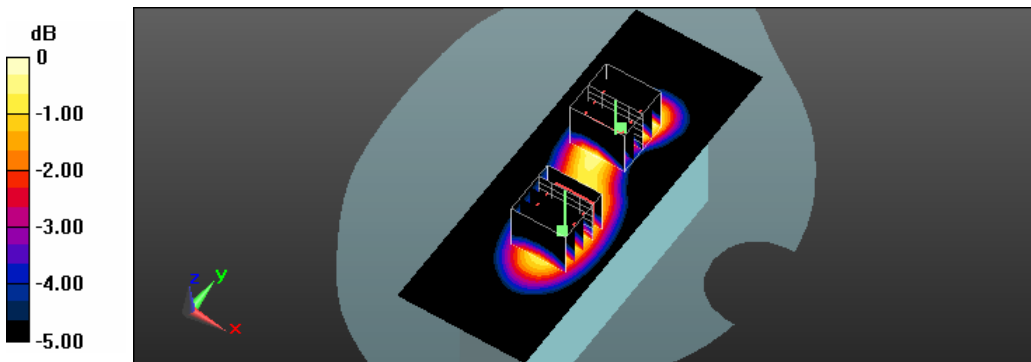

0 dB = 0.495 W/kg = -3.05 dBW/kg

Test Laboratory: A Test Lab Techno Corp.

Date: 2015/10/11 Time: PM 02:06:58

**27\_HSDPA Band II CH9262\_QPSK\_Sub-test1\_Side 6\_0mm\_original #25\_measurement\_once**

**DUT: PA820; Type: Rugged Handheld Computer; Serial: 359998040102016**

Communication System: UID 0, HSDPA Band II (0); Frequency: 1852.4 MHz; Duty Cycle: 1:1

Medium parameters used:  $f = 1852.4$  MHz;  $\sigma = 1.462$  S/m;  $\epsilon_r = 54.612$ ;  $\rho = 1000$  kg/m<sup>3</sup>

Phantom section: Flat Section

Measurement Standard: DASY5 (IEEE/IEC/ANSI C63.19-2011)

DASY Configuration:

- Area Scan setting - Find Secondary Maximum Within: 2.0dB and with a peak SAR value greater than 0.5 W/Kg
- Probe: EX3DV4 - SN3847; ConvF(7.46, 7.46, 7.46); Calibrated: 2015/1/30;
- Sensor-Surface: 2mm (Mechanical Surface Detection)
- Electronics: DAE4 Sn541; Calibrated: 2015/2/3
- Phantom: SAM with CRP; Type: SAM; Serial: TP-1150 and higher
- Measurement SW: DASY52, Version 52.8 (8); SEMCAD X Version 14.6.10 (7331)

**Flat/Area Scan (51x141x1):** Interpolated grid: dx=1.500 mm, dy=1.500 mm

Maximum value of SAR (interpolated) = 1.23 W/kg

**Flat/Zoom Scan (5x5x7)/Cube 0:** Measurement grid: dx=8mm, dy=8mm, dz=5mm

Reference Value = 24.96 V/m; Power Drift = -0.14 dB

Peak SAR (extrapolated) = 2.10 W/kg

**SAR(1 g) = 1.06 W/kg; SAR(10 g) = 0.513 W/kg**

Maximum value of SAR (measured) = 1.44 W/kg

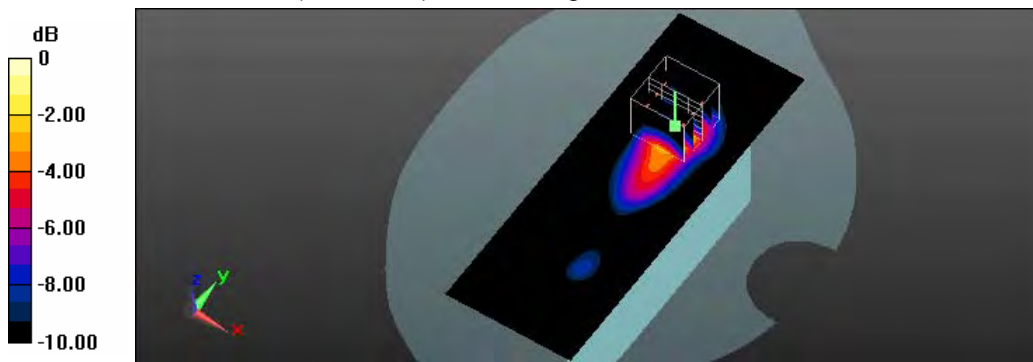

0 dB = 1.44 W/kg = 1.58 dBW/kg



Test Laboratory: A Test Lab Techno Corp.

Date: 2015/10/5 Time: PM 07:05:05

**2\_802.11b CH1\_1M\_Side 2\_0mm**

**DUT: PA820; Type: Rugged Handheld Computer; Serial: 359998040102016**

Communication System: UID 0, IEEE 802.11b (0); Frequency: 2412 MHz; Duty Cycle: 1:1

Medium parameters used:  $f = 2412$  MHz;  $\sigma = 1.901$  S/m;  $\epsilon_r = 51.185$ ;  $\rho = 1000$  kg/m<sup>3</sup>

Phantom section: Flat Section

Measurement Standard: DASY5 (IEEE/IEC/ANSI C63.19-2011)

DASY Configuration:

- Area Scan setting - Find Secondary Maximum Within: 2.0dB and with a peak SAR value greater than 0.5 W/Kg
- Probe: EX3DV4 - SN3847; ConvF(7.29, 7.29, 7.29); Calibrated: 2015/1/30;
- Sensor-Surface: 2mm (Mechanical Surface Detection)
- Electronics: DAE4 Sn541; Calibrated: 2015/2/3
- Phantom: SAM with CRP; Type: SAM; Serial: TP-1150 and higher
- Measurement SW: DASY52, Version 52.8 (8); SEMCAD X Version 14.6.10 (7331)

**Flat/Area Scan (121x191x1):** Interpolated grid: dx=1.000 mm, dy=1.000 mm

Maximum value of SAR (interpolated) = 0.128 W/kg

**Flat/Zoom Scan (7x7x7)/Cube 0:** Measurement grid: dx=5mm, dy=5mm, dz=5mm

Reference Value = 4.508 V/m; Power Drift = 0.140 dB

Peak SAR (extrapolated) = 0.0740 W/kg

**SAR(1 g) = 0.013 W/kg; SAR(10 g) = 0.00631 W/kg**

Maximum value of SAR (measured) = 0.0696 W/kg

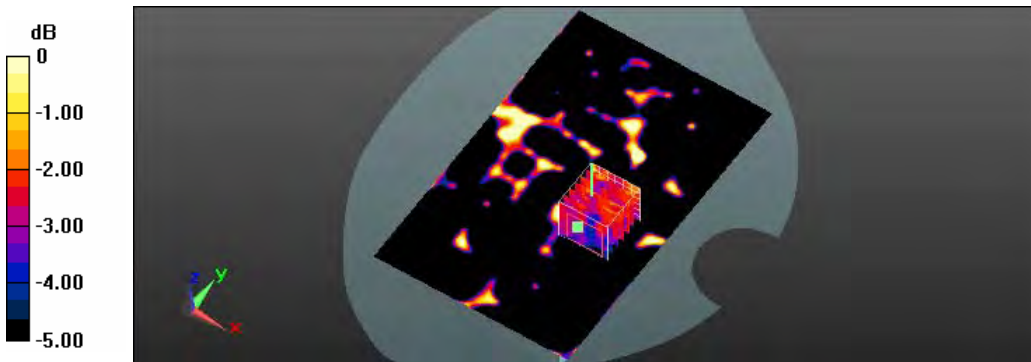

0 dB = 0.0696 W/kg = -11.57 dBW/kg

Test Laboratory: A Test Lab Techno Corp.

Date: 2015/10/5 Time: PM 08:12:54

**3\_802.11b CH1\_1M\_Side 5\_0mm**

**DUT: PA820; Type: Rugged Handheld Computer; Serial: 359998040102016**

Communication System: UID 0, IEEE 802.11b (0); Frequency: 2412 MHz; Duty Cycle: 1:1

Medium parameters used:  $f = 2412$  MHz;  $\sigma = 1.901$  S/m;  $\epsilon_r = 51.185$ ;  $\rho = 1000$  kg/m<sup>3</sup>

Phantom section: Flat Section

Measurement Standard: DASY5 (IEEE/IEC/ANSI C63.19-2011)

DASY Configuration:

- Area Scan setting - Find Secondary Maximum Within: 2.0dB and with a peak SAR value greater than 0.5 W/Kg
- Probe: EX3DV4 - SN3847; ConvF(7.29, 7.29, 7.29); Calibrated: 2015/1/30;
- Sensor-Surface: 2mm (Mechanical Surface Detection)
- Electronics: DAE4 Sn541; Calibrated: 2015/2/3
- Phantom: SAM with CRP; Type: SAM; Serial: TP-1150 and higher
- Measurement SW: DASY52, Version 52.8 (8); SEMCAD X Version 14.6.10 (7331)

**Flat/Area Scan (71x211x1):** Interpolated grid: dx=1.000 mm, dy=1.000 mm

Maximum value of SAR (interpolated) = 0.200 W/kg

**Flat/Zoom Scan (7x7x7)/Cube 0:** Measurement grid: dx=5mm, dy=5mm, dz=5mm

Reference Value = 10.30 V/m; Power Drift = 0.04 dB

Peak SAR (extrapolated) = 0.248 W/kg

**SAR(1 g) = 0.135 W/kg; SAR(10 g) = 0.066 W/kg**

Maximum value of SAR (measured) = 0.194 W/kg

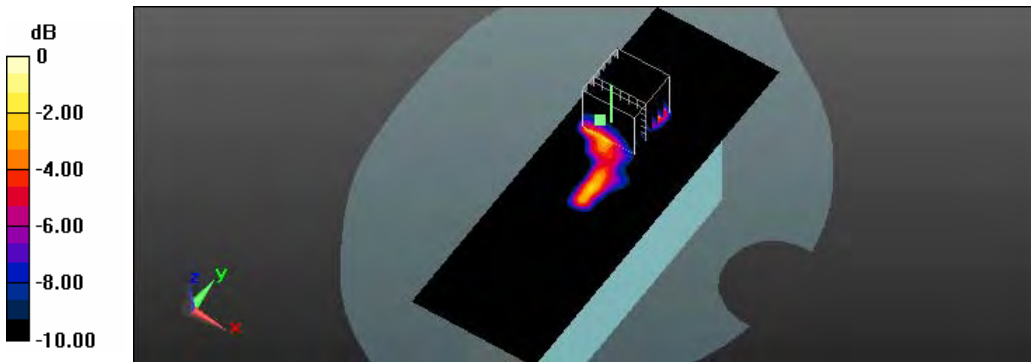

0 dB = 0.194 W/kg = -7.12 dBW/kg



## ***Appendix C - Calibration***

All of the instruments Calibration information are listed below.

- Dipole \_ D835V2 SN:4d082 Calibration No.D835V2-4d082\_Jul15
- Dipole \_ D1900V2 SN:5d111 Calibration No.D1900V2-5d111\_Jul15
- Dipole \_ D2450V2 SN:712 Calibration No.D2450V2-712\_Mar15
- Probe \_ EX3DV4 SN:3847 Calibration No.EX3-3847\_Jan15
- DAE \_ DAE4 SN:541 Calibration No.DAE4-541\_Feb15



Add: No.51 Xueyuan Road, Haidian District, Beijing, 100191, China  
 Tel: +86-10-62304633-2079 Fax: +86-10-62304633-2504  
 E-mail: cttl@chinattl.com [Http://www.chinattl.cn](http://www.chinattl.cn)



Client **ATL** Certificate No: **Z15-97087**

### CALIBRATION CERTIFICATE

Object: D835V2 - SN: 4d082

Calibration Procedure(s): FD-Z11-2-003-01  
 Calibration Procedures for dipole validation kits

Calibration date: July 6, 2015

This calibration Certificate documents the traceability to national standards, which realize the physical units of measurements(SI). The measurements and the uncertainties with confidence probability are given on the following pages and are part of the certificate.

All calibrations have been conducted in the closed laboratory facility: environment temperature(22±3)°C and humidity<70%.

Calibration Equipment used (M&TE critical for calibration)

Primary Standards	ID #	Cal Date(Calibrated by, Certificate No.)	Scheduled Calibration
Power Meter NRP2	101919	01-Jul-15 (CTTL, No.J15X04256)	Jun-16
Power sensor NRP-Z91	101547	01-Jul-15 (CTTL, No.J15X04256)	Jun-16
Reference Probe EX3DV4	SN 3846	24-Sep-14(SPEAG,No.EX3-3846_Sep14)	Sep-15
DAE4	SN 1331	20-Jan-15(CTTL-SPEAG, No. Z15-97011)	Jan-16
Secondary Standards	ID #	Cal Date(Calibrated by, Certificate No.)	Scheduled Calibration
Signal Generator E4438C	MY49071430	02-Feb-15 (CTTL, No.J15X00729)	Feb-16
Network Analyzer E5071C	MY46110673	03-Feb-15 (CTTL, No.J15X00728)	Feb-16

	Name	Function	Signature
Calibrated by:	Zhao Jing	SAR Test Engineer	
Reviewed by:	Qi Dianyuan	SAR Project Leader	
Approved by:	Lu Bingsong	Deputy Director of the laboratory	

Issued: July 10, 2015

This calibration certificate shall not be reproduced except in full without written approval of the laboratory.

**Glossary:**

TSL	tissue simulating liquid
ConvF	sensitivity in TSL / NORM <sub>x,y,z</sub>
N/A	not applicable or not measured

**Calibration is Performed According to the Following Standards:**

- IEEE Std 1528-2013, "IEEE Recommended Practice for Determining the Peak Spatial-Averaged Specific Absorption Rate (SAR) in the Human Head from Wireless Communications Devices: Measurement Techniques", June 2013
- IEC 62209-1, "Procedure to measure the Specific Absorption Rate (SAR) For hand-held devices used in close proximity to the ear (frequency range of 300MHz to 3GHz)", February 2005
- KDB865664, SAR Measurement Requirements for 100 MHz to 6 GHz

**Additional Documentation:**

- DASY4/5 System Handbook

**Methods Applied and Interpretation of Parameters:**

- Measurement Conditions:* Further details are available from the Validation Report at the end of the certificate. All figures stated in the certificate are valid at the frequency indicated.
- Antenna Parameters with TSL:* The dipole is mounted with the spacer to position its feed point exactly below the center marking of the flat phantom section, with the arms oriented parallel to the body axis.
- Feed Point Impedance and Return Loss:* These parameters are measured with the dipole positioned under the liquid filled phantom. The impedance stated is transformed from the measurement at the SMA connector to the feed point. The Return Loss ensures low reflected power. No uncertainty required.
- Electrical Delay:* One-way delay between the SMA connector and the antenna feed point. No uncertainty required.
- SAR measured:* SAR measured at the stated antenna input power.
- SAR normalized:* SAR as measured, normalized to an input power of 1 W at the antenna connector.
- SAR for nominal TSL parameters:* The measured TSL parameters are used to calculate the nominal SAR result.

The reported uncertainty of measurement is stated as the standard uncertainty of Measurement multiplied by the coverage factor  $k=2$ , which for a normal distribution Corresponds to a coverage probability of approximately 95%.

### Measurement Conditions

DASY system configuration, as far as not given on page 1.

DASY Version	DASY52	52.8.8.1222
Extrapolation	Advanced Extrapolation	
Phantom	Triple Flat Phantom 5.1C	
Distance Dipole Center - TSL	15 mm	with Spacer
Zoom Scan Resolution	dx, dy, dz = 5 mm	
Frequency	835 MHz ± 1 MHz	

### Head TSL parameters

The following parameters and calculations were applied.

	Temperature	Permittivity	Conductivity
Nominal Head TSL parameters	22.0 °C	41.5	0.90 mho/m
Measured Head TSL parameters	(22.0 ± 0.2) °C	40.8 ± 6 %	0.92 mho/m ± 6 %
Head TSL temperature change during test	<1.0 °C	----	----

### SAR result with Head TSL

SAR averaged over 1 cm <sup>3</sup> (1 g) of Head TSL	Condition	
SAR measured	250 mW input power	2.43 mW / g
SAR for nominal Head TSL parameters	normalized to 1W	<b>9.56 mW /g ± 20.8 % (k=2)</b>
SAR averaged over 10 cm <sup>3</sup> (10 g) of Head TSL	Condition	
SAR measured	250 mW input power	1.60 mW / g
SAR for nominal Head TSL parameters	normalized to 1W	<b>6.32 mW /g ± 20.4 % (k=2)</b>

### Body TSL parameters

The following parameters and calculations were applied.

	Temperature	Permittivity	Conductivity
Nominal Body TSL parameters	22.0 °C	55.2	0.97 mho/m
Measured Body TSL parameters	(22.0 ± 0.2) °C	56.8 ± 6 %	0.97 mho/m ± 6 %
Body TSL temperature change during test	<1.0 °C	----	----

### SAR result with Body TSL

SAR averaged over 1 cm <sup>3</sup> (1 g) of Body TSL	Condition	
SAR measured	250 mW input power	2.43 mW / g
SAR for nominal Body TSL parameters	normalized to 1W	<b>9.77 mW /g ± 20.8 % (k=2)</b>
SAR averaged over 10 cm <sup>3</sup> (10 g) of Body TSL	Condition	
SAR measured	250 mW input power	1.61 mW / g
SAR for nominal Body TSL parameters	normalized to 1W	<b>6.46 mW /g ± 20.4 % (k=2)</b>



In Collaboration with  
**s p e a g**  
 CALIBRATION LABORATORY

Add: No.51 Xueyuan Road, Haidian District, Beijing, 100191, China  
 Tel: +86-10-62304633-2079 Fax: +86-10-62304633-2504  
 E-mail: cttl@chinattl.com Http://www.chinattl.cn

**Appendix**

**Antenna Parameters with Head TSL**

Impedance, transformed to feed point	51.0Ω- 2.80jΩ
Return Loss	- 30.6dB

**Antenna Parameters with Body TSL**

Impedance, transformed to feed point	46.5Ω- 4.91jΩ
Return Loss	- 24.1dB

**General Antenna Parameters and Design**

Electrical Delay (one direction)	1.442 ns
----------------------------------	----------

After long term use with 100W radiated power, only a slight warming of the dipole near the feedpoint can be measured.

The dipole is made of standard semirigid coaxial cable. The center conductor of the feeding line is directly connected to the second arm of the dipole. The antenna is therefore short-circuited for DC-signals. On some of the dipoles, small end caps are added to the dipole arms in order to improve matching when loaded according to the position as explained in the "Measurement Conditions" paragraph. The SAR data are not affected by this change. The overall dipole length is still according to the Standard. No excessive force must be applied to the dipole arms, because they might bend or the soldered connections near the feedpoint may be damaged.

**Additional EUT Data**

Manufactured by	SPEAG
-----------------	-------

**DASY5 Validation Report for Head TSL**

Date: 07.06.2015

Test Laboratory: CCTL, Beijing, China

**DUT: Dipole 835 MHz; Type: D835V2; Serial: D835V2 - SN: 4d082**

Communication System: UID 0, CW; Frequency: 835 MHz; Duty Cycle: 1:1

Medium parameters used:  $f = 835 \text{ MHz}$ ;  $\sigma = 0.915 \text{ S/m}$ ;  $\epsilon_r = 40.76$ ;  $\rho = 1000 \text{ kg/m}^3$

Phantom section: Left Section

Measurement Standard: DASY5 (IEEE/IEC/ANSI C63.19-2007)

DASY5 Configuration:

- Probe: EX3DV4 - SN3846; ConvF(9.18, 9.18, 9.18); Calibrated: 9/24/2014;
- Sensor-Surface: 2mm (Mechanical Surface Detection)
- Electronics: DAE4 Sn1331; Calibrated: 2015-01-20
- Phantom: Triple Flat Phantom 5.1C; Type: QD 000 P51 CA; Serial: 1161/1
- Measurement SW: DASY52, Version 52.8 (8); SEMCAD X Version 14.6.10 (7331)

**Dipole Calibration/Zoom Scan (7x7x7) (7x7x7)/Cube 0:** Measurement grid:  $dx=5\text{mm}$ ,  $dy=5\text{mm}$ ,  $dz=5\text{mm}$

Reference Value = 58.09 V/m; Power Drift = 0.01 dB

Peak SAR (extrapolated) = 3.64 W/kg

**SAR(1 g) = 2.43 W/kg; SAR(10 g) = 1.6 W/kg**

Maximum value of SAR (measured) = 3.08 W/kg

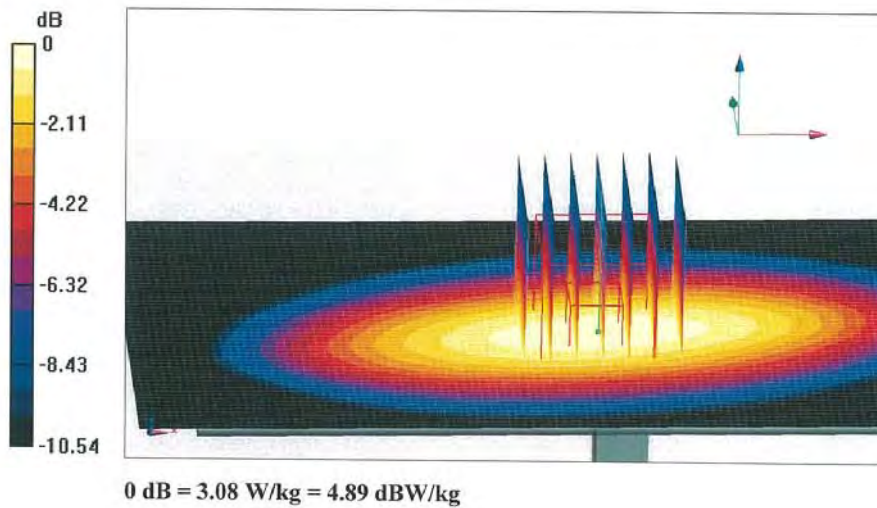





In Collaboration with  
**s p e a g**  
CALIBRATION LABORATORY

Add: No.51 Xueyuan Road, Haidian District, Beijing, 100191, China  
Tel: +86-10-62304633-2079 Fax: +86-10-62304633-2504  
E-mail: cttl@chinattl.com Http://www.chinattl.cn

### Impedance Measurement Plot for Head TSL

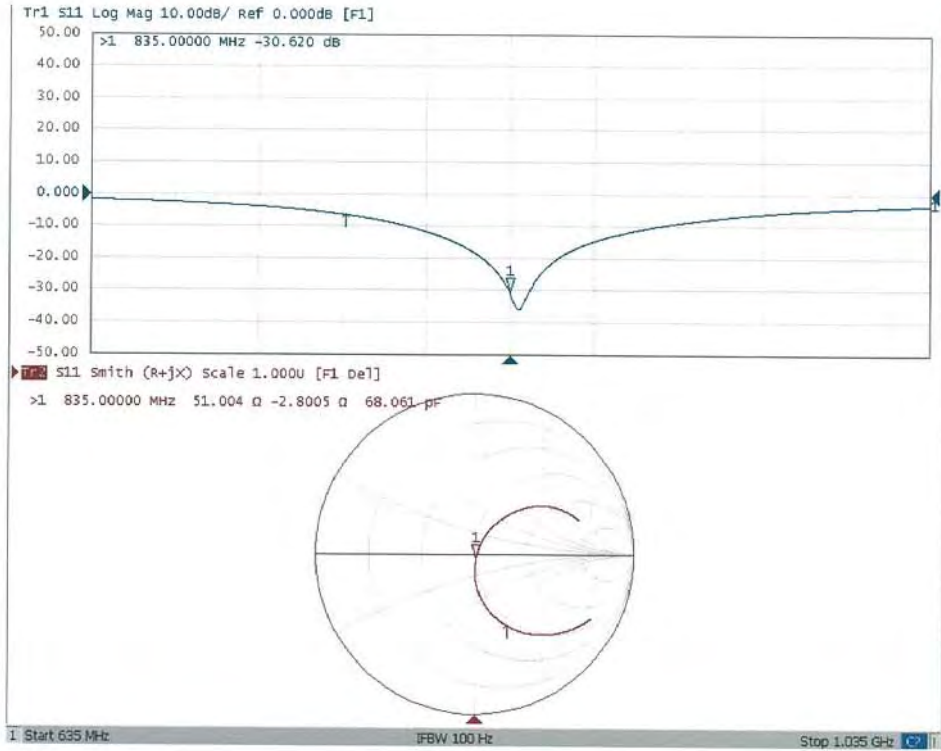

**DASY5 Validation Report for Body TSL**

Date: 07.06.2015

Test Laboratory: CTTL, Beijing, China

**DUT: Dipole 835 MHz; Type: D835V2; Serial: D835V2 - SN: 4d082**

Communication System: UID 0, CW; Frequency: 835 MHz; Duty Cycle: 1:1

Medium parameters used:  $f = 835 \text{ MHz}$ ;  $\sigma = 0.972 \text{ S/m}$ ;  $\epsilon_r = 56.78$ ;  $\rho = 1000 \text{ kg/m}^3$

Phantom section: Right Section

Measurement Standard: DASY5 (IEEE/IEC/ANSI C63.19-2007)

DASY5 Configuration:

- Probe: EX3DV4 - SN3846; ConvF(9.09,9.09, 9.09); Calibrated: 9/24/2014;
- Sensor-Surface: 2mm (Mechanical Surface Detection)
- Electronics: DAE4 Sn1331; Calibrated: 2015-01-20
- Phantom: Triple Flat Phantom 5.1C; Type: QD 000 P51 CA; Serial: 1161/1
- Measurement SW: DASY52, Version 52.8 (8); SEMCAD X Version 14.6.10 (7331)

**Dipole Calibration/Zoom Scan (7x7x7) (7x7x7)/Cube 0:** Measurement grid:  $dx=5\text{mm}$ ,  $dy=5\text{mm}$ ,  $dz=5\text{mm}$

Reference Value = 54.35 V/m; Power Drift = -0.00 dB

Peak SAR (extrapolated) = 3.59 W/kg

**SAR(1 g) = 2.43 W/kg; SAR(10 g) = 1.61 W/kg**

Maximum value of SAR (measured) = 3.06 W/kg

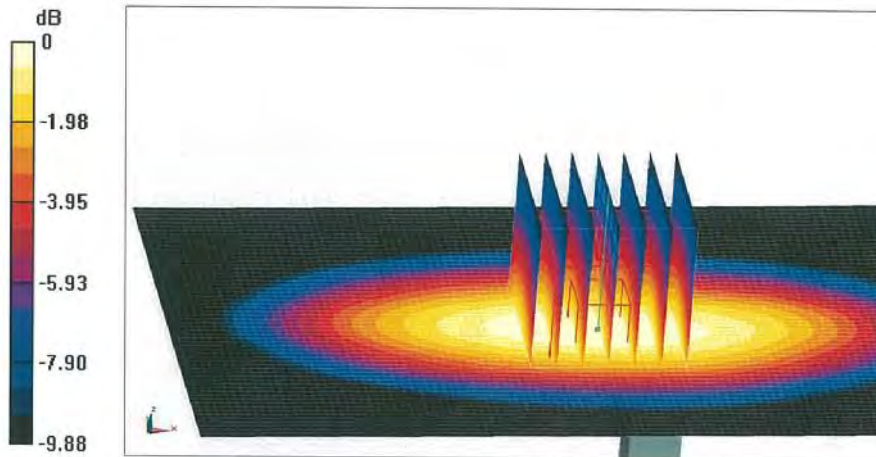

**0 dB = 3.06 W/kg = 4.86 dBW/kg**



In Collaboration with  
**s p e a g**  
CALIBRATION LABORATORY

Add: No.51 Xueyuan Road, Haidian District, Beijing, 100191, China  
Tel: +86-10-62304633-2079 Fax: +86-10-62304633-2504  
E-mail: cttl@chinattl.com Http://www.chinattl.cn

### Impedance Measurement Plot for Body TSL

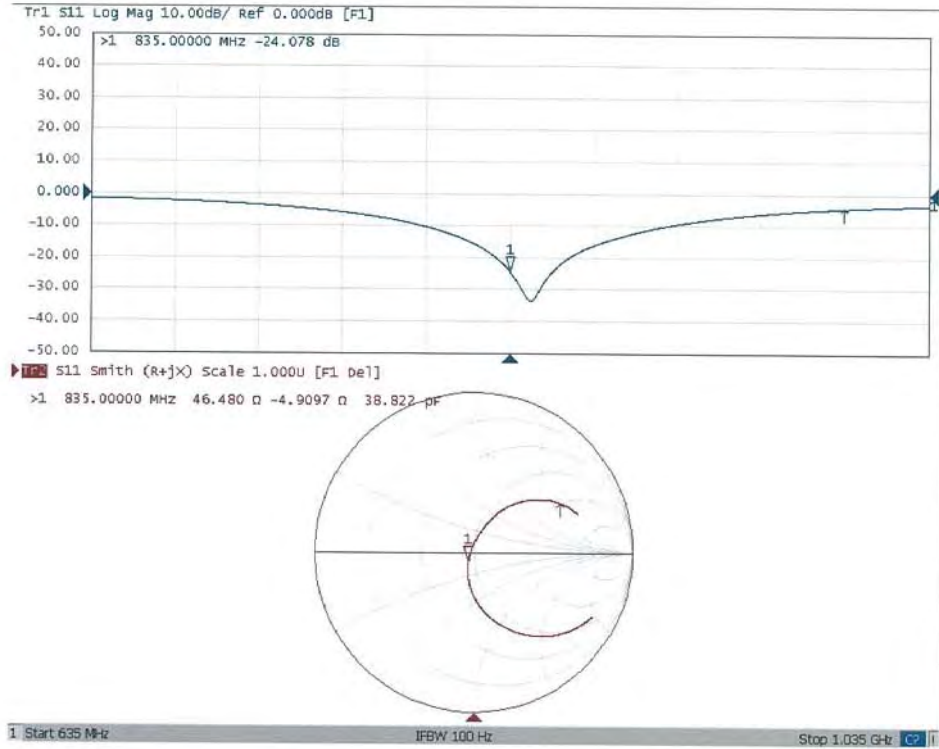



In Collaboration with  
**s p e a g**  
CALIBRATION LABORATORY



Add: No.51 Xueyuan Road, Haidian District, Beijing, 100191, China  
Tel: +86-10-62304633-2079 Fax: +86-10-62304633-2504  
E-mail: cttl@chinattl.com [Http://www.chinattl.cn](http://www.chinattl.cn)

Client **ATL**

Certificate No: **Z15-97088**

### CALIBRATION CERTIFICATE

Object: D1900V2 - SN: 5d111

Calibration Procedure(s): FD-Z11-2-003-01  
Calibration Procedures for dipole validation kits

Calibration date: July 7, 2015

This calibration Certificate documents the traceability to national standards, which realize the physical units of measurements(SI). The measurements and the uncertainties with confidence probability are given on the following pages and are part of the certificate.

All calibrations have been conducted in the closed laboratory facility: environment temperature(22±3)°C and humidity<70%.

Calibration Equipment used (M&TE critical for calibration)

Primary Standards	ID #	Cal Date(Calibrated by, Certificate No.)	Scheduled Calibration
Power Meter NRP2	101919	01-Jul-15 (CTTL, No.J15X04256)	Jun-16
Power sensor NRP-Z91	101547	01-Jul-15 (CTTL, No.J15X04256)	Jun-16
Reference Probe EX3DV4	SN 3846	24-Sep-14(SPEAG,No.EX3-3846_Sep14)	Sep-15
DAE4	SN 1331	20-Jan-15(CTTL-SPEAG, No. Z15-97011)	Jan-16
Secondary Standards	ID #	Cal Date(Calibrated by, Certificate No.)	Scheduled Calibration
Signal Generator E4438C	MY49071430	02-Feb-15 (CTTL, No.J15X00729)	Feb-16
Network Analyzer E5071C	MY46110673	03-Feb-15 (CTTL, No.J15X00728)	Feb-16

	Name	Function	Signature
Calibrated by:	Zhao Jing	SAR Test Engineer	
Reviewed by:	Qi Dianyuan	SAR Project Leader	
Approved by:	Lu Bingsong	Deputy Director of the laboratory	

Issued: July 10, 2015

This calibration certificate shall not be reproduced except in full without written approval of the laboratory.

**Glossary:**

TSL	tissue simulating liquid
ConvF	sensitivity in TSL / NORM <sub>x,y,z</sub>
N/A	not applicable or not measured

**Calibration is Performed According to the Following Standards:**

- IEEE Std 1528-2013, "IEEE Recommended Practice for Determining the Peak Spatial-Averaged Specific Absorption Rate (SAR) in the Human Head from Wireless Communications Devices: Measurement Techniques", June 2013
- IEC 62209-1, "Procedure to measure the Specific Absorption Rate (SAR) For hand-held devices used in close proximity to the ear (frequency range of 300MHz to 3GHz)", February 2005
- KDB865664, SAR Measurement Requirements for 100 MHz to 6 GHz

**Additional Documentation:**

- DASY4/5 System Handbook

**Methods Applied and Interpretation of Parameters:**

- Measurement Conditions:* Further details are available from the Validation Report at the end of the certificate. All figures stated in the certificate are valid at the frequency indicated.
- Antenna Parameters with TSL:* The dipole is mounted with the spacer to position its feed point exactly below the center marking of the flat phantom section, with the arms oriented parallel to the body axis.
- Feed Point Impedance and Return Loss:* These parameters are measured with the dipole positioned under the liquid filled phantom. The impedance stated is transformed from the measurement at the SMA connector to the feed point. The Return Loss ensures low reflected power. No uncertainty required.
- Electrical Delay:* One-way delay between the SMA connector and the antenna feed point. No uncertainty required.
- SAR measured:* SAR measured at the stated antenna input power.
- SAR normalized:* SAR as measured, normalized to an input power of 1 W at the antenna connector.
- SAR for nominal TSL parameters:* The measured TSL parameters are used to calculate the nominal SAR result.

The reported uncertainty of measurement is stated as the standard uncertainty of Measurement multiplied by the coverage factor  $k=2$ , which for a normal distribution Corresponds to a coverage probability of approximately 95%.

### Measurement Conditions

DASY system configuration, as far as not given on page 1.

DASY Version	DASY52	52.8.8.1222
Extrapolation	Advanced Extrapolation	
Phantom	Triple Flat Phantom 5.1C	
Distance Dipole Center - TSL	10 mm	with Spacer
Zoom Scan Resolution	dx, dy, dz = 5 mm	
Frequency	1900 MHz $\pm$ 1 MHz	

### Head TSL parameters

The following parameters and calculations were applied.

	Temperature	Permittivity	Conductivity
Nominal Head TSL parameters	22.0 °C	40.0	1.40 mho/m
Measured Head TSL parameters	(22.0 $\pm$ 0.2) °C	41.1 $\pm$ 6 %	1.42 mho/m $\pm$ 6 %
Head TSL temperature change during test	<1.0 °C	----	----

### SAR result with Head TSL

SAR averaged over 1 $cm^3$ (1 g) of Head TSL	Condition	
SAR measured	250 mW input power	10.3 mW / g
SAR for nominal Head TSL parameters	normalized to 1W	41.1 mW / g $\pm$ 20.8 % (k=2)
SAR averaged over 10 $cm^3$ (10 g) of Head TSL	Condition	
SAR measured	250 mW input power	5.41 mW / g
SAR for nominal Head TSL parameters	normalized to 1W	21.6 mW / g $\pm$ 20.4 % (k=2)

### Body TSL parameters

The following parameters and calculations were applied.

	Temperature	Permittivity	Conductivity
Nominal Body TSL parameters	22.0 °C	53.3	1.52 mho/m
Measured Body TSL parameters	(22.0 $\pm$ 0.2) °C	52.4 $\pm$ 6 %	1.53 mho/m $\pm$ 6 %
Body TSL temperature change during test	<1.0 °C	----	----

### SAR result with Body TSL

SAR averaged over 1 $cm^3$ (1 g) of Body TSL	Condition	
SAR measured	250 mW input power	10.1 mW / g
SAR for nominal Body TSL parameters	normalized to 1W	40.1 mW / g $\pm$ 20.8 % (k=2)
SAR averaged over 10 $cm^3$ (10 g) of Body TSL	Condition	
SAR measured	250 mW input power	5.29 mW / g
SAR for nominal Body TSL parameters	normalized to 1W	21.1 mW / g $\pm$ 20.4 % (k=2)



In Collaboration with  
**s p e a g**  
 CALIBRATION LABORATORY

Add: No.51 Xueyuan Road, Haidian District, Beijing, 100191, China  
 Tel: +86-10-62304633-2079 Fax: +86-10-62304633-2504  
 E-mail: cttl@chinattl.com Http://www.chinattl.cn

## Appendix

### Antenna Parameters with Head TSL

Impedance, transformed to feed point	50.4Ω+ 5.18jΩ
Return Loss	- 25.7dB

### Antenna Parameters with Body TSL

Impedance, transformed to feed point	45.9Ω+ 4.97jΩ
Return Loss	- 23.5dB

### General Antenna Parameters and Design

Electrical Delay (one direction)	1.306 ns
----------------------------------	----------

After long term use with 100W radiated power, only a slight warming of the dipole near the feedpoint can be measured.

The dipole is made of standard semirigid coaxial cable. The center conductor of the feeding line is directly connected to the second arm of the dipole. The antenna is therefore short-circuited for DC-signals. On some of the dipoles, small end caps are added to the dipole arms in order to improve matching when loaded according to the position as explained in the "Measurement Conditions" paragraph. The SAR data are not affected by this change. The overall dipole length is still according to the Standard. No excessive force must be applied to the dipole arms, because they might bend or the soldered connections near the feedpoint may be damaged.

### Additional EUT Data

Manufactured by	SPEAG
-----------------	-------

**DASY5 Validation Report for Head TSL**

Date: 07.07.2015

Test Laboratory: CTTL, Beijing, China

**DUT: Dipole 1900 MHz; Type: D1900V2; Serial: D1900V2 - SN: 5d111**

Communication System: UID 0, CW; Frequency: 1900 MHz; Duty Cycle: 1:1

Medium parameters used:  $f = 1900 \text{ MHz}$ ;  $\sigma = 1.419 \text{ S/m}$ ;  $\epsilon_r = 41.11$ ;  $\rho = 1000 \text{ kg/m}^3$

Phantom section: Right Section

Measurement Standard: DASY5 (IEEE/IEC/ANSI C63.19-2007)

DASY5 Configuration:

- Probe: EX3DV4 - SN3846; ConvF(7.26, 7.26, 7.26); Calibrated: 9/24/2014;
- Sensor-Surface: 2mm (Mechanical Surface Detection)
- Electronics: DAE4 Sn1331; Calibrated: 2015-01-20
- Phantom: Triple Flat Phantom 5.1C; Type: QD 000 P51 CA; Serial: 1161/1
- Measurement SW: DASY52, Version 52.8 (8); SEMCAD X Version 14.6.10 (7331)

**System Performance Check/Zoom Scan (7x7x7) (7x7x7)/Cube 0:** Measurement grid:

$dx=5\text{mm}$ ,  $dy=5\text{mm}$ ,  $dz=5\text{mm}$

Reference Value = 104.4V/m; Power Drift = -0.01 dB

Peak SAR (extrapolated) = 18.5W/kg

**SAR(1 g) = 10.3 W/kg; SAR(10 g) = 5.41 W/kg**

Maximum value of SAR (measured) = 14.7 W/kg

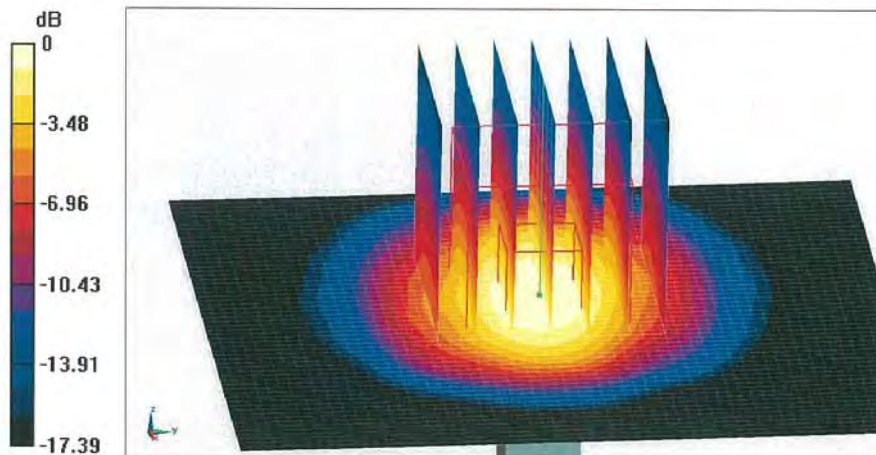

0 dB = 14.7 W/kg = 11.67 dBW/kg



### Impedance Measurement Plot for Head TSL

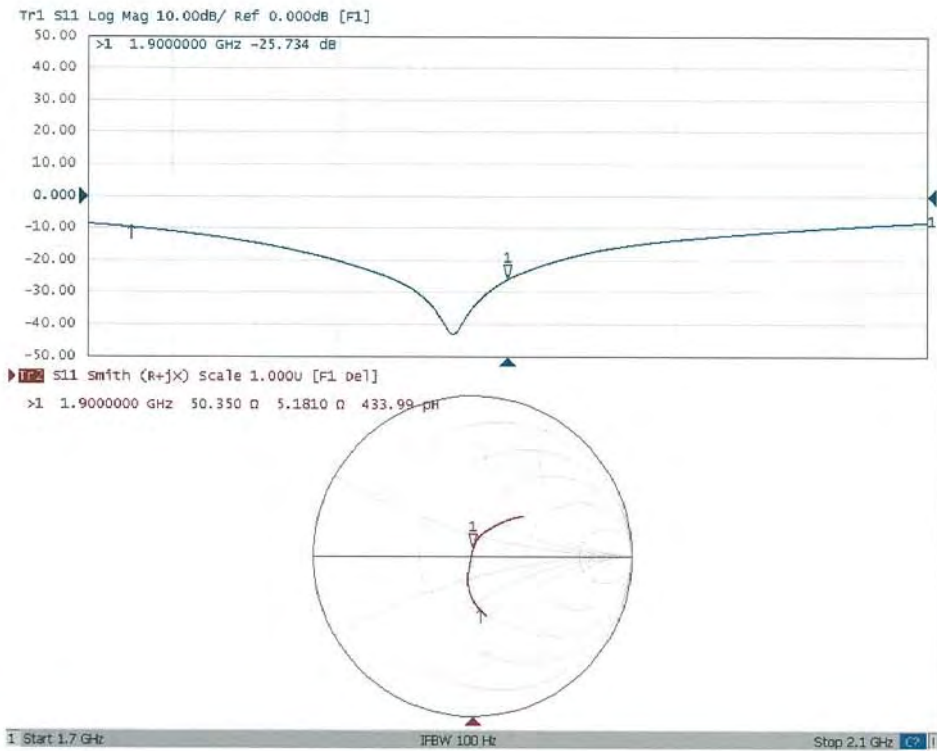

**DASY5 Validation Report for Body TSL**

Date: 07.07.2015

Test Laboratory: CTTL, Beijing, China

**DUT: Dipole 1900 MHz; Type: D1900V2; Serial: D1900V2 - SN: 5d111**

Communication System: UID 0, CW; Frequency: 1900 MHz; Duty Cycle: 1:1

Medium parameters used:  $f = 1900$  MHz;  $\sigma = 1.532$  S/m;  $\epsilon_r = 52.37$ ;  $\rho = 1000$  kg/m<sup>3</sup>

Phantom section: Left Section

Measurement Standard: DASY5 (IEEE/IEC/ANSI C63.19-2007)

DASY5 Configuration:

- Probe: EX3DV4 - SN3846; ConvF(7.15, 7.15, 7.15); Calibrated: 9/24/2014;
- Sensor-Surface: 2mm (Mechanical Surface Detection)
- Electronics: DAE4 Sn1331; Calibrated: 2015-01-20
- Phantom: Triple Flat Phantom 5.1C; Type: QD 000 P51 CA; Serial: 1161/1
- Measurement SW: DASY52, Version 52.8 (8); SEMCAD X Version 14.6.10 (7331)

**System Performance Check/Zoom Scan (7x7x7) (7x7x7)/Cube 0: Measurement grid:**

$dx=5$ mm,  $dy=5$ mm,  $dz=5$ mm

Reference Value = 93.28 V/m; Power Drift = 0.07 dB

Peak SAR (extrapolated) = 18.3 W/kg

**SAR(1 g) = 10.1 W/kg; SAR(10 g) = 5.29 W/kg**

Maximum value of SAR (measured) = 14.6 W/kg

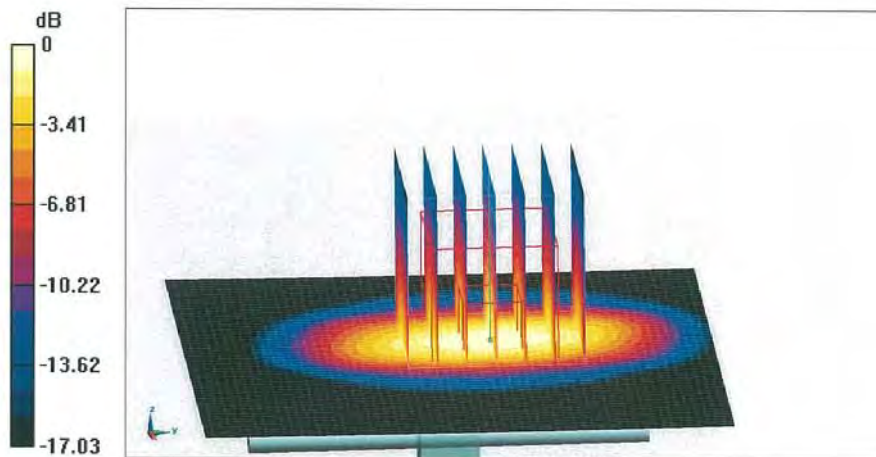

0 dB = 14.6 W/kg = 11.64 dBW/kg

### Impedance Measurement Plot for Body TSL

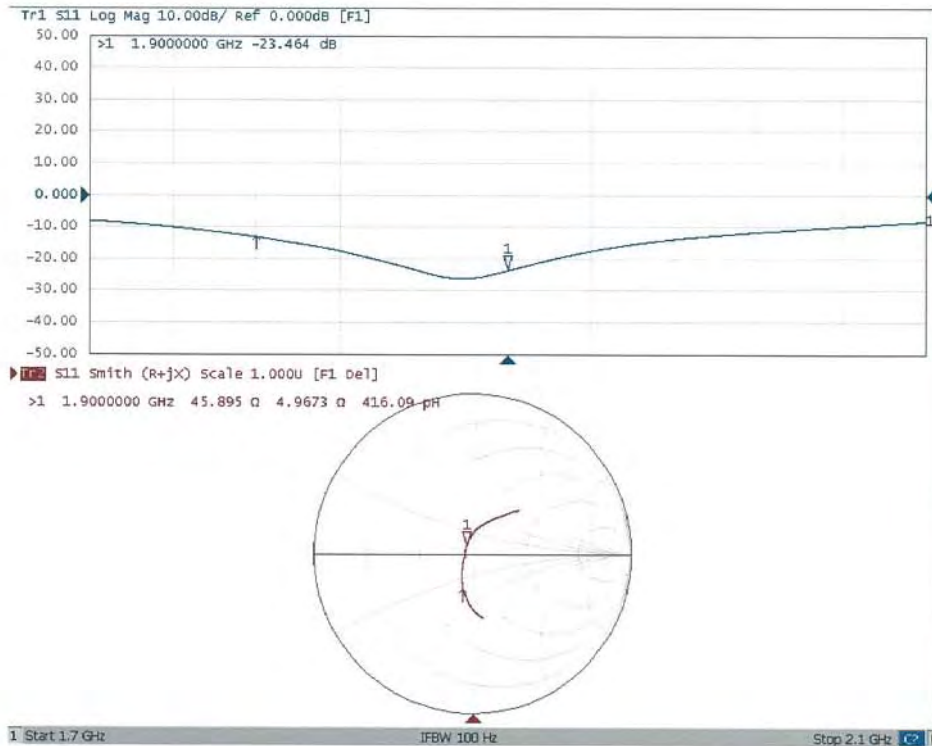



In Collaboration with  
**s p e a g**  
CALIBRATION LABORATORY



Add: No.51 Xueyuan Road, Haidian District, Beijing, 100191, China  
Tel: +86-10-62304633-2079 Fax: +86-10-62304633-2504  
E-mail: cttl@chinattl.com [Http://www.chinattl.cn](http://www.chinattl.cn)

CALIBRATION  
No. L0570

Client

ATL

Certificate No: Z15-97042

## CALIBRATION CERTIFICATE

Object: D2450V2 - SN: 712

Calibration Procedure(s): FD-Z11-2-003-01  
Calibration Procedures for dipole validation kits

Calibration date: March 12, 2015

This calibration Certificate documents the traceability to national standards, which realize the physical units of measurements(SI). The measurements and the uncertainties with confidence probability are given on the following pages and are part of the certificate.

All calibrations have been conducted in the closed laboratory facility: environment temperature(22±3)°C and humidity<70%.

Calibration Equipment used (M&TE critical for calibration)

Primary Standards	ID #	Cal Date(Calibrated by, Certificate No.)	Scheduled Calibration
Power Meter NRP2	101919	01-Jul-14 (CTTL, No.J14X02146)	Jun-15
Power sensor NRP-Z91	101547	01-Jul-14 (CTTL, No.J14X02146)	Jun-15
Reference Probe ES3DV3	SN 3142	01-Sep-14(CTTL-SPEAG, No. Z14-97079)	Aug-15
DAE4	SN 1331	20-Jan-15(CTTL-SPEAG, No. Z15-97011)	Jan-16
Secondary Standards	ID #	Cal Date(Calibrated by, Certificate No.)	Scheduled Calibration
Signal Generator E4438C	MY49071430	02-Feb-15 (CTTL, No.J15X00729)	Feb-16
Network Analyzer E5071C	MY46110673	03-Feb-15 (CTTL, No.J15X00728)	Feb-16

	Name	Function	Signature
Calibrated by:	Zhao Jing	SAR Test Engineer	
Reviewed by:	Qi Dianyuan	SAR Project Leader	
Approved by:	Lu Bingsong	Deputy Director of the laboratory	

Issued: March 12, 2015

This calibration certificate shall not be reproduced except in full without written approval of the laboratory.

Certificate No: Z15-97042

Page 1 of 8



In Collaboration with  
**s p e a g**  
CALIBRATION LABORATORY

Add: No.51 Xueyuan Road, Haidian District, Beijing, 100191, China  
Tel: +86-10-62304633-2079 Fax: +86-10-62304633-2504  
E-mail: cttl@chinattl.com Http://www.chinattl.cn

**Glossary:**

TSL	tissue simulating liquid
ConvF	sensitivity in TSL / NORM <sub>x,y,z</sub>
N/A	not applicable or not measured

**Calibration is Performed According to the Following Standards:**

- IEEE Std 1528-2013, "IEEE Recommended Practice for Determining the Peak Spatial-Averaged Specific Absorption Rate (SAR) in the Human Head from Wireless Communications Devices: Measurement Techniques", June 2013
- IEC 62209-1, "Procedure to measure the Specific Absorption Rate (SAR) For hand-held devices used in close proximity to the ear (frequency range of 300MHz to 3GHz)", February 2005
- KDB865664, SAR Measurement Requirements for 100 MHz to 6 GHz

**Additional Documentation:**

- DASY4/5 System Handbook

**Methods Applied and Interpretation of Parameters:**

- Measurement Conditions:* Further details are available from the Validation Report at the end of the certificate. All figures stated in the certificate are valid at the frequency indicated.
- Antenna Parameters with TSL:* The dipole is mounted with the spacer to position its feed point exactly below the center marking of the flat phantom section, with the arms oriented parallel to the body axis.
- Feed Point Impedance and Return Loss:* These parameters are measured with the dipole positioned under the liquid filled phantom. The impedance stated is transformed from the measurement at the SMA connector to the feed point. The Return Loss ensures low reflected power. No uncertainty required.
- Electrical Delay:* One-way delay between the SMA connector and the antenna feed point. No uncertainty required.
- SAR measured:* SAR measured at the stated antenna input power.
- SAR normalized:* SAR as measured, normalized to an input power of 1 W at the antenna connector.
- SAR for nominal TSL parameters:* The measured TSL parameters are used to calculate the nominal SAR result.

The reported uncertainty of measurement is stated as the standard uncertainty of Measurement multiplied by the coverage factor  $k=2$ , which for a normal distribution corresponds to a coverage probability of approximately 95%.



In Collaboration with  
**s p e a g**  
CALIBRATION LABORATORY

Add: No.51 Xueyuan Road, Haidian District, Beijing, 100191, China  
Tel: +86-10-62304633-2079 Fax: +86-10-62304633-2504  
E-mail: cttl@chinattl.com Http://www.chinattl.cn

### Measurement Conditions

DASY system configuration, as far as not given on page 1.

DASY Version	DASY52	52.8.8.1222
Extrapolation	Advanced Extrapolation	
Phantom	Triple Flat Phantom 5.1C	
Distance Dipole Center - TSL	10 mm	with Spacer
Zoom Scan Resolution	dx, dy, dz = 5 mm	
Frequency	2450 MHz $\pm$ 1 MHz	

### Head TSL parameters

The following parameters and calculations were applied.

	Temperature	Permittivity	Conductivity
Nominal Head TSL parameters	22.0 °C	39.2	1.80 mho/m
Measured Head TSL parameters	(22.0 $\pm$ 0.2) °C	39.5 $\pm$ 6 %	1.77 mho/m $\pm$ 6 %
Head TSL temperature change during test	<1.0 °C	---	---

### SAR result with Head TSL

SAR averaged over 1 cm <sup>3</sup> (1 g) of Head TSL	Condition	
SAR measured	250 mW input power	13.7 mW / g
SAR for nominal Head TSL parameters	normalized to 1W	<b>55.3 mW / g <math>\pm</math> 20.8 % (k=2)</b>
SAR averaged over 10 cm <sup>3</sup> (10 g) of Head TSL	Condition	
SAR measured	250 mW input power	6.33 mW / g
SAR for nominal Head TSL parameters	normalized to 1W	<b>25.5 mW / g <math>\pm</math> 20.4 % (k=2)</b>

### Body TSL parameters

The following parameters and calculations were applied.

	Temperature	Permittivity	Conductivity
Nominal Body TSL parameters	22.0 °C	52.7	1.95 mho/m
Measured Body TSL parameters	(22.0 $\pm$ 0.2) °C	51.8 $\pm$ 6 %	1.96 mho/m $\pm$ 6 %
Body TSL temperature change during test	<1.0 °C	---	---

### SAR result with Body TSL

SAR averaged over 1 cm <sup>3</sup> (1 g) of Body TSL	Condition	
SAR measured	250 mW input power	13.3 mW / g
SAR for nominal Body TSL parameters	normalized to 1W	<b>52.9 mW / g <math>\pm</math> 20.8 % (k=2)</b>
SAR averaged over 10 cm <sup>3</sup> (10 g) of Body TSL	Condition	
SAR measured	250 mW input power	6.13 mW / g
SAR for nominal Body TSL parameters	normalized to 1W	<b>24.4 mW / g <math>\pm</math> 20.4 % (k=2)</b>



In Collaboration with  
**s p e a g**  
 CALIBRATION LABORATORY

Add: No.51 Xueyuan Road, Haidian District, Beijing, 100191, China  
 Tel: +86-10-62304633-2079 Fax: +86-10-62304633-2504  
 E-mail: cttl@chinattl.com Http://www.chinattl.cn

## Appendix

### Antenna Parameters with Head TSL

Impedance, transformed to feed point	52.7Ω+ 5.06jΩ
Return Loss	- 25.1dB

### Antenna Parameters with Body TSL

Impedance, transformed to feed point	50.0Ω+ 6.01jΩ
Return Loss	- 24.4dB

### General Antenna Parameters and Design

Electrical Delay (one direction)	1.037 ns
----------------------------------	----------

After long term use with 100W radiated power, only a slight warming of the dipole near the feedpoint can be measured.

The dipole is made of standard semirigid coaxial cable. The center conductor of the feeding line is directly connected to the second arm of the dipole. The antenna is therefore short-circuited for DC-signals. On some of the dipoles, small end caps are added to the dipole arms in order to improve matching when loaded according to the position as explained in the "Measurement Conditions" paragraph. The SAR data are not affected by this change. The overall dipole length is still according to the Standard. No excessive force must be applied to the dipole arms, because they might bend or the soldered connections near the feedpoint may be damaged.

### Additional EUT Data

Manufactured by	SPEAG
-----------------	-------



In Collaboration with  
**s p e a g**  
 CALIBRATION LABORATORY

Add: No.51 Xueyuan Road, Haidian District, Beijing, 100191, China  
 Tel: +86-10-62304633-2079 Fax: +86-10-62304633-2504  
 E-mail: cttl@chinattl.com Http://www.chinattl.cn

**DASY5 Validation Report for Head TSL**

Date: 03.12.2015

Test Laboratory: CTTL, Beijing, China

**DUT: Dipole 2450 MHz; Type: D2450V2; Serial: D2450V2 - SN: 712**

Communication System: UID 0, CW; Frequency: 2450 MHz; Duty Cycle: 1:1

Medium parameters used:  $f = 2450$  MHz;  $\sigma = 1.774$  S/m;  $\epsilon_r = 39.52$ ;  $\rho = 1000$  kg/m<sup>3</sup>

Phantom section: Right Section

Measurement Standard: DASY5 (IEEE/IEC/ANSI C63.19-2007)

DASY5 Configuration:

- Probe: ES3DV3 - SN3142; ConvF(4.58, 4.58, 4.58); Calibrated: 2014-09-01;
- Sensor-Surface: 3mm (Mechanical Surface Detection)
- Electronics: DAE4 S1331; Calibrated: 2015-01-20
- Phantom: Triple Flat Phantom 5.1C; Type: QD 000 P51 CA; Serial: 1161/1
- Measurement SW: DASY52, Version 52.8 (8); SEMCAD X Version 14.6.10 (7331)

**System Performance Check at Frequencies above 1 GHz/d=10mm, Pin=250 mW, dist=3.0mm (ES-Probe)/Zoom Scan (7x7x7) (7x7x7)/Cube 0: Measurement grid:**

dx=5mm, dy=5mm, dz=5mm

Reference Value = 99.87 V/m; Power Drift = 0.04 dB

Peak SAR (extrapolated) = 28.9 W/kg

**SAR(1 g) = 13.7 W/kg; SAR(10 g) = 6.33 W/kg**

Maximum value of SAR (measured) = 18.0 W/kg

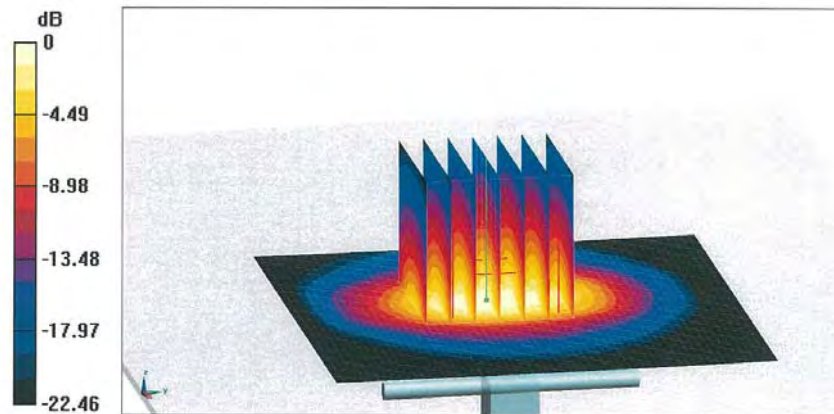

0 dB = 18.0 W/kg = 12.55 dB W/kg





In Collaboration with  
**s p e a g**  
 CALIBRATION LABORATORY

Add: No.51 Xueyuan Road, Haidian District, Beijing, 100191, China  
 Tel: +86-10-62304633-2079 Fax: +86-10-62304633-2504  
 E-mail: cttl@chinattl.com Http://www.chinattl.cn

### Impedance Measurement Plot for Head TSL

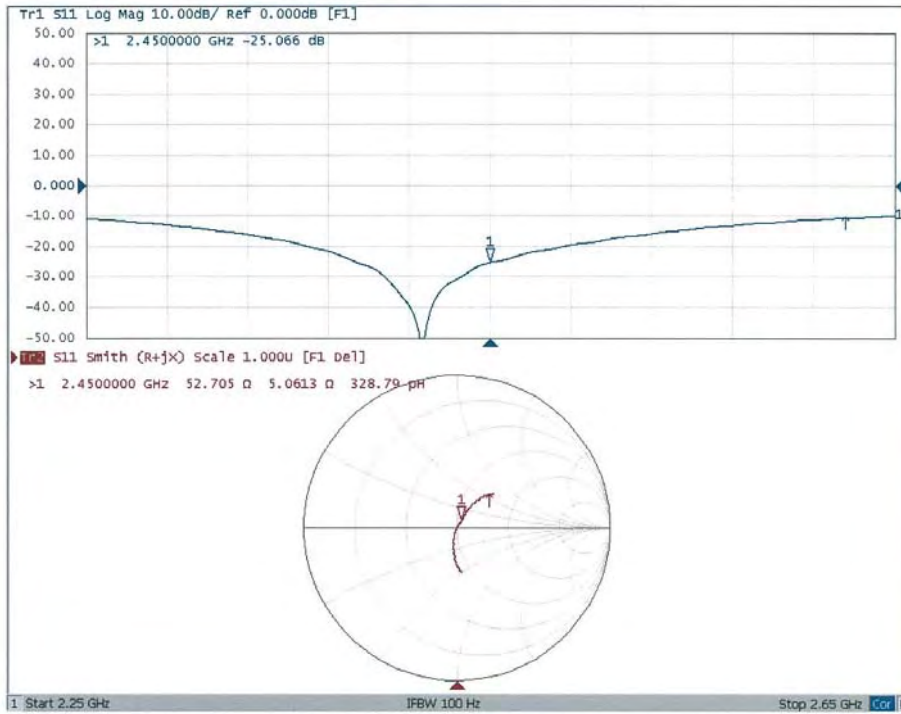



In Collaboration with  
**s p e a g**  
CALIBRATION LABORATORY

Add: No.51 Xueyuan Road, Haidian District, Beijing, 100191, China  
Tel: +86-10-62304633-2079 Fax: +86-10-62304633-2504  
E-mail: cttl@chinattl.com Http://www.chinattl.cn

**DASY5 Validation Report for Body TSL**

Date: 03.12.2015

Test Laboratory: CTTL, Beijing, China

**DUT: Dipole 2450 MHz; Type: D2450V2; Serial: D2450V2 - SN: 712**

Communication System: UID 0, CW; Frequency: 2450 MHz; Duty Cycle: 1:1

Medium parameters used:  $f = 2450$  MHz;  $\sigma = 1.962$  S/m;  $\epsilon_r = 51.82$ ;  $\rho = 1000$  kg/m<sup>3</sup>

Phantom section: Center Section

Measurement Standard: DASY5 (IEEE/IEC/ANSI C63.19-2007)

DASY5 Configuration:

- Probe: ES3DV3 - SN3142; ConvF(4.29, 4.29, 4.29); Calibrated: 2014-09-01;
- Sensor-Surface: 3mm (Mechanical Surface Detection)
- Electronics: DAE4 Sn1331; Calibrated: 2015-01-20
- Phantom: Triple Flat Phantom 5.1C; Type: QD 000 P51 CA; Serial: 1161/1
- Measurement SW: DASY52, Version 52.8 (8); SEMCAD X Version 14.6.10 (7331)

**System Performance Check at Frequencies above 1 GHz/d=10mm, Pin=250 mW,**

**dist=3.0mm (ES-Probe)/Zoom Scan (7x7x7) (8x7x7)/Cube 0: Measurement grid:**

dx=5mm, dy=5mm, dz=5mm

Reference Value = 94.63 V/m; Power Drift = 0.02 dB

Peak SAR (extrapolated) = 27.6 W/kg

**SAR(1 g) = 13.3 W/kg; SAR(10 g) = 6.13 W/kg**

Maximum value of SAR (measured) = 17.6 W/kg

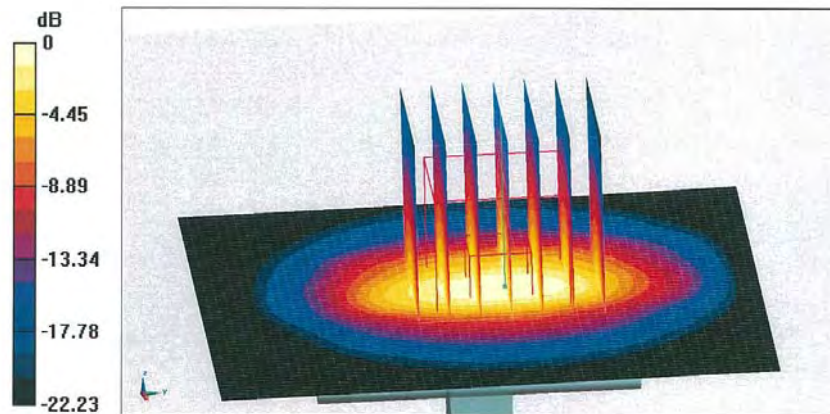

0 dB = 17.6 W/kg = 12.46 dBW/kg



In Collaboration with  
**s p e a g**  
 CALIBRATION LABORATORY

Add: No.51 Xueyuan Road, Haidian District, Beijing, 100191, China  
 Tel: +86-10-62304633-2079 Fax: +86-10-62304633-2504  
 E-mail: cttl@chinattl.com Http://www.chinattl.cn

**Impedance Measurement Plot for Body TSL**

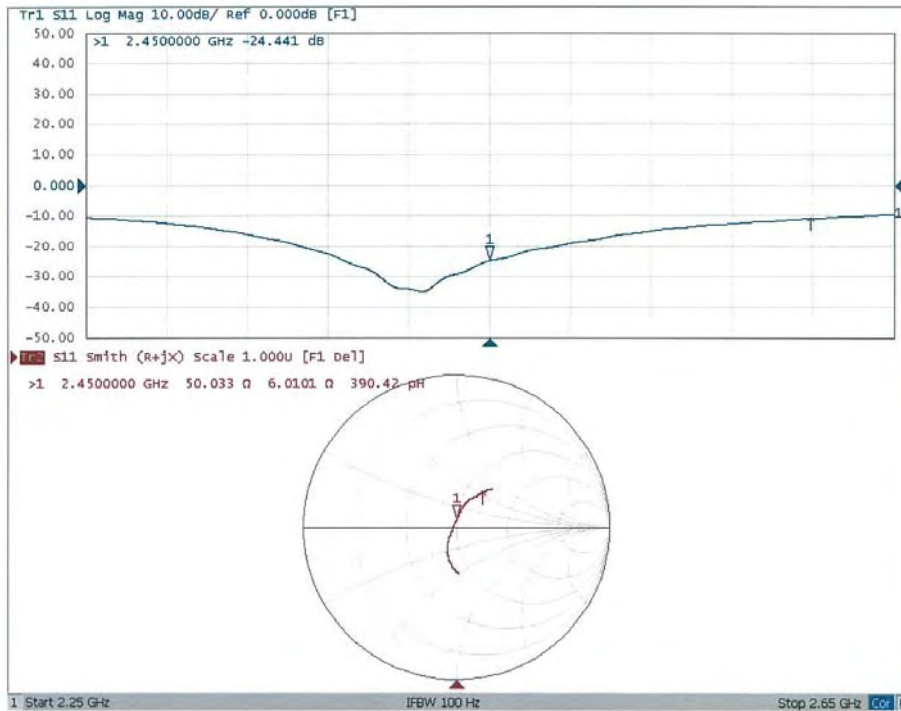

**Acceptable Conditions for SAR Measurements Using Probes and Dipoles  
Calibrated under the SPEAG-CTTL Dual-Logo Calibration Program to  
Support FCC Equipment Certification**

The acceptable conditions for SAR measurements using probes, dipoles and DAEs calibrated by CTTL (*China Telecommunication Technology Labs*), under the Dual-Logo Calibration Certificate program and quality assurance (QA) protocols established between SPEAG (*Schmid & Partner Engineering AG, Switzerland*) and CTTL, to support FCC (*U.S. Federal Communications Commission*) equipment certification are defined and described in the following. The conditions in this KDB are valid until December 31, 2015.

- 1) The agreement established between SPEAG and CTTL is only applicable to calibration services performed by CTTL where its clients (companies and divisions of such companies) are headquartered in the Greater China Region, including Taiwan and Hong Kong. CTTL shall inform the FCC of any changes or early termination to the agreement.
- 2) Only a subset of the calibration services specified in the SPEAG-CTTL agreement, while it remains valid, are applicable to SAR measurements performed using such equipment for supporting FCC equipment certification. These are identified in the following.
  - a) Calibration of dosimetric (SAR) probes EX3DVx, ET3DVx and ES3DVx.
    - i) Free-space E-field and H-field probes, including those used for HAC (hearing aid compatibility) evaluation, temperature probes, other probes or equipment not identified in this document, when calibrated by CTTL, are excluded and cannot be used for measurements to support FCC equipment certification.
    - ii) Signal specific and bundled probe calibrations based on PMR (probe modulation response) characteristics or probe sensor model based linearization methods that are not fully described in SAR standards are excluded and cannot be used for measurements to support FCC equipment certification.
  - b) Calibration of SAR system validation dipoles, excluding HAC dipoles.
  - c) Calibration of data acquisition electronics DAE3Vx, DAE4Vx and DAEasyVx.
  - d) For FCC equipment certification purposes, the frequency range of SAR probe and dipole calibrations is limited to 700 MHz - 6 GHz and provided it is supported by the equipment identified in the CTTL QA protocol (a separate attachment to this document).
  - e) The identical system and equipment setup, measurement configurations, hardware, evaluation algorithms, calibration and QA protocols, including the format of calibration certificates and reports used by SPEAG shall be applied by CTTL. Equivalent test equipment and measurement configurations may be considered only when agreed by both SPEAG and the FCC.
  - f) The calibrated items are only applicable to SPEAG DASY 4 and DASY 5 systems or higher version systems that satisfy the requirements of this KDB.
- 3) The SPEAG-CTTL agreement includes specific protocols identified in the following to ensure the quality of calibration services provided by CTTL under this SPEAG-

CTTL Dual-Logo calibration agreement are equivalent to the calibration services provided by SPEAG. CTTL shall apply the required protocols without modification and, upon request, provide copies of documentation to the FCC to substantiate program implementation.

- a) The Inter-laboratory Calibration Evaluation (ILCE) stated in the CTTL QA protocol shall be performed between SPEAG and CTTL at least once every 12 months. The ILCE acceptance criteria defined in the CTTL QA protocol shall be satisfied for the CTTL, SPEAG and FCC agreements to remain valid.
  - b) Check of Calibration Certificate (CCC) shall be performed by SPEAG for all calibrations performed by CTTL. Written confirmation from SPEAG is required for CTTL to issue calibration certificates under the SPEAG-CTTL Dual-Logo calibration program. Quarterly reports for all calibrations performed by CTTL under the program are also issued by SPEAG.
  - c) The calibration equipment and measurement system used by CTTL shall be verified before each calibration service according to the specific reference SAR probes, dipoles, and DAE calibrated by SPEAG. The results shall be reproducible and within the defined acceptance criteria specified in the CTTL QA protocol before each actual calibration can commence. CTTL shall maintain records of the measurement and calibration system verification results for all calibrations.
  - d) Quality Check of Calibration (QCC) certificates shall be performed by SPEAG at least once every 12 months. SPEAG shall visit CTTL facilities to verify the laboratory, equipment, applied procedures and plausibility of randomly selected certificates.
- 4) A copy of this document shall be provided to CTTL clients that accept calibration services according to the SPEAG-CTTL Dual-Logo calibration program, which should be presented to a TCB (*Telecommunication Certification Body*), to facilitate FCC equipment approval.
  - 5) CTTL shall address any questions raised by its clients or TCBS relating to the SPEAG-CTTL Dual-Logo calibration program and inform the FCC and SPEAG of any critical issues.



Add: No.51 Xueyuan Road, Haidian District, Beijing, 100191, China  
 Tel: +86-10-62304633-2079 Fax: +86-10-62304633-2504  
 E-mail: cttl@chinatl.com [Http://www.chinatl.cn](http://www.chinatl.cn)



Client **ATL**

Certificate No: **Z15-97003**

### CALIBRATION CERTIFICATE

Object: **EX3DV4 - SN:3847**

Calibration Procedure(s): **FD-Z11-2-004-01**  
**Calibration Procedures for Dosimetric E-field Probes**

Calibration date: **January 30, 2015**

This calibration Certificate documents the traceability to national standards, which realize the physical units of measurements(SI). The measurements and the uncertainties with confidence probability are given on the following pages and are part of the certificate.

All calibrations have been conducted in the closed laboratory facility: environment temperature(22±3)°C and humidity<70%.

Calibration Equipment used (M&TE critical for calibration)

Primary Standards	ID #	Cal Date(Calibrated by, Certificate No.)	Scheduled Calibration
Power Meter NRP2	101919	01-Jul-14 (CTTL, No.J14X02146)	Jun-15
Power sensor NRP-Z91	101547	01-Jul-14 (CTTL, No.J14X02146)	Jun-15
Power sensor NRP-Z91	101548	01-Jul-14 (CTTL, No.J14X02146)	Jun-15
Reference10dBAttenuator	18N50W-10dB	13-Mar-14(TMC,No.JZ14-1103)	Mar-16
Reference20dBAttenuator	18N50W-20dB	13-Mar-14(TMC,No.JZ14-1104)	Mar-16
Reference Probe EX3DV4	SN 3617	28-Aug-14(SPEAG,No.EX3-3617_Aug14)	Aug-15
DAE4	SN 777	17-Sep-14 (SPEAG, DAE4-777_Sep14)	Sep -15
Secondary Standards	ID #	Cal Date(Calibrated by, Certificate No.)	Scheduled Calibration
SignalGeneratorMG3700A	6201052605	01-Jul-14 (CTTL, No.J14X02145)	Jun-15
Network Analyzer E5071C	MY46110673	15-Feb-14 (TMC, No.JZ14-781)	Feb-15

	Name	Function	Signature
Calibrated by:	Yu Zongying	SAR Test Engineer	
Reviewed by:	Qi Dianyuan	SAR Project Leader	
Approved by:	Lu Bingsong	Deputy Director of the laboratory	

Issued: January 31, 2015

This calibration certificate shall not be reproduced except in full without written approval of the laboratory.

Certificate No: Z15-97003

Page 1 of 11

### Glossary:

TSL	tissue simulating liquid
NORM <sub>x,y,z</sub>	sensitivity in free space
ConvF	sensitivity in TSL / NORM <sub>x,y,z</sub>
DCP	diode compression point
CF	crest factor (1/duty_cycle) of the RF signal
A,B,C,D	modulation dependent linearization parameters
Polarization $\Phi$	$\Phi$ rotation around probe axis
Polarization $\theta$	$\theta$ rotation around an axis that is in the plane normal to probe axis (at measurement center), $\theta=0$ is normal to probe axis

Connector Angle information used in DASY system to align probe sensor X to the robot coordinate system

### Calibration is Performed According to the Following Standards:

- a) IEEE Std 1528-2013, "IEEE Recommended Practice for Determining the Peak Spatial-Averaged Specific Absorption Rate (SAR) in the Human Head from Wireless Communications Devices: Measurement Techniques", June 2013
- b) IEC 62209-1, "Procedure to measure the Specific Absorption Rate (SAR) for hand-held devices used in close proximity to the ear (frequency range of 300MHz to 3GHz)", February 2005

### Methods Applied and Interpretation of Parameters:

- **NORM<sub>x,y,z</sub>**: Assessed for E-field polarization  $\theta=0$  ( $f \leq 900\text{MHz}$  in TEM-cell;  $f > 1800\text{MHz}$ : waveguide). NORM<sub>x,y,z</sub> are only intermediate values, i.e., the uncertainties of NORM<sub>x,y,z</sub> does not effect the  $E^2$ -field uncertainty inside TSL (see below ConvF).
- **NORM(f)<sub>x,y,z</sub>** = NORM<sub>x,y,z</sub> \* frequency\_response (see Frequency Response Chart). This linearization is implemented in DASY4 software versions later than 4.2. The uncertainty of the frequency response is included in the stated uncertainty of ConvF.
- **DCP<sub>x,y,z</sub>**: DCP are numerical linearization parameters assessed based on the data of power sweep (no uncertainty required). DCP does not depend on frequency nor media.
- **PAR**: PAR is the Peak to Average Ratio that is not calibrated but determined based on the signal characteristics.
- **A<sub>x,y,z</sub>; B<sub>x,y,z</sub>; C<sub>x,y,z</sub>; VR<sub>x,y,z</sub>; A,B,C** are numerical linearization parameters assessed based on the data of power sweep for specific modulation signal. The parameters do not depend on frequency nor media. VR is the maximum calibration range expressed in RMS voltage across the diode.
- **ConvF and Boundary Effect Parameters**: Assessed in flat phantom using E-field (or Temperature Transfer Standard for  $f \leq 800\text{MHz}$ ) and inside waveguide using analytical field distributions based on power measurements for  $f > 800\text{MHz}$ . The same setups are used for assessment of the parameters applied for boundary compensation (alpha, depth) of which typical uncertainty valued are given. These parameters are used in DASY4 software to improve probe accuracy close to the boundary. The sensitivity in TSL corresponds to NORM<sub>x,y,z</sub> \* ConvF whereby the uncertainty corresponds to that given for ConvF. A frequency dependent ConvF is used in DASY version 4.4 and higher which allows extending the validity from  $\pm 50\text{MHz}$  to  $\pm 100\text{MHz}$ .
- **Spherical isotropy (3D deviation from isotropy)**: in a field of low gradients realized using a flat phantom exposed by a patch antenna.
- **Sensor Offset**: The sensor offset corresponds to the offset of virtual measurement center from the probe tip (on probe axis). No tolerance required.
- **Connector Angle**: The angle is assessed using the information gained by determining the NORM<sub>x</sub> (no uncertainty required).



Add: No.51 Xueyuan Road, Haidian District, Beijing, 100191, China  
Tel: +86-10-62304633-2079 Fax: +86-10-62304633-2504  
E-mail: cttl@chinattl.com Http://www.chinattl.cn

# Probe EX3DV4

## SN: 3847

Calibrated: January 30, 2015

Calibrated for DASY/EASY Systems

(Note: non-compatible with DASY2 system!)





Add: No.51 Xueyuan Road, Haidian District, Beijing, 100191, China  
 Tel: +86-10-62304633-2079 Fax: +86-10-62304633-2504  
 E-mail: cttl@chinattl.com Http://www.chinattl.cn

## DASY/EASY – Parameters of Probe: EX3DV4 – SN: 3847

### Basic Calibration Parameters

	Sensor X	Sensor Y	Sensor Z	Unc (k=2)
Norm( $\mu\text{V}/(\text{V}/\text{m})^2$ ) <sup>A</sup>	0.45	0.35	0.42	±10.8%
DCP(mV) <sup>B</sup>	102.5	102.7	101.5	

### Modulation Calibration Parameters

UID	Communication System Name		A dB	B dB $\mu\text{V}$	C	D dB	VR mV	Unc <sup>E</sup> (k=2)
0	CW	X	0.0	0.0	1.0	0.00	176.8	±2.7%
		Y	0.0	0.0	1.0		158.5	
		Z	0.0	0.0	1.0		170.2	

The reported uncertainty of measurement is stated as the standard uncertainty of Measurement multiplied by the coverage factor k=2, which for a normal distribution Corresponds to a coverage probability of approximately 95%.

<sup>A</sup> The uncertainties of Norm X, Y, Z do not affect the E<sup>2</sup>-field uncertainty inside TSL (see Page 5 and Page 6).

<sup>B</sup> Numerical linearization parameter: uncertainty not required.

<sup>E</sup> Uncertainty is determined using the max. deviation from linear response applying rectangular distribution and is expressed for the square of the field value.



Add: No.51 Xueyuan Road, Haidian District, Beijing, 100191, China  
 Tel: +86-10-62304633-2079 Fax: +86-10-62304633-2504  
 E-mail: cttl@chinattl.com Http://www.chinattl.cn

## DASY/EASY – Parameters of Probe: EX3DV4 – SN: 3847

### Calibration Parameter Determined in Head Tissue Simulating Media

f [MHz] <sup>C</sup>	Relative Permittivity <sup>F</sup>	Conductivity (S/m) <sup>F</sup>	ConvF X	ConvF Y	ConvF Z	Alpha <sup>G</sup>	Depth <sup>G</sup> (mm)	Unct. (k=2)
750	41.9	0.89	9.71	9.71	9.71	0.13	1.25	±12%
835	41.5	0.90	9.12	9.12	9.12	0.14	1.26	±12%
900	41.5	0.97	8.99	8.99	8.99	0.13	1.34	±12%
1750	40.1	1.37	7.92	7.92	7.92	0.16	1.40	±12%
1900	40.0	1.40	7.79	7.79	7.79	0.17	1.35	±12%
2000	40.0	1.40	7.72	7.72	7.72	0.13	1.71	±12%
2300	39.5	1.67	7.48	7.48	7.48	0.28	0.91	±12%
2450	39.2	1.80	7.06	7.06	7.06	0.50	0.77	±12%
2600	39.0	1.96	6.91	6.91	6.91	0.66	0.67	±12%
5200	36.0	4.66	5.32	5.32	5.32	0.45	1.16	±13%
5300	35.9	4.76	5.04	5.04	5.04	0.43	1.18	±13%
5500	35.6	4.96	4.83	4.83	4.83	0.46	1.26	±13%
5600	35.5	5.07	4.77	4.77	4.77	0.52	1.10	±13%
5800	35.3	5.27	4.66	4.66	4.66	0.55	1.11	±13%

<sup>C</sup> Frequency validity of ±100MHz only applies for DASY v4.4 and higher (Page 2), else it is restricted to ±50MHz. The uncertainty is the RSS of ConvF uncertainty at calibration frequency and the uncertainty for the indicated frequency band.

<sup>F</sup> At frequency below 3 GHz, the validity of tissue parameters ( $\epsilon$  and  $\sigma$ ) can be relaxed to ±10% if liquid compensation formula is applied to measured SAR values. At frequencies above 3 GHz, the validity of tissue parameters ( $\epsilon$  and  $\sigma$ ) is restricted to ±5%. The uncertainty is the RSS of the ConvF uncertainty for indicated target tissue parameters.

<sup>G</sup> Alpha/Depth are determined during calibration. SPEAG warrants that the remaining deviation due to the boundary effect after compensation is always less than ± 1% for frequencies below 3 GHz and below ± 2% for the frequencies between 3-6 GHz at any distance larger than half the probe tip diameter from the boundary.



Add: No.51 Xueyuan Road, Haidian District, Beijing, 100191, China  
 Tel: +86-10-62304633-2079 Fax: +86-10-62304633-2504  
 E-mail: cttl@chinattl.com Http://www.chinattl.cn

## DASY/EASY – Parameters of Probe: EX3DV4 – SN: 3847

### Calibration Parameter Determined in Body Tissue Simulating Media

f [MHz] <sup>C</sup>	Relative Permittivity <sup>F</sup>	Conductivity (S/m) <sup>F</sup>	ConvF X	ConvF Y	ConvF Z	Alpha <sup>G</sup>	Depth <sup>G</sup> (mm)	Unct. (k=2)
750	55.5	0.96	9.53	9.53	9.53	0.14	1.56	± 12%
835	55.2	0.97	9.42	9.42	9.42	0.18	1.36	± 12%
900	55.0	1.05	9.19	9.19	9.19	0.20	1.24	± 12%
1750	53.4	1.49	7.65	7.65	7.65	0.13	1.80	± 12%
1900	53.3	1.52	7.46	7.46	7.46	0.16	1.43	± 12%
2000	53.3	1.52	7.65	7.65	7.65	0.13	2.07	± 12%
2300	52.9	1.81	7.52	7.52	7.52	0.34	1.15	± 12%
2450	52.7	1.95	7.29	7.29	7.29	0.32	1.18	± 12%
2600	52.5	2.16	7.19	7.19	7.19	0.42	0.91	± 12%
5200	49.0	5.30	4.96	4.96	4.96	0.52	1.21	± 13%
5300	48.9	5.42	4.78	4.78	4.78	0.60	1.03	± 13%
5500	48.6	5.65	4.42	4.42	4.42	0.58	1.19	± 13%
5600	48.5	5.77	4.41	4.41	4.41	0.61	1.04	± 13%
5800	48.2	6.00	4.35	4.35	4.35	0.66	0.90	± 13%

<sup>C</sup> Frequency validity of ±100MHz only applies for DASY v4.4 and higher (Page 2), else it is restricted to ±50MHz. The uncertainty is the RSS of ConvF uncertainty at calibration frequency and the uncertainty for the indicated frequency band.

<sup>F</sup> At frequency below 3 GHz, the validity of tissue parameters ( $\epsilon$  and  $\sigma$ ) can be relaxed to ±10% if liquid compensation formula is applied to measured SAR values. At frequencies above 3 GHz, the validity of tissue parameters ( $\epsilon$  and  $\sigma$ ) is restricted to ±5%. The uncertainty is the RSS of the ConvF uncertainty for indicated target tissue parameters.

<sup>G</sup> Alpha/Depth are determined during calibration. SPEAG warrants that the remaining deviation due to the boundary effect after compensation is always less than ± 1% for frequencies below 3 GHz and below ± 2% for the frequencies between 3-6 GHz at any distance larger than half the probe tip diameter from the boundary.

## Frequency Response of E-Field (TEM-Cell: ifi110 EXX, Waveguide: R22)

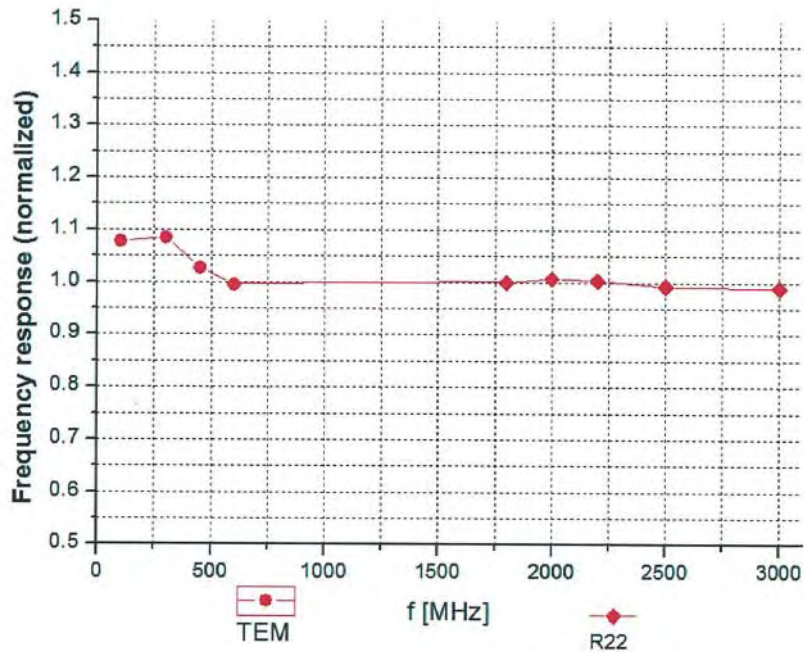

Uncertainty of Frequency Response of E-field:  $\pm 7.5\%$  (k=2)

## Receiving Pattern ( $\Phi$ ), $\theta=0^\circ$

f=600 MHz, TEM

f=1800 MHz, R22

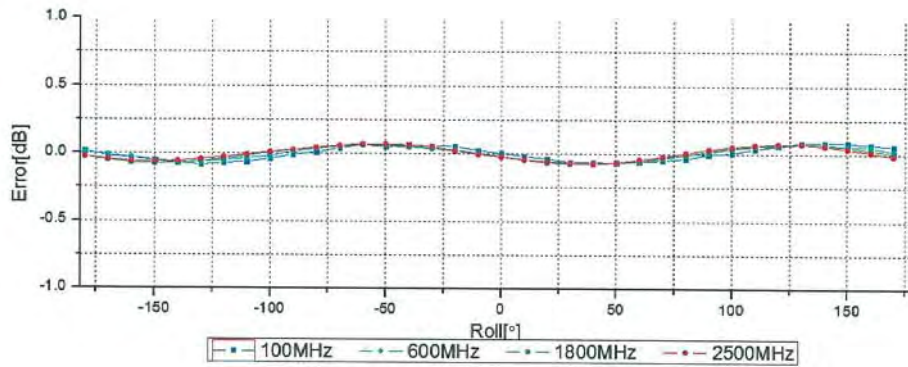
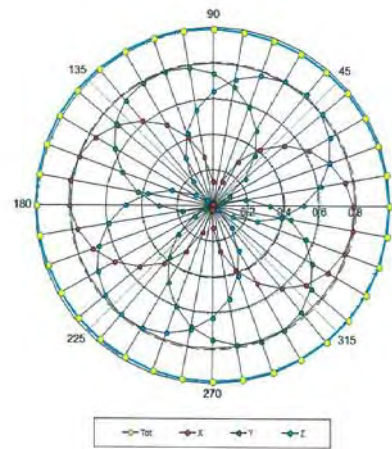
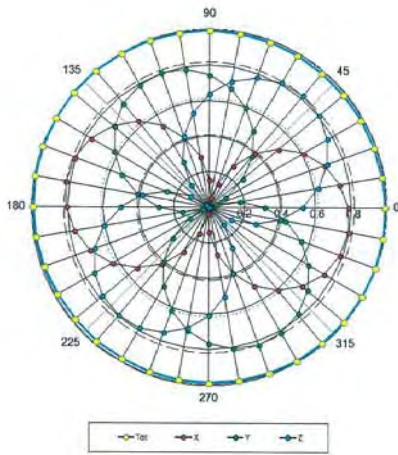

Uncertainty of Axial Isotropy Assessment:  $\pm 0.9\%$  ( $k=2$ )

### Dynamic Range f(SAR<sub>head</sub>) (TEM cell, f = 900 MHz)

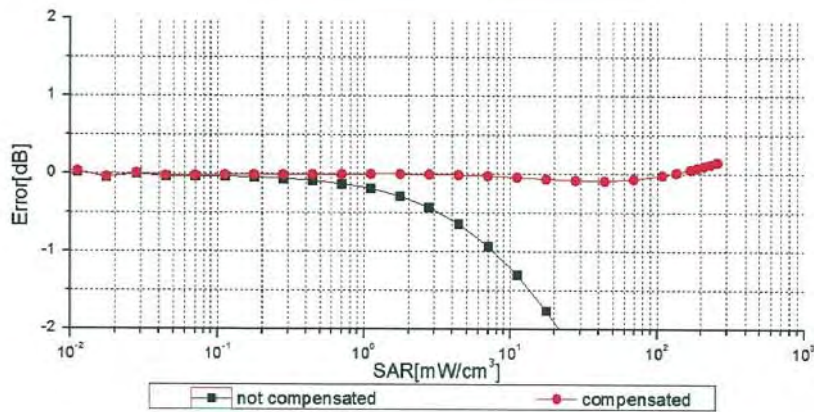
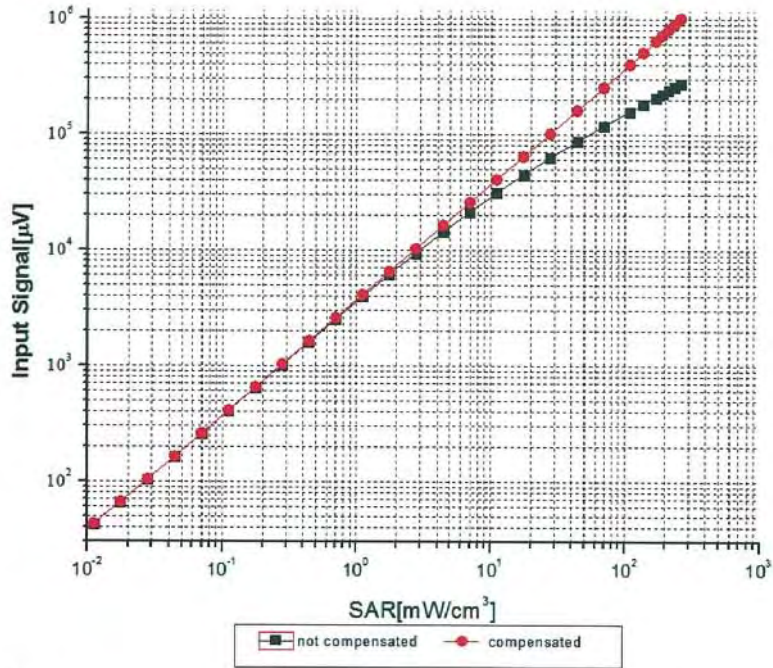

Uncertainty of Linearity Assessment: ±0.9% (k=2)

## Conversion Factor Assessment

f=900 MHz, WGLS R9(H\_convF)

f=1750 MHz, WGLS R22(H\_convF)

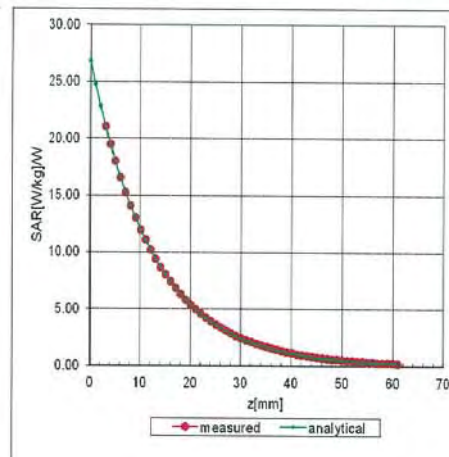
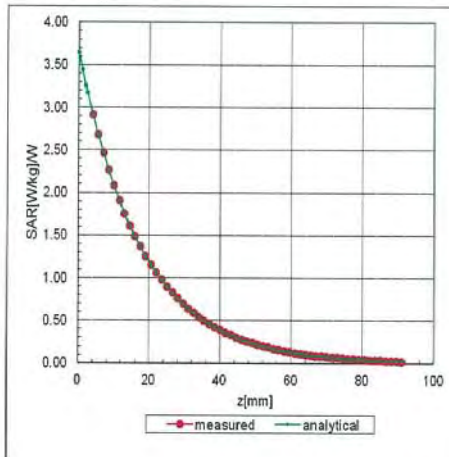

## Deviation from Isotropy in Liquid

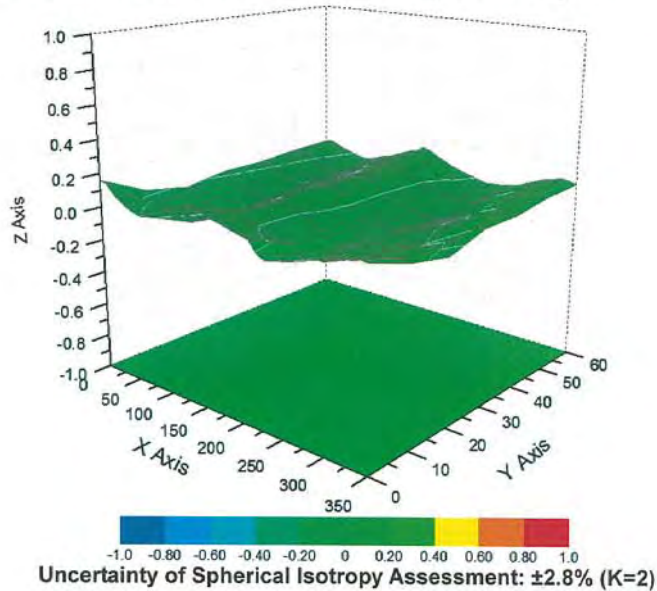



Add: No.51 Xueyuan Road, Haidian District, Beijing, 100191, China  
Tel: +86-10-62304633-2079 Fax: +86-10-62304633-2504  
E-mail: cttl@chinattl.com Http://www.chinattl.cn

## DASY/EASY – Parameters of Probe: EX3DV4 – SN: 3847

### Other Probe Parameters

Sensor Arrangement	Triangular
Connector Angle (°)	12.6
Mechanical Surface Detection Mode	enabled
Optical Surface Detection Mode	disable
Probe Overall Length	337mm
Probe Body Diameter	10mm
Tip Length	9mm
Tip Diameter	2.5mm
Probe Tip to Sensor X Calibration Point	1mm
Probe Tip to Sensor Y Calibration Point	1mm
Probe Tip to Sensor Z Calibration Point	1mm
Recommended Measurement Distance from Surface	1.4mm





Add: No.51 Xueyuan Road, Haidian District, Beijing, 100191, China  
 Tel: +86-10-62304633-2079 Fax: +86-10-62304633-2504  
 E-mail: cttl@chinattl.com [Http://www.chinattl.cn](http://www.chinattl.cn)



Client : **ATL**

Certificate No: **Z15-97004**

CALIBRATION CERTIFICATE			
Object	DAE4 - SN: 541		
Calibration Procedure(s)	FD-Z11-2-002-01 Calibration Procedure for the Data Acquisition Electronics (DAEx)		
Calibration date:	February 03, 2015		
<p>This calibration Certificate documents the traceability to national standards, which realize the physical units of measurements(SI). The measurements and the uncertainties with confidence probability are given on the following pages and are part of the certificate.</p> <p>All calibrations have been conducted in the closed laboratory facility: environment temperature(22±3)°C and humidity&lt;70%.</p> <p>Calibration Equipment used (M&amp;TE critical for calibration)</p>			
Primary Standards	ID #	Cal Date(Calibrated by, Certificate No.)	Scheduled Calibration
Process Calibrator 753	1971018	01-July-14 (CTTL, No:J14X02147)	July-15
Calibrated by:	Name	Function	Signature
	Yu Zongying	SAR Test Engineer	
Reviewed by:	Qi Dianyuan	SAR Project Leader	
Approved by:	Lu Bingsong	Deputy Director of the laboratory	
Issued: February 04, 2015			
This calibration certificate shall not be reproduced except in full without written approval of the laboratory.			



Add: No.51 Xueyuan Road, Haidian District, Beijing, 100191, China  
Tel: +86-10-62304633-2079 Fax: +86-10-62304633-2504  
E-mail: cttl@chinattl.com Http://www.chinattl.cn

**Glossary:**

DAE data acquisition electronics  
Connector angle information used in DASY system to align probe sensor X to the robot coordinate system.

**Methods Applied and Interpretation of Parameters:**

- *DC Voltage Measurement:* Calibration Factor assessed for use in DASY system by comparison with a calibrated instrument traceable to national standards. The figure given corresponds to the full scale range of the voltmeter in the respective range.
- *Connector angle:* The angle of the connector is assessed measuring the angle mechanically by a tool inserted. Uncertainty is not required.
- The report provide only calibration results for DAE, it does not contain other performance test results.



Add: No.51 Xueyuan Road, Haidian District, Beijing, 100191, China  
 Tel: +86-10-62304633-2079 Fax: +86-10-62304633-2504  
 E-mail: cttl@chinattl.com Http://www.chinattl.cn

**DC Voltage Measurement**

A/D - Converter Resolution nominal  
 High Range: 1LSB = 6.1μV , full range = -100...+300 mV  
 Low Range: 1LSB = 61nV , full range = -1.....+3mV  
 DASY measurement parameters: Auto Zero Time: 3 sec; Measuring time: 3 sec

Calibration Factors	X	Y	Z
High Range	404.549 ± 0.15% (k=2)	404.414 ± 0.15% (k=2)	404.175 ± 0.15% (k=2)
Low Range	3.96723 ± 0.7% (k=2)	3.93603 ± 0.7% (k=2)	3.97491 ± 0.7% (k=2)

**Connector Angle**

Connector Angle to be used in DASY system	290.5° ± 1 °
---	--------------