

PA600 Phone Edition

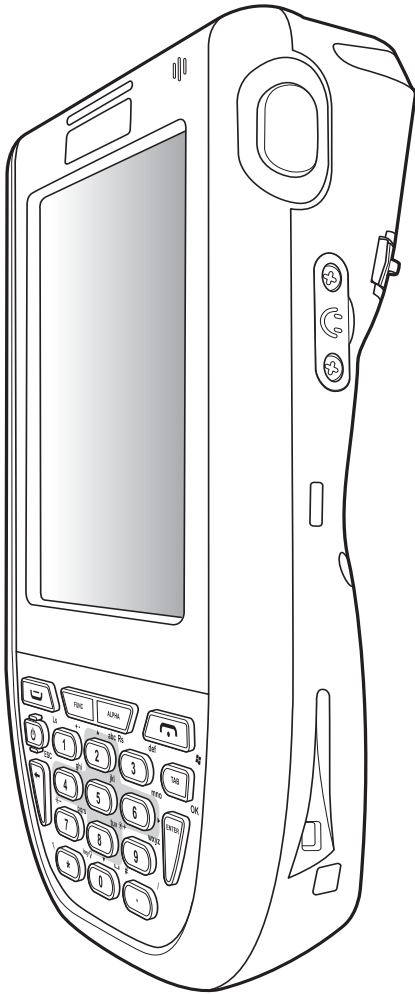

User's Manual



About This Manual

This manual explains how to install, operate and maintain the PA600 II Rugged Mobile Computer.

No part of this publication may be reproduced or used in any form, or by any electrical or mechanical means, without permission in writing from the manufacturer. This includes electronic or mechanical means, such as photocopying, recording, or information storage and retrieval systems. The material in this manual is subject to change without notice.

© Copyright 2008 unitech Electronics Co., Ltd. All rights reserved.

unitech global website address: <http://www.unitech-adc.com>

Bluetooth is a registered trademark of Bluetooth SIG.



Microsoft, Windows and ActiveSync are either registered trademarks or trademarks of Microsoft Corporation. Other product names mentioned in this manual may be trademarks or registered trademarks of their respective companies and are hereby acknowledged.



unitech is a member of Oracle Embedded Software Licensing Program.



Regulatory Compliance Statements

FCC Warning Statement

This equipment has been tested and found to comply with the limits for a Class B digital device, pursuant to part 15 of the FCC rules. These limits are designed to provide reasonable protection against harmful interference in a residential installation. This equipment generates, uses and can radiate radio frequency energy and, if not installed and used in accordance with the instructions, may cause harmful interference to radio communications. However, there is no guarantee that interference will not occur in a particular installation. If this equipment does cause harmful interference to radio or television reception, which can be determined by turning the equipment off and on, the user is encouraged to try to correct the interference by one or more of the following measures:

- Reorient or relocate the receiving antenna.
- Increase the separation between the equipment and receiver.

- Connect the equipment into an outlet on a circuit different from that to which the receiver is connected.
 - Consult the dealer or an experienced radio/TV technician for help.
1. This equipment complies with FCC RF radiation exposure limits set forth for an uncontrolled environment.
 2. Any changes or modifications (including the antennas) made to this device that are not expressly approved by the manufacturer may void the user's authority to operate the equipment.

FCC Label Statement

This device complies with part 15 of the FCC rules. Operation is subject to the following two conditions:

1. This device may not cause harmful interference, and
2. This device must accept any interference received, including interference that may cause undesired operation.

Canadian Compliance Statement

This Class B Digital apparatus meets all requirements of the Canadian Interference-Causing Equipment Regulations.

Cet appareil numérique de la classe B respecte les exigences du Règlement sur le matériel brouilleur du Canada.

European Conformity Statement

Declaration of Conformity with Regard to the R&TTE 1999/5/EC and EMC 89/336/EEC directives.

Taiwan NCC Warning Statement

國家通訊傳播委員會 (NCC) 低功率電波輻射性電機管理辦法 (930322)

根據 NCC 低功率管理辦法 規定：

第十二條 經型式認證合格之低功率射頻電機，非經許可，公司、商號或使用者均不得擅自變更頻率、加大功率或變更原設計之特性及功能。

第十四條 低功率射頻電機之使用不得影響飛航安全及干擾合法通信；經發現有干擾現象時，應立即停用，並改善至無干擾時方得繼續使用。前項合法通信，指依電信法規定作業之無線電通信。低功率射頻電機須忍受合法通信或工業、科學及醫療用電波輻射性電機設備之干擾。

為減少電磁波影響，請妥適使用!

Laser Information

The unitech PA600 II series is certified in the U.S. to conform to the requirements of DHHS/CDRH 21CFR Subchapter J and to the requirements of IEC 825-1. Class II and Class 2 products are not considered to be hazardous. The PA600 II series contains internally a Visible Laser Diode (VLD) whose emissions do not exceed the maximum limits as set forth in the above regulations. The scanner is designed so that there is no human access to harmful laser light during normal operation, user maintenance or during prescribed service operations.

The laser safety warning label required by the DHHS/IEC for the PA600 II series's optional laser scanner module is located on the memory compartment cover, on the back of the unit.

CAUTION! Use of controls or adjustments or performance of procedures other than those specified herein may result in hazardous laser light. Use of optical instruments with the scanner will increase eye hazard. Optical instruments include binoculars, microscopes, and magnifying glasses. This does not include eye glasses worn by the user.

Battery Notices

This unit is equipped with a battery pack and backup battery. Both batteries will discharge after an extended period of not being used.

When both batteries are discharged, recharge the unit for 16 hours in order to fully charge the main battery and backup battery. There are two ways to recharge PA600 II:

1. Plug the USB charging cable to the PA600 II and plug the 5V/3A AC-DC adapter to the power jack of the USB charging cable.
2. Place the PA600 II into the docking station and plug the 5V/3A AC-DC adapter to the power jack of the docking station.

For more details, refer to page 8, Charging the Battery.

If the main battery is removed, the backup battery ensures the data on SDRAM is safe for up to 2 hours. To prevent data loss, do not leave the PA600 II uncharged with the main battery removed for an extended period.

Battery charge notice

It is important to consider the environment temperature whenever you are charging the Lithium-Ion battery pack. The process is most efficient at normal room temperature or slightly cooler. It is essential that you charge batteries within the stated range of 10°C to 45°C. Charging batteries outside of the specified range could damage the batteries and shorten their charging life cycle.

Storage and safety notice

Although charged Lithium-Ion batteries may be left unused for several months, their capacity may be depleted due to build up of internal resistance. If this happens they will require recharging prior to use. Lithium-Ion batteries may be stored at temperatures between -20°C to 60°C , however they may be depleted more rapidly at the high end of this range. It is recommended to store batteries within normal room temperature.

Table of Contents

Preface

About This Manual	i
Regulatory Compliance Statements	i
FCC Warning Statement	i
FCC Label Statement	ii
Canadian Compliance Statement	ii
European Conformity Statement	ii
Laser Information	iii
Battery Notices	iii
Battery charge notice	iii
Storage and safety notice	iv

Chapter 1

Getting Started	1
Introducing the PA600 II	1
Features	2
Package Contents	3
A Tour of the PA600 II	3
Front Left View	4
Back View	5
Getting Started	6
Installing the Battery	6
Charging the Battery	8
<i>Charging the Battery using the USB Cable</i>	8
<i>Charging the Battery with the Docking Station</i>	9
<i>Checking the Battery Status</i>	9
Connecting the PA600 II to a PC	10
Turning the PA600 II on for the First Time	11
<i>Powering On</i>	11
<i>Calibrating the PA600 II Screen</i>	12

Chapter 2

Using the Hardware	14
Keypads and Function Buttons	14
Adjusting the Screen Brightness	16
Using the Stylus	16
Using the SD/MMC memory card	17
<i>Inserting a Storage Card</i>	17
<i>Removing a Storage Card</i>	17
Using the Laser Scanner	18
Using the SIM Card	19
<i>Inserting the SIM Card</i>	19

Using the Phone	20
Making a Call Using the Phone Keypad	21
Using the Contact List.....	21
Using the Speed Dial.....	22
Customizing the Phone Settings.....	22
Chapter 3	
Getting Connected	23
Establishing Device-PC Connection	23
Installing Microsoft ActiveSync	23
Connecting the Device to Your Computer	26
Synchronizing with Your Computer	27
Connection options	27
<i>USB Connection</i>	27
<i>Bluetooth Connection</i>	27
<i>GPRS Connection</i>	30
<i>WiFi Connection</i>	31
Synchronizing Information	35
Synchronization Options.....	35
Using ActiveSync to Exchange Files	35
Chapter 4	
Barcode Scanner Programs	37
Scanner Setting	37
Scan2Key	37
Barcode Symbolologies.....	38
Chapter 5	
Advanced Settings	39
Adjusting Settings	39
Checking the Main and Backup Battery Status	40
Extending Battery Life	41
Changing the Automatic Power Settings	41
Adjusting Backlight Setting	42
Viewing Flash Memory Files	43
Performing a hardware reset	44
Performing a Warm Boot	44
Performing a Cold Boot	45
Performing a Clean Boot	46
Appendix	
System Specifications	47

Getting Started

Introducing the PA600 II

Thank you for purchasing the PA600 II Rugged Mobile Computer. Your PA600 II was designed for users who need a compact and durable PDA for data collection and real time transactions.

The PA600 II is a rugged, compact and lightweight palm-size computer using the Windows Mobile 5.0 operating system, and incorporating an integral bar code scanning laser device, cell phone function, color LCD with touchscreen, keypad, and wireless communication capability. It provides users with a standard Windows-based environment for customizing and operating the device.

To reduce TCO, the PA600 II is sealed to meet IP64 standards and has undergone multiple drop tests to prevent downtime.

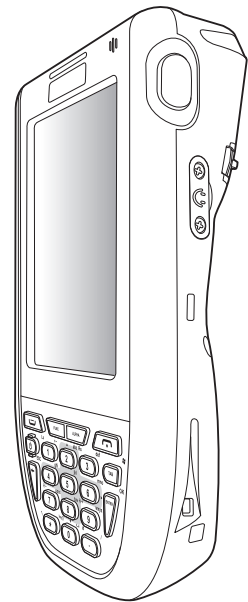

Features

Powerful system

- Microsoft Windows Mobile™ 5.0 operating system
- Intel PXA270 processor with speed of up to 624 MHz

System memory

- 128 MB SDRAM
- 320 MB Flash ROM

Display

- 3.5-inch QVGA TFT-LCD with touch screen and backlight
- 240 x 320 resolution

Barcode scanner

- Built-in laser scan engine
- Built-in vibrator for scanning indication
- Symbol SE950 support
- Unitech Hamster barcode decoder

Communication

- USB Host & Client
- Bluetooth 2.0 + EDR (supports Bluetooth Printer, Bluetooth Modem, Bluetooth ActiveSync)
- eGPRS Siemens MC75 Radio Module, quad-band GSM 850/900/1800/1900 MHz
 - EDGE Multislot Class 10
 - GPRS Multislot Class 12
 - GSM Release 99

Audio

- MIC
- Speaker
- Headset Connector
- Receiver

Wireless connectivity

- 802.11b/g with diversity antenna
- Bluetooth wireless technology

Expansion slot

- Secure Digital (SD) card slot (supports SDHC up to 4G)

Battery life



- Operation time: typical 5 hours (with Wifi), average 9 hours (w/o Wifi)
- Charging time: under 5 hours
- Embedded backup battery cell

User-friendly interface

- Quick launch hot keys for enabling backlight, calibration, phone calls, software keyboard, and other device management tasks
- Trigger keys for barcode scanning

Package Contents

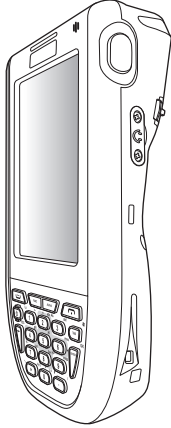
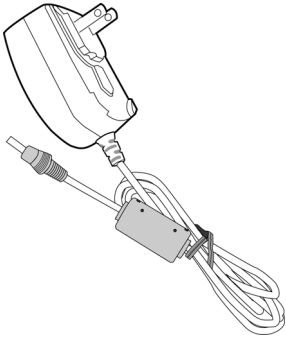
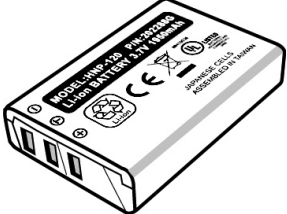
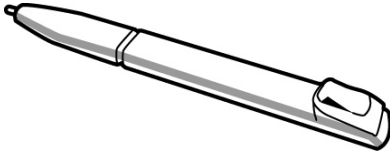
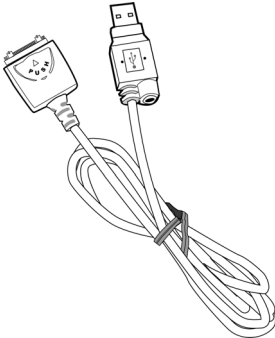
After opening the box, ensure the following accessories for the PA600 II are present:

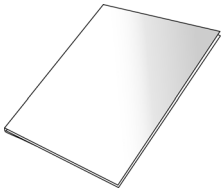
		
<p>PA600 II Terminal</p>	<p>AC Adapter with universal plugs</p>	
		
<p>Battery Pack</p>	<p>Stylus</p>	
		
<p>USB Charging Cables</p>	<p>CD-ROM</p>	<p>Quick Reference Guide</p>

If anything is missing or appear damaged in any way, contact your dealer.

A Tour of the PA600 II

The following sections describe the main components and features of the PA600 II.

Front Left View

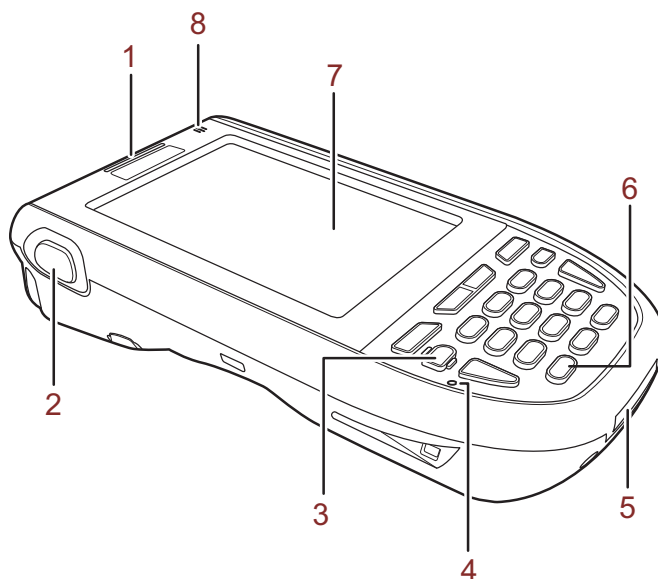

No.	Component	Description
1.	Status indicator	Indicates the battery charging and barcode scanning status. Green - Battery is fully charged, or barcode scanning process is completed without error. Red - Battery is charging, barcode scanner is fired/ activated. Yellow - GPRS is on Blue - Bluetooth is on
2.	Left scanner trigger button	Press to activate the barcode laser scanner.
3.	Power button	If the device is off, press this button to turn it on. Alternatively, when the unit is on, this key must be pressed and held down for about three seconds in order to turn the device off.
4.	Microphone	Enables you to record voice audio.
5.	Universal connector	Connects your device to a USB charging/ communication cable. This USB cable connects to the computer's USB port and accepts the 5V AC adapter to provide power to the PA600 II. This unit can simultaneously recharge and perform an ActiveSync operation. You can also use it to connect peripheral hardware, such as a docking station, to your device. This port can also support USB and RS232 hosting for devices such as a USB or RS232 scanner, keyboard, or USB memory key.
6.	Keypad	Keypad interface for controlling the PA600 II. See <i>Keypads and Function Buttons</i> on page 14 for more information.
7.	LCD touch screen	Displays the applications and data stored on your device. It is touch-sensitive and responds to the stylus or finger.
8.	Speaker	Enables you to hear audio from the PA600 II.

Back View

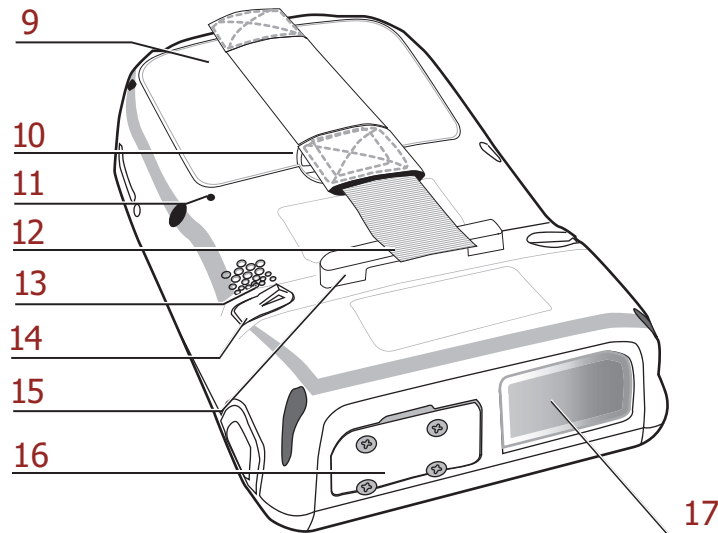

No.	Component	Description
9.	Battery compartment	Houses the removable and rechargeable 3.7 V, 2200 mAH battery pack
10.	Battery compartment release latch	Opens the battery compartment.
11.	Reset button	Press the end of the stylus into the button to reset your device.
12.	Handstrap	Enables you to securely hold the PA600 II while using it.
13.	Speaker	Enables you to hear audio from the PA600 II.
14.	Stylus	Enables you to interact with the operating system. To use the stylus, remove it from its holder and hold it the same way as you hold a pen or pencil.
15.	Strap holder	Attachment location for holding hand strap, carrying strap, and stylus.
16.	Memory card slot	Accommodates Secure Digital (SD) memory cards and can serve as an SDIO port.
17.	Barcode scanner window	Scan barcodes window where the laser pass through.

Getting Started

This section explains how to install and charge the battery, how to check battery status, how to turn on the PA600 II, and how to calibrate the screen.

Installing the Battery

WARNING! There is a risk of fire and burns if the battery pack is handled improperly. DO NOT disassemble, crush, puncture, short external contacts, or dispose the battery pack in fire or water. DO NOT attempt to open or service the battery pack. Dispose of used batteries according to local recycling guidelines in your area.

A backup battery cell is embedded into your device to prevent data loss in instances when the removable battery pack is removed or completely discharged. This backup battery cell will keep the data and system setting for up to 6 hours if the main battery is removed.

NOTE: To enable the internal battery cell to provide backup power supply, charge your device with the main battery pack for at least 16 hours.

1. Open the battery compartment by pushing the latch in the direction of the arrow and lifting up.

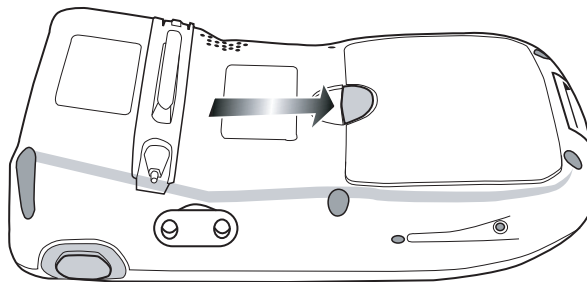

The battery compartment is displayed:

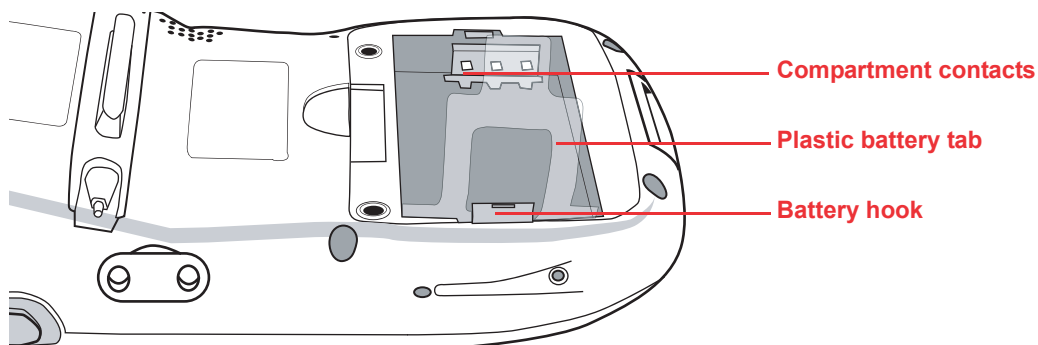

NOTE: The plastic battery tab makes it easy to remove the battery.

2. Locate the backup battery switch and turn it on.

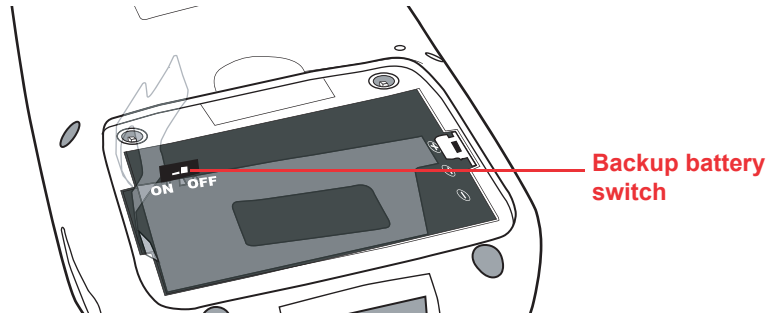

3. Position the battery pack, making sure the battery contacts are aligned with the contacts in the compartment and the battery is placed on top of the plastic tab, as shown in the following illustration.

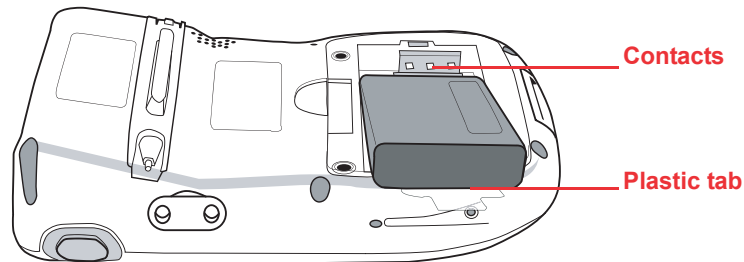

4. Slide the battery pack into the battery bay while simultaneously pulling the battery hook until the battery clicks into place.

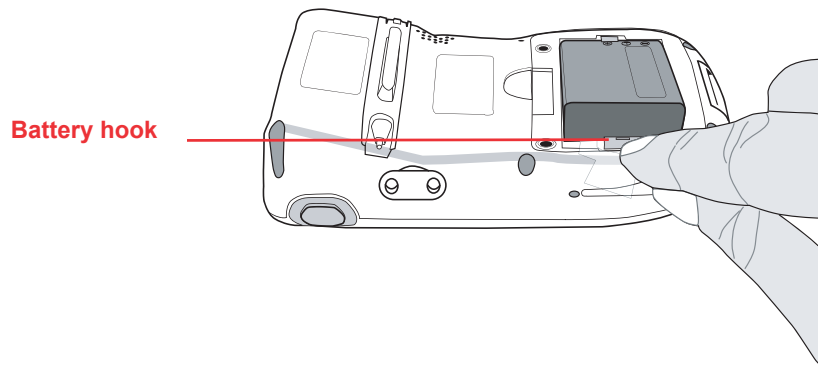

5. Replace the battery compartment cover.

Charging the Battery

Before using the PA600 II for the first time, you need to charge it for about 16 hours. After that, you can charge the PA600 II 4 hours to recharge the battery to full capacity. Charge the PA600 II using the USB charging cable or the docking station.

CAUTION! Operating the PA600 II for the first time without the AC adapter, and without fully charging the backup battery may result in loss of data stored in RAM memory. When the main battery is removed, the backup battery retains RAM data in memory for 2 hours, please charge the battery for the period to avoid the data loss in RAM memory.

NOTE: Turn the backup battery switch on before charging the battery. Data you entered may not be properly stored until the built-in backup battery has been adequately charged.

Charging the Battery using the USB Cable

1. Press and hold the connector button on the USB charging cable and connect it to the PA600 II (1).
2. Plug the AC adapter cable into the power jack on the USB charging cable (2).
3. Connect the AC adapter into an electrical outlet (3).

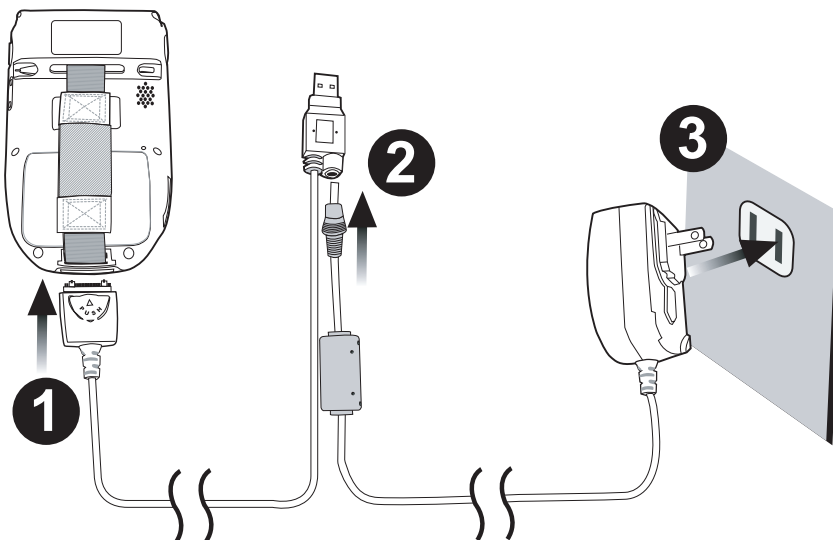

Charging the Battery with the Docking Station

1. Plug the AC adapter cable into the power jack on the docking station, then connect the AC adapter into an electrical outlet.

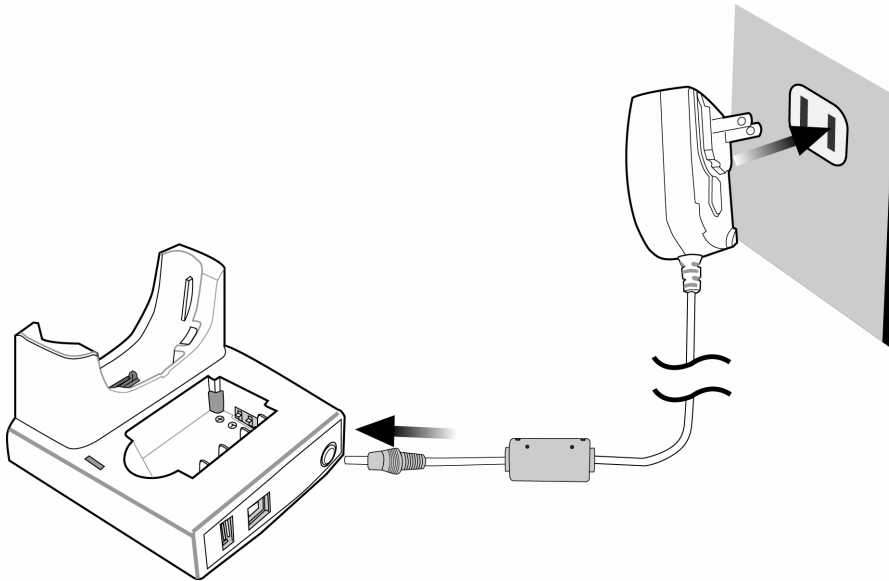

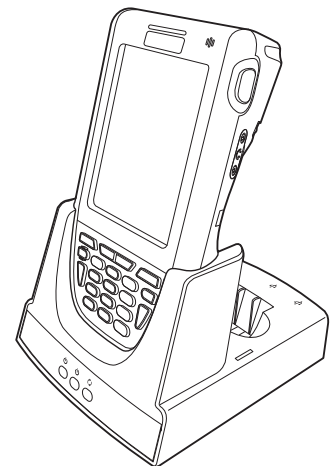

2. Slide the device into the docking station until it clicks into place.



3. The connection is secure when the bottom edge of the device is aligned with the docking station, and the LED indicator on the device lights up red.

LED Status

	LED	Meaning
PA600 II	Solid Red	Charging
	Solid Green	Charging complete
Docking Station	 Power LED	Power is on
	 Charging LED:	Charging (For spare battery only)
	 Sync LED	Synchronization is taking place

Checking the Battery Status

If the battery level becomes low in the course of normal use, a status icon appears on the device screen indicating low or very low battery status. In both cases, perform an Active-Sync operation to back up your data, then recharge your device as soon as possible.

If the battery level reaches low status, the device will enter a sleep mode and cannot be powered up until the battery is charged. Windows Mobile 5.0 devices will retain installed applications and data when the main battery is completely drained for extended periods of time.

Connecting the PA600 II to a PC

Use the USB cable to connect the PA600 II to a PC, in order to use with ActiveSync.

1. Press and hold the connector button on the USB charging cable and connect it to the PA600 II (1).
2. Plug the USB connector into the USB port on the PC and connect the AC adapter into the USB connector (2).
3. Connect the AC adapter into an electrical outlet (3).

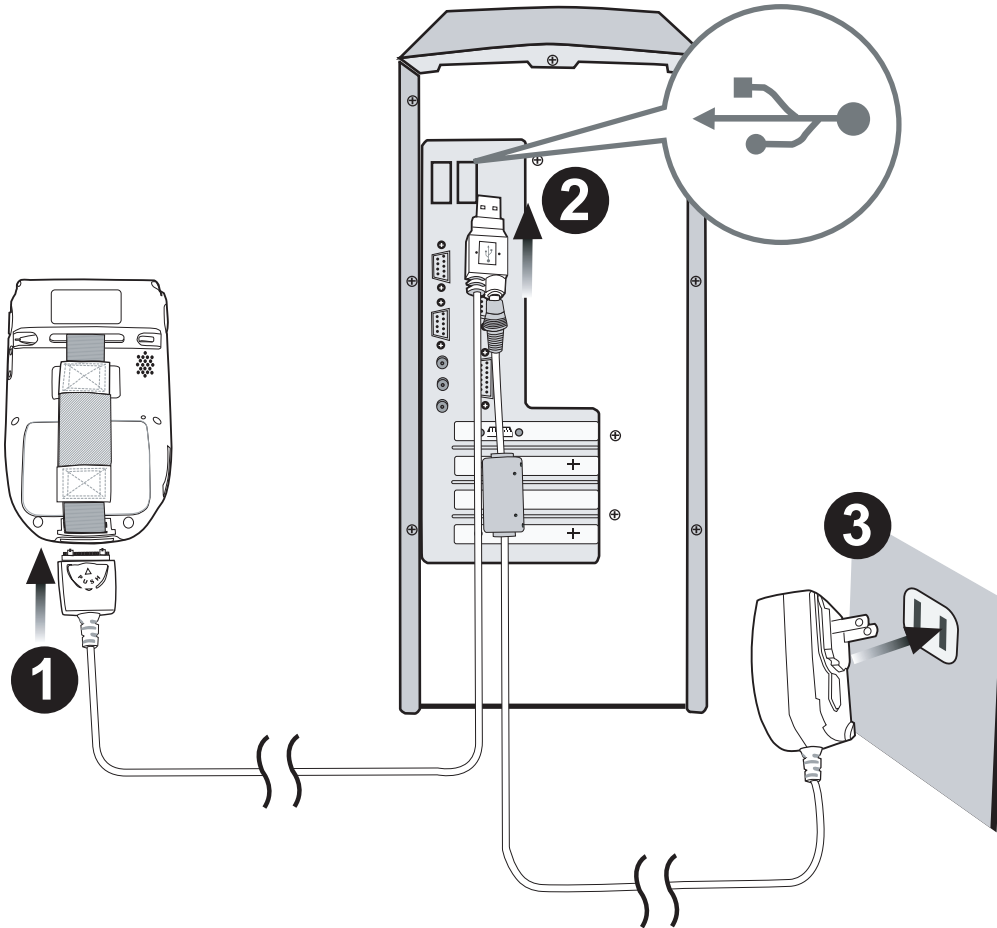

Turning the PA600 II on for the First Time

After you have initially charged your device for about 16 hours, the device is ready to be used. You can now start up your device where you'll calibrate the display, learn some basic stylus usage, and set up the system time zone, date and time.

Powering On

1. Turn on your device by pressing the power button on the front panel.

NOTE: The PA600 II screen ships with a protective plastic film. You may remove this if desired by peeling from one corner. The screen will be more susceptible to scratching without the film, but will be more readable.

2. The unitech PA600 II welcome screen appears for a moment followed by the Windows Mobile screen.

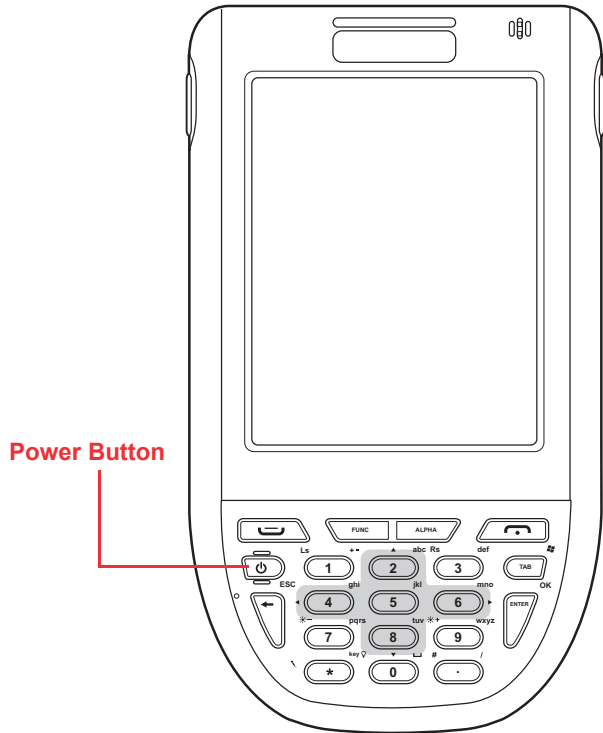

Calibrating the PA600 II Screen

The calibrate screen automatically appears when the unit is powered-on for the first time or after the system is reset.

To calibrate the screen at any time, follow these instructions.

1. Tap **Start** → **Settings**, and then switch to **System** tab.
2. Tap the **Screen** icon.

Or

Press Func key and ESC key simultaneously.



The Screen Settings window appears.

This Window enables you to customize the screen settings.

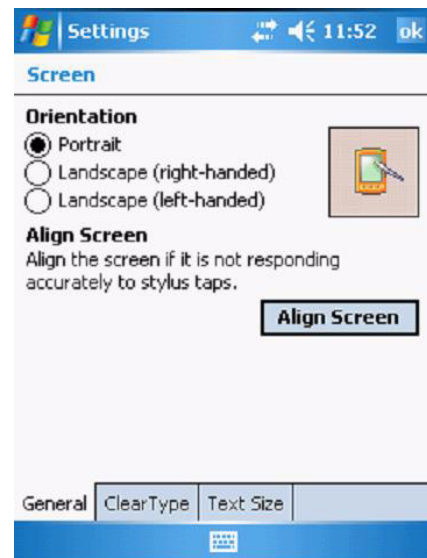

3. Tap **Align Screen** to calibrate the screen.
The align screen window appears.
4. Tap the cross hair firmly and accurately.

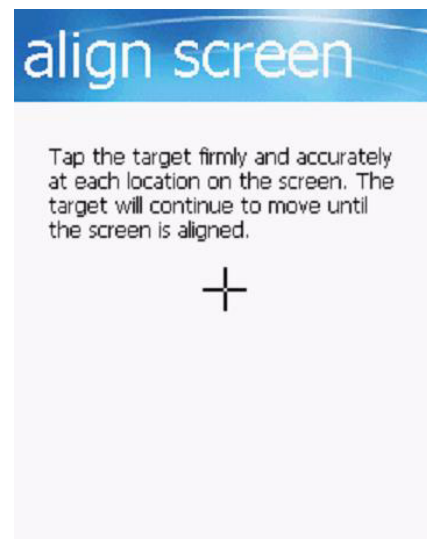

The cross hair moves to the next location.

5. Continue tapping the cross hairs until the screen has been calibrated.

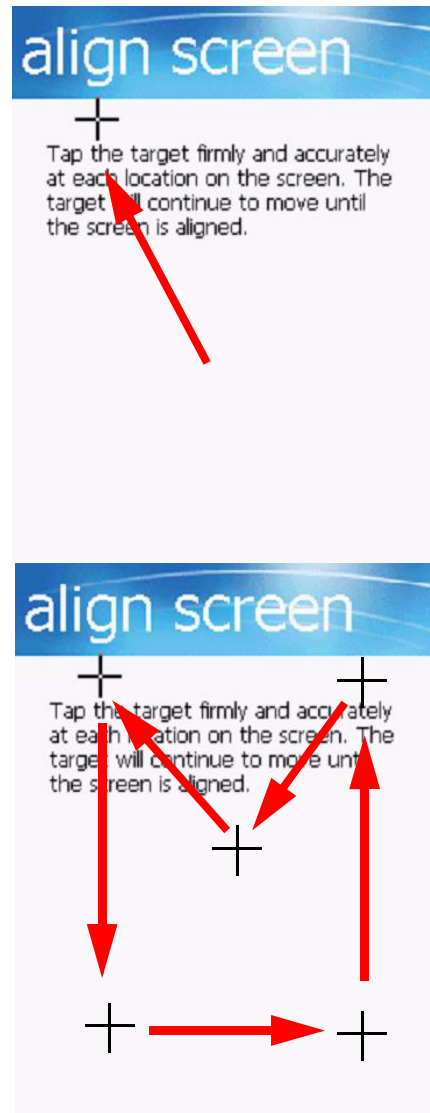

Using the Hardware



Keypads and Function Buttons



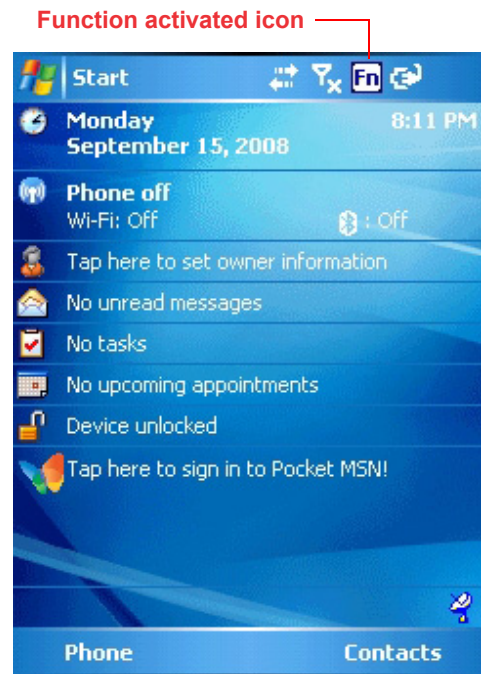



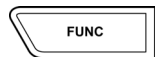
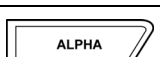
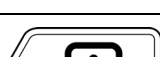

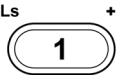
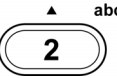
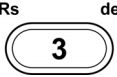

The keypad enables you to both enter information and interact with the PDA operating system and also operate secondary functions using the function button. When the green function button is pressed, the green icon functions on the keypad become available.

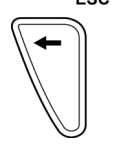
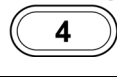
When the Function button  is pressed, an icon appears in the operating system:

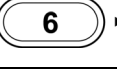

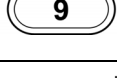
The following table describes the keypad keys.

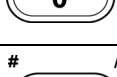
Key	Main Function	Secondary Function
	Talk/Send	Opens Phone screen to make a call or send a message
	—	Enables/ disables secondary function keys
	Alpha	—
	End	Exits Phone screen or ends a call
	Turns the PA600 II on and off.	—

Key	Main Function	Secondary Function
	Number 1	Left soft key - activates function above in LCD screen.
	Alphanumeric 2, a, b, c	Up navigation key
	Alphanumeric 3, d, e, f	Right soft key - activates function above in LCD screen.
	Tab	Windows key opens Start menu
	Back space	Escape key
	Alphanumeric 4, g, h, i	Left navigation key
	Alphanumeric 5, j, k, l	—
	Alphanumeric 6, m, n, o	Right navigation key
	Alphanumeric 7, p, q, r, s	Decreases screen brightness
	Alphanumeric 8, t, u, v	Down navigation key
	Alphanumeric 9, w, x, y, z	Increases screen brightness
	Asterisk	Illuminates keypad
	Number 0, space	—
	Period	Pound
	Enter key	OK

Adjusting the Screen Brightness

Adjust the screen brightness by pressing the Function button to enable the soft keys and pressing the 7 (decrease brightness) or 9 (increase brightness) buttons.

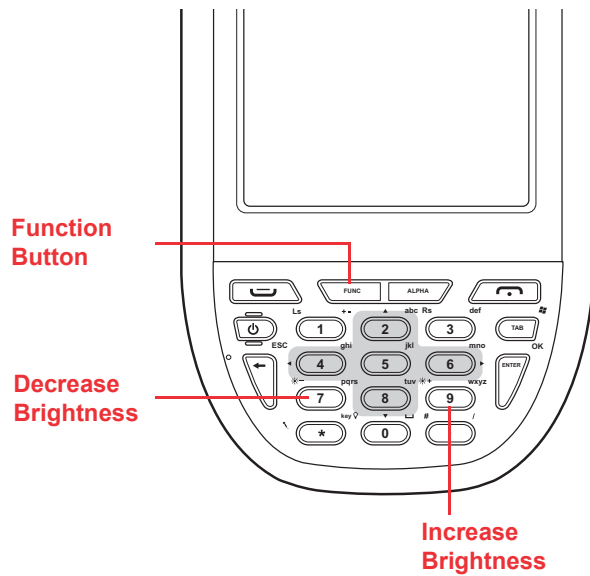

Using the Stylus

CAUTION! Never use anything other than the PA600 II stylus on the screen. Otherwise this could cause a permanent damage.

1. Remove the stylus from its holder.

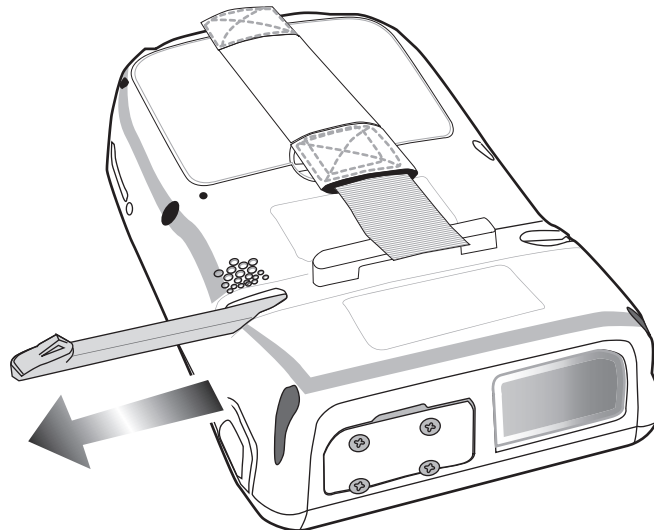

2. Hold the stylus as you hold a pencil.
3. To make a choice from a menu, lightly tap the tip of the stylus on that choice.
4. To write data into a field on a form, use the stylus to print the letters or numbers. Use very light pressure.

Using the SD/MMC memory card

Your device has an expansion slot compatible with a range of SD and MMC storage cards, which are primarily used to back up or transfer files and data. The slot also supports SDIO cards for added connectivity options.

Inserting a Storage Card

1. Remove the four screws from the SD compartment cover and remove the cover.

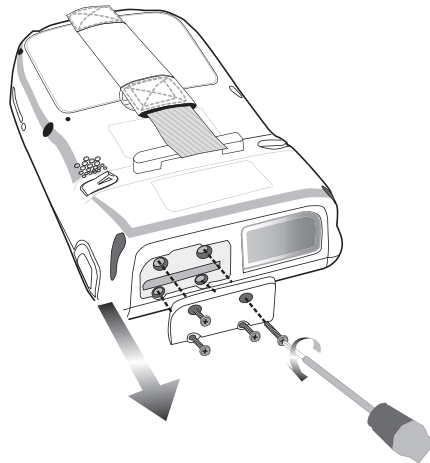

2. Insert the SD card with the notched corner as shown by the icon on the case.

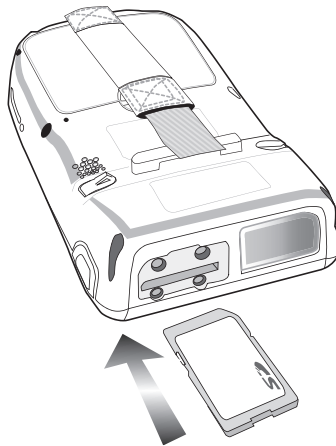

3. Replace the SD compartment cover and the four compartment screws.

Removing a Storage Card

1. Remove the four screws from the SD compartment cover and remove the cover.
2. Press the card in and release.
The card pops out.
3. Remove the card from the slot.

Using the Laser Scanner

The PA600 II has an integrated laser scanner which reads all major bar code labels with excellent performance.

NOTE: Scanning software must be enabled in order to operate the scanner. This can be a user-loaded application or a pre-loaded utility such as Scanner Setting and Scan2Key.

Activate the laser scanner by pressing either one of the trigger keys located on the left and right side of the unit.

The PA600 II has a built-in Scanner Setting utility that allows you to test the device's barcode scan function.

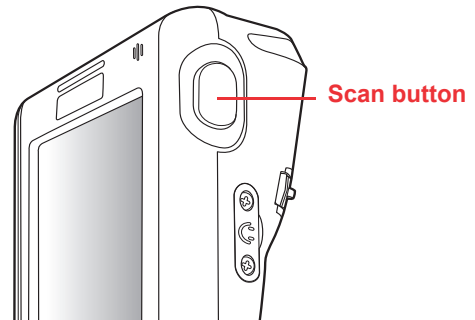

1. To launch Scanner Settings, tap **Start** → **Settings**, and then switch to **System** tab. Tap the **Scanner** icon.



2. The Scanner Control Panel opens.



From here you can configure barcode scanner parameters such as enabling or disabling barcode symbologies, setting data transmission options, configuring magnetic and proximity reading options, and setting power management options.

3. To test the barcode scanner, tap the **Test** tab.
4. Tap **Tools**
5. Tap **Enable Scan**
6. To perform auto scan, Tap **Tools** → **Auto Scan** → Start **Auto- Scan**
7. Choose Interval: 3 secs
8. Tap: **Start**
9. Laser scans every 3 seconds and barcode is scanned automatically.
10. Tap **Tools** → **Auto-Scan** → **Stop Auto-Scan**.

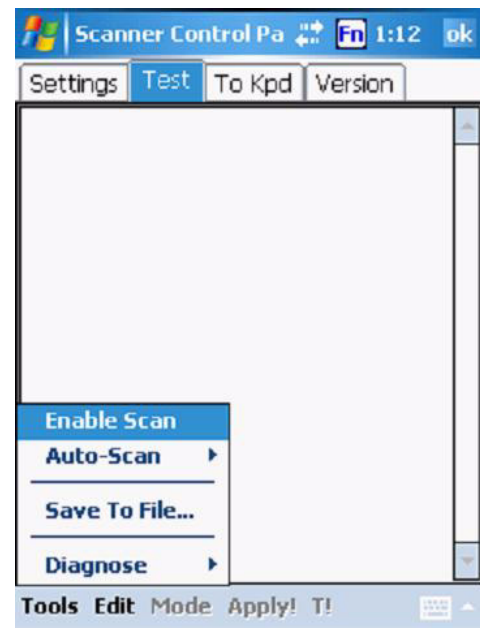

Using the SIM Card

The PA600 II has a slot for GPRS SIM card. It is placed inside the battery compartment.

Inserting the SIM Card

1. Take out the battery cover and the main battery. Insert the SIM card with the notched corner as shown in the picture below.

NOTE: The chip of the SIM card should face upwards.

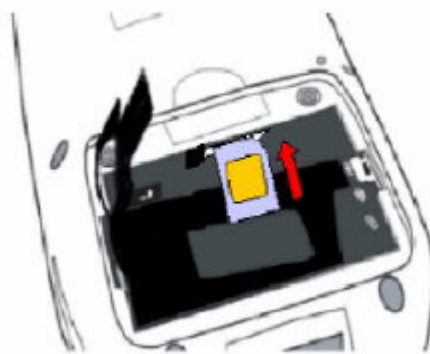

2. Push the SIM card to the end until you hear a click. Push the lock to the right to lock the card by stylus.

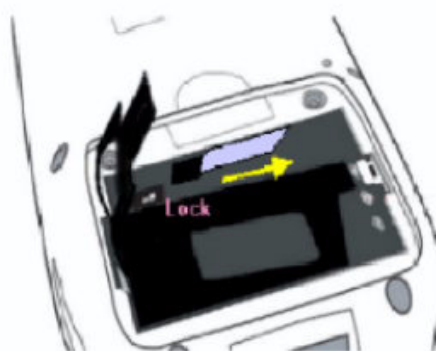

Using the Phone

The PA600 II has an integrated phone keypad, which allows you to make, receive, and send messages via the built-in module.

NOTE: Make sure you insert the SIM card properly.

To open the Phone screen, do one of the following.

1. Tap Phone on the bottom left corner of the screen.
2. Press Talk/Send button.
Press End button when you want to exit the Phone screen.

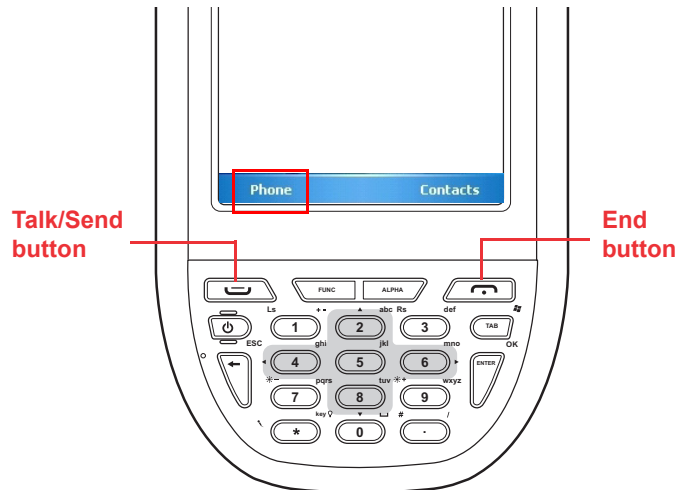

The Phone screen opens. From here you can manage the contact list, create speed dials, messages, notes, and customize phone settings.

NOTE: If your SIM card is protected by a PIN code, input the password before you can use the phone.

Tap the antenna signal icon on the upper right corner of the screen. Tap Wireless Manager and turn on phone function.

Antenna signal icon

Signal	Description
	Phone service searching
	No signal is available.
	Strongest signal strength More bars you have, the stronger signal you have.
	No phone service provided.
	Phone function is turned off. Tap the antenna signal icon and turn on phone function in the Wireless Manager.

Tap the speaker icon on the upper right corner of the screen. You can adjust the device/ phone volume by moving the sliders and change the ring volume by tapping On, Vibrate, or Off.



Making a Call Using the Phone Keypad

1. Tap Phone or press Talk/Send button.
2. Enter the desired phone numbers.
3. Tap the Talk button on the Phone screen.
4. When the call connects, you can tap Hold to place the first number on hold.
5. Enter the second phone numbers and tap Talk again.
6. Tap Swap to switch between calls.
7. Tap End or press End button to stop dialing or end the call.

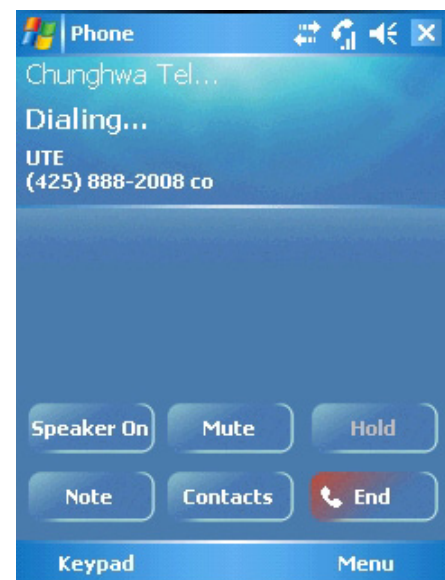

Using the Contact List

1. Tap Contacts on the bottom left corner of the Phone screen.
2. Tap New on the bottom left corner of the contact list, you can add a new contact.
3. Tap a contact, you can edit the contact info.
4. Tap and hold on a contact, a menu appears. You can send e-mail/ text message to the contact, add this contact to speed dial list, and so on.

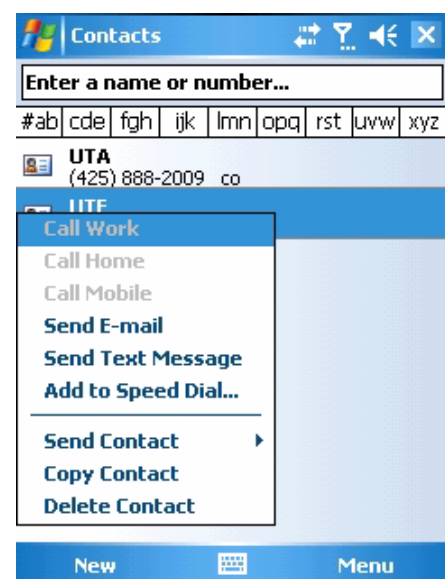

Using the Speed Dial

1. Tap Speed Dial on the Phone keypad.
2. Tap Menu, and select New.
3. Select a contact in your contact list by tapping the desired contact.

4. Assign an available location for the new speed dial entry. Tap OK, and then OK to exit the speed dial list.

NOTE: The first speed dial location is reserved for voice mail.

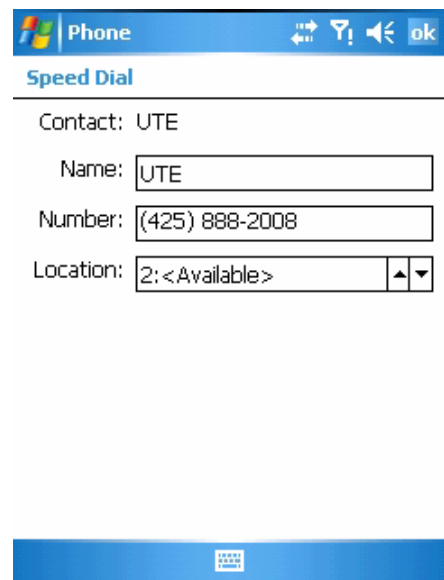
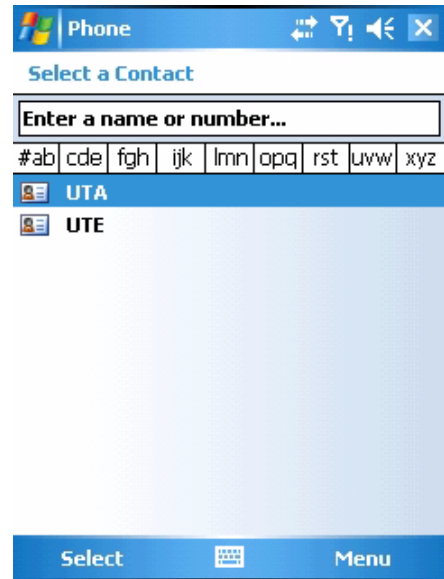

To make speed dial call, do one of the following.

1. Tap and hold the speed dial location number assigned to a contact on the Phone keypad.
2. Tap Speed Dial on the Phone keypad, and tap the location number of the desired speed dial entry.

Location number

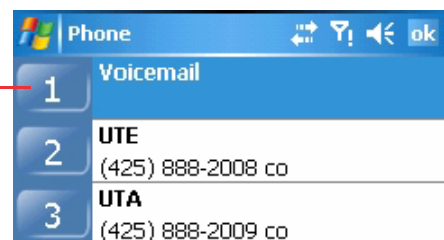

Customizing the Phone Settings

Tap Menu, and select Options, you can change the default phone settings, including ring sound, keypad sound, call barring, call forwarding, call waiting, mobile phone network, etc.

Getting Connected

Establishing Device-PC Connection

Installing Microsoft ActiveSync

In order to exchange data between your computer and PA600 II, Microsoft ActiveSync must be installed on your computer. Use the USB charging cable that comes with your device to connect the device to your computer.

NOTE: If you have a previous version of the Microsoft ActiveSync installed in your computer, uninstall it first before installing the latest version of Microsoft ActiveSync.

To install Microsoft ActiveSync on your computer:

1. Close any open programs, including those that run at startup, and disable any virus-scanning software.
2. Download the ActiveSync software from the Microsoft ActiveSync Download page at <http://www.microsoft.com/windowsmobile/downloads/activesync42.msp>.
3. Browse the location of the downloaded file, and double-click it.

The installation wizard begins.

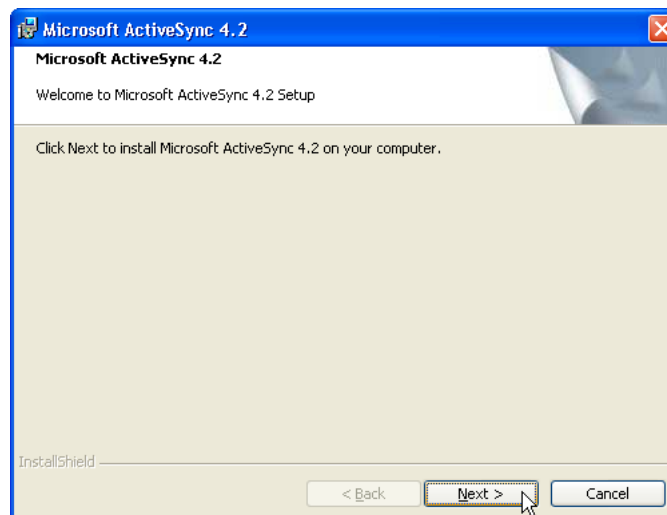

Chapter 3 Getting Connected

4. Click **Next**.

You are prompted to read the End User License Agreement (EULA).



5. Accept the license agreement terms and click **Next**.

You are prompted for user information.

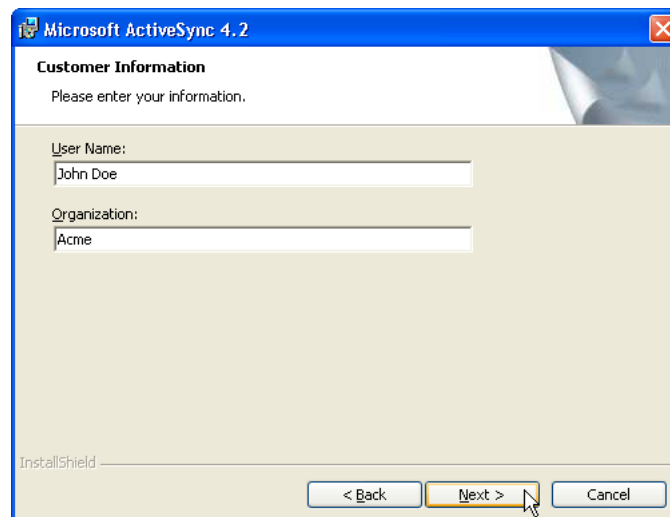

6. Type the user name and organization and click **Next**.

You are prompted for the destination folder.

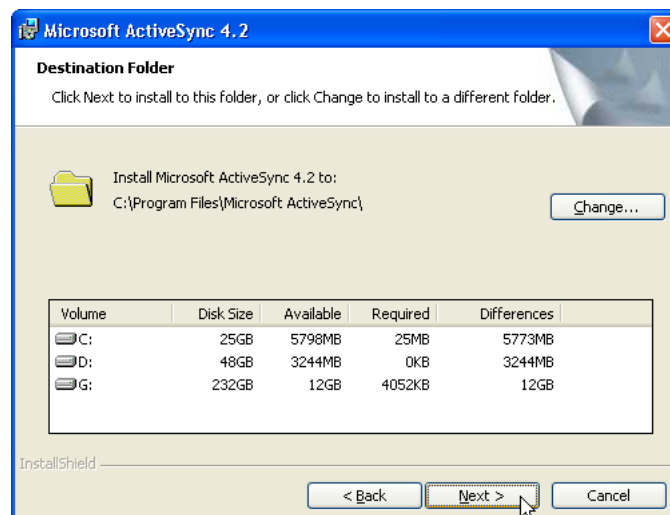

7. Select a drive to install the program and click **Next**.

The installation wizard has gathered the information it needs to install ActiveSync and prompts you to begin the installation.

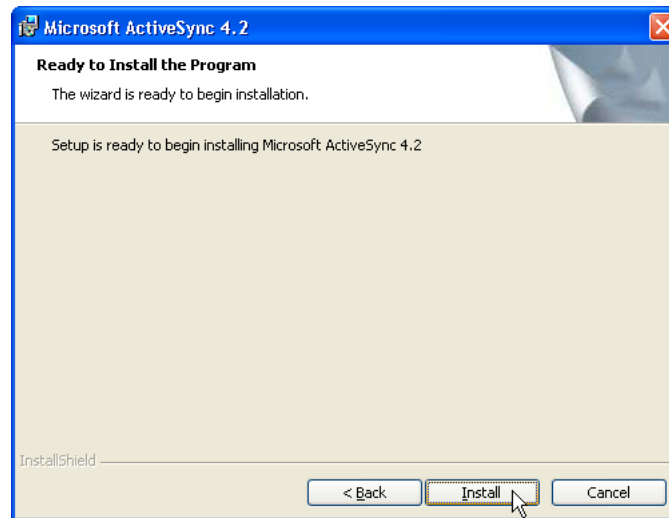

8. Click **Install**.

The program begin the installation

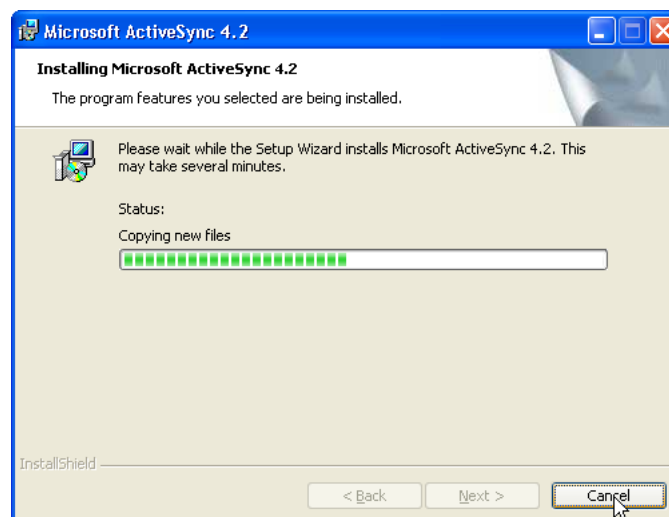

After the program has finished installing you see the following screen.

