

Multi-functional T&A Terminal

- MT700 -



User's Manual

Version 1.0

About This Manual

This manual explains how to install, operate and maintain the MT700 Multi-Function Versatile Controller.

No part of this publication may be reproduced or used in any form, or by any electrical or mechanical means, without permission in writing from the manufacturer, which includes photocopying, recording, or information storage and retrieval systems. The material in this manual is subject to change without notice.

© Copyright 2013 unitech Electronics Co., Ltd. All rights reserved.

Unitech global website address: <http://www.unitech-adc.com>



Microsoft, Windows and ActiveSync are either registered trademarks or trademarks of Microsoft Corporation. Other product names mentioned in this manual may be trademarks or registered trademarks of their respective companies and are hereby acknowledged.

Regulatory Compliance Statements

FCC Warning Statement

This equipment has been tested and found to comply with the limits for a Class B digital device, pursuant to part 15 of the FCC rules. These limits are designed to provide reasonable protection against harmful interference in a residential installation.

This equipment generates, uses and can radiate radio frequency energy and, if not installed and used in accordance with the instructions, may cause harmful interference to radio communications. However, there is no guarantee that interference will not occur in a particular installation. If this equipment does cause harmful interference to radio or television reception, which can be determined by turning the equipment off and on, the user is encouraged to try to correct the interference by one or more of the following:

- Relocate the receiving antenna.
 - Increase the separation between the equipment and receiver.
 - Connect the equipment into an outlet on a circuit that is different from the receiver.
 - Consult the distributor or an experienced radio/television technician for help.
1. This Transmitter must not cohabitate or operate in conjunction with any other antenna(s) or transmitter(s).
 2. This equipment complies with FCC RF radiation exposure limits set forth for an uncontrolled environment. To maintain compliance with FCC RF exposure compliance requirements, avoid direct contact to the transmitting antenna during transmission.
 3. Any changes or modifications (including the antennas) made to this device that are not expressly approved by the manufacturer may void the user's authority to operate the equipment.

This device complies with Part 15 of the FCC Rules. Operation is subject to the following two conditions:

- (1) this device may not cause harmful interference, and
- (2) this device must accept any interference received, including interference that may cause undesired operation.

FCC Radiation Exposure Statement

This device complies with FCC radiation exposure limits set forth for an uncontrolled environment and it also complies with Part 15 of the FCC RF Rules. This equipment must be installed and operated in accordance with provided instructions and the antenna(s) used for this transmitter must be installed to provide a separation distance of at least 20 cm from all persons and must not be co-located or operating in conjunction with any other antenna or transmitter. End-users and installers must be provide with antenna installation instructions and consider removing the no-collocation statement.

Canadian Compliance Statement

This Class A Digital apparatus meets all requirements of the Canadian Interference-Causing Equipment Regulations.

Cet appareil numérique de la classe A respecte les exigences du Règlement sur le matériel brouilleur du Canada.

European Conformity Statement

Declaration of Conformity with Regard to the R&TTE 1999/5/EC and EMC 89/336/ EEC directives.

RoHS Statement



This device conforms to RoHS (Restriction of Hazardous Substances) European Union regulations that set maximum concentration limits on hazardous materials used in electrical and electronic equipment.

Taiwan NCC Warning Statement

交通部電信總局低功率電波輻射性電機管理辦法 (930322)

根據交通部低功率管理辦法規定：

第十二條 經型式認證合格之低功率射頻電機，非經許可，公司、商號或使用者均不得擅自變更頻率、加大功率或變更原設計之特性及功能。

第十四條 低功率射頻電機之使用不得影響飛航安全及干擾合法通信；經發現有干擾現象時，應立即停用，並改善至無干擾時方得繼續使用。前項合法通信，指依電信法規定作業之無線電通信。低功率射頻電機須忍受合法通信或工業、科學及醫療用電波輻射性電機設備之干擾。

Warranty

The following items are covered under Unitech Limited Warranty:

- MT700 Multi-Function Versatile Controller – 1-year limited warranty.
- Cables – three-month limited warranty.

Table of Contents

PREFACE	I
Regulatory Compliance Statements.....	i
ABOUT THIS MANUAL	I
Warranty	ii
CHAPTER 1	1
Introducing the MT700.....	1
Tour of the MT700.....	1
GETTING STARTED	1
<i>Front View</i>	2
<i>Side View</i>	2
<i>Bottom View</i>	3
<i>Front Main Board</i>	3
<i>Back Terminal Board</i>	4
Setting up the MT700	4
<i>Connecting Power</i>	4
<i>Powering On the MT700</i>	4
Using the MT700 for the First Time.....	4
<i>Using the Touch-screen</i>	4
<i>Setting the Date and Time</i>	5
CHAPTER 2	6
<i>On-screen virtual Keyboard</i>	6
BASIC OPERATION	1
RFID Reader (Optional).....	7
<i>RFID Card Verification</i>	7
Audio Input/Output.....	8
Built-in Camera	9
Tools/Utilities/Applications.....	10
<i>Warm Boot</i>	10
<i>Cold Boot</i>	11
<i>I/O Card Control</i>	11
<i>Registry Backup</i>	12

<i>Func 9</i>	13
<i>Server Manager</i>	13
<i>MifareDemo</i>	19
<i>CameraDemo</i>	20
<i>WavTest</i>	22
<i>Screen Rotation</i>	23
<i>Calibration</i>	24
<i>Net</i>	25
<i>Windows CE Remote Management</i>	26
CHAPTER 3	29
USB Port.....	29
DATA COMMUNICATION	1
Establishing a Wi-Fi Connection	30
IP Address Setup	30
<i>Obtaining an IP Address via DHCP Server</i>	30
<i>Specifying an IP Address</i>	31
CHAPTER 4	32
Adjusting the Backlight	32
POWER AND HARDWARE	1
Hardware Reset.....	33
Performing a Software Reset.....	33
<i>Performing a Warm Boot</i>	33
<i>Performing a Cold Boot</i>	34
Terminal Block	35
APPENDIX A	36
SYSTEM SPECIFICATION	1
APPENDIX B	37
WORLDWIDE SUPPORT	1

Getting Started

Introducing the MT700

The MT700 is a versatile fixed-mount TASHI (Time & Attendance, Access Control, Surveillance, Home Automation and Intercom) Controller. This multi-functional device offers a RFID reader (optional), a microphone, and an audio speaker. It runs on a Windows CE 6.0 operating system, which provides a variety of applications that benefit numerous industries.

Features

Internal System

- TI OMAP DM3730 with DSP 1GHz Processor
- Microsoft Windows CE 6.0

Memory

- 512M bytes DDR SDRAM
- 512M bytes NAND Flash

Display

- 7 inches color TFT-LCD touch screen
- 1024 x 600 resolution

Multimedia

- Speaker Audio Output
- Microphone Audio Input

RFID Reader (Optional)

- EM + HID
- 13.56MHz (ISO14443A or 14443A/B & 15693, or 14443A/4B+15693+NFC)
- Finger print 1:N high performance

Communication

- RS485
- USB 2.0 Host
- Ethernet 10/100Base-T

Wireless Connectivity

- Supports 802.11b/g/n Wireless LAN (Optional)

User Interface

- 12 programmable numeric keys
- Touch-screen

Software Programming Tools

- C#, VB.NET, C++

Programming SDK



- SIP and IP-CAM server/client SDK supporting
- ModBus SDK supporting
- Video Streaming, VoIP and V2oIP
- Elfin utility

Camera

- 1.3 megapixel CMOS camera

Tour of the MT700

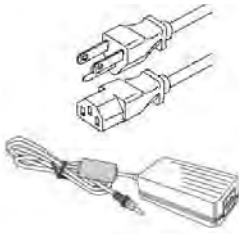
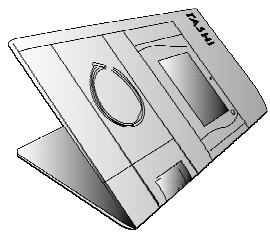
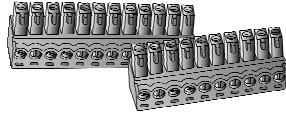
Please make sure the following contents are in the MT700 box. If anything appears missing or damaged, please contact a Unitech representative.

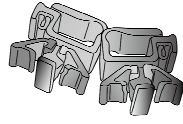
			
MT700	Power Adapter / Cable		QRG paper note
			
10 & 12 pin Terminal Block Plug	Key * 2pcs	Rubber Cap	Cable tie

NOTE: The MT700's display is shipped with a transparent protection film that has been pasted onto the surface of touch panel of the MT700 for protecting the top cover and touch panel. Before using the MT700, tear out the protective film.

If MT700 is provided with RFID reader, you will see the RFID reader logo  on the front panel of MT700.

DO NOT wipe the MT700 with any chemical cleansing agent! We recommend the usage of clean water or soft cloth for display panel/eyeglasses to clean the machine.

The following sections describe the main components and features of the M700.

Front View

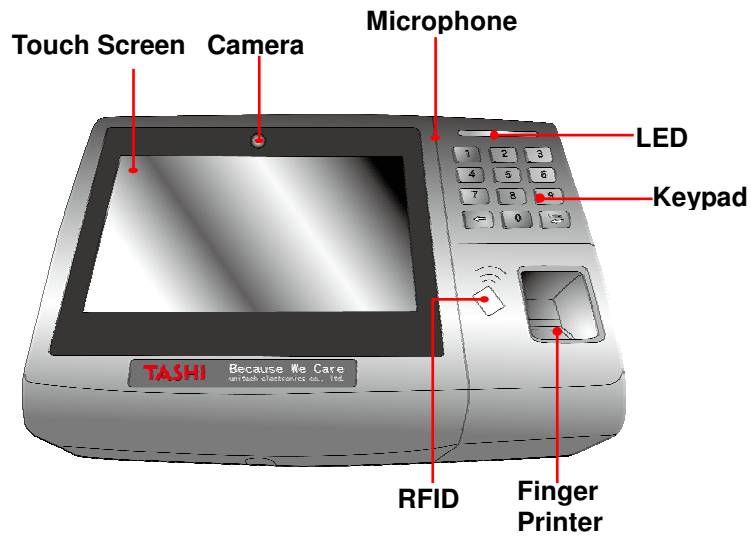

Side View Left



Right



Bottom View

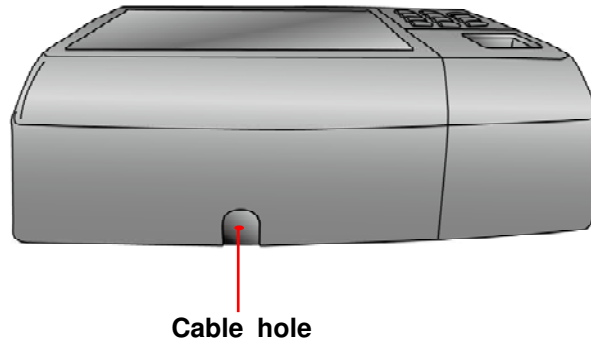

Front Main Board

The Main board can be access via unlocking the right side lock of the MT700 and removing the back steel plate.

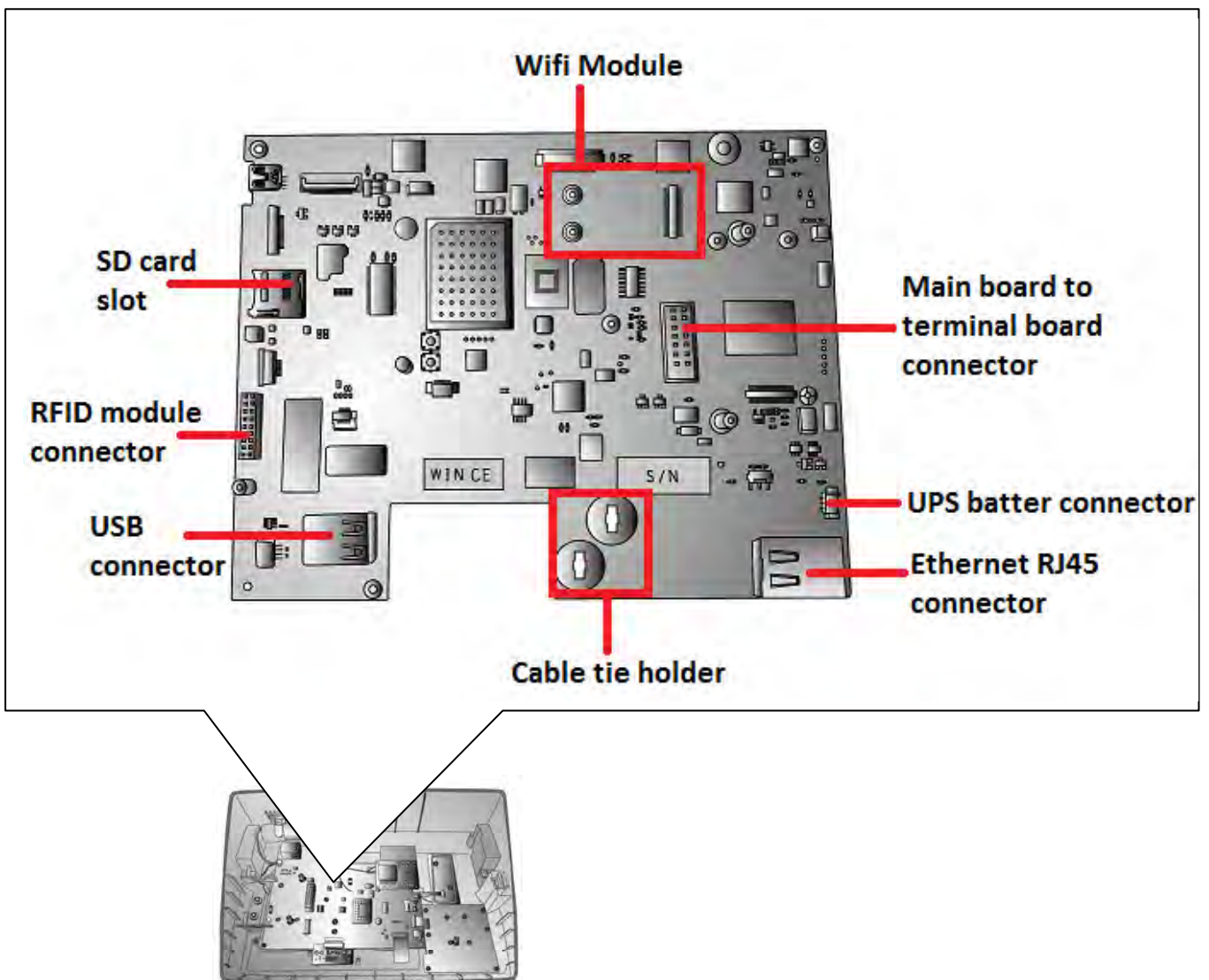

Back Terminal Board

The terminal board can be accessed via unlocking the right side lock of the MT700 and removing the back steel plate.

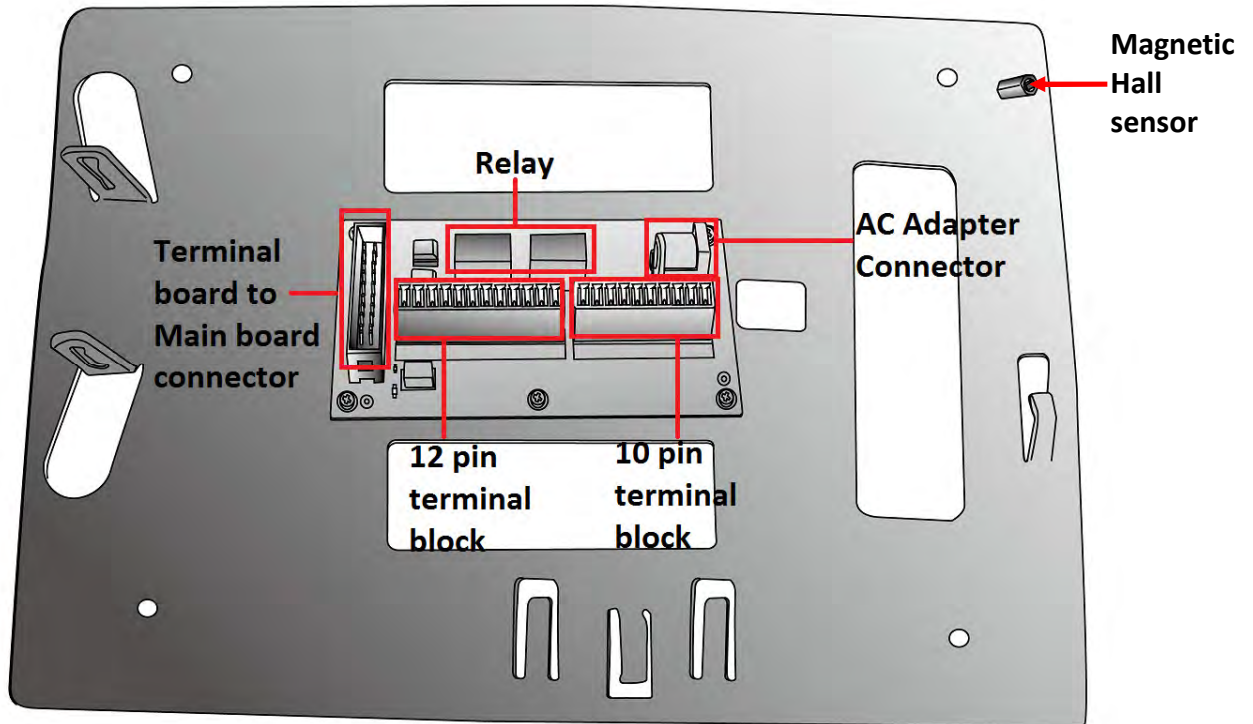

Setting up the MT700

Connecting Power

Connect power to the MT700 through the following instruction: Plug the Power Adapter Cable into the MT700's DC input jack and then connect the other end of the Power Adapter into an electrical outlet.

Powering On the MT700

The MT700 automatically powers on when the Power Adapter plugs into an external power source. The MT700 welcome screen appears.

Using the MT700 for the First Time

Using the Touch-screen

1. Tap the screen to choose a menu option.
2. Double tap to open programs.
3. Use the Windows CE Keyboard to type letters or numbers into a data field or on a form.

Setting the Date and Time

In the Date/Time Properties window, touch the screen to select the current date/time, time zone and daylight saving time option.

- Tap the Left or Right arrows to scroll through the desired year and month, or directly tap the year or month to change the setting.
- Tap on the Hr/Min/Sec AM/PM to input the Hr/Min/Sec to set the time.
- Tap the arrow and set the correct time zone from the drop-down menu.
- Check the box to enable Windows to automatically adjust for day-light saving time.
- Tap Apply to save the settings and exit the Date/Time Properties dialog, or tap  to exit without saving.

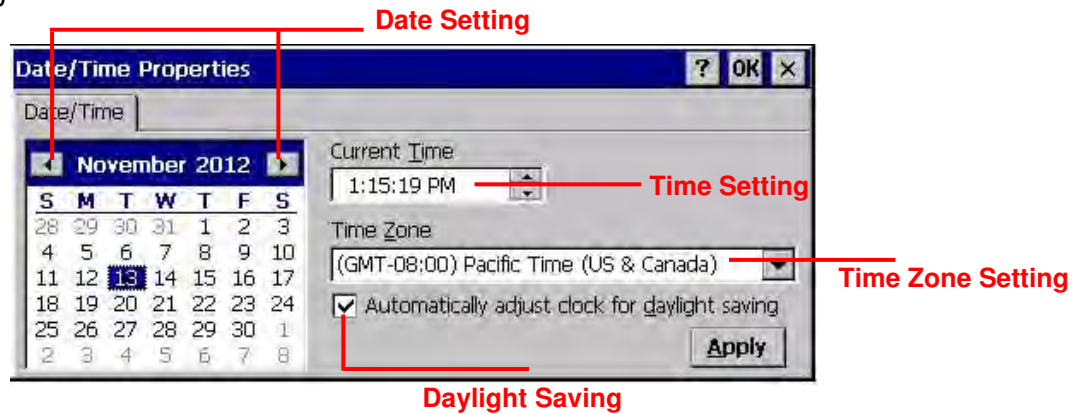

Basic Operation

On-screen virtual Keyboard

Windows CE features on-screen virtual keyboard that simulates all functions and behaviors of physical PC keyboard.

To launch the on-screen virtual keyboard, please tap  → **LargeKB**.

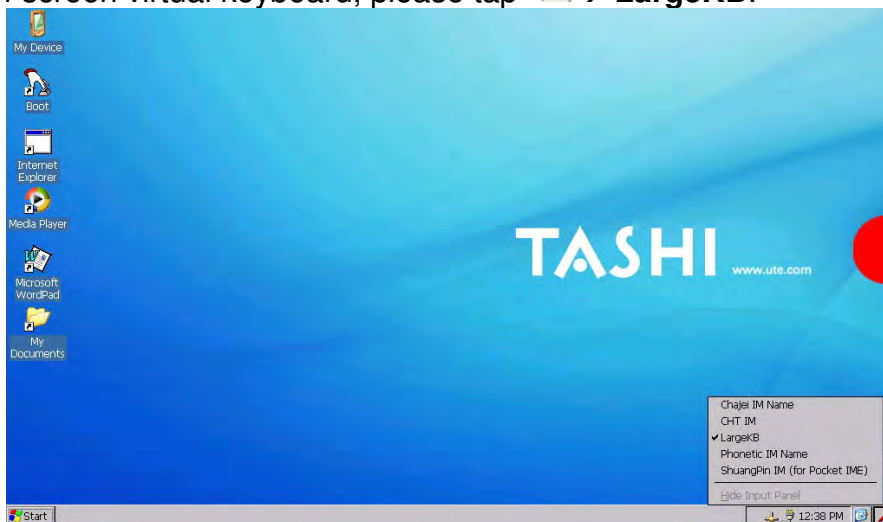

Keyboard Icon

Entering Characters

Entering alphabetic and numeric characters on the MT700 is the same as character input on a standard PC keyboard. Tap the onscreen button corresponding to the desired character.

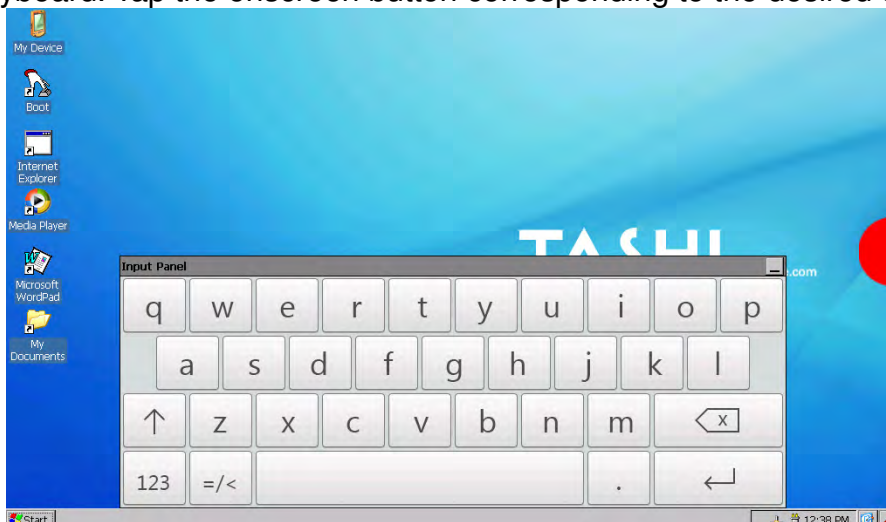

Moving the Keyboard

Tap the title bar and drag the keyboard to a desired location.

Closing the Keyboard

Tap the keyboard icon → Hide Input Panel to close the Windows CE keyboard.

RFID Reader (Optional)

If the MT700 is with built-in RFID reader, you will see the RFID reader logo  on the front panel of MT700. The MT700 features a standard RFID reader, which is compatible with 13.56MHz MiFare cards.

RFID Card Verification

The MT700 has built-in demo programs that allow RFID card verifications.

1. Double-tap the **My Device** icon on the Windows CE desktop.
2. Tap **Windows**.
3. Double-tap **PDA_1.0** to open the demo program.
4. Set the COM Port: field at 2. Tap Connect.

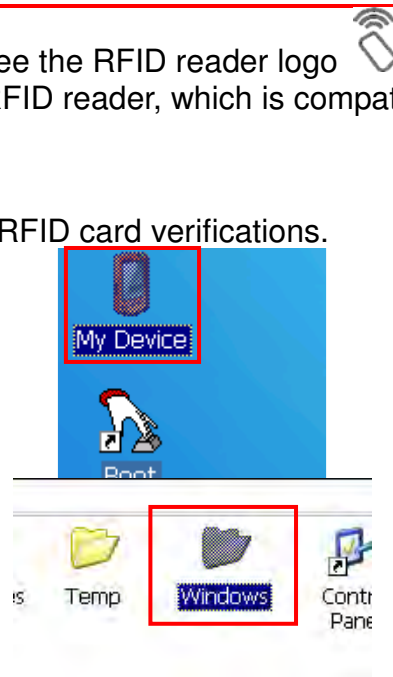

5. Choose a card type to activate the demo test program.

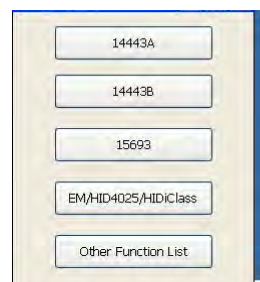
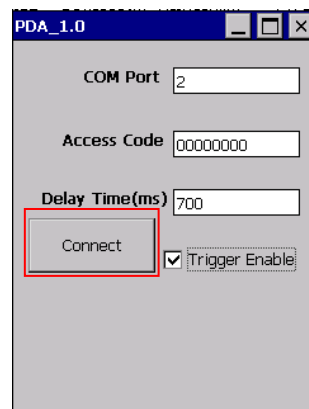

6. Tap Auto and bring the RFID card close to the sensor. The code will display on the field below.

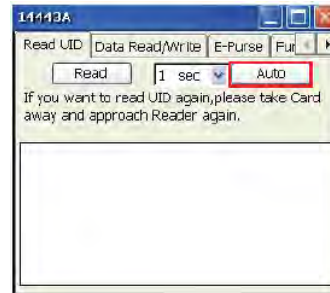

7. Tap Stop to end the reading.

Audio Input/Output

An audio demo program will test the audio input (recording) and output (playback).

1. Double tap My Device on the Windows CE desktop.

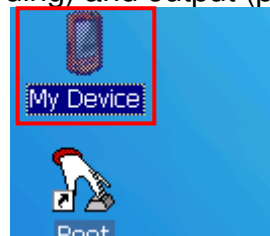

2. Double-tap Windows.

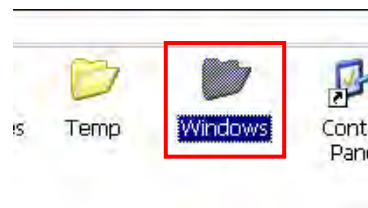

3. Double-tap **wavtest** to open the demo program.



4. Do one of the following:
 - Tap Rec to record the voice.
 - Tap Stop to finish recording.
 - Tap Play to listen to the recording.

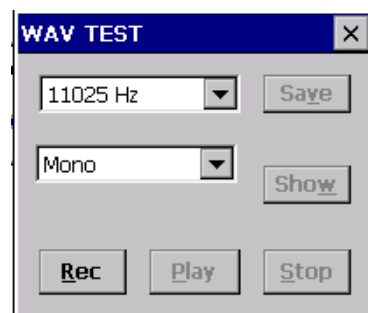

Built-in Camera

The MT700 has a built-in 2.0 megapixel camera which provides the following extra functionality:

- Enables users to capture still pictures when a card is being read
- Checks attendant time with a photo image
- Records video continuously
- Functions as an audio/video intercom

Additionally, facial recognition can be incorporated using third party software.

The MT700 has a demo program that enables users to capture a still picture with a card number and time stamp when a card is read.

To start the camera demo:

1. Double-tap the My Device icon on the Windows CE desktop.

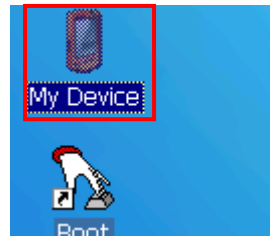

2. Double-tap the Windows folder.

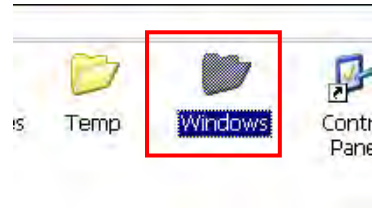

3. Double-tap CameraDemo to open the program. The testing program is displayed.

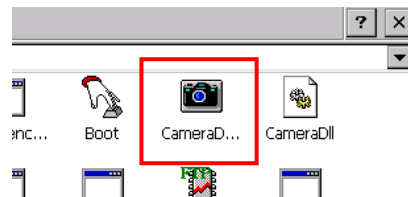

4. Tap Preview → Start.

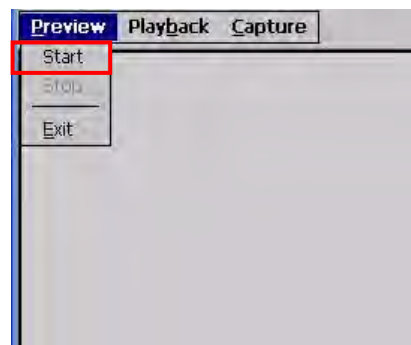

A continuous image is displayed enabling users to capture and playback video.

Tools/Utilities/Applications

BootMode

Path: Start Menu/Programs/Utilities/Boot Mode

This tool allows you to perform warm boot or cold boot.

Warm Boot

1. Select Start Menu -> Programs -> Utilities -> Bootmode



2. Tap "Warm Boot". The system will be warm started.

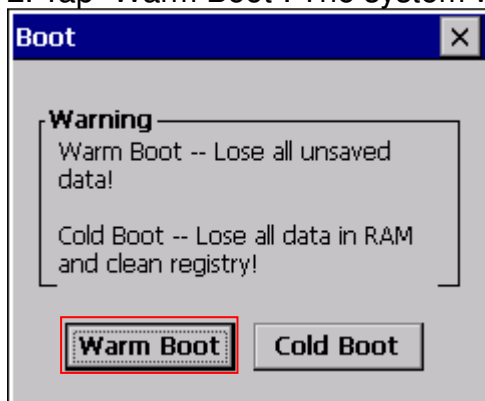

Cold Boot

Caution: Backup your data first!

1. Tap “BootMode”, and Tap “Cold Boot”. Then confirm the choice by selecting YES when program asked to reconfirm the command.

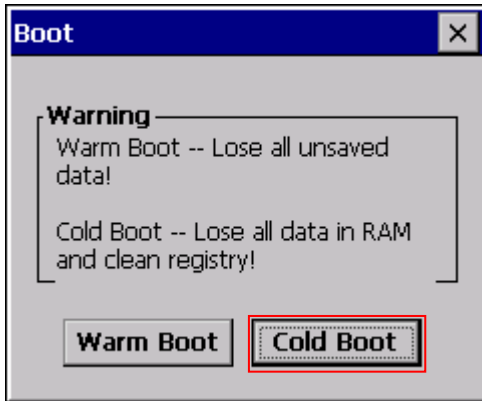

2. The terminal will be cold started.

3. Calibrate the screen according to the instruction displayed, and tap the screen anywhere again once the calibration is completed to continue.

4. Set the date and time, press OK.

I/O Card Control

Path: Start Menu/Programs/Utilities/IO Card

This tool allows you enable or disable CF slot whenever it is necessary. Once you disable the slot, the card in that slot will not work until you enable the slot again.

1. Select Start Menu ->Programs -> Utilities -> IO Card



2. You may choose to enable or disable the card from this tool. Once you selected

disable, the card will no longer be detected unless it is enabled again. Tap “Enable” to enable the card.



3. Tap “Hide” to hide I/O Card Control window.

4. Tap “Exit” to exit I/O card control.

The setting is kept after suspend and power on, however, after warm start/cold start, the setting will be resumed to default value (which is “Enable”)

Registry Backup

Path: Start Menu/Programs/Utilities/RegBackup

This tool allows you to save the current registry or reset to factory default.

1. Select Start Menu -> Programs -> Utilities -> RegBackup.

2. Tap “Save” to save current registry settings.



3. Or tap “Restore” to reset registry to factory default. Terminal will be warm started. (Note that “Restore” button is grey out if the registry setting was not saved before)

Func 9

Path: Start Menu/Programs/Utilities/Func9

This tool displays the general information of the terminal such as platform, firmware version, device ID etc.

1. Select Start Menu -> Programs -> Utilities -> Func9



2. Device information is shown as below:

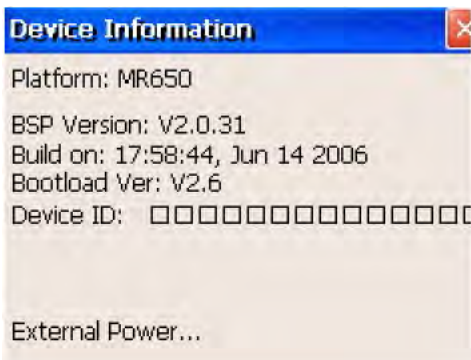

Server Manager

Path: Start Menu/Programs/Utilities/ServerManager

Server Manager is a tool for the user to manager the NTLM (Windows NT LAN Manager) users, FTP users and telnet users.

1. Select Start Menu -> Programs -> Utilities -> Server Manager.

2. On "NTLM" tab, tap "Add" to add a new user.

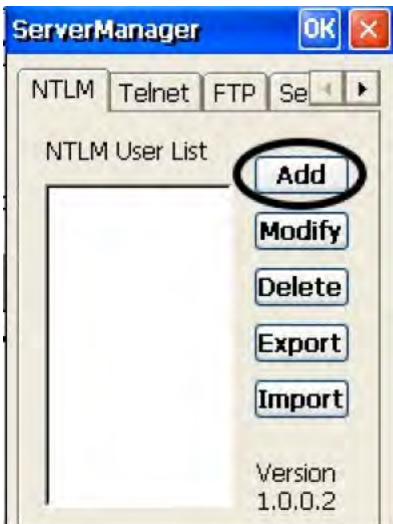

3. Key in the user name and password. Tap OK. Add Success. Tap OK.

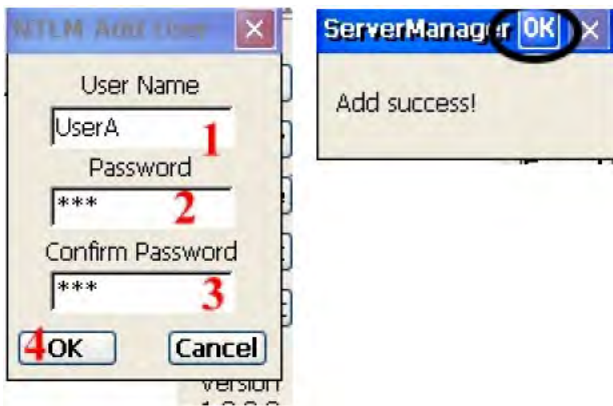

4. To modify a user's password, select the user and tap "Modify".

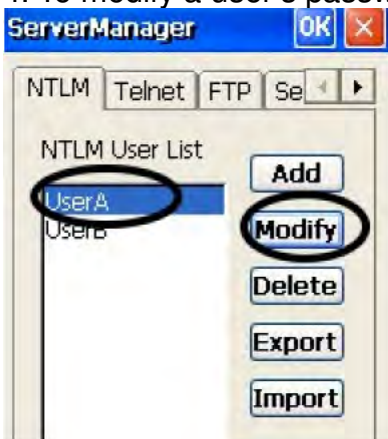

5. Enter the new password and confirm password. Tap OK. Change password success. Tap OK.

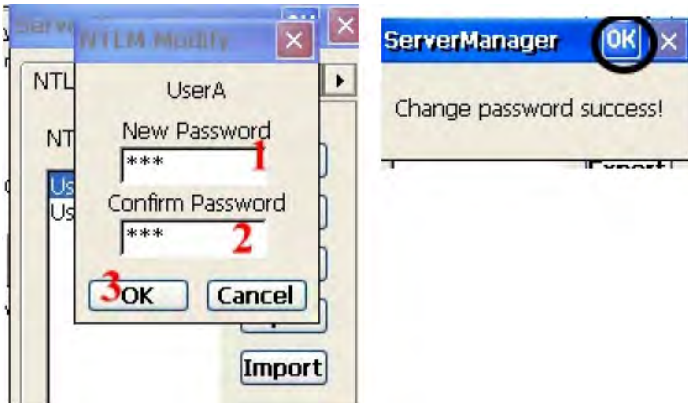

6. To delete a user, select the user you want to delete, tap “Delete”.

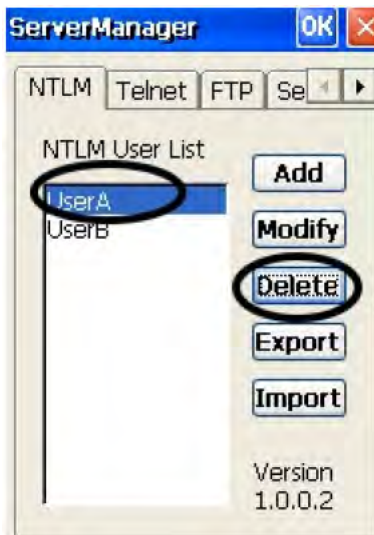

7. Tap “Export”. The user can backup SSID, WEP, all server users and this server’s settings to \Flash Storage.

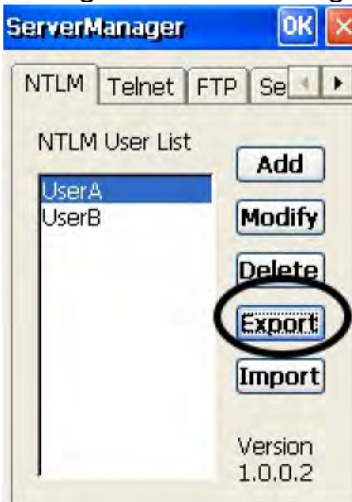

8. Tap “Import” to restore all settings.

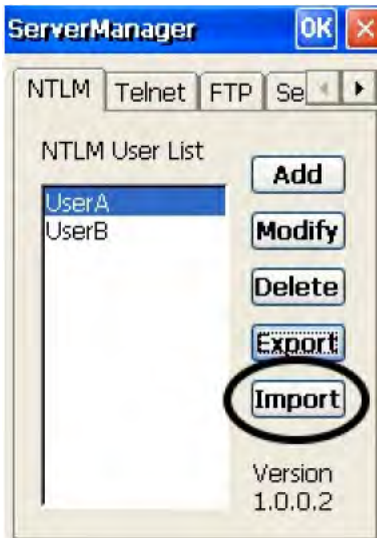

9. Under “Telnet” tab, tap “Add”. Add the telnet user from NTLM. Select the user and tap “Add”.



10. Do you want to add user X to the telnet server? Tap “Yes”.

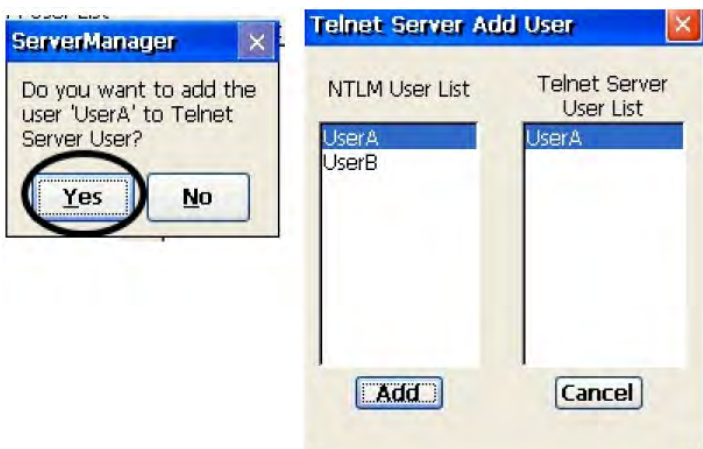

11. To delete telnet user, select the user and tap “Delete”. Do you want to delete the user X? Tap “Yes”

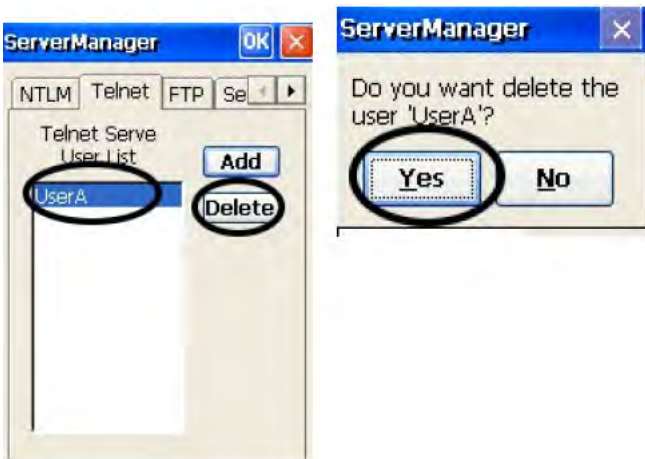

12. Under “FTP” tab, tap “Add” to add ftp user.

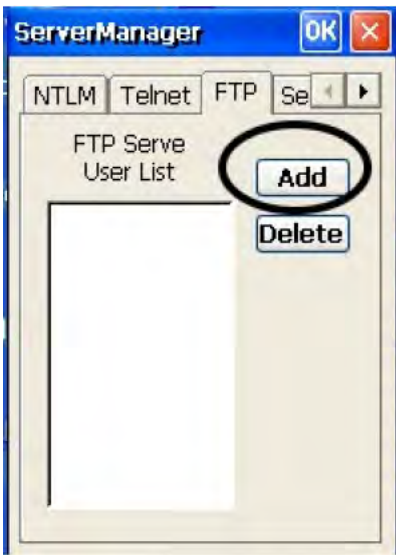

13. Select the user and tap “Add”. Do you want to add user “X” to FTP server User? Tap “Yes”.

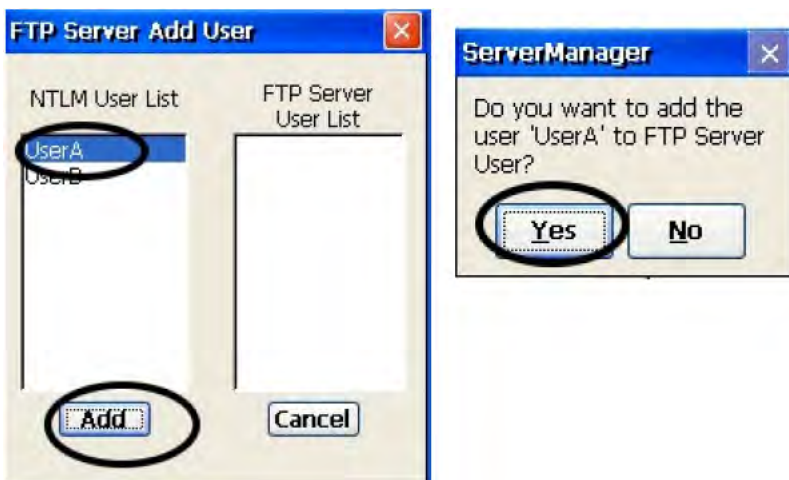



14. To delete ftp user, select the user and tap “Delete”. Do you want to delete the user X? Tap “Yes”.

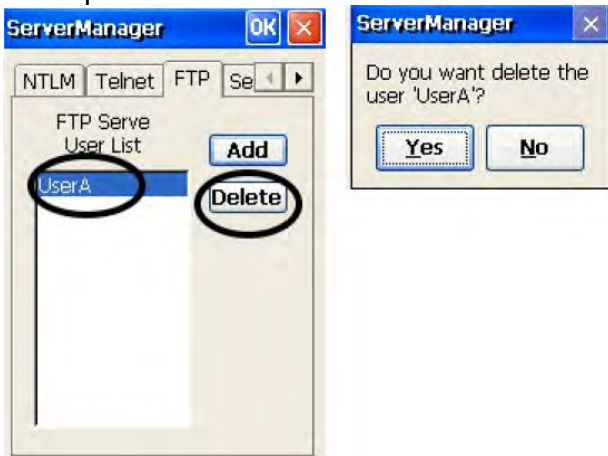

15. Under “Server setting”tab, for telnet server setting, enable/disable server.



16. For FTP server setting, enable/disable server and define anonymous login.



17. Tap "Set Login Directory". Define the login directory (Default is /Temp), tap "Set."

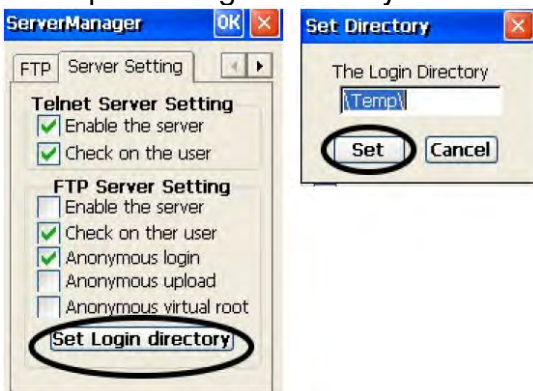

MifareDemo

This feature allows you to make Mifare card verification.

Path: /My Device/Windows/MifareDemo.exe

1. Double tap "MifareDemo".

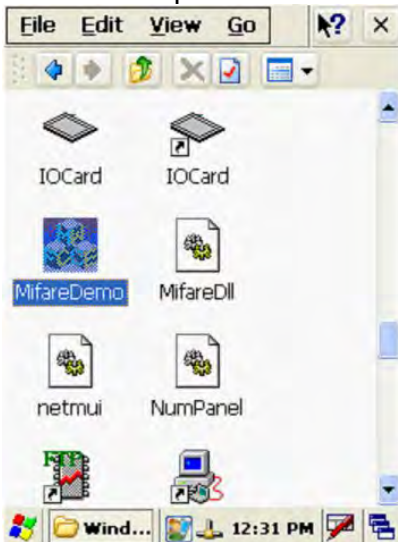

2. Under “Key”, select “Connect” to activate the program.

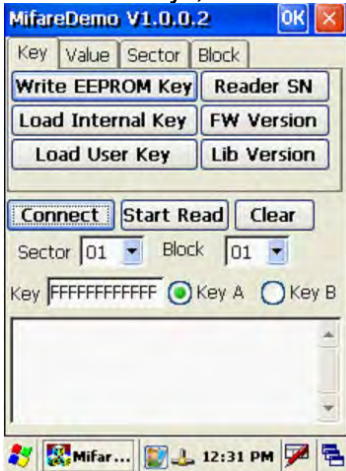

3. Tap “Start Read” and bring the Mifare card close to the sensor. The code will be read and displayed on the following field.

4. Tap “Stop Read” to end reading.

CameraDemo

This utility allows image capture and video streaming.

Path: /My Device/Windows/CameraDemo.exe

1. Double tap “CameraDemo”.

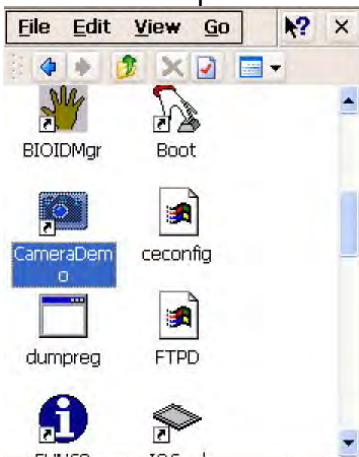

2. Under “Capture”, select “Capture Settings”. Define image and video dimension and storage folder, then tap “OK”.

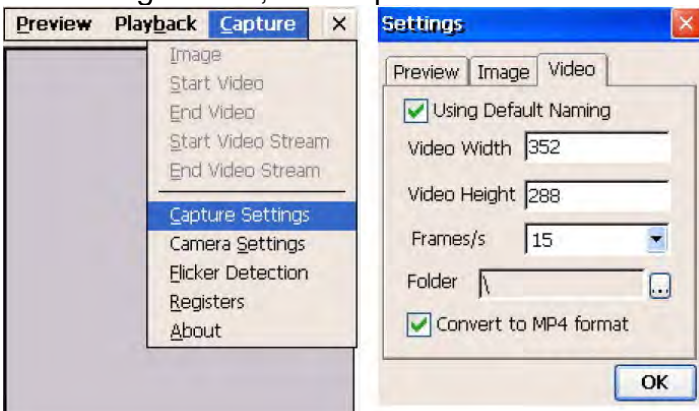

3. Under "Capture", select "Camera Settings". Define the pixel integration time.



4. Under "Capture", select "Flicker Detection". Select the frequency.

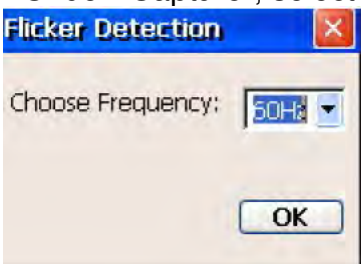

5. Under "Preview", select "Start". Your image will be focused. Under "Capture", select "image".

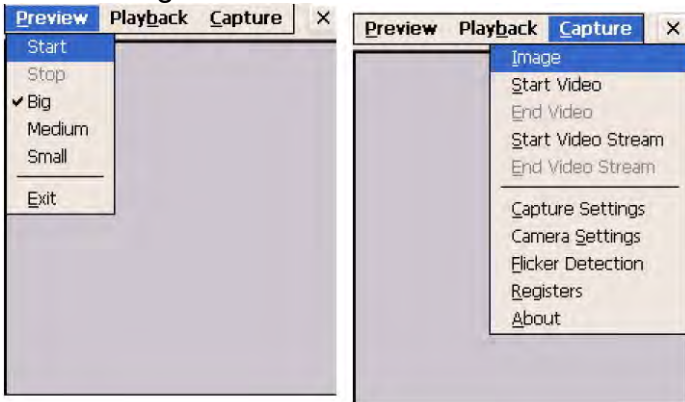

6. Under "Preview", select "Stop". Under "Playback", select "Open". Select the image file that was captured.

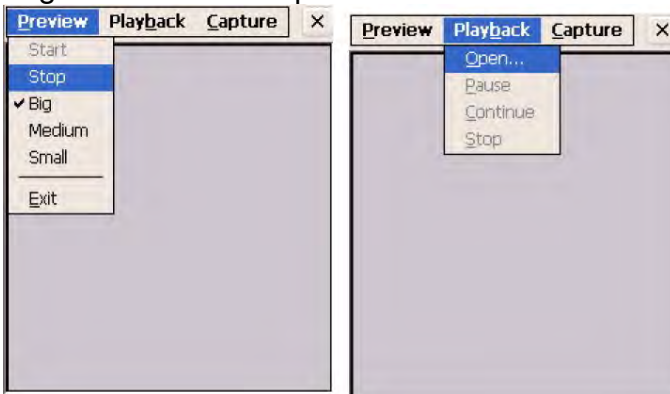

7. Tap "Preview/Exit" to close.

WavTest

Path: /My Device/WavTest

This tool is to test the audio recording and display.

1. Double tap "WavTest".

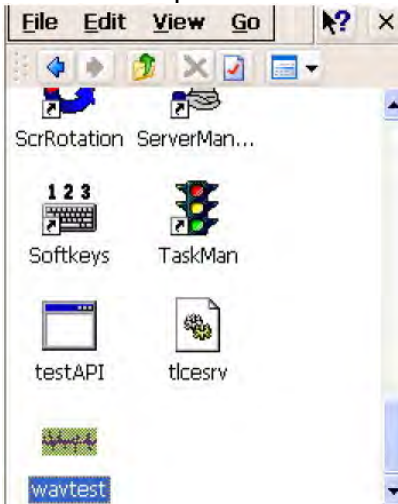

2. Change to "Stereo". Tap "Rec". Talk near to the microphone port of MR650.



3. Tap "Stop" to stop recording. Tap "Play" to play the audio you just recorded.



4. Tap "Save" to save this audio as a wav file.



Screen Rotation

Path: /My Device/Windows/ScrRotation.exe

Screen Rotation allows the users to rotate the screen of terminal to the right, to the left or upside down.

1. Double tap “ScrRotation.exe”.

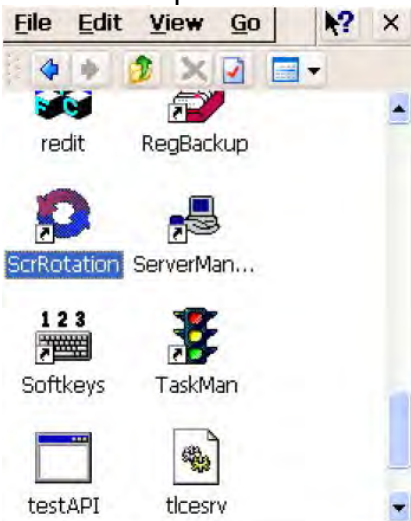

2. The screen rotation icon will appear on the taskbar. Tap the icon to select the option from the menu.



3. Tap “Rotate Right”. The screen is rotated to the right.
4. Tap “Rotate Left”. The screen is rotated to the left.
5. Tap “Upside Down”. The screen is flipped 180° vertically.
6. Tap “About”. The version of screen rotation is shown.
7. Tap “Exit”. Screen rotation icon is disappeared.

Calibration

This tool allows you to do calibration while the original screen calibration is no longer accurate.

Path:/My Device/Windows/Calibration.exe

1. Double tap "Calibration".

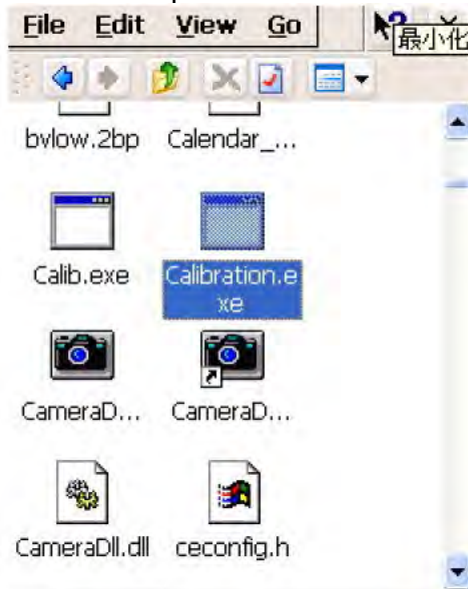

2. Use the stylus to touch the "+" (Center, Top left, Bottom left, Bottom right, Top right), then press "Enter" key.

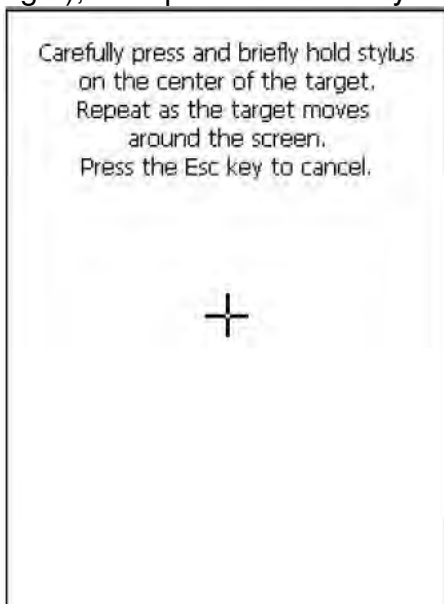

Net

Path: My Device/Windows/Net.exe

This is a MS Dos command that allows you to share data/files with any computer in the network. (Your terminal must connect to network)

1. On your PC/notebook, share a folder to the network.
2. Execute MS DOS prompt command.
3. On the DOS prompt, type the command:
Net Use //<PC's Name>/<Shared Folder Name> <Terminal folder's name>
For Terminal folder's name, you can specify any name you like.

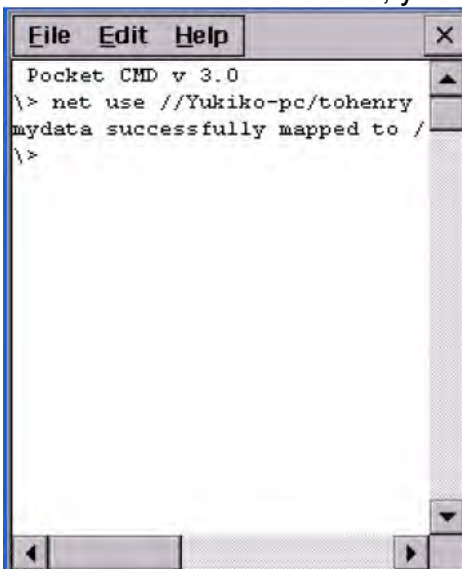

```
File Edit Help X
Pocket CMD v 3.0
\> net use //Yukiko-pc/tohenry
mydata successfully mapped to /
\>
```

4. In "My Device", tap "Network". You will see a terminal folder.

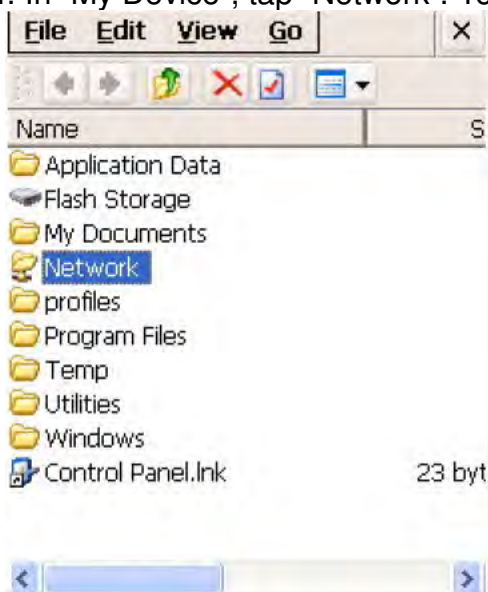

5. Open the folder. You will see the files in the folder. The content is the same as the shared folder in your PC/notebook.



Windows CE Remote Management

1. Connect LAN cable to MR650.
2. Check IP address of MR650.



3. Input IP address of MR650 in the browser's address bar.

4. Enter "admin" as default password and verify the password again.

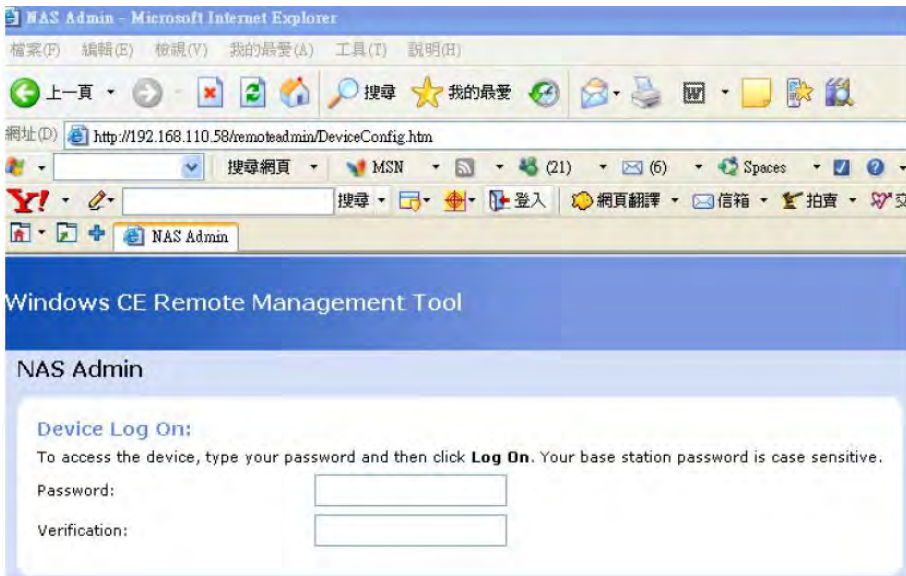

5. Please input Device Name you want and press “Apply”.

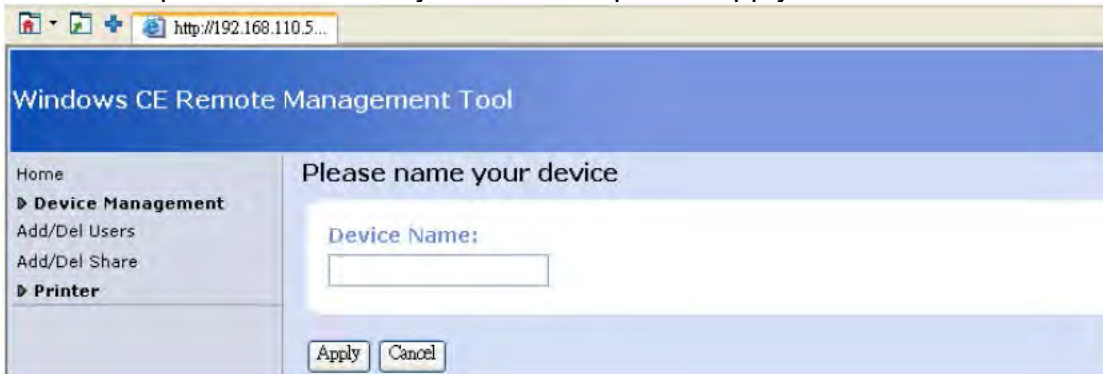

6. The Windows CE Remote Management Tool interface.
Device Management – Configure Network

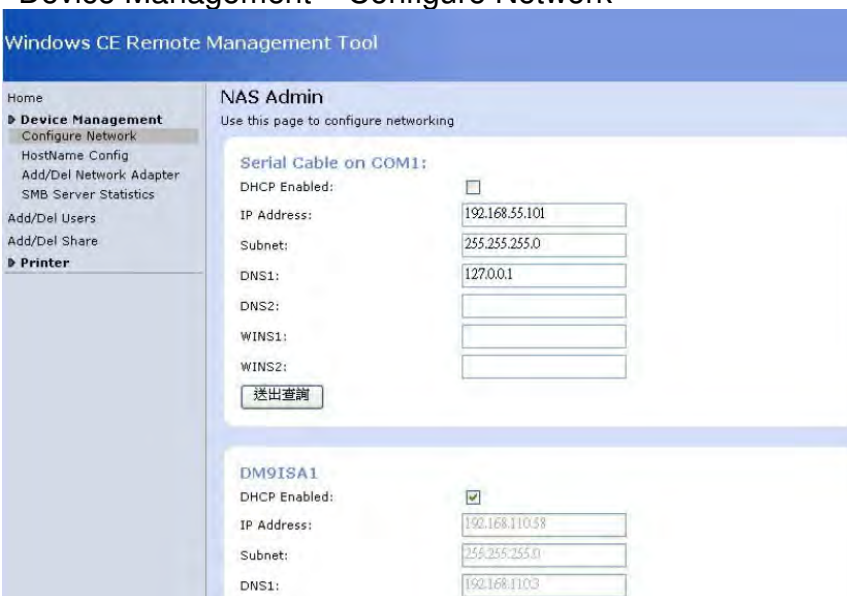

7. Click “Add/Del Users” to Add/Delete users.

You can add or delete any user, except Admin. After enter “Add New”, you can see your new user under “Delete Users”

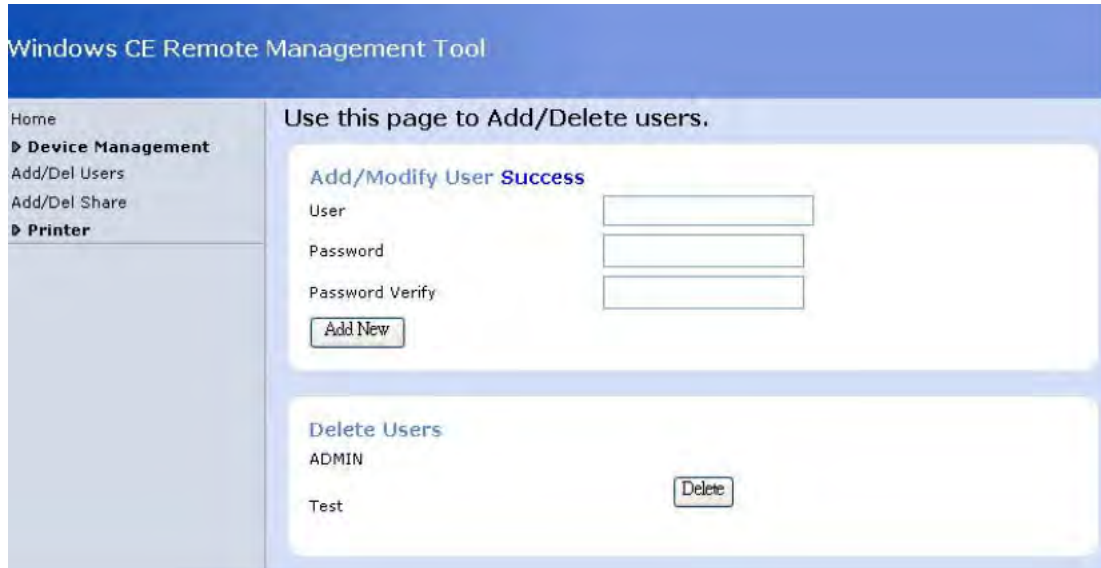

8. Click“Add/Del Network Adapter”. Select the adapter and click “Submit Query”.

9. Click “Add/Del Shares”, define a name for the folder of terminal that you want to share.

10. Click “Permission”. Select “Allow” or “Deny” for the user’s access right. Click “Update”. Click “Done”.

11. On the browser’s URL, enter \\<Device Name>\<folder name>. All the data of the shared folder of the device are shown and they are ready to be shared.

12. To remove any shared folder, click “Remove”.

Data Communication

The MT700 can link to a host computer for data communication via USB or Ethernet cables. USB and Ethernet port is on the front main board and is positioned as indicated in the diagram below.

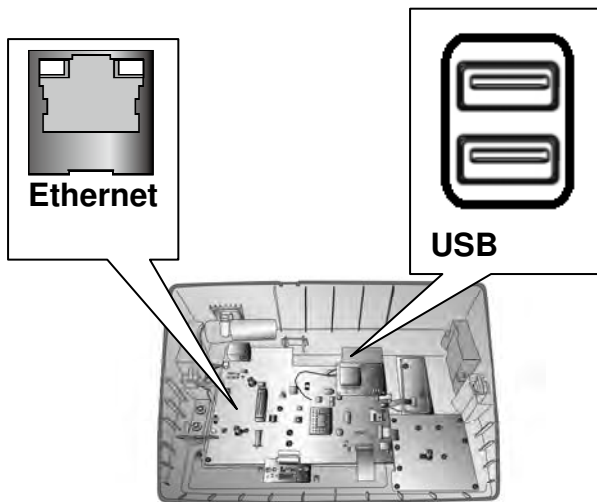

USB Port

Connect a USB cable to the MT700's USB host port, and connect the other end to a USB peripheral, such as a: Keyboard, mouse, memory card or HID compliant device.

Establishing a Wi-Fi Connection

The MT700 supports wireless communication with a built-in Wi-Fi card for 802.11b/g/n WLAN. It is possible to use the WiFi Utility to set up or modify the Wi-Fi settings through the following steps:

NOTE: Wi-Fi access requires a separate service contract through a wireless service provider. Contact a wireless service provider for more information.

Unitech terminals come with built-in RF facility. This chapter guides you through the RF setting.

1. Tap the wireless network icon as a shortcut on the desktop.
2. Move to **Wireless Information**, and tap **Add New** or double tap a preferred network.
3. Enter a Network Name (SSID) and a Network Key. For the detailed instruction on wireless network encryption setting, please visit Microsoft website. Then, tap OK.
4. The network icon appears on the taskbar when the RF is connected.

IP Address Setup

The MT700 automatically detects WLAN module during the first installation. Set the IP address through one of the following methods:

- Obtaining an IP Address via Dynamic Host Configuration Protocol (DHCP) Server.
- Specifying an IP Address.

Obtaining an IP Address via DHCP Server

Make sure a DHCP server is available in the LAN environment before trying to obtain the IP address through a DHCP server.

1. Tap  Start → Settings → Network and Dial-up Connections.
NOTE: Tap  Start → Settings → Control Panel → double-tap Network and Dial-up Connections.

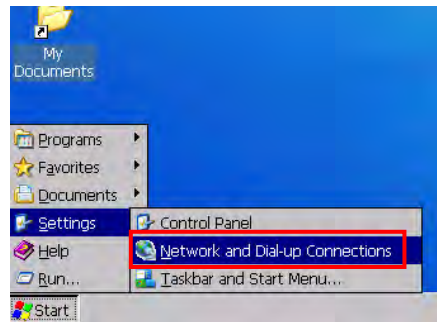

2. Double-tap SMSC95001.



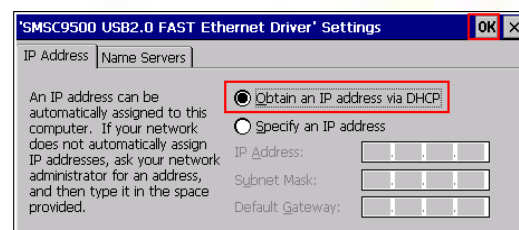

3. Tap the radio button next to Obtain an IP address via DHCP and then tap OK.



Specifying an IP Address

If no DHCP server is available, assign an IP address to each MT700 through the following:

1. Tap  Start → Settings → Network and Dial-up Connections.
NOTE: Tap  Start → Settings → Control Panel → double tap Network and Dial-up Connections.

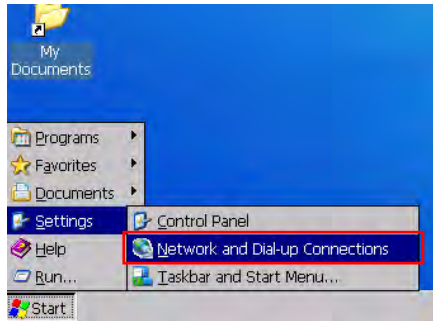

2. Double-tap SMSC95001.



3. Tap the radio button next to Specify an IP address. Input the proper IP address, Subnet Mask and Default Gateway.

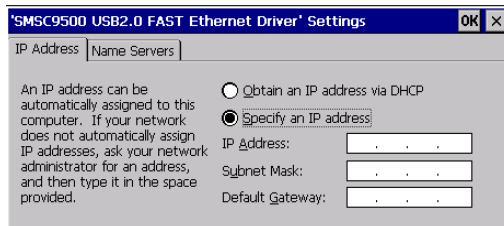

4. In the Name Servers tab, input the proper Primary DNS:, Secondary DNS:, Primary WINS: and Secondary WINS:. Tap OK.

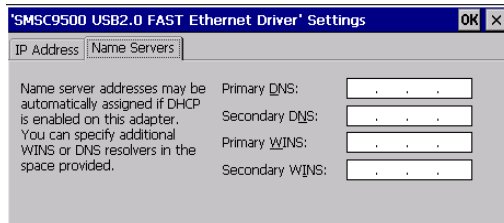

NOTE: To avoid conflict with the Local Area Network environment, consult an MIS department for the correct Transmission Control Protocol / Internet Protocol setting.

Power and Hardware

The MT700 must work with external power. In this case, connect the MT700 to the AC outlet with the power adapter.

Adjusting the Backlight

Adjust the backlight screen settings through the following steps:

NOTE: The MT700 screen contrast has been preset by Unitech for optimum performance.

1. Tap  Start → Settings → Control Panel → double-tap Backlight to adjust the screen brightness.



2. The color display's backlight can be customized for the Battery Power and External Power conditions. Set the backlight behavior and drag the On Intensity and Dim Intensity sliders to the desired levels.

Field	Description
Dim Backlight	Minutes until the backlight dims.
Turn Off Backlight	Minutes until the backlight turns automatically off.
Turn on Backlight	The backlight turns on when a button is pressed, or the touch-screen is tapped.

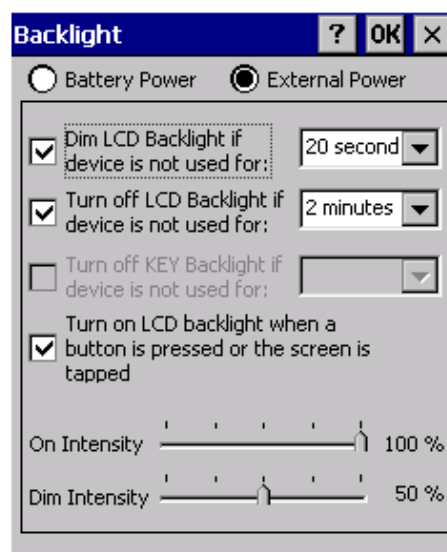

Hardware Reset



To perform a hardware reset, press the Hardware Reset button with a stylus or a sharp object.

Caution: *If you perform the hardware reset, there is a possibility that the settings you have done will be lost!*

Performing a Software Reset

Perform a reset if the MT700 is frozen (i.e., the device no longer responds to pressing buttons on/or the touch-screen).

Performing a Warm Boot

A Warm Boot is used to reset or reboot the device without losing data stored in RAM memory. Perform a Warm Boot in any of the following situations:

- The MT700 fails to respond.
- After installing software applications.
- After making changes to certain system settings (i.e. SD card).

CAUTION! *A Warm Start will erase all unsaved data.*

From Windows CE

1. Tap My Device → Windows → Boot.

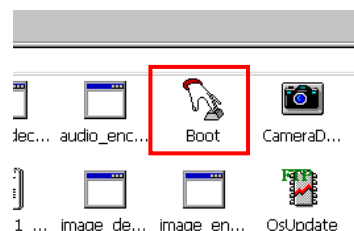

2. Tap Warm Boot.

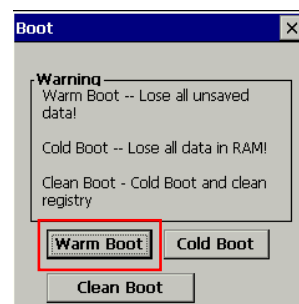

Performing a Cold Boot

A Cold Boot will erase all added data and programs, but it will restore the device to the default factory settings. However, data and application programs stored in the Flash Storage will not be deleted.

Always perform a Warm Boot before attempting to use a Cold Boot to correct a problem. Data previously synchronized to the computer can be restored.

Perform a Cold Boot by using the BootMode utility in the operating system.

Perform a cold boot in the following situations:

Reset the operating system.

Restore the MT700 back to factory settings.

Reset the MT700 after a boot loader, keyboard and kernel upgrade.

CAUTION! A cold boot will erase all data and installed applications in RAM memory.

Method 1: From Windows CE

1. Tap My Device → Windows → Boot.

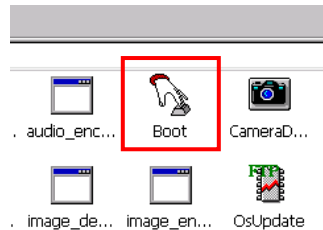

2. Tap Cold Boot.

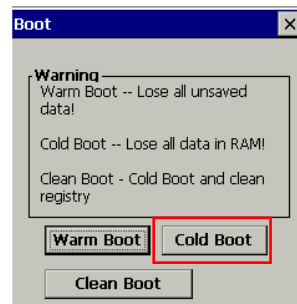

Method 2: From Hardware

Pull out the power cable and then plug the cable into the DC input jack to cold boot

Terminal Block

The MT700 provides a 10-pin and a 12-pin terminal block plugs for input/output signals. With reference to the illustrative figures below, Insert the terminal block plugs into the terminal block sockets on the rear side of the MT700.

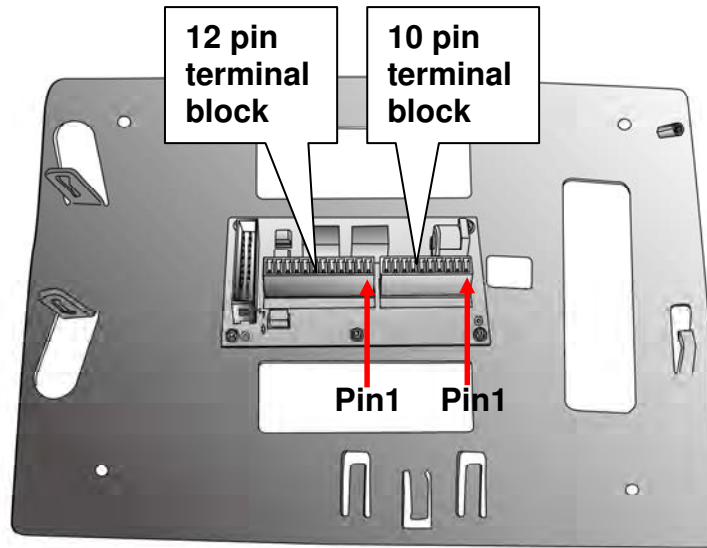

10 pin Terminal Block Pin Assignment

Pin	Name
Pin 1	12V
Pin 2	GND
Pin 3	WIEGAND1_D0
Pin 4	WIEGAND1_D1
Pin 5	GND
Pin 6	5V
Pin 7	WIEGAND2_D0
Pin 8	WIEGAND2_D1
Pin 9	GND
Pin 10	5V
N/A	

12 pin Terminal Block Pin Assignment

Pin	Name
Pin 1	RL1NO
Pin 2	RL1C
Pin 3	RL1NC
Pin 4	RL2NO
Pin 5	RL2C
Pin 6	RL2NC
Pin 7	DI1-2
Pin 8	DI1-1
Pin 9	DI2-2
Pin 10	DI2-1
Pin 11	RS485+
Pin 12	RS485-

Appendix A

System Specification

Processor/Memory	CPU	TI OMAP DM3730 with DSP 1GHz Processor	
	Memory	SDRAM: 512 MB NAND Flash: 512 MB	
OS	Microsoft Windows CE 6.0 Professional Plus		
Button	12 programmable numeric keys		
Display	7 inches color (1024 x 600) Pixels Backlight Touch-screen, TFT-LCD		
Communication	1 X RJ45 with POE (DC12V/1A, IEEE802.3af Compliant) RS485 Support (Optional RS485+, RS485-) baud rate at 15200 bps or lower USB v2.0 Host Supports IEEE 802.11b/g/n (optional)		
Multimedia	Audio: Two 1 Watt speakers Microphone audio input		
Programming SDK	ModBus SDK supporting Elfin utility		
Power Source	External Power (DC12V/2A)		
Enclosure	Weight	1618 g.	
	Dimension	297.53mm (L) X 203.98mm (W) X 74.98mm(H)	
Environmental	Operating temperature	-10°C ~ 50°C	
	Storage temperature	-20°C ~ 60°C	
	Relative Humidity	10% – 95%	
Certification	CE, FCC, NCC, CB, BSMI and RoHS compliant		
Programming	VoIP/V2oIP, Video Streaming		
RFID Reader (Optional)	EM+HID MiFare 13.56MHz (ISO 14443A / ISO 14443-4B / ISO 15693 / NFC) Finger print 1:N performance module		
Camera	1.3 megapixel CMOS camera		
Storage	Micro SD slot and support up to 4Gb		

Appendix B

Worldwide Support

At unitech, we have a professional support team to answer your questions or any related technical issues. If the equipment problem occurs, you may contact our regional services representatives to get the quick response. We have six regional services centers, and choose your region to get our quick support and their contact information can be found in our websites provided as below.

Region	Web Site
Global Operation Center	http://www.ute.com
Unitech Taiwan	http://tw.ute.com
Unitech Asia Pacific & Middle	http://apac.ute.com http://india.ute.com
Unitech China	http://cn.ute.com
Unitech Japan	http://jp.ute.com
Unitech America	http://us.ute.com http://can.ute.com
Unitech Latin America	http://latin.ute.com
Unitech Europe	http://eu.ute.com