



FCC 47 CFR PART 15 SUBPART C

TEST REPORT

For

Dongle for MS84X wireless scanner

Model Number: MS84X-2

Trade Name: unitech

Issued to

**Unitech electronics co., ltd.
5Fl., No.136, Lane235, Pao-Chiao Rd., Hsin-Tien Dist,
New Taipei City, Taiwan**

Issued by

**Compliance Certification Services Inc.
No.11, Wugong 6th Rd., Wugu Dist.,
New Taipei City 24891, Taiwan. (R.O.C.)
<http://www.ccsrf.com>
service@ccsrf.com
Issued Date: April 18, 2013**



Note: This report shall not be reproduced except in full, without the written approval of Compliance Certification Services Inc. This document may be altered or revised by Compliance Certification Services Inc. personnel only, and shall be noted in the revision section of the document.



Revision History

Rev.	Issue Date	Revisions	Effect Page	Revised By
00	April 18, 2013	Initial Issue	ALL	Kelly Cheng



TABLE OF CONTENTS

1. TEST RESULT CERTIFICATION.....	4
2. EUT DESCRIPTION.....	5
3. TEST METHODOLOGY	6
3.1 EUT CONFIGURATION	6
3.2 EUT EXERCISE.....	6
3.3 GENERAL TEST PROCEDURES.....	6
3.4 FCC PART 15.205 RESTRICTED BANDS OF OPERATIONS.....	7
3.5 DESCRIPTION OF TEST MODES	8
4. INSTRUMENT CALIBRATION.....	9
4.1 MEASURING INSTRUMENT CALIBRATION	9
4.2 MEASUREMENT EQUIPMENT USED	9
4.3 MEASUREMENT UNCERTAINTY	10
5. FACILITIES AND ACCREDITATIONS	11
5.1 FACILITIES	11
5.2 EQUIPMENT.....	11
5.3 TABLE OF ACCREDITATIONS AND LISTINGS.....	12
6. SETUP OF EQUIPMENT UNDER TEST	13
6.1 SETUP CONFIGURATION OF EUT.....	13
6.2 SUPPORT EQUIPMENT	13
7. FCC PART 15.249 REQUIREMENTS	14
7.1 20 DB BANDWIDTH.....	14
7.2 BAND EDGES MEASUREMENT	17
7.3 SPURIOUS EMISSION	23
7.4 POWERLINE CONDUCTED EMISSIONS	31
APPENDIX I PHOTOGRAPHS OF TEST SETUP	34
APPENDIX 1 - PHOTOGRAPHS OF EUT	



1. TEST RESULT CERTIFICATION

Applicant: Unitech electronics co., ltd.
 5Fl., No.136, Lane235, Pao-Chiao Rd., Hsin-Tien Dist,
 New Taipei City, Taiwan

Equipment Under Test: Dongle for MS84X wireless scanner

Trade Name: unitech

Model Number: MS84X-2

Date of Test: January 3 ~ March 23, 2013

APPLICABLE STANDARDS	
STANDARD	TEST RESULT
FCC 47 CFR Part 15 Subpart C(10-1-12 Edition)	No non-compliance noted

We hereby certify that:

The above equipment was tested by Compliance Certification Services Inc. The test data, data evaluation, test procedures, and equipment configurations shown in this report were made in accordance with the procedures given in **ANSI C63.4: 2009** and the energy emitted by the sample EUT tested as described in this report is in compliance with the requirements emission limits of FCC Rules Part 15.207, 15.209 and 15.249.

The test results of this report relate only to the tested sample identified in this report.

Approved by:

Reviewed by:

Miller Lee
 Section Manager
 Compliance Certification Services Inc.

Gina Lo
 Section Manager
 Compliance Certification Services Inc.



2. EUT DESCRIPTION

Product	Dongle for MS84X wireless scanner					
Trade Name	unitech					
Model Number	MS84X-2					
Received Date	December 27, 2012					
Power Supply	Power from host device.					
Frequency Spacing	Channel	Frequency (MHz)	Channel	Frequency (MHz)	Channel	Frequency (MHz)
	1	2410	22	2431	43	2452
	2	2411	23	2432	44	2453
	3	2412	24	2433	45	2454
	4	2413	25	2434	46	2455
	5	2414	26	2435	47	2456
	6	2415	27	2436	48	2457
	7	2416	28	2437	49	2457
	8	2417	29	2438	50	2458
	9	2418	30	2439	51	2460
	10	2419	31	2440	52	2461
	11	2420	32	2441	53	2462
	12	2421	33	2442	54	2463
	13	2422	34	2443	55	2464
	14	2423	35	2444	56	2465
	15	2424	36	2445	57	2466
	16	2425	37	2446	58	2467
	17	2426	38	2447	59	2468
	18	2427	39	2448	60	2469
	19	2428	40	2449	61	2470
	20	2429	41	2450		
	21	2430	42	2451		
Modulation Technique	GFSK					
Antenna Gain	-3dBi					
Antenna Designation	PCB Antenna					

Remark:

1. The sample selected for test was production product and was provided by manufacturer.
2. This submittal(s) (test report) is intended for FCC ID: **HLEMS84XGP** filing to comply with Section 15.107, 15.109, 15.207, 15.209, 15.249 (FCC Part 15, Subpart C Rules.)



3. TEST METHODOLOGY

The tests documented in this report were performed in accordance with ANSI C63.4: 2009 and FCC CFR 47 Part 15.207, 15.209, 15.247.

3.1 EUT CONFIGURATION

The EUT configuration for testing is installed on RF field strength measurement to meet the Commissions requirement and operating in a manner that intends to maximize its emission characteristics in a continuous normal application.

3.2 EUT EXERCISE

The EUT was operated in the engineering mode to fix the TX frequency that was for the purpose of the measurements.

According to its specifications, the EUT must comply with the requirements of the Section 15.207, 15.209, 15.249 under the FCC Rules Part 15 Subpart C.

3.3 GENERAL TEST PROCEDURES

Conducted Emissions

The EUT is placed on the turntable, which is 0.8 m above ground plane. According to the requirements in Section 13.1.4.1 of ANSI C63.4: 2009 Conducted emissions from the EUT measured in the frequency range between 0.15 MHz and 30MHz using CISPR Quasi-peak and average detector modes.

Radiated Emissions

The EUT is placed on a turn table, which is 0.8 m above ground plane. The turntable shall rotate 360 degrees to determine the position of maximum emission level. EUT is set 3m away from the receiving antenna, which varied from 1m to 4m to find out the highest emission. And also, each emission was to be maximized by changing the polarization of receiving antenna both horizontal and vertical. In order to find out the maximum emissions, exploratory radiated emission measurements were made according to the requirements in Section 13.1.4.1 of ANSI C63.4: 2009.



3.4 FCC PART 15.205 RESTRICTED BANDS OF OPERATIONS

(a) Except as shown in paragraph (d) of this section, only spurious emissions are permitted in any of the frequency bands listed below:

MHz	MHz	MHz	GHz
0.090 - 0.110	16.42 - 16.423	399.9 - 410	4.5 - 5.15
¹ 0.495 - 0.505	16.69475 - 16.69525	608 - 614	5.35 - 5.46
2.1735 - 2.1905	16.80425 - 16.80475	960 - 1240	7.25 - 7.75
4.125 - 4.128	25.5 - 25.67	1300 - 1427	8.025 - 8.5
4.17725 - 4.17775	37.5 - 38.25	1435 - 1626.5	9.0 - 9.2
4.20725 - 4.20775	73 - 74.6	1645.5 - 1646.5	9.3 - 9.5
6.215 - 6.218	74.8 - 75.2	1660 - 1710	10.6 - 12.7
6.26775 - 6.26825	108 - 121.94	1718.8 - 1722.2	13.25 - 13.4
6.31175 - 6.31225	123 - 138	2200 - 2300	14.47 - 14.5
8.291 - 8.294	149.9 - 150.05	2310 - 2390	15.35 - 16.2
8.362 - 8.366	156.52475 -	2483.5 - 2500	17.7 - 21.4
8.37625 - 8.38675	156.52525	2655 - 2900	22.01 - 23.12
8.41425 - 8.41475	156.7 - 156.9	3260 - 3267	23.6 - 24.0
12.29 - 12.293	162.0125 - 167.17	3332 - 3339	31.2 - 31.8
12.51975 - 12.52025	167.72 - 173.2	3345.8 - 3358	36.43 - 36.5
12.57675 - 12.57725	240 - 285	3600 - 4400	(²)
13.36 - 13.41	322 - 335.4		

¹ Until February 1, 1999, this restricted band shall be 0.490-0.510 MHz.

² Above 38.6

(b) Except as provided in paragraphs (d) and (e), the field strength of emissions appearing within these frequency bands shall not exceed the limits shown in Section 15.209. At frequencies equal to or less than 1000 MHz, compliance with the limits in Section 15.209 shall be demonstrated using measurement instrumentation employing a CISPR quasi-peak detector. Above 1000 MHz, compliance with the emission limits in Section 15.209 shall be demonstrated based on the average value of the measured emissions. The provisions in Section 15.35 apply to these measurements.



3.5 DESCRIPTION OF TEST MODES

The EUT (model: MS84X-2) had been tested under operating condition.

After verification, all tests were carried out with the worst case test modes as shown below except radiated spurious emission below 1GHz, which worst case was in normal link mode only, and powerline conducted emission below 30MHz, which worst case was in normal link mode.

Channel Low(2410MHz), Channel Mid(2440MHz) and Channel High(2470MHz) were chosen for the final testing.

The field strength of spurious emission was measured in the following position: EUT stand-up position (Z axis), lie-down position (X, Y axis). The worst emission was found in lie-down position (Y axis) and the worst case was recorded.



4. INSTRUMENT CALIBRATION

4.1 MEASURING INSTRUMENT CALIBRATION

The measuring equipment, which was utilized in performing the tests documented herein, has been calibrated in accordance with the manufacturer's recommendations for utilizing calibration equipment, which is traceable to recognized national standards.

4.2 MEASUREMENT EQUIPMENT USED

Equipment Used for Emissions Measurement

Remark: Each piece of equipment is scheduled for calibration once a year and Loop Antenna is scheduled for calibration once three years.

Conducted Emissions Test Site				
Name of Equipment	Manufacturer	Model	Serial Number	Calibration Due
Spectrum Analyzer	Agilent	E4446A	MY43360131	03/20/2014

3M Chamber Test Site				
Name of Equipment	Manufacturer	Model	Serial Number	Calibration Due
Spectrum Analyzer	Agilent	E4446A	US42510268	11/06/2013
EMI Test Receiver	R&S	ESCI	100064	02/28/2014
Pre-Amplifier	Mini-Circuits	ZFL-1000LN	SF350700823	01/12/2014
Pre-Amplifier	MITEQ	AFS44-00102650-42-10P-44	1415367	11/19/2013
Bilog Antenna	Sunol Sciences	JB3	A030105	10/02/2013
Horn Antenna	EMCO	3117	00055165	02/13/2014
Horn Antenna	EMCO	3116	2487	10/10/2013
Loop Antenna	EMCO	6502	8905/2356	06/10/2013
Turn Table	CCS	CC-T-1F	N/A	N.C.R
Antenna Tower	CCS	CC-A-1F	N/A	N.C.R
Controller	CCS	CC-C-1F	N/A	N.C.R
Site NSA	CCS	N/A	N/A	12/22/2013
Test S/W	EZ-EMC (CCS-3A1RE)			

Conducted Emission room # B				
Name of Equipment	Manufacturer	Model	Serial Number	Calibration Due
EMI Test Receiver	R&S	ESCI	101073	07/31/2013
LISN	R&S	ENV216	101054	06/06/2013
LISN	SCHWARZBECK	NSLK 8127	8127-541	12/10/2013
Capacitive Voltage Probe	FCC	F-CVP-1	100185	03/24/2014
Test S/W	CCS-3A1-CE			



4.3 MEASUREMENT UNCERTAINTY

PARAMETER	UNCERTAINTY
Powerline Conducted Emission	+/- 1.2159
3M Semi Anechoic Chamber / <200M	+/- 4.0138
3M Semi Anechoic Chamber / 200M~1000M	+/- 3.9483
3M Semi Anechoic Chamber / 1G~8G	+/- 2.5975
3M Semi Anechoic Chamber / 8G~18G	+/- 2.6112
3M Semi Anechoic Chamber / 18G~26G	+/- 2.7389
3M Semi Anechoic Chamber / 26G~40G	+/- 2.9683

Remark: This uncertainty represents an expanded uncertainty expressed at approximately the 95% confidence level using a coverage factor of $k=2$.



5. FACILITIES AND ACCREDITATIONS

5.1 FACILITIES

All measurement facilities used to collect the measurement data are located at

No.199, Chungshen Road, Hsintien City, Taipei Hsien, Taiwan, R.O.C.

Tel: 886-2-2217-0894 / Fax: 886-2-2217-1029

No.11, Wugong 6th Rd., Wugu Dist., New Taipei City 24891, Taiwan. (R.O.C.)

Tel: 886-2-2299-9720 / Fax: 886-2-2298-4045

No.81-1, Lane 210, Bade 2nd Rd., Lujhu Township, Taoyuan County 33841, TAIWAN, R.O.C.

Tel: 886-3-324-0332 / Fax: 886-3-324-5235

The sites are constructed in conformance with the requirements of ANSI C63.7, ANSI C63.4 and CISPR Publication 22.

5.2 EQUIPMENT

Radiated emissions are measured with one or more of the following types of linearly polarized antennas: tuned dipole, biconical, log periodic, bi-log, and/or ridged waveguide, horn. Spectrum analyzers with pre-selectors and quasi-peak detectors are used to perform radiated measurements.



Conducted emissions are measured with Line Impedance Stabilization Networks and EMI Test Receivers.

Calibrated wideband preamplifiers, coaxial cables, and coaxial attenuators are also used for making measurements.

All receiving equipment conforms to CISPR Publication 16-1, "Radio Interference Measuring Apparatus and Measurement Methods."



5.3 TABLE OF ACCREDITATIONS AND LISTINGS

Country	Agency	Scope of Accreditation	Logo
USA	FCC	3M Semi Anechoic Chamber (FCC MRA: TW1039) to perform FCC Part 15 measurements	 FCC MRA: TW1039
Taiwan	TAF	LP0002, RTTE01, FCC Method-47 CFR Part 15 Subpart C, D, E, RSS-210, RSS-310 IDA TS SRD, AS/NZS 4268, AS/NZS 4771, TS 12.1 & 12.2, ETSI EN 300 440-1, ETSI EN 300 440-2, ETSI EN 300 328, ETSI EN 300 220-1, ETSI EN 300 220-2, ETSI EN 301 893, ETSI EN 301 489-1/3/7/17 FCC OET Bulletin 65 + Supplement C, EN 50360, EN 50361, EN 50371, RSS 102, EN 50383, EN 50385, EN 50392, IEC 62209, CNS 14958-1, CNS 14959 FCC Method -47 CFR Part 15 Subpart B IEC / EN 61000-3-2, IEC / EN 61000-3-3, IEC / EN 61000-4-2/3/4/5/6/8/11	
Canada	Industry Canada	3M Semi Anechoic Chamber (IC 2324G-1 / IC 2324G-2) to perform	 IC 2324G-1 IC 2324G-2

* No part of this report may be used to claim or imply product endorsement by A2LA or any agency of the US Government.



6. SETUP OF EQUIPMENT UNDER TEST

6.1 SETUP CONFIGURATION OF EUT

See test photographs attached in Appendix I for the actual connections between EUT and support equipment.

6.2 SUPPORT EQUIPMENT

No	Equipment	Model	Serial No.	FCC ID	Trade Name	Power Cord
1.	NB	7663 (T61)	L3E9812	N/A	IBM	Unshielded, 1.8m with a core
2.	NB	Pavilion dv6	CNF9491GLJ	R33022	HP	Unshielded, 2.0m
3.	Mouse	OXN867	J0206CRS	R41108	DELL	N/A
4.	Printer	Stylus-C63	FAPY150360	R33126	EPSON	Unshielded, 1.8m
5.	HDD	My Passport	WX31A41A7211	D33015	WD	N/A

Remark:

1. *All the equipment/cables were placed in the worst-case configuration to maximize the emission during the test.*
2. *Grounding was established in accordance with the manufacturer's requirements and conditions for the intended use.*



7. FCC PART 15.249 REQUIREMENTS

7.1 20 DB BANDWIDTH

LIMIT

None; for reporting purposes only.

Test Configuration

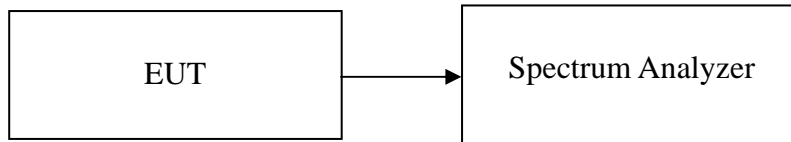

TEST PROCEDURE

1. Place the EUT on the table and set it in the transmitting mode.
2. Remove the antenna from the EUT and then connect a low loss RF cable from the antenna port to the spectrum analyzer.
3. Set the spectrum analyzer as RBW=10kHz, VBW = 30kHz, Span = 1MHz, Sweep = auto.
4. Mark the peak frequency and 20dB (upper and lower) frequency.
5. Repeat until all the rest channels are investigated.

TEST RESULTS

No non-compliance noted

Test Data

Channel	Frequency (MHz)	20dB Bandwidth (kHz)
Low	2410	112.893
Mid	2440	124.426
High	2470	130.797



Test Plot

CH Low

Agilent 11:13:38 Mar 23, 2013

R T

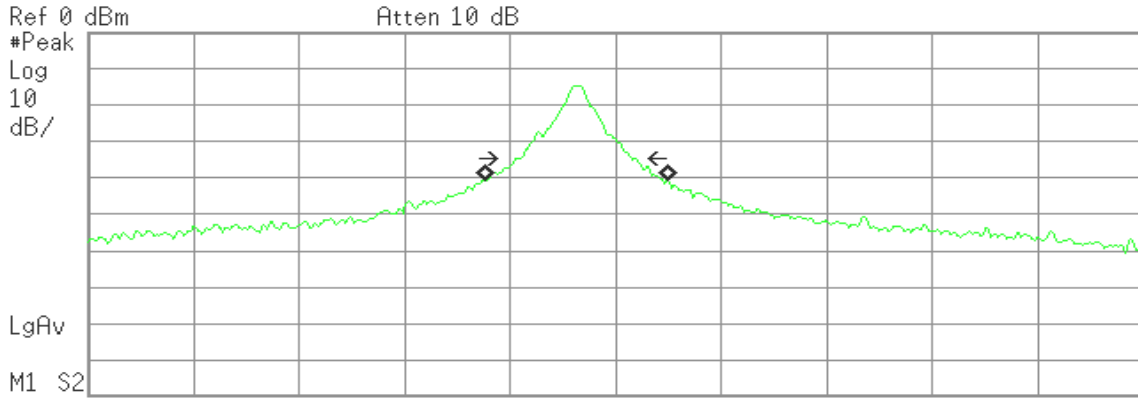

Occupied Bandwidth
176.8557 kHz

Occ BW % Pwr 99.00 %
x dB -20.00 dB

Transmit Freq Error -37.395 kHz
x dB Bandwidth 112.893 kHz

CH Mid

Agilent 11:24:00 Mar 23, 2013

R T

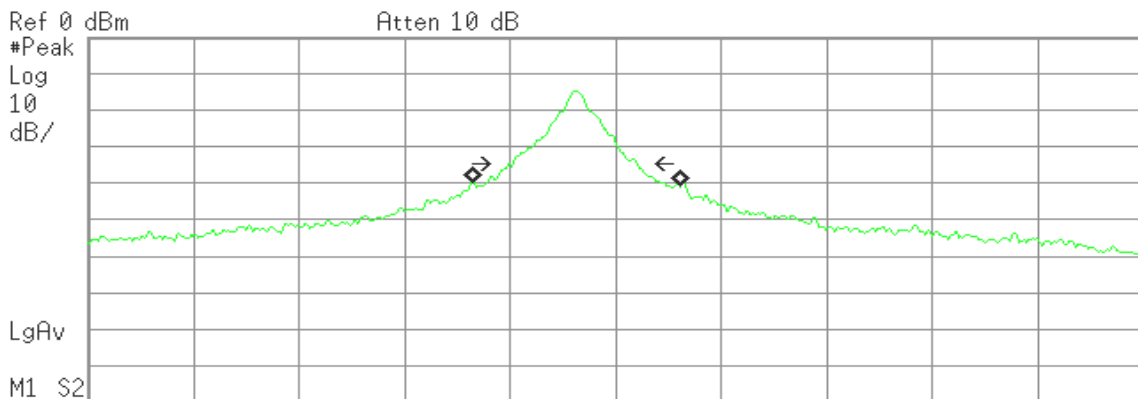

Occupied Bandwidth
200.2834 kHz

Occ BW % Pwr 99.00 %
x dB -20.00 dB

Transmit Freq Error -37.255 kHz
x dB Bandwidth 124.426 kHz



CH High

Agilent 11:26:49 Mar 23, 2013

R T

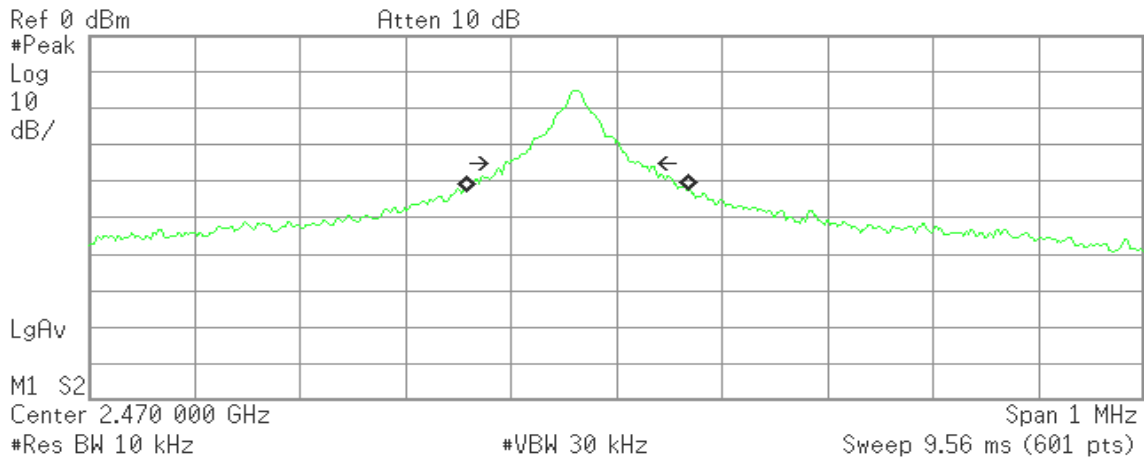

Occupied Bandwidth
212.6051 kHz

Occ BW % Pwr 99.00 %
x dB -20.00 dB

Transmit Freq Error -37.637 kHz
x dB Bandwidth 130.797 kHz



7.2 BAND EDGES MEASUREMENT

LIMIT

1. According to §15.209(a), except as provided elsewhere in this Subpart, the emissions from an intentional radiator shall not exceed the field strength levels specified in the following table:

Frequency (MHz)	Field Strength ($\mu\text{V/m}$)	Measurement Distance (m)
0.009 - 0.490	$2400/F(\text{kHz}) + 80$	$20\text{LOG}((240/F(\text{kHz}))+80)$
0.490 - 1.705	$24000/F(\text{kHz}) + 40$	$20\text{LOG}((2400/F(\text{kHz}))+40)$
1.705 – 30.0	70	36.9
30-88	100	40
88-216	150	43.5
216-960	200	46
Above 960	500	54

Remark: Except as provided in paragraph (g), fundamental emissions from intentional radiators operating under this Section shall not be located in the frequency bands 54-72 MHz, 76-88 MHz, 174-216 MHz or 470-806 MHz. However, operation within these frequency bands is permitted under other sections of this Part, e.g., Sections 15.231 and 15.241.

2. As shown in Section 15.35(b), for frequencies above 1000 MHz, the above field strength limits in paragraphs (a) and (b) of this section are based on average limits. However, the peak field strength of any emission shall not exceed the maximum permitted average limits specified above by more than 20 dB under any condition of modulation. For point-to-point operation under paragraph (b) of this section, the peak field strength shall not exceed 2500 millivolts/meter at 3 meters along the antenna azimuth.

Test Configuration

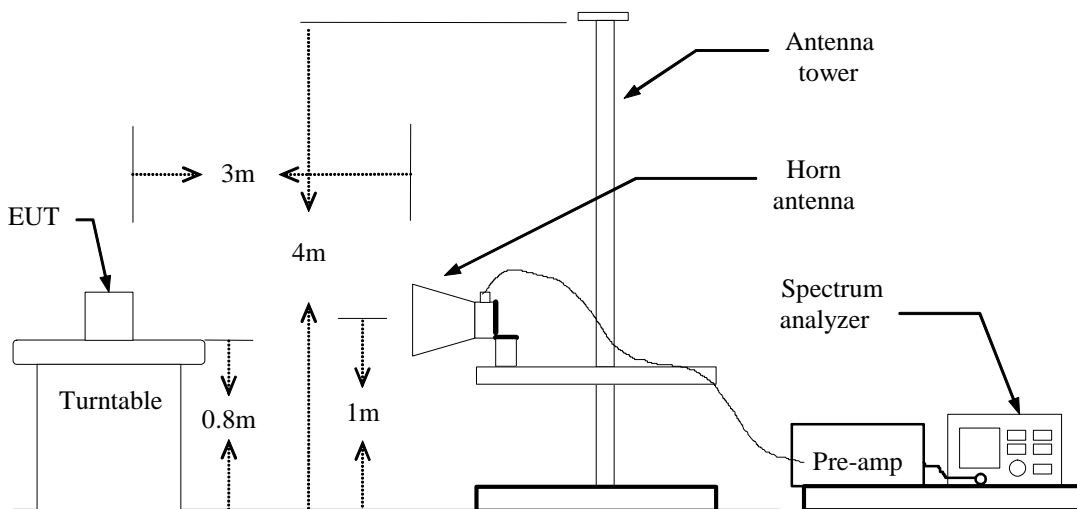



TEST PROCEDURE

1. The EUT is placed on a turntable, which is 0.8m above the ground plane.
2. The turntable shall be rotated for 360 degrees to determine the position of maximum emission level.
3. EUT is set 3m away from the receiving antenna, which is varied from 1m to 4m to find out the highest emission.
4. Set the spectrum analyzer in the following setting in order to capture the lower and upper band-edges of the emission:
 - (a) PEAK: RBW=1MHz ,VBW=3MHz,Sweep=100ms
 - (b) AVERAGE: RBW=1MHz / VBW=10Hz / Sweep=AUTO
5. Repeat the procedures until all the PEAK and AVERAGE versus POLARIZATION are measured.

TEST RESULTS

Refer to attach spectrum analyzer data chart.



Band Edges (CH Low)

Detector mode: Peak

Polarity: Vertical

Agilent

R T

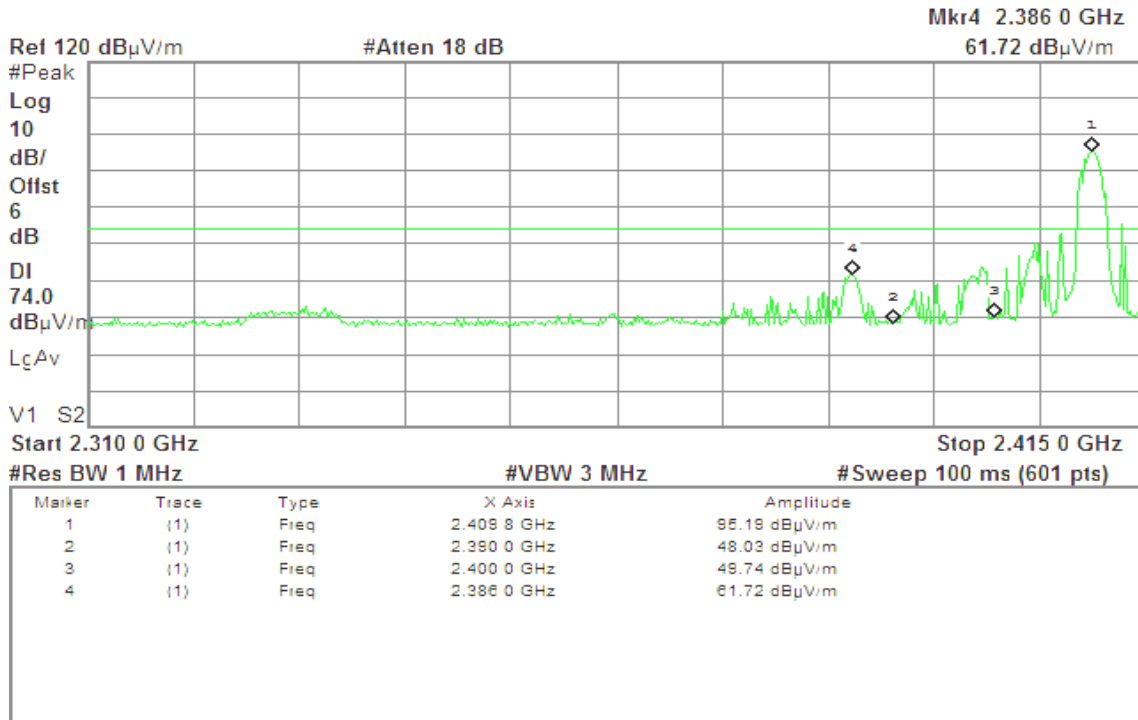

Detector mode: Average

Polarity: Vertical

Agilent

R T

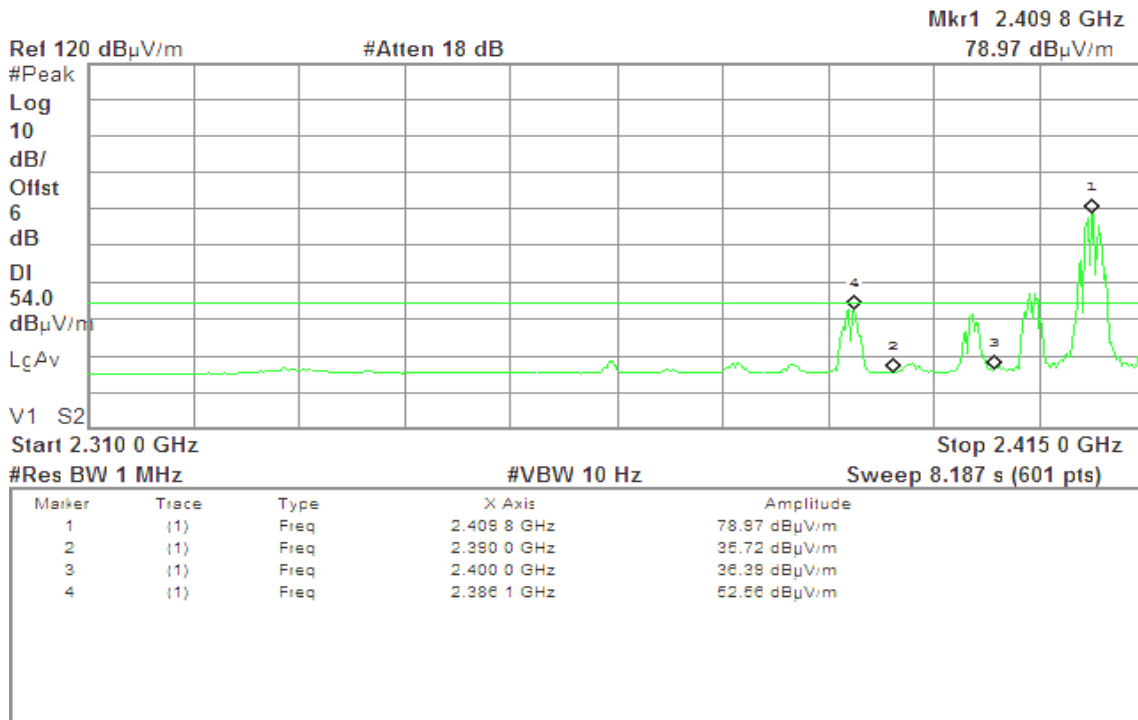



Detector mode: Peak

Polarity: Horizontal

Agilent

R T

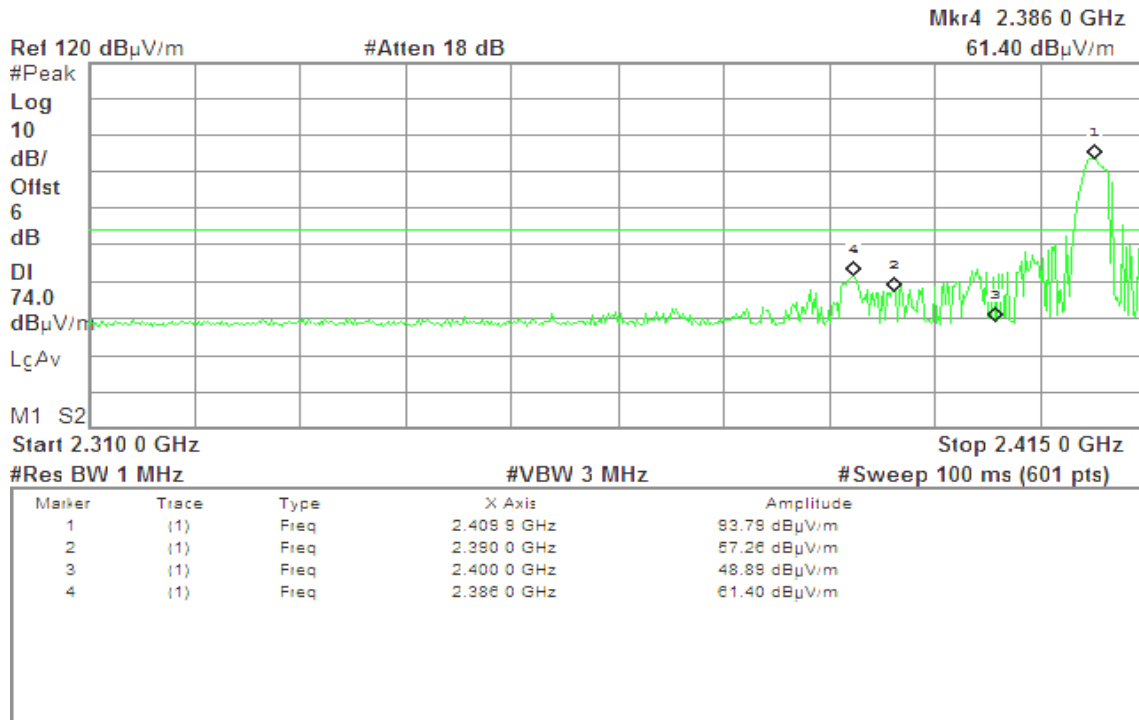

Detector mode: Average

Polarity: Horizontal

Agilent

R T

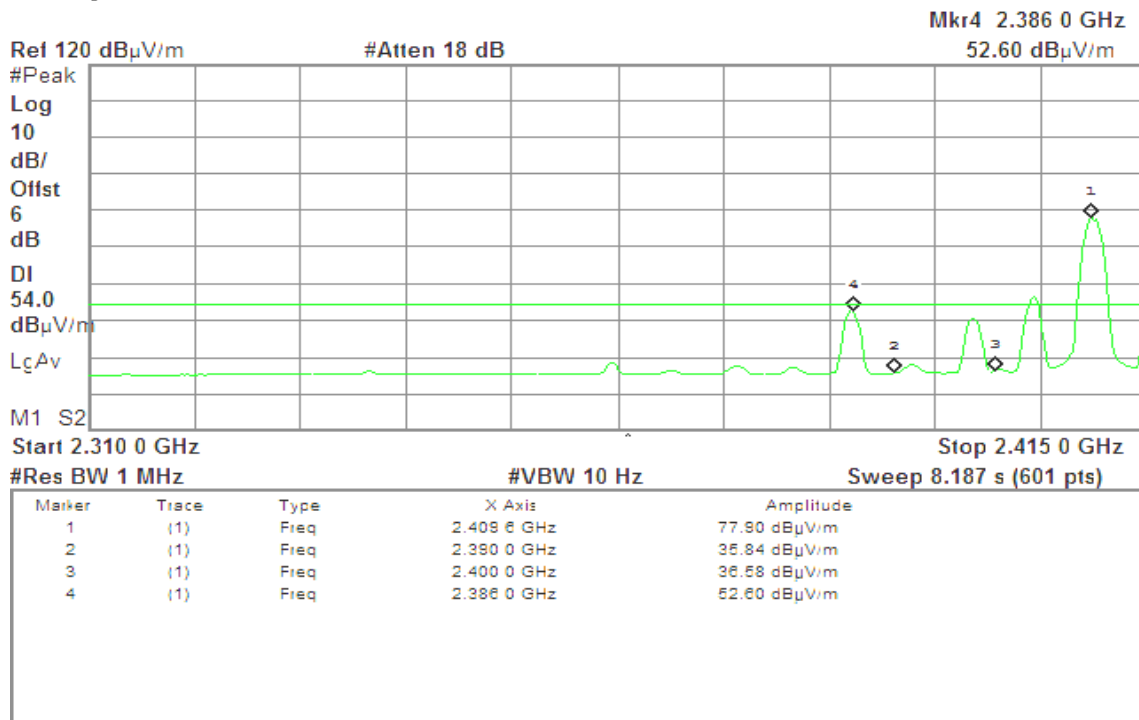



Band Edges (CH High)

Detector mode: Peak

Polarity: Vertical

Agilent

R T

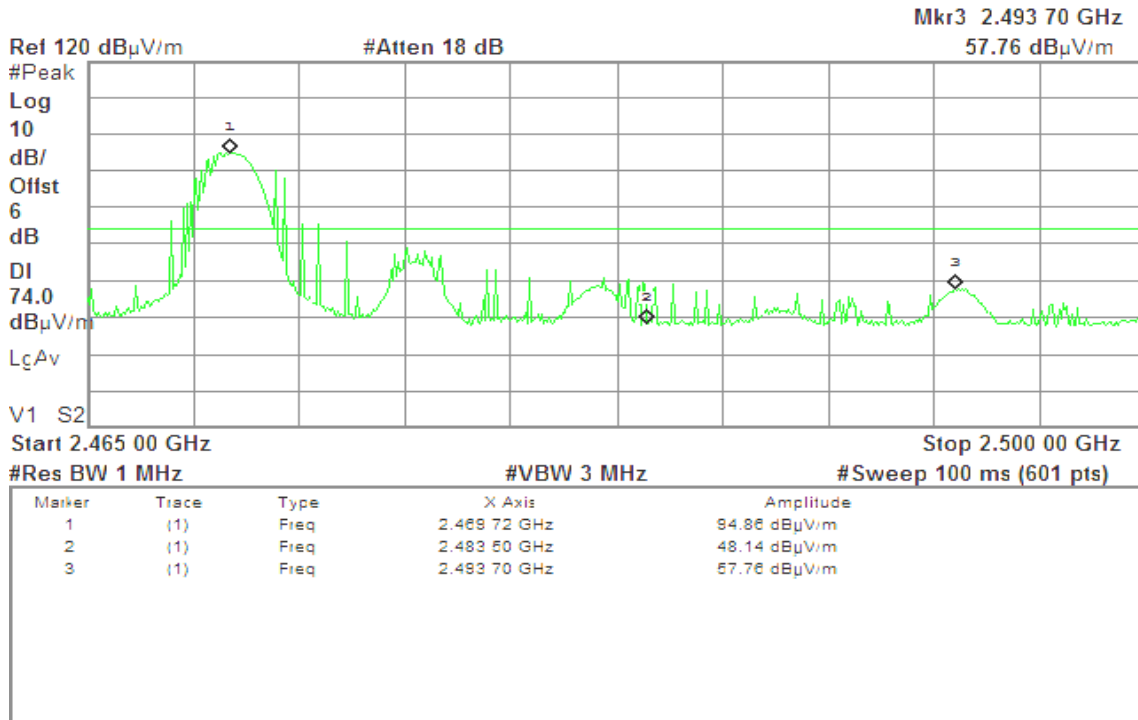

Detector mode: Average

Polarity: Vertical

Agilent

R T

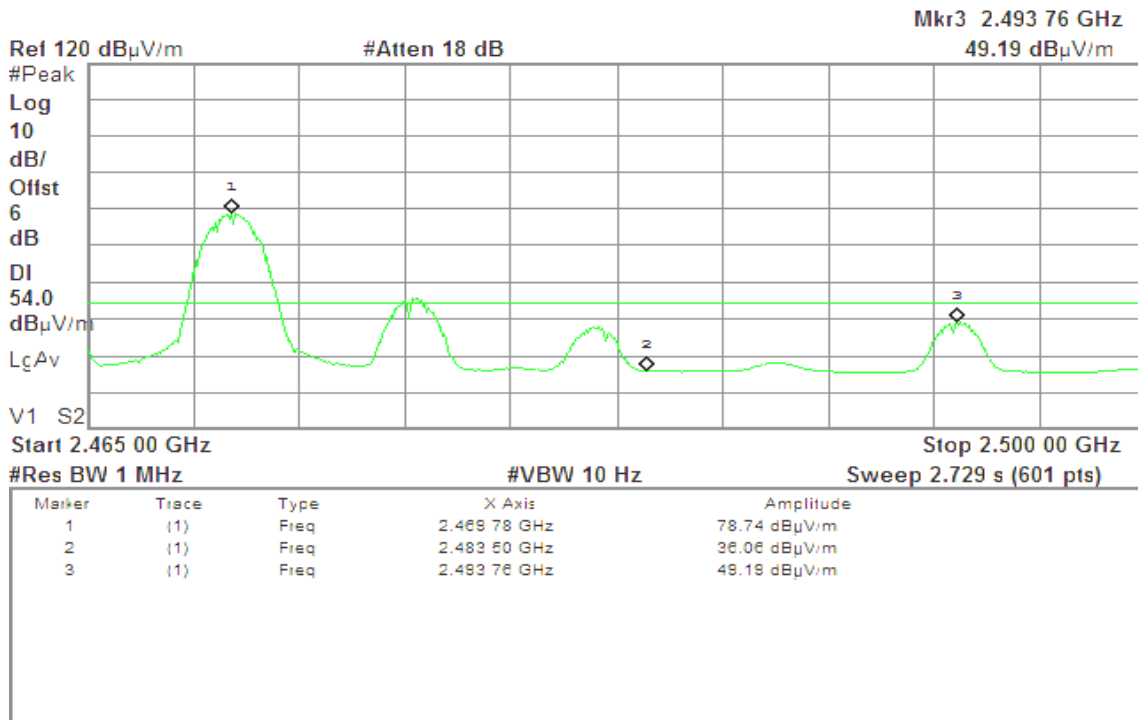



Detector mode: Peak

Polarity: Horizontal

Agilent

R T

Mkr3 2.493 88 GHz
57.09 dB μ V/m

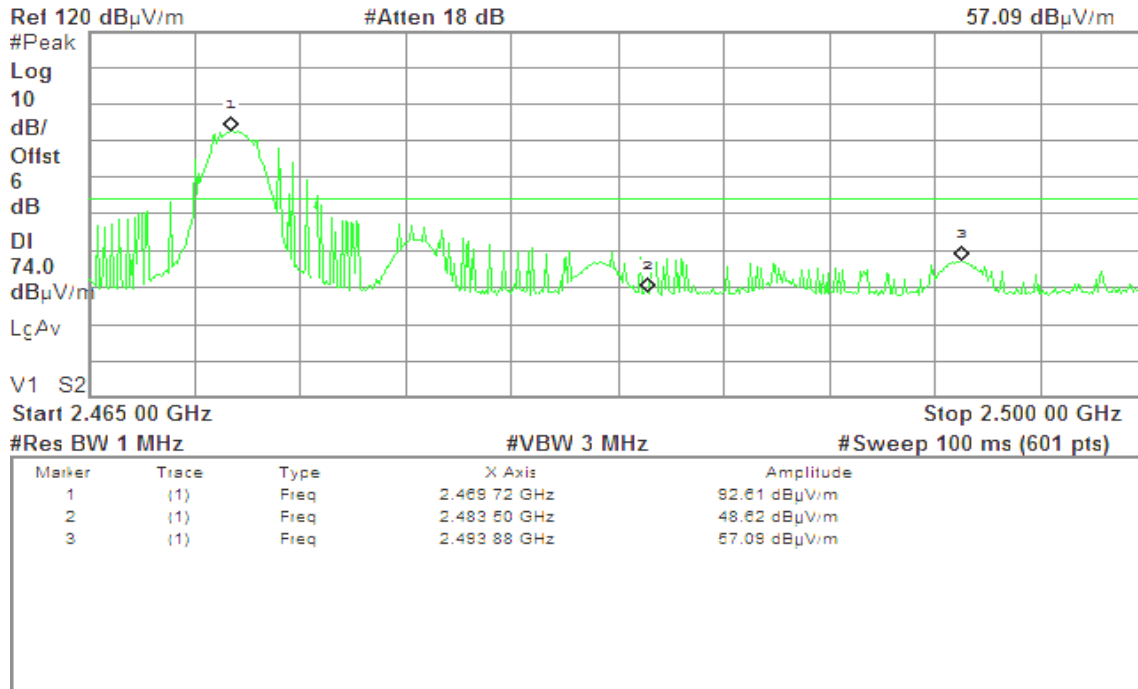

Detector mode: Average

Polarity: Horizontal

Agilent

R T

Mkr3 2.493 82 GHz
48.82 dB μ V/m

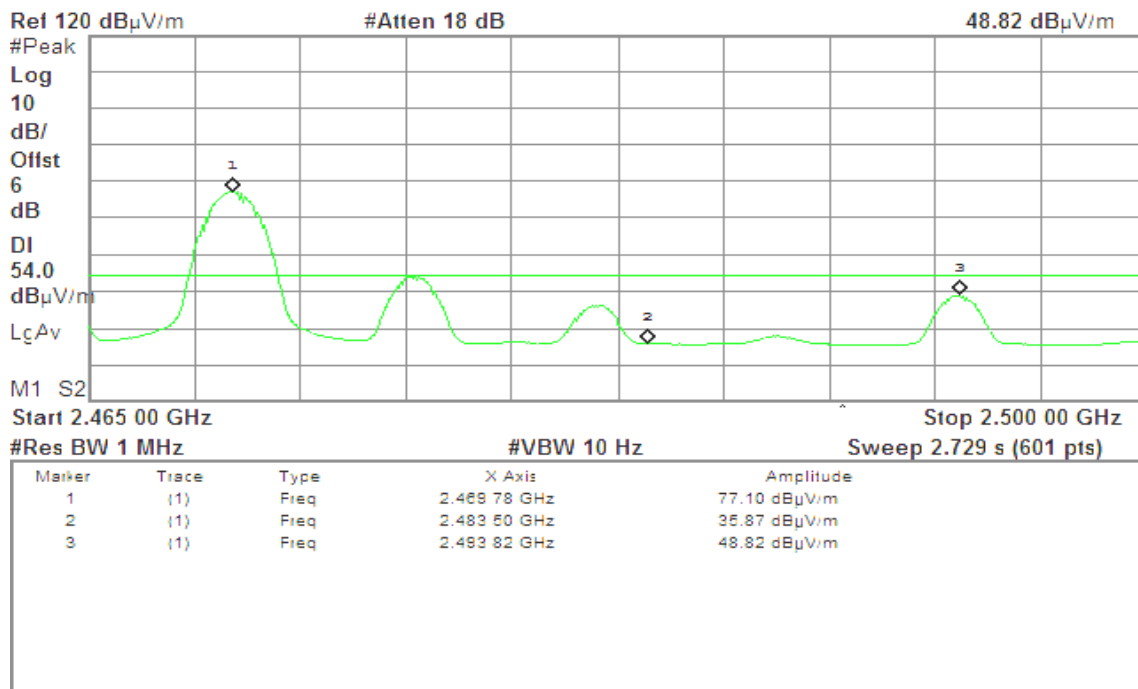



7.3 SPURIOUS EMISSION

LIMIT

1. In the section 15.249(a):

Except as provided in paragraph (b) of this section, the field strength of emissions from intentional radiators operated within these frequency bands shall comply with the following:

Fundamental Frequency (MHz)	Field Strength of Fundamental Field Strength (mV/m)	Field Strength of Harmonics (μ V/m)
902-928 MHz	50	500
2400 - 2483.5 MHz	50	500
5725 - 5875 MHz	50	500
24.0 - 24.25 GHz	250	2500

2. According to §15.209(a), except as provided elsewhere in this Subpart, the emissions from an intentional radiator shall not exceed the field strength levels specified in the following table:

Frequency (MHz)	Field Strength (μ V/m)	Measurement Distance (m)
0.009 - 0.490	$2400/F(\text{kHz}) + 80$	$20\text{LOG}((240/F(\text{kHz}))+80)$
0.490 - 1.705	$24000/F(\text{kHz}) + 40$	$20\text{LOG}((2400/F(\text{kHz}))+40)$
1.705 – 30.0	70	36.9
30-88	100	40
88-216	150	43.5
216-960	200	46
Above 960	500	54

Remark: Except as provided in paragraph (g), fundamental emissions from intentional radiators operating under this Section shall not be located in the frequency bands 54-72 MHz, 76-88 MHz, 174-216 MHz or 470-806 MHz. However, operation within these frequency bands is permitted under other sections of this Part, e.g., Sections 15.231 and 15.241.



Test Configuration

9kHz ~ 30MHz

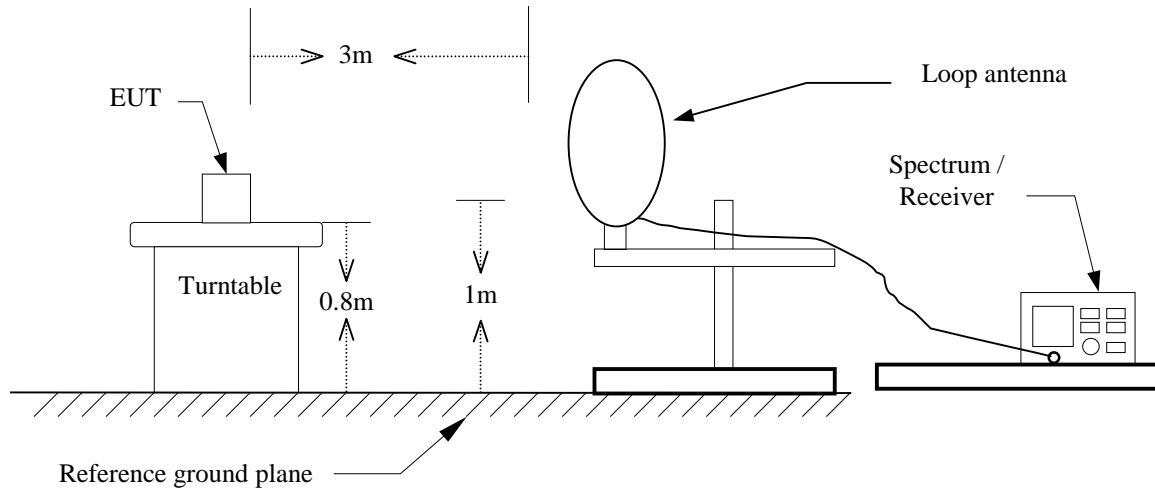

30MHz ~ 1GHz

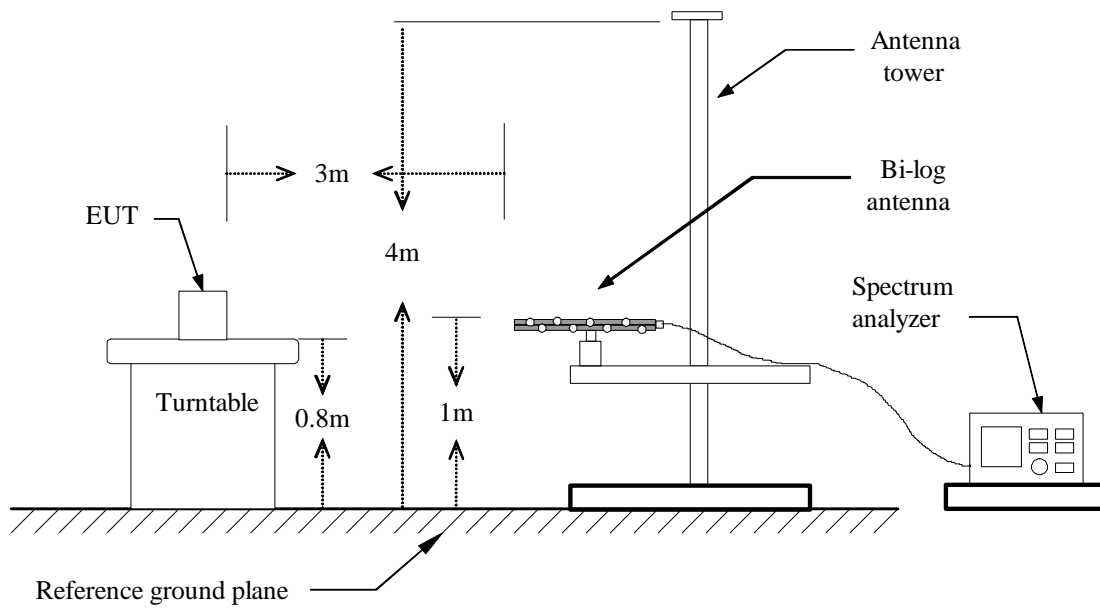



Above 1 GHz

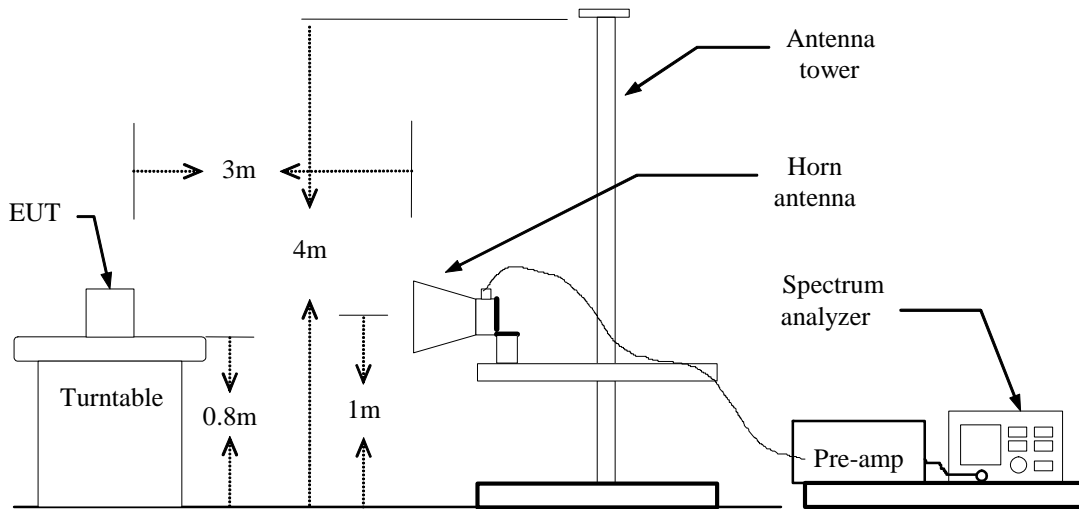



TEST PROCEDURE

1. The EUT is placed on a turntable, which is 0.8m above ground plane.
2. The turntable shall be rotated for 360 degrees to determine the position of maximum emission level.
3. EUT is set 3m away from the receiving antenna, which is varied from 1m to 4m to find out the highest emissions.
4. Maximum procedure was performed on the six highest emissions to ensure EUT compliance.
5. And also, each emission was to be maximized by changing the polarization of receiving antenna both horizontal and vertical.
6. Set the spectrum analyzer in the following setting as:
Below 1GHz:
RBW=100kHz / VBW=300kHz / Sweep=AUTO
Above 1GHz:
(a) PEAK: RBW=1MHz / VBW=3MHz / Sweep=AUTO
(b) AVERAGE: RBW=1MHz / VBW=10Hz / Sweep=AUTO
7. Repeat above procedures until the measurements for all frequencies are complete.



Below 1 GHz

Operation Mode: Normal Link

Test Date: March 21, 2013

Temperature: 27°C

Tested by: Shawn Wu

Humidity: 53% RH

Polarity: Ver. / Hor.

Frequency (MHz)	Reading (dBuV)	Correction Factor (dB/m)	Result (dBuV/m)	Limit 3m (dBuV/m)	Margin (dB)	Detector Mode (PK/QP)	Ant.Pol. (H/V)
31.6167	58.09	-21.64	36.45	40.00	-3.55	Peak	V
51.0167	66.10	-34.10	32.00	40.00	-8.00	Peak	V
299.9833	57.47	-27.73	29.74	46.00	-16.26	Peak	V
599.0667	58.21	-22.50	35.71	46.00	-10.29	Peak	V
624.9333	58.55	-21.60	36.95	46.00	-9.05	Peak	V
663.7333	54.73	-20.61	34.12	46.00	-11.88	Peak	V
249.8667	61.75	-29.65	32.10	46.00	-13.90	Peak	H
298.3667	66.32	-27.76	38.56	46.00	-7.44	Peak	H
332.3167	60.95	-26.97	33.98	46.00	-12.02	Peak	H
384.0500	56.89	-25.86	31.03	46.00	-14.97	Peak	H
624.9333	60.49	-21.60	38.89	46.00	-7.11	Peak	H
749.4167	56.71	-19.53	37.18	46.00	-8.82	Peak	H

Remark:

1. No emission found between lowest internal used/generated frequency to 30MHz (9kHz~30MHz).
2. Radiated emissions measured were made with an instrument using peak/quasi-peak detector mode.
3. Quasi-peak test would be performed if the peak result were greater than the quasi-peak limit or as required by the applicant.
4. Measurements above show only up to 6 maximum emissions noted, or would be lesser, with " N/A " remark, if no specific emissions from the EUT are recorded (ie: margin>20dB from the applicable limit) and considered that's already beyond the background noise floor.
5. $Margin (dB) = Remark\ result (dBuV/m) - Quasi-peak\ limit (dBuV/m).$

**Above 1 GHz****Operation Mode:** Tx / CH Low**Test Date:** March 6, 2013**Temperature:** 27°C**Tested by:** Shawn Wu**Humidity:** 53% RH**Polarity:** Ver. / Hor.

Frequency (MHz)	Reading (dBuV)	Correction Factor (dB/m)	Result (dBuV/m)	Limit (dBuV/m)	Margin (dB)	Remark	Ant.Pol. (H/V)
2410.000	109.85	-14.44	95.41	114.00	-18.59	peak	V
2410.000	93.47	-14.44	79.03	94.00	-14.97	AVG	V
4816.667	64.26	-8.67	55.59	74.00	-18.41	peak	V
4816.667	56.98	-8.67	48.31	54.00	-5.69	AVG	V
7233.333	61.54	-4.38	57.16	74.00	-16.84	peak	V
7233.333	54.97	-4.38	50.59	54.00	-3.41	AVG	V
2410.000	108.49	-14.44	94.05	114.00	-19.95	peak	H
2410.000	92.52	-14.44	78.08	94.00	-15.92	AVG	H
1330.000	70.45	-20.36	50.09	74.00	-23.91	peak	H
1460.000	70.03	-20.15	49.88	74.00	-24.12	peak	H
4816.667	66.19	-8.67	57.52	74.00	-16.48	peak	H
4816.667	59.84	-8.67	51.17	54.00	-2.83	AVG	H

Remark:

1. Measuring frequencies from 1 GHz to the 10th harmonic of highest fundamental frequency.
2. Radiated emissions measured in frequency above 1000MHz were made with an instrument using peak/average detector mode.
3. Average test would be performed if the peak result were greater than the average limit or as required by the applicant.
4. Data of measurement within this frequency range shown " --- " in the table above means the reading of emissions are attenuated more than 20dB below the permissible limits or the field strength is too small to be measured.
5. Measurements above show only up to 6 maximum emissions noted, or would be lesser, with " N/A " remark, if no specific emissions from the EUT are recorded (ie: margin>20dB from the applicable limit) and considered that's already beyond the background noise floor.
6. Margin (dB) = Result (dBuV/m) - limit (dBuV/m).



Operation Mode: Tx / CH Mid

Test Date: March 6, 2013

Temperature: 27°C

Tested by: Shawn Wu

Humidity: 53% RH

Polarity: Ver. / Hor.

Frequency (MHz)	Reading (dBuV)	Correction Factor (dB/m)	Result (dBuV/m)	Limit (dBuV/m)	Margin (dB)	Remark	Ant.Pol. (H/V)
2440.000	110.36	-14.37	95.99	114.00	-18.01	peak	V
2440.000	93.70	-14.37	79.33	94.00	-14.67	AVG	V
4883.333	62.22	-8.50	53.72	74.00	-20.28	peak	V
4883.333	55.91	-8.50	47.41	54.00	-6.59	AVG	V
7316.667	60.66	-4.30	56.36	74.00	-17.64	peak	V
7316.667	55.00	-4.30	50.70	54.00	-3.30	AVG	V
2440.000	107.33	-14.37	92.96	114.00	-21.04	peak	H
2440.000	91.65	-14.37	77.28	94.00	-16.72	AVG	H
1330.000	70.26	-20.36	49.90	74.00	-24.10	peak	H
4883.333	67.52	-8.50	59.02	74.00	-14.98	peak	H
4883.333	60.20	-8.50	51.70	54.00	-2.30	AVG	H
7316.667	56.11	-4.30	51.81	74.00	-22.19	peak	H

Remark:

1. Measuring frequencies from 1 GHz to the 10th harmonic of highest fundamental frequency.
2. Radiated emissions measured in frequency above 1000MHz were made with an instrument using peak/average detector mode.
3. Average test would be performed if the peak result were greater than the average limit or as required by the applicant.
4. Data of measurement within this frequency range shown " --- " in the table above means the reading of emissions are attenuated more than 20dB below the permissible limits or the field strength is too small to be measured.
5. Measurements above show only up to 6 maximum emissions noted, or would be lesser, with " N/A " remark, if no specific emissions from the EUT are recorded (ie: margin>20dB from the applicable limit) and considered that's already beyond the background noise floor.
6. Margin (dB) = Result (dBuV/m) - limit (dBuV/m).

**Operation Mode:** Tx / CH High**Test Date:** March 6, 2013**Temperature:** 27°C**Tested by:** Shawn Wu**Humidity:** 53% RH**Polarity:** Ver. / Hor.

Frequency (MHz)	Reading (dBuV)	Correction Factor (dB/m)	Result (dBuV/m)	Limit (dBuV/m)	Margin (dB)	Remark	Ant.Pol. (H/V)
2470.000	109.50	-14.30	95.20	114.00	-18.80	peak	V
2470.000	93.04	-14.30	78.74	94.00	-15.26	AVG	V
4941.667	60.78	-8.35	52.43	74.00	-21.57	peak	V
4941.667	53.73	-8.35	45.38	54.00	-8.62	AVG	V
7408.333	56.74	-4.22	52.52	74.00	-21.48	peak	V
7408.333	53.03	-4.22	48.81	54.00	-5.19	AVG	V
2470.000	107.06	-14.30	92.76	114.00	-21.24	peak	H
2470.000	91.40	-14.30	77.10	94.00	-16.90	AVG	H
4941.667	68.01	-8.35	59.66	74.00	-14.34	peak	H
4941.667	60.59	-8.35	52.24	54.00	-1.76	AVG	H
7408.333	57.71	-4.22	53.49	74.00	-20.51	peak	H
7408.333	51.15	-4.22	46.93	54.00	-7.07	AVG	H

Remark:

1. Measuring frequencies from 1 GHz to the 10th harmonic of highest fundamental frequency.
2. Radiated emissions measured in frequency above 1000MHz were made with an instrument using peak/average detector mode.
3. Average test would be performed if the peak result were greater than the average limit or as required by the applicant.
4. Data of measurement within this frequency range shown " --- " in the table above means the reading of emissions are attenuated more than 20dB below the permissible limits or the field strength is too small to be measured.
5. Measurements above show only up to 6 maximum emissions noted, or would be lesser, with " N/A " remark, if no specific emissions from the EUT are recorded (ie: margin>20dB from the applicable limit) and considered that's already beyond the background noise floor.
6. $Margin (dB) = Result (dBuV/m) - limit (dBuV/m)$.



7.4 POWERLINE CONDUCTED EMISSIONS

LIMIT

According to §15.207(a), except as shown in paragraphs (b) and (c) of this section, for an intentional radiator that is designed to be connected to the public utility (AC) power line, the radio frequency voltage that is conducted back onto the AC power line on any frequency or frequencies within the band 150 kHz to 30 MHz shall not exceed the limits in the following table, as measured using a 50 μ H/50 ohms line impedance stabilization network (LISN). Compliance with the provisions of this paragraph shall be based on the measurement of the radio frequency voltage between each power line and ground at the power terminal. The lower limit applies at the boundary between the frequency ranges.

Frequency Range (MHz)	Limits (dB μ V)	
	Quasi-peak	Average
0.15 to 0.50	66 to 56*	56 to 46*
0.50 to 5	56	46
5 to 30	60	50

* Decreases with the logarithm of the frequency.

Test Configuration

See test photographs attached in Appendix I for the actual connections between EUT and support equipment.

TEST PROCEDURE

1. The EUT was placed on a table, which is 0.8m above ground plane.
2. Maximum procedure was performed on the six highest emissions to ensure EUT compliance.
3. Repeat above procedures until all frequency measured were complete.



TEST RESULTS

The initial step in collecting conducted data is a spectrum analyzer peak scan of the measurement range. Significant peaks are then marked as shown on the following data page, and these signals are then quasi-peaked.

Test Data

Operation Mode: Normal Link

Test Date: January 3, 2013

Temperature: 20.2°C

Tested by: Peter Chang

Humidity: 68 % RH

Freq. (MHz)	QP Reading (dBuV)	AV Reading (dBuV)	Corr. factor (dB)	QP Result (dBuV)	AV Result (dBuV)	QP Limit (dBuV)	AV Limit (dBuV)	QP Margin (dB)	AV Margin (dB)	Note
0.1580	31.14	16.12	9.87	41.01	25.99	65.57	55.57	-24.56	-29.58	L1
0.2694	30.84	25.22	9.88	40.72	35.10	61.14	51.14	-20.42	-16.04	L1
0.4052	32.89	31.65	9.88	42.77	41.53	57.75	47.75	-14.98	-6.22	L1
0.4832	12.20	5.60	9.88	22.08	15.48	56.28	46.28	-34.20	-30.80	L1
4.5177	16.32	8.48	10.03	26.35	18.51	56.00	46.00	-29.65	-27.49	L1
6.2995	19.74	11.75	10.08	29.82	21.83	60.00	50.00	-30.18	-28.17	L1
0.1857	30.19	24.70	9.64	39.83	34.34	64.23	54.23	-24.40	-19.89	L2
0.2740	25.63	19.80	9.65	35.28	29.45	61.00	51.00	-25.72	-21.55	L2
0.3620	30.59	28.49	9.66	40.25	38.15	58.68	48.68	-18.43	-10.53	L2
0.4540	30.11	28.09	9.66	39.77	37.75	56.80	46.80	-17.03	-9.05	L2
1.2179	23.12	18.31	9.70	32.82	28.01	56.00	46.00	-23.18	-17.99	L2
3.6946	22.57	13.67	9.79	32.36	23.46	56.00	46.00	-23.64	-22.54	L2

Remark:

1. Measuring frequencies from 0.15 MHz to 30MHz.
2. The emissions measured in frequency range from 0.15 MHz to 30MHz were made with an instrument using Quasi-peak detector and average detector.
3. The IF bandwidth of SPN between 0.15MHz to 30MHz was 10kHz; the IF bandwidth of Test Receiver between 0.15MHz to 30MHz was 9kHz;
4. L1 = Line One (Live Line) / L2 = Line Two (Neutral Line)
5. "-" means Quasi-peak reading value also meets average limit and measurement with the average detector is unnecessary.



Test Plots

Conducted emissions (Line 1)

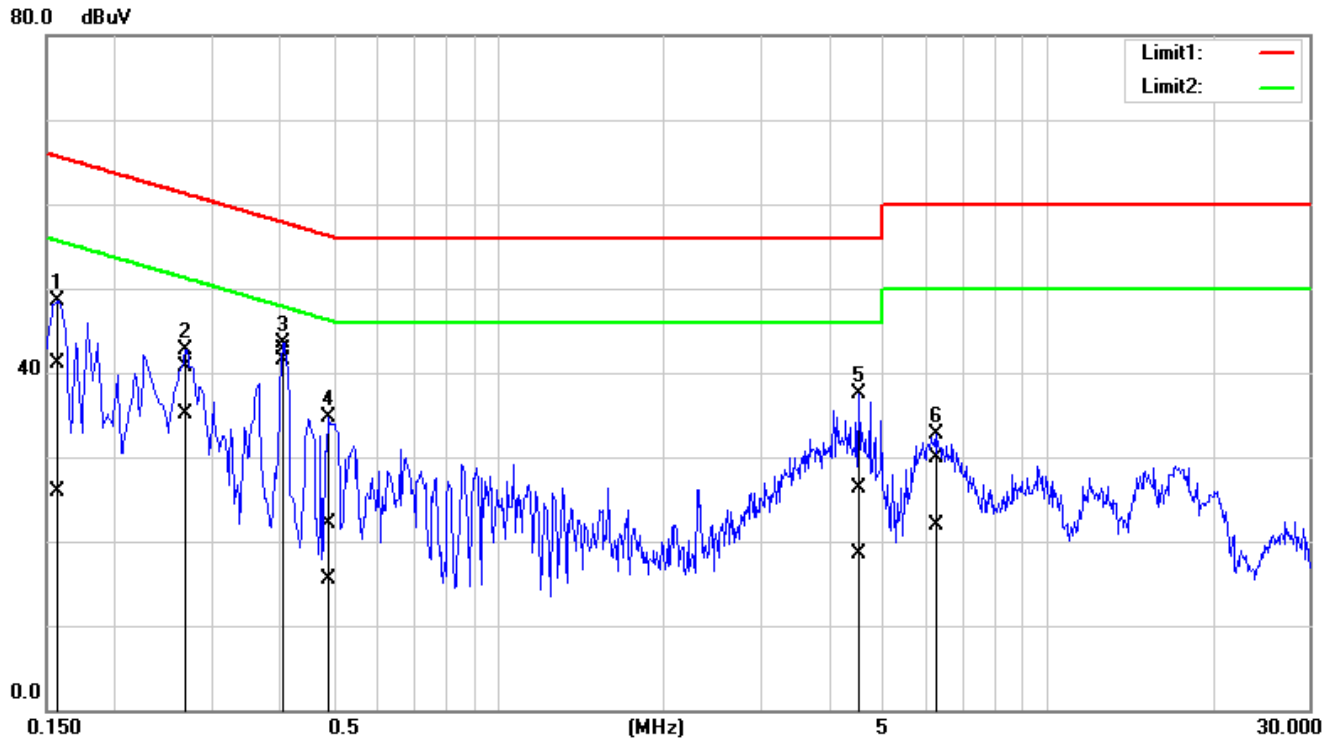

Conducted emissions (Line 2)

