



FCC TEST REPORT

REPORT NO.: RF921231R02

MODEL NO.: ZW9

RECEIVED: Dec. 31, 2003

TESTED: Jan. 01 ~ Jan. 02, 2004

APPLICANT: Quanta Computer Inc.

ADDRESS: 7F, 116, Hou Kang St., Shih Lin, Taipei, Taiwan,
R.O.C.

ISSUED BY: Advance Data Technology Corporation

LAB LOCATION: 47 14th Lin, Chiapau Tsun, Linko, Taipei,
Taiwan, R.O.C.

This test report consists of 49 pages in total. It may be duplicated completely for legal use with the approval of the applicant. It should not be reproduced except in full, without the written approval of our laboratory. The client should not use it to claim product endorsement by CNLA, NVLAP or any government agencies. The test results in the report only apply to the tested sample.



0528
ILAC MRA



Lab Code: 200102-0



Table of Contents

1	CERTIFICATION	4
2	SUMMARY OF TEST RESULTS	5
3	GENERAL INFORMATION	6
3.1	GENERAL DESCRIPTION OF EUT	6
3.2	DESCRIPTION OF TEST MODES	7
3.3	GENERAL DESCRIPTION OF APPLIED STANDARDS	7
3.4	DESCRIPTION OF SUPPORT UNITS	8
4	TEST TYPES AND RESULTS	9
4.1	CONDUCTED EMISSION MEASUREMENT	9
4.1.1	LIMITS OF CONDUCTED EMISSION MEASUREMENT	9
4.1.2	TEST INSTRUMENTS	9
4.1.3	TEST PROCEDURES	10
4.1.4	TEST SETUP	10
4.1.5	EUT OPERATING CONDITIONS	11
4.1.6	TEST RESULTS	12
4.2	RADIATED EMISSION MEASUREMENT	18
4.2.1	LIMITS OF RADIATED EMISSION MEASUREMENT	18
4.2.2	TEST INSTRUMENTS	19
4.2.3	TEST PROCEDURES	20
4.2.4	TEST SETUP	21
4.2.5	EUT OPERATING CONDITIONS	21
4.2.6	TEST RESULTS	22
4.3	6dB BANDWIDTH MEASUREMENT	27
4.3.1	LIMITS OF 6dB BANDWIDTH MEASUREMENT	27
4.3.2	TEST INSTRUMENTS	27
4.3.3	TEST PROCEDURE	28
4.3.4	TEST SETUP	28
4.3.5	EUT OPERATING CONDITIONS	28
4.3.6	TEST RESULTS	29
4.4	MAXIMUM PEAK OUTPUT POWER	33
4.4.1	LIMITS OF MAXIMUM PEAK OUTPUT POWER MEASUREMENT	33
4.4.2	TEST INSTRUMENTS	33
4.4.3	TEST PROCEDURES	34
4.4.4	TEST SETUP	34
4.4.5	EUT OPERATING CONDITIONS	34



4.4.6	TEST RESULTS.....	35
4.5	POWER SPECTRAL DENSITY MEASUREMENT.....	36
4.5.1	LIMITS OF POWER SPECTRAL DENSITY MEASUREMENT	36
4.5.2	TEST INSTRUMENTS	36
4.5.3	TEST PROCEDURE	37
4.5.4	TEST SETUP	37
4.5.5	EUT OPERATING CONDITIONS.....	37
4.5.6	TEST RESULTS.....	38
4.6	BAND EDGES MEASUREMENT	42
4.6.1	LIMITS OF BAND EDGES MEASUREMENT	42
4.6.2	TEST INSTRUMENTS	42
4.6.3	TEST PROCEDURE	42
4.6.4	EUT OPERATING CONDITION	42
4.6.5	TEST RESULTS.....	43
4.7	ANTENNA REQUIREMENT	46
4.7.1	STANDARD APPLICABLE	46
4.7.2	ANTENNA CONNECTED CONSTRUCTION.....	46
5	PHOTOGRAPHS OF THE TEST CONFIGURATION.....	47
6	INFORMATION ON THE TESTING LABORATORIES	49



1 CERTIFICATION

PRODUCT : NoteBook
MODEL NO. : ZW9
BRAND : Quanta
TEST ITEM: R&D Sample
APPLICANT : Quanta Computer Inc.
STANDARDS : FCC Part 15, Subpart C (Section 15.247),
ANSI C63.4-1992

We, **Advance Data Technology Corporation**, hereby certify that one sample of the designation has been tested in our facility from Jan. 01 to Jan. 02, 2004. The test record, data evaluation and Equipment Under Test (EUT) configurations represented herein are true and accurate accounts of the measurements of the sample's EMC characteristics under the conditions herein specified.

PREPARED BY: Windy Chou, **DATE:** Jan. 05, 2004

APPROVED BY: Ellis Wu, **DATE:** Jan. 05, 2004

Ellis Wu, Manager



2 SUMMARY OF TEST RESULTS

The EUT has been tested according to the following specifications:

APPLIED STANDARD: FCC Part 15, Subpart C			
Standard Section	Test Type and Limit	Result	REMARK
15.207	AC Power Conducted Emission	PASS	Meet the requirement of limit Minimum passing margin is -17.32dB at 0.154MHz
15.247(a)(2)	Spectrum Bandwidth of a Direct Sequence Spread Spectrum System Limit: min. 500kHz	PASS	Meet the requirement of limit
15.247(b)	Maximum Peak Output Power Limit: max. 30dBm	PASS	Meet the requirement of limit
15.247(c)	Transmitter Radiated Emissions Limit: Table 15.209	PASS	Meet the requirement of limit Minimum passing margin is -0.78dB at 454.74MHz
15.247(d)	Power Spectral Density Limit: max. 8dBm	PASS	Meet the requirement of limit
15.247(c)	Band Edge Measurement Limit: 20 dB less than the peak value of fundamental frequency	PASS	Meet the requirement of limit

NOTE: The information of measurement uncertainty is available upon the customer's request.



3 GENERAL INFORMATION

3.1 GENERAL DESCRIPTION OF EUT

PRODUCT	NoteBook
MODEL NO.	ZW9
POWER SUPPLY	19Vdc from AC adapter
MODULATION TYPE	BPSK, QPSK, CCK
RADIO TECHNOLOGY	DSSS
TRANSFER RATE	1/2/5.5/11Mbps
FREQUENCY RANGE	2412MHz ~ 2462MHz
NUMBER OF CHANNEL	11
OUTPUT POWER	16.2dBm
ANTENNA TYPE	Monopole
ANTENNA GAIN	0.08dBi for Main antenna -0.79dBi for Auxiliary antenna
DATA CABLE	NA
I/O PORTS	NA
ASSOCIATED DEVICES	NA

NOTE:

1. The mini PCI card, which brand is Intel and the model name is WM3B2100, is specified to this EUT.
2. The EUT is powered by the following adapter:

BRAND :	LITEON
MODEL :	PA-1750-01
INPUT :	100-240Vac, 2.3A, 50-60Hz
OUTPUT :	19Vdc, 3.95A

3. For more detailed features description, please refer to the manufacturer's specifications or User's Manual.



3.2 DESCRIPTION OF TEST MODES

Eleven channels are provided to this EUT.

Channel	Frequency	Channel	Frequency
1	2412 MHz	7	2442 MHz
2	2417 MHz	8	2447 MHz
3	2422 MHz	9	2452 MHz
4	2427 MHz	10	2457 MHz
5	2432 MHz	11	2462 MHz
6	2437 MHz		

NOTE:

1. Below 1 GHz, the channel 1, 6, and 11 were pre-tested in chamber. The channel 11, worst case one, was chosen for final test.
2. Above 1 GHz, the channel 1, 6, and 11 were tested individually.
3. Data rate 11Mbps, the worst case, was chosen for final test.
4. Diversity function was provided to this EUT. Monopole with 0.08dBi antenna gain, the worse case, was chosen for final test.

3.3 GENERAL DESCRIPTION OF APPLIED STANDARDS

The EUT is a NoteBook. According to the specifications of the manufacturer, it must comply with the requirements of the following standards:

FCC Part 15, Subpart C. (15.247)

ANSI C63.4 : 1992

All test items have been performed and recorded as per the above standards.

NOTE: The EUT is also considered as a kind of computer peripheral, because the connection to computer is necessary for typical use. It has been verified to comply with the requirements of FCC Part 15, Subpart B, Class B (DoC). The test report has been issued separately.



3.4 DESCRIPTION OF SUPPORT UNITS

The EUT has been tested as an independent unit together with other necessary accessories or support units. The following support units or accessories were used to form a representative test configuration during the tests.

NO.	PRODUCT	BRAND	MODEL NO.	SERIAL NO.	FCC ID
1	600Ω Load	NA	NA	NA	NA
2	PRINTER	EPSON	EPSON	DCGY017058	FCC DoC Approved

NO.	SIGNAL CABLE DESCRIPTION OF THE ABOVE SUPPORT UNITS
1	NA
2	1.2m braid shielded wire, terminated with DB25 and Centronics connector via metallic frame, w/o core.

NOTE: All power cords of the above support units are non shielded (1.8m).

3.5 CONFIGURATION OF SYSTEM UNDER TEST

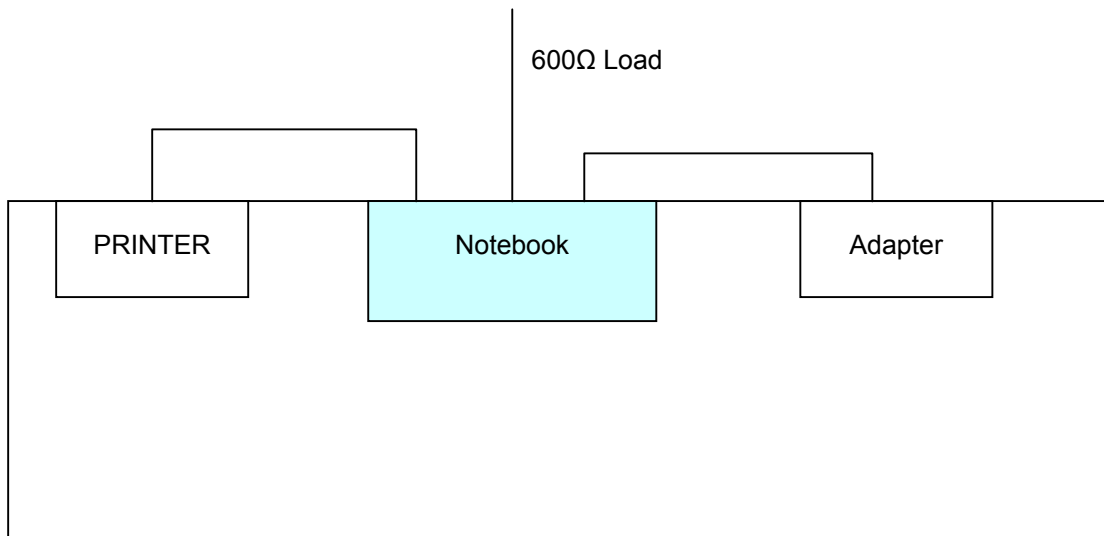



4 TEST TYPES AND RESULTS

4.1 CONDUCTED EMISSION MEASUREMENT

4.1.1 LIMITS OF CONDUCTED EMISSION MEASUREMENT

FREQUENCY OF EMISSION (MHz)	CONDUCTED LIMIT (dB μ V)	
	Quasi-peak	Average
0.15-0.5	66 to 56	56 to 46
0.5-5	56	46
5-30	60	50

- NOTE:**
1. The lower limit shall apply at the transition frequencies.
 2. The limit decreases in line with the logarithm of the frequency in the range of 0.15 to 0.50 MHz.
 3. All emanations from a class A/B digital device or system, including any network of conductors and apparatus connected thereto, shall not exceed the level of field strengths specified above.

4.1.2 TEST INSTRUMENTS

DESCRIPTION & MANUFACTURER	MODEL NO.	SERIAL NO.	CALIBRATED UNTIL
ROHDE & SCHWARZ Test Receiver	ESCS 30	838251/021	Jan. 20, 2004
ROHDE & SCHWARZ Artificial Mains Network (for EUT)	ESH3-Z5	100218	Dec. 09, 2004
ROHDE & SCHWARZ Artificial Mains Network (for peripherals)	ESH3-Z5	100219	Dec. 09, 2004
ROHDE & SCHWARZ Artificial Mains Network (for peripherals)	ESH3-Z5	100220	Dec. 09, 2004
*ROHDE & SCHWARZ 4-wire ISN	ENY41	837032/016	Nov. 19, 2004
*ROHDE & SCHWARZ 2-wire ISN	ENY22	837497/016	Nov. 19, 2004
Software	Cond-V2M3	NA	NA
RF cable (JYEBAO)	5D-FB	Cable-C10.01	May 01, 2004
SUHNER Terminator (For ROHDE & SCHWARZ LISN)	65BNC-5001	E1-010770	Mar. 24, 2004
SUHNER Terminator (For ROHDE & SCHWARZ LISN)	65BNC-5001	E1-010773	Apr. 06, 2004

- NOTE:**
1. The calibration interval of the above test instruments is 12 months and the calibrations are traceable to NML/ROC and NIST/USA.
 2. “*”: These equipment are used for conducted telecom port test only (if tested).
 3. The test was performed in ADT Shielded Room No. 10.
 4. The VCCI Site Registration No. is C-1312.

4.1.3 TEST PROCEDURES

- The EUT was placed 0.4 meters from the conducting wall of the shielded room with EUT being connected to the power mains through a line impedance stabilization network (LISN). Other support units were connected to the power mains through another LISN. The two LISNs provide 50 ohm/ 50uH of coupling impedance for the measuring instrument.
- Both lines of the power mains connected to the EUT were checked for maximum conducted interference.
- The frequency range from 150 kHz to 30 MHz was searched. Emission levels over 10dB under the prescribed limits could not be reported

4.1.4 DEVIATION FROM TEST STANDARD

No deviation

4.1.5 TEST SETUP

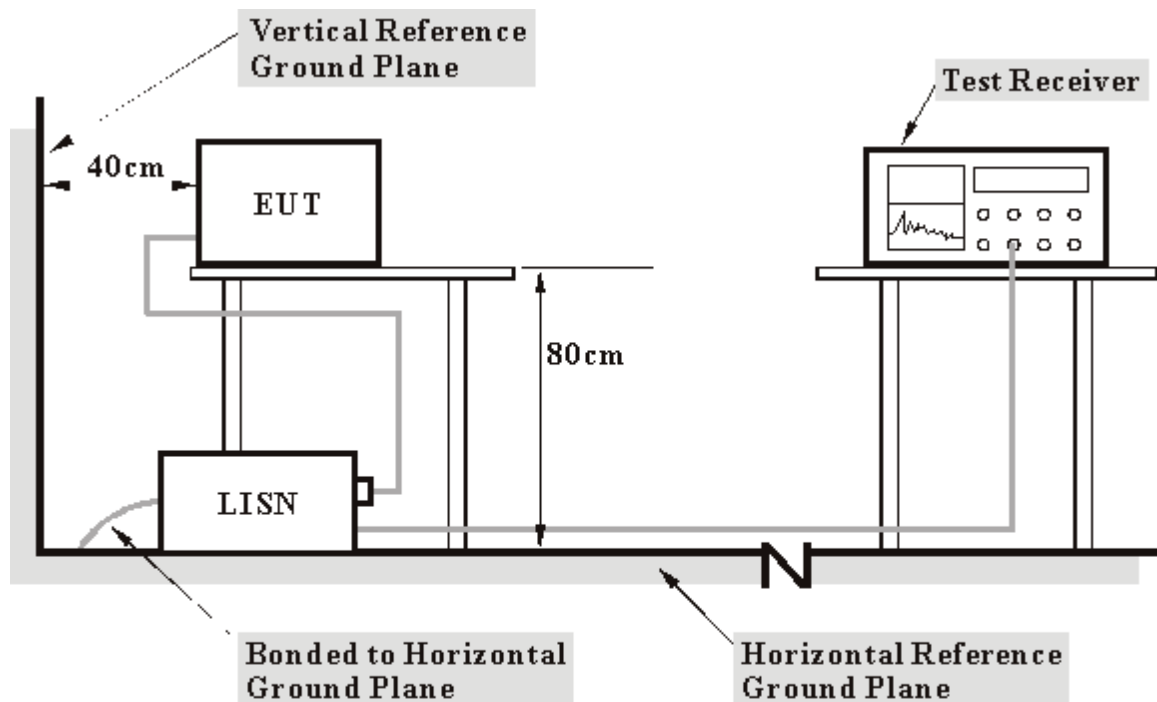

- Note:**
- Support units were connected to second LISN.
 - Both of LISNs (AMN) 80 cm from EUT and at the least 80 cm from other units and other metal planes support units.

For the actual test configuration, please refer to the related item – Photographs of the Test Configuration.



4.1.6 EUT OPERATING CONDITIONS

- a. The computer system ran a test program to enable EUT under transmission/receiving condition continuously at specific channel frequency.
- b. The computer system sent "H" messages to its screen.
- c. The computer system sent "H" messages to printer, and the printer prints them on paper.
- d. Repeated items b to c.



4.1.7 TEST RESULTS

EUT	NoteBook	MODEL	ZW9
MODE	Channel 1	6dB BANDWIDTH	9 kHz
INPUT POWER (SYSTEM)	120Vac, 60 Hz	PHASE	Line (L)
ENVIRONMENTAL CONDITIONS	20 deg. C, 65%RH, 991 hPa	TESTED BY: Jamison Chan	

No	Freq. [MHz]	Corr. Factor (dB)	Reading Value		Emission Level		Limit		Margin	
			[dB (uV)]		[dB (uV)]		[dB (uV)]		(dB)	
			Q.P.	AV.	Q.P.	AV.	Q.P.	AV.	Q.P.	AV.
1	0.150	0.10	47.49	-	47.59	-	66.00	56.00	-18.41	-
2	0.213	0.10	33.57	-	33.67	-	63.11	53.11	-29.44	-
3	0.353	0.10	24.74	-	24.84	-	58.89	48.89	-34.05	-
4	0.927	0.19	22.41	-	22.60	-	56.00	46.00	-33.40	-
5	19.391	0.89	27.84	-	28.73	-	60.00	50.00	-31.27	-
6	22.813	1.07	29.12	-	30.19	-	60.00	50.00	-29.81	-

- REMARKS:**
1. Q.P. and AV. are abbreviations of quasi-peak and average individually.
 2. "-": The Quasi-peak reading value also meets average limit and measurement with the average detector is unnecessary.
 3. The emission levels of other frequencies were very low against the limit.
 4. Margin value = Emission level - Limit value
 5. Correction factor = Insertion loss + Cable loss
 6. Emission Level = Correction Factor + Reading Value.

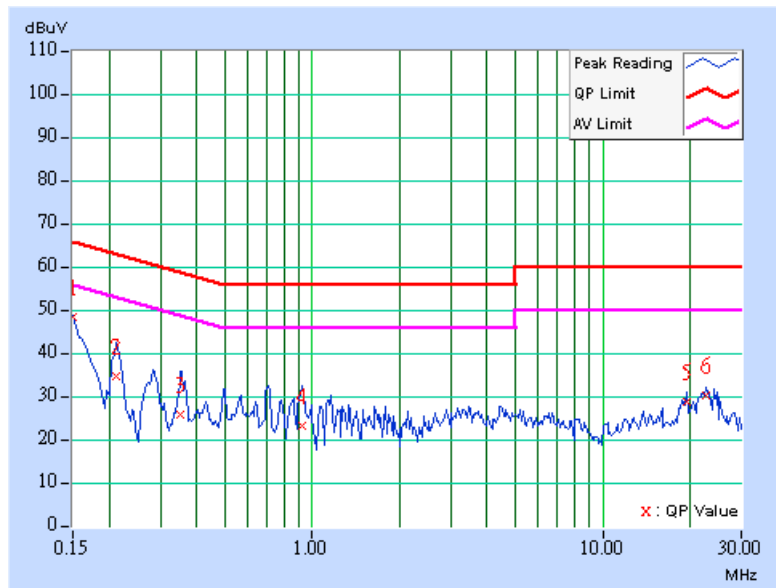



EUT	NoteBook	MODEL	ZW9
MODE	Channel 1	6dB BANDWIDTH	9 kHz
INPUT POWER (SYSTEM)	120Vac, 60 Hz	PHASE	Neutral (N)
ENVIRONMENTAL CONDITIONS	20 deg. C, 65%RH, 991 hPa	TESTED BY: Jamison Chan	

No	Freq. [MHz]	Corr. Factor (dB)	Reading Value		Emission Level		Limit		Margin	
			[dB (uV)]		[dB (uV)]		[dB (uV)]		(dB)	
			Q.P.	AV.	Q.P.	AV.	Q.P.	AV.	Q.P.	AV.
1	0.150	0.10	43.58	-	43.68	-	66.00	56.00	-22.32	-
2	0.220	0.10	26.59	-	26.69	-	62.81	52.81	-36.12	-
3	0.330	0.10	28.61	-	28.71	-	59.46	49.46	-30.75	-
4	2.172	0.21	23.55	-	23.76	-	56.00	46.00	-32.24	-
5	16.000	0.72	40.42	-	41.14	-	60.00	50.00	-18.86	-
6	19.453	0.79	29.06	-	29.85	-	60.00	50.00	-30.15	-

- REMARKS:**
1. Q.P. and AV. are abbreviations of quasi-peak and average individually.
 2. "-": The Quasi-peak reading value also meets average limit and measurement with the average detector is unnecessary.
 3. The emission levels of other frequencies were very low against the limit.
 4. Margin value = Emission level - Limit value
 5. Correction factor = Insertion loss + Cable loss
 6. Emission Level = Correction Factor + Reading Value.

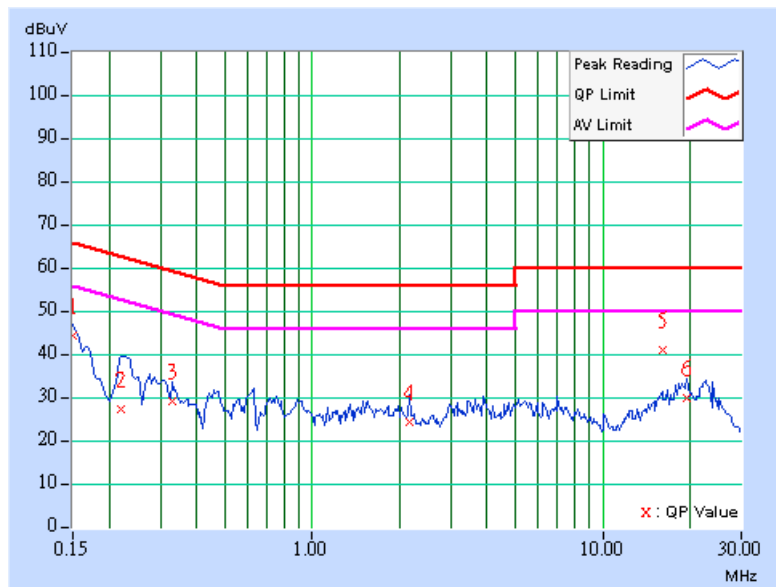



EUT	NoteBook	MODEL	ZW9
MODE	Channel 6	6dB BANDWIDTH	9 kHz
INPUT POWER (SYSTEM)	120Vac, 60 Hz	PHASE	Line (L)
ENVIRONMENTAL CONDITIONS	20 deg. C, 65%RH, 991 hPa	TESTED BY: Jamison Chan	

No	Freq. [MHz]	Corr. Factor (dB)	Reading Value		Emission Level		Limit		Margin	
			[dB (uV)]		[dB (uV)]		[dB (uV)]		(dB)	
			Q.P.	AV.	Q.P.	AV.	Q.P.	AV.	Q.P.	AV.
1	0.154	0.10	48.37	-	48.47	-	65.79	55.79	-17.32	-
2	0.224	0.10	32.03	-	32.13	-	62.66	52.66	-30.53	-
3	0.306	0.10	29.78	-	29.88	-	60.07	50.07	-30.19	-
4	0.373	0.10	24.62	-	24.72	-	58.44	48.44	-33.72	-
5	19.449	0.89	27.81	-	28.70	-	60.00	50.00	-31.30	-
6	24.141	1.15	29.15	-	30.30	-	60.00	50.00	-29.70	-

- REMARKS:**
1. Q.P. and AV. are abbreviations of quasi-peak and average individually.
 2. "-": The Quasi-peak reading value also meets average limit and measurement with the average detector is unnecessary.
 3. The emission levels of other frequencies were very low against the limit.
 4. Margin value = Emission level - Limit value
 5. Correction factor = Insertion loss + Cable loss
 6. Emission Level = Correction Factor + Reading Value.

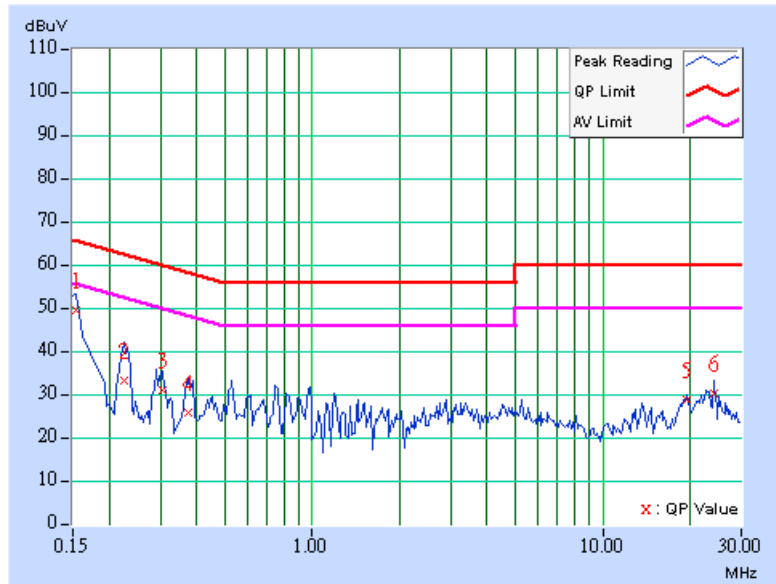



EUT	NoteBook	MODEL	ZW9
MODE	Channel 6	6dB BANDWIDTH	9 kHz
INPUT POWER (SYSTEM)	120Vac, 60 Hz	PHASE	Neutral (N)
ENVIRONMENTAL CONDITIONS	20 deg. C, 65%RH, 991 hPa	TESTED BY: Jamison Chan	

No	Freq. [MHz]	Corr. Factor (dB)	Reading Value		Emission Level		Limit		Margin	
			[dB (uV)]		[dB (uV)]		[dB (uV)]		(dB)	
			Q.P.	AV.	Q.P.	AV.	Q.P.	AV.	Q.P.	AV.
1	0.158	0.10	47.22	-	47.32	-	65.58	55.58	-18.26	-
2	0.177	0.10	38.25	-	38.35	-	64.61	54.61	-26.26	-
3	0.236	0.10	32.69	-	32.79	-	62.24	52.24	-29.45	-
4	0.392	0.10	32.23	-	32.33	-	58.02	48.02	-25.69	-
5	19.031	0.78	31.20	-	31.98	-	60.00	50.00	-28.02	-
6	22.332	0.89	30.61	-	31.50	-	60.00	50.00	-28.50	-

- REMARKS:**
1. Q.P. and AV. are abbreviations of quasi-peak and average individually.
 2. "-": The Quasi-peak reading value also meets average limit and measurement with the average detector is unnecessary.
 3. The emission levels of other frequencies were very low against the limit.
 4. Margin value = Emission level - Limit value
 5. Correction factor = Insertion loss + Cable loss
 6. Emission Level = Correction Factor + Reading Value.

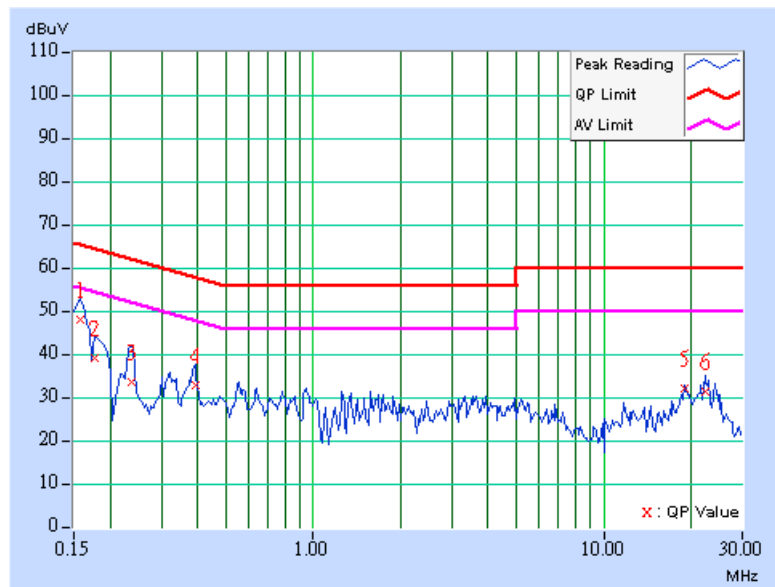



EUT	NoteBook	MODEL	ZW9
MODE	Channel 11	6dB BANDWIDTH	9 kHz
INPUT POWER (SYSTEM)	120Vac, 60 Hz	PHASE	Line (L)
ENVIRONMENTAL CONDITIONS	20 deg. C, 65%RH, 991 hPa	TESTED BY: Jamison Chan	

No	Freq. [MHz]	Corr. Factor (dB)	Reading Value		Emission Level		Limit		Margin	
			[dB (uV)]		[dB (uV)]		[dB (uV)]		(dB)	
			Q.P.	AV.	Q.P.	AV.	Q.P.	AV.	Q.P.	AV.
1	0.173	0.10	46.29	-	46.39	-	64.79	54.79	-18.40	-
2	0.259	0.10	33.54	-	33.64	-	61.45	51.45	-27.81	-
3	0.341	0.10	28.73	-	28.83	-	59.17	49.17	-30.34	-
4	0.591	0.13	23.53	-	23.66	-	56.00	46.00	-32.34	-
5	18.852	0.88	29.31	-	30.19	-	60.00	50.00	-29.81	-
6	22.332	1.04	30.33	-	31.37	-	60.00	50.00	-28.63	-

- REMARKS:**
1. Q.P. and AV. are abbreviations of quasi-peak and average individually.
 2. "-": The Quasi-peak reading value also meets average limit and measurement with the average detector is unnecessary.
 3. The emission levels of other frequencies were very low against the limit.
 4. Margin value = Emission level - Limit value
 5. Correction factor = Insertion loss + Cable loss
 6. Emission Level = Correction Factor + Reading Value.

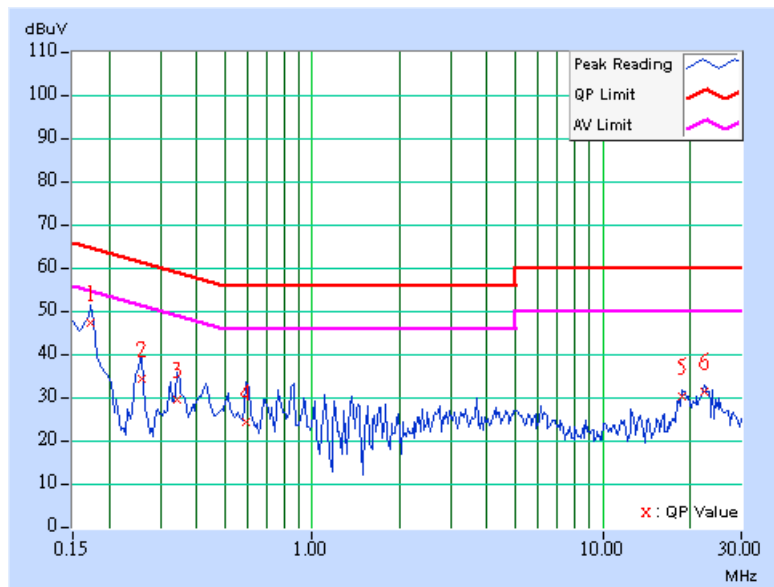



EUT	NoteBook	MODEL	ZW9
MODE	Channel 11	6dB BANDWIDTH	9 kHz
INPUT POWER (SYSTEM)	120Vac, 60 Hz	PHASE	Netural (N)
ENVIRONMENTAL CONDITIONS	20 deg. C, 65%RH, 991 hPa	TESTED BY: Jamison Chan	

No	Freq. [MHz]	Corr. Factor (dB)	Reading Value		Emission Level		Limit		Margin	
			[dB (uV)]		[dB (uV)]		[dB (uV)]		(dB)	
			Q.P.	AV.	Q.P.	AV.	Q.P.	AV.	Q.P.	AV.
1	0.166	0.10	46.71	-	46.81	-	65.18	55.18	-18.37	-
2	0.252	0.10	34.79	-	34.89	-	61.71	51.71	-26.82	-
3	0.408	0.10	32.63	-	32.73	-	57.69	47.69	-24.96	-
4	0.584	0.13	29.73	-	29.86	-	56.00	46.00	-26.14	-
5	19.027	0.78	30.67	-	31.45	-	60.00	50.00	-28.55	-
6	22.934	0.92	29.49	-	30.41	-	60.00	50.00	-29.59	-

- REMARKS:**
1. Q.P. and AV. are abbreviations of quasi-peak and average individually.
 2. "-": The Quasi-peak reading value also meets average limit and measurement with the average detector is unnecessary.
 3. The emission levels of other frequencies were very low against the limit.
 4. Margin value = Emission level - Limit value
 5. Correction factor = Insertion loss + Cable loss
 6. Emission Level = Correction Factor + Reading Value.

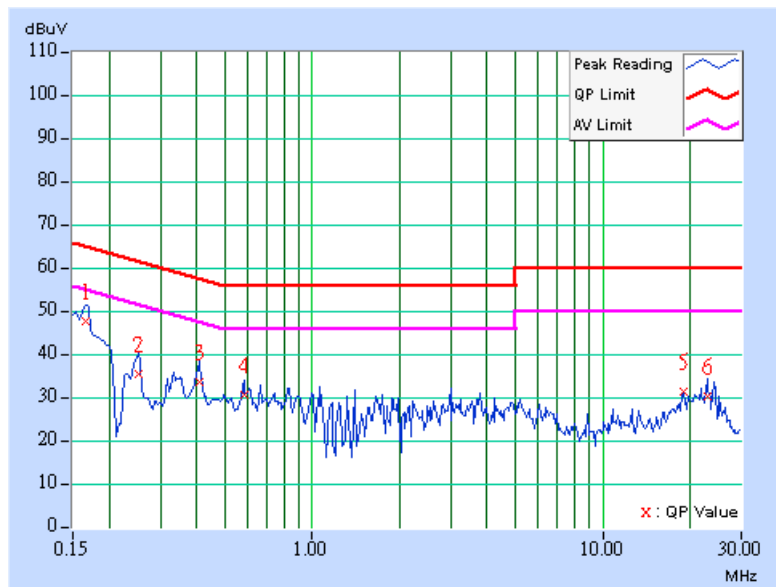



4.2 RADIATED EMISSION MEASUREMENT

4.2.1 LIMITS OF RADIATED EMISSION MEASUREMENT

Emissions radiated outside of the specified bands, shall be according to the general radiated limits in 15.209 as following:

Frequencies (MHz)	Field strength (microvolts/meter)	Measurement distance (meters)
0.009-0.490	2400/F(kHz)	300
0.490-1.705	24000/F(kHz)	30
1.705-30.0	30	30
30-88	100	3
88-216	150	3
216-960	200	3
Above 960	500	3

NOTE:

1. The lower limit shall apply at the transition frequencies.
2. Emission level (dBuV/m) = 20 log Emission level (uV/m).
3. As shown in 15.35(b), for frequencies above 1000MHz, the field strength limits are based on average detector, however, the peak field strength of any emission shall not exceed the maximum permitted average limits, specified above by more than 20dB under any condition of modulation.



4.2.2 TEST INSTRUMENTS

DESCRIPTION & MANUFACTURER	MODEL NO.	SERIAL NO.	CALIBRATED UNTIL
* HP Spectrum Analyzer	8593E	3911A07465	July 07, 2004
* HP Preamplifier	8447D	2432A03504	June 10, 2004
* HP Preamplifier	8449B	3008A01201	Dec. 11, 2004
SCHAFFNER Tunable Dipole Antenna	VHBA 9123	459	Jun. 26, 2004
SCHWARZBECK Tunable Dipole Antenna	UHA 9105	977	
* ROHDE & SCHWARZ TEST RECEIVER	ESMI	839013/007 839379/002	Feb. 13, 2004
*Schwarzbeck Antenna	VULB9168	137	Apr. 03, 2004
* SCHWARZBECK Horn Antenna	BBHA9120-D1	D130	June 30, 2004
*ADT. Turn Table	TT100	0306	NA
*ADT. Tower	AT100	0306	NA
*Software	ADT_Radiated_V5.14	NA	NA
*TIMES RF cable	LL142	CABLE-CH6-01	Apr. 30, 2004

- NOTE:**
1. The calibration interval of the above test instruments is 12 months. And the calibrations are traceable to NML/ROC and NIST/USA.
 2. "*" = These equipment are used for the final measurement.
 3. The horn antenna and HP preamplifier (model: 8449B) are used only for the measurement of emission frequency above 1GHz if tested.
 4. The test was performed in ADT Chamber No. 6.



4.2.3 TEST PROCEDURES

- a. The EUT was placed on the top of a rotating table 0.8 meters above the ground at a 10 meter open area test site. The table was rotated 360 degrees to determine the position of the highest radiation.
- b. The EUT was set 3 meters away from the interference-receiving antenna, which was mounted on the top of a variable-height antenna tower.
- c. The antenna is a broadband antenna, and its height is varied from one meter to four meters above the ground to determine the maximum value of the field strength. Both horizontal and vertical polarizations of the antenna are set to make the measurement.
- d. For each suspected emission, the EUT was arranged to its worst case and then the antenna was tuned to heights from 1 meter to 4 meters and the rotatable table was turned from 0 degrees to 360 degrees to find the maximum reading.
- e. The test-receiver system was set to Peak Detect Function and Specified Bandwidth with Maximum Hold Mode.
- f. If the emission level of the EUT in peak mode was 10 dB lower than the limit specified, then testing could be stopped and the peak values of the EUT would be reported. Otherwise the emissions that did not have 10 dB margin would be re-tested one by one using peak, quasi-peak or average method as specified and then reported in a data sheet.

NOTE:

1. The resolution bandwidth and video bandwidth of test receiver/spectrum analyzer is 120kHz for Peak detection (PK) and Quasi-peak detection (QP) at frequency below 1GHz.
2. The resolution bandwidth and video bandwidth of test receiver/spectrum analyzer is 1 MHz for Peak detection at frequency above 1GHz.
3. The resolution bandwidth of test receiver/spectrum analyzer is 1 MHz and the video bandwidth is 10 Hz for Average detection (AV) at frequency above 1GHz.

4.2.4 DEVIATION FROM TEST STANDARD

No deviation

4.2.5 TEST SETUP

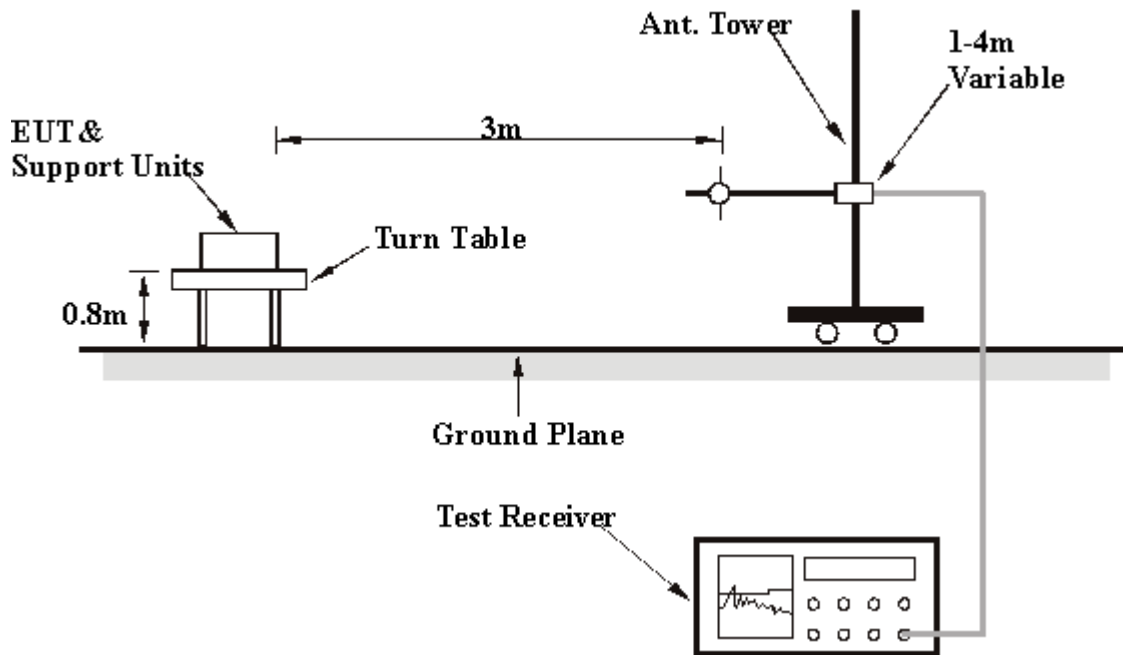

For the actual test configuration, please refer to the related item – Photographs of the Test Configuration.

4.2.6 EUT OPERATING CONDITIONS

Same as 4.1.6



4.2.7 TEST RESULTS

EUT	NoteBook	MODEL	ZW9
MODE	Channel 11	FREQUENCY RANGE	Below 1000 MHz
INPUT POWER (SYSTEM)	120Vac, 60 Hz	DETECTOR FUNCTION	Quasi-Peak
ENVIRONMENTAL CONDITIONS	20 deg. C, 65 % RH, 991 hPa	TESTED BY: Steven Lu	

ANTENNA POLARITY & TEST DISTANCE: HORIZONTAL AT 3 M								
No.	Freq. (MHz)	Emission Level (dBuV/m)	Limit (dBuV/m)	Margin (dB)	Antenna Height (m)	Table Angle (Degree)	Raw Value (dBuV)	Correction Factor (dB/m)
1	198.65	42.33 QP	43.50	-1.17	1.74 H	99	31.06	11.28
2	228.28	36.90 QP	46.00	-9.10	1.50 H	97	24.31	12.59
3	300.20	37.48 QP	46.00	-8.52	1.00 H	31	22.38	15.10
4	325.47	38.25 QP	46.00	-7.75	1.00 H	238	22.49	15.77
5	331.30	40.66 QP	46.00	-5.34	1.00 H	277	24.73	15.92
6	333.25	42.09 QP	46.00	-3.91	1.00 H	280	26.12	15.97
7	389.62	38.78 QP	46.00	-7.22	1.00 H	301	21.34	17.44
8	455.71	37.48 QP	46.00	-8.52	2.00 H	103	18.09	19.38
9	527.64	35.51 QP	46.00	-10.49	1.00 H	73	14.89	20.62
10	576.23	35.11 QP	46.00	-10.89	1.50 H	166	13.22	21.90
11	599.56	38.78 QP	46.00	-7.22	1.50 H	349	16.19	22.59
12	733.69	39.48 QP	46.00	-6.52	1.00 H	232	14.58	24.90
13	910.58	34.55 QP	46.00	-11.45	1.00 H	286	7.29	27.26
14	994.17	36.86 QP	54.00	-17.14	1.00 H	331	8.96	27.90

- REMARKS:**
1. Emission level(dBuV/m)=Raw Value(dBuV) + Correction Factor(dB)
 2. Correction Factor(dB/m) = Antenna Factor (dB/m) + Cable Factor (dB)
 3. The other emission levels were very low against the limit.
 4. Margin value = Emission level – Limit value.



EUT	NoteBook	MODEL	ZW9
MODE	Channel 11	FREQUENCY RANGE	Below 1000 MHz
INPUT POWER (SYSTEM)	120Vac, 60 Hz	DETECTOR FUNCTION	Quasi-Peak
ENVIRONMENTAL CONDITIONS	20 deg. C, 65 % RH, 991 hPa	TESTED BY: Steven Lu	

ANTENNA POLARITY & TEST DISTANCE: VERTICAL AT 3 M								
No.	Freq. (MHz)	Emission Level (dBuV/m)	Limit (dBuV/m)	Margin (dB)	Antenna Height (m)	Table Angle (Degree)	Raw Value (dBuV)	Correction Factor (dB/m)
1	197.17	36.17 QP	43.50	-7.33	2.00 V	19	24.79	11.38
2	228.28	34.06 QP	46.00	-11.94	1.00 V	304	21.46	12.59
3	259.38	32.93 QP	46.00	-13.07	1.50 V	181	19.32	13.61
4	333.25	40.37 QP	46.00	-5.63	1.25 V	193	24.40	15.97
5	352.69	36.77 QP	46.00	-9.23	1.00 V	172	20.28	16.49
6	389.62	41.38 QP	46.00	-4.62	1.25 V	349	23.93	17.44
7	422.67	33.60 QP	46.00	-12.40	1.25 V	343	15.17	18.43
8	454.74	45.22 QP	46.00	-0.78	1.00 V	168	25.86	19.37
9	486.81	37.29 QP	46.00	-8.71	1.00 V	208	17.47	19.82
10	529.58	41.67 QP	46.00	-4.33	1.50 V	160	21.00	20.67
11	576.23	40.14 QP	46.00	-5.86	1.75 V	34	18.24	21.90
12	624.83	33.46 QP	46.00	-12.54	1.50 V	58	10.54	22.92
13	702.59	34.26 QP	46.00	-11.74	2.50 V	46	10.21	24.05
14	834.77	37.96 QP	46.00	-8.04	1.25 V	205	11.98	25.98

- REMARKS:**
1. Emission level(dBuV/m)=Raw Value(dBuV) + Correction Factor(dB)
 2. Correction Factor(dB/m) = Antenna Factor (dB/m) + Cable Factor (dB)
 3. The other emission levels were very low against the limit.
 4. Margin value = Emission level – Limit value.



EUT	NoteBook	MODEL	ZW9
MODE	Channel 1	FREQUENCY RANGE	Above 1000 MHz
INPUT POWER (SYSTEM)	120Vac, 60 Hz	DETECTOR FUNCTION	Peak(PK) Average (AV)
ENVIRONMENTAL CONDITIONS	20 deg. C, 65 % RH, 991 hPa	TESTED BY: Steven Lu	

ANTENNA POLARITY & TEST DISTANCE: HORIZONTAL AT 3 M

No.	Freq. (MHz)	Emission Level (dBuV/m)	Limit (dBuV/m)	Margin (dB)	Antenna Height (m)	Table Angle (Degree)	Raw Value (dBuV)	Correction Factor (dB/m)
1	1674.00	44.04 PK	74.00	-29.96	1.20 H	274	14.69	29.35
2	2390.00	56.39 PK	74.00	-17.61	1.67 H	115	24.91	31.48
2	2390.00	46.80 AV	54.00	-7.20	1.67 H	115	15.32	31.48
3	*2412.00	109.44 PK			1.67 H	115	77.93	31.51
3	*2412.00	99.85 AV			1.67 H	115	68.34	31.51
4	7236.00	51.94 PK	74.00	-22.06	1.22 H	10	9.74	42.21
4	7236.00	39.61 AV	54.00	-14.39	1.22 H	10	-2.59	42.21

ANTENNA POLARITY & TEST DISTANCE: VERTICAL AT 3 M

No.	Freq. (MHz)	Emission Level (dBuV/m)	Limit (dBuV/m)	Margin (dB)	Antenna Height (m)	Table Angle (Degree)	Raw Value (dBuV)	Correction Factor (dB/m)
1	1674.00	46.73 PK	74.00	-27.27	1.06 V	222	17.38	29.35
2	*2412.00	103.09 PK			1.25 V	325	71.58	31.51
2	*2412.00	93.36 AV			1.25 V	325	61.85	31.51
4	4824.00	48.96 PK	74.00	-25.04	1.37 V	321	11.11	37.86

REMARKS:

1. Emission level(dBuV/m)=Raw Value(dBuV) + Correction Factor(dB)
2. Correction Factor(dB/m) = Antenna Factor (dB/m) + Cable Factor (dB)
3. The other emission levels were very low against the limit.
4. Margin value = Emission level – Limit value.
5. “ * “ : Fundamental frequency



EUT	NoteBook	MODEL	ZW9
MODE	Channel 6	FREQUENCY RANGE	Above 1000 MHz
INPUT POWER (SYSTEM)	120Vac, 60 Hz	DETECTOR FUNCTION	Peak(PK) Average (AV)
ENVIRONMENTAL CONDITIONS	20 deg. C, 65 % RH, 991 hPa	TESTED BY: Steven Lu	

ANTENNA POLARITY & TEST DISTANCE: HORIZONTAL AT 3 M								
No.	Freq. (MHz)	Emission Level (dBuV/m)	Limit (dBuV/m)	Margin (dB)	Antenna Height (m)	Table Angle (Degree)	Raw Value (dBuV)	Correction Factor (dB/m)
1	1674.00	44.51 PK	74.00	-29.49	1.46 H	62	15.16	29.35
2	*2437.00	107.17 PK			1.62 H	111	75.63	31.54
2	*2437.00	96.81 AV			1.62 H	111	65.27	31.54

ANTENNA POLARITY & TEST DISTANCE: VERTICAL AT 3 M								
No.	Freq. (MHz)	Emission Level (dBuV/m)	Limit (dBuV/m)	Margin (dB)	Antenna Height (m)	Table Angle (Degree)	Raw Value (dBuV)	Correction Factor (dB/m)
1	1674.00	46.14 PK	74.00	-27.86	1.26 V	28	16.79	29.35
2	*2437.00	107.89 PK			1.03 V	89	76.35	31.54
2	*2437.00	98.23 AV			1.03 V	89	66.69	31.54
3	4874.00	46.60 PK	74.00	-27.40	1.27 V	20	8.66	37.94

REMARKS:

1. Emission level(dBuV/m)=Raw Value(dBuV) + Correction Factor(dB)
2. Correction Factor(dB/m) = Antenna Factor (dB/m) + Cable Factor (dB)
3. The other emission levels were very low against the limit.
4. Margin value = Emission level – Limit value.
5. “ * “ : Fundamental frequency



EUT	NoteBook	MODEL	ZW9
MODE	Channel 11	FREQUENCY RANGE	Above 1000 MHz
INPUT POWER (SYSTEM)	120Vac, 60 Hz	DETECTOR FUNCTION	Peak(PK) Average (AV)
ENVIRONMENTAL CONDITIONS	20 deg. C, 65 % RH, 991 hPa	TESTED BY: Steven Lu	

ANTENNA POLARITY & TEST DISTANCE: HORIZONTAL AT 3 M								
No.	Freq. (MHz)	Emission Level (dBuV/m)	Limit (dBuV/m)	Margin (dB)	Antenna Height (m)	Table Angle (Degree)	Raw Value (dBuV)	Correction Factor (dB/m)
1	1674.00	42.46 PK	74.00	-31.54	1.40 H	122	13.11	29.35
2	*2462.00	106.39 PK			1.62 H	115	74.82	31.57
2	*2462.00	96.72 AV			1.62 H	115	65.15	31.57
3	2483.50	54.79 PK	74.00	-19.21	1.62 H	115	23.19	31.60
3	2483.50	45.12 AV	54.00	-8.88	1.62 H	115	13.52	31.60

ANTENNA POLARITY & TEST DISTANCE: VERTICAL AT 3 M								
No.	Freq. (MHz)	Emission Level (dBuV/m)	Limit (dBuV/m)	Margin (dB)	Antenna Height (m)	Table Angle (Degree)	Raw Value (dBuV)	Correction Factor (dB/m)
1	1674.00	44.35 PK	74.00	-29.65	1.21 V	24	15.00	29.35
2	*2462.00	107.65 PK			1.03 V	89	76.08	31.57
2	*2462.00	97.92 AV			1.03 V	89	66.35	31.57
3	2483.50	56.05 PK	74.00	-17.95	1.03 V	89	24.45	31.60
3	2483.50	46.32 AV	54.00	-7.68	1.03 V	89	14.72	31.60
4	4924.00	46.45 PK	74.00	-27.55	1.32 V	325	8.43	38.02

REMARKS:

1. Emission level(dBuV/m)=Raw Value(dBuV) + Correction Factor(dB)
2. Correction Factor(dB/m) = Antenna Factor (dB/m) + Cable Factor (dB)
3. The other emission levels were very low against the limit.
4. Margin value = Emission level – Limit value.
5. “ * “ : Fundamental frequency



4.3 6dB BANDWIDTH MEASUREMENT

4.3.1 LIMITS OF 6dB BANDWIDTH MEASUREMENT

The minimum of 6dB Bandwidth Measurement is 0.5 MHz.

4.3.2 TEST INSTRUMENTS

Description & Manufacturer	Model No.	Serial No.	Calibrated Until
SPECTRUM ANALYZER	FSEK30	100049	August 12, 2004

NOTE:

The calibration interval of the above test instruments is 12 months and the calibrations are traceable to NML/ROC and NIST/USA.



4.3.3 TEST PROCEDURE

The transmitter output was connected to the spectrum analyzer through an attenuator. The bandwidth of the fundamental frequency was measured by spectrum analyzer with 100 kHz RBW and 100 kHz VBW. The 6 dB bandwidth is defined as the total spectrum the power of which is higher than peak power minus 6 dB.

4.3.4 DEVIATION FROM TEST STANDARD

No deviation

4.3.5 TEST SETUP

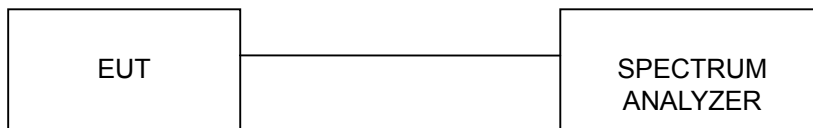

For the actual test configuration, please refer to the related Item – Photographs of the Test Configuration.

4.3.6 EUT OPERATING CONDITIONS

The software provided by client to enable the EUT under transmission condition continuously at lowest, middle and highest channel frequencies individually.



4.3.7 TEST RESULTS

EUT	NoteBook	MODEL	ZW9
INPUT POWER (SYSTEM)	120Vac, 60 Hz	ENVIRONMENTAL CONDITIONS	23 deg. C, 62%RH, 991 hPa
TESTED BY: Steven Lu			

CHANNEL	CHANNEL FREQUENCY (MHz)	6 dB BANDWIDTH (MHz)	MINIMUM LIMIT (MHz)	PASS/FAIL
1	2412	11.90	0.5	PASS
6	2437	12.34	0.5	PASS
11	2462	12.42	0.5	PASS



CH1

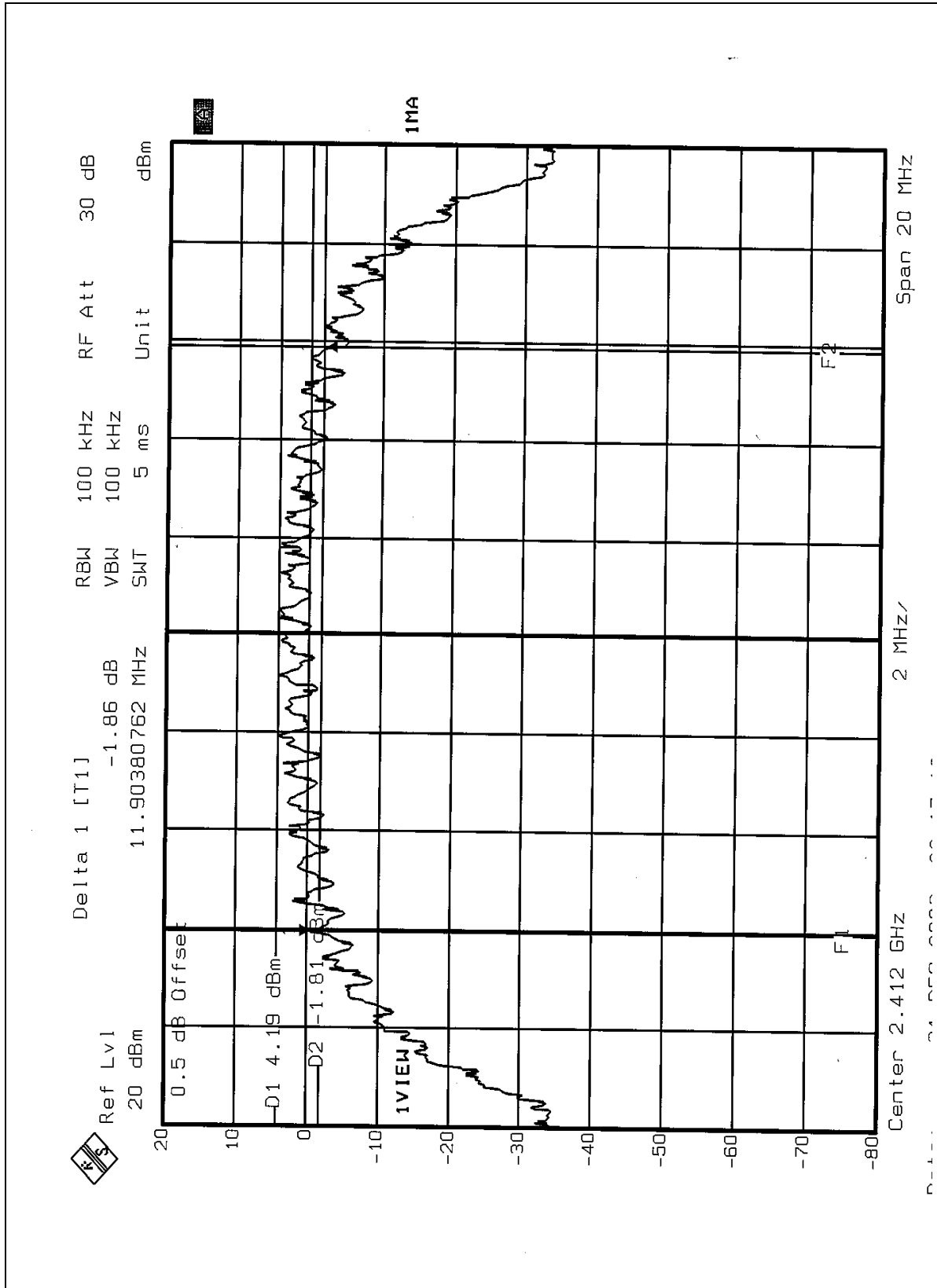



CH6

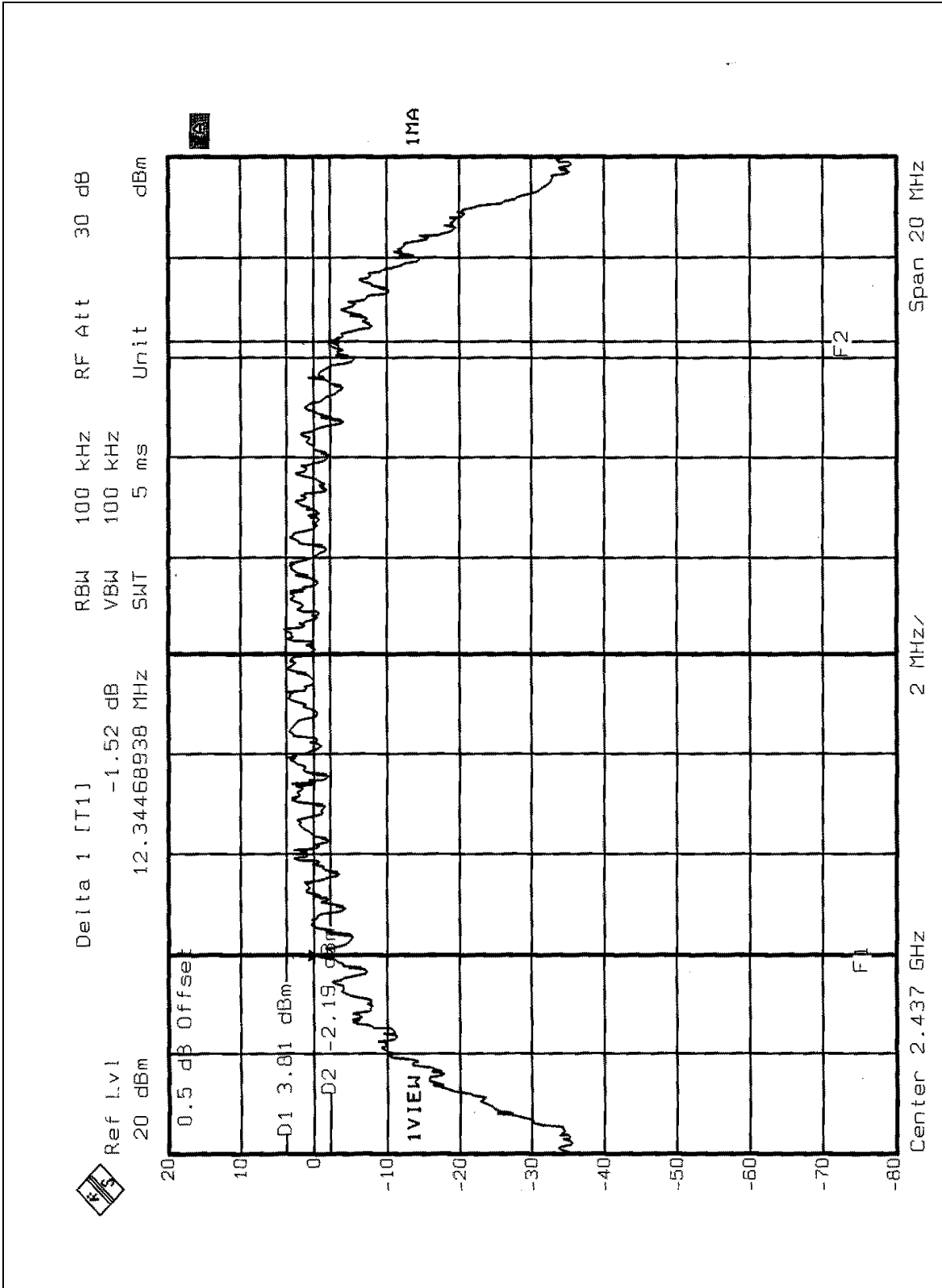



CH11

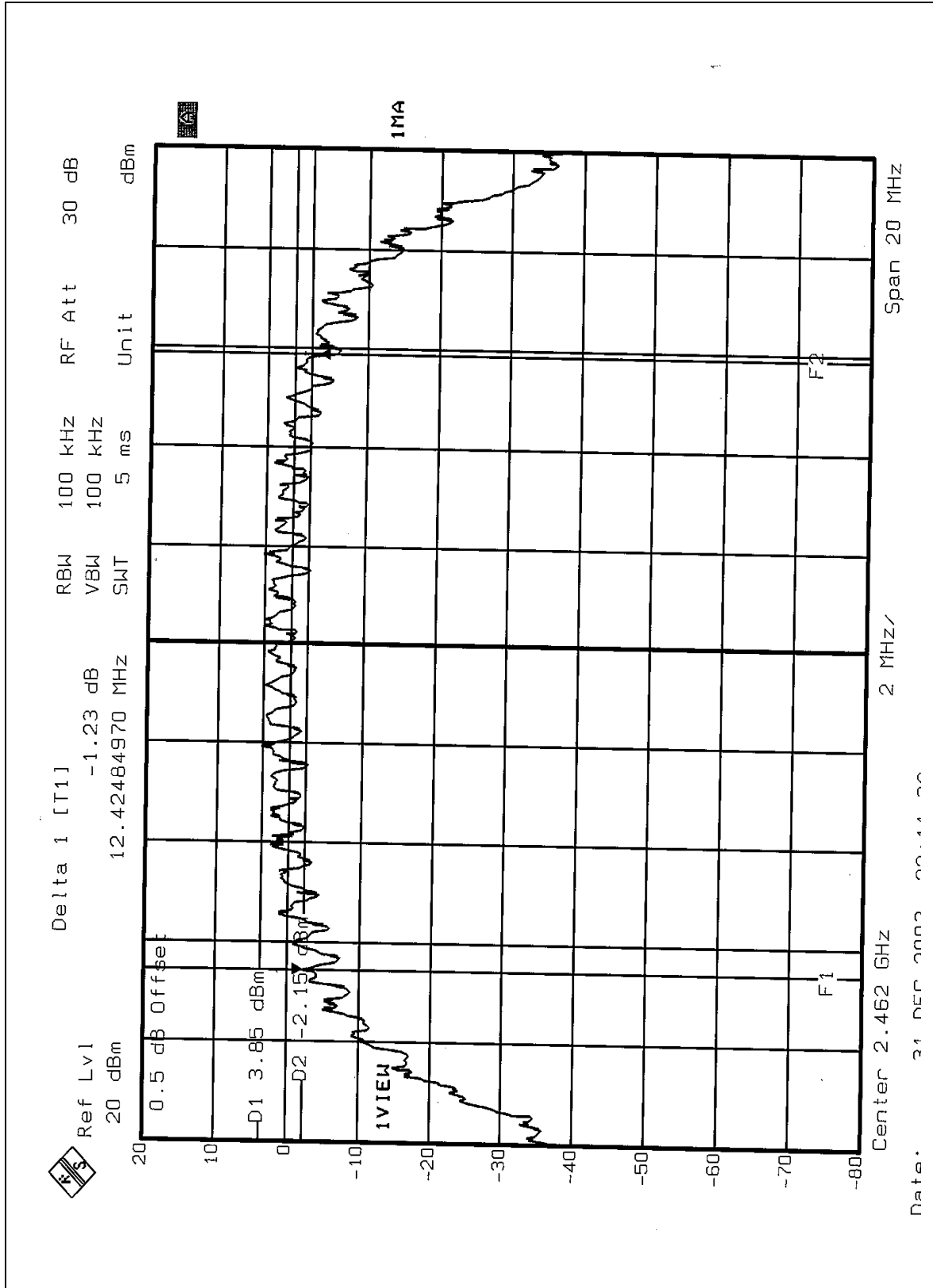



4.4 MAXIMUM PEAK OUTPUT POWER

4.4.1 LIMITS OF MAXIMUM PEAK OUTPUT POWER MEASUREMENT

The Maximum Peak Output Power Measurement is 30dBm.

4.4.2 TEST INSTRUMENTS

Description & Manufacturer	Model No.	Serial No.	Calibrated Until
R&S SPECTRUM ANALYZER	FSEK30	100049	August 12, 2004
R&S SIGNAL GENERATOR	SMP04	100011	May 28, 2004
TEKTRONIX OSCILLOSCOPE	TDS 220	B048470	Mar. 05, 2004
NARDA DETECTOR	4503A	FSCM99899	NA

NOTE:

The calibration interval of the above test instruments is 12 months and the calibrations are traceable to NML/ROC and NIST/USA.



4.4.3 TEST PROCEDURES

1. A detector was used on the output port of the EUT. An oscilloscope was used to read the response of the detector.
2. Replaced the EUT by the signal generator . The center frequency of the S.G was adjusted to the center frequency of the measured channel.
3. Adjusted the power to have the same reading on oscilloscope. Record the power level.

4.4.4 DEVIATION FROM TEST STANDARD

No deviation

4.4.5 TEST SETUP

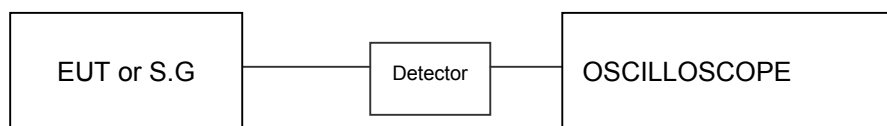

4.4.6 EUT OPERATING CONDITIONS

Same as Item 4.3.6



4.4.7 TEST RESULTS

EUT	NoteBook	MODEL	ZW9
INPUT POWER (SYSTEM)	120Vac, 60 Hz	ENVIRONMENTAL CONDITIONS	23 deg. C, 62%RH, 991 hPa
TESTED BY: Steven Lu			

CHANNEL	CHANNEL FREQUENCY (MHz)	PEAK POWER OUTPUT (dBm)	PEAK POWER LIMIT (dBm)	PASS/FAIL
1	2412	16.1	30	PASS
6	2437	16.2	30	PASS
11	2462	16.1	30	PASS



4.5 POWER SPECTRAL DENSITY MEASUREMENT

4.5.1 LIMITS OF POWER SPECTRAL DENSITY MEASUREMENT

The Maximum of Power Spectral Density Measurement is 8dBm.

4.5.2 TEST INSTRUMENTS

Description & Manufacturer	Model No.	Serial No.	Calibrated Until
SPECTRUM ANALYZER	FSEK30	100049	August 12, 2004

NOTE:

The calibration interval of the above test instruments is 12 months and the calibrations are traceable to NML/ROC and NIST/USA.

4.5.3 TEST PROCEDURE

The transmitter output was connected to the spectrum analyzer through an attenuator, the bandwidth of the fundamental frequency was measured with the spectrum analyzer using 3 kHz RBW and 30 kHz VBW, set sweep time=span/3kHz. The power spectral density was measured and recorded. The sweep time is allowed to be longer than span/3KHz for a full response of the mixer in the spectrum analyzer.

4.5.4 DEVIATION FROM TEST STANDARD

No deviation

4.5.5 TEST SETUP

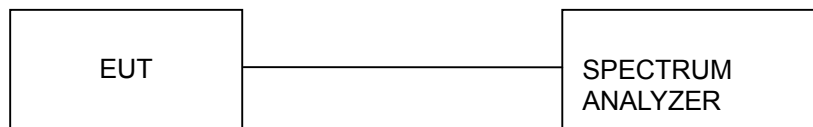

4.5.6 EUT OPERATING CONDITIONS

Same as 4.3.6



4.5.7 TEST RESULTS

EUT	NoteBook	MODEL	ZW9
INPUT POWER (SYSTEM)	120Vac, 60 Hz	ENVIRONMENTAL CONDITIONS	23 deg. C, 62%RH, 991 hPa
TESTED BY: Steven Lu			

CHANNEL NUMBER	CHANNEL FREQUENCY (MHz)	RF POWER LEVEL IN 3 KHz BW (dBm)	MAXIMUM LIMIT (dBm)	PASS/FAIL
1	2412	-7.53	8	PASS
6	2437	-7.53	8	PASS
11	2462	-7.26	8	PASS



CH1

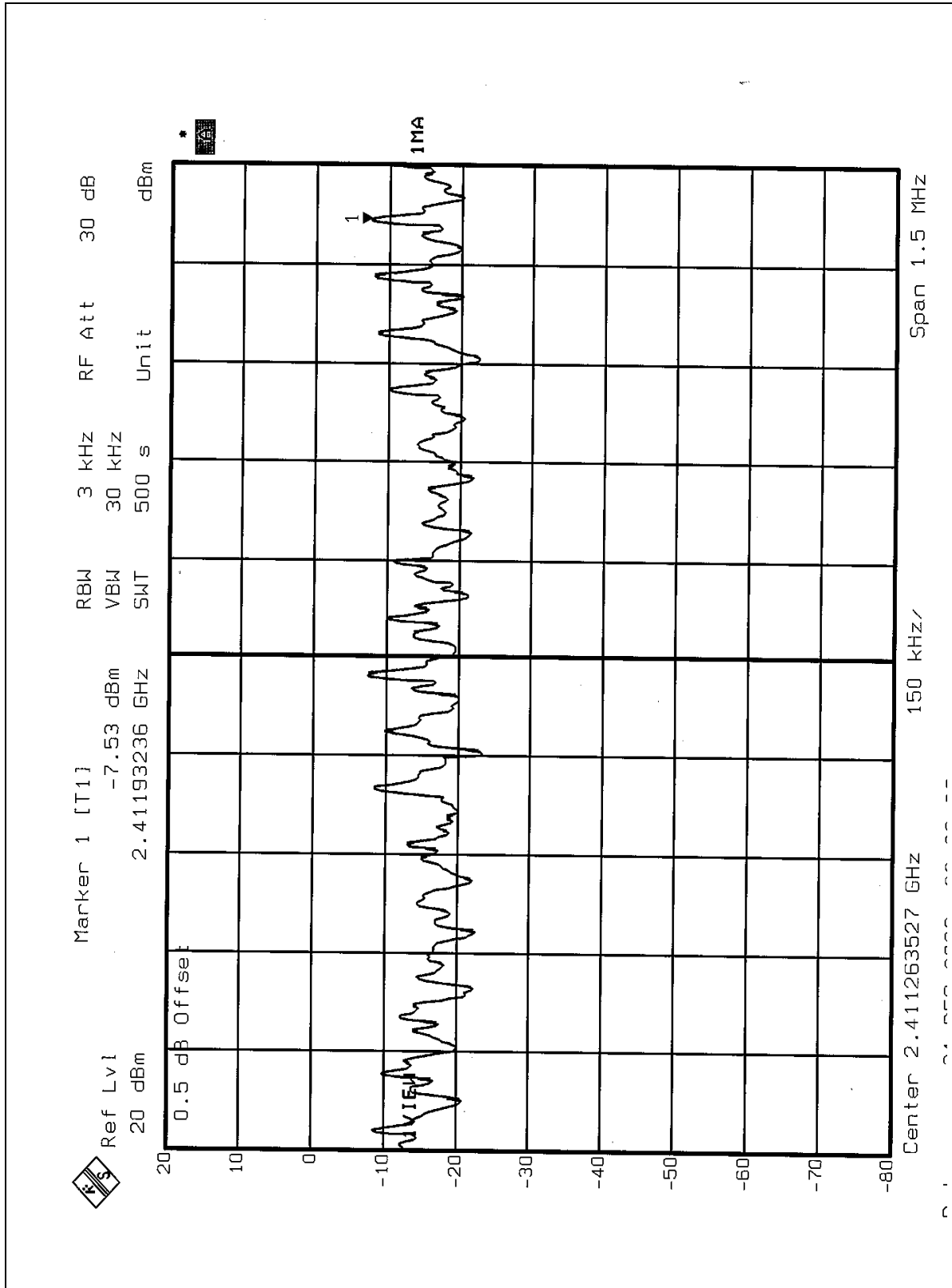



CH6

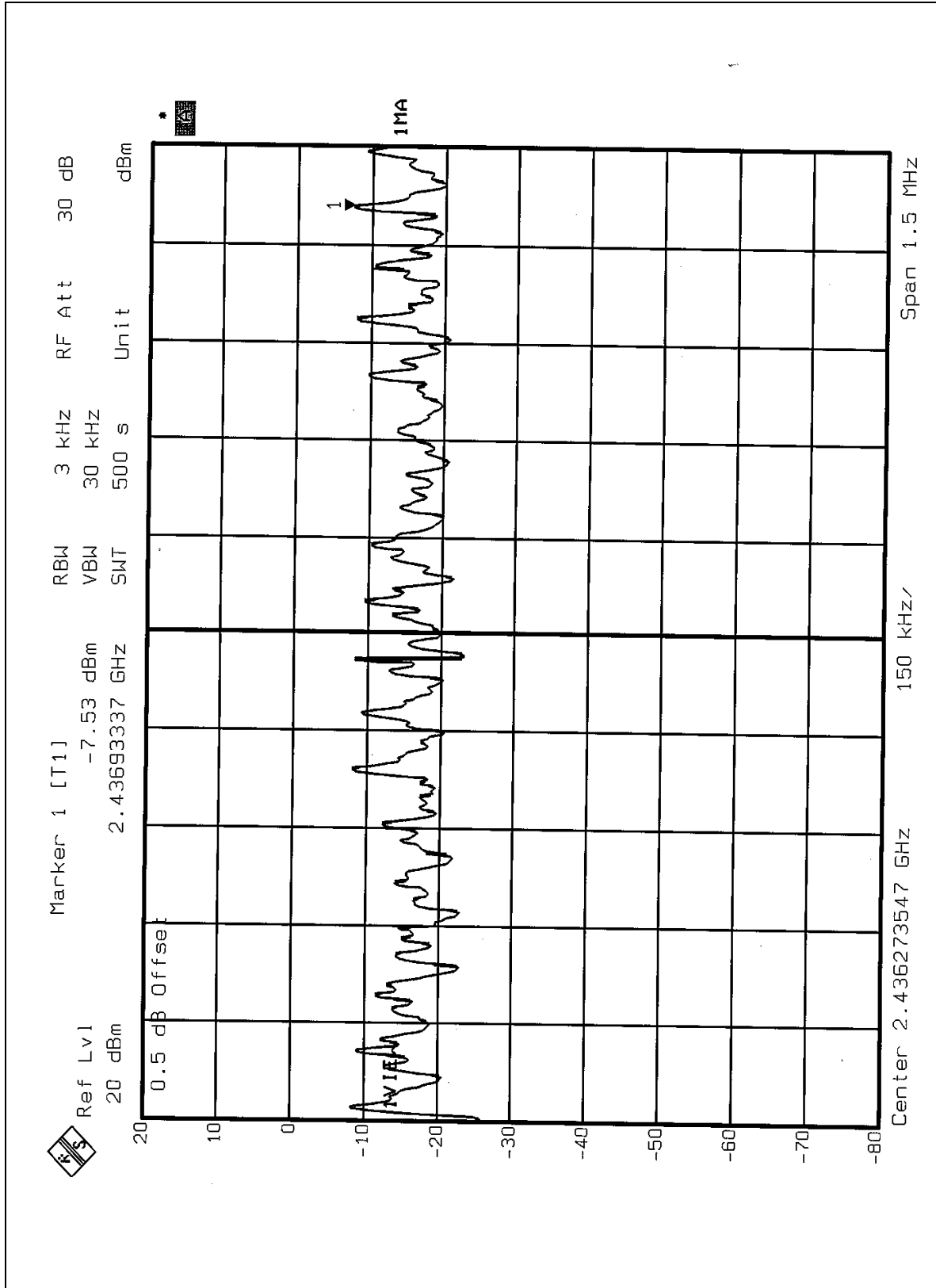



CH11

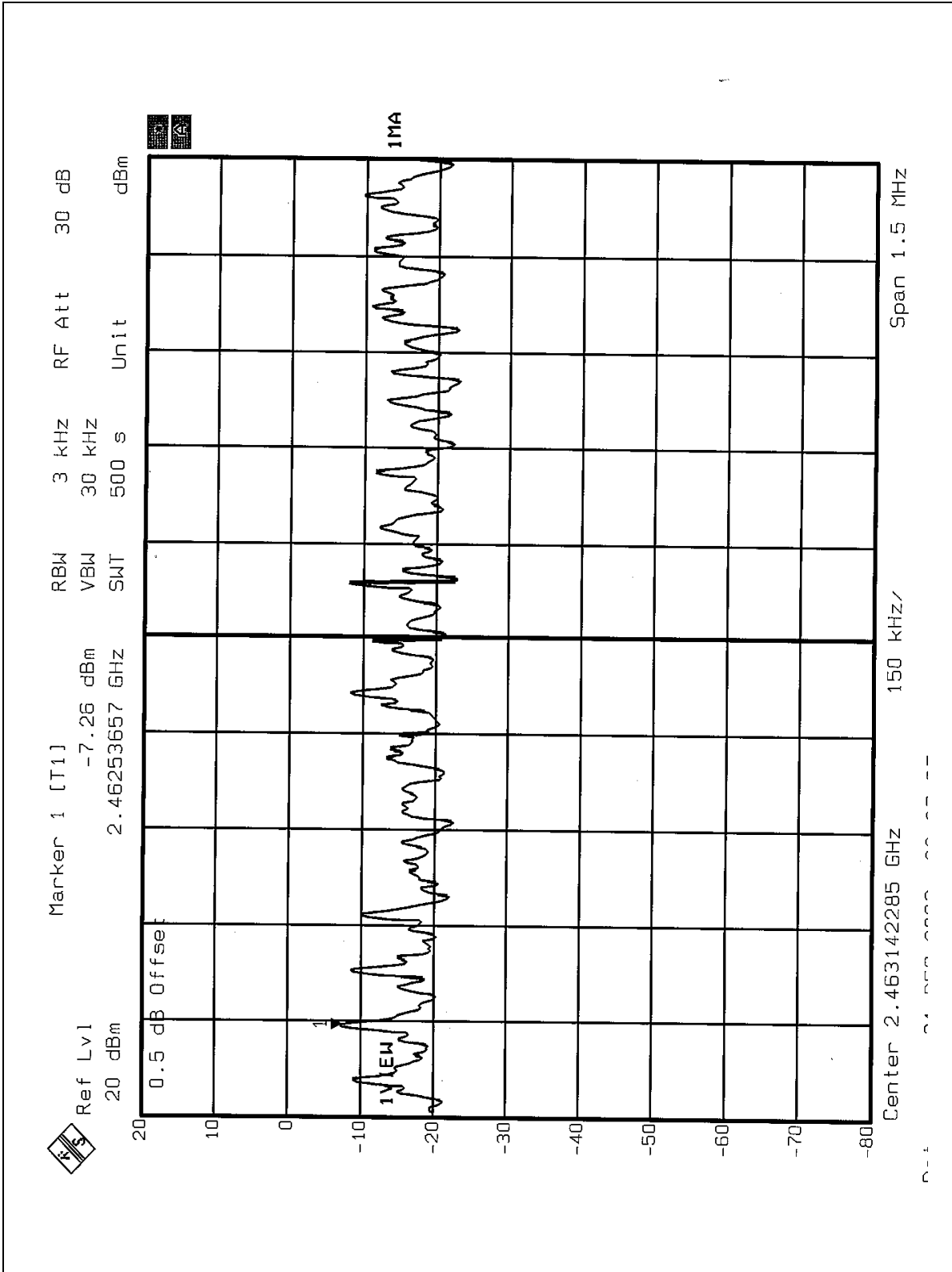



4.6 BAND EDGES MEASUREMENT

4.6.1 LIMITS OF BAND EDGES MEASUREMENT

Below -20dB of the highest emission level of operating band (in 100KHz Resolution Bandwidth).

4.6.2 TEST INSTRUMENTS

Description & Manufacturer	Model No.	Serial No.	Calibrated Until
SPECTRUM ANALYZER	FSEK30	100049	August 12, 2004

NOTE:

The calibration interval of the above test instruments is 12 months and the calibrations are traceable to NML/ROC and NIST/USA.

4.6.3 TEST PROCEDURE

The transmitter output was connected to the spectrum analyzer via a low lose cable. Set both RBW and VBW of spectrum analyzer to 1MHz and 10Hz with suitable frequency span including 100MHz bandwidth from band edge. The band edges was measured and recorded.

4.6.4 DEVIATION FROM TEST STANDARD

No deviation

4.6.5 EUT OPERATING CONDITION

Same as Item 4.3.6



4.6.6 TEST RESULTS

The spectrum plots are attached on the following 2 pages. D2 line indicates the highest level, D1 line indicates the 20dB offset below D2. It shows compliance with the requirement in part 15.247(C).

NOTE:

The band edge emission plot on the following first page shows 51.79dB delta between carrier maximum power and local maximum emission in restrict band (2.3900GHz). The emission of carrier strength list in the test result of channel 1 at the item 4.2.6 (Page 24) is 99.85dBuV/m, so the maximum field strength in restrict band is $99.85-51.79=48.06$ dBuV/m which is under 54 dBuV/m limit.

The band edge emission plot on the following second page shows 50.76dB delta between carrier maximum power and local maximum emission in restrict band (2.4835GHz). The emission of carrier strength list in the test result of channel 11 at the item 4.2.6 (Page 26) is 97.92dBuV/m, so the maximum field strength in restrict band is $97.92-50.76=47.16$ dBuV/m which is under 54 dBuV/m limit.

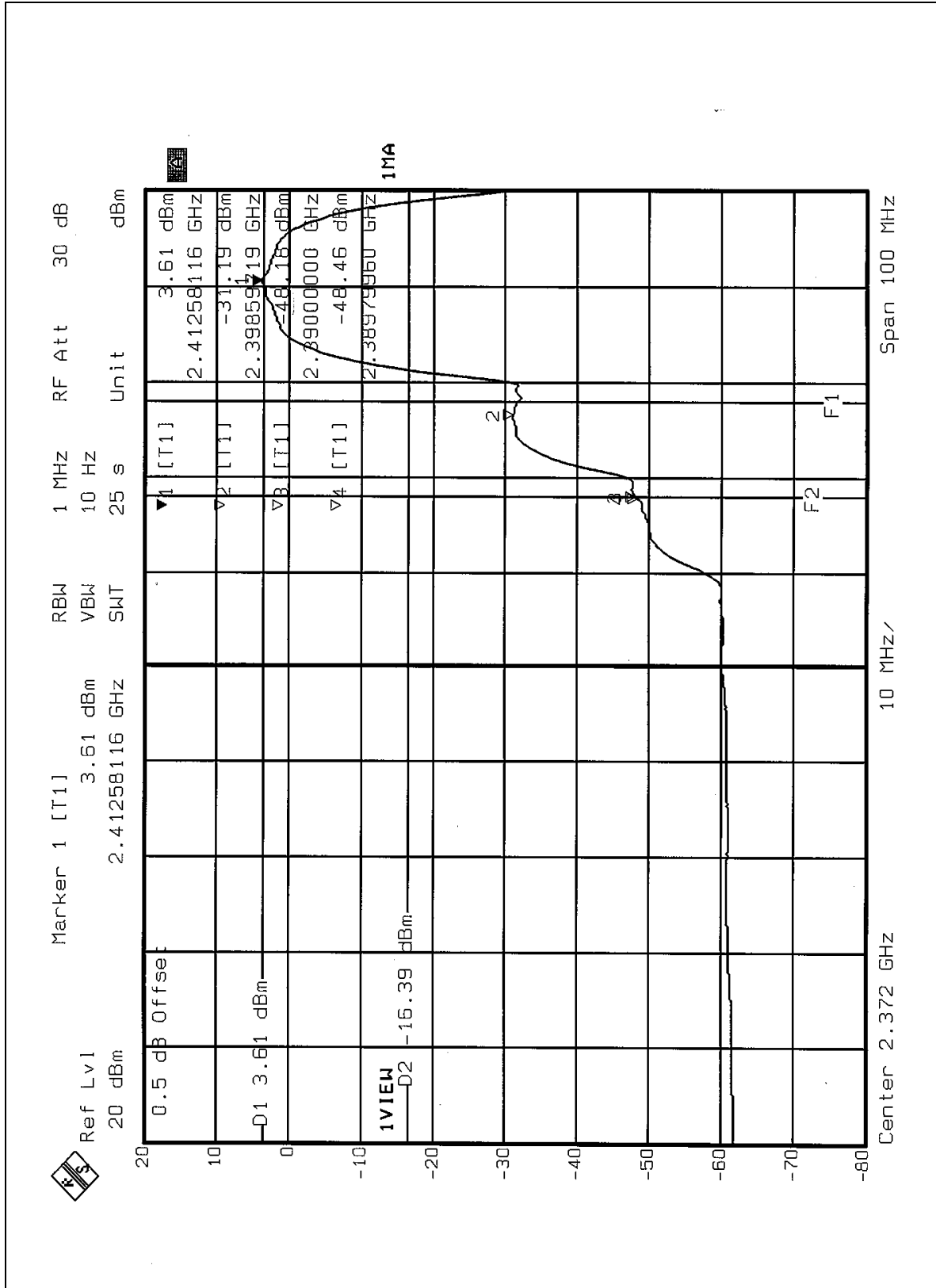

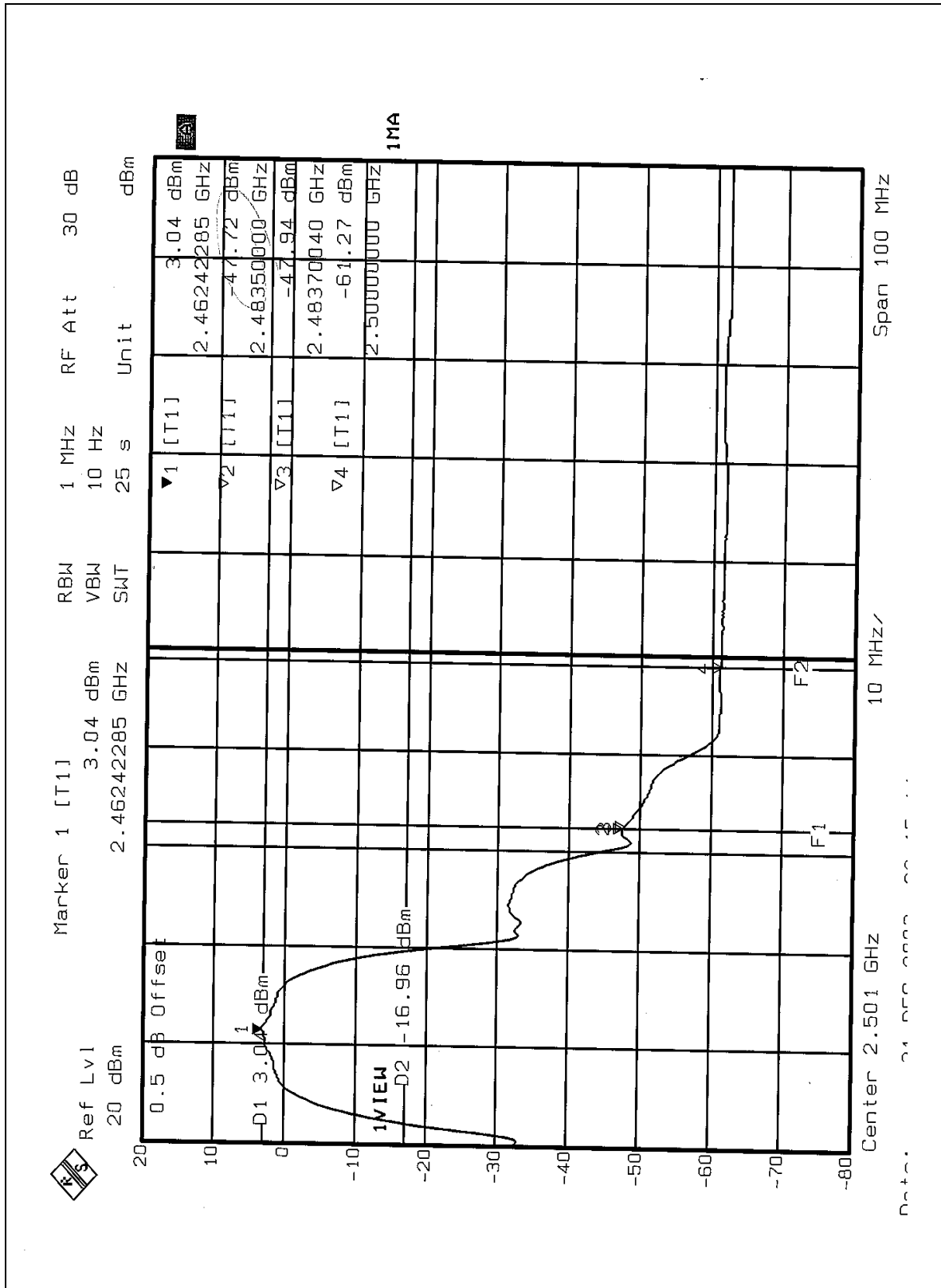



4.7 ANTENNA REQUIREMENT

4.7.1 STANDARD APPLICABLE

For intentional device, according to FCC 47 CFR Section 15.203, an intentional radiator shall be designed to ensure that no antenna other than that furnished by the responsible party shall be used with the device.

And according to FCC 47 CFR Section 15.247 (b), if transmitting antennas of directional gain greater than 6dBi are used, the power shall be reduced by the amount in dB that the directional gain of the antenna exceeds 6dBi.

4.7.2 ANTENNA CONNECTED CONSTRUCTION

The antenna used in this product is Monopole with UFL antenna connector. And the maximum Gain of this antenna is 0.08dBi only.

5 PHOTOGRAPHS OF THE TEST CONFIGURATION CONDUCTED EMISSION TEST



RADIATED EMISSION TEST

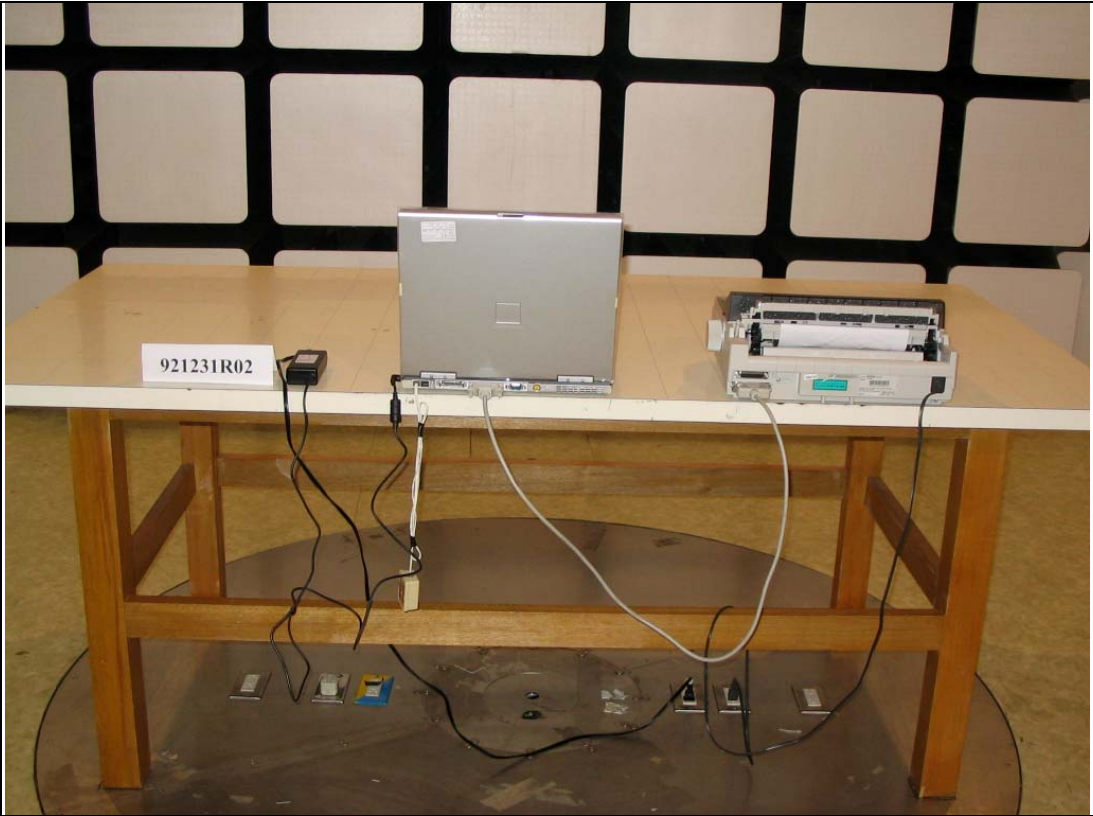



6 INFORMATION ON THE TESTING LABORATORIES

We, ADT Corp., were founded in 1988 to provide our best service in EMC and Safety consultation. Our laboratories are accredited and approved by the following approval agencies according to ISO/IEC 17025, Guide 25 or EN 45001:

USA	FCC, NVLAP
Germany	TUV Rheinland
Japan	VCCI
New Zealand	MoC
Norway	NEMKO
R.O.C.	BSMI, DGT, CNLA

Copies of accreditation certificates of our laboratories obtained from approval agencies can be downloaded from our web site:

www.adt.com.tw/index.5/phtml.

If you have any comments, please feel free to contact us at the following:

Lin Kou EMC Lab:

Tel: 886-2-26052180

Fax: 886-2-26052943

Hsin Chu EMC Lab:

Tel: 886-35-935343

Fax: 886-35-935342

Lin Kou Safety Lab:

Tel: 886-2-26093195

Fax: 886-2-26093184

Lin Kou RF&Telecom Lab

Tel: 886-3-3270910

Fax: 886-3-3270892

Email: service@mail.adt.com.tw

Web Site: www.adt.com.tw

The address and road map of all our labs can be found in our web site also.