

TEST REPORT

For

**Mini PCI Type 3B Single Band 802.11b WLAN Adapter
Model Number: WM3B2100**

*MEASUREMENTS PERFORMED IN ACCORDANCE WITH THE
FOLLOWING EMISSIONS STANDARD*

47 CFR Part 15, Subpart C (Section 15.247)

Test Method:

ANSI C63.4: 1992 American National Standard for Methods of Measurement of Radio-Noise Emissions from Low-Voltage Electrical and Electronic Equipment in the Range of 9 kHz to 40 GHz



CERTIFICATE NUMBER: 1111.01

To view a copy of the Scope of Accreditation visit www.A2LA2.net

PREPARED FOR:

Intel Corporation
2300 Corporate Center Drive
Thousand Oaks, California 91320

Contact(s): James K. Baer

PREPARED BY:

Aegis Labs, Inc.
22431 Antonio Parkway B160-417
Rancho S. Margarita, CA 92688

Agent(s): Mr. Steve Kuiper
Mr. Rick Candelas

Test Report #: **INTEL-021001F**
Test Date: October 1-25, 2002

	REPORT BODY	APPENDICES <i>I</i>	TOTAL
PAGES	19	59	78

The contents of this report shall not be reproduced except in full, without the written approval of Aegis Labs, Inc.

AEGIS LABS, INC 22431 Antonio Parkway B160-417, Rancho Santa Margarita, CA 92688
949-459-7886 TEL 949-459-7869 FAX www.aegislabsinc.com

TABLE OF CONTENTS

SECTION	TITLE	PAGE
	COVER SHEET.....	01
	TABLE OF CONTENTS.....	02
1.0	CERTIFICATION OF TEST DATA.....	03
2.0	ADMINISTRATIVE DATA AND TEST DESCRIPTION.....	04
3.0	DESCRIPTION OF EUT CONFIGURATION.....	05
3.1	EUT Description.....	05
3.1.1	Channel Number and Frequencies.....	06
3.2	EUT Configuration.....	07
3.3	EUT and Sub-Assemblies List.....	08
3.4	Accessory / Host Equipment List.....	08
3.5	Cabling Diagram and Description.....	09
4.0	TEST EQUIPMENT SETTINGS AND TEST SETUPS.....	10
4.1	Conducted Emissions At AC Mains Port.....	10
4.1.1	Conducted Emissions At AC Mains Port – Test Setup.....	11
4.2	Radiated Emissions (Spurious and Harmonics).....	12
4.2.1	Radiated Emissions (Spurious and Harmonics) – Test Setup.....	13
4.3	Occupied Bandwidth Measurement.....	14
4.3.1	Occupied Bandwidth Measurement– Test Setup.....	14
4.4	Maximum Peak Output Power Measurement.....	15
4.4.1	Maximum Peak Output Power Measurement– Test Setup.....	15
4.5	Spectral Power Density Measurement.....	16
4.5.1	Spectral Power Density Measurement– Test Setup.....	16
4.6	Spurious Emissions Measurement At The Antenna Terminal.....	17
4.6.1	Spurious Emissions Measurement At The Antenna Terminal– Test Setup.....	17
4.7	Band Edge Measurement At The Antenna Terminal.....	18
4.7.1	Band Edge Measurement At The Antenna Terminal– Test Setup.....	18
5.0	MODIFICATIONS AND RECOMMENDATIOIS.....	19
APPENDICES		
I	Data Sheets	
II	Accreditation Certificate (Removed to maintain 4.0 MB file upload size limitation)	

1.0 CERTIFICATION OF TEST DATA

Aegis Labs, Inc. operates as both a Nevada and California Corporation with no organizational or financial relationship with any company, institution, or private individual.

Testing and engineering functions provided by Aegis Labs are furnished through the use of part-time, full-time or consulting engineers with the appropriate qualifications to carry out their duties. The intended purpose of this test report is to describe the measurement procedure and to determine whether the equipment under test “EUT” complies with both the conducted and radiated limits. Limits for emissions testing are described under 47 CFR Part 15, Subpart C (Section 15.247).

The data, data evaluation and equipment configuration represented herein are a true and accurate representation of the Equipment Under Test (EUT) under the requirements specified in the emissions standard as described below. The test results contained in this report are only representative of the test sample tested as described in Section 2.0 of this report.

The test results provided within this report, indicate that the information technology equipment has been found to be in **COMPLIANCE** with the test specifications based upon the following RF compliance standards:

Pass/Fail determination is based upon the nominal values of the test data.

EMISSIONS STANDARDS	DESCRIPTION	TEST RESULTS
FCC 47 CFR, Part 15.207	Conducted Emissions At AC Mains Port	PASSED
CISPR22 Class B Limits	Radiated Emissions (30-1000 MHz)	PASSED
FCC 47 CFR, Part 15.247(c), 15.209	Radiated Emissions (1-26.5 GHz)	PASSED
FCC 47 CFR, Part 15.247(a)(2)	Occupied Bandwidth Measurement	PASSED
FCC 47 CFR, Part 15.247(b)	Maximum Peak Output Power Measurement	PASSED
FCC 47 CFR, Part 15.247(d)	Spectral Power Density Measurement	PASSED
FCC 47 CFR, Part 15.247(c)	Spurious Emissions Measurement At The Antenna Terminal	PASSED
FCC 47 CFR, Part 15.247(c)	Band Edge Measurement At The Antenna Terminal	PASSED

Prepared By:



12/02/02

Rick Candelas
Staff Engineer
Aegis Labs, Inc.

Date:

Report Approved By:



12/02/02

Steve J. Kuiper
President
Aegis Labs, Inc.

Date:

2.0 ADMINISTRATIVE DATA AND TEST DESCRIPTION

DEVICE TESTED: Trade Name: Mini PCI Type 3B Single Band 802.11b WLAN Adapter
 Model Number: WM3B2100
 Serial Number: 0004230018AE
 FCC ID: PD9WM3B2100

TEST DATE(S): October 1-25, 2002
DATE EUT RECEIVED: October 1, 2002

ORIGIN OF TEST

SAMPLE(S): Pre-Production

RESPONSIBLE PARTY:	Intel Corporation 2300 Corporate Center Drive Thousand Oaks, California 91320
CLIENT CONTACT:	Mr. Jim Baer
MANUFACTURER:	Intel Corporation

TEST LOCATION: Aegis Labs, Inc.
 32231 Trabuco Creek Road
 Trabuco Canyon, CA 92678
 Conducted Site #2
 Radiated Site #2

A2LA CERTIFICATE:	1111.01, Valid until February 28, 2004
--------------------------	--

PURPOSE OF TEST: To demonstrate compliance with the relevant standards described in Section 1.0 of this report.

TEST(S) PERFORMED: Refer to Table in Section 1 of this report.

All calibration vendors were responsible for certifying Aegis Labs, Inc. test equipment as per the manufacturer's specifications and that the equipment is calibrated using instruments and standards where the accuracy is traceable to the National Institute of Standards and Technology (NIST). Calibration of all test equipment conforms to ANSI/NCSL Z540-1 and ISO 10012-1 and/or ISO/IEC Guide 17025 compliance (Additionally, other pertinent test equipment will carry MIL-STD-45662A). All calibration documents are on file with Aegis Labs, Inc., with copies provided upon request.

3.0 DESCRIPTION OF EUT

3.1 EUT Description

Equipment Under Test (EUT)	
Trade Name:	Mini PCI Type 3B Single Band 802.11b WLAN Adapter
Model Number:	WM3B2100
Frequency Range:	2.412 – 2.462 GHz
Type of Transmission:	Direct Sequence Spread Spectrum
Transfer Rate:	1/5.5/11 Mbps
Number of Channels:	11
Modulation Type:	DBPSK, DQPSK, CCK
Antenna Type:	Hirose U.FL-R-SMT mates with cable connector U.FL-LP-066
Antenna Gain (See Note 2):	Hitachi Antenna = 1.67dBi (gain) – 1.56dB (cable loss) = 0.11dBi Ethertronics Antenna = 1.18dBi with cable loss
Transmit Output Power:	16 dBm (Typical) Please see Appendix I (Data Sheets) for actual output power.
Power Supply:	3.3VDC from computer MPCI slot.
Number of External Test Ports Exercised:	2 Antenna Ports (1 Main & 1 Auxiliary)

The Mini PCI Type 3B Single Band 802.11b WLAN Adapter is an embedded 2.4 GHz Wireless Local Area Network Mini-PCI adapter. The Mini-PCI Type 3B form factor is designed for notebook computer systems where overall thickness must be kept to an absolute minimum. It is capable of a data rate of up to 11 Mbps at 2.4 GHz. Please refer to Section 3.2 of this report for a further description of the configuration tested.

NOTE 1: For a more detailed description, please refer to the manufacture’s specifications or User’s Manual.

NOTE 2: The EUT was tested separately with two different sets of antennas (Hitachi and Ethertronics). The “Hitachi Antenna Specification” list a 1.67dBi peak gain and the “Hitachi Antenna Cable Loss Measurement” list a cable loss of 1.56dB. The “Ethertronics Antenna Specification With Cable Loss” list a 1.18dBi gain, which was measured with the cable installed at the main antenna port. (Refer to each antenna specifications).

3.1.1 Channel Number and Frequencies

Eleven channels are provided for the EUT.

Channel	Frequency (MHz)
1	2412
2	2417
3	2422
4	2427
5	2432
6	2437
7	2442
8	2447
9	2452
10	2457
11	2462

3.2 EUT Configuration

The EUT was set-up according to the ANSI C63.4: 1992 guidelines for emissions testing. For emissions testing the EUT (Mini PCI Type 3B Single Band 802.11b WLAN Adapter, Model Number: WM3B2100) had a loaded antenna connected to both its receive and transmit ports. All the appropriate test ports were exercised during both the pre-qualification and final evaluation scans.

The EUT was tested installed in the Mini-PCI slot of the IBM host computer as a modular device using a PCI extender board to extend the EUT outside the computer chassis. The EUT was then connected to a set of antennas via its transmit and receive Hirose U.FL-R-SMT ports. Data for a set of Hitachi and Ethertronics dual band antennas can be found in Appendix I (Data Sheets)

For conducted emissions at the AC mains port and radiated emissions, the IBM host computer was connected to a Hayes modem, Canon printer, NEC monitor, IBM keyboard, IBM mouse via its serial, parallel, video, keyboard, and mouse ports respectively. For conducted emissions at the antenna port, the IBM host computer as described in the previous configuration with the exception of the modem and printer.

The low (channel 1), middle (channel 6, and high (channel 11) were tested. The EUT was transmitting and receiving on a continuous basis.

The final conducted as well as radiated data was taken in this mode of operation. The external cables were bundled and routed as shown in the photographs in Appendix I (Data Sheets).

3.3 EUT and Sub-Assemblies List

EUT and Sub-Assemblies List			
Manufacturer	Equipment Name	Model Number	Serial Number
Intel Corporation	Mini PCI Type 3B Single Band 802.11b WLAN Adapter	WM3B2100	0004230018AE
Sub-Assemblies			
Hitachi	Dual Band Antenna	None	None
Ethertronics	Dual Band Antenna	PCI01001	10

3.4 Accessory / Host Equipment List

Accessory / Host Equipment List			
Manufacturer	Equipment Name	Model Number	Serial Number
NetVista Computer	IBM	21U	KAOL42K
Monitor	NEC	JC-1575VMA	2Y785821
Keyboard	IBM	SK-8811	1922408
Mouse	IBM	MU295	23-161493
Modem	Hayes	5362US	A02153623145
Printer	Canon	BJC-4200	0048

NOTE: All the power cords of the above support equipment are standard non-shielded, 1.8 meters long.

3.5 Cabling Diagram and Description

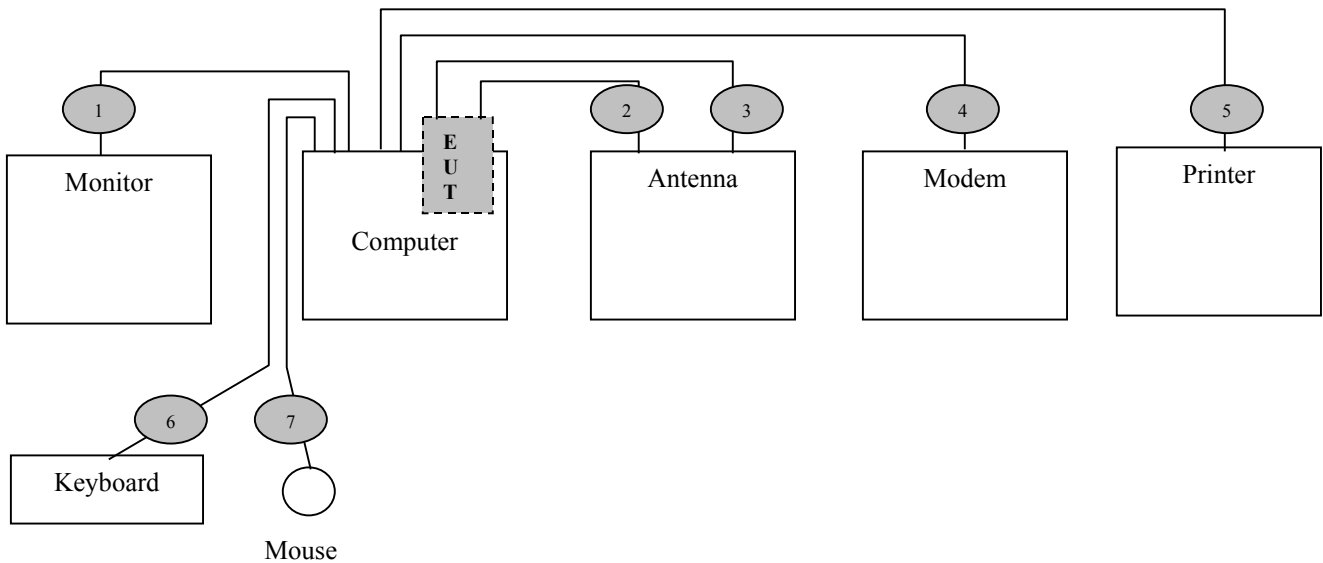

- Cable 1: This is a 6-foot braid and foil shielded round cable connecting the host IBM computer with the NEC monitor. It has metallic DB-15 type connector at the computer end and is hardwired to the monitor. The cable is bundled to a length of one meter and the shield of the cable is grounded to the chassis of both devices via the connector shells.
- Cables 2-3: These are rolled copper with Kapton tape on both sides round coax cables connecting the EUT transmit and receive antenna ports to the loaded antennas. They have a metallic Hirose U.FL-LP-006 type of connectors at the EUT end and are hardwired to the loaded antennas.
- Cable 4: This is a 6-foot braid and foil shielded round cable connecting the IBM host computer to the Hayes modem. It has a metallic DB-9 type connector at the computer end and a metallic DB-25 type connector at the modem end. The cable is bundled to a length of one meter and the shield of the cable is grounded to the chassis of both devices via the connector shells.
- Cable 5: This is a 6-foot braid and foil shielded round cable connecting the IBM host computer to the Canon printer. It has a metallic DB-25 type connector at the computer end and a metallic 36-pin centronics type connector at the printer end. The cable is bundled to a length of one meter and the shield of the cable is grounded to the chassis of both devices via the connector shells.
- Cable 6: This is a 1-meter foil shielded round cable connecting the IBM host computer to the IBM keyboard. It has a metallic 6 pin Mini DIN type connector at the computer end and is hardwired at the keyboard end. The shield of the cable is grounded to the chassis via the connector shell.
- Cable 7: This is a 1-meter foil shielded round cable connecting the IBM host computer to the IBM mouse. It has a metallic 6 pin Mini DIN type connector at the computer end and is hardwired at the mouse end. The shield of the cable is grounded to the chassis via the connector shell.

4.0 TEST EQUIPMENT AND TEST SETUPS

The test equipment settings and functions are selected using the guidance of ANSI C63.4-1992. All test equipment setups and operations during conducted and radiated emissions testing are in accordance with this reference document.

4.1 Conducted Emissions At AC Mains Port

During conducted emissions measurements, a spectrum analyzer was used as the measuring instrument along with a preselector and quasi-peak detector. A 10 dB attenuation pad was used for the protection of the spectrum analyzer input stage. The conducted emissions from the EUT in the frequency range from 150 kHz to 30 MHz were captured for graphical display through the use of automated LABVIEW EMI measurement software. All graphical readings were measured in the “Peak” mode only to reduce testing time. Upon completion of the graphical scan, the test lab personnel performed the conducted measurement scan manually using the spectrum analyzer front panel keys. All peak measurements coming within 3 dB of the limit line were “Averaged” and/or “Quasi-Peaked” and denoted appropriately in the EXCEL spreadsheet.

The Equipment Under Test (EUT) was configured as a system with peripherals connected, so that at least one interface port of each type is connected to one external peripheral when tested for conducted emissions according to ANSI C63.4: 1992. The EUT was tested in a tabletop configuration.

The six highest emission readings for Line 1 and Line 2 are highlighted on the data sheets in Appendix I. The graphical scans only reflects peak readings while the tabulated data sheets reflect peak, average, and/or quasi-peak readings which ever applies.

4.1.1 Conducted Emissions At AC Mains Port – Test Setup

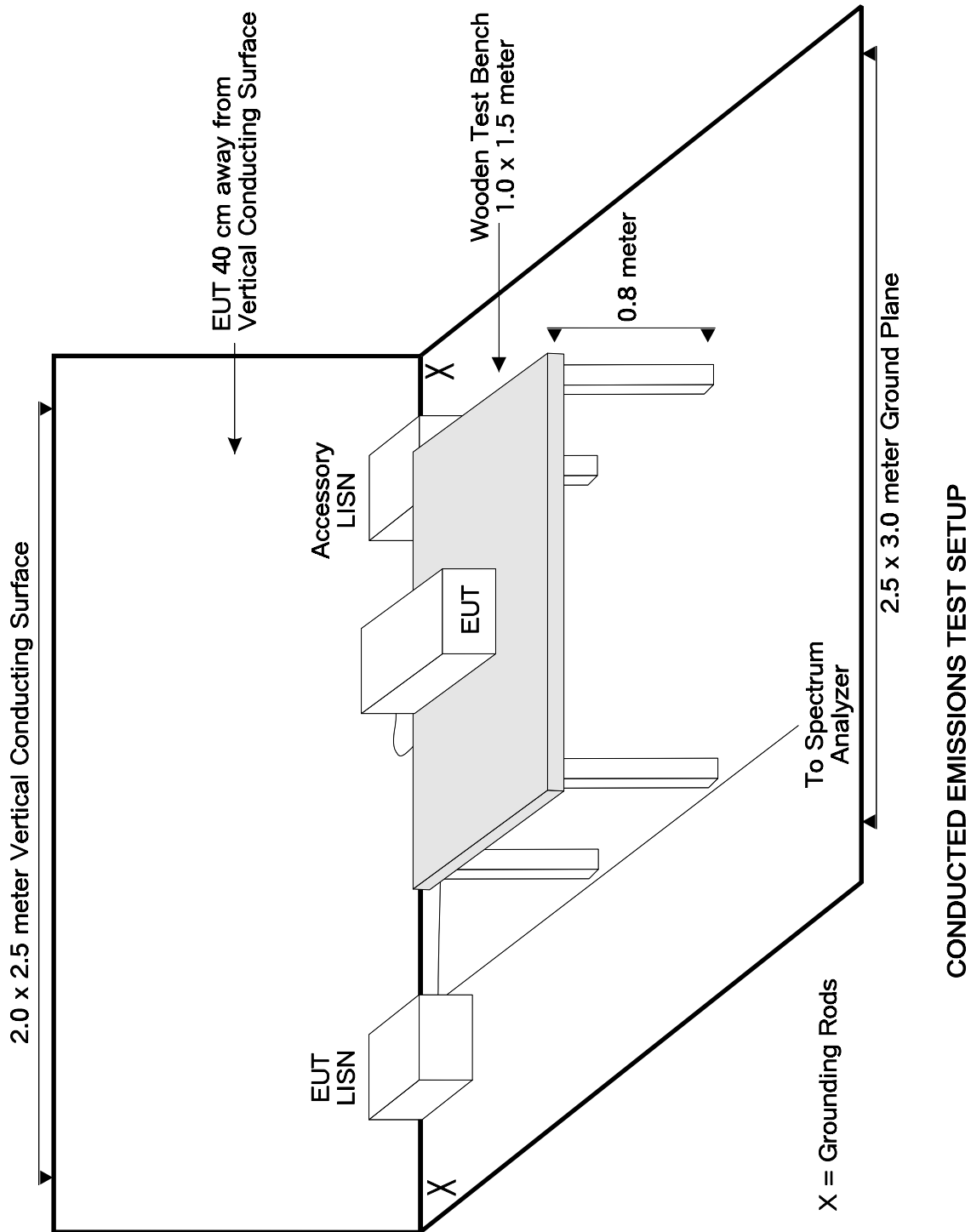

4.2 Radiated Emissions (Spurious and Harmonics)

A spectrum analyzer was used as the measuring instrumentation along with a preselector and quasi-peak-detector. The pre-amplifiers were used to increase the sensitivity of the instrument. The spectrum analyzer was used in the peak detector mode with the “max-hold” feature activated and in Positive Peak mode. In this mode, the spectrum analyzer records the highest measured reading over all the sweeps. The quasi-peak detector was used only for those readings, which are marked accordingly in the data sheet. The effective measurement bandwidth used for the radiated emissions test was 120 kHz for (30 MHz- 1000 MHz). The spectrum analyzer operated such that the modulation of the signal was filtered out to set the analyzer in linear mode. For testing beyond 1000 MHz a spectrum analyzer capable of taking reading above 1000 MHz was connected to the high frequency amplifier, where these measurement readings were taken with the transducer placed at a 3-meter test distance from the EUT.

The Open Area Test Sites (OATS) was used for radiated emission testing. These test sites are designed according to ANSI C63.4: 1992 and ANSI C63.7: 1992 guidelines. The Measurements were conducted in accordance with ANSI C63.4: 1992 and ANSI C63.7: 1992 requirements.

Broadband biconical, log periodic, and horn antennas were used as transducers during the measurement reading phase. The frequency spans were wide (30 MHz-88 MHz, 88 MHz-216 MHz, 216 MHz- 300 MHz, and 300 MHz- 1000 MHz). After 1000 MHz the horn antenna was used to measure emissions. The six highest emission readings in both horizontal and vertical polarities are highlighted on the data sheets in Appendix I.

4.3 Occupied Bandwidth Measurement

A spectrum analyzer was used to measure the occupied bandwidth. The bandwidth was measured using a direct connection from the RF output port of the EUT to the spectrum analyzer using a low loss cable and a DC block. The resolution bandwidth was 100 kHz and the video bandwidth was 300 kHz.

The EUT bandwidth is at least 500 kHz. Please refer to Appendix I for graphical plots.

4.3.1 Occupied Bandwidth Measurement – Test Setup

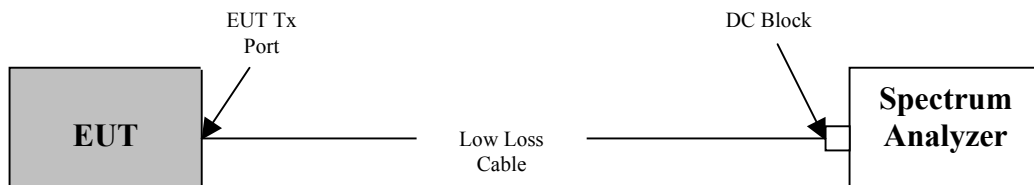

4.4 Maximum Peak Output Power Measurement

A power meter along with a power sensor was used to measure the maximum peak output power. The low (channel 1), middle (channel 6), and high (channel 11) were measured as well as data rates 1, 5.5, and 11 Mbps.

The EUT maximum peak output power is less than 1 Watt. Please refer to Appendix I for the data sheets.

4.4.1 Maximum Peak Output Power Measurement – Test Setup

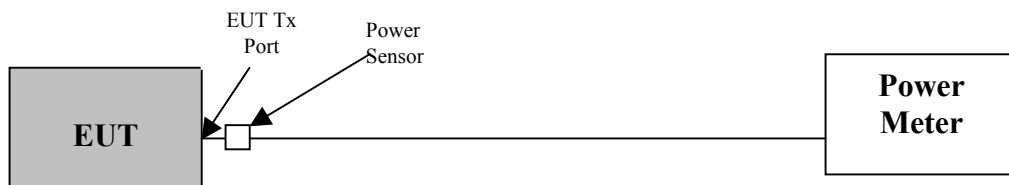

4.5 Spectral Power Density Measurement

A spectrum analyzer was used to measure the spectral power density. It was measured using a direct connection from the RF output port of the EUT to the spectrum analyzer using a low loss cable and a DC block. The resolution bandwidth was 3 kHz and the video bandwidth was 10 kHz. The highest 4.5 MHz of the signal was used as the frequency span with the sweep rate being 1 second for every 3 kHz of span.

The EUT spectral power density does not exceed 8 dBm in any 3 kHz band. Please refer to Appendix I for graphical plots.

4.5.1 Spectral Power Density Measurement – Test Setup

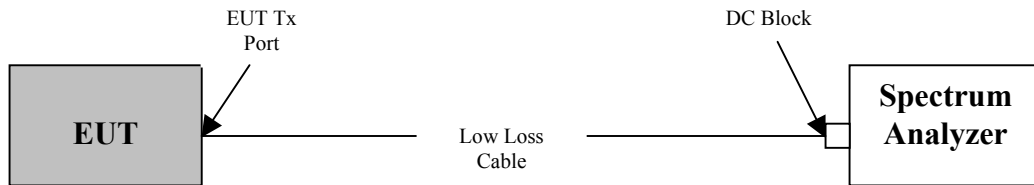

4.6 Spurious Emissions Measurement At The Antenna Terminal

A spectrum analyzer was used to measure the spurious emissions at the antenna terminal. It was measured using a direct connection from the RF output port of the EUT to the spectrum analyzer using a low loss cable and a DC block. The resolution bandwidth was 1 MHz and the video bandwidth was 300 kHz. The spans were wide enough to include all the harmonics and emissions that were produced by the intentional radiator.

The EUT RF power that is produced in any 100 kHz bandwidth outside the frequency band in which the spread spectrum intentional radiator is operating, the radio frequency power that is produced by the intentional radiator is at least 20 dB below that in the 100 kHz bandwidth within the band that contains the highest level of the desired power. Please refer to Appendix I for graphical plots.

4.6.1 Spurious Emissions Measurement At The Antenna Terminal – Test Setup

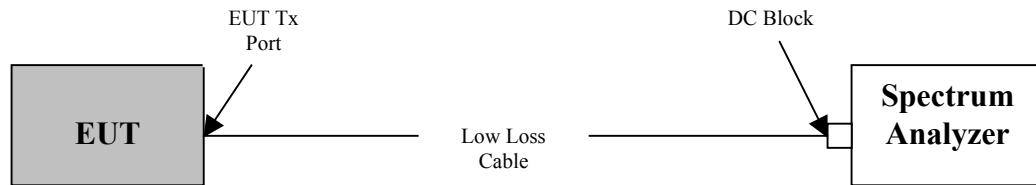

4.7 Band Edge Measurement At The Antenna Terminal

A spectrum analyzer was used to measure the band edge measurements at the antenna terminal with the EUT transmitting at 2412 MHz (channel 1) and 2462 MHz (channel 11). It was measured using a direct connection from the RF output port of the EUT to the spectrum analyzer using a low loss cable and a DC block. The resolution bandwidth was 1 MHz and the video bandwidth was 1 MHz. It was verified that the band edge measurements were not above the limit in the restricted bands below 2390 MHz and above 2483.5 MHz. Please refer to Appendix I for graphical plots.

4.7.1 Band Edge Measurement At The Antenna Terminal – Test Setup

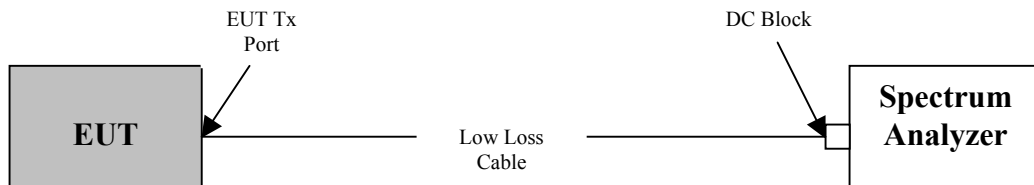

5.0 MODIFICATIONS AND RECOMMENDATIONS

There were no modifications done to the EUT.

APPENDIX I

DATA SHEETS

CONDUCTED EMISSIONS AT AC MAINS PORT

CLIENT:	Intel Corporation	DATE:	10/10/02
EUT:	Mini PCI Type 3B Single Band 802.11b WLAN Adapter	PROJECT NUMBER:	INTEL-021001-18
MODEL NUMBER:	WM3B2100	TEST ENGINEER:	Rick Candelas
SERIAL NUMBER:	0004230018AE	SITE #:	2
CONFIGURATION:	Installed in IBM NetVista Desktop Computer, SN: KAOL42K	TEMPERATURE:	23 C
		HUMIDITY:	50% RH
		TIME:	2:00 PM

Standard:	FCC CFR 47, Part 15.207
Description:	AC Power Conducted Emissions
Results:	Passes FCC Limits

NOTE: During preliminary scans, there wasn't any difference which channel, data rate, or which set of antennas were used with the EUT, therefore only Channel 1 at a data rate of 1 Mbps with the Ethertronics antennas were used for final testing.

CONDUCTED EMISSIONS AT AC MAINS PORT (Continued)

FCC CLASS B CONDUCTED EMISSIONS – LINE 1						
<i>Freq. (MHz)</i>	<i>Meter Reading (dBuV)</i>	<i>Detector (PK/QP/AV)</i>	<i>Average Limit (dBuV)</i>	<i>Average Delta(dB)</i>	<i>Quasi-Peak Limit (dBuV)</i>	<i>Quasi-Peak Delta(dB)</i>
0.2010	48.70	PK	54.54	-5.84	64.54	-15.84
0.2040	49.30	PK	54.46	-5.16	64.46	-15.16
0.4070	42.70	PK	48.66	-5.96	58.66	-15.96
0.4100	42.90	PK	48.57	-5.67	58.57	-15.67
16.5000	38.70	PK	50.00	-11.30	60.00	-21.30
17.9000	38.40	PK	50.00	-11.60	60.00	-21.60

FCC CLASS B CONDUCTED EMISSIONS – LINE 2						
<i>Freq. (MHz)</i>	<i>Meter Reading (dBuV)</i>	<i>Detector (PK/QP/AV)</i>	<i>Average Limit (dBuV)</i>	<i>Average Delta(dB)</i>	<i>Quasi-Peak Limit (dBuV)</i>	<i>Quasi-Peak Delta(dB)</i>
0.2010	49.40	PK	54.54	-5.14	64.54	-15.14
0.2050	50.00	PK	54.43	-4.43	64.43	-14.43
0.4070	42.60	PK	48.66	-6.06	58.66	-16.06
0.4110	43.30	PK	48.54	-5.24	58.54	-15.24
17.8000	39.40	PK	50.00	-10.60	60.00	-20.60
17.9300	38.50	PK	50.00	-11.50	60.00	-21.50

CONDUCTED EMISSIONS AT AC MAINS PORT (Continued)

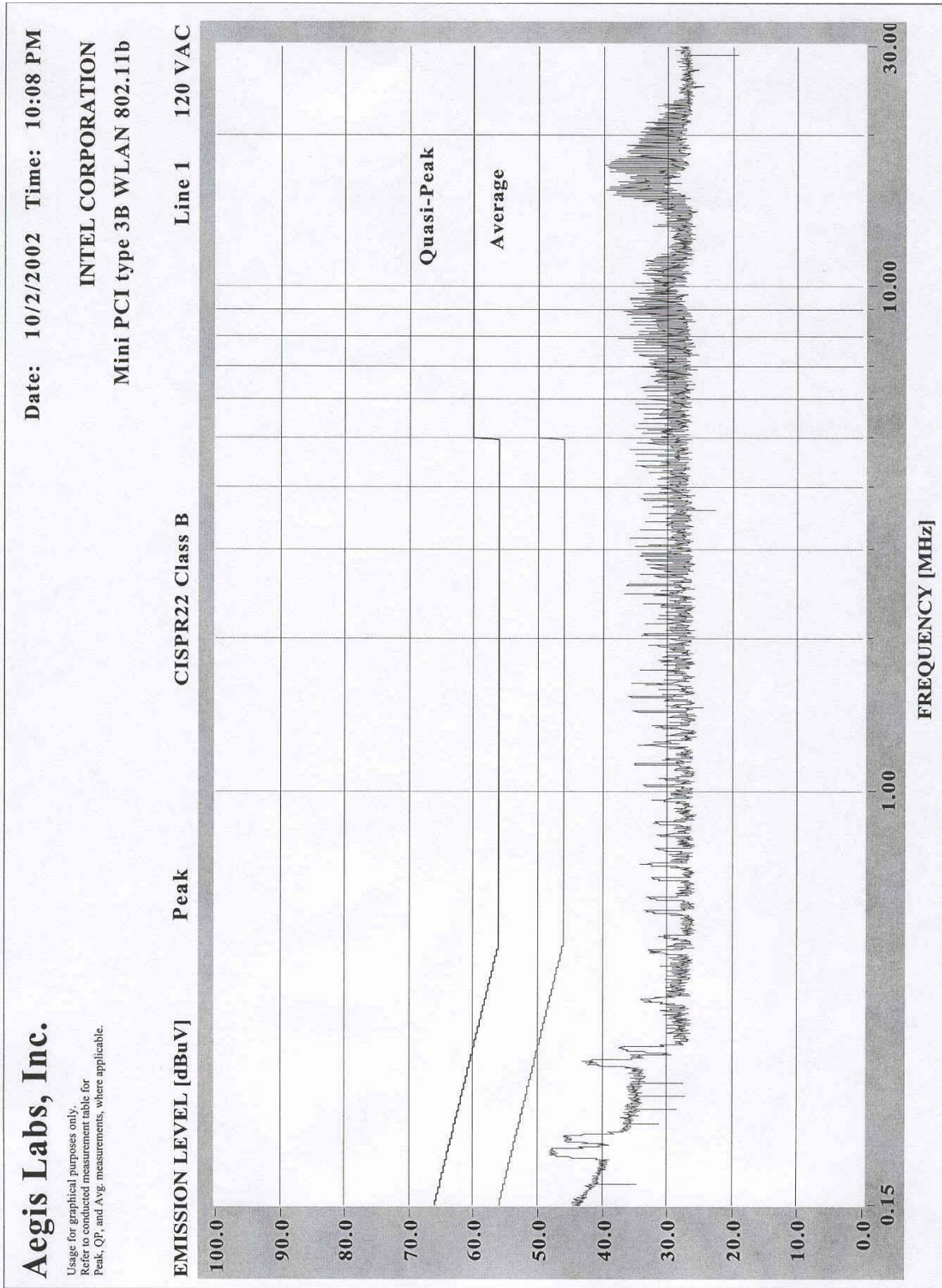

CONDUCTED EMISSIONS AT AC MAINS PORT (Continued)

Aegis Labs, Inc.

Usage for graphical purposes only.
Refer to conducted measurement table for
Peak, QP, and Avg. measurements, where applicable.

Date: 10/2/2002 Time: 10:20 PM

INTEL CORPORATION
Mini PCI type 3B WLAN 802.11b

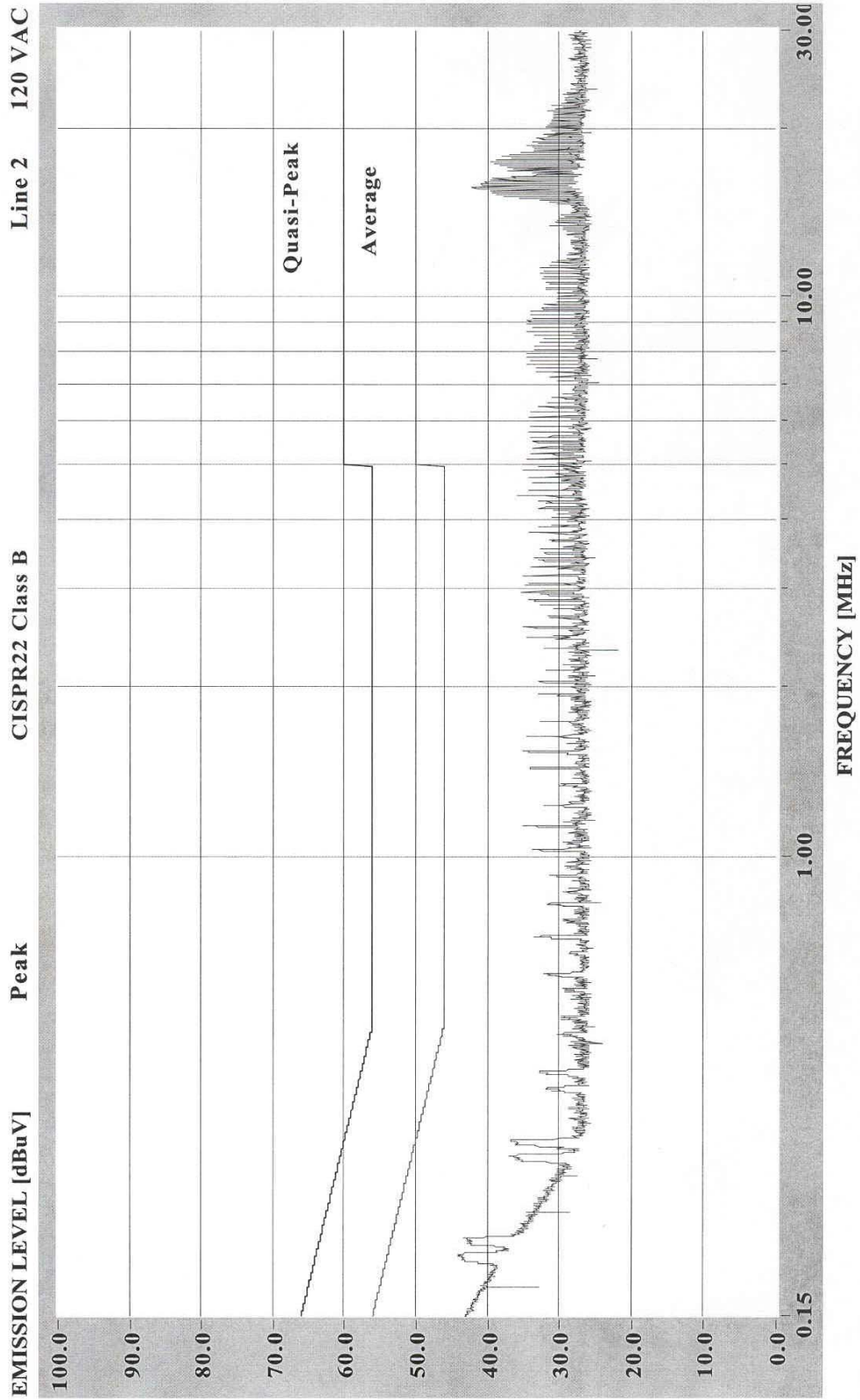

CONDUCTED EMISSIONS AT AC MAINS PORT (Continued)

TEST EQUIPMENT USED					
Equipment Name	Manufacturer	Model Number	Serial Number	Calibration Due Date	Calibration Cycle
Spectrum Analyzer - RF Section	Hewlett Packard	8568B	2634A03093	11/27/02	1 Year
Spectrum Analyzer - Display Section	Hewlett Packard	85662A	1833A00389	11/27/02	1 Year
Quasi-Peak Adapter	Hewlett Packard	85650A	2043A00220	11/28/02	1 Year
RF Preselector	Hewlett Packard	85685A	2620A00281	05/10/03	1 Year
Attenuator - 5W-10dB	Pasternack	PE7014-10	N/A	11/03/02	1 Year
LISN (EUT)	FCC	FCC-LISN-50-25-2	9931	12/12/02	1 Year
LISN (Access)	Com-Power	LI-200	12019	01/25/03	1 Year
LISN (Access)	Com-Power	LI-200	12018	01/25/03	1 Year
Temperature/Humidity Monitor	Dickson	TH550	7255185	01/08/03	1 Year

ACCESSORIES EQUIPMENT			
Equipment Name	Manufacturer	Model Number	Serial Number
NetVista Computer	IBM	21U	KAOL42K
Monitor	NEC	JC-1575VMA	2Y785821
Keyboard	IBM	SK-8811	1922408
Mouse	IBM	MU295	23-161493
Modem	Hayes	5362US	A02153623145
Printer	Canon	BJC-4200	001

BLOCK DIAGRAM

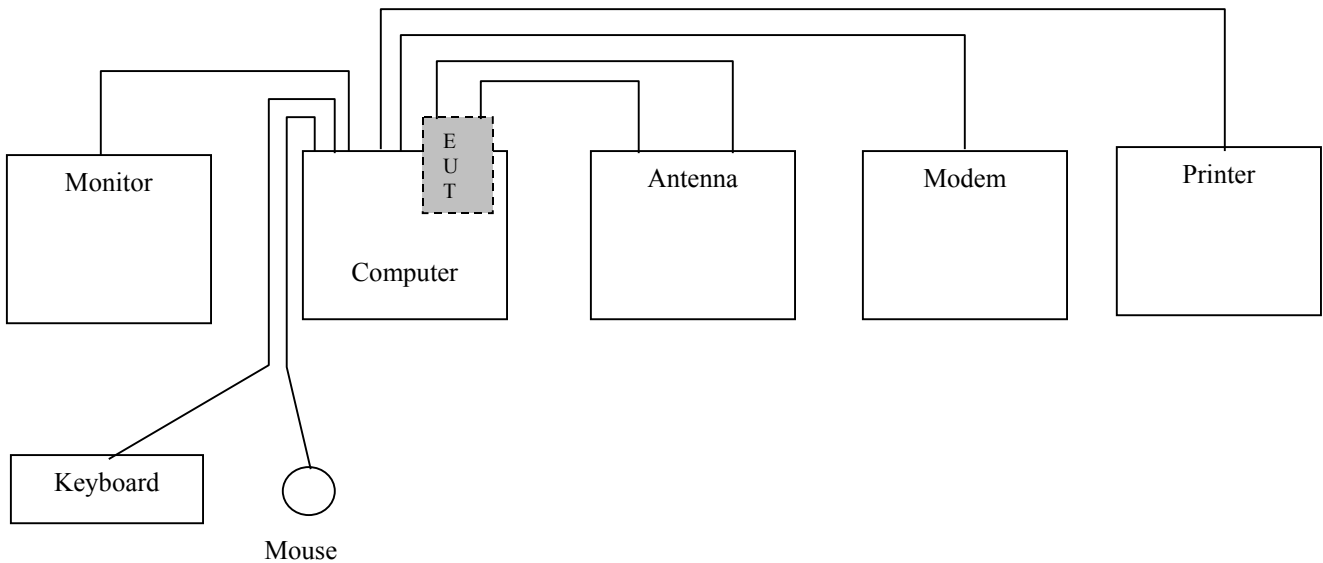

CONDUCTED EMISSIONS AT AC MAINS PORT (Continued)

PHOTOGRAPHS

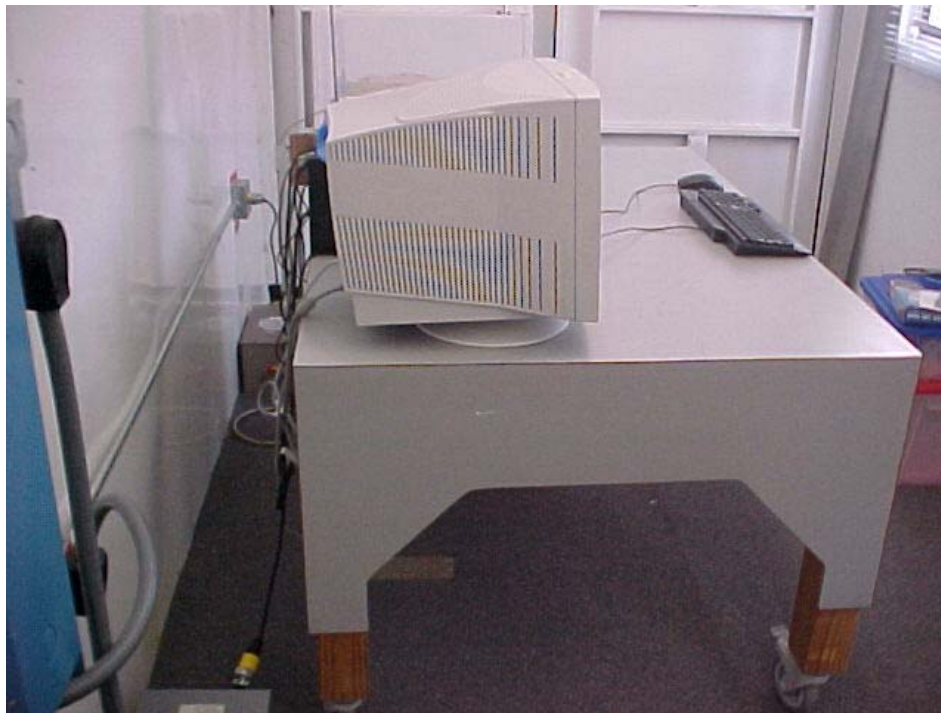

RADIATED EMISSIONS (SPURIOUS AND HARMONICS)

CLIENT:	Intel Corporation	DATE:	10/24/02
EUT:	Mini PCI Type 3B Single Band 802.11b WLAN Adapter	PROJECT NUMBER:	INTEL-021001-25
MODEL NUMBER:	WM3B2100	TEST ENGINEER:	Rick Candelas
SERIAL NUMBER:	0004230018AE	SITE #:	2
CONFIGURATION:	Installed in IBM NetVista Desktop Computer, SN: KAOL42K	TEMPERATURE:	18 C
		HUMIDITY:	50% RH
		TIME:	3:30 PM

Standard:	CISPR22 Class B Limits
Description:	Spurious Emissions Measurements - Radiated
Results:	-4.30 dB margin @ 99.61 MHz

NOTE: During preliminary scans, there wasn't any difference which channel, data rate, or which set of antennas were used with the EUT, therefore only Channel 1 at a data rate of 1 Mbps with the Ethertronics antennas were used for final testing.

RADIATED EMISSIONS (SPURIOUS AND HARMONICS) (Continued)

Horizontal Open Field Maximized Data							
<i>Freq. (MHz)</i>	<i>Meter Reading (dBuV)</i>	<i>Antenna Height (cm)</i>	<i>Azimuth (degrees)</i>	<i>Quasi pk or AVG (dBuV)</i>	<i>Corrected Reading (dBuV)</i>	<i>Limits (dBuV)</i>	<i>Diff (dB) +=FAIL</i>
33.20	33.20	300	180		17.66	30.00	-12.34
99.52	42.10	400	90		19.69	30.00	-10.31
110.03	36.50	400	315		16.05	30.00	-13.95
132.03	37.80	400	225		19.76	30.00	-10.24
176.03	37.40	400	225		21.75	30.00	-8.25
199.77	32.90	400	180		17.89	30.00	-12.11
233.20	35.60	400	135		21.46	37.00	-15.54
264.02	39.90	300	180		26.86	37.00	-10.14
308.04	46.50	250	90		29.70	37.00	-7.30
320.05	39.60	250	270		23.32	37.00	-13.68
336.06	41.00	250	225		25.02	37.00	-11.98
352.05	38.90	200	270		23.05	37.00	-13.95
366.50	38.40	200	180		22.80	37.00	-14.20
368.10	36.20	200	180		20.63	37.00	-16.37
384.09	36.90	150	270		21.75	37.00	-15.25
396.03	36.00	150	270		21.25	37.00	-15.75
400.19	36.30	150	225		21.68	37.00	-15.32
432.07	37.20	150	225		23.28	37.00	-13.72

Vertical Open Field Maximized Data							
<i>Freq. (MHz)</i>	<i>Meter Reading (dBuV)</i>	<i>Antenna Height (cm)</i>	<i>Azimuth (degrees)</i>	<i>Quasi pk or AVG (dBuV)</i>	<i>Corrected Reading (dBuV)</i>	<i>Limits (dBuV)</i>	<i>Diff (dB) +=FAIL</i>
33.37	31.90	100	0		16.30	30.00	-13.70
53.90	45.90	100	270		23.17	30.00	-6.83
99.61	48.10	100	90		25.70	30.00	-4.30
110.04	43.00	100	90		22.55	30.00	-7.45
132.03	38.30	100	45		20.26	30.00	-9.74
199.91	33.90	100	90		18.89	30.00	-11.11
231.95	38.60	100	45		24.43	37.00	-12.57
264.04	42.50	100	180		29.47	37.00	-7.53
308.04	46.60	100	90		29.80	37.00	-7.20
320.06	40.20	100	0		23.92	37.00	-13.08
336.09	44.10	100	0		28.12	37.00	-8.88
352.06	44.70	100	90		28.85	37.00	-8.15
366.19	41.20	100	315		25.60	37.00	-11.40
368.09	42.20	100	45		26.63	37.00	-10.37
384.10	38.40	100	0		23.25	37.00	-13.75
396.04	43.60	100	315		28.85	37.00	-8.15
400.16	42.80	100	315		28.18	37.00	-8.82
432.01	43.00	100	180		29.08	37.00	-7.92

RADIATED EMISSIONS (SPURIOUS AND HARMONICS) (Continued)

TEST EQUIPMENT USED					
Equipment Name	Manufacturer	Model Number	Serial Number	Calibration Due Date	Calibration Cycle
Spectrum Analyzer - RF Section	Hewlett Packard	8568B	2634A03093	11/27/02	1 Year
Spectrum Analyzer - Display Section	Hewlett Packard	85662A	1833A00389	11/27/02	1 Year
Quasi-Peak Adapter	Hewlett Packard	85650A	2043A00220	11/28/02	1 Year
RF Preselector	Hewlett Packard	85685A	2620A00281	05/10/03	1 Year
Preamplifier	Com-Power	PA-102	1438	04/29/03	1 Year
Cable - 10m underground	Andrew	N/A	N/A	11/03/03	1 Year
Antenna - Biconical	EMCO	3110	9108-1421	10/02/03	1 Year
Antenna - Log Periodic	EMC Test Systems	3148	4947	10/12/03	1 Year
Temperature/Humidity Monitor	Dickson	TH550	7255185	01/08/03	1 Year

EUT ACCESSORIES			
Equipment Name	Manufacturer	Model Number	Serial Number
NetVista Computer	IBM	21U	KAOL42K
Monitor	NEC	JC-1575VMA	2Y785821
Keyboard	IBM	SK-8811	1922408
Mouse	IBM	MU295	23-161493
Modem	Hayes	5362US	A02153623145
Printer	Canon	BJC-4200	001

BLOCK DIAGRAM

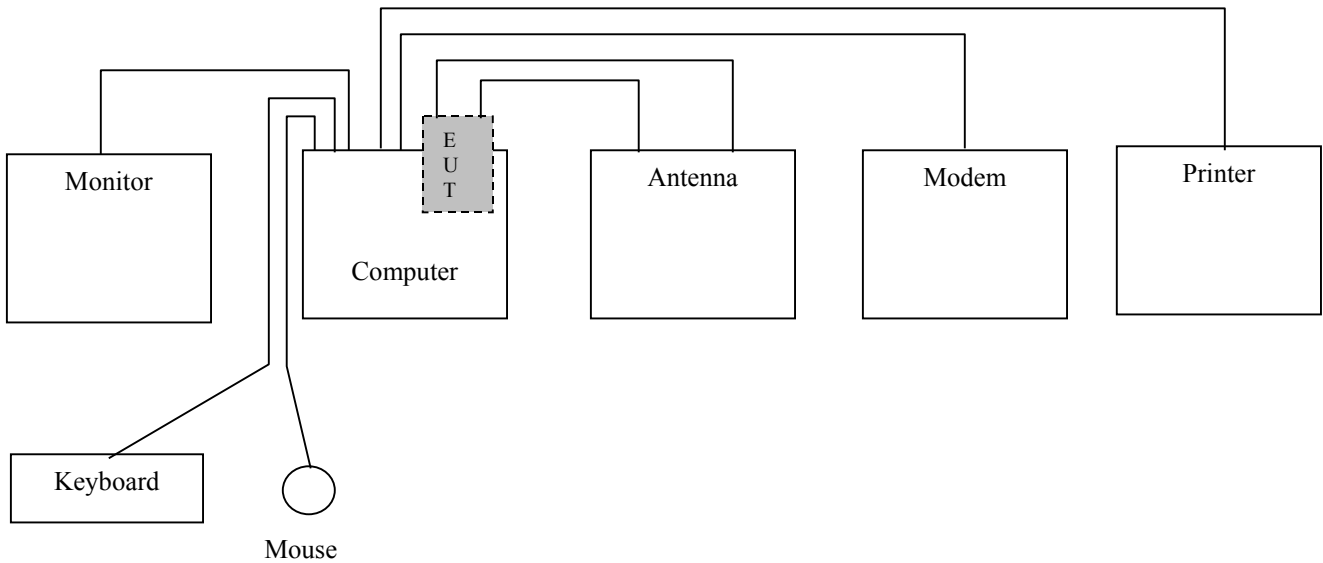

RADIATED EMISSIONS (SPURIOUS AND HARMONICS) (Continued)

PHOTOGRAPHS

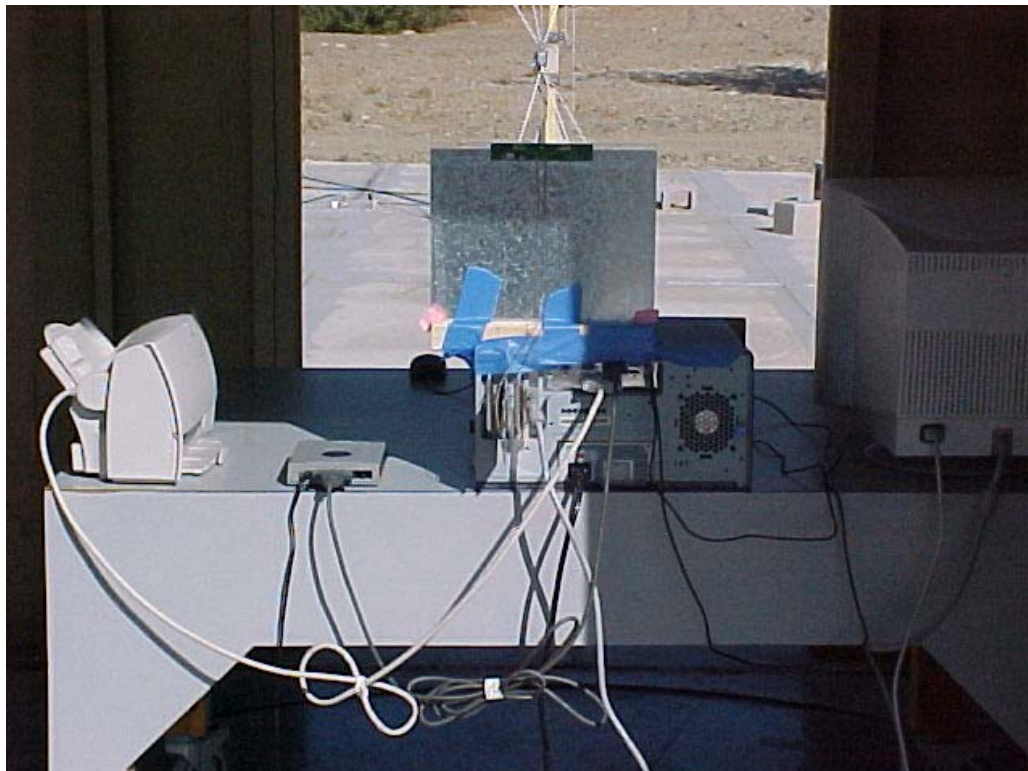
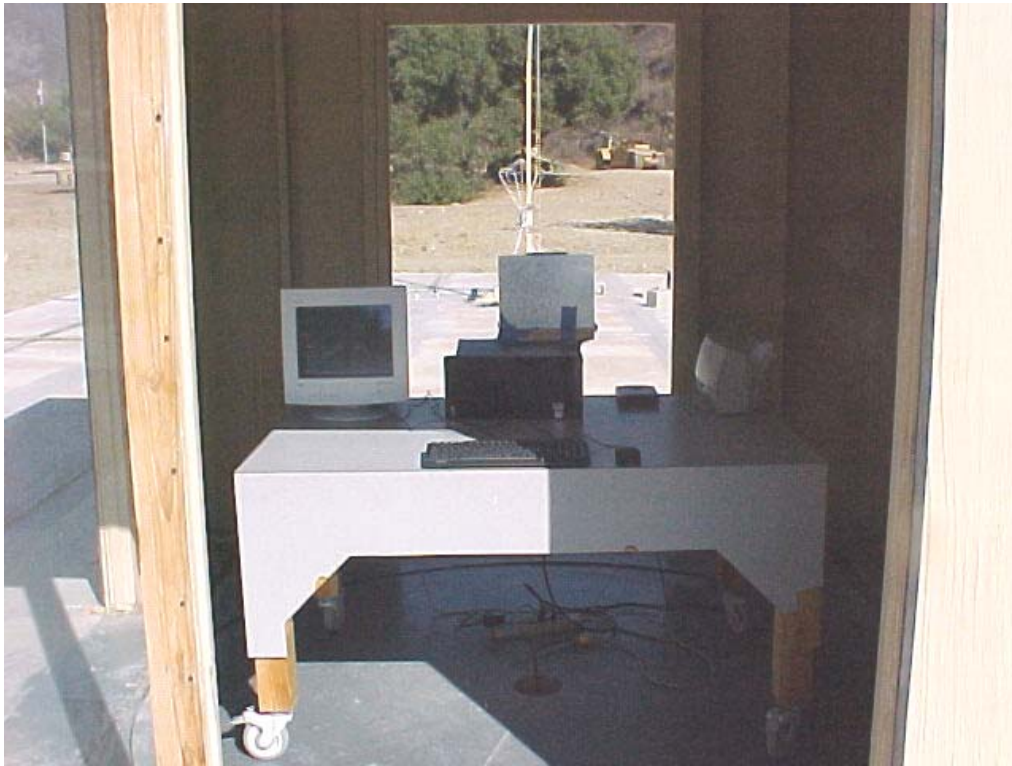

RADIATED EMISSIONS (SPURIOUS AND HARMONICS) (Continued)

CLIENT:	Intel Corporation	DATE:	10/23/02
EUT:	Mini PCI Type 3B Single Band 802.11b WLAN Adapter	PROJECT NUMBER:	INTEL-021001
MODEL NUMBER:	WM3B2100	TEST ENGINEER:	Rick Candelas
SERIAL NUMBER:	0004230018AE	SITE #:	2
CONFIGUARTION:	Installed in IBM NetVista Desktop Computer, SN: KAOL42K	TEMPERATURE:	20 C
		HUMIDITY:	44% RH
		TIME:	10:30 AM

Standard:	FCC CFR 47, Part 15, 15.247(c), 15.209
Description:	Spurious Emissions Measurements - Radiated
Results:	In any 100 kHz bandwidth outside the frequency band in which the spread spectrum intentional radiator is operating, the radio frequency power that is produced by the intentional radiator is at least 20 dB below that in the 100 kHz bandwidth within the band that contains the highest level of the desired power, based on either an RF conducted or a radiated measurement.

RADIATED EMISSIONS (SPURIOUS AND HARMONICS) (Continued)

*Fundamental and Band Edge Measurements at Channels 1, 6, & 11
with Hitachi Dual Band Antennas
INTEL-021001-20*

Horizontal Open Field Maximized Data								
<i>Freq. (MHz)</i>	<i>Meter Reading (dBuV)</i>	<i>Antenna Height (cm)</i>	<i>Azimuth (degrees)</i>	<i>Quasi pk or AVG (dBuV)</i>		<i>Corrected Reading (dBuV)</i>	<i>Limits (dBuV)</i>	<i>Diff (dB) +=FAIL</i>
2411.03	77.17	100	225			110.80		
2390.00	30.33	100	225			63.89	74.00	-10.11
2390.00				19.29	A	52.85	54.00	-1.15
2436.00	76.67	100	225			110.37		
2461.02	74.83	100	135			108.61		
2483.50	29.67	100	135			63.52	74.00	-10.48
2483.50				18.75	A	52.60	54.00	-1.40

Vertical Open Field Maximized Data								
<i>Freq. (MHz)</i>	<i>Meter Reading (dBuV)</i>	<i>Antenna Height (cm)</i>	<i>Azimuth (degrees)</i>	<i>Quasi pk or AVG (dBuV)</i>		<i>Corrected Reading (dBuV)</i>	<i>Limits (dBuV)</i>	<i>Diff (dB) +=FAIL</i>
2411.00	75.00	100	90			108.63		
2390.00	30.33	100	90			63.89	74.00	-10.11
2390.00				17.88	A	51.44	54.00	-2.56
2435.99	76.50	250	90			110.20		
2461.01	75.83	250	90			109.61		
2483.50	30.17	250	90			64.02	74.00	-9.98
2483.50				18.44	A	52.29	54.00	-1.71

RADIATED EMISSIONS (SPURIOUS AND HARMONICS) (Continued)

*Harmonic Measurements at Channels 1, 6, & 11 with Hitachi Dual Band Antennas
INTEL-021001-21*

Horizontal Open Field Maximized Data								
<i>Freq. (MHz)</i>	<i>Meter Reading (dBuV)</i>	<i>Antenna Height (cm)</i>	<i>Azimuth (degrees)</i>	<i>Quasi pk or AVG (dBuV)</i>		<i>Corrected Reading (dBuV)</i>	<i>Limits (dBuV)</i>	<i>Diff (dB) +=FAIL</i>
4823.96	46.50	100	135			50.75	74.00	-23.25
4823.96				38.71	A	42.96	54.00	-11.04
7240.01	49.67	100	90			57.89	74.00	-16.11
7240.01				41.94	A	50.16	54.00	-3.84
9648.07	45.50	100	90			54.67	90.80	-36.13
4873.87	43.50	100	180			47.87	74.00	-26.13
4873.87				33.23	A	37.60	54.00	-16.40
7307.93	46.17	100	135			54.49	74.00	-19.51
7307.93				35.72	A	44.04	54.00	-9.96
9748.12	47.00	200	135			56.29	90.37	-34.08
4924.00	45.00	225	135			49.48	74.00	-24.52
4924.00				38.36	A	42.84	54.00	-11.16
7389.77	45.33	100	45			53.77	74.00	-20.23
7389.77				33.10	A	41.54	54.00	-12.46
9848.05	45.50	100	90			54.91	88.61	-33.70

Vertical Open Field Maximized Data								
<i>Freq. (MHz)</i>	<i>Meter Reading (dBuV)</i>	<i>Antenna Height (cm)</i>	<i>Azimuth (degrees)</i>	<i>Quasi pk or AVG (dBuV)</i>		<i>Corrected Reading (dBuV)</i>	<i>Limits (dBuV)</i>	<i>Diff (dB) +=FAIL</i>
4824.08	47.33	100	180			51.58	74.00	-22.42
4824.08				40.83	A	45.08	54.00	-8.92
7239.56	47.00	200	270			55.22	74.00	-18.78
7239.56				38.48	A	46.70	54.00	-7.30
9648.16	45.17	100	0			54.34	88.63	-34.29
4873.97	44.00	100	180			48.37	74.00	-25.63
4873.97				35.69	A	40.06	54.00	-13.94
7314.56	45.50	100	45			53.83	74.00	-20.17
7314.56				34.95	A	43.28	54.00	-10.72
9748.02	45.67	100	45			54.96	90.20	-35.24
4923.92	44.33	100	135			48.81	74.00	-25.19
4923.92				34.58	A	39.06	54.00	-14.94
7382.50	44.50	100	45			52.93	74.00	-21.07
7382.50				31.96	A	40.39	54.00	-13.61
9847.44	45.67	100	90			55.08	89.61	-34.53

RADIATED EMISSIONS (SPURIOUS AND HARMONICS) (Continued)

*Fundamental and Band Edge Measurements at Channels 1, 6, & 11
with Ethertronics Dual Band Antennas
INTEL-021001-22*

Horizontal Open Field Maximized Data								
<i>Freq. (MHz)</i>	<i>Meter Reading (dBuV)</i>	<i>Antenna Height (cm)</i>	<i>Azimuth (degrees)</i>	<i>Quasi pk or AVG (dBuV)</i>		<i>Corrected Reading (dBuV)</i>	<i>Limits (dBuV)</i>	<i>Diff (dB) +=FAIL</i>
2410.98	76.17	100	135			109.80		
2390.00	30.17	100	135			63.73	74.00	-10.27
2390.00				18.32	A	51.88	54.00	-2.12
2436.00	76.67	100	135			110.37		
2461.04	78.83	150	225			112.61		
2483.50	31.33	150	225			65.18	74.00	-8.82
2483.50				18.08	A	51.93	54.00	-2.07

Vertical Open Field Maximized Data								
<i>Freq. (MHz)</i>	<i>Meter Reading (dBuV)</i>	<i>Antenna Height (cm)</i>	<i>Azimuth (degrees)</i>	<i>Quasi pk or AVG (dBuV)</i>		<i>Corrected Reading (dBuV)</i>	<i>Limits (dBuV)</i>	<i>Diff (dB) +=FAIL</i>
2412.89	75.00	250	90			108.63		
2390.00	29.67	250	90			63.23	74.00	-10.77
2390.00				16.49	A	50.05	54.00	-3.95
2436.03	75.76	100	270			109.46		
2461.04	73.67	100	270			107.45		
2483.50	29.33	100	270			63.18	74.00	-10.82
2483.50				15.69	A	49.54	54.00	-4.46

RADIATED EMISSIONS (SPURIOUS AND HARMONICS) (Continued)

*Harmonic Measurements at Channels 1, 6, & 11 with Ethertronics Dual Band Antennas
INTEL-021001-23*

Horizontal Open Field Maximized Data								
<i>Freq. (MHz)</i>	<i>Meter Reading (dBuV)</i>	<i>Antenna Height (cm)</i>	<i>Azimuth (degrees)</i>	<i>Quasi pk or AVG (dBuV)</i>		<i>Corrected Reading (dBuV)</i>	<i>Limits (dBuV)</i>	<i>Diff (dB) +=FAIL</i>
4823.94	45.83	100	180			50.08	74.00	-23.92
4823.94				37.63	A	41.88	54.00	-12.12
7231.90	43.83	100	135			52.04	74.00	-21.96
7231.90				31.81	A	40.02	54.00	-13.98
9648.04	46.17	100	90			55.34	89.80	-34.46
4873.93	45.50	100	180			49.87	74.00	-24.13
4873.93				38.89	A	43.26	54.00	-10.74
7314.73	44.83	100	90			53.16	74.00	-20.84
7314.73				33.82	A	42.15	54.00	-11.85
9748.44	46.33	100	45			55.62	90.37	-34.75
4924.01	48.67	100	135			53.15	74.00	-20.85
4924.01				44.08	A	48.56	54.00	-5.44
7389.30	44.33	100	225			52.77	74.00	-21.23
7389.30				31.73	A	40.17	54.00	-13.83
9848.06	45.33	100	90			54.74	92.61	-37.87

Vertical Open Field Maximized Data								
<i>Freq. (MHz)</i>	<i>Meter Reading (dBuV)</i>	<i>Antenna Height (cm)</i>	<i>Azimuth (degrees)</i>	<i>Quasi pk or AVG (dBuV)</i>		<i>Corrected Reading (dBuV)</i>	<i>Limits (dBuV)</i>	<i>Diff (dB) +=FAIL</i>
4823.83	44.33	100	135			48.58	74.00	-25.42
4823.83				33.94	A	38.19	54.00	-15.81
7237.76	45.67	100	45			53.89	74.00	-20.11
7237.76				35.59	A	43.81	54.00	-10.19
9647.86	45.17	100	45			54.34	88.63	-34.29
4874.02	43.33	100	135			47.70	74.00	-26.30
4874.02				33.69	A	38.06	54.00	-15.94
7313.80	46.50	100	45			54.83	74.00	-19.17
7313.80				37.63	A	45.96	54.00	-8.04
9747.94	46.33	100	45			55.62	89.46	-33.84
4924.02	44.67	200	90			49.15	74.00	-24.85
4924.02				35.99	A	40.47	54.00	-13.53
7390.02	44.83	100	90			53.27	74.00	-20.73
7390.02				32.34	A	40.78	54.00	-13.22
9848.00	45.33	100	45			54.74	87.45	-32.71

RADIATED EMISSIONS (SPURIOUS AND HARMONICS) (Continued)

*Spurious Emissions Measurements on Ch. 1 @ 1Mbps Data Rate
using Hitachi Dual Band Antennas
INTEL-021001-24*

Horizontal Open Field Maximized Data								
<i>Freq. (MHz)</i>	<i>Meter Reading (dBuV)</i>	<i>Antenna Height (cm)</i>	<i>Azimuth (degrees)</i>	<i>Quasi pk or AVG (dBuV)</i>		<i>Corrected Reading (dBuV)</i>	<i>Limits (dBuV)</i>	<i>Diff (dB) +=FAIL</i>
1120.95	57.83	100	45			49.68	74.00	-24.32
1122.66				41.51	A	33.37	54.00	-20.63
1346.26	51.83	100	0			44.23	74.00	-29.77
1346.26				36.63	A	29.03	54.00	-24.97
1461.74	52.00	100	270			45.13	74.00	-28.87
1461.74				35.15	A	28.28	54.00	-25.72
1593.91	55.33	100	180			48.74	74.00	-25.26
1593.91				42.73	A	36.14	54.00	-17.86

Vertical Open Field Maximized Data								
<i>Freq. (MHz)</i>	<i>Meter Reading (dBuV)</i>	<i>Antenna Height (cm)</i>	<i>Azimuth (degrees)</i>	<i>Quasi pk or AVG (dBuV)</i>		<i>Corrected Reading (dBuV)</i>	<i>Limits (dBuV)</i>	<i>Diff (dB) +=FAIL</i>
1122.66	52.33	100	270			44.19	74.00	-29.81
1122.66				41.91	A	33.77	54.00	-20.23
1458.17	53.33	100	0			46.45	74.00	-27.55
1458.17				34.90	A	28.02	54.00	-25.98
1591.79	54.67	100	270			48.09	74.00	-25.91
1591.79				49.67	A	43.09	54.00	-10.91

RADIATED EMISSIONS (SPURIOUS AND HARMONICS) (Continued)

TEST EQUIPMENT USED					
Equipment Name	Manufacturer	Model Number	Serial Number	Calibration Due Date	Calibration Cycle
Spectrum Analyzer	Agilent	8564EC	4046A00387	02/28/04	2 Years
Preamplifier	Agilent	8449B	3008A01573	04/29/03	1 Year
Antenna - Horn	EMCO	3115	2230	09/14/03	1 Year
Temperature/Humidity Monitor	Dickson	TH550	7255185	01/08/03	1 Year

EUT ACCESSORIES			
Equipment Name	Manufacturer	Model Number	Serial Number
NetVista Computer	IBM	21U	KAOL42K
Monitor	NEC	JC-1575VMA	2Y785821
Keyboard	IBM	SK-8811	1922408
Mouse	IBM	MU295	23-161493

BLOCK DIAGRAM

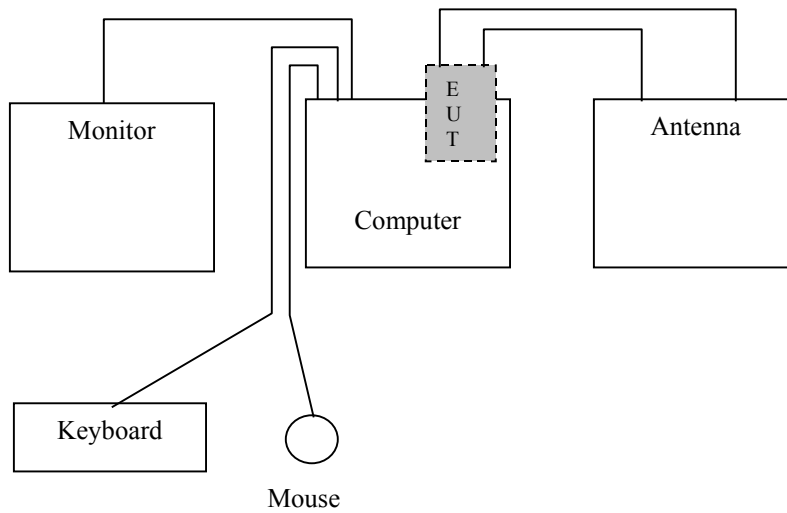

RADIATED EMISSIONS (SPURIOUS AND HARMONICS) (Continued)

PHOTOGRAPHS

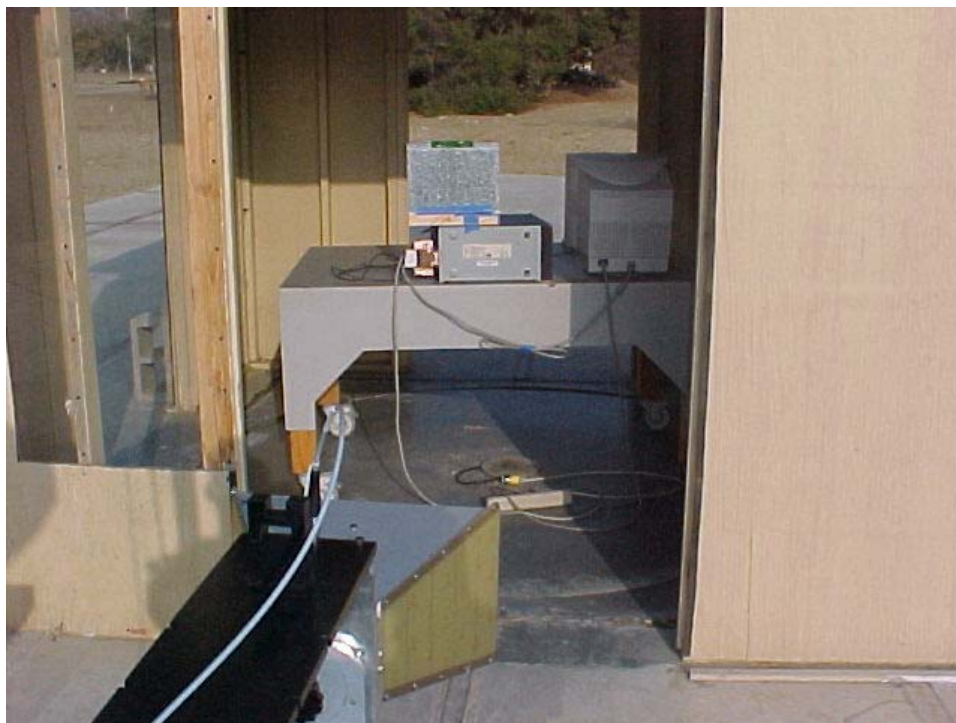

BAND EDGE EMISSIONS MEASUREMENT - RADIATED

CLIENT:	Intel Corporation	DATE:	10/25/02
EUT:	Mini PCI Type 3B Single Band 802.11b WLAN Adapter	PROJECT NUMBER:	INTEL-021001
MODEL NUMBER:	WM3B2100	TEST ENGINEER:	Rick Candelas
SERIAL NUMBER:	0004230018AE	SITE #:	2
CONFIGURATION:	Installed in IBM NetVista Desktop Computer, SN: KAOL42K	TEMPERATURE:	24 C
		HUMIDITY:	31% RH
		TIME:	9:00 AM

Standard:	FCC CFR 47, Part 15, 15.247(c)
Description:	Band Edge Emissions Measurement - Radiated
Results:	Radiated emissions which fall in the restricted bands, as defined in Sec. 15.205(a), must also comply with the radiated emission limits specified in Sec. 15.209(a) (see Sec. 15.205(c)).

BAND EDGE EMISSIONS MEASUREMENT - RADIATED (Continued)

With the Hitachi Dual Band Antennas

Vertical Open Field Maximized Data								
<i>Freq. (MHz)</i>	<i>Meter Reading (dBuV)</i>	<i>Antenna Height (cm)</i>	<i>Azimuth (degrees)</i>	<i>Quasi pk or AVG (dBuV)</i>		<i>Corrected Reading (dBuV)</i>	<i>Limits (dBuV)</i>	<i>Diff (dB) +=FAIL</i>
2390.00	30.50	100	225			64.06	74.00	-9.94
2390.00				18.50	A	52.06	54.00	-1.94
2483.50	30.17	100	225			64.02	74.00	-9.98
2483.50				18.67	A	52.52	54.00	-1.48

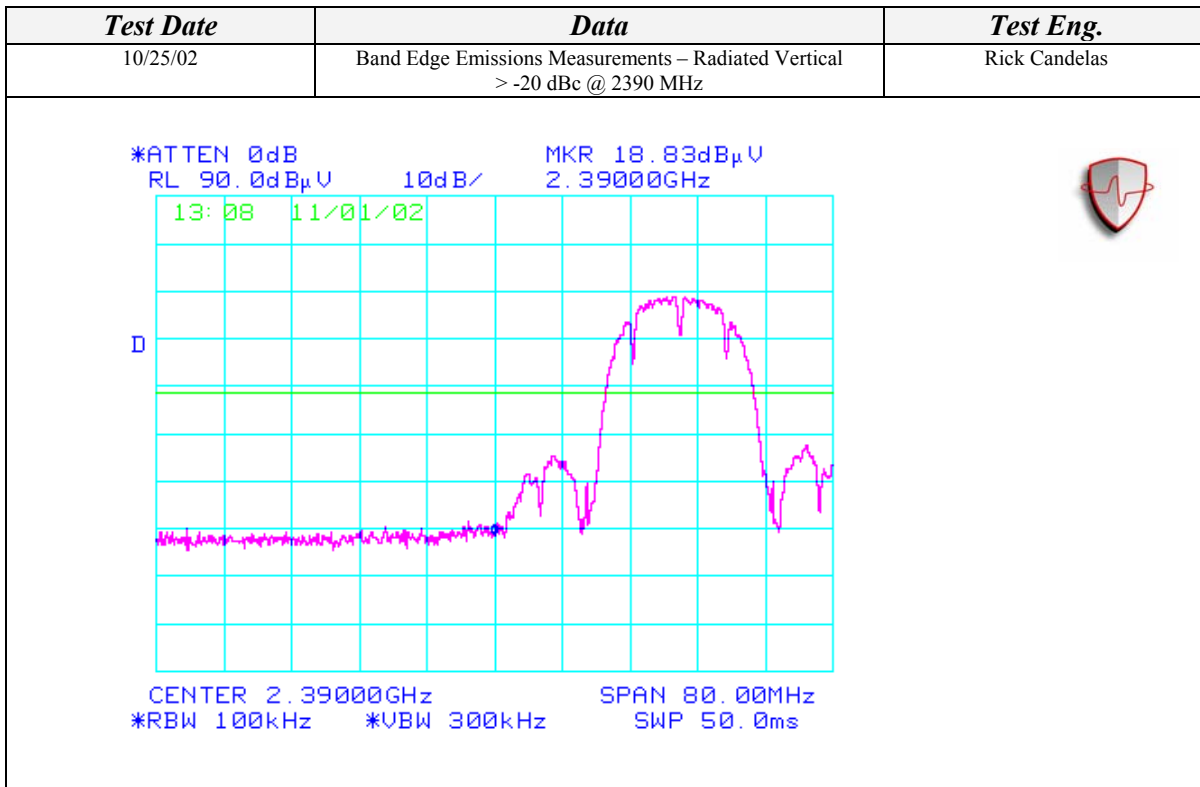

BAND EDGE EMISSIONS MEASUREMENT - RADIATED (Continued)

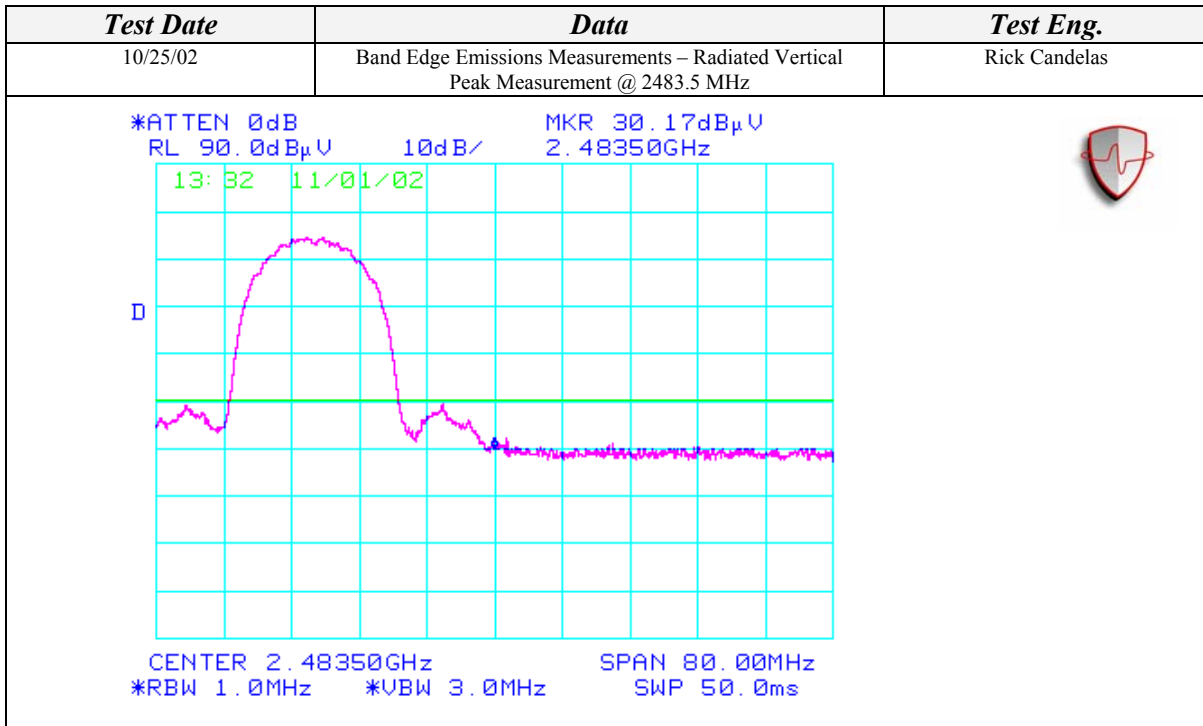
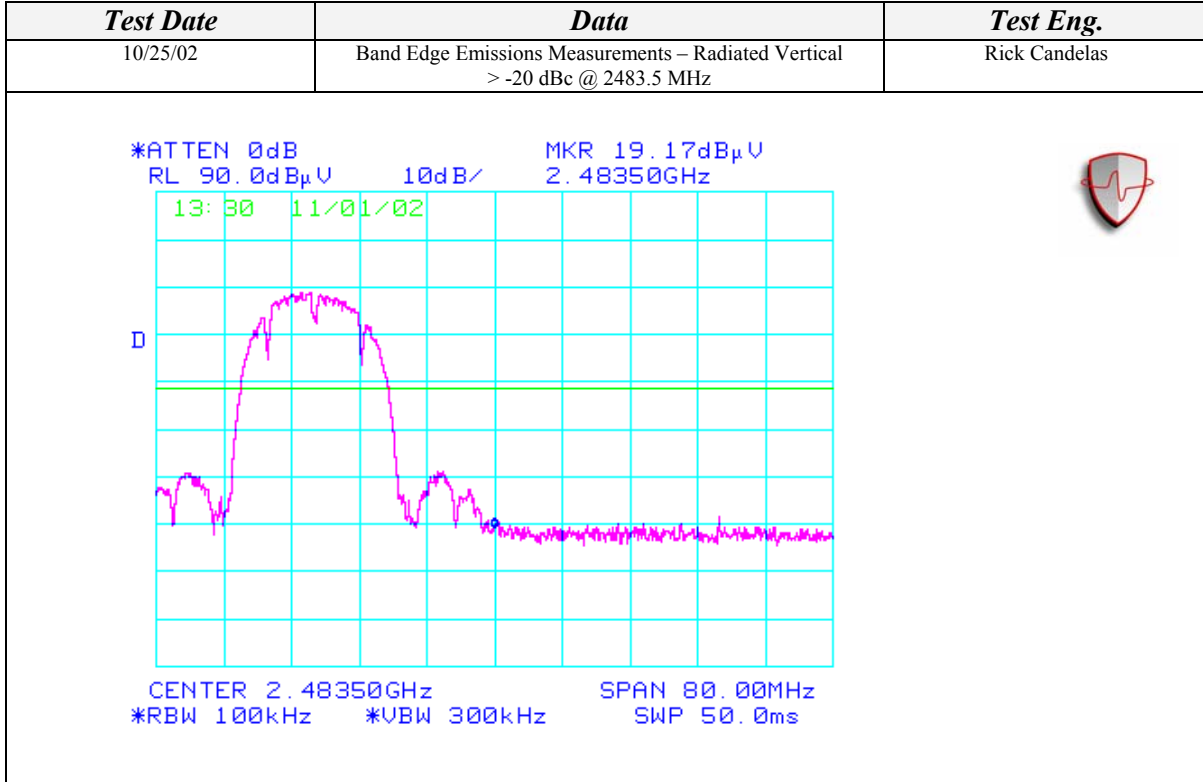

BAND EDGE EMISSIONS MEASUREMENT - RADIATED (Continued)

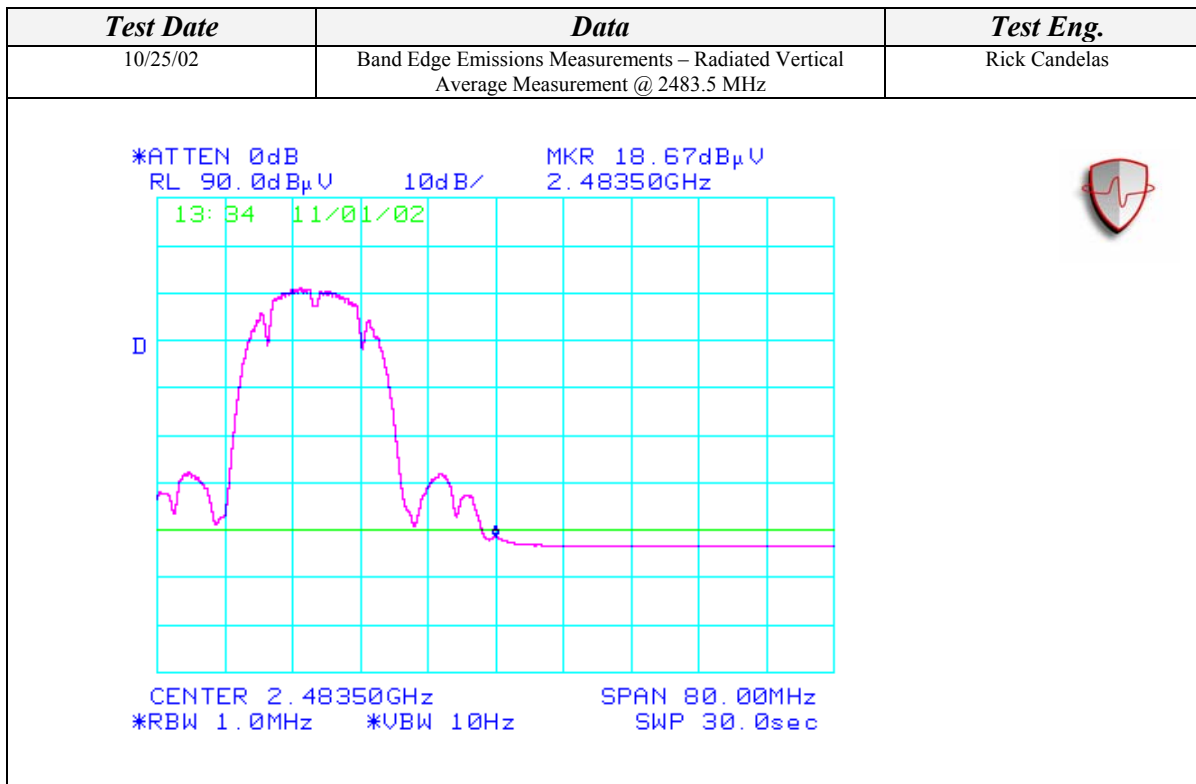

BAND EDGE EMISSIONS MEASUREMENT - RADIATED (Continued)

With the Hitachi Dual Band Antennas

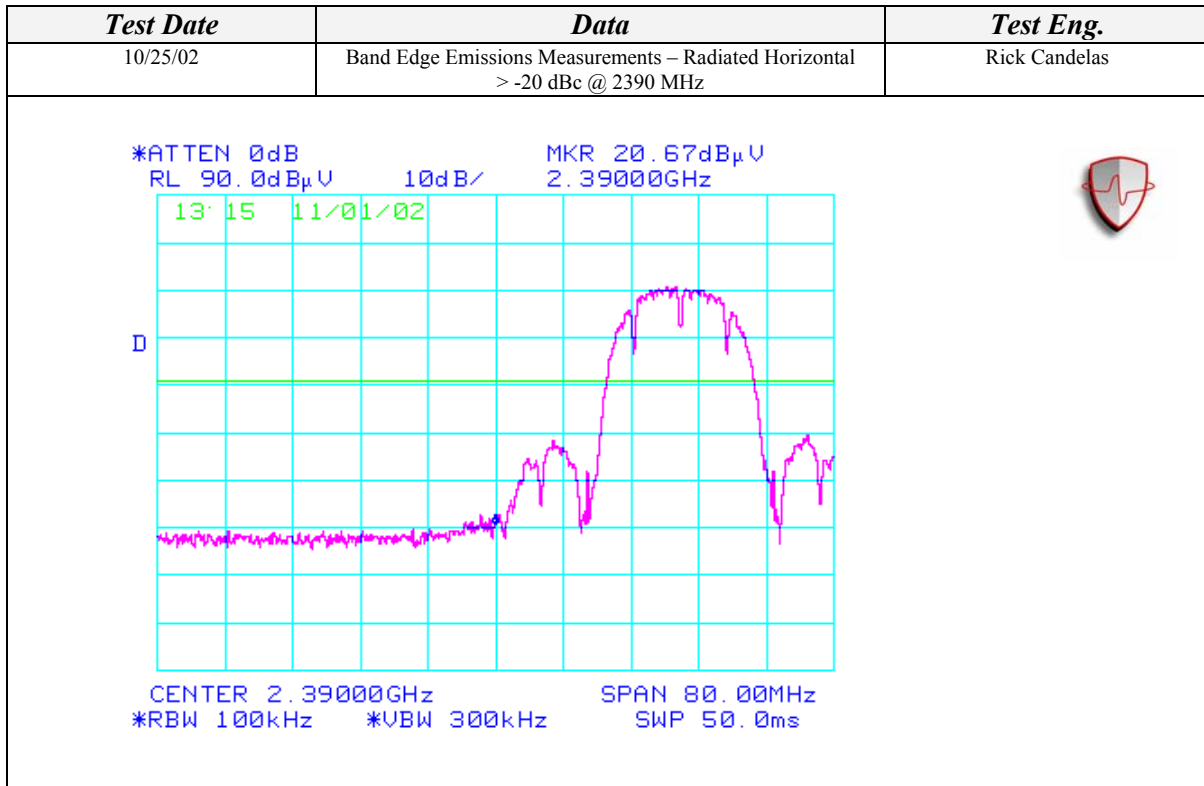

Horizontal Open Field Maximized Data								
<i>Freq. (MHz)</i>	<i>Meter Reading (dBuV)</i>	<i>Antenna Height (cm)</i>	<i>Azimuth (degrees)</i>	<i>Quasi pk or AVG (dBuV)</i>		<i>Corrected Reading (dBuV)</i>	<i>Limits (dBuV)</i>	<i>Diff (dB) +/-FAIL</i>
2390.00	31.00	100	225			64.56	74.00	-9.44
2390.00				18.83	A	52.39	54.00	-1.61
2483.50	30.00	100	225			63.85	74.00	-10.15
2483.50				18.00	A	51.85	54.00	-2.15



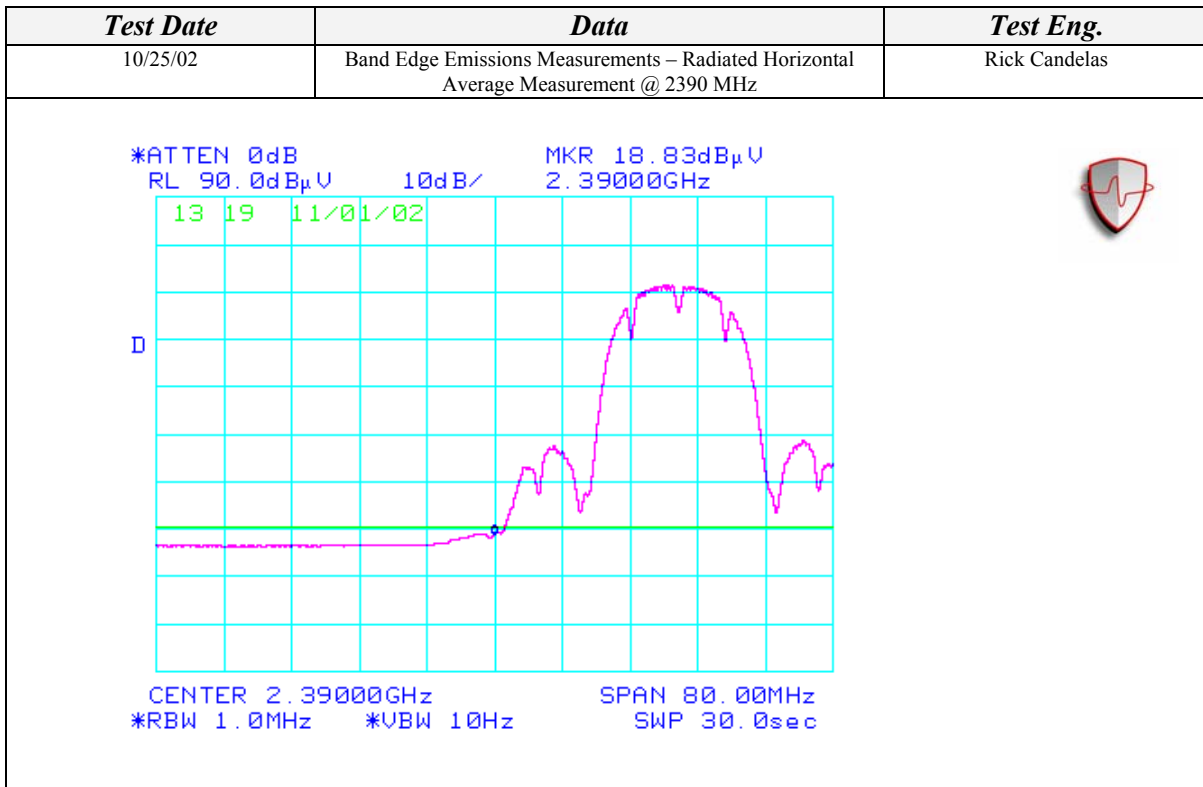
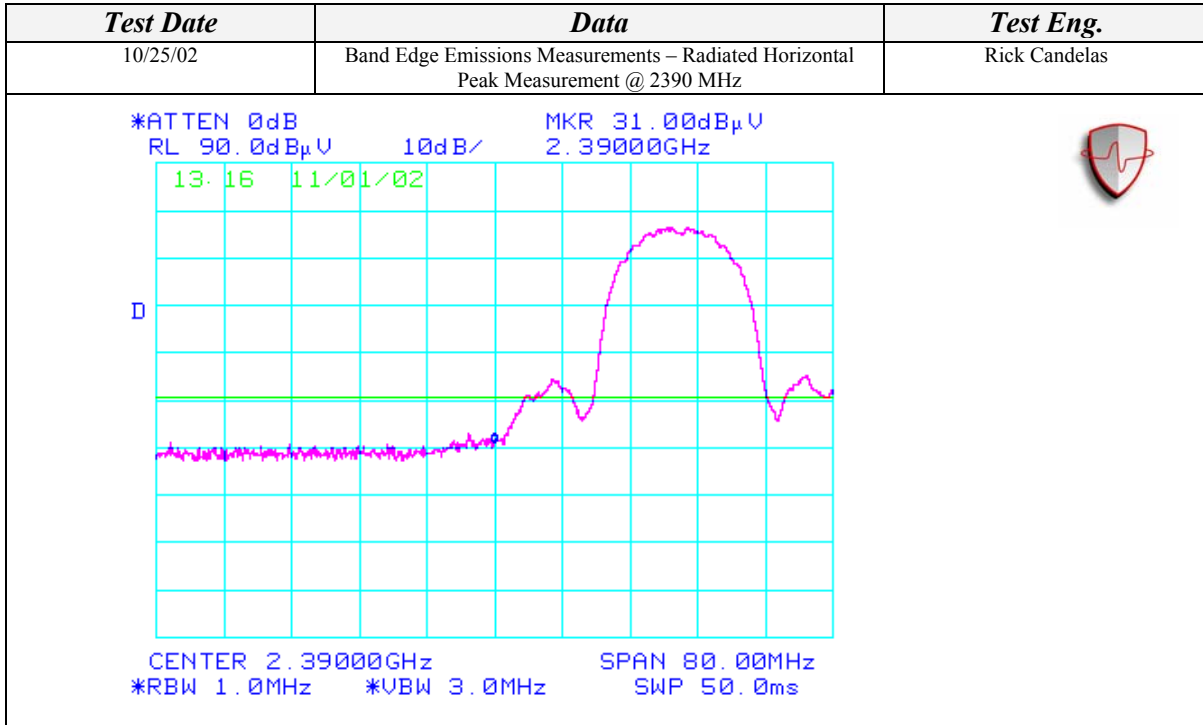

BAND EDGE EMISSIONS MEASUREMENT - RADIATED (Continued)

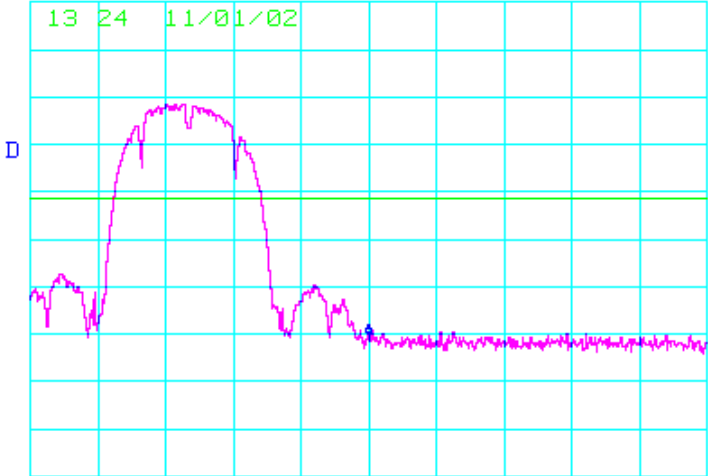

BAND EDGE EMISSIONS MEASUREMENT - RADIATED (Continued)

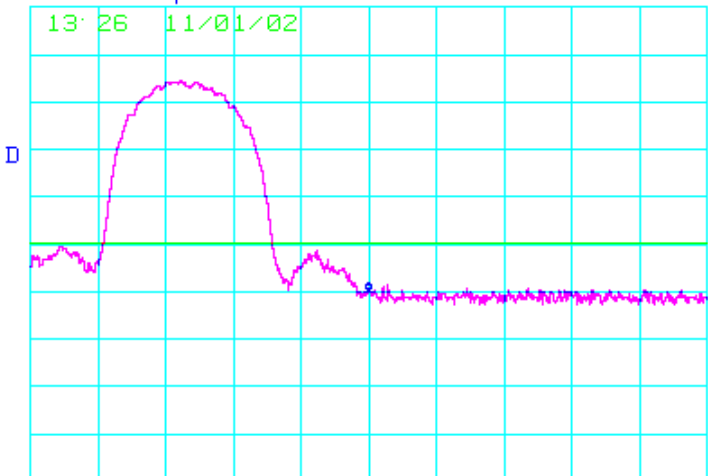
<i>Test Date</i>	<i>Data</i>	<i>Test Eng.</i>
10/25/02	Band Edge Emissions Measurements – Radiated Horizontal > -20 dBc @ 2483.5 MHz	Rick Candelas
<div style="display: flex; justify-content: space-between; align-items: flex-start;"> <div style="width: 60%;"> <p>*ATTEN 0dB RL 90.0dBμV 10dB/ MKR 19.83dBμV 2.48350GHz</p> <p>13 24 11/01/02</p>  <p style="text-align: center;">CENTER 2.48350GHz SPAN 80.00MHz *RBW 100kHz *VBW 300kHz SWP 50.0ms</p> </div> <div style="width: 35%; text-align: right;">  </div> </div>		

<i>Test Date</i>	<i>Data</i>	<i>Test Eng.</i>
10/25/02	Band Edge Emissions Measurements – Radiated Horizontal Peak Measurement @ 2483.5 MHz	Rick Candelas
<div style="display: flex; justify-content: space-between; align-items: flex-start;"> <div style="width: 60%;"> <p>*ATTEN 0dB RL 90.0dBμV 10dB/ MKR 30.00dBμV 2.48350GHz</p> <p>13 26 11/01/02</p>  <p style="text-align: center;">CENTER 2.48350GHz SPAN 80.00MHz *RBW 1.0MHz *VBW 3.0MHz SWP 50.0ms</p> </div> <div style="width: 35%; text-align: right;">  </div> </div>		

BAND EDGE EMISSIONS MEASUREMENT - RADIATED (Continued)

With the Ethertronics Dual Band Antenna

Vertical Open Field Maximized Data								
<i>Freq. (MHz)</i>	<i>Meter Reading (dBuV)</i>	<i>Antenna Height (cm)</i>	<i>Azimuth (degrees)</i>	<i>Quasi pk or AVG (dBuV)</i>		<i>Corrected Reading (dBuV)</i>	<i>Limits (dBuV)</i>	<i>Diff (dB) +=FAIL</i>
2390.00	30.33	100	225			63.89	74.00	-10.11
2390.00				17.83	A	51.39	54.00	-2.61
2483.50	28.17	100	225			62.02	74.00	-11.98
2483.50				17.17	A	51.02	54.00	-2.98

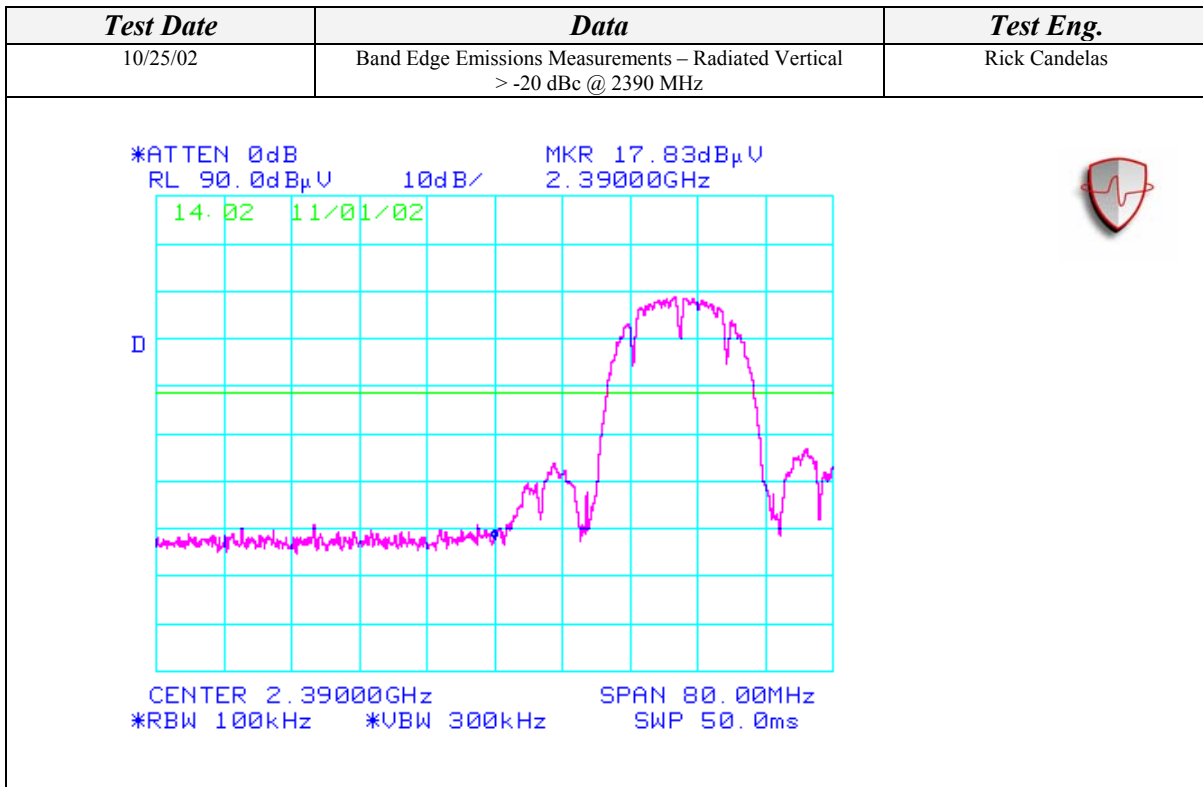

BAND EDGE EMISSIONS MEASUREMENT - RADIATED (Continued)

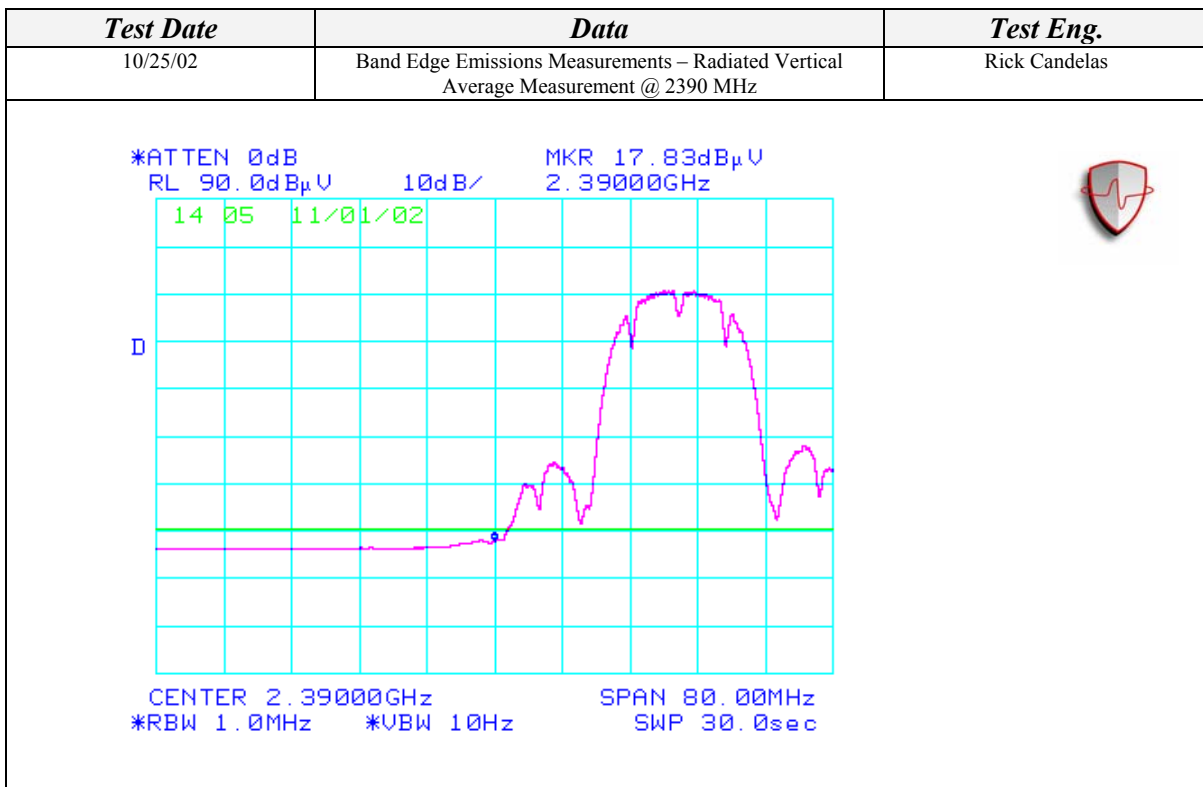
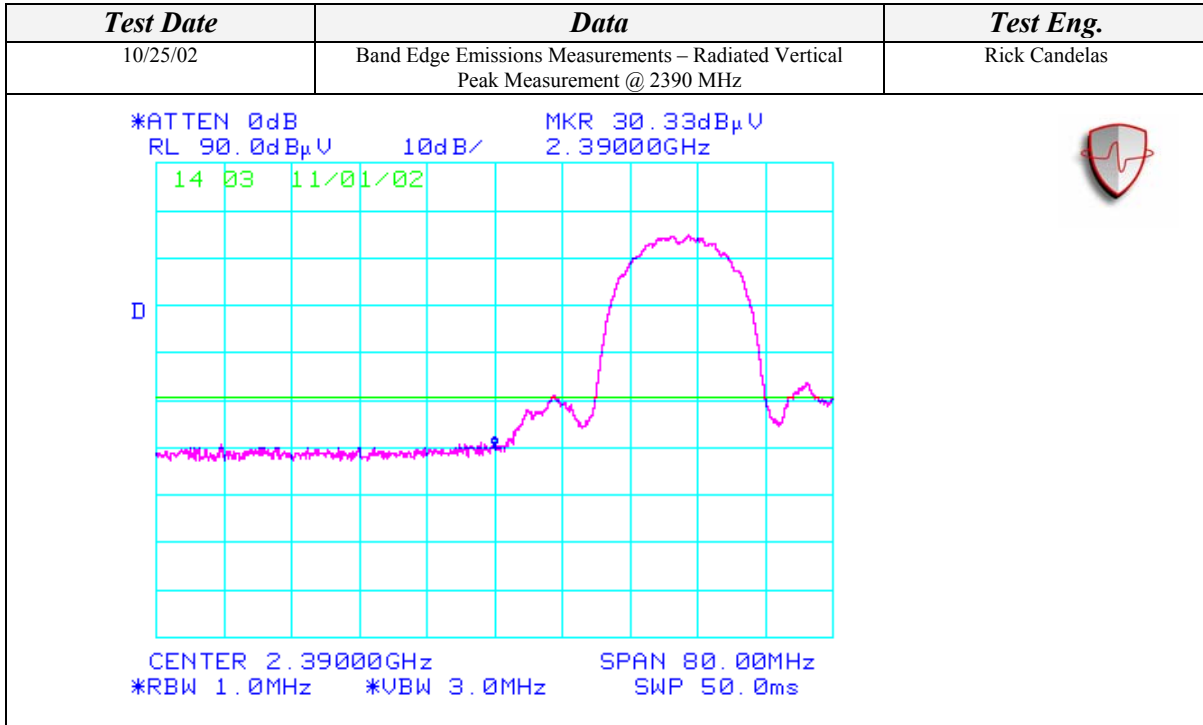

BAND EDGE EMISSIONS MEASUREMENT - RADIATED (Continued)

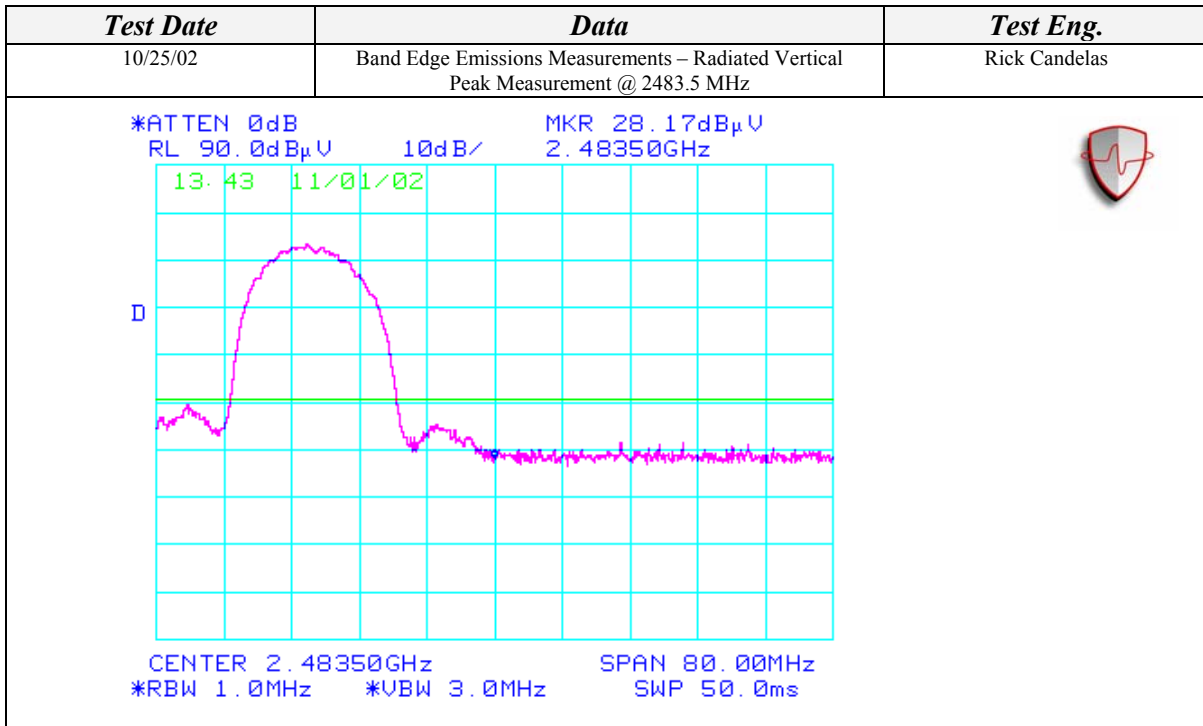
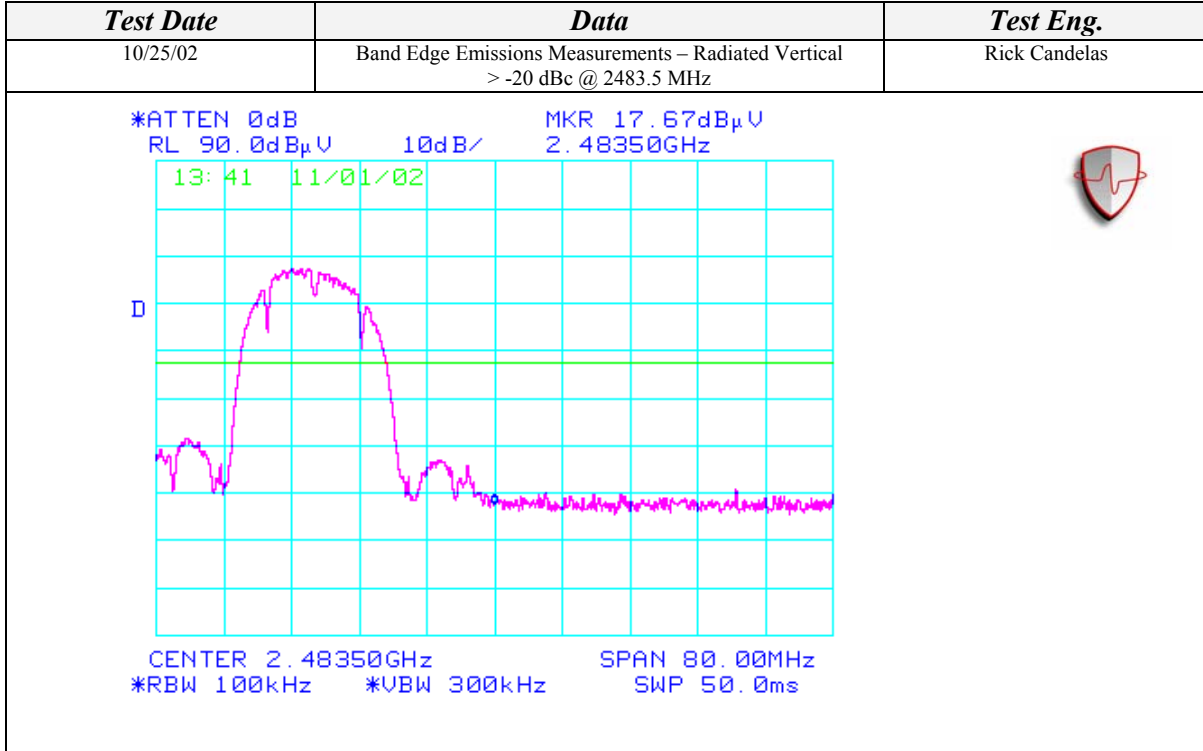

BAND EDGE EMISSIONS MEASUREMENT - RADIATED (Continued)

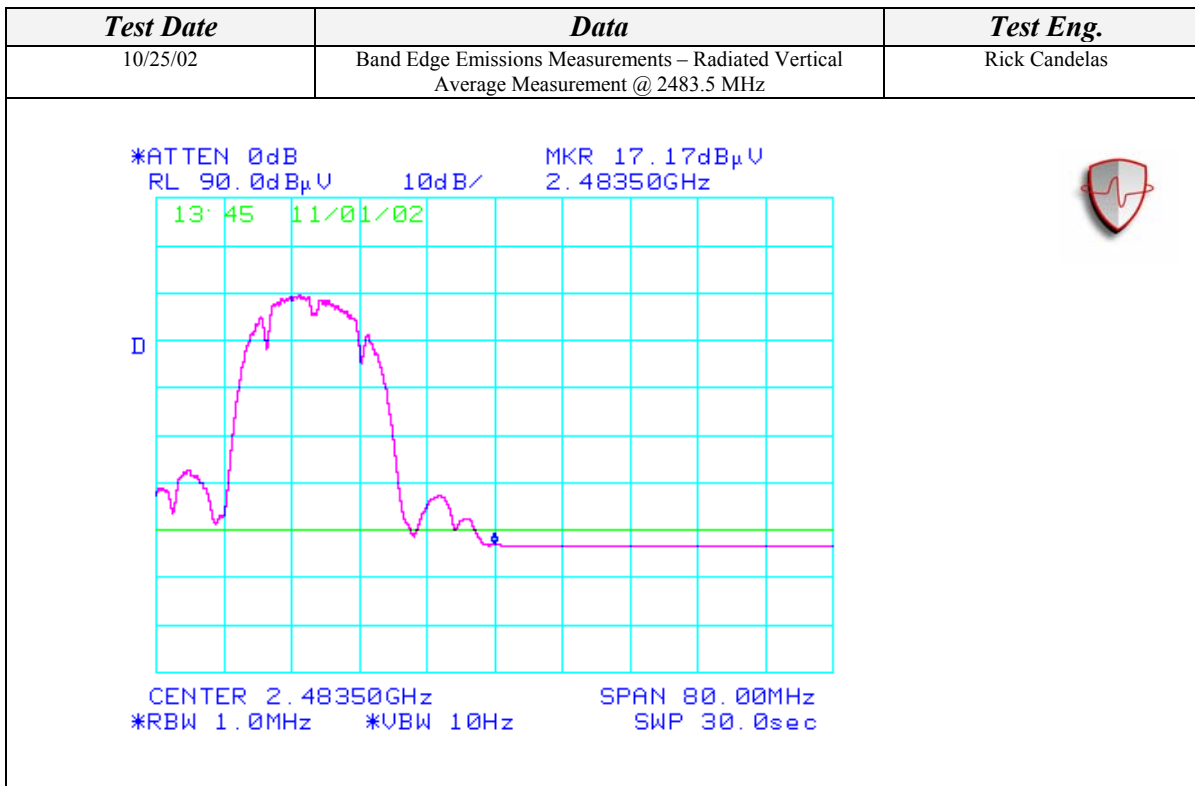

BAND EDGE EMISSIONS MEASUREMENT - RADIATED (Continued)

With the Ethertronics Dual Band Antenna

Horizontal Open Field Maximized Data								
<i>Freq. (MHz)</i>	<i>Meter Reading (dBuV)</i>	<i>Antenna Height (cm)</i>	<i>Azimuth (degrees)</i>	<i>Quasi pk or AVG (dBuV)</i>		<i>Corrected Reading (dBuV)</i>	<i>Limits (dBuV)</i>	<i>Diff (dB) +/-FAIL</i>
2390.00	28.50	100	225			62.06	74.00	-11.94
2390.00				18.83	A	52.39	54.00	-1.61
2483.50	31.17	100	225			65.02	74.00	-8.98
2483.50				19.00	A	52.85	54.00	-1.15

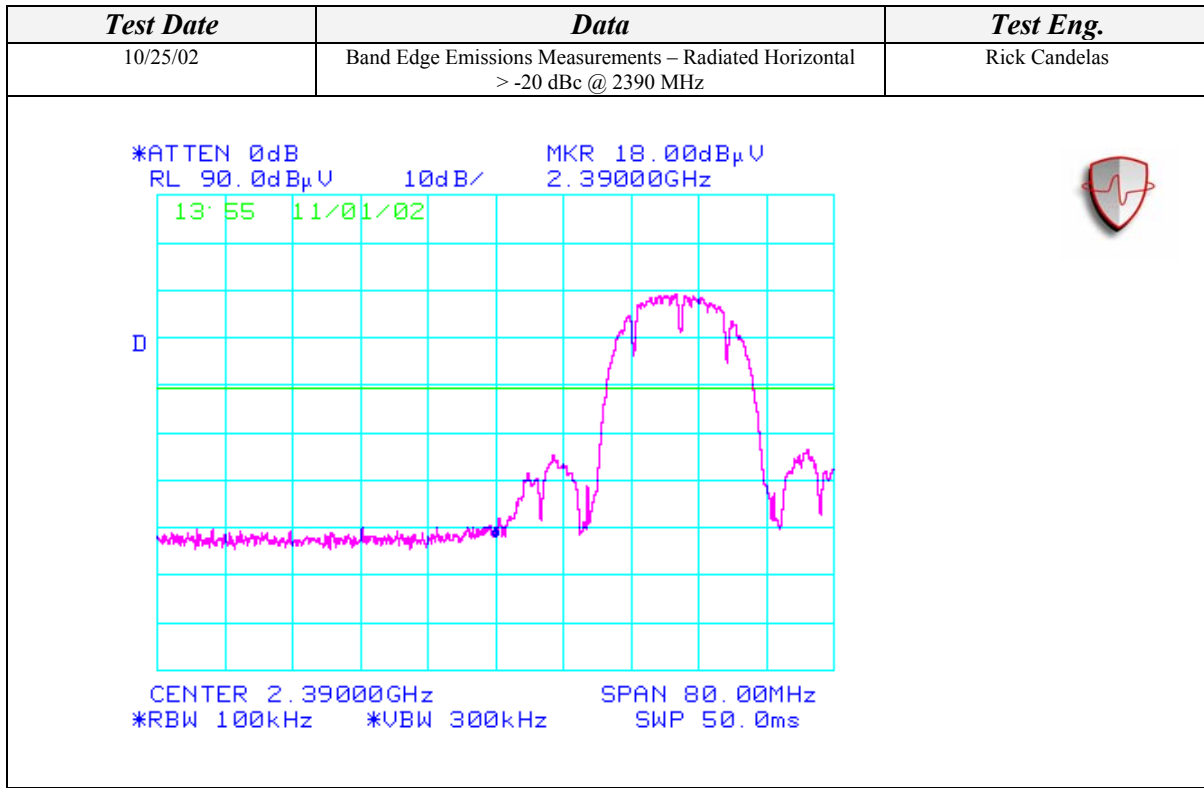

BAND EDGE EMISSIONS MEASUREMENT - RADIATED (Continued)

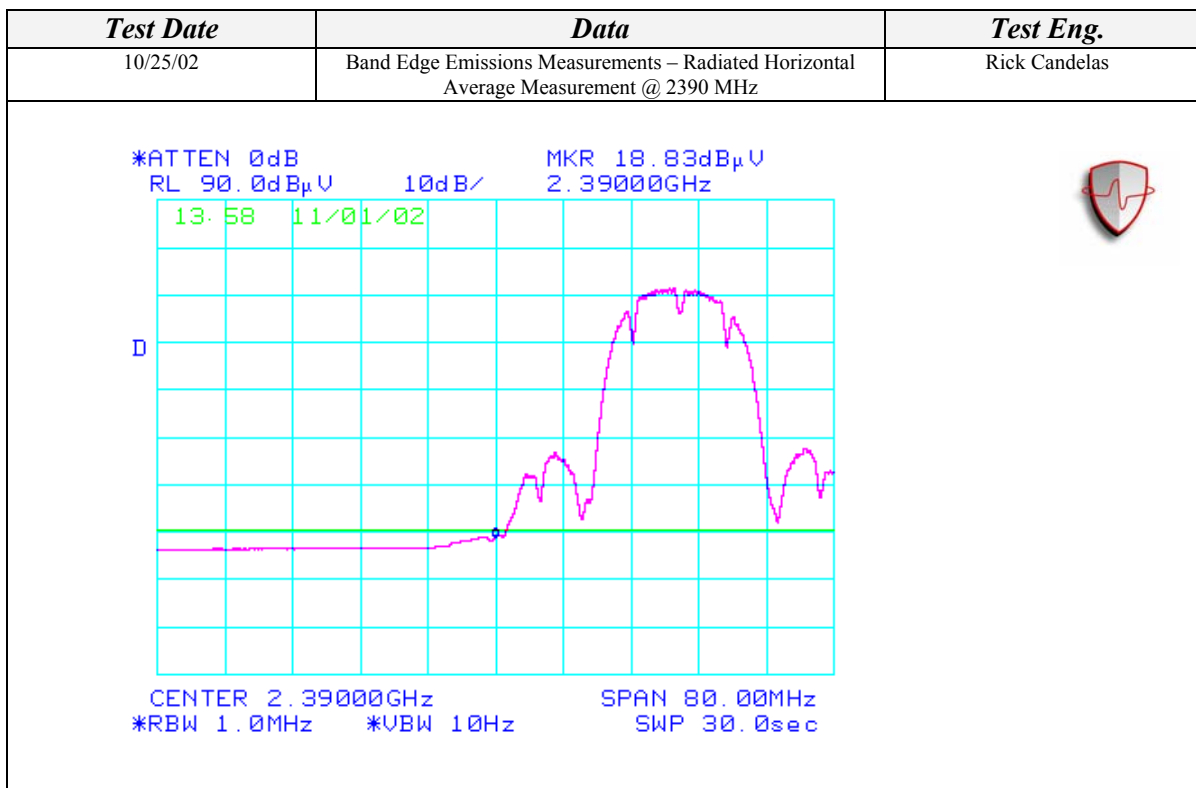
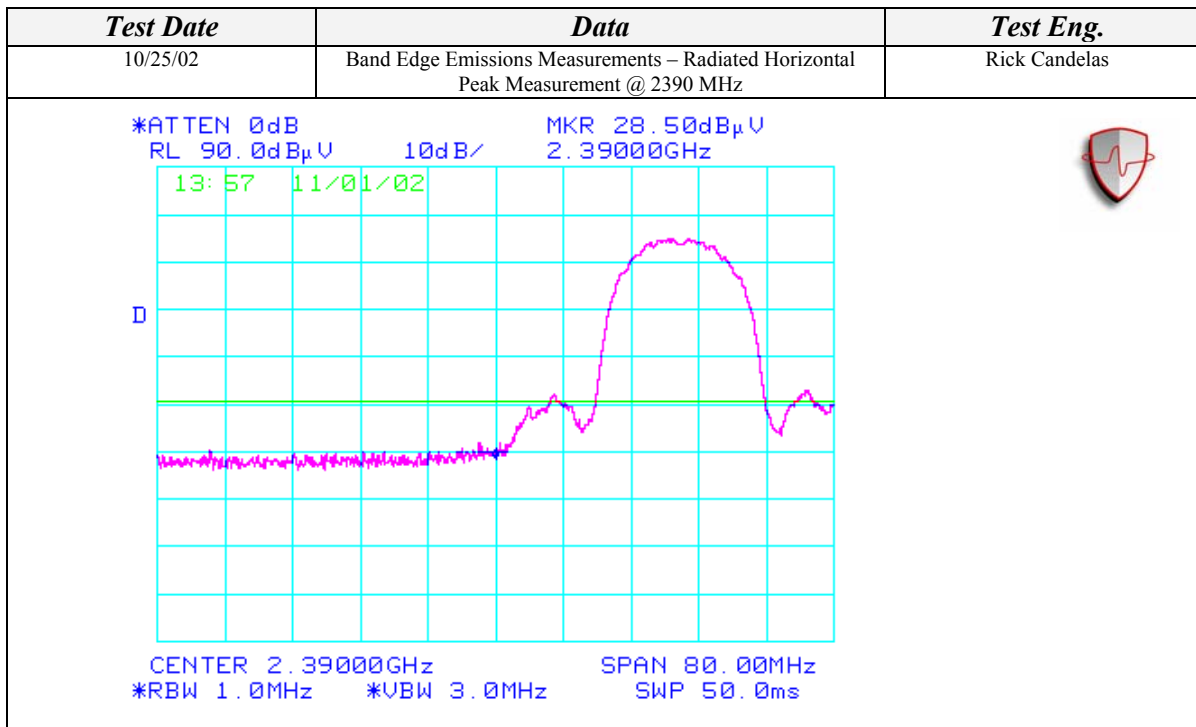

BAND EDGE EMISSIONS MEASUREMENT - RADIATED (Continued)

<i>Test Date</i>	<i>Data</i>	<i>Test Eng.</i>
10/25/02	Band Edge Emissions Measurements – Radiated Horizontal > -20 dBc @ 2483.5 MHz	Rick Candelas
<div style="display: flex; justify-content: space-between; font-size: 0.9em;"> <div> <p>*ATTEN 0dB RL 90.0dBµV 10dB/</p> </div> <div> <p>MKR 20.33dBµV 2.48350GHz</p> </div> </div> <div style="text-align: right; margin-top: 10px;"> </div>		
<p>CENTER 2.48350GHz SPAN 80.00MHz *RBW 100kHz *VBW 300kHz SWP 50.0ms</p>		

<i>Test Date</i>	<i>Data</i>	<i>Test Eng.</i>
10/25/02	Band Edge Emissions Measurements – Radiated Horizontal Peak Measurement @ 2483.5 MHz	Rick Candelas
<div style="display: flex; justify-content: space-between; font-size: 0.9em;"> <div> <p>*ATTEN 0dB RL 90.0dBµV 10dB/</p> </div> <div> <p>MKR 31.17dBµV 2.48350GHz</p> </div> </div> <div style="text-align: right; margin-top: 10px;"> </div>		
<p>CENTER 2.48350GHz SPAN 80.00MHz *RBW 1.0MHz *VBW 3.0MHz SWP 50.0ms</p>		

RADIATED EMISSIONS (SPURIOUS AND HARMONICS) (Continued)

TEST EQUIPMENT USED					
Equipment Name	Manufacturer	Model Number	Serial Number	Calibration Due Date	Calibration Cycle
Spectrum Analyzer	Agilent	8564EC	4046A00387	02/28/04	2 Years
Preamplifier	Agilent	8449B	3008A01573	04/29/03	1 Year
Antenna - Horn	EMCO	3115	2230	09/14/03	1 Year
Temperature/Humidity Monitor	Dickson	TH550	7255185	01/08/03	1 Year

EUT ACCESSORIES			
Equipment Name	Manufacturer	Model Number	Serial Number
NetVista Computer	IBM	21U	KAOL42K
Monitor	NEC	JC-1575VMA	2Y785821
Keyboard	IBM	SK-8811	1922408
Mouse	IBM	MU295	23-161493

BLOCK DIAGRAM

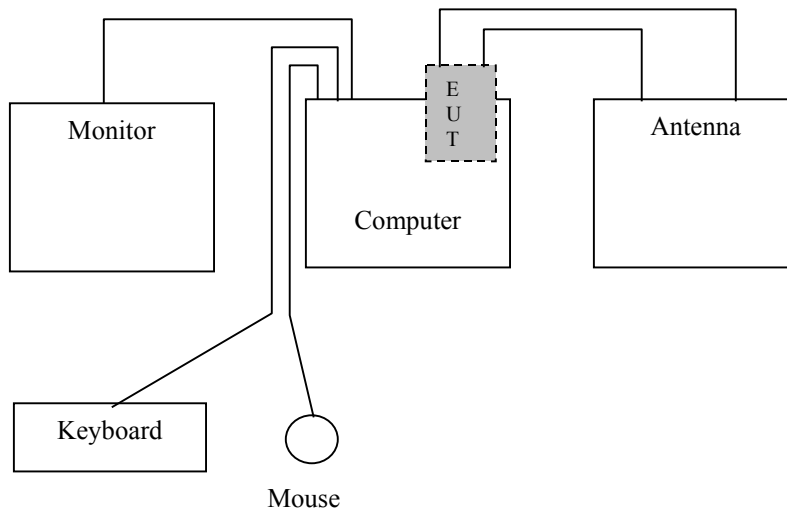

RADIATED EMISSIONS (SPURIOUS AND HARMONICS) (Continued)

PHOTOGRAPHS

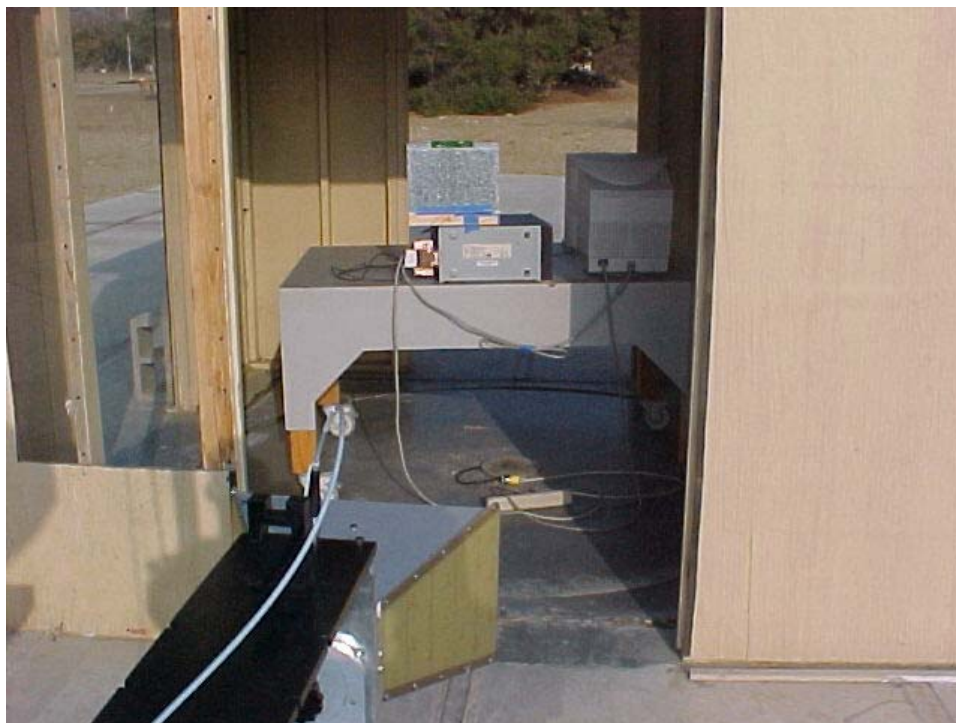

OCCUPIED BANDWIDTH MEASUREMENT

CLIENT:	Intel Corporation	DATE:	10/25/02
EUT:	Mini PCI Type 3B Single Band 802.11b WLAN Adapter	PROJECT NUMBER:	INTEL-021001
MODEL NUMBER:	WM3B2100	TEST ENGINEER:	Rick Candelas
SERIAL NUMBER:	0004230018AE	SITE #:	2
CONFIGURATION:	Installed in IBM NetVista Desktop Computer, SN: KAOL42K	TEMPERATURE:	23 C
		HUMIDITY:	31% RH
		TIME:	8:00 AM

Standard:	FCC CFR 47, Part 15, 15.247(a)(2)
Description:	Occupied Bandwidth Measurement
Results:	6dB bandwidth is at least 500 kHz.

TEST RESULTS SUMMARY	
Data	Result
Channel 1 Occupied Bandwidth	12.17 MHz 6 dB Bandwidth
Channel 6 Occupied Bandwidth	12.58 MHz 6 dB Bandwidth
Channel 11 Occupied Bandwidth	12.67 MHz 6dB Bandwidth

OCCUPIED BANDWIDTH MEASUREMENT (Continued)

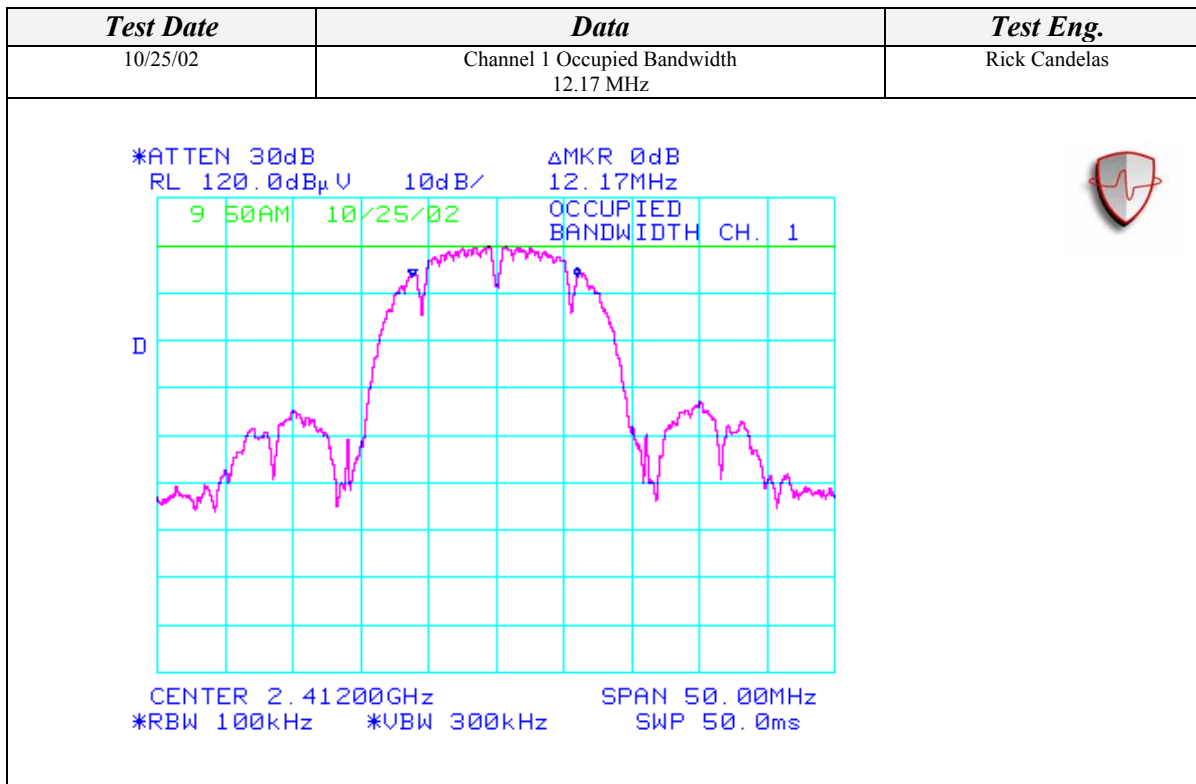

OCCUPIED BANDWIDTH MEASUREMENT (Continued)

<i>Test Date</i>	<i>Data</i>	<i>Test Eng.</i>
10/25/02	Channel 6 Occupied Bandwidth 12.58 MHz	Rick Candelas

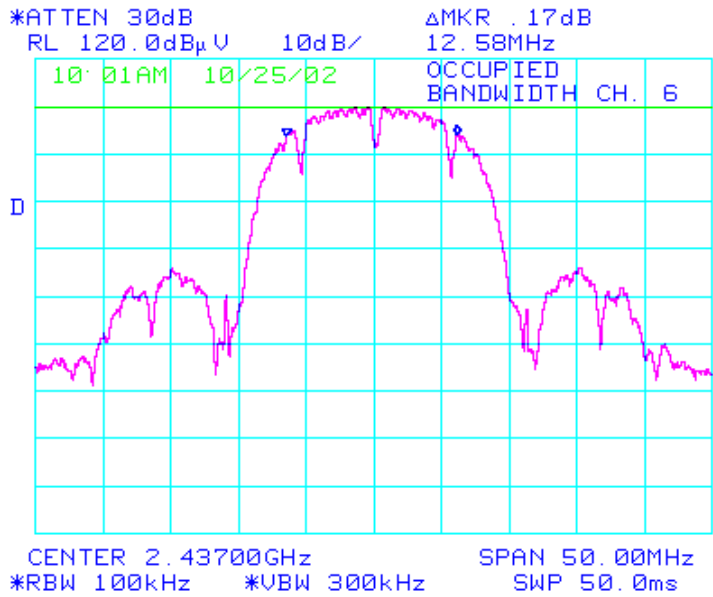

OCCUPIED BANDWIDTH MEASUREMENT (Continued)

<i>Test Date</i>	<i>Data</i>	<i>Test Eng.</i>
10/25/02	Channel 11 Occupied Bandwidth 12.67 MHz	Rick Candelas

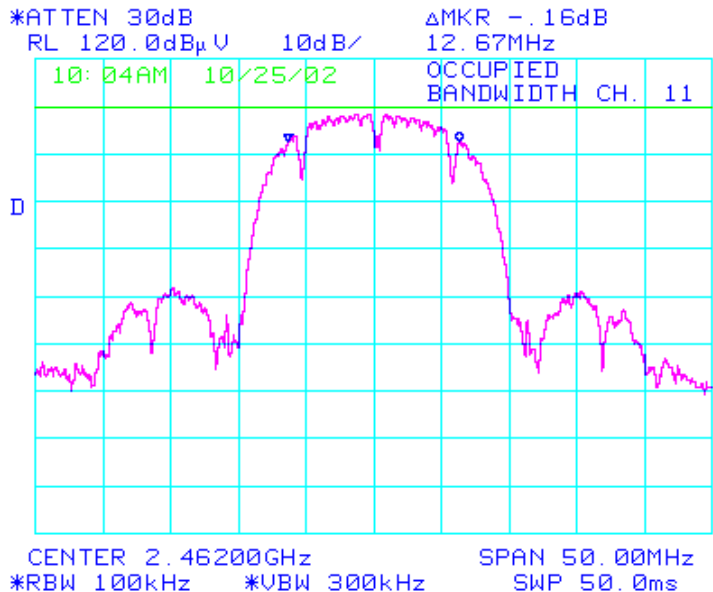

MAXIMUM PEAK OUTPUT POWER MEASUREMENT

CLIENT:	Intel Corporation	DATE:	10/22/02
EUT:	Mini PCI Type 3B Single Band 802.11b WLAN Adapter	PROJECT NUMBER:	INTEL-021001-19
MODEL NUMBER:	WM3B2100	TEST ENGINEER:	Rick Candelas
SERIAL NUMBER:	0004230018AE	SITE #:	2
CONFIGUARTION:	Installed in IBM NetVista Desktop Computer, SN: KAOL42K	TEMPERATURE:	21 C
		HUMIDITY:	49% RH
		TIME:	1:00 PM

Standard:	FCC CFR 47, Part 15, 15.247(b)
Description:	Peak Output Power – Conducted
Results:	Maximum Peak Output Power is less than 1 W. 44.87 mW @ Channel 6 at a data rate of 1 Mbps

Frequency (MHz)	Rate (Mbps)	Power (dBm)	Power Corrected (dBm)	Power (mW)
2412.00	1	16.29	16.44	44.06
2412.00	5.5	16.33	16.48	44.46
2412.00	11	16.45	16.60	45.71
2437.00	1	16.37	16.52	44.87
2437.00	5.5	16.42	16.57	45.39
2437.00	11	16.58	16.73	47.10
2462.00	1	16.29	16.44	44.06
2462.00	5.5	16.35	16.50	44.67
2462.00	11	16.40	16.55	45.19

NOTE 1: Using DINO Configuration software provided by Intel to set power limits.

SPECTRAL POWER DENSITY MEASUREMENT

CLIENT:	Intel Corporation	DATE:	10/25/02
EUT:	Mini PCI Type 3B Single Band 802.11b WLAN Adapter	PROJECT NUMBER:	INTEL-021001
MODEL NUMBER:	WM3B2100	TEST ENGINEER:	Rick Candelas
SERIAL NUMBER:	0004230018AE	SITE #:	2
CONFIGURATION:	Installed in IBM NetVista Desktop Computer, SN: KAOL42K	TEMPERATURE:	26 C
		HUMIDITY:	32% RH
		TIME:	2:00 PM

Standard:	FCC CFR 47, Part 15, 15.247(D)
Description:	Power Spectral Density Measurement
Results:	Transmitted power density averaged over any 1 second interval is not greater than 8 dBm in any 3 kHz bandwidth within these bands

TEST RESULTS SUMMARY	
Data	Result
Channel 1 Power Spectral Density	-9.67 dBm – Pass
Channel 6 Power Spectral Density	-9.50 dBm – Pass
Channel 11 Power Spectral Density	-4.83 dBm - Pass

SPECTRAL POWER DENSITY MEASUREMENT (Continued)

<i>Test Date</i>	<i>Data</i>	<i>Test Eng.</i>
10/25/02	Channel 1 Power Spectral Density	Rick Candelas

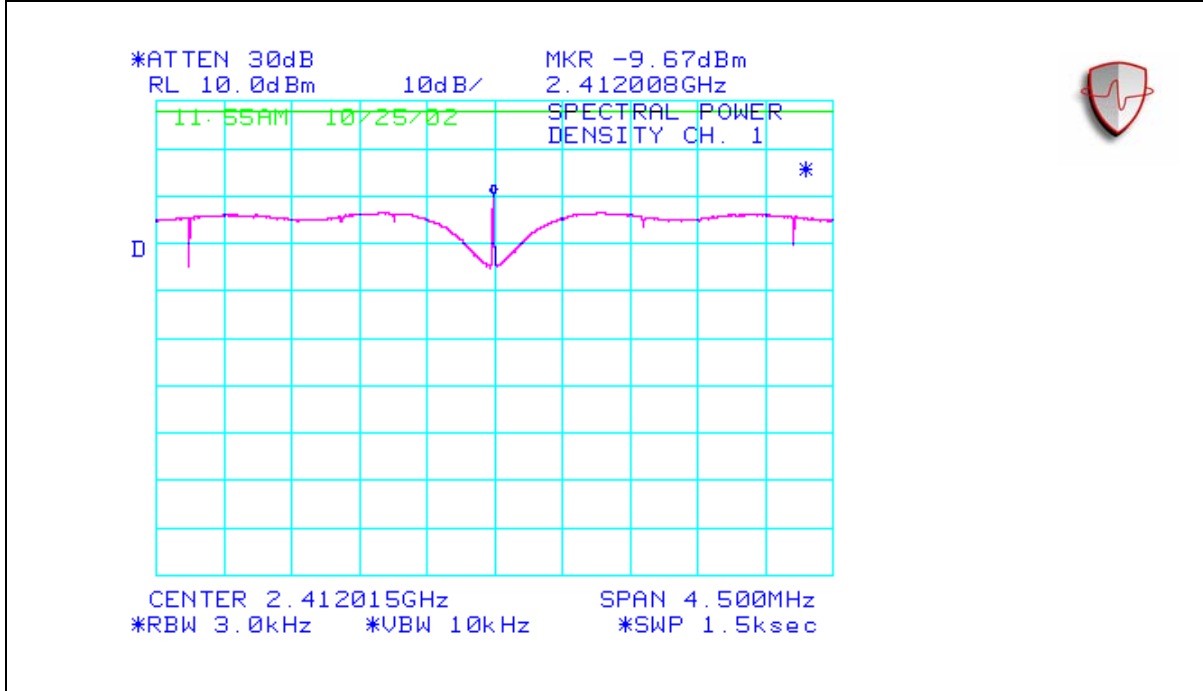

SPECTRAL POWER DENSITY MEASUREMENT (Continued)

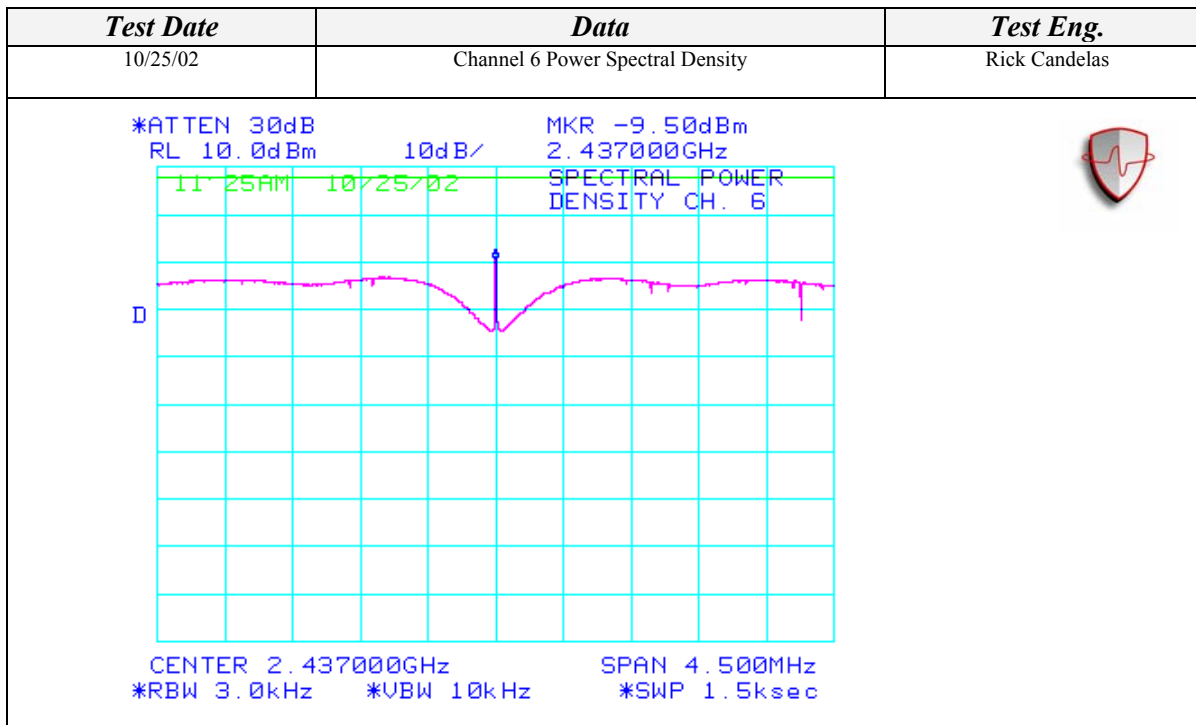

SPECTRAL POWER DENSITY MEASUREMENT (Continued)

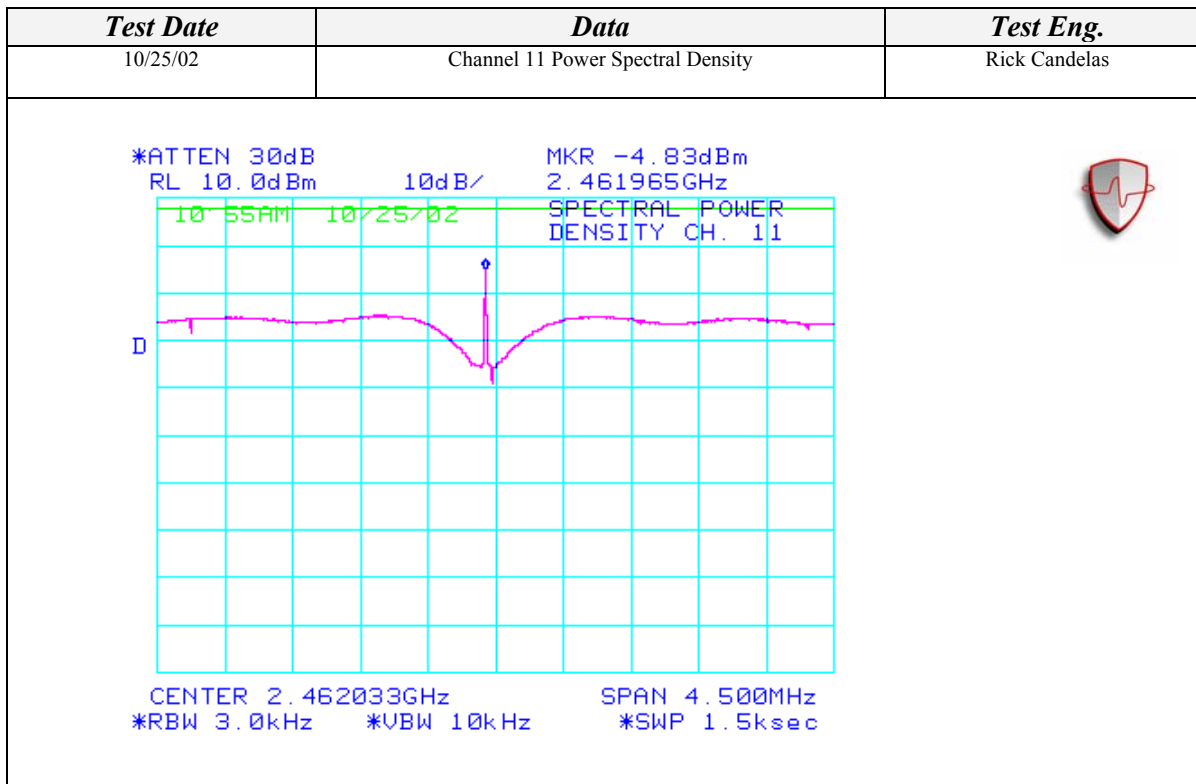

SPURIOUS EMISSIONS MEASUREMENT AT THE ANTENNA TERMINAL

CLIENT:	Intel Corporation	DATE:	10/25/02
EUT:	Mini PCI Type 3B Single Band 802.11b WLAN Adapter	PROJECT NUMBER:	INTEL-021001
MODEL NUMBER:	WM3B2100	TEST ENGINEER:	Rick Candelas
SERIAL NUMBER:	0004230018AE	SITE #:	2
CONFIGURATION:	Installed in IBM NetVista Desktop Computer, SN: KAOL42K	TEMPERATURE:	23 C
		HUMIDITY:	31% RH
		TIME:	8:00 AM

Standard:	FCC CFR 47, Part 15, 15.247(c)
Description:	Conducted Spurious Emissions
Results:	In any 100 kHz bandwidth outside the frequency band in which the spread spectrum intentional radiator is operating, the radio frequency power that is produced by the intentional radiator shall be at least 20 dB below that in the 100 kHz bandwidth within the band that contains the highest level of the desired power, based on either an RF conducted or a radiated measurement.

TEST RESULTS SUMMARY	
Data	Result
Channel 1 Spurious Emissions – Antenna Terminal - 30MHz – 2GHz	Max Spur Signal @ -52.50 dBm – Pass
Channel 1 Spurious Emissions – Antenna Terminal - 2GHz – 10GHz	Max Spur Signal @ -45.00 dBm – Pass
Channel 1 Spurious Emissions – Antenna Terminal - 10GHz – 20GHz	Max Spur Signal @ -45.50 dBm – Pass
Channel 1 Spurious Emissions – Antenna Terminal - 20GHz – 26.5GHz	Max Spur Signal @ -41.83 dBm – Pass
Channel 6 Spurious Emissions – Antenna Terminal - 30MHz – 2GHz	Max Spur Signal @ -53.67 dBm – Pass
Channel 6 Spurious Emissions – Antenna Terminal - 2GHz – 10GHz	Max Spur Signal @ -42.00 dBm – Pass
Channel 6 Spurious Emissions – Antenna Terminal - 10GHz – 20GHz	Max Spur Signal @ -44.50 dBm – Pass
Channel 6 Spurious Emissions – Antenna Terminal - 20GHz – 26.5GHz	Max Spur Signal @ -42.00 dBm – Pass
Channel 11 Spurious Emissions – Antenna Terminal - 30MHz – 2GHz	Max Spur Signal @ -52.00 dBm – Pass
Channel 11 Spurious Emissions – Antenna Terminal - 2GHz – 10GHz	Max Spur Signal @ -43.00 dBm – Pass
Channel 11 Spurious Emissions – Antenna Terminal - 10GHz – 20GHz	Max Spur Signal @ -45.50 dBm – Pass
Channel 11 Spurious Emissions – Antenna Terminal - 20GHz – 26.5GHz	Max Spur Signal @ -42.17 dBm – Pass

**SPURIOUS EMISSIONS MEASUREMENT AT THE ANTENNA TERMINAL
(Continued)**

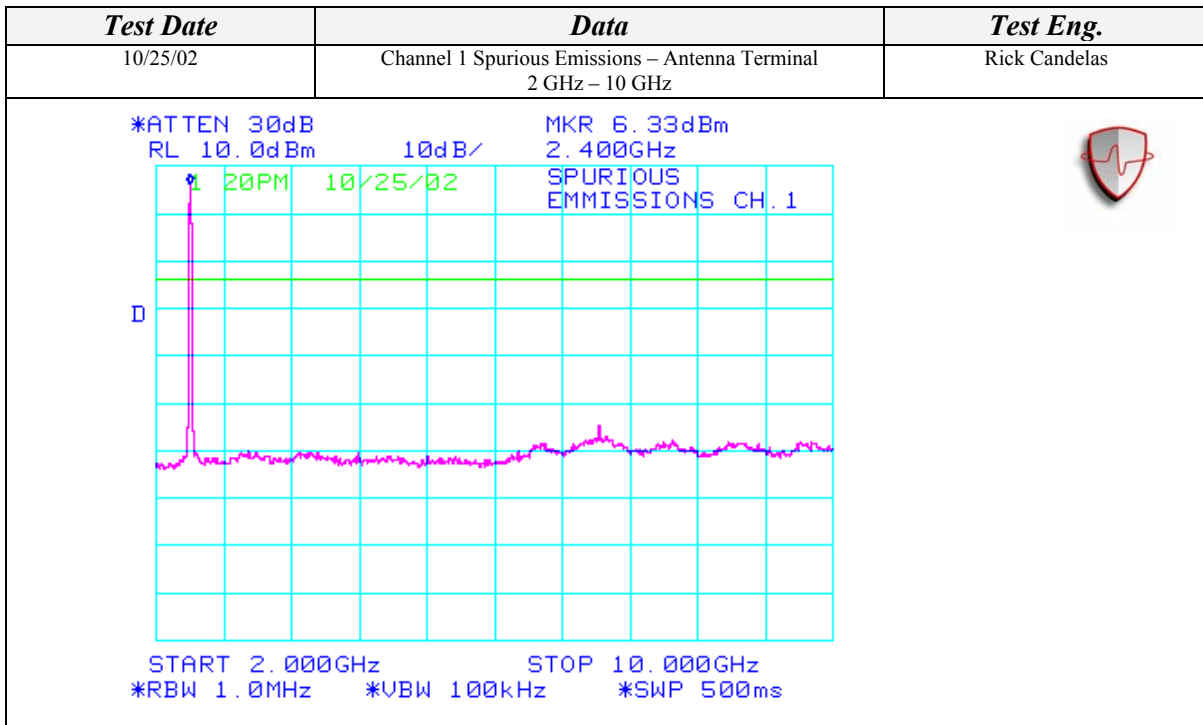
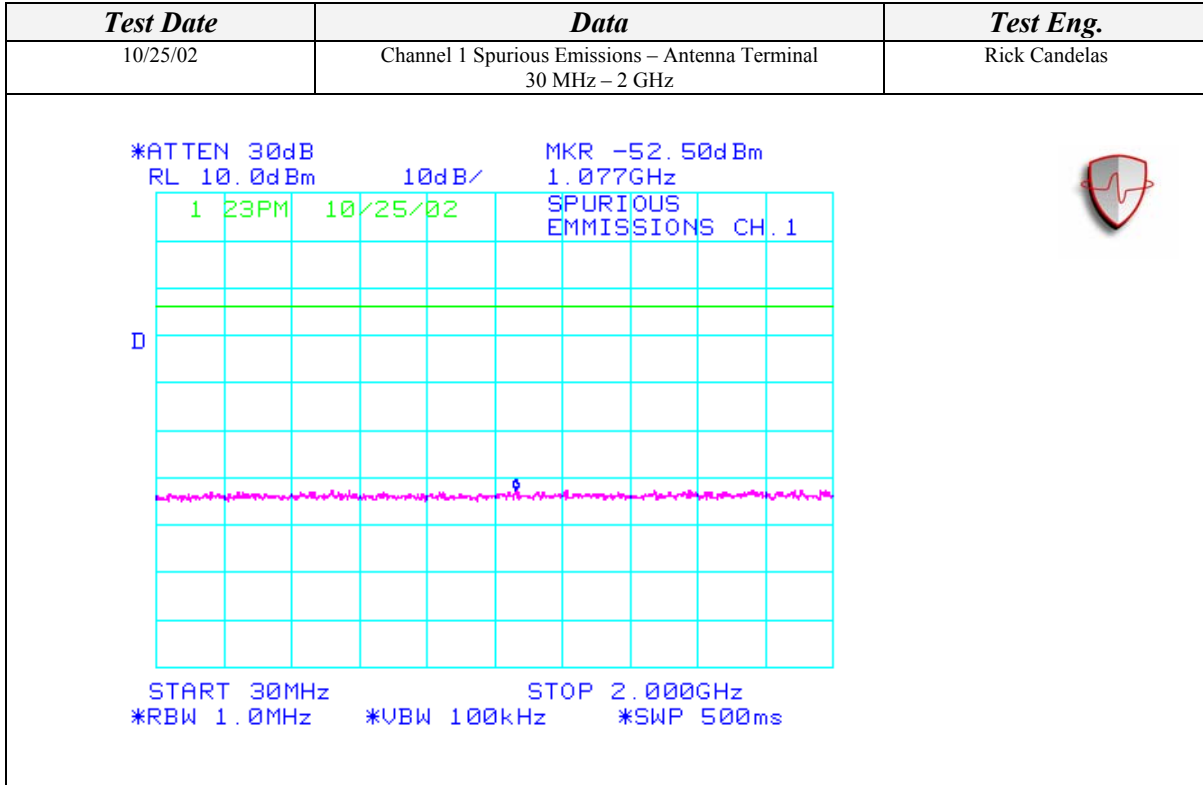

**SPURIOUS EMISSIONS MEASUREMENT AT THE ANTENNA TERMINAL
(Continued)**

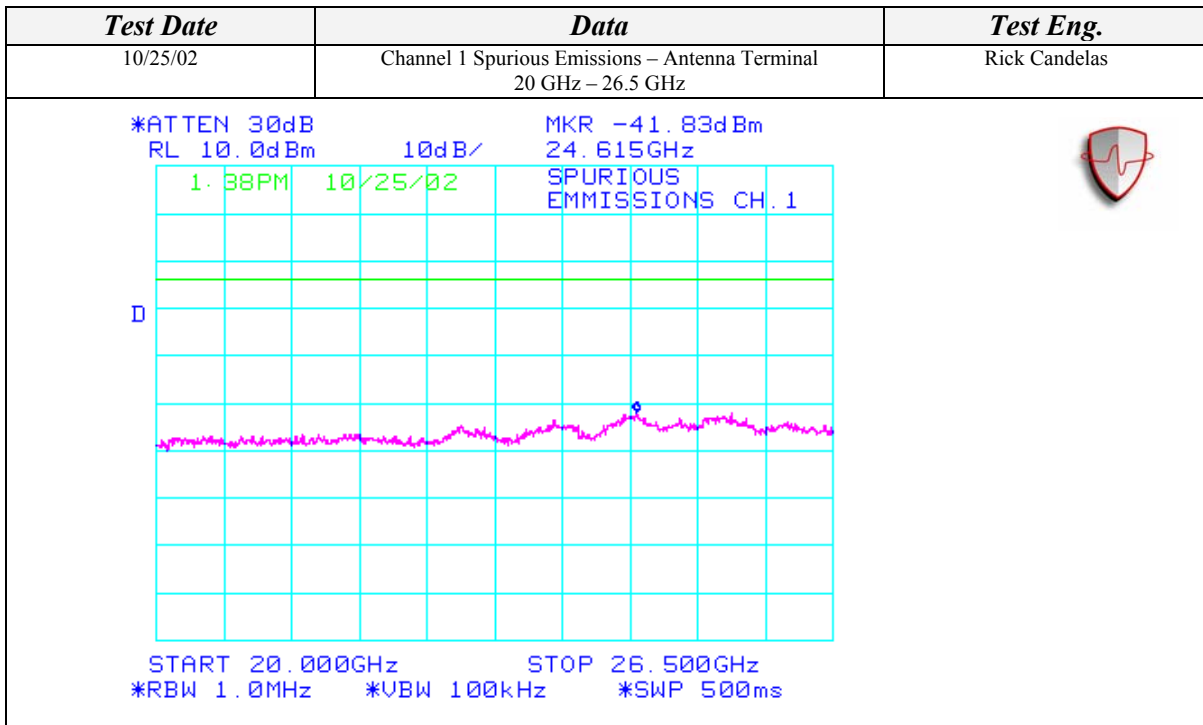
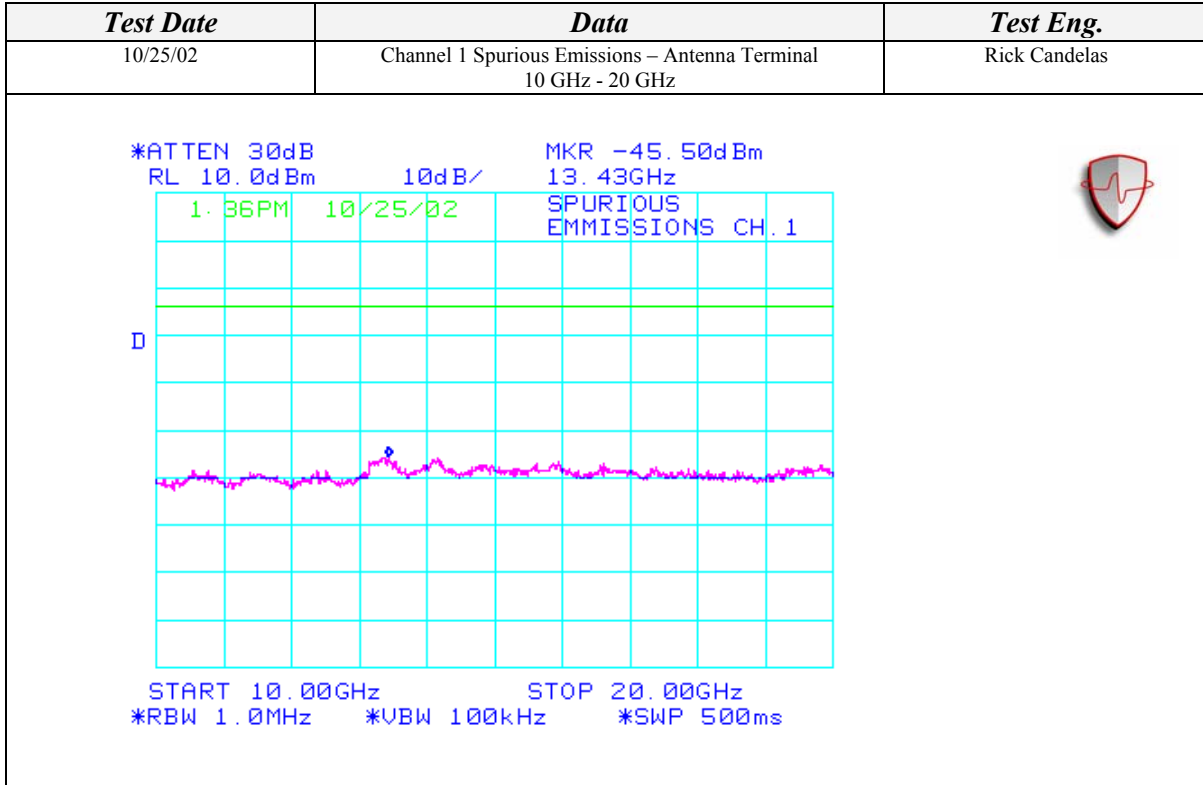

SPURIOUS EMISSIONS MEASUREMENT AT THE ANTENNA TERMINAL (Continued)

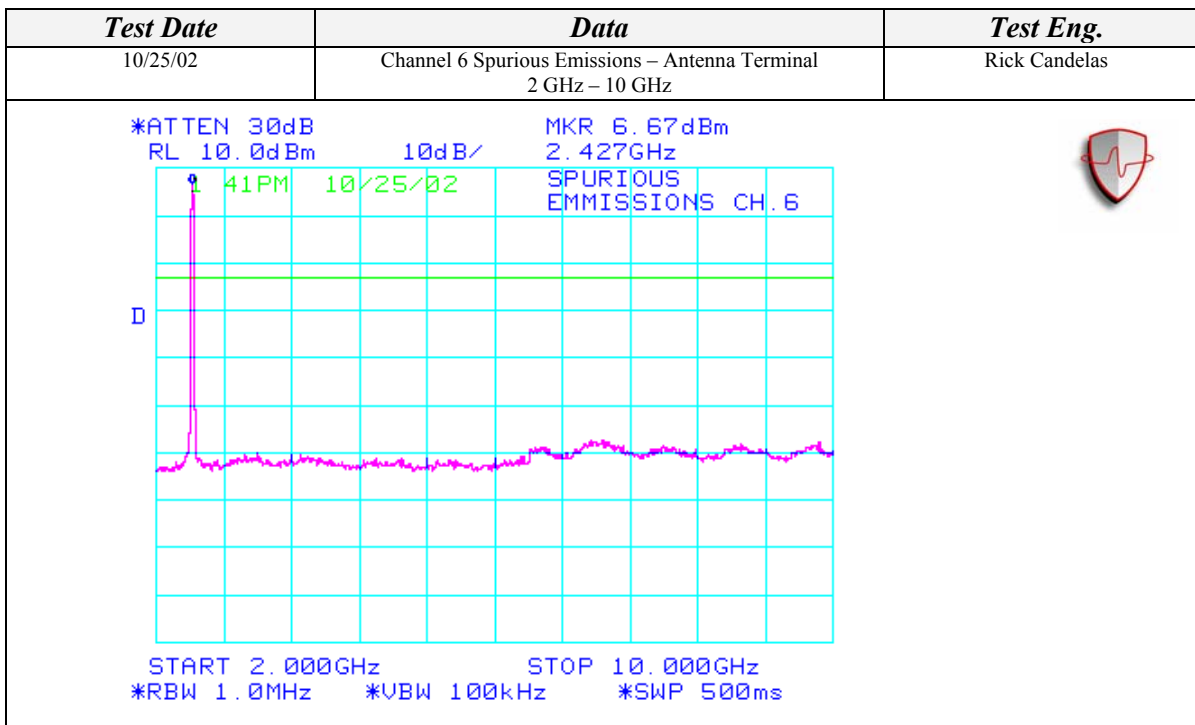
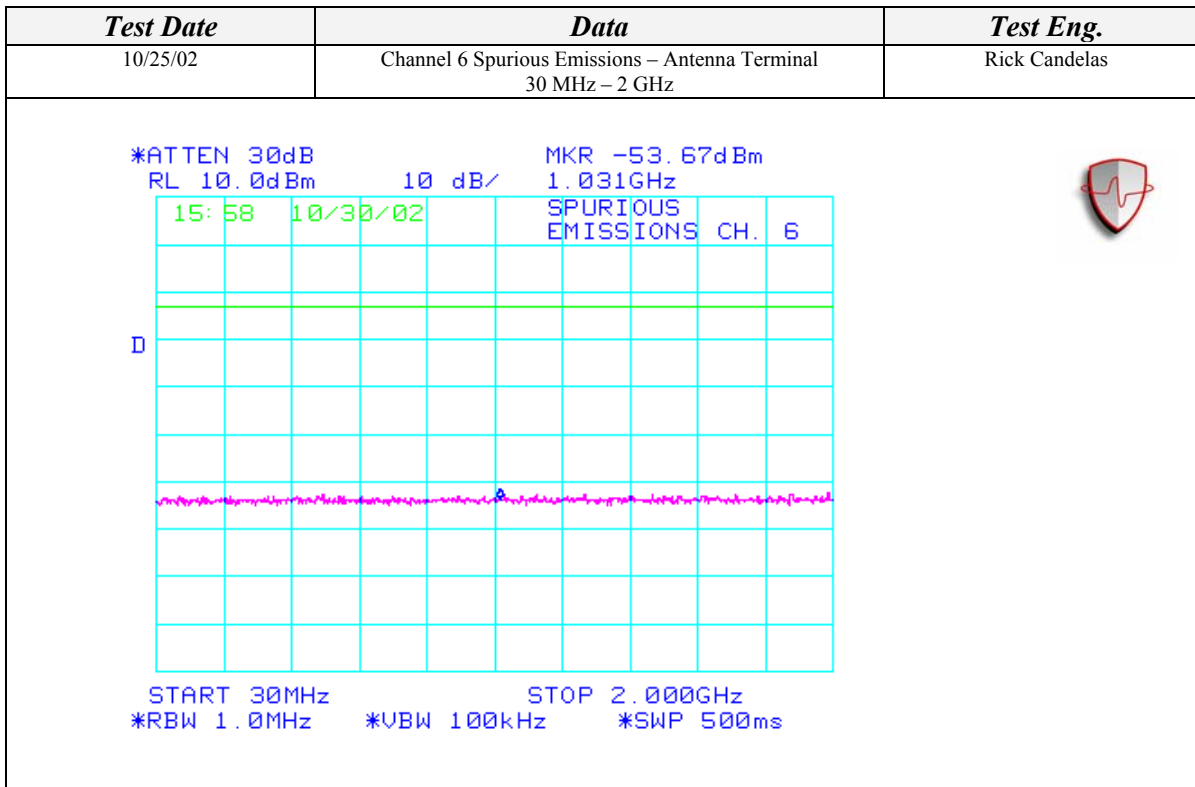

**SPURIOUS EMISSIONS MEASUREMENT AT THE ANTENNA TERMINAL
(Continued)**

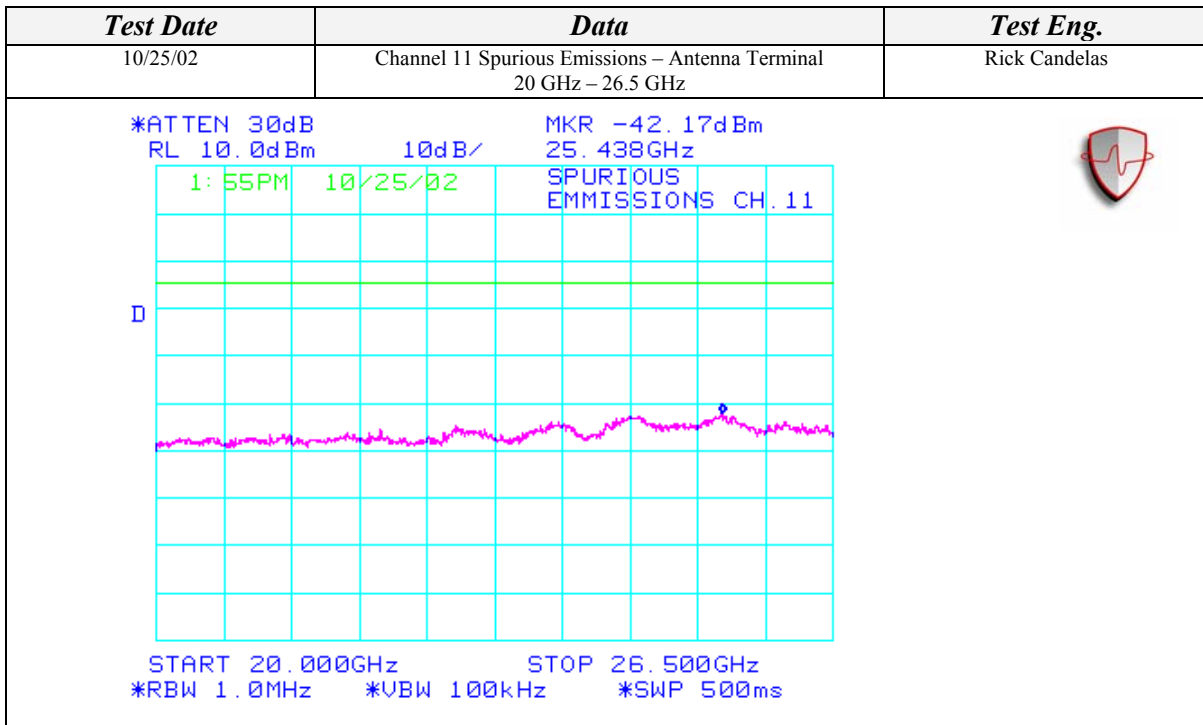
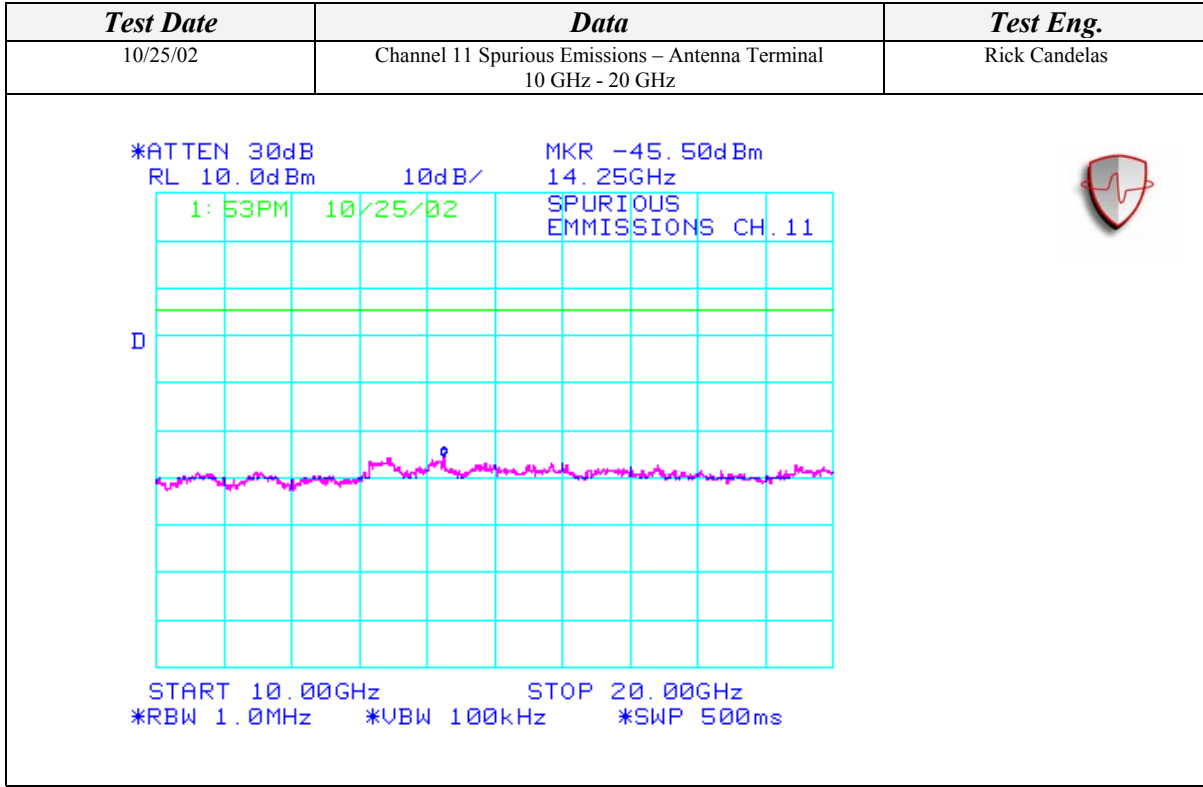

BAND EDGE EMISSIONS MEASUREMENT AT THE ANTENNA TERMINAL

CLIENT:	Intel Corporation	DATE:	10/25/02
EUT:	Mini PCI Type 3B Single Band 802.11b WLAN Adapter	PROJECT NUMBER:	INTEL-021001
MODEL NUMBER:	WM3B2100	TEST ENGINEER:	Rick Candelas
SERIAL NUMBER:	0004230018AE	SITE #:	2
CONFIGURATION:	Installed in IBM NetVista Desktop Computer, SN: KAOL42K	TEMPERATURE:	27 C
		HUMIDITY:	32% RH
		TIME:	11:00 AM

Standard:	FCC CFR 47, Part 15, 15.247(c)
Description:	Conducted Band Edge Emissions
Results:	In any 100 kHz bandwidth outside the frequency band in which the spread spectrum intentional radiator is operating, the radio frequency power that is produced by the intentional radiator shall be at least 20 dB below that in the 100 kHz bandwidth within the band that contains the highest level of the desired power, based on either an RF conducted or a radiated measurement.

TEST RESULTS SUMMARY	
Data	Result
Channel 1 Band Edge Measurement Peak Measurement @ 2390 MHz	>20 dBc – Pass
Channel 1 Band Edge Measurement Average Measurement @ 2390 MHz	56.01 dBuV - Pass
Channel 11 Band Edge Measurement Peak Measurement @ 2483.5 MHz	>20 dBc – Pass
Channel 11 Band Edge Measurement Average Measurement @ 2483.5 MHz	54.54 dBuV - Pass

CONDUCTED BAND EDGE EMISSIONS MEASUREMENT (Continued)

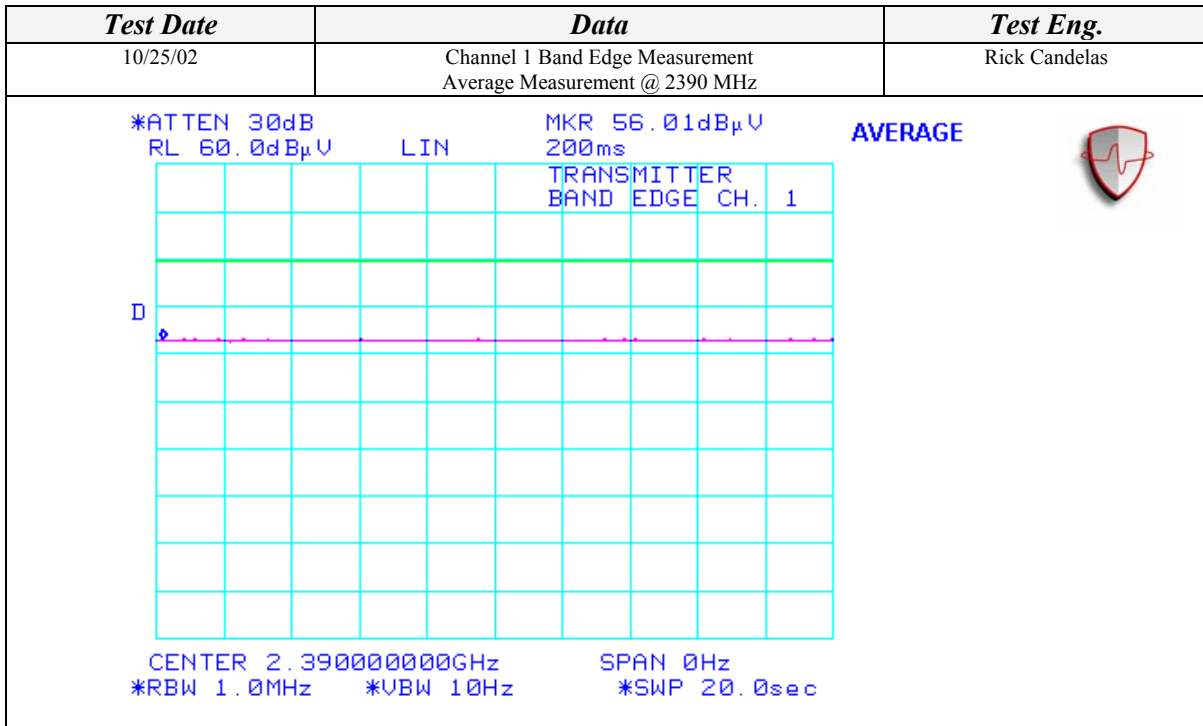
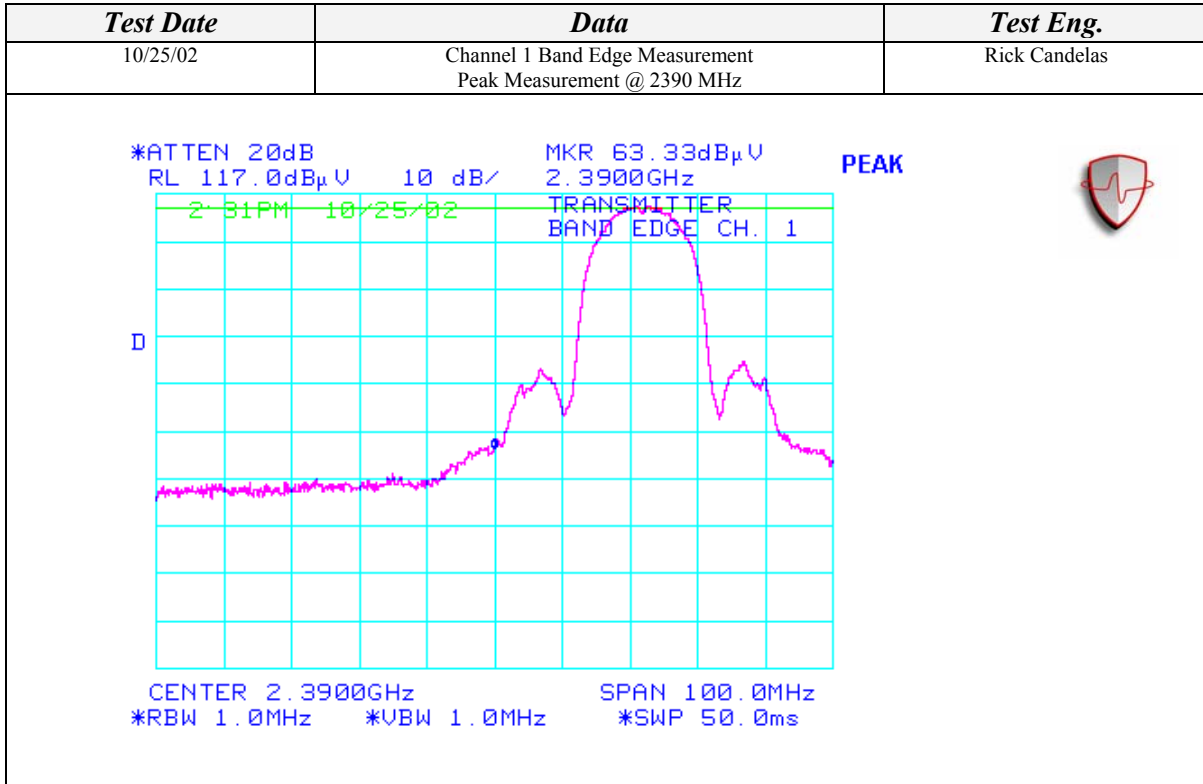

ALL CONDUCTED MEASUREMENTS SETUP

TEST EQUIPMENT USED					
Equipment Name	Manufacturer	Model Number	Serial Number	Calibration Due Date	Calibration Cycle
Spectrum Analyzer	Agilent	8564EC	4046A00387	02/28/04	2 Years
DC Block	Inmet	8039	N/A	N/A	N/A
Power Meter	Rohde & Schwarz	NRVS	DE30863	11/24/03	1 Year
Power Sensor	Leistungsmesskoph	NRV-Z5	844855/012	11/24/03	1 Year
Temperature / Humidity Monitor	Dickson	TH550	7255185	01/08/03	1 Year

EUT ACCESSORIES			
Equipment Name	Manufacturer	Model Number	Serial Number
NetVista Computer	IBM	21U	KAOL42K
Monitor	NEC	JC-1575VMA	2Y785821
Keyboard	IBM	SK-8811	1922408
Mouse	IBM	MU295	23-161493

BLOCK DIAGRAM

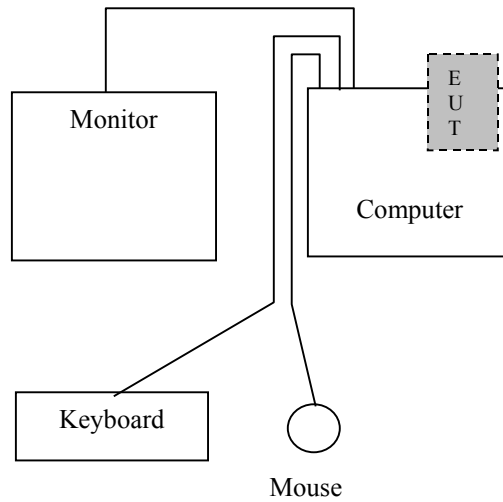

ALL CONDUCTED MEASUREMENTS SETUP (Continued)

PHOTOGRAPHS

