

**ELECTROMAGNETIC EMISSIONS COMPLIANCE REPORT
INTENTIONAL RADIATOR CERTIFICATION TO
FCC PART 15 SUBPART C (DTS) REQUIREMENT**

OF

Notebook with WLAN + Bluetooth module

Model Name: ZI2

FCC ID: HFSZI2WM3B2100BT

REPORT NO: 030049-RID

ISSUE DATE: April 24, 2003

Prepared for

**Quanta Computer Inc.
No. 188, Wen Hwa 2nd Rd., Kuei Shan Hsiang,
Tao Yuan Hsien, Taiwan, R.O.C.**

Prepared by

**C&C LABORATORY, CO., LTD.
#B1, 1st Fl., Universal Center,
No. 183, Sec. 1, Tatung Rd., Hsi Chih,
Taipei Hsien, Taiwan, R.O.C.**



TEL: (02)8642-2071~3

FAX: (02)8642-2256

This report shall not be reproduced, except in full, without the written approval of
C&C LABORATORY, CO., LTD.



VERIFICATION OF COMPLIANCE

Applicant: Quanta Computer Inc.
No. 188, Wen Hwa 2nd Rd., Kuei Shan Hsiang,
Tao Yuan Hsien, Taiwan, R.O.C.

Equipment Under Test: Notebook with WLAN + Bluetooth module

BRAND NAME: acer

MODEL No.: ZI2

Serial Number: N/A

File Number: 030049-RID

Date of Test: Apr. 10 2003 ~Apr. 15, 2003

We hereby certify that:

The above equipment was tested by C&C Laboratory Co., Ltd. The test data, data evaluation, test procedures, and equipment configurations shown in this report were made in accordance with the procedures given in ANSI C63.4 (2001) and the energy emitted by the sample EUT tested as described in this report is in compliance with conducted and radiated emission limits of FCC Rules Part 15.247.

The test results of this report relate only to the tested sample identified in this report.

Approved By

Jonson Lee / Director
C&C Laboratory Co., Ltd.

Review By

Susan Su / Section Manager
C&C Laboratory Co., Ltd.

Table of Contents

1.	GENERAL INFORMATION	5
1.1	PRODUCT DESCRIPTION	5
1.2	RELATED SUBMITTAL(S) / GRANT (S)	5
1.3	TEST METHODOLOGY	5
1.4	TEST FACILITY	6
1.5	SPECIAL ACCESSORIES	6
1.6	EQUIPMENT MODIFICATIONS.....	6
2.	SYSTEM TEST CONFIGURATION	7
2.1	EUT CONFIGURATION	7
2.2	EUT EXERCISE	7
2.3	TEST PROCEDURE	7
2.4	CONFIGURATION OF TESTED SYSTEM	8
3.	SUMMARY OF TEST RESULTS	9
4.	DESCRIPTION OF TEST MODES	9
5.	SPURIOUS EMISSION TEST	10
5.1	STANDARD APPLICABLE.....	10
5.2	EUT SETUP	10
5.3	MEASUREMENT PROCEDURE.....	10
5.4	TEST SET-UP (BLOCK DIAGRAM OF CONFIGURATION)	11
5.5	MEASUREMENT EQUIPMENT USED:.....	12
5.6	MEASUREMENT RESULT	12
6.	AC POWER LINE CONDUCTED EMISSION TEST	34
6.1.	STANDARD APPLICABLE.....	34
6.2.	EUT SETUP	34
6.3.	MEASUREMENT PROCEDURE.....	34
6.4.	MEASUREMENT EQUIPMENT USED:.....	35
6.5.	MEASUREMENT RESULT	35
7.	6 DB BANDWIDTH MEASUREMENT.....	38
7.1	STANDARD APPLICABLE.....	38
7.2	MEASUREMENT EQUIPMENT USED:.....	38
7.3	TEST SETUP:	38
7.4	MEASUREMENT PROCEDURE	39
7.5	MEASUREMENT RESULT	39



8.	PEAK OUTPUT POWER MEASUREMENT.....	42
8.1	STANDARD APPLICABLE.....	42
8.2	TEST SETUP.....	42
8.3	MEASUREMENT EQUIPMENT USED:.....	42
8.4	TEST RESULTS:	42
9.	100KHZ BANDWIDTH OF BAND EDGES MEASUREMENT	43
9.1	STANDARD APPLICABLE.....	43
9.2	MEASUREMENT PROCEDURE.....	43
9.3	MEASUREMENT RESULT	43
9.4	MEASUREMENT EQUIPMENT USED:.....	43
10.	PEAK POWER SPECTRAL DENSITY	45
10.1	STANDARD APPLICABLE.....	45
10.2	MEASUREMENT PROCEDURE.....	45
10.3	MEASUREMENT RESULT	45
10.4	MEASUREMENT EQUIPMENT USED:.....	45
11.	ANTENNA REQUIREMENT	48
11.1	STANDARD APPLICABLE.....	48
11.2	ANTENNA CONNECTED CONSTRUCTION	48
12.	RF EXPOSURE	49
12.1	STANDARD APPLICABLE.....	49
12.2	MEASUREMENT RESULT:.....	49

1. GENERAL INFORMATION

1.1 Product Description

The Quanta Computer Inc.. Model: ZI2 (referred to as the EUT in this report) is a Notebook with WLAN + Bluetooth module.

The EUT is compliance with IEEE 802.11 b and Bluetooth Standard.

A major Bluetooth Module technical descriptions of EUT is described as following:

- A). Operation Frequency: 2402 MHz – 2483 MHz, 79 channels
- B). Rated output power: 4 dBm (Peak)
- C). Modulation type: Frequency Hopping Sequence Spread Spectrum (FHSS)
- D). Antenna Designation: Metal Antenna, 0.64dBi, Non-User Replaceable (Fixed)

A major WLAN technical descriptions of EUT is described as following:

- A). Operation Frequency: 2.412GHz – 2.462GHz, 11 channels
- B). Transmit Power: 14 dBm (Peak)
- C). Modulation type: Direct Sequence Spread Spectrum, (CCK; DQPSK; DBPSK; DFSK)
- D). Transition Speed: 1/2/5.5/11Mbps
- E). Antenna Designation: PIFA Antenna; -0.16dBi, Non-User Embedded, two provided.
TX and RX diversity.

Power Supply: Input: AC 100-240V 50-60Hz 1.5A; Output: DC +19V, 3.95A

1.2 Related Submittal(s) / Grant (s)

This submittal(s) (test report) is intended for FCC ID: HFSZI2WM3B2100BT filing to comply with Section 15.247 of the FCC Part 15, Subpart C Rules. The composite system (digital device) is compliance with Subpart B is authorized under a DoC procedure.

1.3 Test Methodology

Both conducted and radiated testing was performed according to the procedures in ANSI C63.4 (1992). Radiated testing was performed at an antenna to EUT distance 3 meters..



1.4 Test Facility

The open area test site and conducted measurement facility used to collect the radiated data is located on the address of C&C Laboratory, Co., Ltd. No. 81-1, 210 Lane, Pa-de 2nd Road, Lu-Chu Hsiang, Taoyuan, Taiwan, R.O.C.. The Open Area Test Sites and the Line Conducted labs are constructed and calibrated to meet the FCC requirements in documents ANSI C63.4: 2001 and CISPR 22/EN 55022 requirements.

1.5 Special Accessories

Not available for this EUT intended for grant.

1.6 Equipment Modifications

Not available for this EUT intended for grant.

2. SYSTEM TEST CONFIGURATION

2.1 EUT Configuration

The EUT configuration for testing is installed on RF field strength measurement to meet the Commissions requirement and operating in a manner that intends to maximize its emission characteristics in a continuous normal application.

2.2 EUT Exercise

The EUT (Transmitter) was operated in the engineering mode to fix the Tx frequency that was for the purpose of the measurements.

2.3 Test Procedure

2.3.1 Conducted Emissions

The EUT is a placed on as turn table which is 0.8 m above ground plane. According to the requirements in Section 13.1.4.1 of ANSI C63.4-2001. Conducted emissions from the EUT measured in the frequency range between 0.15 MHz and 30MHz using CISPR Quasi-Peak detector mode.

2.3.2 Radiated Emissions

The EUT is a placed on as turn table which is 0.8 m above ground plane. The turn table shall rotate 360 degrees to determine the position of maximum emission level. EUT is set 3m away from the receiving antenna which varied from 1m to 4m to find out the highest emission. And also, each emission was to be maximized by changing the polarization of receiving antenna both horizontal and vertical. In order to find out the max. emission, the relative positions of this hand-held transmitter(EUT) was rotated through three orthogonal axes according to the requirements in Section 13.1.4.1 of ANSI C63.4-2001.

2.4 Configuration of Tested System

Fig. 2-1 Configuration of Tested System

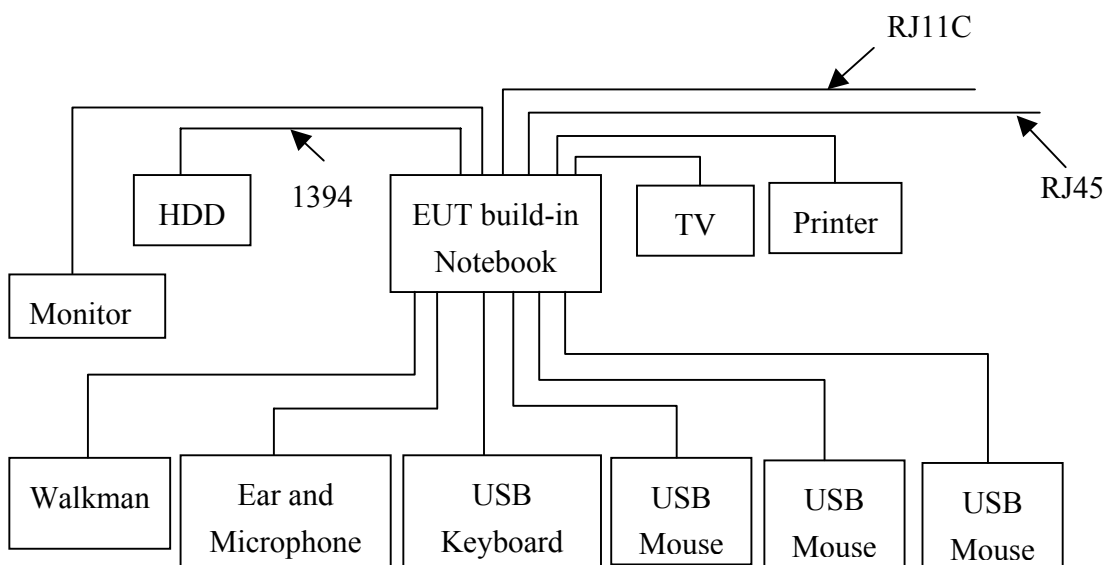

Table 2-1 Equipment Used in Tested System

Item	Equipment	Mfr/Brand	Model/Type No.	FCC ID	Series No.	Data Cable	Power Cord
1.	External HDD	IBM	N/A	N/A	DCAS-34330	Shielded, 1.8m	Unshielded, 1.8m
2.	Monitor	SONY	3882B102	2716043	CPD-G200	Shielded, 1.8m With a core	Shielded, 1.8m
3.	Printer	EPSON	EPSON STYLUS C20SX	N/A	DW4E130542	Shielded, 1.8m	Unshielded, 1.8m
4.	TV	PROTON	FT-21S	N/A	FT-21S00002CA00112	N/A	Unshielded, 1.8m
5.	Ear/Microphone	GITON	N/A	N/A	GT-2004V	Unshielded, 1.25m	N/A
6.	USB Keyboard	BTC	3872B597	G91400266	7932M	Shielded, 1.8m	N/A
7.	USB Mouse	Logitech	4872A221	LZE92250102	M-BB48	Shielded, 1.8m	N/A
8.	USB Mouse	Logitech	M-BB48	FCC DoC	LZE92250113	Shielded, 1.8m	N/A
9.	USB Mouse	Logitech	M-BB48	FCC DoC	LZE93300460	Shielded, 1.8m	N/A
10.	Walkman	Panasonic	RQ-L10	N/A	HB003029	Unshielded, 1.8m	N/A

3. SUMMARY OF TEST RESULTS

FCC Rules	Description Of Test	Result
§ 15.209(a) (f)	Spurious Emission	Compliant
§ 15.207(a)	AC Power Port Conducted Emission	Compliant
§ 15.247(a)(2)	6dB Bandwidth	Compliant
§ 15.247(b)	Peak Output Power	Compliant
§ 15.247(c)	100 KHz Bandwidth Of Frequency Band Edges	Compliant
§ 15.247(d)	Power Density	Compliant
§ 15.203	Antenna Requirement	Compliant
§ 1.1307(b)(1)	RF exposures	Compliant

4. DESCRIPTION OF TEST MODES

The EUT (Notebook with WLAN + Bluetooth module) has been tested under operating condition.

Test program used to control the EUT for staying in continuous transmitting mode is programmed.

The co-location test modes were defended as below for radiated spurious emission test and reported.

1. WLAN Channel Low + BT Channel Low
2. WLAN Channel Low + BT Channel Mid.
3. WLAN Channel Low + BT Channel High

WLAN module Channel low (2412MHz) 、 mid (2437MHz) and high (2462MHz) with 11Mbps highest data rate are chosen for others test items.

Peak Output Power was tested for both Antenna ports J5 and J6. The port J5 is higher than J6. The other test items of worst case at Antenna port A.

5. SPURIOUS EMISSION TEST

5.1 Standard Applicable

According to § 15.247(c), all other emissions outside these bands shall not exceed the general radiated emission limits specified in § 15.209(a). And according to § 15.33(a)(1), for an intentional radiator operates below 10GHz, the frequency range of measurements: to the tenth harmonic of the highest fundamental frequency or to 40GHz, whichever is lower.

5.2 EUT Setup

1. The radiated emission tests were performed in the 3 meter open-test site, using the setup in accordance with the ANSI C63.4-2001.
2. The EUT was put in the front of the test table. The host PC system was placed on the center of the back edge on the test table. The peripherals like modem, monitor, printer, K/B, and mouse were placed on the side of the host PC system. The rear of the EUT and peripherals were placed flushed with the rear of the tabletop.
3. The keyboard was placed directly in the front of the monitor, flushed with the front tabletop. The mouse was placed next to the Keyboard, flushed with the back of keyboard.
4. The spacing between the peripherals was 10 centimeters.
5. External I/O cables were draped along the edge of the test table and bundle when necessary.
6. The host PC system was connected with 110Vac/60Hz power source.

5.3 Measurement Procedure

1. The EUT was placed on a turn table which is 0.8m above ground plane.
2. The turn table shall rotate 360 degrees to determine the position of maximum emission level.
3. EUT is set 3m away from the receiving antenna which varied from 1m to 4m to find out the highest emissions.
4. Maximum procedure was performed on the six highest emissions to ensure EUT compliance.
5. And also, each emission was to be maximized by changing the polarization of receiving antenna both horizontal and vertical.
6. Repeat above procedures until all frequency measured were complete.

5.4 Test SET-UP (Block Diagram of Configuration)

(A) Radiated Emission Test Set-Up, Frequency Below 1000MHz

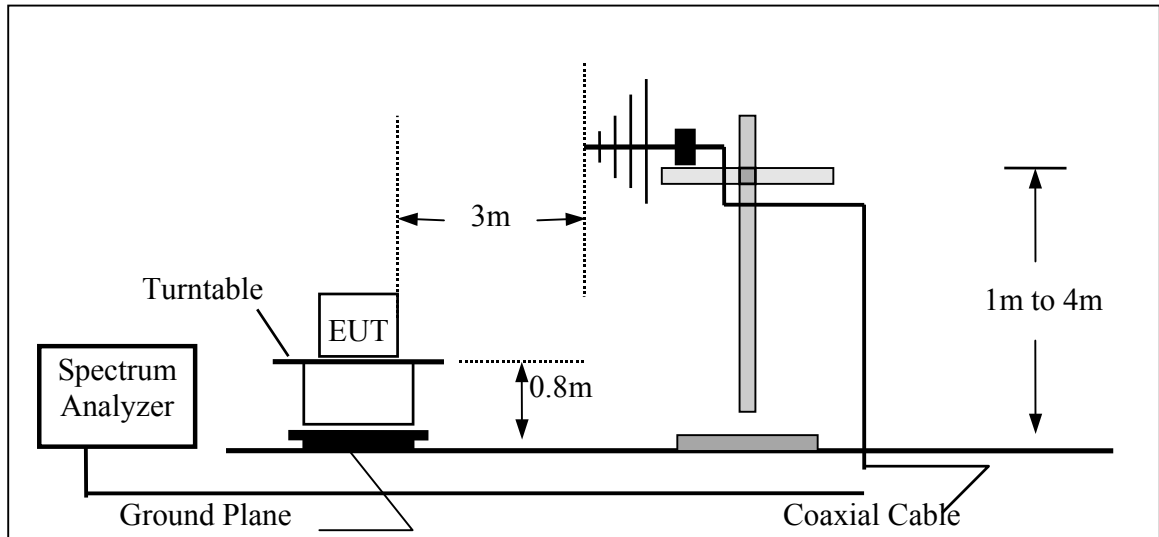

(B) Radiated Emission Test Set-UP Frequency Over 1 GHz

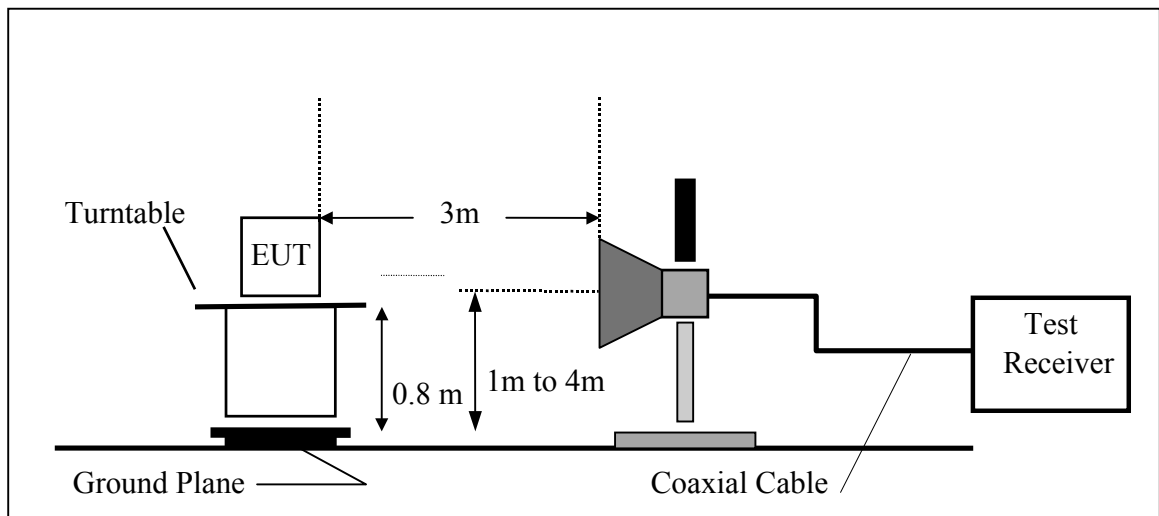

5.5 Measurement Equipment Used:

Open Area Test Site # 3					
EQUIPMENT TYPE	MFR	MODEL NUMBER	SERIAL NUMBER	LAST CAL.	CAL DUE.
Spectrum Analyzer	ADVANTEST	R3261A	81720301	08/28/2002	08/27/2003
Spectrum Analyzer	ROHDE & SCHWARZ	FSP30	100112	06/29/2002	06/28/2003
EMI Test Receiver	R&S	ESVS20	838804/004	01/09/2003	01/08/2004
Pre-Amplifier	HP	8447D	2944A09173	03/03/2003	03/02/2004
Bilog Antenna	SCHWAZBECK	VULB9163	145	07/06/2002	07/05/2003
Horn antenna	Schwarzbeck	BBHA 9120	D210	2/24/2003	2/23/2004
Pre-Amplifier	HP	8449B	3008B00965	10/01/2002	10/02/2003
Turn Table	EMCO	2081-1.21	9709-1885	N.C.R	N.C.R
Antenna Tower	EMCO	2075-2	9707-2060	N.C.R	N.C.R
Controller	EMCO	2090	9709-1256	N.C.R	N.C.R
RF Switch	ANRITSU	MP59B	M53867	N.C.R	N.C.R
Site NSA	C&C	N/A	N/A	09/07/2002	09/06/2003

Field Strength Calculation

The field strength is calculated by adding the Antenna Factor and Cable Factor and subtracting the Amplifier Gain and Duty Cycle Correction Factor(if any) from the measured reading. The basic equation with a sample calculation is as follows:

$$FS = RA + AF + CL - AG$$

Where	FS = Field Strength	CL = Cable Attenuation Factor (Cable Loss)
	RA = Reading Amplitude	AG = Amplifier Gain
	AF = Antenna Factor	

5.6 Measurement Result

Refer to attach tabular data sheets.

NOTE:

The resolution bandwidth and video bandwidth of test receiver/spectrum analyzer is 100kHz for Peak detection (PK) and Quasi-peak detection (QP) at frequency below 1GHz.



Conducted Spurious Emission Measurement Result

Ch Low

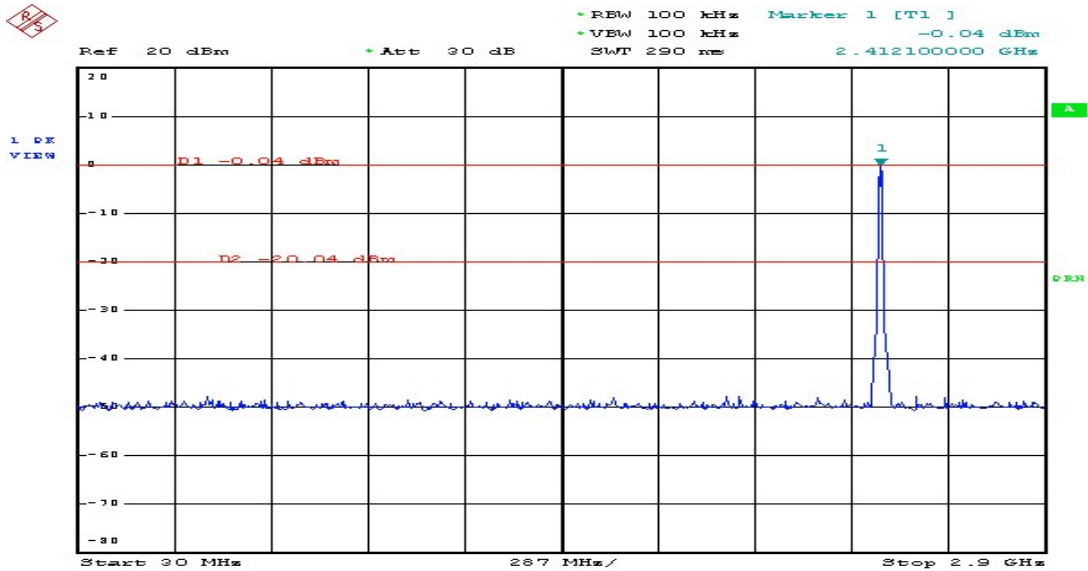

Date: 10.APR.2003 10:35:39

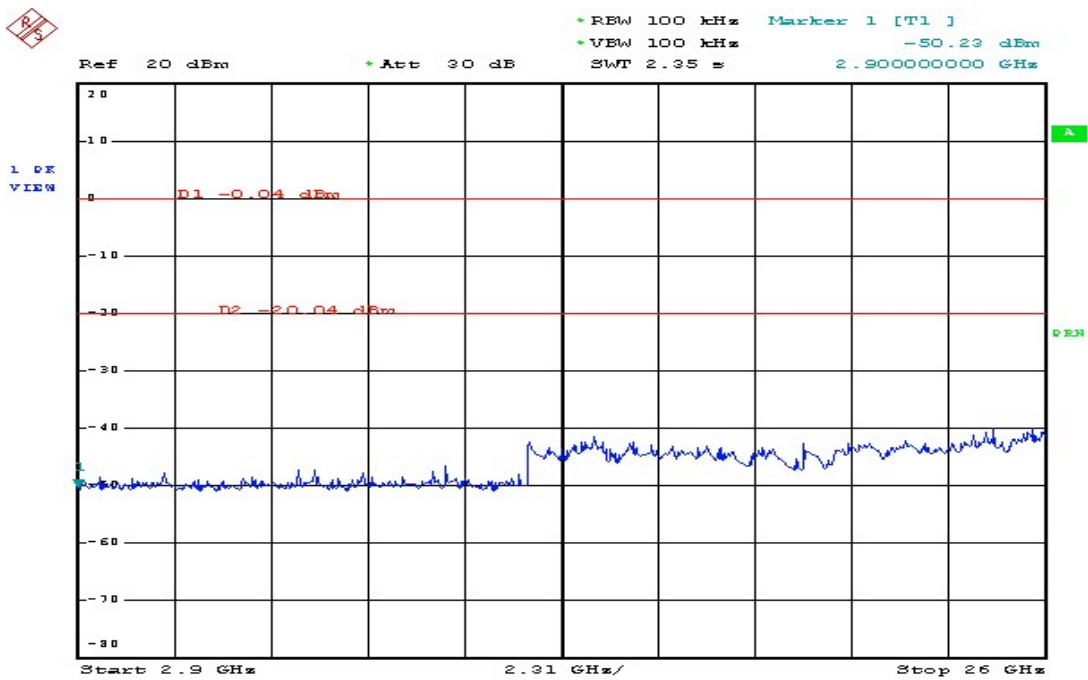

Date: 10.APR.2003 10:36:19



Ch Mid

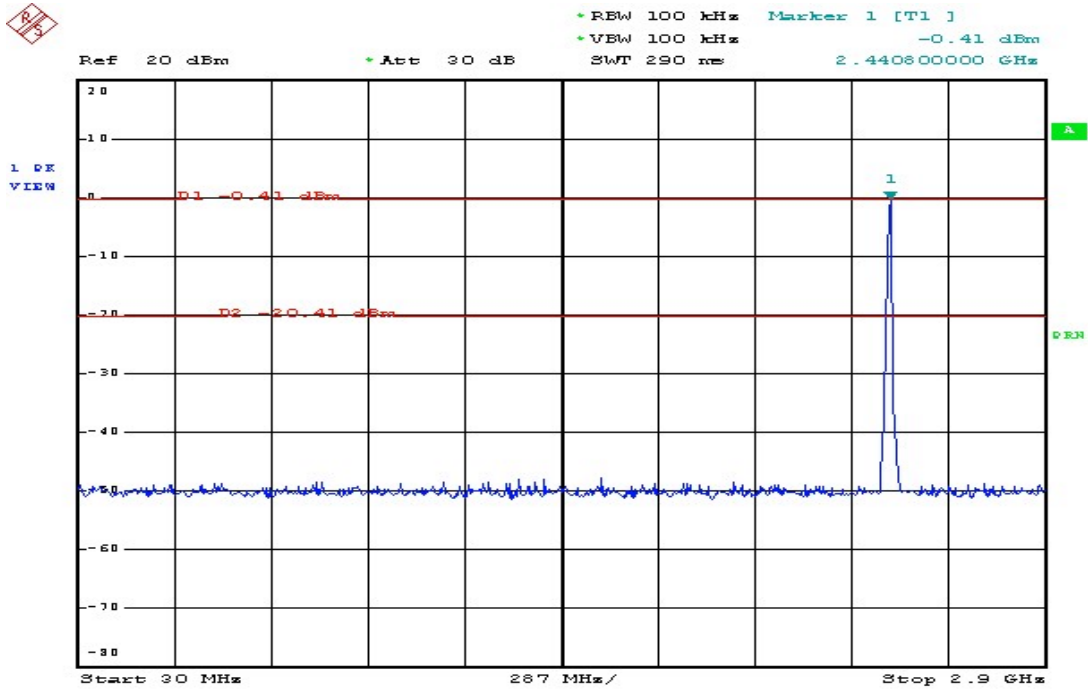

Date: 10.APR.2003 10:33:13

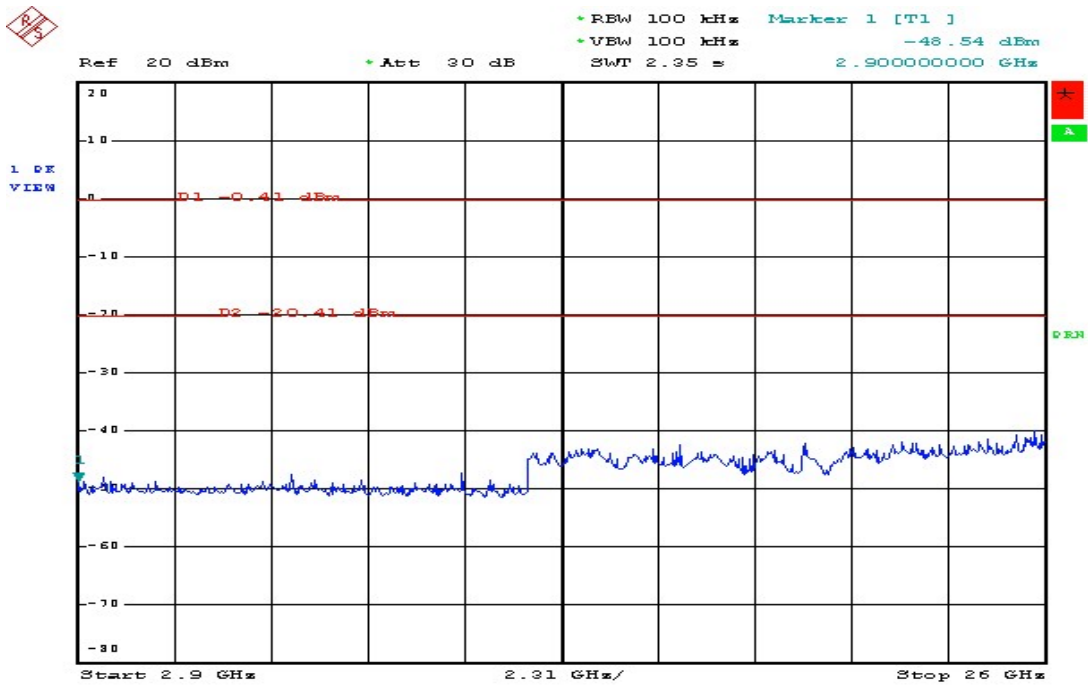

Date: 10.APR.2003 10:34:10

Ch High

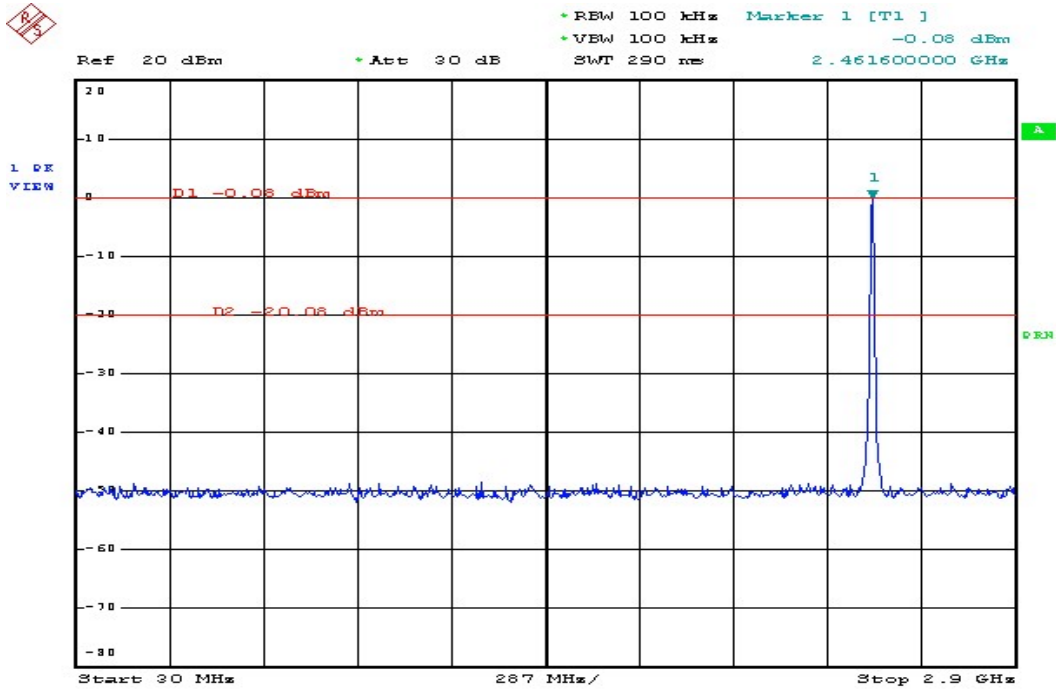

Date: 10.APR.2003 10:27:44

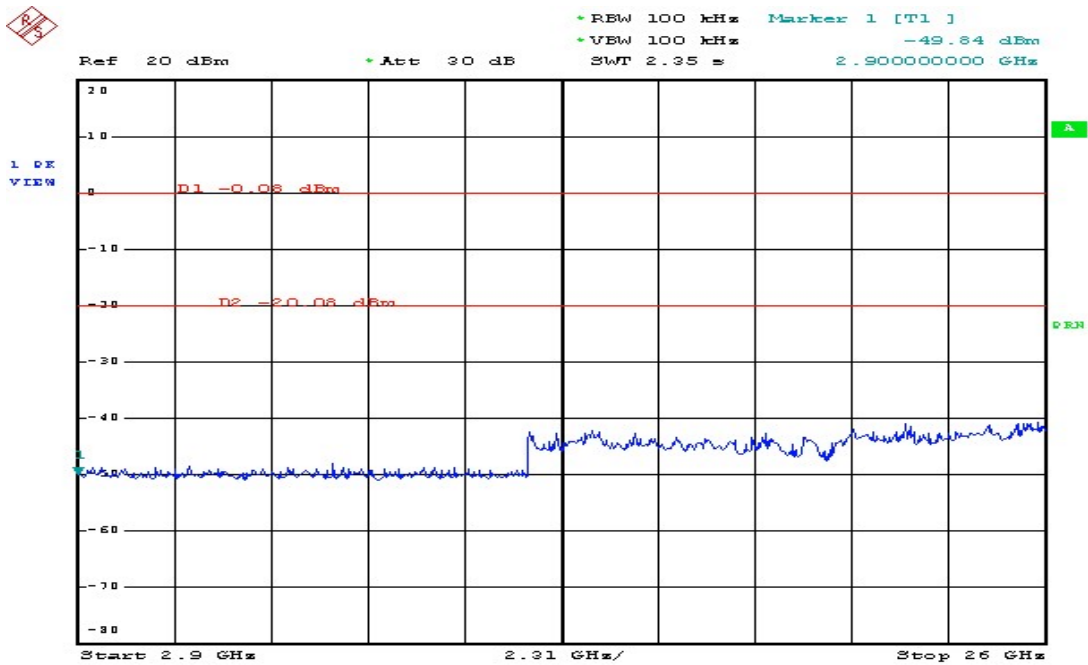

Date: 10.APR.2003 10:30:46

Radiated Spurious Emission Measurement Result (below 1GHz) – (WLAN)

Operation Mode: TX CH Low Mode Test Date: 04. 10, 2003
 Temperature: 20 °C Test By: Roic
 Humidity: 70 % Pol: Ver./Hor

Freq. (MHz)	Ant.Pol. H/V	Detector Mode (PK/QP)	Reading (dBuV)	Factor (dB)	Actual FS (dBuV/m)	Limit 3m (dBuV/m)	Safe Margin (dB)
54.30	V	Peak	19.50	14.61	34.11	40.00	-5.89
64.02	V	Peak	20.88	12.12	33.00	40.00	-7.00
67.26	V	Peak	21.51	11.04	32.55	40.00	-7.45
463.80	V	Peak	20.46	20.82	41.28	46.00	-4.72
756.40	V	Peak	13.46	25.91	39.37	46.00	-6.63
918.80	V	Peak	12.27	28.42	40.69	46.00	-5.31
237.90	H	Peak	22.38	15.83	38.21	46.00	-7.79
248.70	H	Peak	20.64	16.26	36.90	46.00	-9.10
365.80	H	Peak	18.73	18.88	37.61	46.00	-8.39
596.80	H	Peak	10.08	25.30	35.38	46.00	-10.62
886.60	H	Peak	8.64	27.92	36.56	46.00	-9.44

Remark :

- (1) Measuring frequencies from 30 MHz to the 1GHz °
- (2) Radiated emissions measured in frequency range from 30 MHz to 1000MHz were made with an instrument using Peak detector mode.
- (3) Datas of measurement within this frequency range shown “ - ” in the table above means the reading of emissions are attenuated more than 20dB below the permissible limits or the field strength is too small to be measured.
- (4) The IF bandwidth of SPA between 30MHz to 1GHz was 100KHz.

Radiated Spurious Emission Measurement Result (below 1GHz) – (WLAN)

Operation Mode: TX CH Mid Mode Test Date: 04. 10, 2003
 Temperature: 20 °C Test By: Roic
 Humidity: 70 % Pol: Ver./Hor

Freq. (MHz)	Ant.Pol. H/V	Detector Mode (PK/QP)	Reading (dBuV)	Factor (dB)	Actual FS (dBuV/m)	Limit3m (dBuV/m)	Safe Margin (dB)
54.84	V	Peak	20.75	14.50	35.25	40.00	-4.75
64.02	V	Peak	23.18	12.12	35.30	40.00	-4.70
84.54	V	Peak	20.81	10.68	31.49	40.00	-8.51
466.60	V	Peak	17.36	20.95	38.31	46.00	-7.69
756.40	V	Peak	12.12	25.91	38.03	46.00	-7.97
918.80	V	Peak	12.16	28.42	40.58	46.00	-5.42
120.72	H	Peak	22.25	11.54	33.79	43.50	-9.71
194.70	H	Peak	19.36	14.39	33.75	43.50	-9.75
365.80	H	Peak	17.98	18.88	36.86	46.00	-9.14
466.60	H	Peak	14.91	20.95	35.86	46.00	-10.14
756.40	H	Peak	10.76	25.91	36.67	46.00	-9.33
918.80	H	Peak	10.62	28.42	39.04	46.00	-6.96

Remark :

- (1) Measuring frequencies from 30 MHz to the 1GHz ◦
- (2) Radiated emissions measured in frequency range from 30 MHz to 1000MHz were made with an instrument using Peak detector mode.
- (3) Datas of measurement within this frequency range shown “ - ” in the table above means the reading of emissions are attenuated more than 20dB below the permissible limits or the field strength is too small to be measured.
- (4) The IF bandwidth of SPA between 30MHz to 1GHz was 100KHz.

Radiated Spurious Emission Measurement Result (below 1GHz) – (WLAN)

Operation Mode: TX CH High Mode Test Date: 04. 10, 2003
 Temperature: 20 °C Test By: Roic
 Humidity: 70 % Pol: Ver./Hor

Freq. (MHz)	Ant.Pol. H/V	Detector Mode (PK/QP)	Reading (dBuV)	Factor (dB)	Actual FS (dBuV/m)	Limit3m (dBuV/m)	Safe Margin (dB)
54.30	V	Peak	19.05	14.61	33.66	40.00	-6.34
60.78	V	Peak	18.68	13.20	31.88	40.00	-8.12
463.80	V	Peak	20.76	20.82	41.58	46.00	-4.42
566.00	V	Peak	11.58	24.63	36.21	46.00	-9.79
756.40	V	Peak	12.36	25.91	38.27	46.00	-7.73
918.80	V	Peak	12.18	28.42	40.60	46.00	-5.40
237.90	H	Peak	20.82	15.83	36.65	46.00	-9.35
365.80	H	Peak	18.21	18.88	37.09	46.00	-8.91
386.80	H	Peak	14.29	20.01	34.30	46.00	-11.70
756.40	H	Peak	11.24	25.91	37.15	46.00	-8.85
886.60	H	Peak	7.67	27.92	35.59	46.00	-10.41
918.80	H	Peak	9.73	28.42	38.15	46.00	-7.85

Remark :

- (1) Measuring frequencies from 30 MHz to the 1GHz ◦
- (2) Radiated emissions measured in frequency range from 30 MHz to 1000MHz were made with an instrument using Peak detector mode.
- (3) Datas of measurement within this frequency range shown “ - ” in the table above means the reading of emissions are attenuated more than 20dB below the permissible limits or the field strength is too small to be measured.
- (4) The IF bandwidth of SPA between 30MHz to 1GHz was 100KHz.

Radiated Spurious Emission Measurement Result (Above 1GHz) – (WLAN)

Operation Mode: TX CH Low Mode Test Date: 04. 10, 2003
 Temperature: 20 °C Test By: Roic
 Humidity: 70 % Pol: Vertical

Freq. (MHz)	Peak	AV	Ant./CL CF(dB)	Actual FS		Peak	AV	Margin (dB)	Remark
	Reading (dBuV)	Reading (dBuV)		Peak (dBuV/m)	AV (dBuV/m)	Limit (dBuV/m)	Limit (dBuV/m)		
1132	61.17	---	-9.49	51.68	---	74.00	54.00	-2.32	Peak
1512	53.18	---	-7.50	45.68	---	74.00	54.00	-8.32	Peak
4824	--					74.00	54.00		
7236	--					74.00	54.00		
9648	--					74.00	54.00		
12060	--					74.00	54.00		
14472	--					74.00	54.00		
16884	--					74.00	54.00		
19296	--					74.00	54.00		
21708	--					74.00	54.00		
24120	--					74.00	54.00		

Remark :

- (1) Measuring frequencies from 1 GHz to the 10th harmonic of highest fundamental frequency °
- (2) Datas of measurement within this frequency range shown “ - ” in the table above means the reading of emissions are attenuated more than 20dB below the permissible limits or the field strength is too small to be measured.
- (3) Radiated emissions measured in frequency above 1000MHz were made with an instrument using Peak detector mode and average detector mode of the emission shown in Actual FS column °
- (4) Spectrum Peak Setting 1GHz- 26GHz, RBW= 1MHz, VBW= 1MHz, Sweep time= 200 ms.
Spectrum AV Setting 1GHz- 26GHz, RBW= 1MHz, VBW= 10Hz, Sweep time= 200 ms.

Radiated Spurious Emission Measurement Result (Above 1GHz) – (WLAN)

Operation Mode: TX Low Mode Test Date: 04. 10, 2003
 Temperature: 20°C Test By: Roic
 Humidity: 70 % Pol: Horizontal

Freq. (MHz)	Peak	AV	Ant./CL CF(dB)	Actual FS		Peak	AV	Margin (dB)	Remark
	Reading (dBuV)	Reading (dBuV)		Peak (dBuV/m)	AV (dBuV/m)	Limit (dBuV/m)	Limit (dBuV/m)		
1132	57.16	---	-9.49	47.67	---	74.00	54.00	-6.33	Peak
1512	53.21	---	-7.50	45.71	---	74.00	54.00	-8.29	Peak
4824	--					74.00	54.00		
7236	--					74.00	54.00		
9648	--					74.00	54.00		
12060	--					74.00	54.00		
14472	--					74.00	54.00		
16884	--					74.00	54.00		
19296	--					74.00	54.00		
21708	--					74.00	54.00		
24120	--					74.00	54.00		

Remark :

- (1) Measuring frequencies from 1 GHz to the 10th harmonic of highest fundamental frequency °
- (2) Datas of measurement within this frequency range shown “ - ” in the table above means the reading of emissions are attenuated more than 20dB below the permissible limits or the field strength is too small to be measured.
- (3) Radiated emissions measured in frequency above 1000MHz were made with an instrument using Peak detector mode and average detector mode of the emission shown in Actual FS column °
- (4) Spectrum Peak Setting 1GHz- 26GHz, RBW= 1MHz, VBW= 1MHz, Sweep time= 200 ms.
Spectrum AV Setting 1GHz- 26GHz, RBW= 1MHz, VBW= 10Hz, Sweep time= 200 ms.

Radiated Spurious Emission Measurement Result (Above 1GHz) – (WLAN)

Operation Mode: TX Mid Mode Test Date : 04. 10, 2003
 Temperature: 20 °C Test By: Roic
 Humidity: 70 % Pol: Vertical

Freq. (MHz)	Peak	AV	Ant./CL CF(dB)	Actual FS		Peak	AV	Margin (dB)	Remark
	Reading (dBuV)	Reading (dBuV)		Peak (dBuV/m)	AV (dBuV/m)	Limit (dBuV/m)	Limit (dBuV/m)		
1132	58.54	---	-9.49	49.05	---	74.00	54.00	-4.95	Peak
1512	51.98	---	-7.50	44.48	---	74.00	54.00	-9.52	Peak
4874	--					74.00	54.00		
7311	--					74.00	54.00		
9748	--					74.00	54.00		
12185	--					74.00	54.00		
14622	--					74.00	54.00		
17059	--					74.00	54.00		
19496	--					74.00	54.00		
21933	--					74.00	54.00		
24370	--					74.00	54.00		

Remark :

- (1) Measuring frequencies from 1 GHz to the 10th harmonic of highest fundamental frequency °
- (2) Datas of measurement within this frequency range shown “ - ” in the table above means the reading of emissions are attenuated more than 20dB below the permissible limits or the field strength is too small to be measured.
- (3) Radiated emissions measured in frequency above 1000MHz were made with an instrument using Peak detector mode and average detector mode of the emission shown in Actual FS column °
- (4) Spectrum Peak Setting 1GHz- 26GHz, RBW= 1MHz, VBW= 1MHz, Sweep time= 200 ms.
Spectrum AV Setting 1GHz- 26GHz, RBW= 1MHz, VBW= 10Hz, Sweep time= 200 ms.

Radiated Spurious Emission Measurement Result (Above 1GHz) – (WLAN)

Operation Mode: TX Mid Mode Test Date: 04. 10, 2003
 Temperature: 20 °C Test By: Roic
 Humidity: 70 % Pol: Horizontal

Freq. (MHz)	Peak	AV	Ant./CL CF(dB)	Actual FS		Peak	AV	Margin (dB)	Remark
	Reading (dBuV)	Reading (dBuV)		Peak (dBuV/m)	AV (dBuV/m)	Limit (dBuV/m)	Limit (dBuV/m)		
1060	54.20	---	-10.01	44.19	---	74.00	54.00	-9.81	Peak
1132	56.09	---	-9.49	46.60	---	74.00	54.00	-7.40	Peak
4874	--					74.00	54.00		
7311	--					74.00	54.00		
9748	--					74.00	54.00		
12185	--					74.00	54.00		
14622	--					74.00	54.00		
17059	--					74.00	54.00		
19496	--					74.00	54.00		
21933	--					74.00	54.00		
24370	--					74.00	54.00		

Remark :

- (1) Measuring frequencies from 1 GHz to the 10th harmonic of highest fundamental frequency °
- (2) Datas of measurement within this frequency range shown “ - ” in the table above means the reading of emissions are attenuated more than 20dB below the permissible limits or the field strength is too small to be measured.
- (3) Radiated emissions measured in frequency above 1000MHz were made with an instrument using Peak detector mode and average detector mode of the emission shown in Actual FS column °
- (4) Spectrum Peak Setting 1GHz- 26GHz, RBW= 1MHz, VBW= 1MHz, Sweep time= 200 ms.
Spectrum AV Setting 1GHz- 26GHz, RBW= 1MHz, VBW= 10Hz, Sweep time= 200 ms.

Radiated Spurious Emission Measurement Result (Above 1GHz) – (WLAN)

Operation Mode:	TX High Mode	Test Date:	04. 10, 2003
Temperature:	20 °C	Test By:	Roic
Humidity:	70 %	Pol:	Vertical

Freq. (MHz)	Peak	AV	Ant./CL CF(dB)	Actual FS		Peak	AV	Margin (dB)	Remark
	Reading (dBuV)	Reading (dBuV)		Peak (dBuV/m)	AV (dBuV/m)	Limit (dBuV/m)	Limit (dBuV/m)		
1060	55.88	---	-9.98	45.90	---	74.00	54.00	-8.10	Peak
1132	58.74	---	-9.49	49.25	---	74.00	54.00	-4.75	Peak
1512	52.11	---	-7.50	44.61	---	74.00	54.00	-9.39	Peak
4924	--					74.00	54.00		
7386	--					74.00	54.00		
9848	--					74.00	54.00		
12310	--					74.00	54.00		
14772	--					74.00	54.00		
17234	--					74.00	54.00		
19696	--					74.00	54.00		
22158	--					74.00	54.00		

Remark :

- (1) Measuring frequencies from 1 GHz to the 10th harmonic of highest fundamental frequency °
- (2) Datas of measurement within this frequency range shown “ - ” in the table above means the reading of emissions are attenuated more than 20dB below the permissible limits or the field strength is too small to be measured.
- (3) Radiated emissions measured in frequency above 1000MHz were made with an instrument using Peak detector mode and average detector mode of the emission shown in Actual FS column °
- (4) Spectrum Peak Setting 1GHz- 26GHz, RBW= 1MHz, VBW= 1MHz, Sweep time= 200 ms.
Spectrum AV Setting 1GHz- 26GHz, RBW= 1MHz, VBW= 10Hz, Sweep time= 200 ms.

Radiated Spurious Emission Measurement Result (Above 1GHz) – (WLAN)

Operation Mode:	TX High Mode	Test Date:	04. 10 2003
Temperature:	20 °C	Test By:	Roic
Humidity:	70 %	Pol:	Horizontal

Freq. (MHz)	Peak	AV	Ant./CL CF(dB)	Actual FS		Peak	AV	Margin (dB)	Remark
	Reading (dBuV)	Reading (dBuV)		Peak (dBuV/m)	AV (dBuV/m)	Limit (dBuV/m)	Limit (dBuV/m)		
1060	54.67	---	-10.01	44.66	---	74.00	54.00	-9.34	Peak
1132	56.19	---	-9.49	46.70	---	74.00	54.00	-7.30	Peak
4924	--					74.00	54.00		
7386	--					74.00	54.00		
9848	--					74.00	54.00		
12310	--					74.00	54.00		
14772	--					74.00	54.00		
17234	--					74.00	54.00		
19696	--					74.00	54.00		
22158	--					74.00	54.00		
24620	--					74.00	54.00		

Remark :

- (1) Measuring frequencies from 1 GHz to the 10th harmonic of highest fundamental frequency °
- (2) Datas of measurement within this frequency range shown “ - ” in the table above means the reading of emissions are attenuated more than 20dB below the permissible limits or the field strength is too small to be measured.
- (3) Radiated emissions measured in frequency above 1000MHz were made with an instrument using Peak detector mode and average detector mode of the emission shown in Actual FS column °
- (4) Spectrum Peak Setting 1GHz- 26GHz, RBW= 1MHz, VBW= 1MHz, Sweep time= 200 ms.
Spectrum AV Setting 1GHz- 26GHz, RBW= 1MHz, VBW= 10Hz, Sweep time= 200 ms.

Radiated Spurious Emission Measurement Result (below 1GHz) – (Co-Location)

Operation Mode: WLAN (TX CH Low Mode) + Bluetooth (TX CH Low Mode) Test Date: 04. 14, 2003
 Temperature: 20°C Test By: Jacky
 Humidity: 70 % Pol: Ver./Hor

Freq. (MHz)	Ant.Pol. H/V	Detector Mode (PK/QP)	Reading (dBuV)	Factor (dB)	Actual FS (dBuV/m)	Limit @ 3m (dBuV/m)	Margin (dB)
72.12	V	Peak	28.24	10.00	38.24	40.00	-1.76
84.54	V	Peak	23.28	10.68	33.96	40.00	-6.04
261.12	V	Peak	23.56	16.04	39.60	46.00	-6.40
300.00	V	Peak	23.09	16.68	39.77	46.00	-6.23
326.60	V	Peak	19.67	17.40	37.07	46.00	-8.93
391.00	V	Peak	16.04	20.24	36.28	46.00	-9.72
72.12	H	Peak	28.44	10.00	38.44	40.00	-1.56
84.54	H	Peak	25.08	10.68	35.76	40.00	-4.24
166.08	H	Peak	26.18	11.85	38.03	43.50	-5.47
300.00	H	Peak	24.87	16.68	41.55	46.00	-4.45
336.40	H	Peak	19.28	17.66	36.94	46.00	-9.06
365.80	H	Peak	16.38	18.88	35.26	46.00	-10.74

Remark :

- (1) Measuring frequencies from 30 MHz to the 1GHz ◦
- (2) Radiated emissions measured in frequency range from 30 MHz to 1000MHz were made with an instrument using Peak detector mode.
- (3) Datas of measurement within this frequency range shown “ - ” in the table above means the reading of emissions are attenuated more than 20dB below the permissible limits or the field strength is too small to be measured.
- (4) The IF bandwidth of SPA between 30MHz to 1GHz was 100KHz.

Radiated Spurious Emission Measurement Result (below 1GHz) – (Co-Location)

Operation Mode: WLAN (TX CH Low Mode) + Bluetooth (TX CH Mid Mode) Test Date: 04. 14, 2003
 Temperature: 20°C Test By: Jacky
 Humidity: 70 % Pol: Ver./Hor

Freq. (MHz)	Ant.Pol. H/V	Detector Mode (PK/QP)	Reading (dBuV)	Factor (dB)	Actual FS (dBuV/m)	Limit @ 3m (dBuV/m)	Margin (dB)
72.12	V	Peak	23.32	10.00	33.32	40.00	-6.68
84.54	V	Peak	21.18	10.68	31.86	40.00	-8.14
166.08	V	Peak	25.29	11.85	37.14	43.50	-6.36
261.12	V	Peak	20.79	16.04	36.83	46.00	-9.17
300.00	V	Peak	23.30	16.68	39.98	46.00	-6.02
326.60	V	Peak	19.33	17.40	36.73	46.00	-9.27
72.12	H	Peak	26.24	10.00	36.24	40.00	-3.76
84.54	H	Peak	23.57	10.68	34.25	40.00	-5.75
166.08	H	Peak	30.14	11.85	41.99	43.50	-1.51
233.58	H	Peak	20.85	15.66	36.51	46.00	-9.49
300.00	H	Peak	25.53	16.68	42.21	46.00	-3.79
336.40	H	Peak	18.59	17.66	36.25	46.00	-9.75

Remark :

- (1) Measuring frequencies from 30 MHz to the 1GHz ◦
- (2) Radiated emissions measured in frequency range from 30 MHz to 1000MHz were made with an instrument using Peak detector mode.
- (3) Datas of measurement within this frequency range shown “ - ” in the table above means the reading of emissions are attenuated more than 20dB below the permissible limits or the field strength is too small to be measured.
- (4) The IF bandwidth of SPA between 30MHz to 1GHz was 100KHz.

Radiated Spurious Emission Measurement Result (below 1GHz) – (Co-Location)

Operation Mode: WLAN (TX CH Low Mode) + Bluetooth (TX CH High Mode) Test Date: 04. 14, 2003
 Temperature: 20°C Test By: Jacky
 Humidity: 70 % Pol: Ver./Hor

Freq. (MHz)	Ant.Pol. H/V	Detector Mode (PK/QP)	Reading (dBuV)	Factor (dB)	Actual FS (dBuV/m)	Limit @3m (dBuV/m)	Margin (dB)
72.12	V	Peak	23.20	10.00	33.20	40.00	-6.80
84.54	V	Peak	21.32	10.68	32.00	40.00	-8.00
166.08	V	Peak	24.64	11.85	36.49	43.50	-7.01
261.12	V	Peak	21.01	16.04	37.05	46.00	-8.95
298.92	V	Peak	23.42	16.64	40.06	46.00	-5.94
326.60	V	Peak	19.41	17.40	36.81	46.00	-9.19
72.12	H	Peak	26.70	10.00	36.70	40.00	-3.30
110.46	H	Peak	21.07	12.79	33.86	43.50	-9.64
166.62	H	Peak	28.23	11.89	40.12	43.50	-3.38
233.58	H	Peak	19.63	15.66	35.29	46.00	-10.71
298.92	H	Peak	26.05	16.64	42.69	46.00	-3.31
336.40	H	Peak	18.62	17.66	36.28	46.00	-9.72

Remark :

- (1) Measuring frequencies from 30 MHz to the 1GHz °
- (2) Radiated emissions measured in frequency range from 30 MHz to 1000MHz were made with an instrument using Peak detector mode.
- (3) Datas of measurement within this frequency range shown “ - ” in the table above means the reading of emissions are attenuated more than 20dB below the permissible limits or the field strength is too small to be measured.
- (4) The IF bandwidth of SPA between 30MHz to 1GHz was 100KHz.

Radiated Spurious Emission Measurement Result (Above 1GHz) – (Co-Location)

Operation Mode: WLAN (TX CH Low Mode) + Bluetooth (TX CH Low Mode) Test Date: 04. 12, 2003
 Temperature: 20°C Test By: Jacky
 Humidity: 70 % Pol: Vertical

Freq. (MHz)	Peak	AV	Ant./CL CF(dB)	Actual FS		Peak	AV	Margin (dB)
	Reading (dBuV)	Reading (dBuV)		Peak (dBuV/m)	AV (dBuV/m)	Limit (dBuV/m)	Limit (dBuV/m)	
1064	53.10	---	-9.98	43.12	---	74.00	54.00	-10.88
1260	48.02	---	-8.80	39.22	---	74.00	54.00	-14.78
4804	--					74.00	54.00	
7206	--					74.00	54.00	
9608	--					74.00	54.00	
12010	--					74.00	54.00	
14412	--					74.00	54.00	
16814	--					74.00	54.00	
19216	--					74.00	54.00	
21618	--					74.00	54.00	
24020	--					74.00	54.00	

Remark :

- (1) Measuring frequencies from 1 GHz to the 10th harmonic of highest fundamental frequency ◦
- (2) Datas of measurement within this frequency range shown “ - ” in the table above means the reading of emissions are attenuated more than 20dB below the permissible limits or the field strength is too small to be measured.
- (3) Radiated emissions measured in frequency above 1000MHz were made with an instrument using Peak detector mode and average detector mode of the emission shown in Actual FS column ◦
- (4) Spectrum Peak Setting 1GHz- 26GHz, RBW= 1MHz, VBW= 1MHz, Sweep time= 200 ms.
Spectrum AV Setting 1GHz- 26GHz, RBW= 1MHz, VBW= 10Hz, Sweep time= 200 ms.

Radiated Spurious Emission Measurement Result (Above 1GHz) – (Co-Location)

Operation Mode: WLAN (TX CH Low Mode) + Test Date: 04. 12, 2003
 Bluetooth (TX CH Low Mode)
 Temperature: 20°C Test By: Jacky
 Humidity: 70 % Pol: Horizontal

Freq. (MHz)	Peak	AV	Ant./CL CF(dB)	Actual FS		Peak	AV	Margin (dB)
	Reading (dBuV)	Reading (dBuV)		Peak (dBuV/m)	AV (dBuV/m)	Limit (dBuV/m)	Limit (dBuV/m)	
1064	49.69	---	-9.98	39.71	---	74.00	54.00	-14.29
4804	--					74.00	54.00	
7206	--					74.00	54.00	
9608	--					74.00	54.00	
12010	--					74.00	54.00	
14412	--					74.00	54.00	
16814	--					74.00	54.00	
19216	--					74.00	54.00	
21618	--					74.00	54.00	
24020	--					74.00	54.00	

Remark :

- (1) Measuring frequencies from 1 GHz to the 10th harmonic of highest fundamental frequency °
- (2) Datas of measurement within this frequency range shown “ - ” in the table above means the reading of emissions are attenuated more than 20dB below the permissible limits or the field strength is too small to be measured.
- (3) Radiated emissions measured in frequency above 1000MHz were made with an instrument using Peak detector mode and average detector mode of the emission shown in Actual FS column °
- (4) Spectrum Peak Setting 1GHz- 26GHz, RBW= 1MHz, VBW= 1MHz, Sweep time= 200 ms.
Spectrum AV Setting 1GHz- 26GHz, RBW= 1MHz, VBW= 10Hz, Sweep time= 200 ms.

Radiated Spurious Emission Measurement Result (Above 1GHz) – (Co-Location)

Operation Mode: WLAN (TX CH Low Mode) + Test Date: 04. 12, 2003
 Bluetooth (TX CH Mid Mode)
 Temperature: 20°C Test By: Jacky
 Humidity: 70 % Pol: Vertical

Freq. (MHz)	Peak	AV	Ant./CL CF(dB)	Actual FS		Peak	AV	Margin (dB)
	Reading (dBuV)	Reading (dBuV)		Peak (dBuV/m)	AV (dBuV/m)	Limit (dBuV/m)	Limit (dBuV/m)	
1060	54.38	---	-10.01	44.37	---	74.00	54.00	-9.63
4882	--					74.00	54.00	
7323	--					74.00	54.00	
9764	--					74.00	54.00	
12205	--					74.00	54.00	
14646	--					74.00	54.00	
17087	--					74.00	54.00	
19528	--					74.00	54.00	
21969	--					74.00	54.00	
24410	--					74.00	54.00	

Remark :

- (1) Measuring frequencies from 1 GHz to the 10th harmonic of highest fundamental frequency °
- (2) Datas of measurement within this frequency range shown “ - ” in the table above means the reading of emissions are attenuated more than 20dB below the permissible limits or the field strength is too small to be measured.
- (3) Radiated emissions measured in frequency above 1000MHz were made with an instrument using Peak detector mode and average detector mode of the emission shown in Actual FS column °
- (4) Spectrum Peak Setting 1GHz- 26GHz, RBW= 1MHz, VBW= 1MHz, Sweep time= 200 ms.
Spectrum AV Setting 1GHz- 26GHz, RBW= 1MHz, VBW= 10Hz, Sweep time= 200 ms.

Radiated Spurious Emission Measurement Result (Above 1GHz) – (Co-Location)

Operation Mode: WLAN (TX CH Low Mode) + Bluetooth (TX CH Mid Mode) Test Date: 04. 12, 2003
 Temperature: 20°C Test By: Jacky
 Humidity: 70 % Pol: Horizontal

Freq. (MHz)	Peak	AV	Ant./CL CF(dB)	Actual FS		Peak	AV	Margin (dB)
	Reading (dBuV)	Reading (dBuV)		Peak (dBuV/m)	AV (dBuV/m)	Limit (dBuV/m)	Limit (dBuV/m)	
1064	50.42	---	-9.98	40.44	---	74.00	54.00	-13.56
4882	--					74.00	54.00	
7323	--					74.00	54.00	
9764	--					74.00	54.00	
12205	--					74.00	54.00	
14646	--					74.00	54.00	
17087	--					74.00	54.00	
19528	--					74.00	54.00	
21969	--					74.00	54.00	
24410	--					74.00	54.00	

Remark :

- (1) Measuring frequencies from 1 GHz to the 10th harmonic of highest fundamental frequency °
- (2) Datas of measurement within this frequency range shown “ - ” in the table above means the reading of emissions are attenuated more than 20dB below the permissible limits or the field strength is too small to be measured.
- (3) Radiated emissions measured in frequency above 1000MHz were made with an instrument using Peak detector mode and average detector mode of the emission shown in Actual FS column °
- (4) Spectrum Peak Setting 1GHz- 26GHz, RBW= 1MHz, VBW= 1MHz, Sweep time= 200 ms.
Spectrum AV Setting 1GHz- 26GHz, RBW= 1MHz, VBW= 10Hz, Sweep time= 200 ms.

Radiated Spurious Emission Measurement Result (Above 1GHz) – (Co-Location)

Operation Mode: WLAN (TX CH Low Mode) + Test Date: 04. 12, 2003
 Bluetooth (TX CH High Mode)
 Temperature: 20°C Test By: Jacky
 Humidity: 70 % Pol: Vertical

Freq. (MHz)	Peak	AV	Ant./CL CF(dB)	Actual FS		Peak	AV	Margin (dB)
	Reading (dBuV)	Reading (dBuV)		Peak (dBuV/m)	AV (dBuV/m)	Limit (dBuV/m)	Limit (dBuV/m)	
1060	53.78	---	-10.01	43.77	---	74.00	54.00	-10.23
4960	--					74.00	54.00	
7440	--					74.00	54.00	
9920	--					74.00	54.00	
12400	--					74.00	54.00	
14880	--					74.00	54.00	
17360	--					74.00	54.00	
19840	--					74.00	54.00	
22320	--					74.00	54.00	
24800	--					74.00	54.00	

Remark :

- (1) Measuring frequencies from 1 GHz to the 10th harmonic of highest fundamental frequency °
- (2) Datas of measurement within this frequency range shown “ - ” in the table above means the reading of emissions are attenuated more than 20dB below the permissible limits or the field strength is too small to be measured.
- (3) Radiated emissions measured in frequency above 1000MHz were made with an instrument using Peak detector mode and average detector mode of the emission shown in Actual FS column °
- (4) Spectrum Peak Setting 1GHz- 26GHz, RBW= 1MHz, VBW= 1MHz, Sweep time= 200 ms.
Spectrum AV Setting 1GHz- 26GHz, RBW= 1MHz, VBW= 10Hz, Sweep time= 200 ms.

Radiated Spurious Emission Measurement Result (Above 1GHz) – (Co-Location)

Operation Mode: WLAN (TX CH Low Mode) + Test Date: 04. 12, 2003
 Bluetooth (TX CH High Mode)
 Temperature: 20°C Test By: Jacky
 Humidity: 70 % Pol: Horizontal

Freq. (MHz)	Peak	AV	Ant./CL CF(dB)	Actual FS		Peak	AV	Margin (dB)
	Reading (dBuV)	Reading (dBuV)		Peak (dBuV/m)	AV (dBuV/m)	Limit (dBuV/m)	Limit (dBuV/m)	
1060	50.63	---	-10.01	40.62	---	74.00	54.00	-13.38
4960	--					74.00	54.00	
7440	--					74.00	54.00	
9920	--					74.00	54.00	
12400	--					74.00	54.00	
14880	--					74.00	54.00	
17360	--					74.00	54.00	
19840	--					74.00	54.00	
22320	--					74.00	54.00	
24800	--					74.00	54.00	

Remark :

- (1) Measuring frequencies from 1 GHz to the 10th harmonic of highest fundamental frequency °
- (2) Datas of measurement within this frequency range shown “ - ” in the table above means the reading of emissions are attenuated more than 20dB below the permissible limits or the field strength is too small to be measured.
- (3) Radiated emissions measured in frequency above 1000MHz were made with an instrument using Peak detector mode and average detector mode of the emission shown in Actual FS column °
- (4) Spectrum Peak Setting 1GHz- 26GHz, RBW= 1MHz, VBW= 1MHz, Sweep time= 200 ms.
Spectrum AV Setting 1GHz- 26GHz, RBW= 1MHz, VBW= 10Hz, Sweep time= 200 ms.

6. AC POWER LINE CONDUCTED EMISSION TEST

6.1. Standard Applicable

According to § 15.207. frequency within 150KHz to 30MHz shall not exceed

Frequency range MHz	Limits dB(uV)	
	Quasi-peak	Average
0.15 to 0.50	66 to 56	56 to 46
0.50 to 5	56	46
5 to 30	60	50

Note

- 1.The lower limit shall apply at the transition frequencies
- 2.The limit decreases linearly with the logarithm of the frequency in the range 0.15 MHz to 0.50 MHz.

6.2. EUT Setup

1. The conducted emission tests were performed in the test site, using the setup in accordance with the ANSI C63.4-1992.
2. The EUT was plug-in the host PC via USB port. The host PC system was placed on the center of the back edge on the test table. The peripherals like modem, monitor printer, K/B, and mouse were placed on the side of the host PC system. The rear of the EUT and peripherals were placed flushed with the rear of the tabletop.
3. The keyboard was placed directly in the front of the monitor, flushed with the front tabletop. The mouse was placed next to the Keyboard, flushed with the back of keyboard.
4. The spacing between the peripherals was 10 centimeters.
5. External I/O cables were draped along the edge of the test table and bundle when necessary.
6. The host PC system was connected with 110Vac/60Hz power source.

6.3. Measurement Procedure

1. The EUT was placed on a table which is 0.8m above ground plane.
2. Maximum procedure was performed on the six highest emissions to ensure EUT compliance.
3. Repeat above procedures until all frequency measured were complete.

6.4. Measurement Equipment Used:

Conducted Emission Test Site # 3					
EQUIPMENT TYPE	MFR	Model No.	Serial No.	LAST CAL.	Cal. Due.
EMI Test Receiver	R&S	ESCS30	847793/012	12/21/2002	12/20/2003
LISN	R&S	ESH2-Z5	843285/010	12/16/2002	12/15/2003
LISN	EMCO	3825/2	9003-1628	07/26/2002	07/25/2003
Spectrum Analyzer	ADVANTEST	R3261A	91720031	N/A	N/A
2X2 WIRE ISN	R&S	ENY22	100020	06/20/2002	06/19/2003
FOUR WIRE ISN	R&S	ENY41	100006	06/20/2002	06/19/2003

6.5. Measurement Result

The initial step in collecting conducted data is a spectrum analyzer peak scan of the measurement range. Significant peaks are then marked as shown on the following data page, and these signals are then quasi-peaked.

AC POWER LINE CONDUCTED EMISSION TEST

Operation Mode:	TX + RX Mode			Test Date :	Apr. 11, 2003
Temperature :	22 °C	Humidity :	70%	Test By:	Devin

FREQ MHz	P.K. Raw dBuV	Q.P. Raw dBuV	AVG Raw dBuV	Q.P. Limit dBuV	AVG Limit dBuV	Q.P. Margin dB	AVG Margin dB	NOTE
0.159	65.60	52.10	30.40	65.52	55.52	-13.42	-25.12	L1
0.247	60.00	44.30	22.60	61.86	51.86	-17.56	-29.26	L1
0.377	51.00	36.70	17.40	58.35	48.35	-21.65	-30.95	L1
0.451	47.40	32.20	13.10	56.86	46.86	-24.66	-33.76	L1
0.511	41.20	---	---	56.00	46.00	---	---	L1
0.613	41.40	---	---	56.00	46.00	---	---	L1
0.157	65.60	54.10	31.80	65.62	55.62	-11.52	-23.82	L2
0.270	56.20	44.80	23.10	61.12	51.12	-16.32	-28.02	L2
0.354	50.20	38.60	16.40	58.87	48.87	-20.27	-32.47	L2
0.412	46.80	34.70	15.10	57.61	47.61	-22.91	-32.51	L2
0.490	44.20	---	---	56.17	46.17	---	---	L2
0.576	38.00	---	---	56.00	46.00	---	---	L2

Remark :

- (1) Measuring frequencies from 0.15 MHz to 30MHz ◦
The emissions measured in frequency range from 0.15 MHz to 30MHz were made with an instrument using Qusia-Peak detector and Average detector.
- (2) “---” denotes the emission level was or more than 2dB below the Average limit,
- (3) so no re-check anymore.
The IF bandwidth of SPA between 0.15MHz to 30MHz was 10KHz;
- (4) The IF bandwidth of Test Receiver between 0.15MHz to 30MHz was 9KHz;
- (5) L1 = Line One (Hot side) / L2 = Line Two (Neutral side)



Conducted Test Data

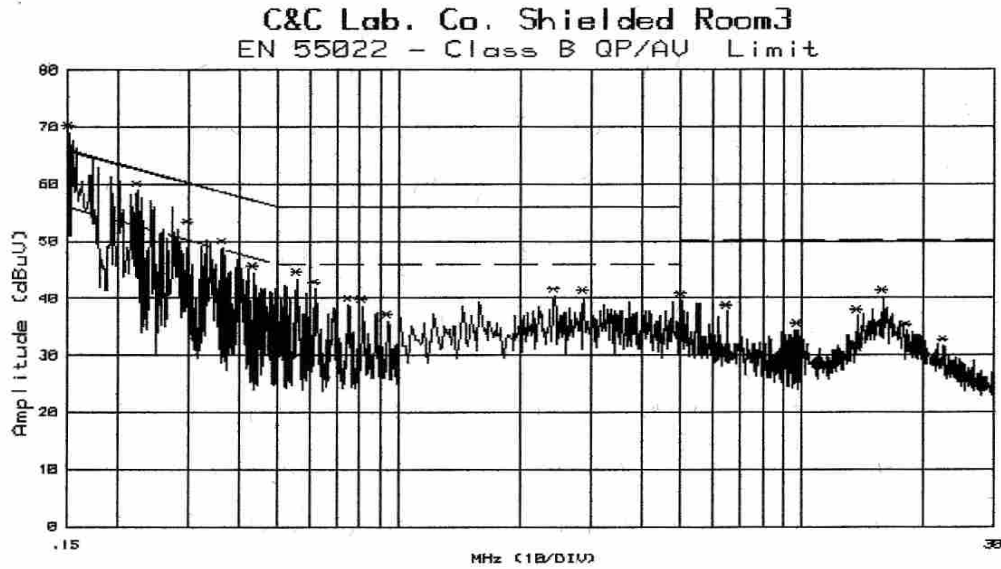

Customer:QUENTA	File#: 2339	Date :11 Apr 2003 22:25:15
Model :W	Humd.:70 (%)	Temp. :22 (C)
Mode :	Port :L1	Tested by:ROBIN
Reading :Peak(R3261C SPA)		
Remark :110V		

LINE 2

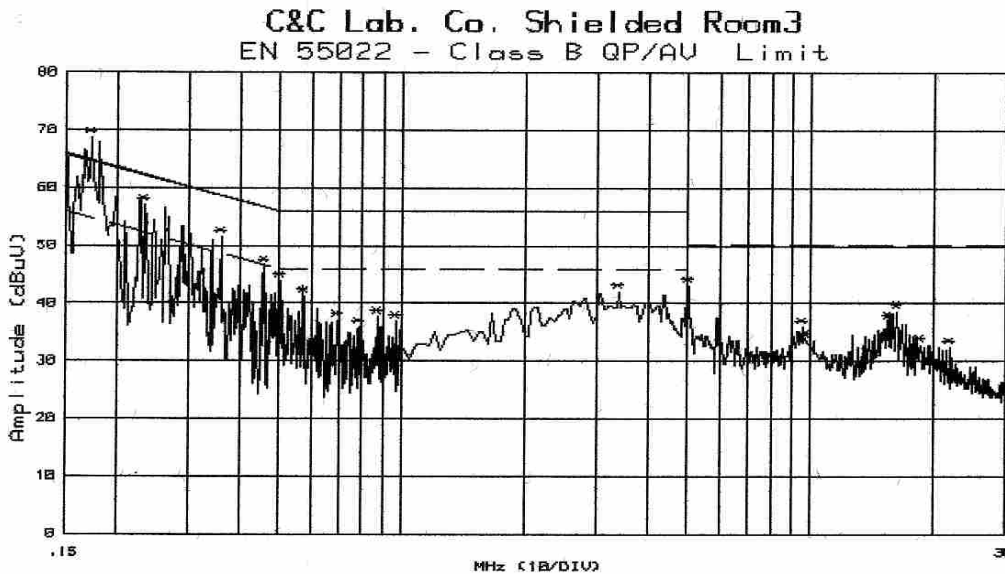

Customer:QUENTA	File#: 2340	Date :11 Apr 2003 22:38:56
Model :W	Humd.:70 (%)	Temp. :22 (C)
Mode :	Port :L2	Tested by:ROBIN
Reading :Peak(R3261C SPA)		
Remark :110V		

7. 6 dB Bandwidth Measurement

7.1 Standard Applicable

According to § 15.247(a)(2), DSSS Systems operating in the 2400MHz-2483.5MHz and 5725MHz – 5850MHz bands. The Minimum 6dB bandwidth shall be at least 500KHz.

7.2 Measurement Equipment Used:

EQUIPMENT TYPE	MFR	Model No.	Serial No.	LAST CAL.	Cal. Due.
Spectrum Analyzer	Advantest	R3182	110600647	11/16/2002	11/15/2003
Spectrum Analyzer	R&S	FSP30	1093.4495.30	07/23/2002	07/22/2003
low loss cable	Huber + Suhner	Sucoflex 104	N/A	N/A	N/A

7.3 Test Setup:

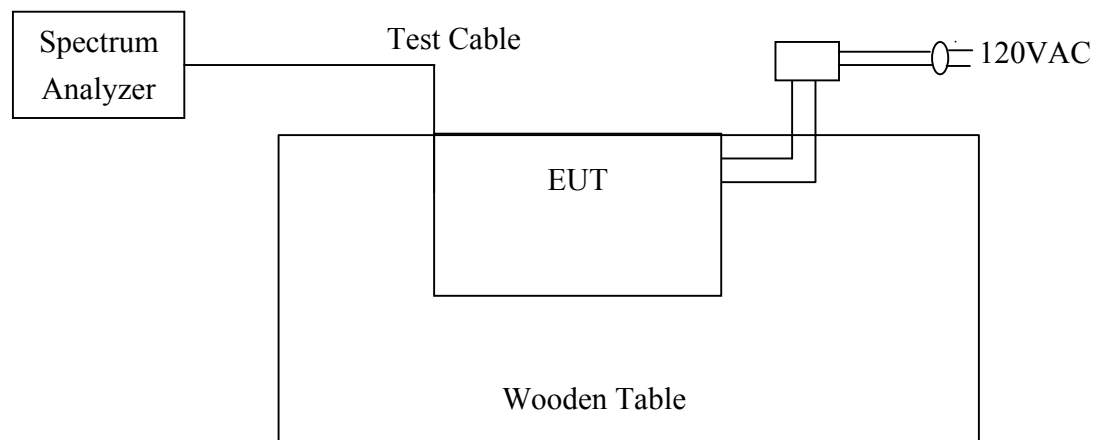

Fig. 4

Fig. 4 : Measurement setup for testing on Antenna connector



7.4 Measurement Procedure

1. Place the EUT on the table and set it in transmitting mode.
2. Remove the antenna from the EUT and then connect a low loss RF cable from the antenna port to the spectrum analyzer.
3. Set the spectrum analyzer as RBW=100KHz, VBW = RBW, Span= 20MHz, Sweep=auto
4. Mark the peak frequency and -6dB (upper and lower) frequency.
5. Repeat above procedures until all frequency measured were complete.

7.5 Measurement Result

Channel	Bandwidth(MHz)	Bandwidth (KHz)	Result
Low	12.92	> 500	PASS
Mid	12.92	> 500	PASS
High	12.92	> 500	PASS

6dB Band Width Test Data CH-LOW

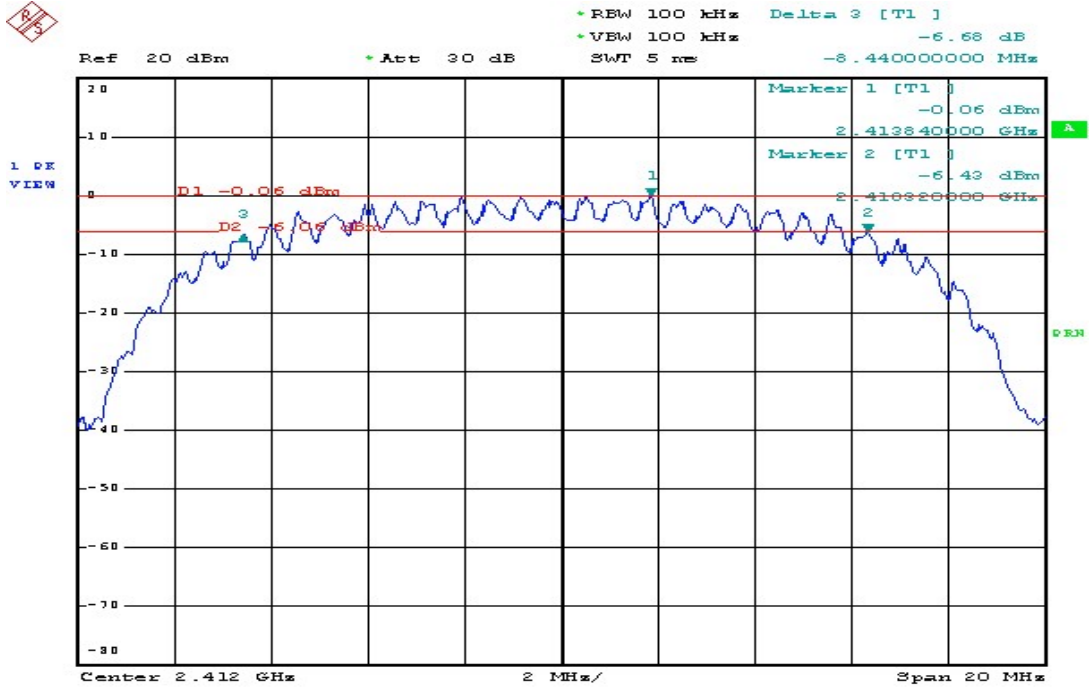

Date: 10.APR.2003 09:59:38

6dB Band Width Test Data CH-MID

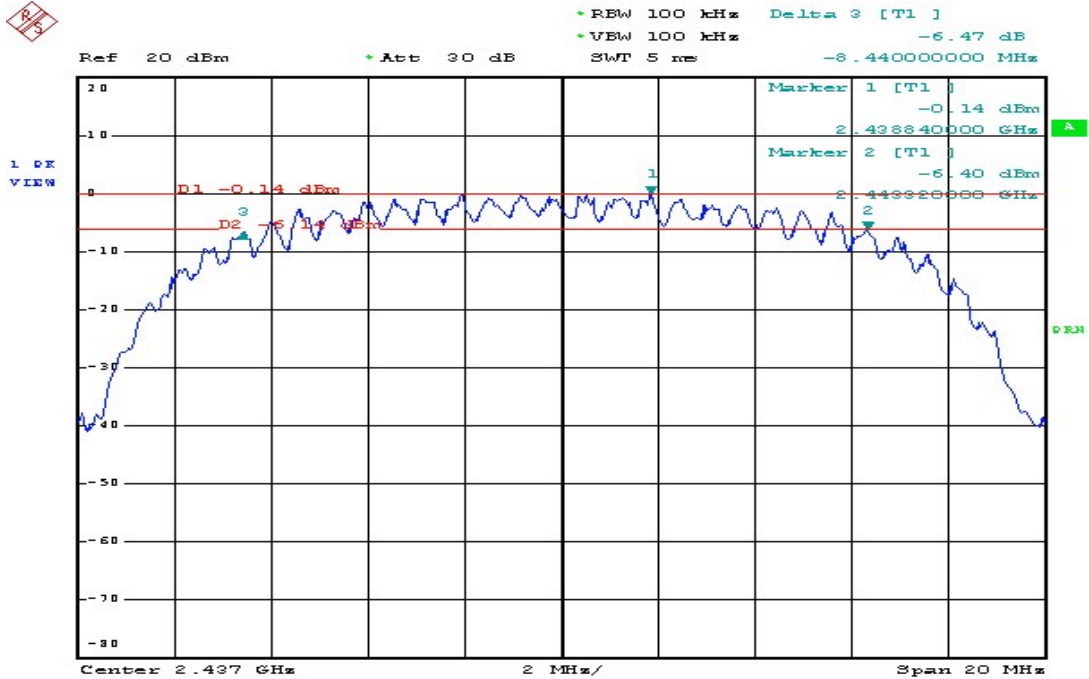

Date: 10.APR.2003 09:57:29

6dB Band Width Test Data CH-HIGH

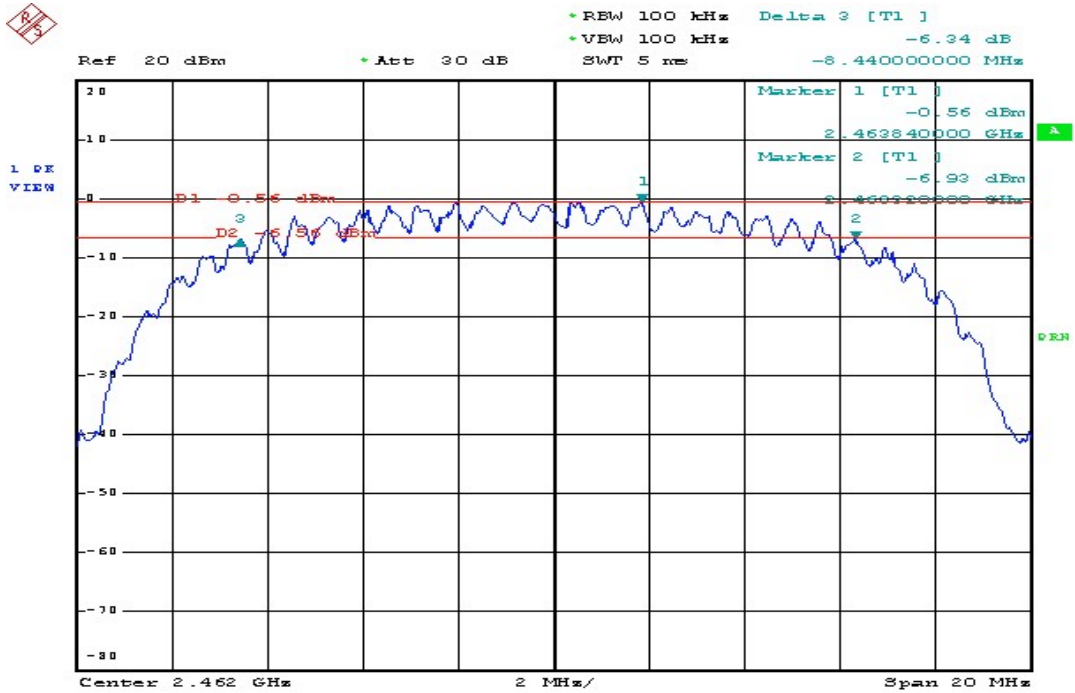

Date: 10.APR.2003 10:02:39

8. PEAK OUTPUT POWER MEASUREMENT

8.1 Standard Applicable

According to § 15.247(b)(2), for direct sequence systems, the maximum peak output power of the intentional radiator shall not exceed 1 Watt.

8.2 Test Setup

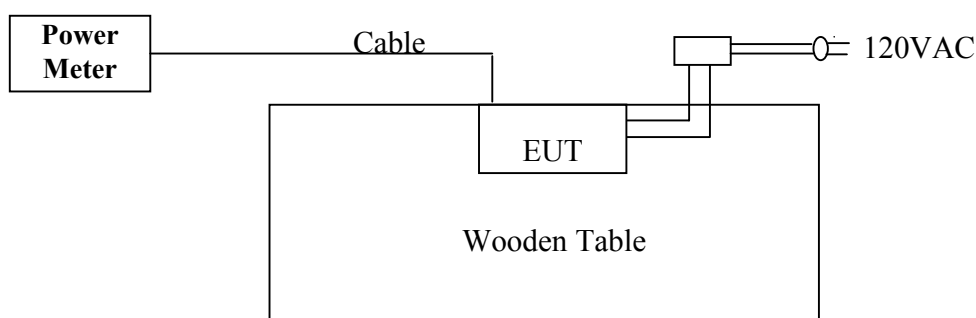

8.3 Measurement Equipment Used:

EQUIPMENT TYPE	MFR	Model No.	Serial No.	LAST CAL.	Cal. Due.
RF Power Meter	BOONTON	4531	130601	01/11/2003	01/10/2004
Power Sensor	Agilent	8481A	2702A61366	3/16/2003	3/15/2004
low loss cable	Huber + Suhner	Sucoflex 104	N/A	N/A	N/A

8.4 Test Results:

Antenna Port	Channel	Reading Power (dBm)	Cable Loss (dB)	Output Power (dBm)	Output Power (W)	Limit (W)	Result
J5	Low	12.91	1.40	14.31	0.02698	1	PASS
	Mid	12.89	1.40	14.29	0.02685	1	PASS
	High	12.55	1.40	13.95	0.02483	1	PASS
J6	Low	11.83	1.40	13.23	0.02104	1	PASS
	Mid	11.80	1.40	13.20	0.02089	1	PASS
	High	11.55	1.40	12.95	0.01972	1	PASS

9. 100KHz BANDWIDTH OF BAND EDGES MEASUREMENT

9.1 Standard Applicable

According to § 15.247(c), in any 100 KHz bandwidth outside the frequency bands in which the spread spectrum intentional radiator is operating, the radio frequency power that is produced by the intentional radiator shall be at least 20dB below that in the 100KHz bandwidth within the band that contains the highest level of the desired power, In addition, radiated emissions which fall in the restricted bands, as defined in § 15.205(a), must also comply with the radiated emission limits specified in 15.209(a).

9.2 Measurement Procedure

1. Place the EUT on the table and set it in transmitting mode.
2. Remove the antenna from the EUT and then connect a low loss RF cable from the antenna port to the spectrum analyzer.
3. Set center frequency of spectrum analyzer = operating frequency.
4. Set the spectrum analyzer as RBW, VBW=100KHz, Center Freq. 2.39GHz, 2.4835GHz, Span=100MHz, Sweep = auto.
5. Mark Peak ,2.4GHz and 2.4835GHz and record the max. level.
6. Repeat above procedures until all frequency measured were complete.

9.3 Measurement Result

Refer to attach spectrum analyzer data chart.

9.4 Measurement Equipment Used:

EQUIPMENT TYPE	MFR	Model No.	Serial No.	LAST CAL.	Cal. Due.
Spectrum Analyzer	Advantest	R3182	110600647	11/16/2002	11/15/2003
Spectrum Analyzer	R&S	FSP30	1093.4495.30	07/23/2002	07/22/2003
low loss cable	Huber + Suhner	Sucoflex 104	N/A	N/A	N/A

Out of Band Test Data CH-LOW

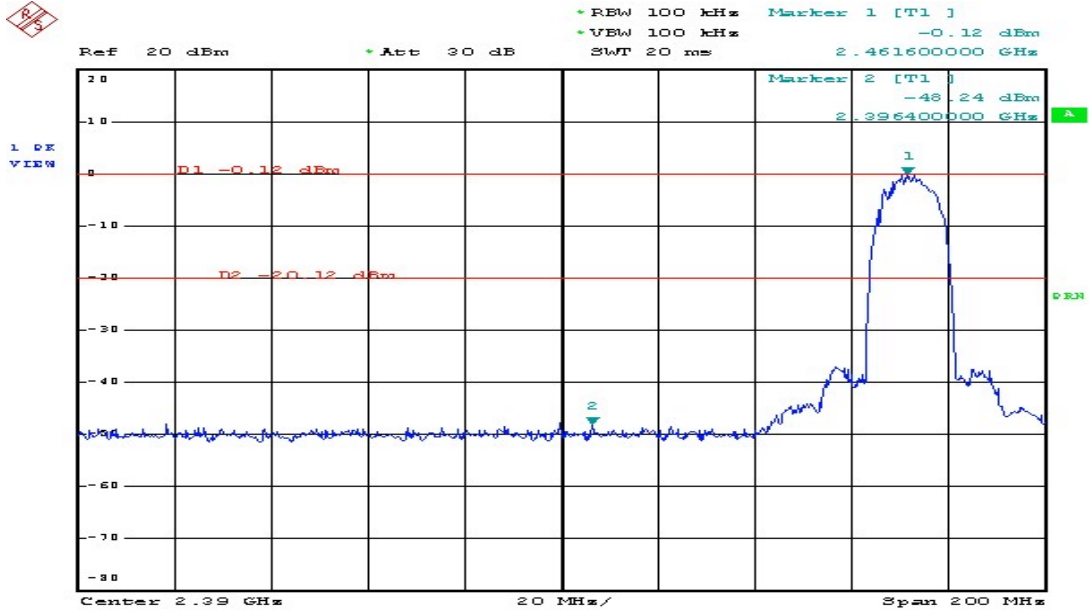

Date: 10.APR.2003 10:25:44

Out of Band Test Data CH-HIGH

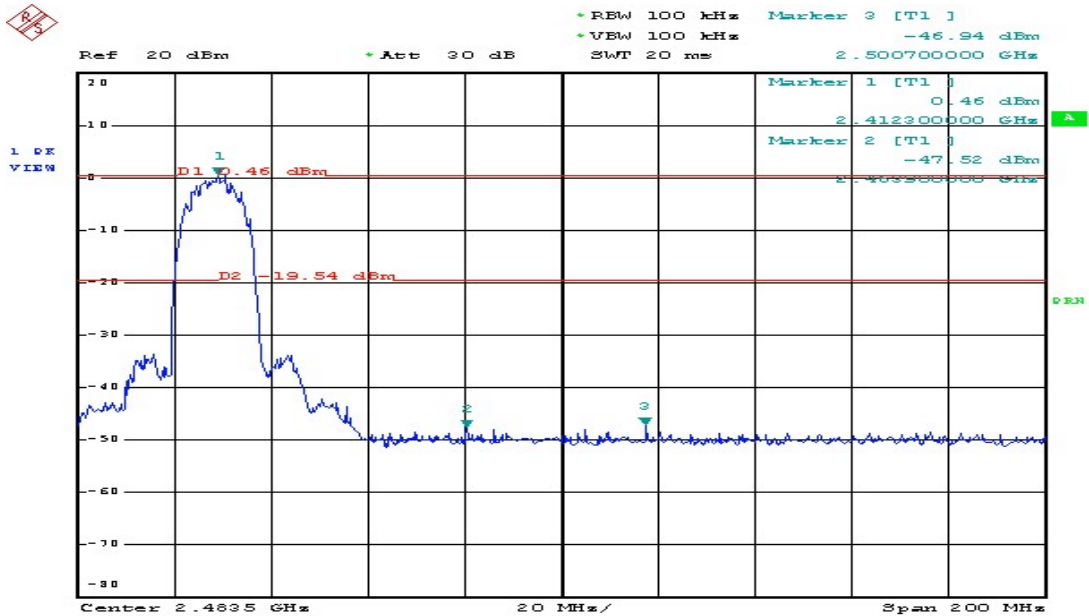

Date: 10.APR.2003 10:23:25

10. Peak Power Spectral Density

10.1 Standard Applicable

According to § 15.247(d), for direct sequence systems, the peak power spectral density conducted from the intentional radiator to the antenna shall not be greater than 8 dBm in any 3kHz band during any time interval of continuous transmission.

10.2 Measurement Procedure

1. Place the EUT on the table and set it in transmitting mode.
2. Remove the antenna from the EUT and then connect a low loss RF cable from the antenna port to the spectrum analyzer.
3. Set the spectrum analyzer as RBW = 3KHz, VBW = 3KHz, Span = 300KHz, Sweep=100s
4. Record the max. reading.
5. Repeat above procedures until all frequency measured were complete.

10.3 Measurement Result

CHANNE L	Reading dBm	Cable Loss dB	Density dBm	Limint dBm	Result
Low	-8.17	1.40	-6.77	8	PASS
Mid	-8.17	1.40	-6.77	8	PASS
High	-8.69	1.40	-7.29	8	PASS

10.4 Measurement Equipment Used:

EQUIPMENT TYPE	MFR	Model No.	Serial No.	LAST CAL.	Cal. Due.
Spectrum Analyzer	Advantest	R3182	110600647	11/16/2002	11/15/2003
Spectrum Analyzer	R&S	FSP30	1093.4495.30	07/23/2002	07/22/2003
low loss cable	Huber + Suhner	Sucoflex 104	N/A	N/A	N/A

Power Density Test Data CH-LOW

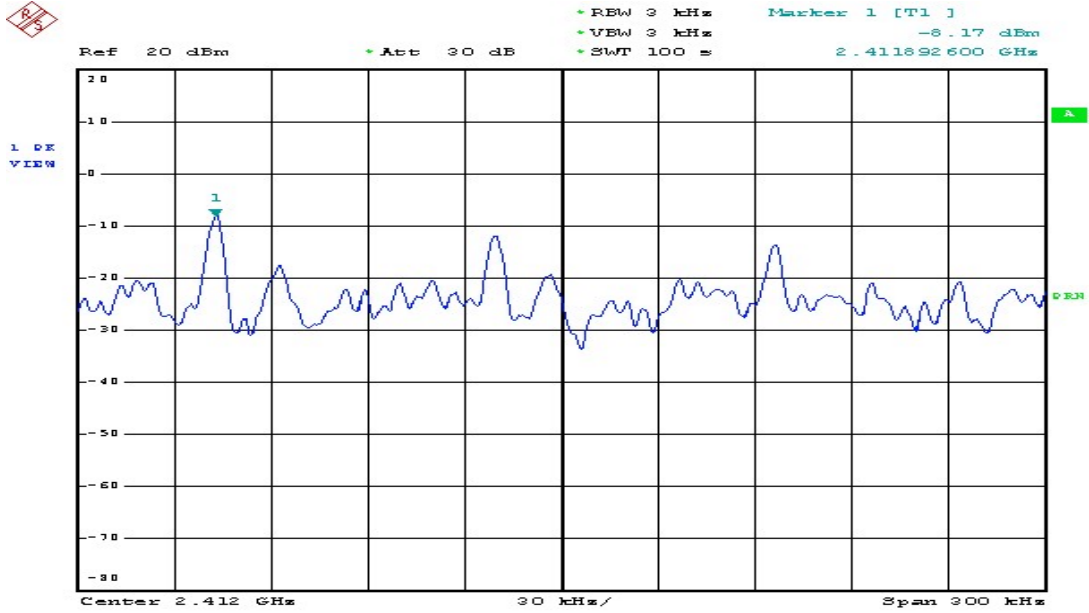

Date: 10.APR.2003 10:20:06

Power Density Test Data CH-MID

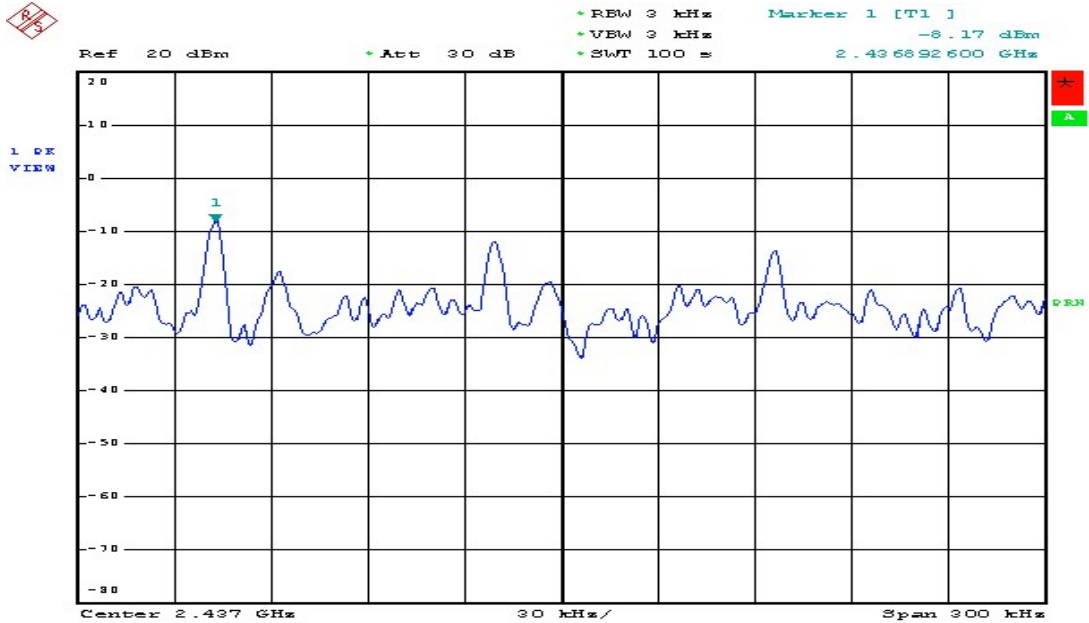

Date: 10.APR.2003 10:10:57



Power Density Test Data CH-HIGH

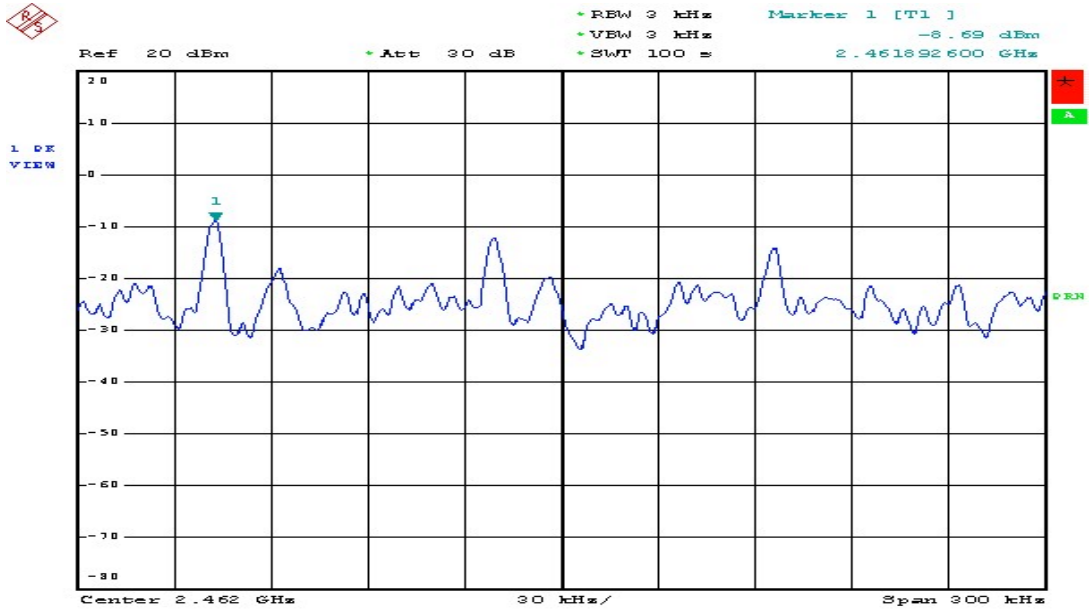

Date: 10.APR.2003 10:08:35

11. ANTENNA REQUIREMENT

11.1 Standard Applicable

For intentional device, according to § 15.203, an intentional radiator shall be designed to ensure that no antenna other than furnished by the responsible party shall be used with the device.

And according to § 15.247(4)(i), if transmitting antennas of directional gain greater than 6dBi are used the power shall be reduced by the amount in 1dB that the directional gain of the antenna exceeds 6 dBi.

11.2 Antenna Connected Construction

The directional gain of antenna used for transmitting is -0.16 dBi, and the user designs the antenna connector with permanent attachment and no consideration of replacement. Please see EUT photo for details.



12. RF Exposure

12.1 Standard Applicable

According to § 15.247(b)(4) and § 1.1307(b)(1), systems operating under the provisions of this section shall be operated in a manner that ensure that the public is not exposed to radio frequency energy level in excess of the Commission's guideline.

This device is classed as a Portable Device.

12.2 Measurement Result:

Co-Location and WLAN Mode:
Refer to SAR test report.