



# FCC TEST REPORT (FOR WIRELESS LAN)

**REPORT NO.:** RF971016L14

**MODEL NO.:** QV1

**RECEIVED:** Oct. 16, 2008

**TESTED:** Nov. 04 ~ Nov. 13, 2008

**ISSUED:** Nov. 18, 2008

**APPLICANT:** QUANTA COMPUTER INC.

**ADDRESS:** No.188,Wen Hwa 2nd Road,Kuei Shan Hsiang  
Taoyuan Hsien, 333 Taiwan ,R.O.C.

**ISSUED BY:** Advance Data Technology Corporation

**LAB ADDRESS:** No. 47, 14th Ling, Chia Pau Tsuen, Lin Kou  
Hsiang, Taipei Hsien 244, Taiwan, R.O.C.

**TEST LOCATION:** No. 19, Hwa Ya 2nd Rd, Wen Hwa Tsuen, Kwei  
Shan Hsiang, Taoyuan Hsien 333, Taiwan, R.O.C.

This test report consists of 64 pages in total. It may be duplicated completely for legal use with the approval of the applicant. It should not be reproduced except in full, without the written approval of our laboratory. The client should not use it to claim product endorsement by TAF or any government agencies. The test results in the report only apply to the tested sample.





## TABLE OF CONTENTS

1.	CERTIFICATION.....	4
2.	SUMMARY OF TEST RESULTS .....	5
2.1	MEASUREMENT UNCERTAINTY .....	5
3.	GENERAL INFORMATION.....	6
3.1	GENERAL DESCRIPTION OF EUT.....	6
3.2	DESCRIPTION OF TEST MODES.....	8
3.2.1	CONFIGURATION OF SYSTEM UNDER TEST.....	9
3.2.2	TEST MODE APPLICABILITY AND TESTED CHANNEL DETAIL.....	10
3.3.3	GENERAL DESCRIPTION OF APPLIED STANDARDS.....	12
3.3.4	DESCRIPTION OF SUPPORT UNITS.....	12
4.	TEST TYPES AND RESULTS .....	13
4.1	RADIATED EMISSION MEASUREMENT .....	13
4.1.1	LIMITS OF RADIATED EMISSION MEASUREMENT.....	13
4.1.2	TEST INSTRUMENTS .....	14
4.1.3	TEST PROCEDURES .....	15
4.1.4	DEVIATION FROM TEST STANDARD .....	15
4.1.5	TEST SETUP .....	16
4.1.6	EUT OPERATING CONDITIONS.....	16
4.1.7	TEST RESULTS .....	17
4.2	CONDUCTED EMISSION MEASUREMENT .....	27
4.2.1	LIMITS OF CONDUCTED EMISSION MEASUREMENT.....	27
4.2.2	TEST INSTRUMENTS .....	27
4.2.3	TEST PROCEDURES .....	28
4.2.4	DEVIATION FROM TEST STANDARD .....	28
4.2.5	TEST SETUP .....	29
4.2.6	EUT OPERATING CONDITIONS.....	29
4.2.7	TEST RESULTS .....	30
4.3	6dB BANDWIDTH MEASUREMENT .....	38
4.3.1	LIMITS OF 6dB BANDWIDTH MEASUREMENT.....	38
4.3.2	TEST INSTRUMENTS .....	38
4.3.3	TEST PROCEDURE .....	38
4.3.4	DEVIATION FROM TEST STANDARD .....	38
4.3.5	TEST SETUP .....	39
4.3.6	EUT OPERATING CONDITIONS.....	39
4.3.7	TEST RESULTS .....	40



4.4	MAXIMUM PEAK OUTPUT POWER .....	44
4.4.1	LIMITS OF MAXIMUM PEAK OUTPUT POWER MEASUREMENT .....	44
4.4.2	TEST INSTRUMENTS .....	44
4.4.3	TEST PROCEDURES .....	44
4.4.4	DEVIATION FROM TEST STANDARD .....	44
4.4.5	TEST SETUP .....	44
4.4.6	EUT OPERATING CONDITIONS .....	44
4.4.7	TEST RESULTS .....	45
4.5	POWER SPECTRAL DENSITY MEASUREMENT .....	46
4.5.1	LIMITS OF POWER SPECTRAL DENSITY MEASUREMENT .....	46
4.5.2	TEST INSTRUMENTS .....	46
4.5.3	TEST PROCEDURE .....	46
4.5.4	DEVIATION FROM TEST STANDARD .....	46
4.5.5	TEST SETUP .....	47
4.5.6	EUT OPERATING CONDITION .....	47
4.5.7	TEST RESULTS .....	48
4.6	BAND EDGES MEASUREMENT .....	52
4.6.1	LIMITS OF BAND EDGES MEASUREMENT .....	52
4.6.2	TEST INSTRUMENTS .....	52
4.6.3	TEST PROCEDURE .....	52
4.6.4	DEVIATION FROM TEST STANDARD .....	52
4.6.5	EUT OPERATING CONDITION .....	52
4.6.6	TEST RESULTS .....	53
4.7	ANTENNA REQUIREMENT .....	61
4.7.1	STANDARD APPLICABLE .....	61
4.7.2	ANTENNA CONNECTED CONSTRUCTION .....	61
5.	PHOTOGRAPHS OF THE TEST CONFIGURATION .....	62
6.	INFORMATION ON THE TESTING LABORATORIES .....	63
7.	APPENDIX A - MODIFICATIONS RECORDERS FOR ENGINEERING CHANGES TO THE EUT BY THE LAB .....	64



# 1. CERTIFICATION

**PRODUCT:** MID

**BRAND:** QUANTA

**MODEL:** QV1

**APPLICANT:** QUANTA COMPUTER INC.

**TESTED:** Nov. 04 ~ Nov. 13, 2008

**TEST SAMPLE:** ENGINEERING SAMPLE

**STANDARDS: FCC Part 15, Subpart C (Section 15.247)**

ANSI C63.4-2003

The above equipment (model: QV1) has been tested by **Advance Data Technology Corporation**, and found compliance with the requirement of the above standards. The test record, data evaluation & Equipment Under Test (EUT) configurations represented herein are true and accurate accounts of the measurements of the sample's EMC characteristics under the conditions specified in this report.

**PREPARED BY** :  Ivy Lin  , **DATE:**  Nov. 18, 2008   
Ivy Lin / Specialist

**TECHNICAL ACCEPTANCE** :  Long Chen  , **DATE:**  Nov. 18, 2008   
Responsible for RF Long Chen / Senior Engineer

**APPROVED BY** :  Gary Chang  , **DATE:**  Nov. 18, 2008   
Gary Chang / Assistant Manager

## 2. SUMMARY OF TEST RESULTS

The EUT has been tested according to the following specifications:

APPLIED STANDARD: FCC Part 15, Subpart C			
STANDARD SECTION	TEST TYPE AND LIMIT	RESULT	REMARK
15.207	AC Power Conducted Emission	PASS	Meet the requirement of limit. Minimum passing margin is -16.53dB at 0.720MHz.
15.247(a)(2)	Spectrum Bandwidth of a Direct Sequence Spread Spectrum System Limit: min. 500kHz	PASS	Meet the requirement of limit
15.247(b)	Maximum Peak Output Power Limit: max. 30dBm	PASS	Meet the requirement of limit
15.247(d)	Radiated Emissions Limit: Table 15.209	PASS	Meet the requirement of limit. Minimum passing margin is -1.88dB at 119.34MHz.
15.247(e)	Power Spectral Density Limit: max. 8dBm	PASS	Meet the requirement of limit
15.247(d)	Band Edge Measurement Limit: 20dB less than the peak value of fundamental frequency	PASS	Meet the requirement of limit

### 2.1 MEASUREMENT UNCERTAINTY

Where relevant, the following measurement uncertainty levels have been estimated for tests performed on the EUT as specified in CISPR 16-4-2:

MEASUREMENT	FREQUENCY	UNCERTAINTY
Conducted emissions	9kHz ~ 30MHz	2.44 dB
Radiated emissions	30MHz ~ 200MHz	3.34 dB
	200MHz ~ 1000MHz	3.35 dB
	1GHz ~ 18GHz	2.26 dB
	18GHz ~ 40GHz	1.94 dB

This uncertainty represents an expanded uncertainty expressed at approximately the 95% confidence level using a coverage factor of k=2.

### 3. GENERAL INFORMATION

#### 3.1 GENERAL DESCRIPTION OF EUT

<b>EUT</b>	MID
<b>MODEL NO.</b>	QV1
<b>FCC ID</b>	HFSTEEPCQVX
<b>POWER SUPPLY</b>	3.6Vdc from battery or 5.0Vdc from AC adapter
<b>MODULATION TYPE</b>	Wireless LAN: CCK, DQPSK, DBPSK for DSSS 64QAM, 16QAM, QPSK, BPSK for OFDM Bluetooth: GFSK, $\pi/4$ -DQPSK, 8DPSK
<b>MODULATION TECHNOLOGY</b>	DSSS, OFDM, FHSS
<b>TRANSFER RATE</b>	Wireless LAN: 802.11b:11/5.5/2/1Mbps 802.11g: 54/48/36/24/18/12/9/6Mbps Bluetooth: 1/2/3Mbps
<b>FREQUENCY RANGE</b>	2400 ~ 2483.5MHz
<b>NUMBER OF CHANNEL</b>	Wireless LAN: 11 Bluetooth: 79
<b>CHANNEL SPACING</b>	Wireless LAN: 5MHz Bluetooth: 1MHz
<b>OUTPUT POWER</b>	Wireless LAN: 80.910mW Bluetooth: 1.033mW
<b>ANTENNA TYPE</b>	PIFA antenna with -0.95dBi gain (For WLAN & Bluetooth)
<b>DATA CABLE</b>	NA
<b>I/O PORTS</b>	Refer to user's manual
<b>ACCESSORY DEVICES</b>	Battery, Adapter, Docking (Brand: QUANTA; Model: QV2)

**NOTE:**

1. The EUT is a TEE PC. The functions of EUT listed as below:

	TEST STANDARD	REFERENCE REPORT
WLAN 802.11b/g	FCC Part 15	RF971016L14
BLUETOOTH		RF971016L14-1

2. The EUT was powered by the following adapters and lithium battery.

Adapter 1	
Brand	Formosa
Model	Au-79D0u
Input power	100-240Vac, 50-60Hz, 0.5A
Output power	5.0Vdc, 3.0A
Power line	1.8 m non-shielded cable with 1 core

Adapter 2	
Brand	DVE
Model	DSA-15P-05 US 050125
Input power	100-240Vac, 50-60Hz, 0.5A
Output power	5.0Vdc, 2.5A
Power line	1.2 m non-shielded cable with 1 core

Lithium Battery	
Brand	SMP Tech. Co., Ltd.
Model	Quanta-QV1 1S2P
Power rating	3.6Vdc, 1500mA

3. The above EUT information was declared by the manufacturer and for more detailed features description, please refer to the manufacturer's specifications or User's Manual.

### 3.2 DESCRIPTION OF TEST MODES

11 channels are provided to the EUT:

CHANNEL	FREQUENCY	CHANNEL	FREQUENCY
1	2412 MHz	7	2442 MHz
2	2417 MHz	8	2447 MHz
3	2422 MHz	9	2452 MHz
4	2427 MHz	10	2457 MHz
5	2432 MHz	11	2462 MHz
6	2437 MHz		



### 3.2.1 CONFIGURATION OF SYSTEM UNDER TEST

#### Without docking test mode

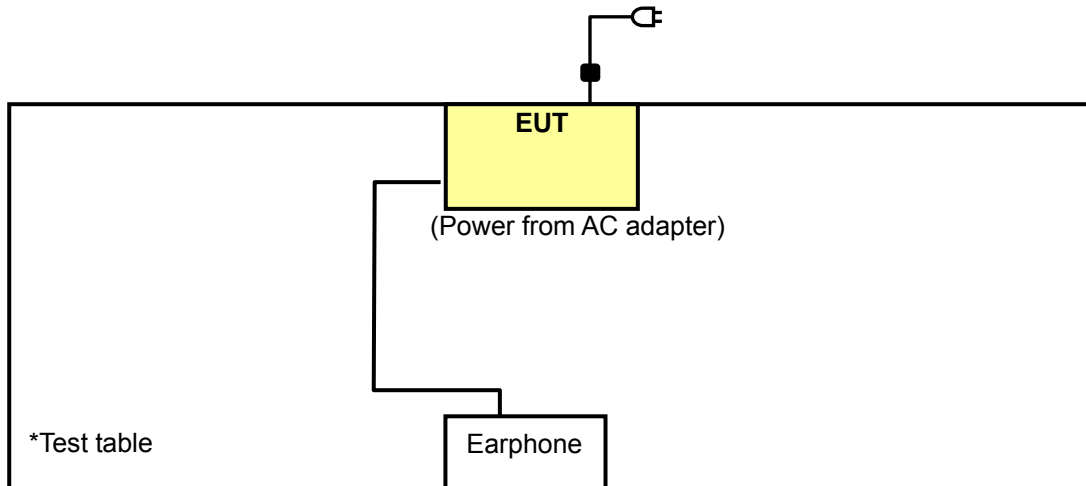

#### With docking test mode

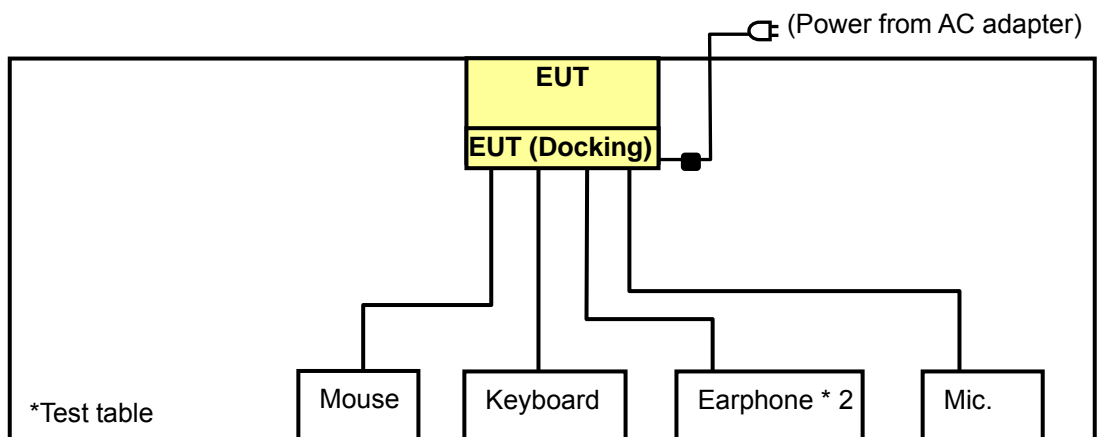

### 3.2.2 TEST MODE APPLICABILITY AND TESTED CHANNEL DETAIL

EUT CONFIGURE MODE	APPLICABLE TO				DESCRIPTION
	RE $\geq$ 1G	RE $<$ 1G	PLC	APCM	
A	-	√	√	-	Without docking, power from Adapter 1
B	√	√	√	√	Without docking, power from Adapter 2
C	-	√	√	-	With docking, power from Adapter 1
D	-	√	√	-	With docking, power from Adapter 2

Where **PLC**: Power Line Conducted Emission                      **RE $<$ 1G**: Radiated Emission below 1GHz  
**RE $\geq$ 1G**: Radiated Emission above 1GHz                      **APCM**: Antenna Port Conducted Measurement

**NOTE**: “-“ means no effect.

#### **RADIATED EMISSION TEST (ABOVE 1 GHz):**

- Pre-Scan has been conducted to determine the worst-case mode from all possible combinations between available modulations, data rates, XYZ axis and antenna ports (if EUT with antenna diversity architecture).
- Following channel(s) was (were) selected for the final test as listed below.

EUT CONFIGURE MODE	MODE	AVAILABLE CHANNEL	TESTED CHANNEL	MODULATION TECHNOLOGY	MODULATION TYPE	DATA RATE (Mbps)	AXIS
B	802.11b	1 to 11	1, 6, 11	DSSS	DBPSK	1.0	X
B	802.11g	1 to 11	1, 6, 11	OFDM	BPSK	6.0	X

#### **RADIATED EMISSION TEST (BELOW 1 GHz):**

- Pre-Scan has been conducted to determine the worst-case mode from all possible combinations between available modulations, data rates, XYZ axis and antenna ports (if EUT with antenna diversity architecture).
- Following channel(s) was (were) selected for the final test as listed below.

EUT CONFIGURE MODE	MODE	AVAILABLE CHANNEL	TESTED CHANNEL	MODULATION TECHNOLOGY	MODULATION TYPE	DATA RATE (Mbps)	AXIS
A, B, C, D	802.11g	1 to 11	6	OFDM	BPSK	6.0	X



**POWER LINE CONDUCTED EMISSION TEST:**

- Pre-Scan has been conducted to determine the worst-case mode from all possible combinations between available modulations, data rates and antenna ports (if EUT with antenna diversity architecture).
- Following channel(s) was (were) selected for the final test as listed below.

EUT CONFIGURE MODE	MODE	AVAILABLE CHANNEL	TESTED CHANNEL	MODULATION TECHNOLOGY	MODULATION TYPE	DATA RATE (Mbps)
A, B, C, D	802.11g	1 to 11	6	OFDM	BPSK	6.0

**BANDEDGE MEASUREMENT:**

- Pre-Scan has been conducted to determine the worst-case mode from all possible combinations between available modulations, data rates, XYZ axis and antenna ports (if EUT with antenna diversity architecture).
- Following channel(s) was (were) selected for the final test as listed below.

EUT CONFIGURE MODE	MODE	AVAILABLE CHANNEL	TESTED CHANNEL	MODULATION TECHNOLOGY	MODULATION TYPE	DATA RATE (Mbps)	AXIS
B	802.11b	1 to 11	1, 11	DSSS	DBPSK	1.0	X
B	802.11g	1 to 11	1, 11	OFDM	BPSK	6.0	X

**ANTENNA PORT CONDUCTED MEASUREMENT:**

- Pre-Scan has been conducted to determine the worst-case mode from all possible combinations between available modulations, data rates and antenna ports (if EUT with antenna diversity architecture).
- Following channel(s) was (were) selected for the final test as listed below.

EUT CONFIGURE MODE	MODE	AVAILABLE CHANNEL	TESTED CHANNEL	MODULATION TECHNOLOGY	MODULATION TYPE	DATA RATE (Mbps)
B	802.11b	1 to 11	1, 6, 11	DSSS	DBPSK	1.0
B	802.11g	1 to 11	1, 6, 11	OFDM	BPSK	6.0



### 3.3.3 GENERAL DESCRIPTION OF APPLIED STANDARDS

The EUT is a RF Product. According to the specifications of the manufacturer, it must comply with the requirements of the following standards:

#### **FCC Part 15, Subpart C. (15.247)**

#### **ANSI C63.4- 2003**

All test items have been performed and recorded as per the above standards.

**NOTE:** The EUT is also considered as a kind of computer peripheral, because the connection to computer is necessary for typical use. It has been verified to comply with the requirements of FCC Part 15, Subpart B, Class B (DoC). The test report has been issued separately.

### 3.3.4 DESCRIPTION OF SUPPORT UNITS

The EUT has been tested as an independent unit together with other necessary accessories or support units. The following support units or accessories were used to form a representative test configuration during the tests.

NO.	PRODUCT	BRAND	MODEL NO.	SERIAL NO.	FCC ID
1	KEYBOARD	BTC	5200U	G09302046421	E5XKB5122U
2	MOUSE	Logitech	M-S43	LZE00703157	DZL211106
3	EARPHONE	PHILIPS	HL145	NA	NA
4	EARPHONE	PHILIPS	HL145	NA	NA
5	MICROPHONE	Labtec	LVA7313	NA	NA

NO.	SIGNAL CABLE DESCRIPTION OF THE ABOVE SUPPORT UNITS
1	1.5m foil shielded wire, USB Connector, w/o core.
2	1.8 m foil shielded wire, terminated with PS2 connector via drain wire, w/o core.
3	1.2m shielded cable.
4	1.2m shielded cable.
5	1.0m wrapped shielded wire, terminated via drain wire, with 3.5 mm phone plug, w/o core.

**NOTE:** All power cords of the above support units are non shielded (1.8m).

## 4. TEST TYPES AND RESULTS

### 4.1 RADIATED EMISSION MEASUREMENT

#### 4.1.1 LIMITS OF RADIATED EMISSION MEASUREMENT

Emissions radiated outside of the specified bands, shall be according to the general radiated limits in 15.209 as following:

FREQUENCIES (MHz)	FIELD STRENGTH (microvolts/meter)	MEASUREMENT DISTANCE (meters)
0.009 ~ 0.490	2400/F(kHz)	300
0.490 ~ 1.705	24000/F(kHz)	30
1.705 ~ 30.0	30	30
30 ~ 88	100	3
88 ~ 216	150	3
216 ~ 960	200	3
Above 960	500	3

**NOTE:**

1. The lower limit shall apply at the transition frequencies.
2. Emission level (dBuV/m) = 20 log Emission level (uV/m).
3. As shown in 15.35(b), for frequencies above 1000MHz, the field strength limits are based on average detector, however, the peak field strength of any emission shall not exceed the maximum permitted average limits, specified above by more than 20dB under any condition of modulation.



#### 4.1.2 TEST INSTRUMENTS

DESCRIPTION & MANUFACTURER	MODEL NO.	SERIAL NO.	DATE OF CALIBRATION	DUE DATE OF CALIBRATION
Test Receiver ROHDE & SCHWARZ	ESI7	100033	Jun. 30, 2008	Jun. 29, 2009
Spectrum Analyzer ROHDE & SCHWARZ	FSP40	100041	Apr. 22, 2008	Apr. 21, 2009
BILOG Antenna SCHWARZBECK	VULB9168	9168-160	May 02, 2008	May 01, 2009
HORN Antenna SCHWARZBECK	9120D	9120D-209	Jun. 24, 2008	Jun. 23, 2009
HORN Antenna SCHWARZBECK	BBHA 9170	BBHA9170243	Dec. 25, 2007	Dec. 24, 2008
Preamplifier Agilent	8447D	2944A10633	Nov. 03, 2008	Nov. 02, 2009
Preamplifier Agilent	8449B	3008A01964	Oct. 23, 2008	Oct. 22, 2009
RF signal cable HUBER+SUHNNER	SUCOFLEX 104	238141/4	May 20, 2008	May 19, 2009
RF signal cable HUBER+SUHNNER	SUCOFLEX 104	12738/6	May 20, 2008	May 19, 2009
Software ADT.	ADT_Radiated_V7.6	NA	NA	NA
Antenna Tower inn-co GmbH	MA 4000	013303	NA	NA
Antenna Tower Controller inn-co GmbH	CO2000	017303	NA	NA
Turn Table ADT.	TT100.	TT93021703	NA	NA
Turn Table Controller ADT.	SC100.	SC93021703	NA	NA

- NOTE:**
1. The calibration interval of the above test instruments is 12 months and the calibrations are traceable to NML/ROC and NIST/USA.
  2. The test was performed in HwaYa Chamber 3.
  3. The horn antenna and HP preamplifier (model: 8449B) are used only for the measurement of emission frequency above 1GHz if tested.
  4. The FCC Site Registration No. is 988962.
  5. The IC Site Registration No. is IC3789B-3.

#### 4.1.3 TEST PROCEDURES

- a. The EUT was placed on the top of a rotating table 0.8 meters above the ground at a 3 meter semi-anechoic chamber. The table was rotated 360 degrees to determine the position of the highest radiation.
- b. The EUT was set 3 meters away from the interference-receiving antenna, which was mounted on the top of a variable-height antenna tower.
- c. The antenna is a broadband antenna, and its height is varied from one meter to four meters above the ground to determine the maximum value of the field strength. Both horizontal and vertical polarizations of the antenna are set to make the measurement.
- d. For each suspected emission, the EUT was arranged to its worst case and then the antenna was tuned to heights from 1 meter to 4 meters and the rotatable table was turned from 0 degrees to 360 degrees to find the maximum reading.
- e. The test-receiver system was set to Peak Detect Function and Specified Bandwidth with Maximum Hold Mode.
- f. If the emission level of the EUT in peak mode was lower than the limit specified, then testing could be stopped and the peak values of the EUT would be reported. Otherwise the emissions would be re-tested one by one using the peak, quasi-peak or average method as specified and then reported in a data sheet.

**NOTE:**

1. The resolution bandwidth and video bandwidth of test receiver/spectrum analyzer is 120kHz for Quasi-peak detection at frequency below 1GHz.
2. The resolution bandwidth of test receiver/spectrum analyzer is 1 MHz and video bandwidth is 3MHz for Peak detection at frequency above 1GHz.
3. The resolution bandwidth of test receiver/spectrum analyzer is 1 MHz and the video bandwidth is 10Hz for Average detection (AV) at frequency above 1GHz.
4. All modes of operation were investigated and the worst-case emissions are reported.

#### 4.1.4 DEVIATION FROM TEST STANDARD

No deviation

#### 4.1.5 TEST SETUP

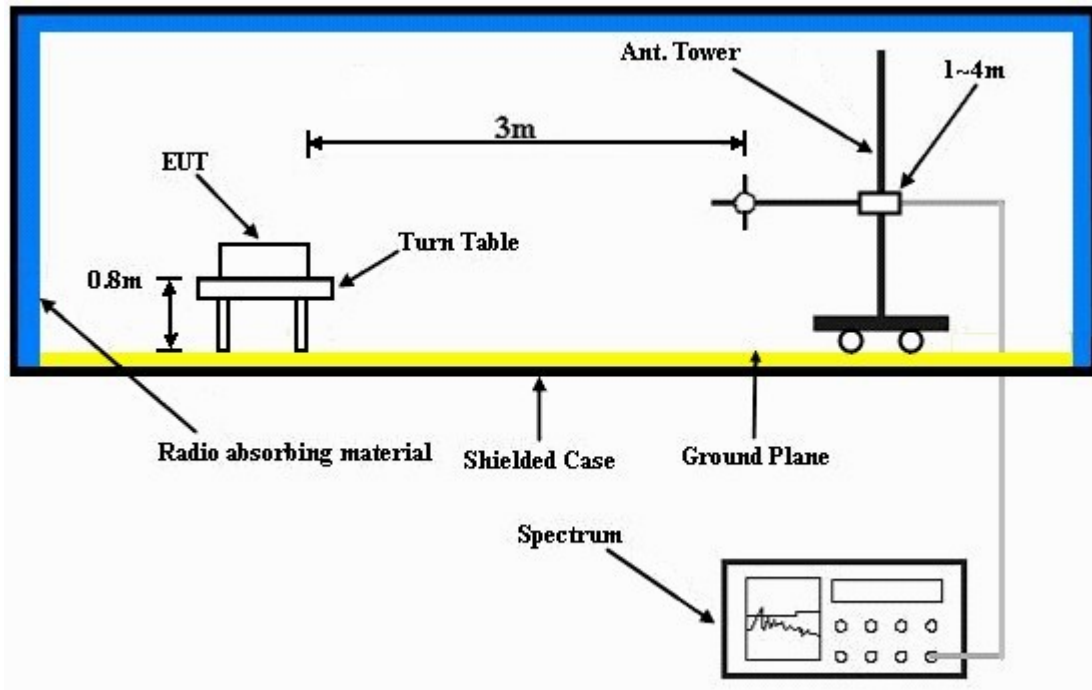

For the actual test configuration, please refer to the attached file (Test Setup Photo).

#### 4.1.6 EUT OPERATING CONDITIONS

Set EUT under transmission condition continuously at specific channel frequency.



## 4.1.7 TEST RESULTS

### 802.11b DSSS MODULATION

EUT TEST CONDITION		MEASUREMENT DETAIL	
CHANNEL	Channel 1	FREQUENCY RANGE	1 ~ 25GHz
INPUT POWER (SYSTEM)	120Vac, 60 Hz	DETECTOR FUNCTION	Peak (PK) Average (AV)
ENVIRONMENTAL CONDITIONS	23deg. C, 67%RH 1021hPa	TESTED BY	Mark Liao

ANTENNA POLARITY & TEST DISTANCE: HORIZONTAL AT 3 M								
NO.	FREQ. (MHz)	EMISSION LEVEL (dBuV/m)	LIMIT (dBuV/m)	MARGIN (dB)	ANTENNA HEIGHT (m)	TABLE ANGLE (Degree)	RAW VALUE (dBuV)	CORRECTION FACTOR (dB/m)
1	1064.00	42.25 PK	74.00	-31.75	1.40 H	124	12.92	29.33
2	1064.00	33.27 AV	54.00	-20.73	1.40 H	124	3.94	29.33
3	2390.00	61.04 PK	74.00	-12.96	1.35 H	35	28.60	32.44
4	2390.00	49.01 AV	54.00	-4.99	1.35 H	35	16.57	32.44
5	*2412.00	102.38 PK			1.35 H	35	69.86	32.52
6	*2412.00	98.00 AV			1.35 H	35	65.48	32.52
7	4824.00	51.32 PK	74.00	-22.68	1.30 H	57	13.02	38.30
8	4824.00	38.82 AV	54.00	-15.18	1.30 H	57	0.52	38.30
ANTENNA POLARITY & TEST DISTANCE: VERTICAL AT 3 M								
NO.	FREQ. (MHz)	EMISSION LEVEL (dBuV/m)	LIMIT (dBuV/m)	MARGIN (dB)	ANTENNA HEIGHT (m)	TABLE ANGLE (Degree)	RAW VALUE (dBuV)	CORRECTION FACTOR (dB/m)
1	1064.00	42.21 PK	74.00	-31.79	1.00 V	245	12.88	29.33
2	1064.00	32.90 AV	54.00	-21.10	1.00 V	245	3.57	29.33
3	2390.00	59.88 PK	74.00	-14.12	1.73 V	53	27.44	32.44
4	2390.00	48.49 AV	54.00	-5.51	1.73 V	53	16.05	32.44
5	*2412.00	98.23 PK			1.73 V	53	65.71	32.52
6	*2412.00	93.66 AV			1.73 V	53	61.14	32.52
7	4824.00	50.64 PK	74.00	-23.36	1.02 V	152	12.34	38.30
8	4824.00	38.58 AV	54.00	-15.42	1.02 V	152	0.28	38.30

- REMARKS:**
1. Emission level (dBuV/m) = Raw Value (dBuV) + Correction Factor (dB/m).
  2. Correction Factor (dB/m) = Antenna Factor (dB/m) + Cable Factor (dB).
  3. The other emission levels were very low against the limit.
  4. Margin value = Emission level – Limit value.
  5. “ \* “: Fundamental frequency.

EUT TEST CONDITION		MEASUREMENT DETAIL	
CHANNEL	Channel 6	FREQUENCY RANGE	1 ~ 25GHz
INPUT POWER (SYSTEM)	120Vac, 60 Hz	DETECTOR FUNCTION	Peak (PK) Average (AV)
ENVIRONMENTAL CONDITIONS	23deg. C, 67%RH 1021hPa	TESTED BY	Mark Liao

ANTENNA POLARITY & TEST DISTANCE: HORIZONTAL AT 3 M								
NO.	FREQ. (MHz)	EMISSION LEVEL (dBuV/m)	LIMIT (dBuV/m)	MARGIN (dB)	ANTENNA HEIGHT (m)	TABLE ANGLE (Degree)	RAW VALUE (dBuV)	CORRECTION FACTOR (dB/m)
1	1080.00	40.24 PK	74.00	-33.76	1.49 H	341	10.86	29.38
2	1080.00	28.44 AV	54.00	-25.56	1.49 H	341	-0.94	29.38
3	*2437.00	102.10 PK			1.32 H	35	69.50	32.60
4	*2437.00	97.79 AV			1.32 H	35	65.19	32.60
5	4874.00	51.23 PK	74.00	-22.77	1.24 H	78	12.73	38.50
6	4874.00	37.20 AV	54.00	-16.80	1.24 H	78	-1.30	38.50
ANTENNA POLARITY & TEST DISTANCE: VERTICAL AT 3 M								
NO.	FREQ. (MHz)	EMISSION LEVEL (dBuV/m)	LIMIT (dBuV/m)	MARGIN (dB)	ANTENNA HEIGHT (m)	TABLE ANGLE (Degree)	RAW VALUE (dBuV)	CORRECTION FACTOR (dB/m)
1	1080.00	40.41 PK	74.00	-33.59	1.00 V	118	11.03	29.38
2	1080.00	30.98 AV	54.00	-23.02	1.00 V	118	1.60	29.38
3	*2437.00	98.57 PK			1.71 V	93	65.97	32.60
4	*2437.00	93.78 AV			1.71 V	93	61.18	32.60
5	4874.00	51.80 PK	74.00	-22.20	1.09 V	130	13.30	38.50
6	4874.00	39.15 AV	54.00	-14.85	1.09 V	130	0.65	38.50

- REMARKS:**
1. Emission level (dBuV/m) = Raw Value (dBuV) + Correction Factor (dB/m).
  2. Correction Factor (dB/m) = Antenna Factor (dB/m) + Cable Factor (dB).
  3. The other emission levels were very low against the limit.
  4. Margin value = Emission level – Limit value.
  5. “ \* “: Fundamental frequency.

EUT TEST CONDITION		MEASUREMENT DETAIL	
CHANNEL	Channel 11	FREQUENCY RANGE	1 ~ 25GHz
INPUT POWER (SYSTEM)	120Vac, 60 Hz	DETECTOR FUNCTION	Peak (PK) Average (AV)
ENVIRONMENTAL CONDITIONS	23deg. C, 67%RH 1021hPa	TESTED BY	Mark Liao

ANTENNA POLARITY & TEST DISTANCE: HORIZONTAL AT 3 M								
NO.	FREQ. (MHz)	EMISSION LEVEL (dBuV/m)	LIMIT (dBuV/m)	MARGIN (dB)	ANTENNA HEIGHT (m)	TABLE ANGLE (Degree)	RAW VALUE (dBuV)	CORRECTION FACTOR (dB/m)
1	1112.00	42.92 PK	74.00	-31.08	1.25 H	116	13.45	29.47
2	1112.00	34.04 AV	54.00	-19.96	1.25 H	116	4.57	29.47
3	*2462.00	102.62 PK			1.32 H	36	69.94	32.68
4	*2462.00	98.20 AV			1.32 H	36	65.52	32.68
5	2483.50	61.04 PK	74.00	-12.96	1.32 H	36	28.28	32.76
6	2483.50	49.08 AV	54.00	-4.92	1.32 H	36	16.32	32.76
7	4924.00	51.58 PK	74.00	-22.42	1.09 H	73	12.94	38.64
8	4924.00	37.19 AV	54.00	-16.81	1.09 H	73	-1.45	38.64
ANTENNA POLARITY & TEST DISTANCE: VERTICAL AT 3 M								
NO.	FREQ. (MHz)	EMISSION LEVEL (dBuV/m)	LIMIT (dBuV/m)	MARGIN (dB)	ANTENNA HEIGHT (m)	TABLE ANGLE (Degree)	RAW VALUE (dBuV)	CORRECTION FACTOR (dB/m)
1	1112.00	41.51 PK	74.00	-32.49	1.42 V	152	12.04	29.47
2	1112.00	30.98 AV	54.00	-23.02	1.42 V	152	1.51	29.47
3	*2462.00	98.28 PK			1.66 V	64	65.60	32.68
4	*2462.00	93.82 AV			1.66 V	64	61.14	32.68
5	2483.50	60.41 PK	74.00	-13.59	1.66 V	64	27.65	32.76
6	2483.50	48.86 AV	54.00	-5.14	1.66 V	64	16.10	32.76
7	4924.00	52.82 PK	74.00	-21.18	1.13 V	124	14.18	38.64
8	4924.00	40.02 AV	54.00	-13.98	1.13 V	124	1.38	38.64

- REMARKS:**
1. Emission level (dBuV/m) = Raw Value (dBuV) + Correction Factor (dB/m).
  2. Correction Factor (dB/m) = Antenna Factor (dB/m) + Cable Factor (dB).
  3. The other emission levels were very low against the limit.
  4. Margin value = Emission level – Limit value.
  5. “ \* “: Fundamental frequency.

### 802.11g OFDM MODULATION

EUT TEST CONDITION		MEASUREMENT DETAIL	
CHANNEL	Channel 1	FREQUENCY RANGE	1 ~ 25GHz
INPUT POWER (SYSTEM)	120Vac, 60 Hz	DETECTOR FUNCTION	Peak (PK) Average (AV)
ENVIRONMENTAL CONDITIONS	23deg. C, 67%RH 1021hPa	TESTED BY	Mark Liao

ANTENNA POLARITY & TEST DISTANCE: HORIZONTAL AT 3 M								
NO.	FREQ. (MHz)	EMISSION LEVEL (dBuV/m)	LIMIT (dBuV/m)	MARGIN (dB)	ANTENNA HEIGHT (m)	TABLE ANGLE (Degree)	RAW VALUE (dBuV)	CORRECTION FACTOR (dB/m)
1	1064.00	42.53 PK	74.00	-31.47	1.35 H	121	13.20	29.33
2	1064.00	33.56 AV	54.00	-20.44	1.35 H	121	4.23	29.33
3	2390.00	59.51 PK	74.00	-14.49	1.36 H	34	27.07	32.44
4	2390.00	48.11 AV	54.00	-5.89	1.36 H	34	15.67	32.44
5	*2412.00	100.28 PK			1.36 H	34	67.76	32.52
6	*2412.00	90.28 AV			1.36 H	34	57.76	32.52
7	4824.00	48.73 PK	74.00	-25.27	1.24 H	43	10.43	38.30
8	4824.00	35.79 AV	54.00	-18.21	1.24 H	43	-2.51	38.30
ANTENNA POLARITY & TEST DISTANCE: VERTICAL AT 3 M								
NO.	FREQ. (MHz)	EMISSION LEVEL (dBuV/m)	LIMIT (dBuV/m)	MARGIN (dB)	ANTENNA HEIGHT (m)	TABLE ANGLE (Degree)	RAW VALUE (dBuV)	CORRECTION FACTOR (dB/m)
1	1064.00	42.22 PK	74.00	-31.78	1.00 V	246	12.89	29.33
2	1064.00	32.89 AV	54.00	-21.11	1.00 V	246	3.56	29.33
3	2390.00	59.58 PK	74.00	-14.42	1.75 V	52	27.14	32.44
4	2390.00	47.68 AV	54.00	-6.32	1.75 V	52	15.24	32.44
5	*2412.00	96.43 PK			1.75 V	52	63.91	32.52
6	*2412.00	86.80 AV			1.75 V	52	54.28	32.52
7	4824.00	48.61 PK	74.00	-25.39	1.14 V	143	10.31	38.30
8	4824.00	35.92 AV	54.00	-18.08	1.14 V	143	-2.38	38.30

- REMARKS:**
1. Emission level (dBuV/m) = Raw Value (dBuV) + Correction Factor (dB/m).
  2. Correction Factor (dB/m) = Antenna Factor (dB/m) + Cable Factor (dB).
  3. The other emission levels were very low against the limit.
  4. Margin value = Emission level – Limit value.
  5. “ \* “: Fundamental frequency.

EUT TEST CONDITION		MEASUREMENT DETAIL	
CHANNEL	Channel 6	FREQUENCY RANGE	1 ~ 25GHz
INPUT POWER (SYSTEM)	120Vac, 60 Hz	DETECTOR FUNCTION	Peak (PK) Average (AV)
ENVIRONMENTAL CONDITIONS	23deg. C, 67%RH 1021hPa	TESTED BY	Mark Liao

ANTENNA POLARITY & TEST DISTANCE: HORIZONTAL AT 3 M								
NO.	FREQ. (MHz)	EMISSION LEVEL (dBuV/m)	LIMIT (dBuV/m)	MARGIN (dB)	ANTENNA HEIGHT (m)	TABLE ANGLE (Degree)	RAW VALUE (dBuV)	CORRECTION FACTOR (dB/m)
1	1080.00	40.86 PK	74.00	-33.14	1.50 H	35	11.48	29.38
2	1080.00	30.41 AV	54.00	-23.59	1.50 H	35	1.03	29.38
3	*2437.00	100.16 PK			1.31 H	49	67.56	32.60
4	*2437.00	89.64 AV			1.31 H	49	57.04	32.60
5	4874.00	49.04 PK	74.00	-24.96	1.08 H	64	10.54	38.50
6	4874.00	35.85 AV	54.00	-18.15	1.08 H	64	-2.65	38.50
ANTENNA POLARITY & TEST DISTANCE: VERTICAL AT 3 M								
NO.	FREQ. (MHz)	EMISSION LEVEL (dBuV/m)	LIMIT (dBuV/m)	MARGIN (dB)	ANTENNA HEIGHT (m)	TABLE ANGLE (Degree)	RAW VALUE (dBuV)	CORRECTION FACTOR (dB/m)
1	1080.00	40.57 PK	74.00	-33.43	1.43 V	156	11.19	29.38
2	1080.00	30.68 AV	54.00	-23.32	1.43 V	156	1.30	29.38
3	*2437.00	96.76 PK			1.71 V	68	64.16	32.60
4	*2437.00	86.38 AV			1.71 V	68	53.78	32.60
5	4874.00	48.82 PK	74.00	-25.18	1.13 V	120	10.32	38.50
6	4874.00	36.04 AV	54.00	-17.96	1.13 V	120	-2.46	38.50

- REMARKS:**
1. Emission level (dBuV/m) = Raw Value (dBuV) + Correction Factor (dB/m).
  2. Correction Factor (dB/m) = Antenna Factor (dB/m) + Cable Factor (dB).
  3. The other emission levels were very low against the limit.
  4. Margin value = Emission level – Limit value.
  5. “ \* “: Fundamental frequency.

EUT TEST CONDITION		MEASUREMENT DETAIL	
CHANNEL	Channel 11	FREQUENCY RANGE	1 ~ 25GHz
INPUT POWER (SYSTEM)	120Vac, 60 Hz	DETECTOR FUNCTION	Peak (PK) Average (AV)
ENVIRONMENTAL CONDITIONS	23deg. C, 67%RH 1021hPa	TESTED BY	Mark Liao

ANTENNA POLARITY & TEST DISTANCE: HORIZONTAL AT 3 M								
NO.	FREQ. (MHz)	EMISSION LEVEL (dBuV/m)	LIMIT (dBuV/m)	MARGIN (dB)	ANTENNA HEIGHT (m)	TABLE ANGLE (Degree)	RAW VALUE (dBuV)	CORRECTION FACTOR (dB/m)
1	1112.00	42.96 PK	74.00	-31.04	1.32 H	162	13.49	29.47
2	1112.00	33.56 AV	54.00	-20.44	1.32 H	162	4.09	29.47
3	*2462.00	100.41 PK			1.32 H	36	67.73	32.68
4	*2462.00	90.18 AV			1.32 H	36	57.50	32.68
5	2483.50	60.13 PK	74.00	-13.87	1.32 H	36	27.37	32.76
6	2483.50	48.79 AV	54.00	-5.21	1.32 H	36	16.03	32.76
7	4924.00	49.52 PK	74.00	-24.48	1.12 H	82	10.88	38.64
8	4924.00	36.03 AV	54.00	-17.97	1.12 H	82	-2.61	38.64
ANTENNA POLARITY & TEST DISTANCE: VERTICAL AT 3 M								
NO.	FREQ. (MHz)	EMISSION LEVEL (dBuV/m)	LIMIT (dBuV/m)	MARGIN (dB)	ANTENNA HEIGHT (m)	TABLE ANGLE (Degree)	RAW VALUE (dBuV)	CORRECTION FACTOR (dB/m)
1	1112.00	41.43 PK	74.00	-32.57	1.00 V	95	11.96	29.47
2	1112.00	31.87 AV	54.00	-22.13	1.00 V	95	2.40	29.47
3	*2462.00	96.72 PK			1.64 V	64	64.04	32.68
4	*2462.00	87.24 AV			1.64 V	64	54.56	32.68
5	2483.50	60.46 PK	74.00	-13.54	1.64 V	64	27.70	32.76
6	2483.50	47.45 AV	54.00	-6.55	1.64 V	64	14.69	32.76
7	4904.00	49.74 PK	74.00	-24.26	1.06 V	92	11.13	38.61
8	4904.00	36.19 AV	54.00	-17.81	1.06 V	92	-2.42	38.61

- REMARKS:**
1. Emission level (dBuV/m) = Raw Value (dBuV) + Correction Factor (dB/m).
  2. Correction Factor (dB/m) = Antenna Factor (dB/m) + Cable Factor (dB).
  3. The other emission levels were very low against the limit.
  4. Margin value = Emission level – Limit value.
  5. “ \* “: Fundamental frequency.



**BELOW 1GHz WORST-CASE DATA : 802.11g OFDM MODULATION**

EUT TEST CONDITION		MEASUREMENT DETAIL	
CHANNEL	Channel 6	FREQUENCY RANGE	Below 1000MHz
INPUT POWER (SYSTEM)	120Vac, 60 Hz	DETECTOR FUNCTION	Quasi-Peak
ENVIRONMENTAL CONDITIONS	26deg. C, 66%RH 1022hPa	TESTED BY	Match Tsui
TEST MODE	A		

ANTENNA POLARITY & TEST DISTANCE: HORIZONTAL AT 3 M								
NO.	FREQ. (MHz)	EMISSION LEVEL (dBuV/m)	LIMIT (dBuV/m)	MARGIN (dB)	ANTENNA HEIGHT (m)	TABLE ANGLE (Degree)	RAW VALUE (dBuV)	CORRECTION FACTOR (dB/m)
1	300.16	35.24 QP	46.00	-10.76	1.00 H	10	20.82	14.42
2	531.53	35.25 QP	46.00	-10.75	1.50 H	334	13.08	22.17
3	599.58	38.08 QP	46.00	-7.92	1.25 H	328	14.43	23.65
4	642.35	34.37 QP	46.00	-11.63	1.25 H	340	9.52	24.85
5	900.94	35.66 QP	46.00	-10.34	2.00 H	10	5.75	29.91
6	932.05	39.12 QP	46.00	-6.88	1.50 H	277	8.87	30.25

ANTENNA POLARITY & TEST DISTANCE: VERTICAL AT 3 M								
NO.	FREQ. (MHz)	EMISSION LEVEL (dBuV/m)	LIMIT (dBuV/m)	MARGIN (dB)	ANTENNA HEIGHT (m)	TABLE ANGLE (Degree)	RAW VALUE (dBuV)	CORRECTION FACTOR (dB/m)
1	265.16	30.32 QP	46.00	-15.68	1.25 V	22	15.90	14.42
2	531.53	31.26 QP	46.00	-14.74	1.50 V	40	9.09	22.17
3	599.58	34.05 QP	46.00	-11.95	1.50 V	235	10.40	23.65
4	642.35	30.39 QP	46.00	-15.61	1.00 V	208	5.53	24.85
5	780.40	30.12 QP	46.00	-15.88	1.50 V	199	2.77	27.35
6	900.94	32.61 QP	46.00	-13.39	2.00 V	298	2.70	29.91
7	932.05	36.94 QP	46.00	-9.06	1.00 V	151	6.69	30.25

- REMARKS:**
1. Emission level (dBuV/m) = Raw Value (dBuV) + Correction Factor (dB/m).
  2. Correction Factor (dB/m) = Antenna Factor (dB/m) + Cable Factor (dB).
  3. The other emission levels were very low against the limit.
  4. Margin value = Emission level – Limit value.

EUT TEST CONDITION		MEASUREMENT DETAIL	
CHANNEL	Channel 6	FREQUENCY RANGE	Below 1000MHz
INPUT POWER (SYSTEM)	120Vac, 60 Hz	DETECTOR FUNCTION	Quasi-Peak
ENVIRONMENTAL CONDITIONS	26deg. C, 66%RH 1022hPa	TESTED BY	Match Tsui
TEST MODE	B		

ANTENNA POLARITY & TEST DISTANCE: HORIZONTAL AT 3 M								
NO.	FREQ. (MHz)	EMISSION LEVEL (dBuV/m)	LIMIT (dBuV/m)	MARGIN (dB)	ANTENNA HEIGHT (m)	TABLE ANGLE (Degree)	RAW VALUE (dBuV)	CORRECTION FACTOR (dB/m)
1	132.95	31.99 QP	43.50	-11.51	1.50 H	289	19.15	12.84
2	179.61	32.36 QP	43.50	-11.14	1.50 H	352	20.10	12.26
3	234.05	33.98 QP	46.00	-12.02	1.25 H	337	20.63	13.35
4	265.16	39.78 QP	46.00	-6.22	1.25 H	328	25.36	14.42
5	300.16	36.39 QP	46.00	-9.61	1.00 H	151	21.97	14.42
6	599.58	36.87 QP	46.00	-9.13	1.25 H	328	13.22	23.65
7	642.35	33.03 QP	46.00	-12.97	1.25 H	256	8.18	24.85
8	900.94	35.29 QP	46.00	-10.71	1.50 H	4	5.38	29.91
9	932.05	38.41 QP	46.00	-7.59	1.50 H	67	8.16	30.25
ANTENNA POLARITY & TEST DISTANCE: VERTICAL AT 3 M								
NO.	FREQ. (MHz)	EMISSION LEVEL (dBuV/m)	LIMIT (dBuV/m)	MARGIN (dB)	ANTENNA HEIGHT (m)	TABLE ANGLE (Degree)	RAW VALUE (dBuV)	CORRECTION FACTOR (dB/m)
1	59.06	26.03 QP	40.00	-13.97	1.25 V	175	12.78	13.24
2	70.73	27.12 QP	40.00	-12.88	1.25 V	280	13.87	13.25
3	132.95	30.04 QP	43.50	-13.46	1.50 V	103	17.20	12.84
4	179.61	28.82 QP	43.50	-14.68	2.00 V	172	16.56	12.26
5	265.16	34.77 QP	46.00	-11.23	1.50 V	220	20.34	14.42
6	599.58	32.01 QP	46.00	-13.99	1.50 V	61	8.36	23.65
7	780.40	31.12 QP	46.00	-14.88	1.25 V	334	3.77	27.35
8	900.94	33.19 QP	46.00	-12.81	2.00 V	328	3.28	29.91
9	932.05	34.46 QP	46.00	-11.54	1.50 V	208	4.21	30.25

- REMARKS:**
1. Emission level (dBuV/m) = Raw Value (dBuV) + Correction Factor (dB/m).
  2. Correction Factor (dB/m) = Antenna Factor (dB/m) + Cable Factor (dB).
  3. The other emission levels were very low against the limit.
  4. Margin value = Emission level – Limit value.



EUT TEST CONDITION		MEASUREMENT DETAIL	
CHANNEL	Channel 6	FREQUENCY RANGE	Below 1000MHz
INPUT POWER (SYSTEM)	120Vac, 60 Hz	DETECTOR FUNCTION	Quasi-Peak
ENVIRONMENTAL CONDITIONS	26deg. C, 66%RH 1022hPa	TESTED BY	Match Tsui
TEST MODE	C		

ANTENNA POLARITY & TEST DISTANCE: HORIZONTAL AT 3 M								
NO.	FREQ. (MHz)	EMISSION LEVEL (dBuV/m)	LIMIT (dBuV/m)	MARGIN (dB)	ANTENNA HEIGHT (m)	TABLE ANGLE (Degree)	RAW VALUE (dBuV)	CORRECTION FACTOR (dB/m)
1	80.45	36.54 QP	40.00	-3.46	1.50 H	343	28.13	8.40
2	119.34	41.62 QP	43.50	-1.88	1.50 H	22	29.84	11.79
3	129.06	40.72 QP	43.50	-2.78	2.00 H	10	28.20	12.52
4	162.11	40.43 QP	43.50	-3.07	1.50 H	97	25.71	14.71
5	239.88	41.73 QP	46.00	-4.27	1.00 H	76	27.99	13.74
6	265.16	38.85 QP	46.00	-7.15	1.50 H	13	24.43	14.42
7	479.03	43.42 QP	46.00	-2.58	1.50 H	124	22.51	20.91
ANTENNA POLARITY & TEST DISTANCE: VERTICAL AT 3 M								
NO.	FREQ. (MHz)	EMISSION LEVEL (dBuV/m)	LIMIT (dBuV/m)	MARGIN (dB)	ANTENNA HEIGHT (m)	TABLE ANGLE (Degree)	RAW VALUE (dBuV)	CORRECTION FACTOR (dB/m)
1	80.45	30.02 QP	40.00	-9.98	2.00 V	271	21.62	8.40
2	265.16	35.65 QP	46.00	-10.35	1.25 V	157	21.23	14.42
3	362.37	34.95 QP	46.00	-11.05	1.50 V	268	17.68	17.27
4	410.98	36.65 QP	46.00	-9.35	1.50 V	67	17.45	19.20
5	459.59	38.73 QP	46.00	-7.27	1.25 V	241	18.34	20.39
6	508.19	35.90 QP	46.00	-10.10	1.25 V	238	14.25	21.65
7	797.89	35.10 QP	46.00	-10.90	1.25 V	349	7.57	27.52
8	900.94	36.87 QP	46.00	-9.13	1.00 V	4	6.96	29.91

- REMARKS:**
1. Emission level (dBuV/m) = Raw Value (dBuV) + Correction Factor (dB/m).
  2. Correction Factor (dB/m) = Antenna Factor (dB/m) + Cable Factor (dB).
  3. The other emission levels were very low against the limit.
  4. Margin value = Emission level – Limit value.

EUT TEST CONDITION		MEASUREMENT DETAIL	
CHANNEL	Channel 6	FREQUENCY RANGE	Below 1000MHz
INPUT POWER (SYSTEM)	120Vac, 60 Hz	DETECTOR FUNCTION	Quasi-Peak
ENVIRONMENTAL CONDITIONS	26deg. C, 66%RH 1022hPa	TESTED BY	Match Tsui
TEST MODE	D		

ANTENNA POLARITY & TEST DISTANCE: HORIZONTAL AT 3 M								
NO.	FREQ. (MHz)	EMISSION LEVEL (dBuV/m)	LIMIT (dBuV/m)	MARGIN (dB)	ANTENNA HEIGHT (m)	TABLE ANGLE (Degree)	RAW VALUE (dBuV)	CORRECTION FACTOR (dB/m)
1	96.01	40.23 QP	43.50	-3.27	2.00 H	103	29.73	10.50
2	158.22	36.50 QP	43.50	-7.00	1.50 H	94	21.71	14.78
3	164.06	35.56 QP	43.50	-7.94	1.00 H	94	20.97	14.60
4	234.05	41.41 QP	46.00	-4.59	1.25 H	313	28.07	13.35
5	265.16	38.30 QP	46.00	-7.70	1.00 H	238	23.88	14.42
6	479.03	41.38 QP	46.00	-4.62	1.50 H	130	20.47	20.91
7	508.19	38.76 QP	46.00	-7.24	2.00 H	40	17.11	21.65
ANTENNA POLARITY & TEST DISTANCE: VERTICAL AT 3 M								
NO.	FREQ. (MHz)	EMISSION LEVEL (dBuV/m)	LIMIT (dBuV/m)	MARGIN (dB)	ANTENNA HEIGHT (m)	TABLE ANGLE (Degree)	RAW VALUE (dBuV)	CORRECTION FACTOR (dB/m)
1	39.62	33.04 QP	40.00	-6.96	1.25 V	94	17.74	15.30
2	78.51	36.55 QP	40.00	-3.45	2.00 V	160	27.36	9.19
3	410.98	36.85 QP	46.00	-9.15	1.50 V	94	17.65	19.20
4	479.03	38.79 QP	46.00	-7.21	1.50 V	241	17.88	20.91
5	508.19	36.61 QP	46.00	-9.39	1.25 V	13	14.96	21.65
6	900.94	37.40 QP	46.00	-8.60	1.00 V	343	7.49	29.91

- REMARKS:**
1. Emission level (dBuV/m) = Raw Value (dBuV) + Correction Factor (dB/m).
  2. Correction Factor (dB/m) = Antenna Factor (dB/m) + Cable Factor (dB).
  3. The other emission levels were very low against the limit.
  4. Margin value = Emission level – Limit value.

## 4.2 CONDUCTED EMISSION MEASUREMENT

### 4.2.1 LIMITS OF CONDUCTED EMISSION MEASUREMENT

FREQUENCY OF EMISSION (MHz)	CONDUCTED LIMIT (dB $\mu$ V)	
	Quasi-peak	Average
0.15 ~ 0.5	66 to 56	56 to 46
0.5 ~ 5	56	46
5 ~ 30	60	50

- NOTE:**
1. The lower limit shall apply at the transition frequencies.
  2. The limit decreases in line with the logarithm of the frequency in the range of 0.15 to 0.50 MHz.
  3. All emanations from a class A/B digital device or system, including any network of conductors and apparatus connected thereto, shall not exceed the level of field strengths specified above.

### 4.2.2 TEST INSTRUMENTS

DESCRIPTION & MANUFACTURER	MODEL NO.	SERIAL NO.	DATE OF CALIBRATION	DUE DATE OF CALIBRATION
Test Receiver ROHDE & SCHWARZ	ESCS30	100288	Sep. 22, 2008	Sep. 21, 2009
RF signal cable Woken	5D-FB	Cable-HYCO2-01	Jan. 04, 2008	Jan. 03, 2009
LISN ROHDE & SCHWARZ	ESH2-Z5	100100	Jan. 10, 2008	Jan. 09, 2009
LISN ROHDE & SCHWARZ	ESH3-Z5	100311	Jul. 30, 2008	Jul. 29, 2009
Software ADT	ADT_Cond_V3	NA	NA	NA

- NOTE:**
1. The calibration interval of the above test instruments is 12 months and the calibrations are traceable to NML/ROC and NIST/USA.
  2. The test was performed in HwaYa Shielded Room 2.
  3. The VCCI Site Registration No. is C-2047.

#### 4.2.3 TEST PROCEDURES

- a. The EUT was placed 0.4 meters from the conducting wall of the shielded room with EUT being connected to the power mains through a line impedance stabilization network (LISN). Other support units were connected to the power mains through another LISN. The two LISNs provide 50 ohm/ 50uH of coupling impedance for the measuring instrument.
- b. Both lines of the power mains connected to the EUT were checked for maximum conducted interference.
- c. The frequency range from 150kHz to 30MHz was searched. Emission levels under (Limit - 20dB) was not recorded.

#### 4.2.4 DEVIATION FROM TEST STANDARD

No deviation

#### 4.2.5 TEST SETUP

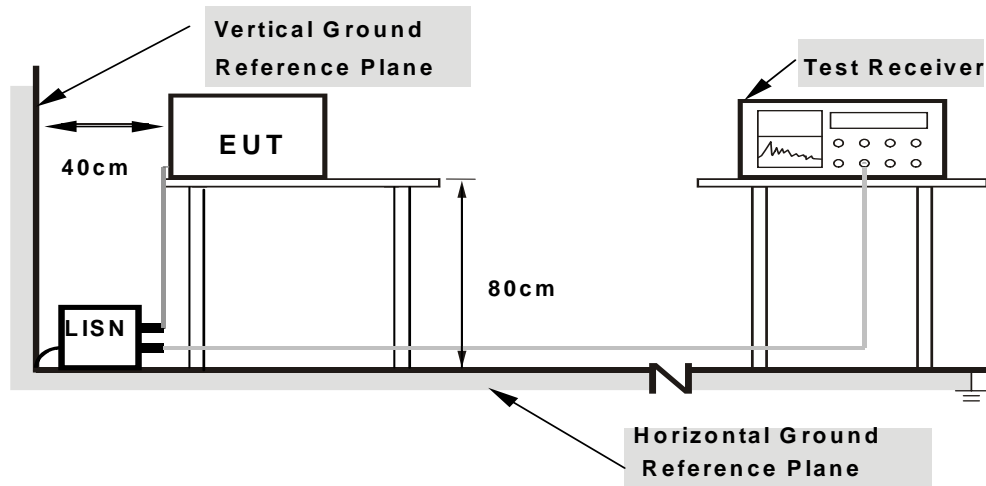

- Note:**
1. Support units were connected to second LISN.
  2. Both of LISNs (AMN) are 80 cm from EUT and at least 80 cm from other units and other metal planes

For the actual test configuration, please refer to the attached file (Test Setup Photo).

#### 4.2.6 EUT OPERATING CONDITIONS

Same as 4.1.6.

## 4.2.7 TEST RESULTS

### CONDUCTED WORST CASE DATA\_802.11g OFDM MODULATION

EUT TEST CONDITION		MEASUREMENT DETAIL	
CHANNEL	Channel 6	PHASE	Line 1
MODULATION TYPE	BPSK	6dB BANDWIDTH	9 kHz
TRANSFER RATE	6Mbps	INPUT POWER	120Vac, 60 Hz
ENVIRONMENTAL CONDITIONS	20deg. C, 60%RH, 1022hPa	TESTED BY	Match Tsui
TEST MODE	A		

No	Freq. [MHz]	Corr.	Reading Value		Emission Level		Limit		Margin	
		Factor [dB]	Q.P. [dB (uV)]	AV. [dB (uV)]	Q.P. [dB (uV)]	AV. [dB (uV)]	Q.P. [dB (uV)]	AV. [dB (uV)]	Q.P. [dB]	AV. [dB]
1	0.150	0.12	39.07	-	39.19	-	66.00	56.00	-26.81	-
2	0.213	0.13	44.59	-	44.72	-	63.11	53.11	-18.39	-
3	0.357	0.14	36.69	-	36.83	-	58.80	48.80	-21.97	-
4	0.642	0.15	30.51	-	30.66	-	56.00	46.00	-25.34	-
5	3.922	0.43	28.90	-	29.33	-	56.00	46.00	-26.67	-
6	21.453	1.39	33.33	-	34.72	-	60.00	50.00	-25.28	-

- REMARKS:**
1. Q.P. and AV. are abbreviations of quasi-peak and average individually.
  2. "-": The Quasi-peak reading value also meets average limit and measurement with the average detector is unnecessary.
  3. The emission levels of other frequencies were very low against the limit.
  4. Margin value = Emission level - Limit value
  5. Correction factor = Insertion loss + Cable loss
  6. Emission Level = Correction Factor + Reading Value.

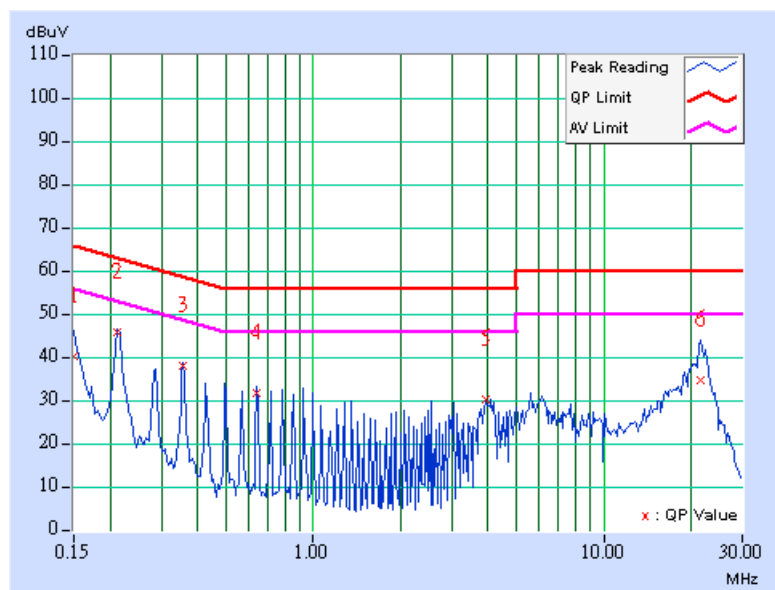

EUT TEST CONDITION		MEASUREMENT DETAIL	
CHANNEL	Channel 6	PHASE	Line 2
MODULATION TYPE	BPSK	6dB BANDWIDTH	9 kHz
TRANSFER RATE	6Mbps	INPUT POWER	120Vac, 60 Hz
ENVIRONMENTAL CONDITIONS	20deg. C, 60%RH, 1022hPa	TESTED BY	Match Tsui
TEST MODE	A		

No	Freq. [MHz]	Corr. Factor (dB)	Reading Value [dB (uV)]		Emission Level [dB (uV)]		Limit [dB (uV)]		Margin (dB)	
			Q.P.	AV.	Q.P.	AV.	Q.P.	AV.	Q.P.	AV.
1	0.150	0.14	39.07	-	39.21	-	66.00	56.00	-26.79	-
2	0.213	0.14	44.67	-	44.81	-	63.11	53.11	-18.30	-
3	0.357	0.15	34.29	-	34.44	-	58.80	48.80	-24.36	-
4	0.783	0.17	31.00	-	31.17	-	56.00	46.00	-24.83	-
5	3.277	0.37	30.73	-	31.10	-	56.00	46.00	-24.90	-
6	22.016	0.98	35.63	-	36.61	-	60.00	50.00	-23.39	-

- REMARKS:**
1. Q.P. and AV. are abbreviations of quasi-peak and average individually.
  2. "-": The Quasi-peak reading value also meets average limit and measurement with the average detector is unnecessary.
  3. The emission levels of other frequencies were very low against the limit.
  4. Margin value = Emission level - Limit value
  5. Correction factor = Insertion loss + Cable loss
  6. Emission Level = Correction Factor + Reading Value.

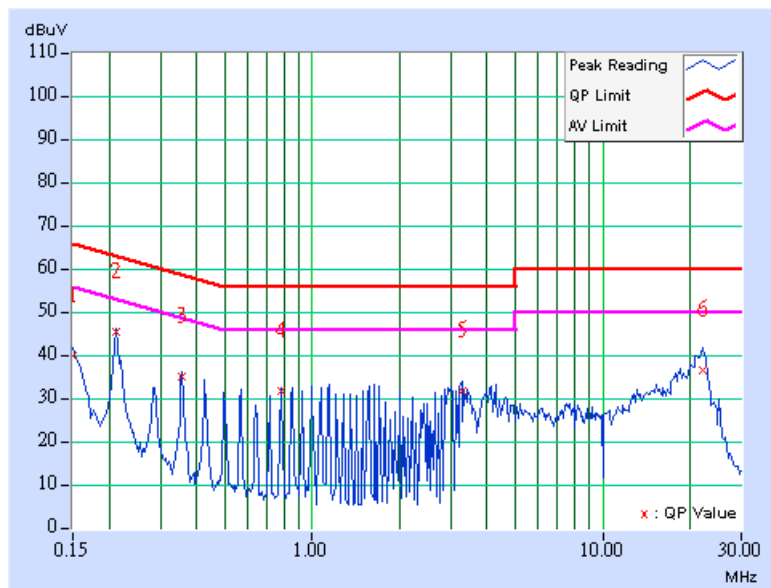

EUT TEST CONDITION		MEASUREMENT DETAIL	
CHANNEL	Channel 6	PHASE	Line 1
MODULATION TYPE	BPSK	6dB BANDWIDTH	9 kHz
TRANSFER RATE	6Mbps	INPUT POWER	120Vac, 60 Hz
ENVIRONMENTAL CONDITIONS	25deg. C, 72%RH, 1023hPa	TESTED BY	Long Chen
TEST MODE	B		

No	Freq. [MHz]	Corr. Factor (dB)	Reading Value [dB (uV)]		Emission Level [dB (uV)]		Limit [dB (uV)]		Margin (dB)	
			Q.P.	AV.	Q.P.	AV.	Q.P.	AV.	Q.P.	AV.
1	0.275	0.13	39.30	-	39.43	-	60.97	50.97	-21.53	-
2	0.439	0.14	37.84	-	37.98	-	57.08	47.08	-19.10	-
3	0.603	0.15	38.13	-	38.28	-	56.00	46.00	-17.72	-
4	0.771	0.16	37.66	-	37.82	-	56.00	46.00	-18.18	-
5	0.935	0.17	37.50	-	37.67	-	56.00	46.00	-18.33	-
6	12.520	0.75	29.51	-	30.26	-	60.00	50.00	-29.74	-

- REMARKS:**
1. Q.P. and AV. are abbreviations of quasi-peak and average individually.
  2. "-": The Quasi-peak reading value also meets average limit and measurement with the average detector is unnecessary.
  3. The emission levels of other frequencies were very low against the limit.
  4. Margin value = Emission level - Limit value
  5. Correction factor = Insertion loss + Cable loss
  6. Emission Level = Correction Factor + Reading Value.

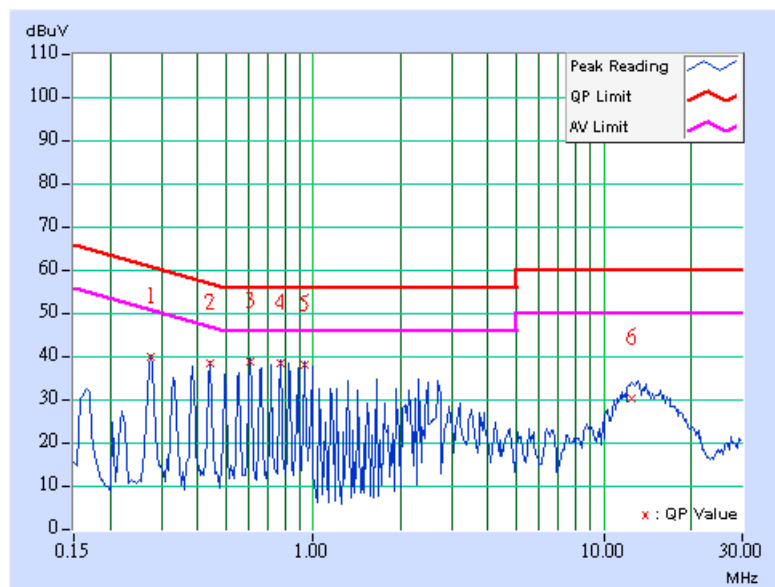



EUT TEST CONDITION		MEASUREMENT DETAIL	
CHANNEL	Channel 6	PHASE	Line 2
MODULATION TYPE	BPSK	6dB BANDWIDTH	9 kHz
TRANSFER RATE	6Mbps	INPUT POWER	120Vac, 60 Hz
ENVIRONMENTAL CONDITIONS	25deg. C, 72%RH, 1023hPa	TESTED BY	Long Chen
TEST MODE	B		

No	Freq. [MHz]	Corr. Factor (dB)	Reading Value [dB (uV)]		Emission Level [dB (uV)]		Limit [dB (uV)]		Margin (dB)	
			Q.P.	AV.	Q.P.	AV.	Q.P.	AV.	Q.P.	AV.
1	0.276	0.14	35.71	-	35.85	-	60.95	50.95	-25.09	-
2	0.498	0.15	32.95	-	33.10	-	56.04	46.04	-22.93	-
3	0.607	0.16	32.82	-	32.98	-	56.00	46.00	-23.02	-
4	0.716	0.17	35.20	-	35.37	-	56.00	46.00	-20.63	-
5	0.939	0.18	33.85	-	34.03	-	56.00	46.00	-21.97	-
6	13.176	0.67	23.13	-	23.80	-	60.00	50.00	-36.20	-

- REMARKS:**
1. Q.P. and AV. are abbreviations of quasi-peak and average individually.
  2. "-": The Quasi-peak reading value also meets average limit and measurement with the average detector is unnecessary.
  3. The emission levels of other frequencies were very low against the limit.
  4. Margin value = Emission level - Limit value
  5. Correction factor = Insertion loss + Cable loss
  6. Emission Level = Correction Factor + Reading Value.

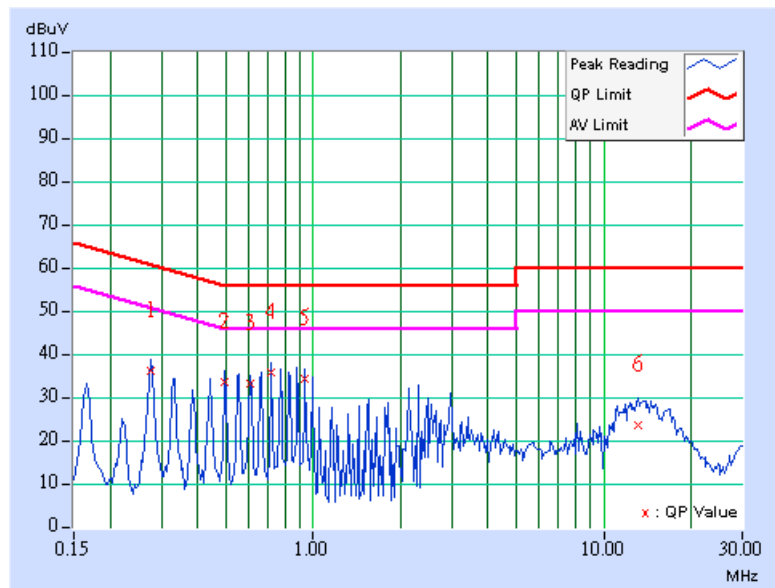

EUT TEST CONDITION		MEASUREMENT DETAIL	
CHANNEL	Channel 6	PHASE	Line 1
MODULATION TYPE	BPSK	6dB BANDWIDTH	9 kHz
TRANSFER RATE	6Mbps	INPUT POWER	120Vac, 60 Hz
ENVIRONMENTAL CONDITIONS	20deg. C, 60%RH, 1022hPa	TESTED BY	Match Tsui
TEST MODE	C		

No	Freq. [MHz]	Corr. Factor (dB)	Reading Value [dB (uV)]		Emission Level [dB (uV)]		Limit [dB (uV)]		Margin (dB)	
			Q.P.	AV.	Q.P.	AV.	Q.P.	AV.	Q.P.	AV.
1	0.150	0.12	39.80	-	39.92	-	66.00	56.00	-26.08	-
2	0.213	0.13	43.64	-	43.77	-	63.11	53.11	-19.34	-
3	0.427	0.14	37.06	-	37.20	-	57.30	47.30	-20.10	-
4	0.642	0.15	35.57	-	35.72	-	56.00	46.00	-20.28	-
5	5.770	0.49	35.88	-	36.37	-	60.00	50.00	-23.63	-
6	21.871	1.41	42.12	-	43.53	-	60.00	50.00	-16.47	-

- REMARKS:**
1. Q.P. and AV. are abbreviations of quasi-peak and average individually.
  2. "-": The Quasi-peak reading value also meets average limit and measurement with the average detector is unnecessary.
  3. The emission levels of other frequencies were very low against the limit.
  4. Margin value = Emission level - Limit value
  5. Correction factor = Insertion loss + Cable loss
  6. Emission Level = Correction Factor + Reading Value.

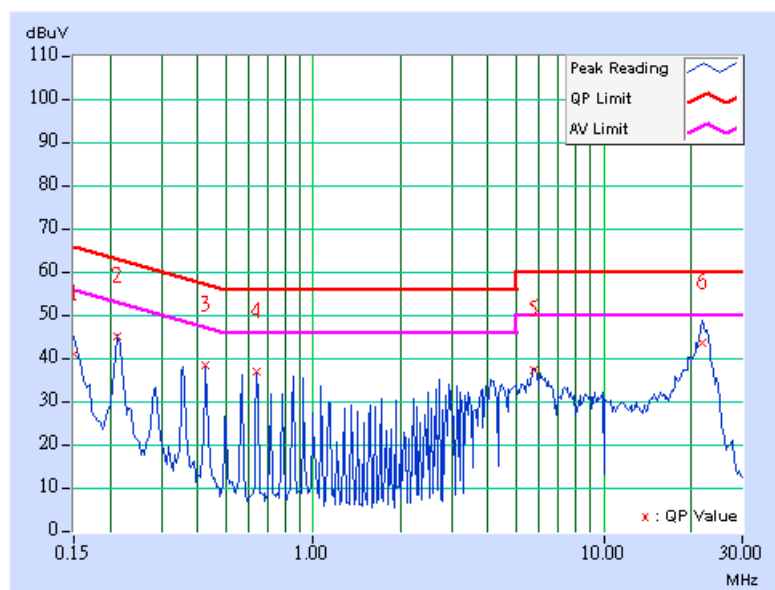

EUT TEST CONDITION		MEASUREMENT DETAIL	
CHANNEL	Channel 6	PHASE	Line 2
MODULATION TYPE	BPSK	6dB BANDWIDTH	9 kHz
TRANSFER RATE	6Mbps	INPUT POWER	120Vac, 60 Hz
ENVIRONMENTAL CONDITIONS	20deg. C, 60%RH, 1022hPa	TESTED BY	Match Tsui
TEST MODE	C		

No	Freq. [MHz]	Corr. Factor (dB)	Reading Value [dB (uV)]		Emission Level [dB (uV)]		Limit [dB (uV)]		Margin (dB)	
			Q.P.	AV.	Q.P.	AV.	Q.P.	AV.	Q.P.	AV.
1	0.150	0.14	39.46	-	39.60	-	66.00	56.00	-26.40	-
2	0.213	0.14	43.76	-	43.90	-	63.11	53.11	-19.21	-
3	0.427	0.15	36.55	-	36.70	-	57.30	47.30	-20.60	-
4	0.927	0.18	34.79	-	34.97	-	56.00	46.00	-21.03	-
5	4.059	0.43	35.77	-	36.20	-	56.00	46.00	-19.80	-
6	21.855	0.98	42.22	-	43.20	-	60.00	50.00	-16.80	-

- REMARKS:**
1. Q.P. and AV. are abbreviations of quasi-peak and average individually.
  2. "-": The Quasi-peak reading value also meets average limit and measurement with the average detector is unnecessary.
  3. The emission levels of other frequencies were very low against the limit.
  4. Margin value = Emission level - Limit value
  5. Correction factor = Insertion loss + Cable loss
  6. Emission Level = Correction Factor + Reading Value.

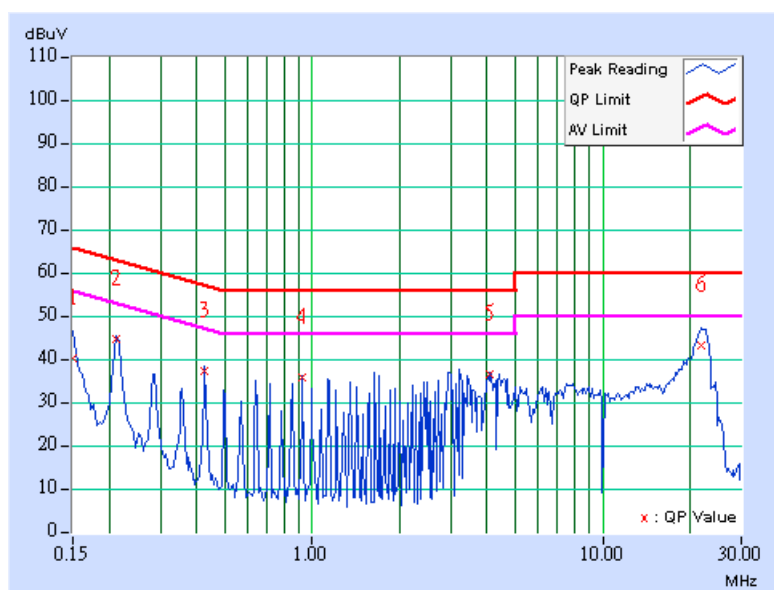

EUT TEST CONDITION		MEASUREMENT DETAIL	
CHANNEL	Channel 6	PHASE	Line 1
MODULATION TYPE	BPSK	6dB BANDWIDTH	9 kHz
TRANSFER RATE	6Mbps	INPUT POWER	120Vac, 60 Hz
ENVIRONMENTAL CONDITIONS	25deg. C, 72%RH, 1023hPa	TESTED BY	Long Chen
TEST MODE	D		

No	Freq. [MHz]	Corr.	Reading Value		Emission Level		Limit		Margin	
		Factor (dB)	Q.P. [dB (uV)]	AV. [dB (uV)]	Q.P. [dB (uV)]	AV. [dB (uV)]	Q.P. [dB (uV)]	AV. [dB (uV)]	Q.P. (dB)	AV. (dB)
1	0.166	0.13	36.89	-	37.02	-	65.18	55.18	-28.16	-
2	0.498	0.14	38.68	-	38.82	-	56.04	46.04	-17.21	-
<b>3</b>	<b>0.720</b>	<b>0.16</b>	<b>39.31</b>	-	<b>39.47</b>	-	<b>56.00</b>	<b>46.00</b>	<b>-16.53</b>	-
4	0.884	0.16	39.23	-	39.39	-	56.00	46.00	-16.61	-
5	2.266	0.28	34.83	-	35.11	-	56.00	46.00	-20.89	-
6	12.285	0.73	32.94	-	33.67	-	60.00	50.00	-26.33	-

- REMARKS:**
1. Q.P. and AV. are abbreviations of quasi-peak and average individually.
  2. "-": The Quasi-peak reading value also meets average limit and measurement with the average detector is unnecessary.
  3. The emission levels of other frequencies were very low against the limit.
  4. Margin value = Emission level - Limit value
  5. Correction factor = Insertion loss + Cable loss
  6. Emission Level = Correction Factor + Reading Value.

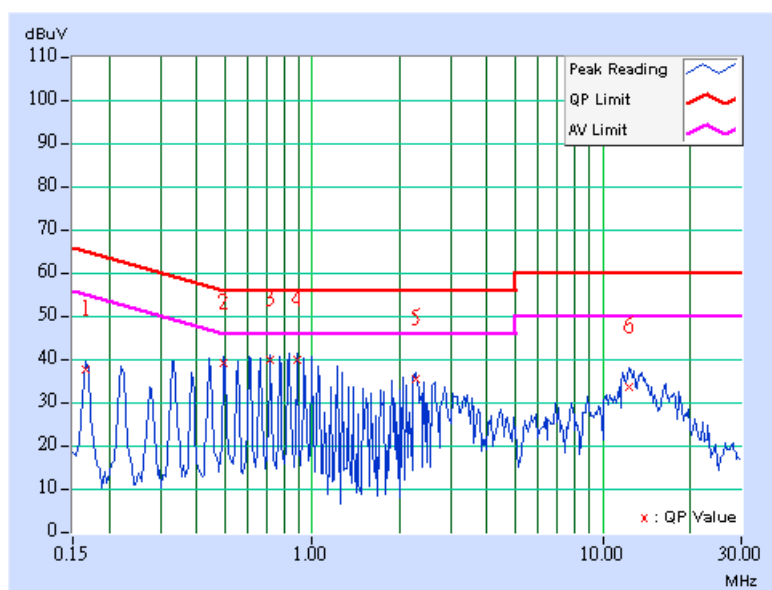

EUT TEST CONDITION		MEASUREMENT DETAIL	
CHANNEL	Channel 6	PHASE	Line 2
MODULATION TYPE	BPSK	6dB BANDWIDTH	9 kHz
TRANSFER RATE	6Mbps	INPUT POWER	120Vac, 60 Hz
ENVIRONMENTAL CONDITIONS	25deg. C, 72%RH, 1023hPa	TESTED BY	Long Chen
TEST MODE	D		

No	Freq. [MHz]	Corr. Factor (dB)	Reading Value [dB (uV)]		Emission Level [dB (uV)]		Limit [dB (uV)]		Margin (dB)	
			Q.P.	AV.	Q.P.	AV.	Q.P.	AV.	Q.P.	AV.
1	0.167	0.14	38.55	-	38.69	-	65.11	55.11	-26.42	-
2	0.443	0.15	36.31	-	36.46	-	57.01	47.01	-20.54	-
3	0.662	0.16	36.39	-	36.55	-	56.00	46.00	-19.45	-
4	0.834	0.17	37.73	-	37.90	-	56.00	46.00	-18.10	-
5	0.998	0.18	37.87	-	38.05	-	56.00	46.00	-17.95	-
6	12.793	0.65	29.40	-	30.05	-	60.00	50.00	-29.95	-

- REMARKS:**
1. Q.P. and AV. are abbreviations of quasi-peak and average individually.
  2. "-": The Quasi-peak reading value also meets average limit and measurement with the average detector is unnecessary.
  3. The emission levels of other frequencies were very low against the limit.
  4. Margin value = Emission level - Limit value
  5. Correction factor = Insertion loss + Cable loss
  6. Emission Level = Correction Factor + Reading Value.

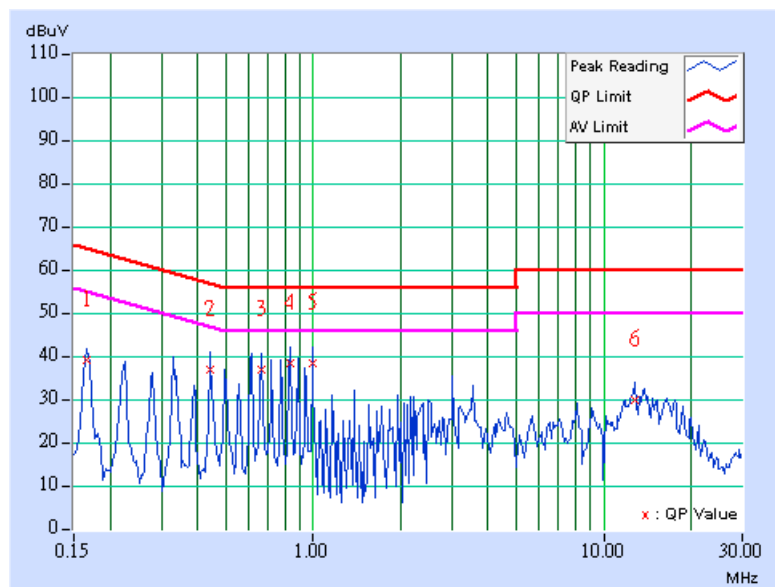



### 4.3 6dB BANDWIDTH MEASUREMENT

#### 4.3.1 LIMITS OF 6dB BANDWIDTH MEASUREMENT

The minimum of 6dB Bandwidth Measurement is 0.5 MHz.

#### 4.3.2 TEST INSTRUMENTS

DESCRIPTION & MANUFACTURER	MODEL NO.	SERIAL NO.	DATE OF CALIBRATION	DUE DATE OF CALIBRATION
SPECTRUM ANALYZER	FSP 40	100041	Apr. 22, 2008	Apr. 21, 2009

**NOTE:** The calibration interval of the above test instruments is 12 months and the calibrations are traceable to NML/ROC and NIST/USA.

#### 4.3.3 TEST PROCEDURE

The transmitter output was connected to the spectrum analyzer through an attenuator. The bandwidth of the fundamental frequency was measured by spectrum analyzer with 100kHz RBW and 300kHz VBW. The 6dB bandwidth is defined as the total spectrum the power of which is higher than peak power minus 6dB.

#### 4.3.4 DEVIATION FROM TEST STANDARD

No deviation

#### 4.3.5 TEST SETUP

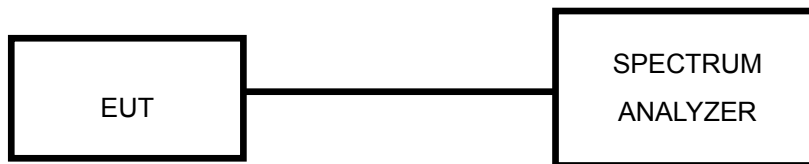

#### 4.3.6 EUT OPERATING CONDITIONS

The software provided by client to enable the EUT under transmission condition continuously at lowest, middle and highest channel frequencies individually.

### 4.3.7 TEST RESULTS

#### 802.11b DSSS MODULATION

<b>MODULATION TYPE</b>	DBPSK	<b>TRANSFER RATE</b>	1Mbps
<b>INPUT POWER</b>	120Vac, 60 Hz	<b>ENVIRONMENTAL CONDITIONS</b>	23deg. C, 66%RH, 1023hPa
<b>TESTED BY</b>	Match Tsui		

CHANNEL	CHANNEL FREQUENCY (MHz)	6dB BANDWIDTH (MHz)	MINIMUM LIMIT (MHz)	PASS/FAIL
1	2412	10.07	0.5	PASS
6	2437	10.06	0.5	PASS
11	2462	10.07	0.5	PASS

#### CH 1

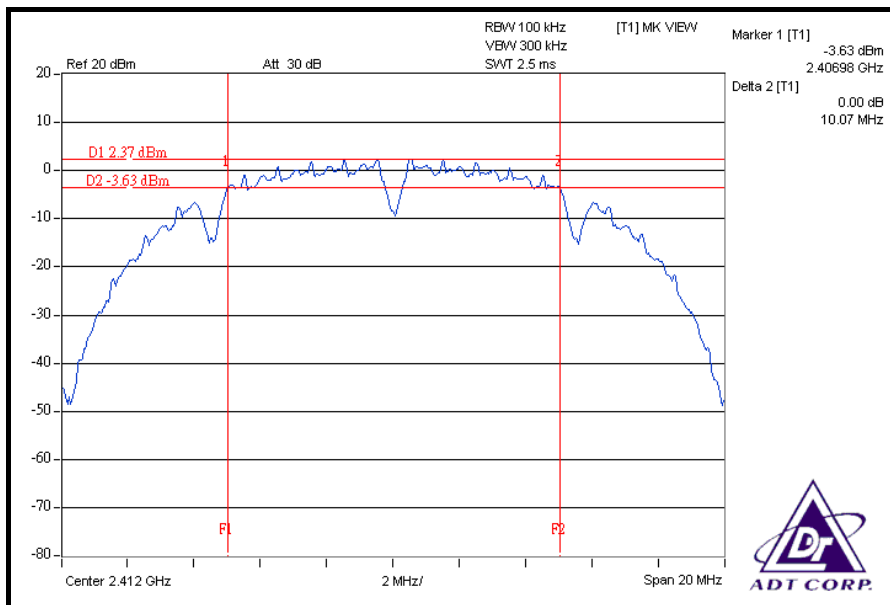







### CH 6

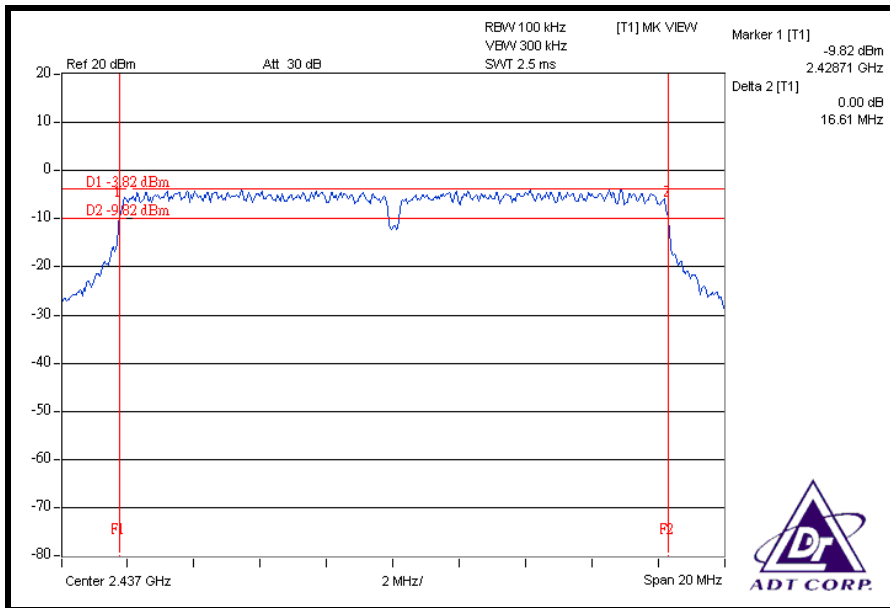

### CH 11

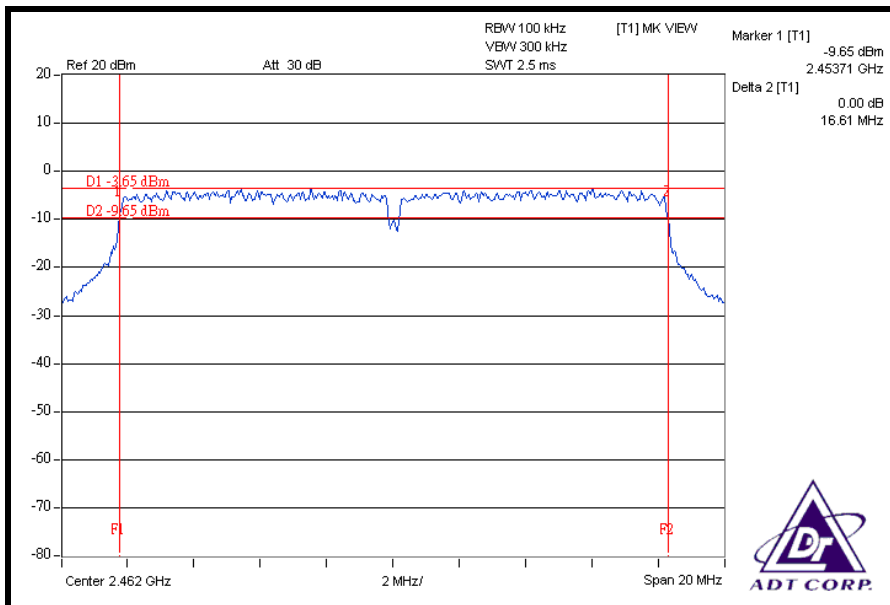

#### 4.4 MAXIMUM PEAK OUTPUT POWER

##### 4.4.1 LIMITS OF MAXIMUM PEAK OUTPUT POWER MEASUREMENT

The Maximum Peak Output Power Measurement is 30dBm.

##### 4.4.2 TEST INSTRUMENTS

DESCRIPTION & MANUFACTURER	MODEL NO.	SERIAL NO.	DATE OF CALIBRATION	DUE DATE OF CALIBRATION
HIGH SPEED PEAK POWER METER	ML2495A	0824012	Aug. 04, 2008	Aug. 03, 2009
POWER SENSOR	MA2444B	0738138	Aug. 04, 2008	Aug. 03, 2009

**NOTE:** 1. The calibration interval of the above test instruments is 12 months and the calibrations are traceable to NML/ROC and NIST/USA.  
 2. Measurement Bandwidth of ML2495A is 65MHz greater than 6dB bandwidth of emission.

##### 4.4.3 TEST PROCEDURES

A power sensor was used on the output port of the EUT. A power meter was used to read the response of the power sensor. Record the power level.

##### 4.4.4 DEVIATION FROM TEST STANDARD

No deviation

##### 4.4.5 TEST SETUP

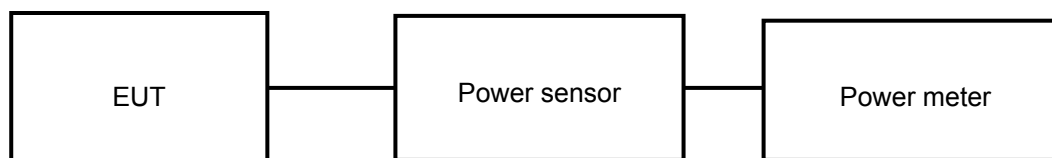

##### 4.4.6 EUT OPERATING CONDITIONS

Same as Item 4.3.6

#### 4.4.7 TEST RESULTS

##### 802.11b DSSS MODULATION

<b>MODULATION TYPE</b>	DBPSK	<b>TRANSFER RATE</b>	1Mbps
<b>INPUT POWER</b>	120Vac, 60 Hz	<b>ENVIRONMENTAL CONDITIONS</b>	23deg. C, 66%RH, 1023hPa
<b>TESTED BY</b>	Match Tsui		

CHANNEL	CHANNEL FREQUENCY (MHz)	PEAK POWER OUTPUT (mW)	PEAK POWER OUTPUT (dBm)	PEAK POWER LIMIT (dBm)	PASS/FAIL
1	2412	56.624	17.53	30	PASS
6	2437	57.677	17.61	30	PASS
11	2462	57.016	17.56	30	PASS

##### 802.11g OFDM MODULATION

<b>MODULATION TYPE</b>	BPSK	<b>TRANSFER RATE</b>	6Mbps
<b>INPUT POWER</b>	120Vac, 60 Hz	<b>ENVIRONMENTAL CONDITIONS</b>	23deg. C, 66%RH, 1023hPa
<b>TESTED BY</b>	Match Tsui		

CHANNEL	CHANNEL FREQUENCY (MHz)	PEAK POWER OUTPUT (mW)	PEAK POWER OUTPUT (dBm)	PEAK POWER LIMIT (dBm)	PASS/FAIL
1	2412	80.168	19.04	30	PASS
6	2437	80.910	19.08	30	PASS
11	2462	79.799	19.02	30	PASS



## 4.5 POWER SPECTRAL DENSITY MEASUREMENT

### 4.5.1 LIMITS OF POWER SPECTRAL DENSITY MEASUREMENT

The Maximum of Power Spectral Density Measurement is 8dBm.

### 4.5.2 TEST INSTRUMENTS

DESCRIPTION & MANUFACTURER	MODEL NO.	SERIAL NO.	DATE OF CALIBRATION	DUE DATE OF CALIBRATION
SPECTRUM ANALYZER	FSP 40	100041	Apr. 22, 2008	Apr. 21, 2009

**NOTE:** The calibration interval of the above test instruments is 12 months and the calibrations are traceable to NML/ROC and NIST/USA.

### 4.5.3 TEST PROCEDURE

The transmitter output was connected to the spectrum analyzer through an attenuator, the bandwidth of the fundamental frequency was measured with the spectrum analyzer using 3kHz RBW and 30kHz VBW, set sweep time = span/1.5MHz. The power spectral density was measured and recorded.

The sweep time is allowed to be longer than span/3kHz for a full response of the mixer in the spectrum analyzer.

### 4.5.4 DEVIATION FROM TEST STANDARD

No deviation

#### 4.5.5 TEST SETUP

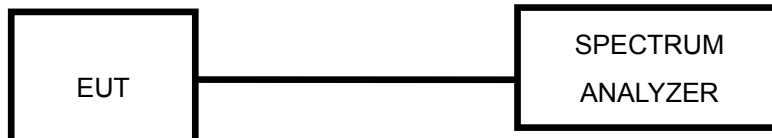

#### 4.5.6 EUT OPERATING CONDITION

Same as Item 4.3.6

## 4.5.7 TEST RESULTS

### 802.11b DSSS MODULATION

<b>MODULATION TYPE</b>	DBPSK	<b>TRANSFER RATE</b>	1Mbps
<b>INPUT POWER</b>	120Vac, 60 Hz	<b>ENVIRONMENTAL CONDITIONS</b>	23deg. C, 66%RH, 1023hPa
<b>TESTED BY</b>	Match Tsui		

CHANNEL	CHANNEL FREQUENCY (MHz)	RF POWER LEVEL IN 3kHz BW (dBm)	MAXIMUM LIMIT (dBm)	PASS/FAIL
1	2412	-15.75	8	PASS
6	2437	-15.74	8	PASS
11	2462	-15.72	8	PASS

### CH 1

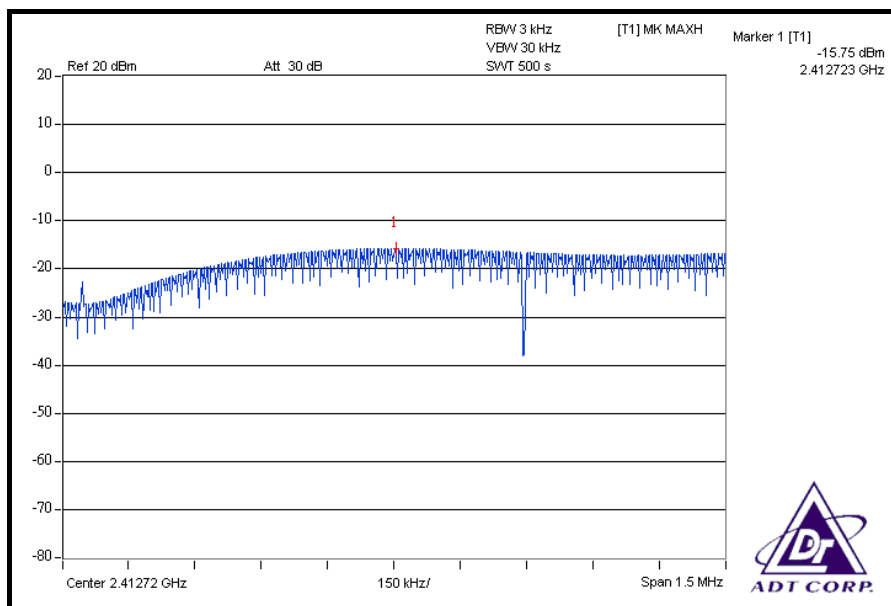



### CH 6

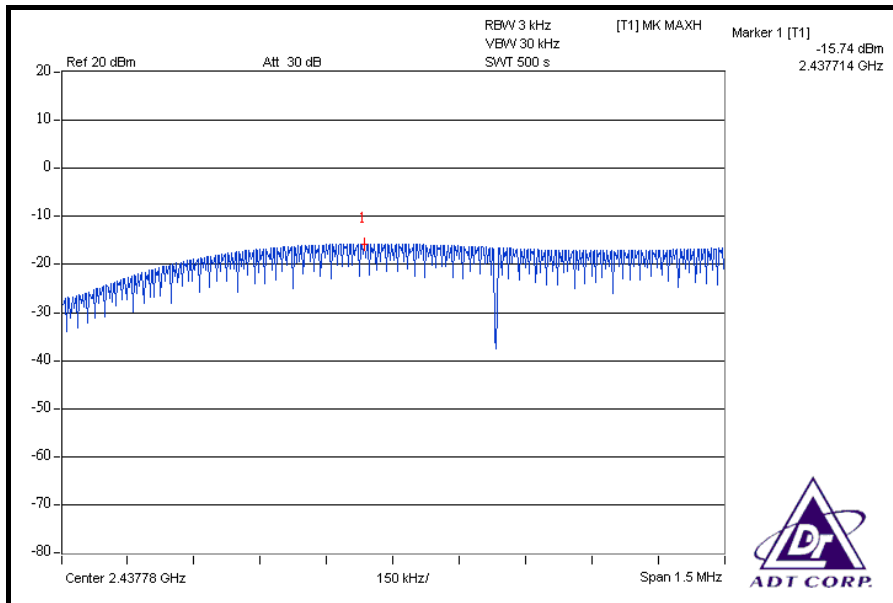

### CH 11

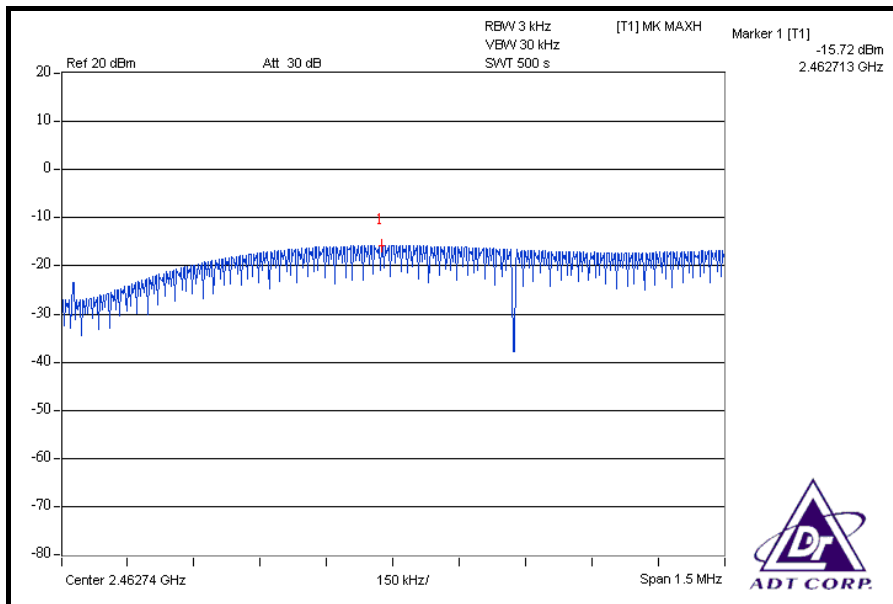







## 4.6 BAND EDGES MEASUREMENT

### 4.6.1 LIMITS OF BAND EDGES MEASUREMENT

Below -20dB of the highest emission level of operating band (in 100kHz Resolution Bandwidth).

### 4.6.2 TEST INSTRUMENTS

DESCRIPTION & MANUFACTURER	MODEL NO.	SERIAL NO.	DATE OF CALIBRATION	DUE DATE OF CALIBRATION
SPECTRUM ANALYZER	FSP 40	100041	Apr. 22, 2008	Apr. 21, 2009

**NOTE:** The calibration interval of the above test instruments is 12 months and the calibrations are traceable to NML/ROC and NIST/USA.

### 4.6.3 TEST PROCEDURE

The transmitter output was connected to the spectrum analyzer via a low lose cable. Set both RBW and VBW of spectrum analyzer to 100 kHz and 300 kHz with suitable frequency span including 100 MHz bandwidth from band edge. The band edges was measured and recorded.

The spectrum plots (Peak RBW=100kHz, VBW=300kHz; Average RBW=1MHz, VBW=10Hz) are attached on the following pages.

### 4.6.4 DEVIATION FROM TEST STANDARD

No deviation

### 4.6.5 EUT OPERATING CONDITION

Same as Item 4.3.6

#### 4.6.6 TEST RESULTS

The spectrum plots are attached on the following 12 images. D1 line indicates the highest level, and D2 line indicates the 20dB offset below D1. It shows compliance with the requirement in part 15.247(d).

#### 802.11b DSSS MODULATION

**NOTE 1:** The band edge emission plot on the next page shows 48.88dBc between carrier maximum power and local maximum emission in restrict band (2.36900GHz). The emission of carrier strength list in the test result of channel 1 at the item 4.1.7 is 102.38dBuV/m (Peak), so the maximum field strength in restrict band is  $102.38 - 48.88 = 53.50$ dBuV/m which is under 74dBuV/m limit.

The band edge emission plot on the next page shows 53.86dBc between carrier maximum power and local maximum emission in restrict band (2.32320GHz). The emission of carrier strength list in the test result of channel 1 at the item 4.1.7 is 98.00dBuV/m (Average), so the maximum field strength in restrict band is  $98.00 - 53.86 = 44.14$ dBuV/m which is under 54dBuV/m limit.

**NOTE 2:** The band edge emission plot on the next second page shows 49.43dBc between carrier maximum power and local maximum emission in restrict band (2.49920GHz). The emission of carrier strength list in the test result of channel 11 at the item 4.2.7 is 102.62dBuV/m (Peak), so the maximum field strength in restrict band is  $102.62 - 49.43 = 53.19$ dBuV/m which is under 74dBuV/m limit.

The band edge emission plot on the next third page shows 59.00dBc between carrier maximum power and local maximum emission in restrict band (2.50000GHz). The emission of carrier strength list in the test result of channel 11 at the item 4.1.7 is 98.20dBuV/m (Average), so the maximum field strength in restrict band is  $98.20 - 59.00 = 39.20$ dBuV/m which is under 54dBuV/m limit.

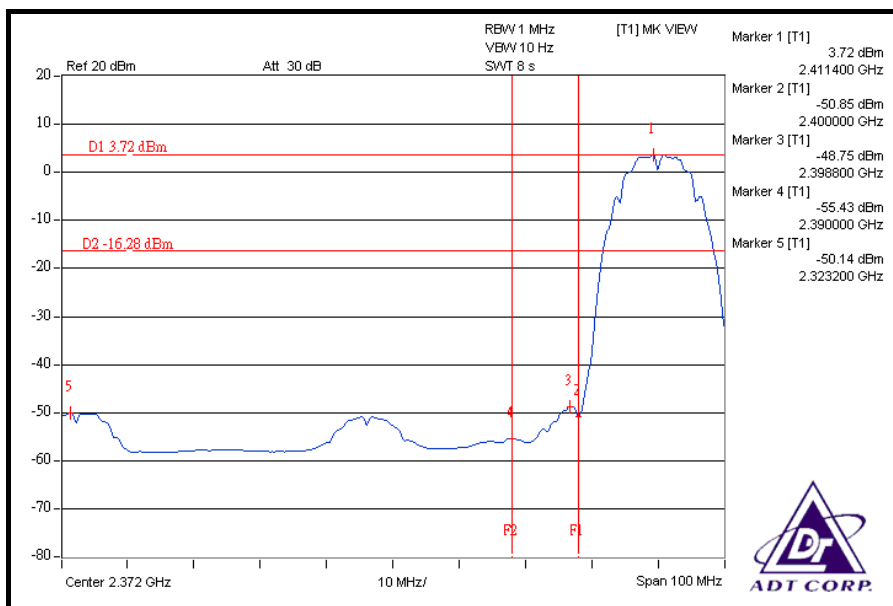
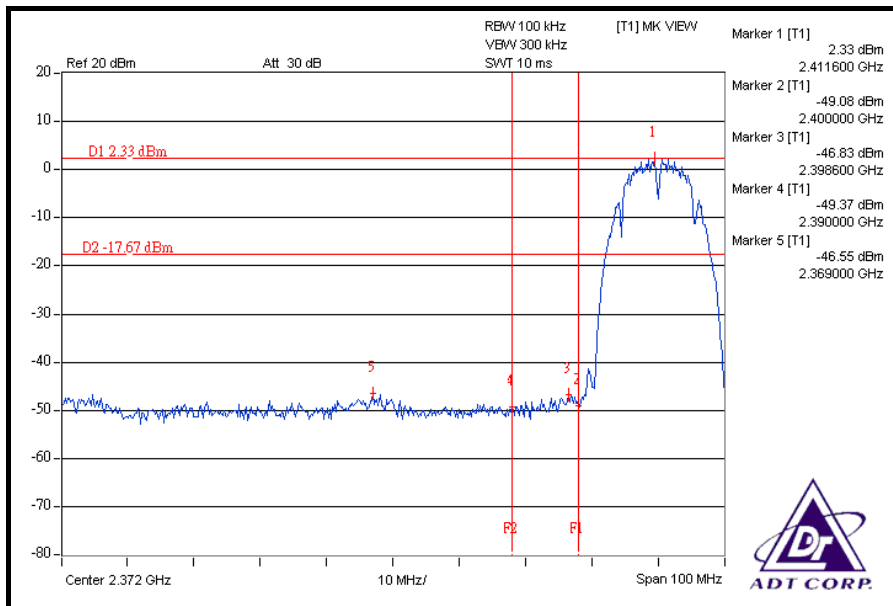

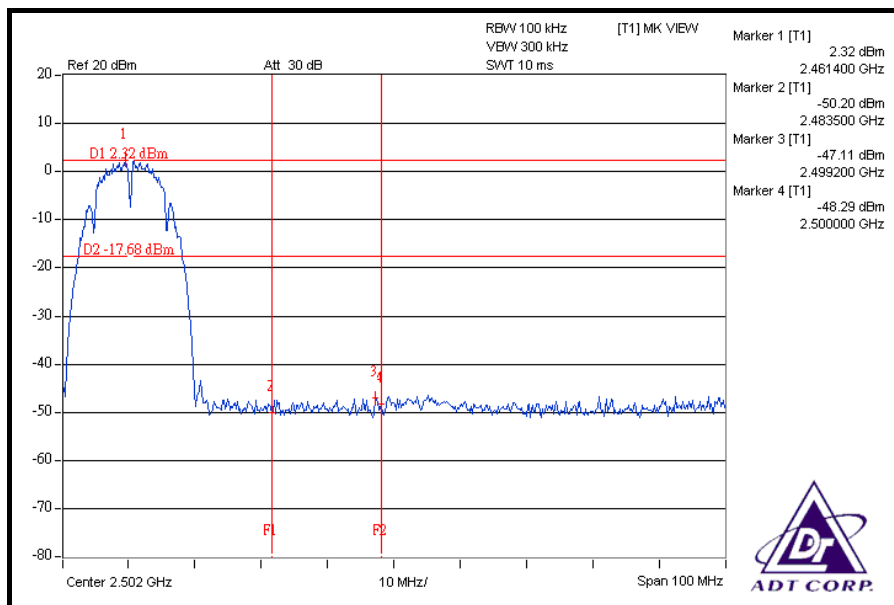
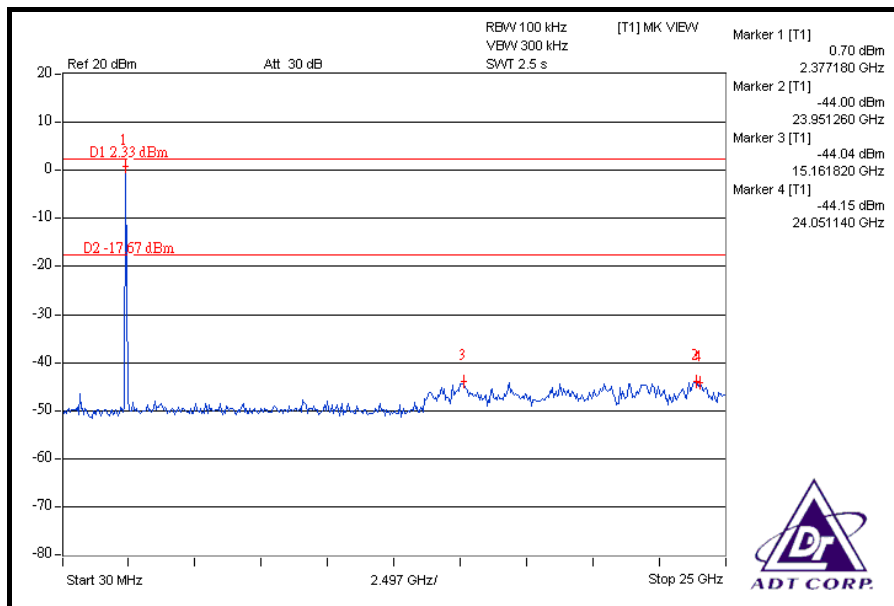

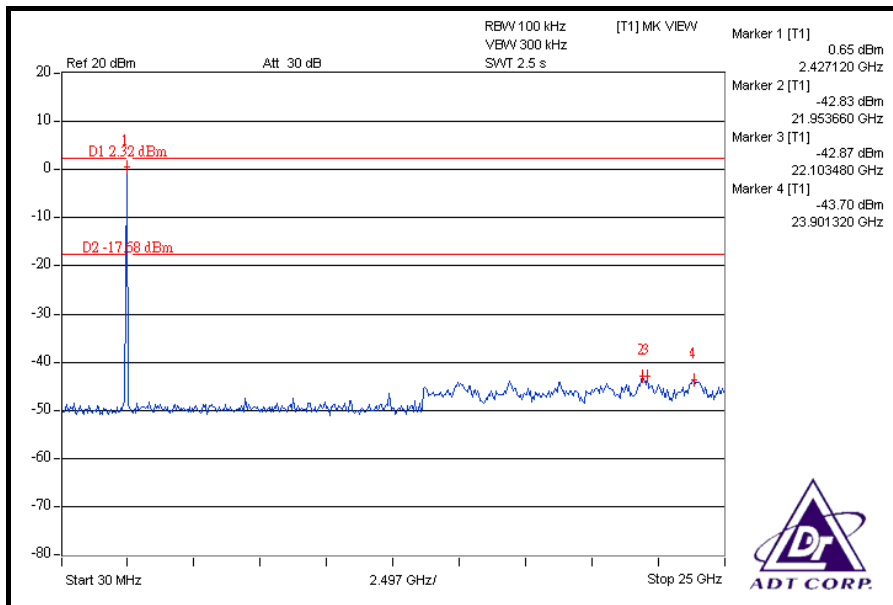
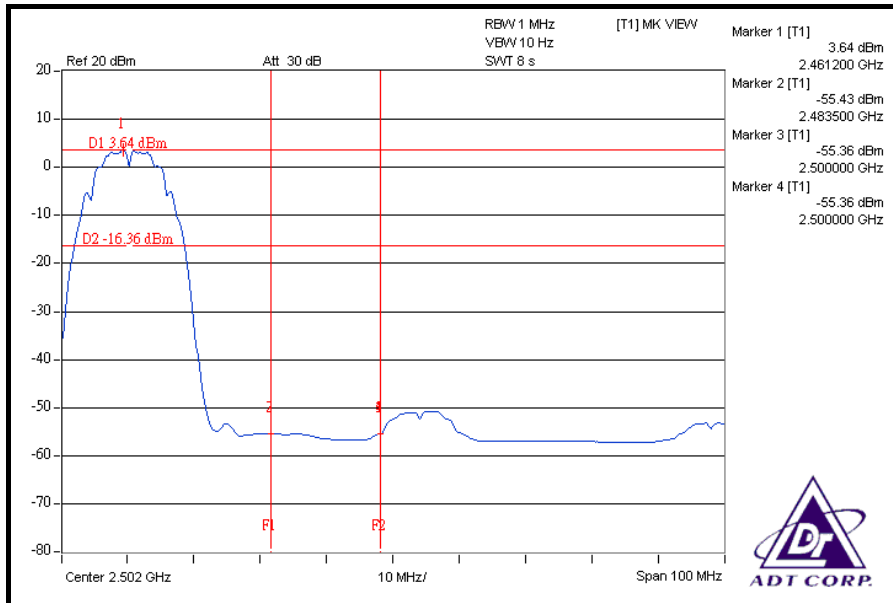



## 802.11g OFDM MODULATION

**NOTE 1:** The band edge emission plot on the next page shows 37.99dBc between carrier maximum power and local maximum emission in restrict band (2.39000GHz). The emission of carrier strength list in the test result of channel 1 at the item 4.1.7 is 100.28dBuV/m (Peak), so the maximum field strength in restrict band is  $100.28 - 37.99 = 62.29$ dBuV/m which is under 74dBuV/m limit.

The band edge emission plot on the next page shows 44.95dBc between carrier maximum power and local maximum emission in restrict band (2.39000GHz). The emission of carrier strength list in the test result of channel 1 at the item 4.1.7 is 90.28dBuV/m (Average), so the maximum field strength in restrict band is  $90.28 - 44.95 = 45.33$ dBuV/m which is under 54dBuV/m limit.

**NOTE 2:** The band edge emission plot on the next second page shows 41.80dBc between carrier maximum power and local maximum emission in restrict band (2.48740GHz). The emission of carrier strength list in the test result of channel 11 at the item 4.1.7 is 100.41dBuV/m (Peak), so the maximum field strength in restrict band is  $100.41 - 41.80 = 58.61$ dBuV/m which is under 74dBuV/m limit.

The band edge emission plot on the next third page shows 50.84dBc between carrier maximum power and local maximum emission in restrict band (2.48350GHz). The emission of carrier strength list in the test result of channel 11 at the item 4.1.7 is 90.18dBuV/m (Average), so the maximum field strength in restrict band is  $90.18 - 50.84 = 39.34$ dBuV/m which is under 54dBuV/m limit.

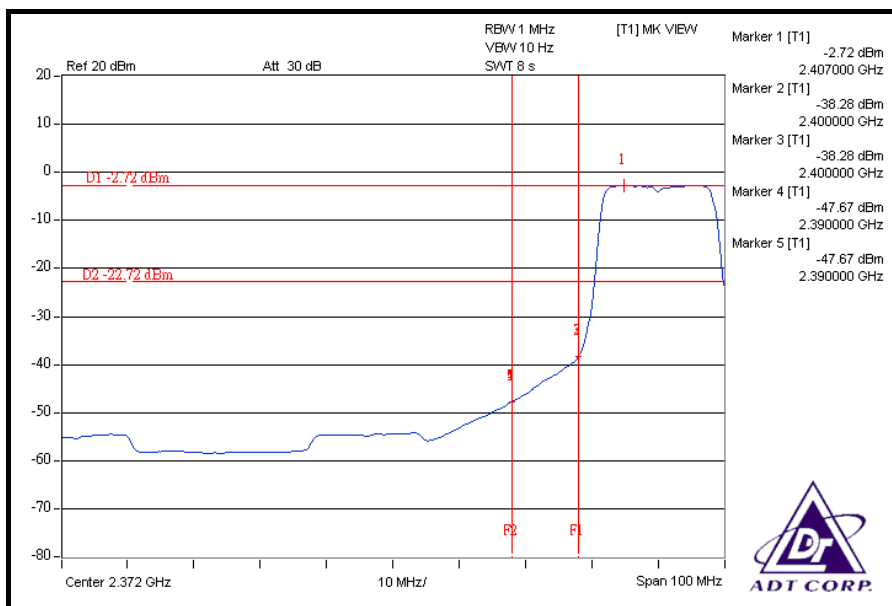
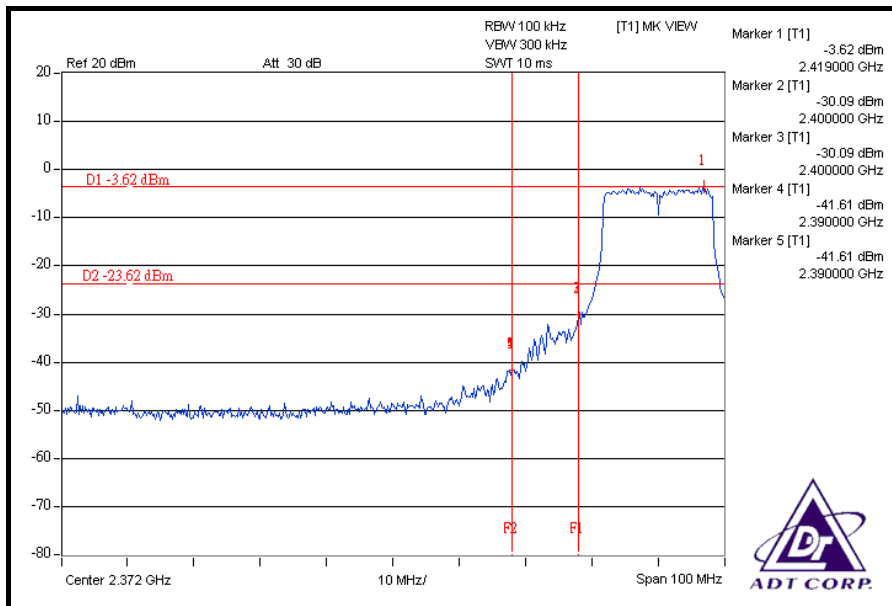

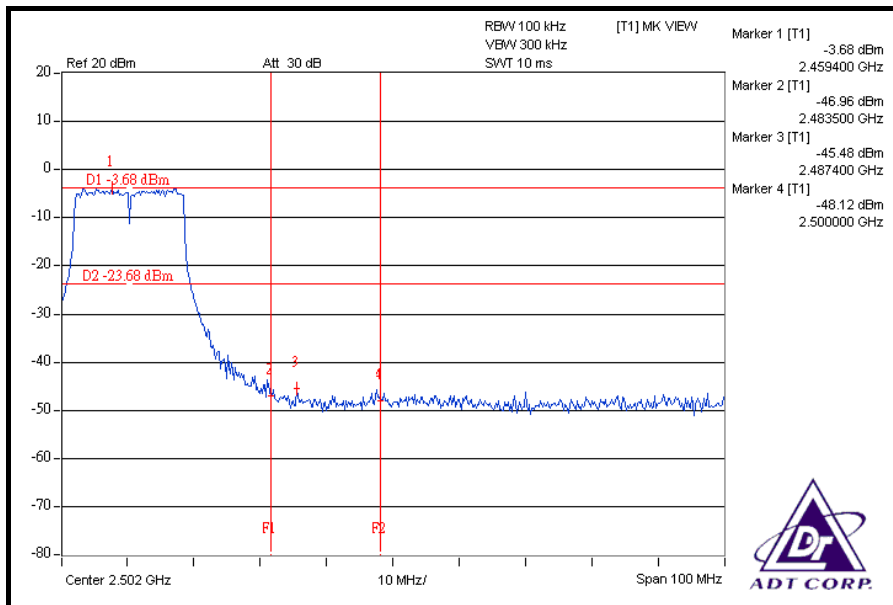
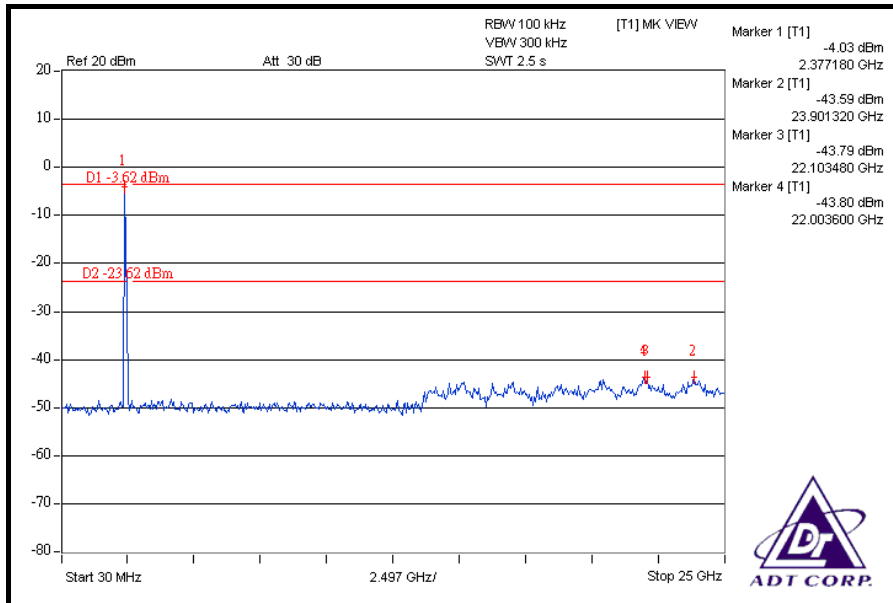

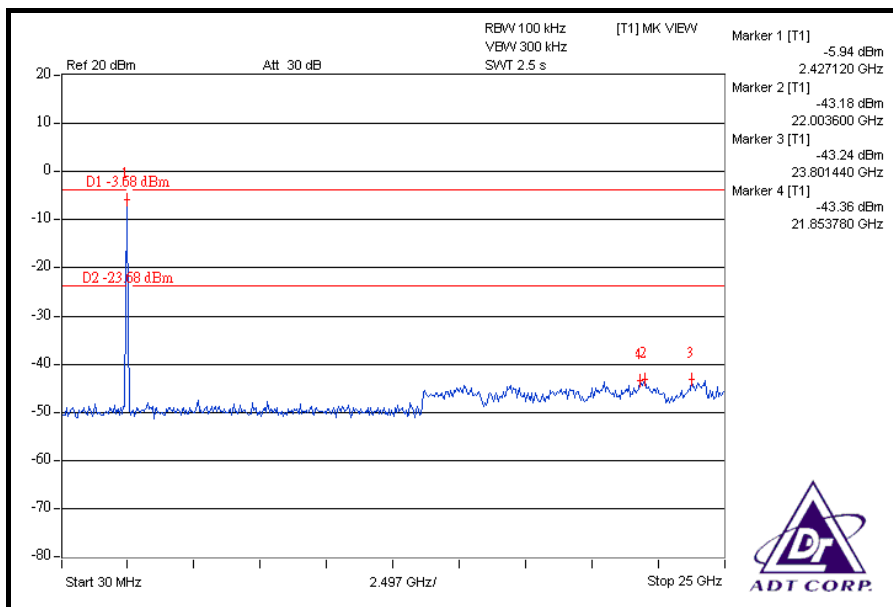
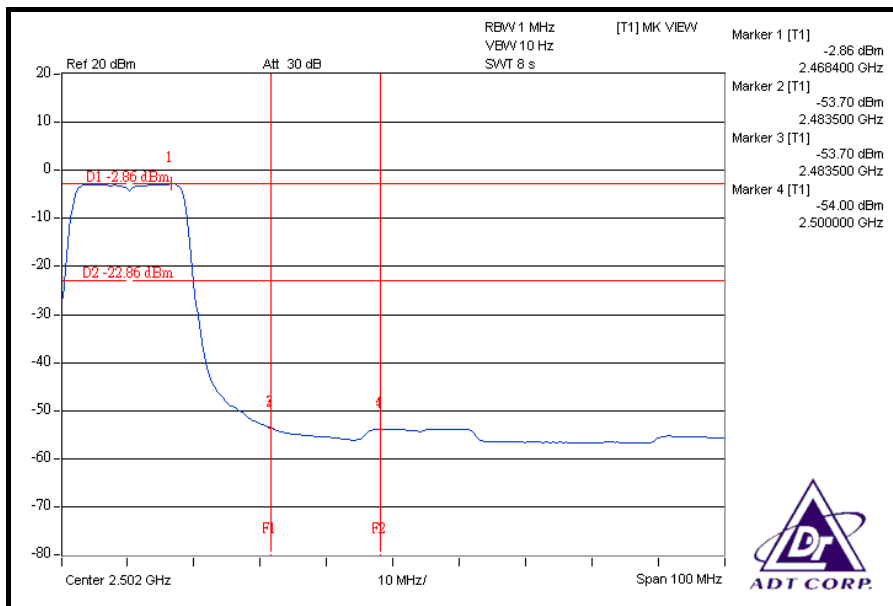



## **4.7 ANTENNA REQUIREMENT**

### **4.7.1 STANDARD APPLICABLE**

For intentional device, according to FCC 47 CFR Section 15.203, an intentional radiator shall be designed to ensure that no antenna other than that furnished by the responsible party shall be used with the device. And according to FCC 47 CFR Section 15.247 (b), if transmitting antennas of directional gain greater than 6dBi are used, the power shall be reduced by the amount in dB that the directional gain of the antenna exceeds 6dBi.

### **4.7.2 ANTENNA CONNECTED CONSTRUCTION**

The antenna used in this product is PIFA antenna without connector. The maximum Gain of the antenna is -0.95dBi.



## **5. PHOTOGRAPHS OF THE TEST CONFIGURATION**

Please refer to the attached file (Test Setup Photo).



## 6. INFORMATION ON THE TESTING LABORATORIES

We, ADT Corp., were founded in 1988 to provide our best service in EMC, Radio, Telecom and Safety consultation. Our laboratories are accredited and approved by the following approval agencies according to ISO/IEC 17025.

<b>USA</b>	FCC, UL
<b>GERMANY</b>	TUV Rheinland
<b>JAPAN</b>	VCCI
<b>NORWAY</b>	NEMKO
<b>CANADA</b>	INDUSTRY CANADA , CSA
<b>R.O.C.</b>	TAF, BSMI, NCC
<b>NETHERLANDS</b>	Telefication
<b>SINGAPORE</b>	GOST-ASIA (MOU)
<b>RUSSIA</b>	CERTIS (MOU)

Copies of accreditation certificates of our laboratories obtained from approval agencies can be downloaded from our web site: [www.adt.com.tw/index.5/phtml](http://www.adt.com.tw/index.5/phtml).  
If you have any comments, please feel free to contact us at the following:

**Linko EMC/RF Lab:**  
Tel: 886-2-26052180  
Fax: 886-2-26051924

**Hsin Chu EMC/RF Lab:**  
Tel: 886-3-5935343  
Fax: 886-3-5935342

**Hwa Ya EMC/RF/Safety Telecom Lab:**  
Tel: 886-3-3183232  
Fax: 886-3-3185050

**Web Site:** [www.adt.com.tw](http://www.adt.com.tw)

The address and road map of all our labs can be found in our web site also.



## **7. APPENDIX A - MODIFICATIONS RECORDERS FOR ENGINEERING CHANGES TO THE EUT BY THE LAB**

No any modifications are made to the EUT by the lab during the test.

**---END---**