



FCC TEST REPORT (15.407)

REPORT NO.: RF940609L03
MODEL NO.: TA1 (with Intel WM3B2915ABG)
RECEIVED: Jun. 27, 2005
TESTED: Jun. 16 ~ Jun. 22, 2005
ISSUED: Jun. 27, 2005

APPLICANT: QUANTA COMPUTER INC.

ADDRESS: 7F, 116, Hou Kang St., Shih Lin, Taipei,
Taiwan, R.O.C.

ISSUED BY: Advance Data Technology Corporation

LAB ADDRESS: No. 47, 14th Ling, Chia Pau Tsuen, Lin Kou
Hsiang 244, Taipei Hsien, Taiwan, R.O.C.

TEST LOCATION: No. 19, Hwa Ya 2nd Rd., Wen Hwa Tsuen, Kwei
Shan Hsiang, Taoyuan Hsien 333, Taiwan,
R.O.C.

This test report consists of 61 pages in total. It may be duplicated completely for legal use with the approval of the applicant. It should not be reproduced except in full, without the written approval of our laboratory. The client should not use it to claim product endorsement by CNLA, A2LA or any government agencies. The test results in the report only apply to the tested sample.



0528
ILAC MRA



No. 2177-01



Table of Contents

1.	CERTIFICATION	4
2.	SUMMARY OF TEST RESULTS	5
2.1	MEASUREMENT UNCERTAINTY	5
3.	GENERAL INFORMATION.....	6
3.1	GENERAL DESCRIPTION OF EUT.....	6
3.2	DESCRIPTION OF TEST MODES.....	8
3.2.1	CONFIGURATION OF SYSTEM UNDER TEST	9
3.2.2	TEST MODE APPLICABILITY AND TESTED CHANNEL DETAIL:.....	10
3.3	GENERAL DESCRIPTION OF APPLIED STANDARDS	12
3.4	DESCRIPTION OF SUPPORT UNITS	12
4.	TEST TYPES AND RESULTS (5150 ~ 5350MHz BAND)	13
4.1	CONDUCTED EMISSION MEASUREMENT	13
4.1.1	LIMITS OF CONDUCTED EMISSION MEASUREMENT.....	13
4.1.2	TEST INSTRUMENTS.....	13
4.1.3	TEST PROCEDURES	14
4.1.4	DEVIATION FROM TEST STANDARD	14
4.1.5	TEST SETUP	15
4.1.6	EUT OPERATING CONDITIONS	15
4.1.7	TEST RESULTS	16
4.2	RADIATED EMISSION MEASUREMENT	20
4.2.1	LIMITS OF RADIATED EMISSION MEASUREMENT.....	20
4.2.2	LIMITS OF UNWANTED EMISSION OUT OF THE RESTRICTED BANDS.....	21
4.2.3	TEST INSTRUMENTS.....	22
4.2.4	TEST PROCEDURES	23
4.2.5	DEVIATION FROM TEST STANDARD	23
4.2.6	TEST SETUP	24
4.2.7	EUT OPERATING CONDITION	24
4.2.8	TEST RESULTS	25
4.3	PEAK TRANSMIT POWER MEASUREMENT	31
4.3.1	LIMITS OF PEAK TRANSMIT POWER MEASUREMENT.....	31
4.3.2	TEST INSTRUMENTS.....	31
4.3.3	TEST PROCEDURE.....	32
4.3.4	DEVIATION FROM TEST STANDARD	32
4.3.5	TEST SETUP	32
4.3.6	EUT OPERATING CONDITIONS	32
4.3.7	TEST RESULTS	33
4.4	PEAK POWER EXCURSION MEASUREMENT	38
4.4.1	LIMITS OF PEAK POWER EXCURSION MEASUREMENT.....	38
4.4.2	TEST INSTRUMENTS.....	38
4.4.3	TEST PROCEDURE.....	39
4.4.4	DEVIATION FROM TEST STANDARD	39
4.4.5	TEST SETUP	39
4.4.6	EUT OPERATING CONDITIONS	39
4.4.7	TEST RESULTS	40
4.5	PEAK POWER SPECTRAL DENSITY MEASUREMENT	43
4.5.1	LIMITS OF PEAK POWER SPECTRAL DENSITY MEASUREMENT.....	43
4.5.2	TEST INSTRUMENTS.....	43



4.5.3	TEST PROCEDURES	44
4.5.4	DEVIATION FROM TEST STANDARD	44
4.5.5	TEST SETUP	44
4.5.6	EUT OPERATING CONDITIONS	44
4.5.7	TEST RESULTS	45
4.6	FREQUENCY STABILITY	48
4.6.1	LIMITS OF FREQUENCY STABILITY MEASUREMENT	48
4.6.2	TEST INSTRUMENTS.....	48
4.6.3	TEST PROCEDURE.....	48
4.6.4	DEVIATION FROM TEST STANDARD	48
4.6.5	TEST SETUP	49
4.6.6	EUT OPERATING CONDITION	49
4.6.7	TEST RESULTS	50
4.7	BAND EDGES MEASUREMENT	51
4.7.1	TEST INSTRUMENTS.....	51
4.7.2	TEST PROCEDURE.....	51
4.7.3	EUT OPERATING CONDITION	51
4.7.4	TEST RESULTS	51
4.8	ANTENNA REQUIREMENT	56
4.8.1	STANDARD APPLICABLE	56
4.8.2	ANTENNA CONNECTED CONSTRUCTION.....	56
5.	PHOTOGRAPHS OF THE TEST CONFIGURATION.....	57
6.	INFORMATION ON THE TESTING LABORATORIES	61



1. CERTIFICATION

PRODUCT: notebook computer
BRAND NAME: Gateway
MODEL NO.: TA1 (with Intel WM3B2915ABG)
APPLICANT: QUANTA COMPUTER INC.
TEST SAMPLE: ENGINEERING SAMPLE
TESTED: Jun. 16 ~ Jun. 22, 2005
STANDARDS: FCC Part 15, Subpart E (Section 15.407)
ANSI C63.4-2003

The above equipment has been tested by **Advance Data Technology Corporation**, and found compliance with the requirement of the above standards. The test record, data evaluation & Equipment Under Test (EUT) configurations represented herein are true and accurate accounts of the measurements of the sample's EMC characteristics under the conditions specified in this report.

PREPARED BY : Andrea Hsia, **DATE:** Jun. 27, 2005
(Andrea Hsia)

TECHNICAL
ACCEPTANCE : Gary Chang, **DATE:** Jun. 27, 2005
Responsible for RF
(Gary Chang)

APPROVED BY : Cody Chang, **DATE:** Jun. 27, 2005
(Cody Chang, Deputy Manager)

2. SUMMARY OF TEST RESULTS

The EUT has been tested according to the following specifications:

APPLIED STANDARD: FCC Part 15, Subpart E (Section 15.407)			
Standard Section	Test Type	Result	Remark
15.407(b)(5)	AC Power Conducted Emission	PASS	Meet the requirement of limit. Minimum passing margin is -18.16dB at 0.158MHz
15.407(b/1/2/3) (b)(5)	Electric Field Strength Spurious Emissions, 30MHz ~ 40000MHz	PASS	Meet the requirement of limit. Minimum passing margin is -2.50dB at 159.33MHz
15.407(a/1/2/3)	Peak Transmit Power	PASS	Meet the requirement of limit.
15.407(a)(6)	Peak Power Excursion	PASS	Meet the requirement of limit.
15.407(a/1/2/3)	Peak Power Spectral Density	PASS	Meet the requirement of limit.
15.407(g)	Frequency Stability	PASS	Meet the requirement of limit.

2.1 MEASUREMENT UNCERTAINTY

Where relevant, the following measurement uncertainty levels have been estimated for tests performed on the EUT as specified in CISPR 16-4:

Measurement	Frequency	Uncertainty
Conducted emissions	9kHz~30MHz	2.44 dB
Radiated emissions	30MHz ~ 200MHz	3.73 dB
	200MHz ~1000MHz	3.74 dB
	1GHz ~ 18GHz	2.20 dB
	18GHz ~ 40GHz	1.88 dB



3. GENERAL INFORMATION

3.1 GENERAL DESCRIPTION OF EUT

EUT	notebook computer
MODEL NO.	TA1 (with Intel WM3B2915ABG)
POWER SUPPLY	19Vdc from AC adapter
MODULATION TYPE	CCK, DQPSK, DBPSK for DSSS 64QAM, 16QAM, QPSK, BPSK for OFDM
MODULATION TECHNOLOGY	DSSS, OFDM
TRANSFER RATE	802.11b: 11/5.5/2/1Mbps 802.11g: 54/48/36/24/18/12/9/6Mbps 802.11a: 54/48/36/24/18/12/9/6Mbps
FREQUENCY RANGE	802.11b & 802.11g: 2.412 ~ 2.462GHz 802.11a: 5.150 ~ 5.350GHz and 5.725 ~ 5.850GHz
NUMBER OF CHANNEL	802.11b & 802.11g: 11 802.11a: 13
CHANNEL SPACING	802.11b & 802.11g: 5MHz 802.11a: 20MHz
OUTPUT POWER	51.286mW for 802.11b 32.211mW for 802.11g 41.020mW for 5.150 ~ 5.350GHz 31.769mW for 5.725 ~ 5.850GHz
ANTENNA TYPE	Refer to Note 2 as below
DATA CABLE	NA
I/O PORTS	Refer to user's manual
ASSOCIATED DEVICES	NA

NOTE:

1. The EUT were tested with the following adapters:

BRAND	LITEON
MODEL	PA-1900-03
INPUT	100-240Vac, 50-60Hz, 1.6A
OUTPUT	19Vdc, 4.74A
POWER LINE	AC 1.8m non-shielded cable without core DC 1.8m non-shielded cable with one core

BRAND	LITEON
MODEL	PA-1650-01
INPUT	100-240Vac, 50-60Hz, 1.6A
OUTPUT	19Vdc, 3.42A
POWER LINE	AC 1.8m non-shielded cable without core DC 1.8m non-shielded cable with one core



2. The following antennas were provided to this EUT.

Antenna Type	P/N	Brand	Connector	Gain (dBi) 2.4GHz	5.0GHz	
					Frequency	Gain (dBi)
PIFA (Main Antenna)	WDAN- GQTA1 001	HON HAI	SGX	2.15	4500 ~ 5350 MHz	1.90
					5470 ~ 5785 MHz	1.26
PIFA (Aux. Antenna)	WDAN- GQTA1 001	HON HAI	SGX	1.95	4500 ~ 5350 MHz	0.65
					5470 ~ 5785 MHz	1.09

* We have tested for each type of antennas and chosen the highest gain of each type for worst case and presented in following section.

3. The EUT operates in both the 5GHz and 2.4GHz Bands and compatibility with 802.11a and 802.11b, 802.11g technology.
4. The EUT operates in the 2.4GHz frequency spectrum with throughput of up to 54Mbps.
5. The above EUT information was declared by the manufacturer and for more detailed features description, please refer to the manufacturer's specifications or User's Manual.

3.2 DESCRIPTION OF TEST MODES

Operated in 5150 ~ 5250MHz, 5250MHz ~ 5350MHz bands:

Eight channels are provided to this EUT.

Channel	Frequency
1	5180 MHz
2	5200 MHz
3	5220 MHz
4	5240 MHz
5	5260 MHz
6	5280 MHz
7	5300 MHz
8	5320 MHz

3.2.1 CONFIGURATION OF SYSTEM UNDER TEST

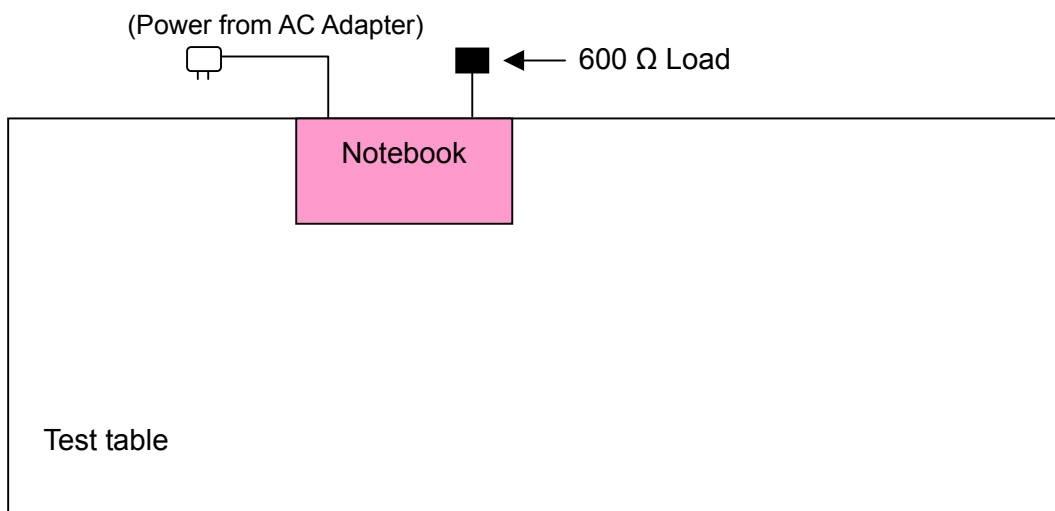



3.2.2 TEST MODE APPLICABILITY AND TESTED CHANNEL DETAIL:

EUT configure mode	Applicable to				Description
	PLC	RE<1G	RE≥1G	APCM	
1	√	√	Note 1	Note 2	Power from AC Adapter (PA-1900-03)
2	√	√	Note 1	Note 2	Power from AC Adapter (PA-1650-01)

Where PLC: Power Line Conducted Emission RE<1G RE: Radiated Emission below 1GHz
 RE≥1G: Radiated Emission above 1GHz APCM: Antenna Port Conducted Measurement

Note 1: No effect on Radiated Emission above 1GHz.

Note 2: No effect on Conducted RF measurement.

Power Line Conducted Emission Test:

- Pre-Scan has been conducted to determine the worst-case mode from all possible combinations between available modulations, data rates and antenna ports (if EUT with antenna diversity architecture).
- Following channel(s) was (were) selected for the final test as listed below.

EUT configure mode	Mode	Available Channel	Tested Channel	Modulation Technology	Modulation Type	Data Rate (Mbps)
1	802.11a	1 to 8	5	OFDM	BPSK	6
2	802.11a	1 to 8	5	OFDM	BPSK	6

Radiated Emission Test (Below 1 GHz):

- Pre-Scan has been conducted to determine the worst-case mode from all possible combinations between available modulations, data rates and antenna ports (if EUT with antenna diversity architecture).
- Following channel(s) was (were) selected for the final test as listed below.

EUT configure mode	Mode	Available Channel	Tested Channel	Modulation Technology	Modulation Type	Data Rate (Mbps)
1	802.11a	1 to 8	5	OFDM	BPSK	6
2	802.11a	1 to 8	5	OFDM	BPSK	6

Radiated Emission Test (Above 1 GHz):

- Pre-Scan has been conducted to determine the worst-case mode from all possible combinations between available modulations, data rates and antenna ports (if EUT with antenna diversity architecture).
- Following channel(s) was (were) selected for the final test as listed below.

EUT configure mode	Mode	Available Channel	Tested Channel	Modulation Technology	Modulation Type	Data Rate (Mbps)
1	802.11a	1 to 8	1, 4, 5, 8	OFDM	BPSK	6
2	802.11a	1 to 8	1, 4, 5, 8	OFDM	BPSK	6



Bandedge Measurement:

- Pre-Scan has been conducted to determine the worst-case mode from all possible combinations between available modulations, data rates and antenna ports (if EUT with antenna diversity architecture).
- Following channel(s) was (were) selected for the final test as listed below.

Mode	Available Channel	Tested Channel	Modulation Technology	Modulation Type	Data Rate (Mbps)
802.11a	1 to 8	1, 8	OFDM	BPSK	6

Antenna Port Conducted Measurement:

- Pre-Scan has been conducted to determine the worst-case mode from all possible combinations between available modulations, data rates and antenna ports (if EUT with antenna diversity architecture).
- Following channel(s) was (were) selected for the final test as listed below.

Mode	Available Channel	Tested Channel	Modulation Technology	Modulation Type	Data Rate (Mbps)
802.11a	1 to 8	1, 4, 5, 8	OFDM	BPSK	6



3.3 GENERAL DESCRIPTION OF APPLIED STANDARDS

The EUT is a notebook computer. According to the specifications of the manufacturer, it must comply with the requirements of the following standards:

FCC Part 15, Subpart E (15.407)

ANSI C63.4-2003

All test items have been performed and recorded as per the above standards.

NOTE: The EUT is also considered as a kind of computer peripheral, because the connection to computer is necessary for typical use. It has been verified to comply with the requirements of FCC Part 15, Subpart B, Class B (DoC). The test report has been issued separately.

3.4 DESCRIPTION OF SUPPORT UNITS

The EUT has been tested as an independent unit together with other necessary accessories or support units. The following support units or accessories were used to form a representative test configuration during the tests.

NO.	PRODUCT	BRAND	MODEL NO.	SERIAL NO.	FCC ID
1	600 Ω LOAD	NA	NA	NA	NA

NO.	SIGNAL CABLE DESCRIPTION OF THE ABOVE SUPPORT UNITS
1	NA

NOTE: All power cords of the above support units are non shielded (1.8m).



4. TEST TYPES AND RESULTS (5150 ~ 5350MHz Band)

4.1 CONDUCTED EMISSION MEASUREMENT

4.1.1 LIMITS OF CONDUCTED EMISSION MEASUREMENT

FREQUENCY OF EMISSION (MHz)	CONDUCTED LIMIT (dB μ V)	
	Quasi-peak	Average
0.15-0.5	66 to 56	56 to 46
0.5-5	56	46
5-30	60	50

- NOTE:**
1. The lower limit shall apply at the transition frequencies.
 2. The limit decreases in line with the logarithm of the frequency in the range of 0.15 to 0.50 MHz.
 3. All emanations from a class A/B digital device or system, including any network of conductors and apparatus connected thereto, shall not exceed the level of field strengths specified above.

4.1.2 TEST INSTRUMENTS

DESCRIPTION & MANUFACTURER	MODEL NO.	SERIAL NO.	CALIBRATED UNTIL
Test Receiver ROHDE & SCHWARZ	ESCS30	100288	Nov. 06, 2005
RF signal cable Woken	5D-FB	Cable-HyC02-01	Jan. 09, 2006
LISN ROHDE & SCHWARZ	ESH2-Z5	100100	Jan. 20, 2006
LISN ROHDE & SCHWARZ	ESH3-Z5	100311	Jan. 20, 2006
Software ADT	ADT_Cond_V3	NA	NA

- NOTE:**
1. The calibration interval of the above test instruments is 12 months and the calibrations are traceable to NML/ROC and NIST/USA.
 2. The test was performed in HwaYa Shielded Room 3.
 3. The VCCI Site Registration No. is C-2047.



4.1.3 TEST PROCEDURES

- a. The EUT was placed 0.4 meters from the conducting wall of the shielded room with EUT being connected to the power mains through a line impedance stabilization network (LISN). Other support units were connected to the power mains through another LISN. The two LISNs provide 50 ohm/ 50uH of coupling impedance for the measuring instrument.
- b. Both lines of the power mains connected to the EUT were checked for maximum conducted interference.
- c. The frequency range from 150kHz to 30MHz was searched. Emission levels under (Limit - 20dB) was not recorded.

4.1.4 DEVIATION FROM TEST STANDARD

No deviation

4.1.5 TEST SETUP

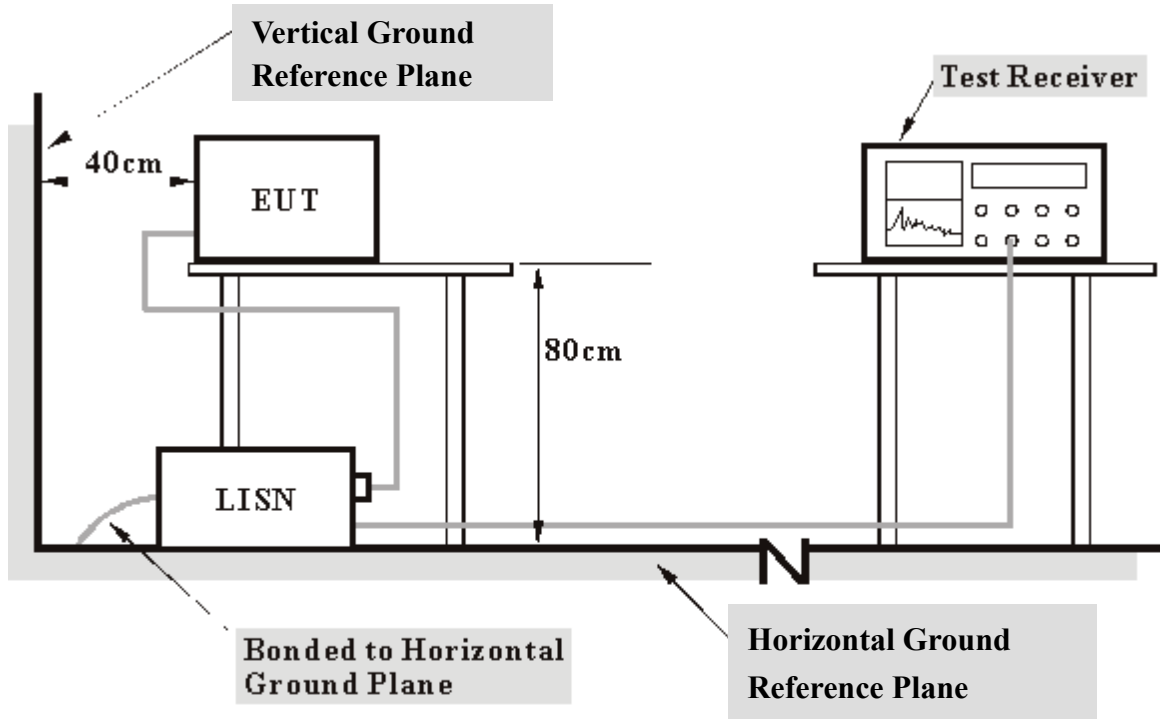

- Note:**
1. Support units were connected to second LISN.
 2. Both of LISNs (AMN) 80 cm from EUT and at the least 80 cm from other units and other metal planes support units.

For the actual test configuration, please refer to the related item – Photographs of the Test Configuration.

4.1.6 EUT OPERATING CONDITIONS

- a. Placed the EUT on a testing table.
- b. The EUT ran a test program (provided by manufacturer) to enable all functions under transmission/receiving condition continuously at specific channel frequency.
- c. The notebook system sent "H" messages to its screen.
- d. Step c was repeated.



4.1.7 TEST RESULTS

Conducted Worst-Case Data (Power from AC Adapter: PA-1900-03)

EUT	notebook computer	MEASUREMENT DETAIL	
MODEL	TA1 (with Intel WM3B2915ABG)	PHASE	Line 1
CHANNEL	Channel 5	6dB BANDWIDTH	9 kHz
MODULATION TYPE	BPSK	ENVIRONMENTAL CONDITIONS	25deg. C, 70%RH, 991hPa
TRANSFER RATE	6Mbps	INPUT POWER (SYSTEM)	120Vac, 60 Hz
TEST MODE	1	TESTED BY	Jamison Chan

No	Freq. [MHz]	Corr. Factor (dB)	Reading Value [dB (uV)]		Emission Level [dB (uV)]		Limit [dB (uV)]		Margin (dB)	
			Q.P.	AV.	Q.P.	AV.	Q.P.	AV.	Q.P.	AV.
			1	0.158	0.10	47.32	21.17	47.42	21.27	65.58
2	0.185	0.10	43.58	-	43.68	-	64.25	54.25	-20.57	-
3	0.412	0.10	28.50	-	28.60	-	57.61	47.61	-29.01	-
4	0.978	0.20	27.37	-	27.57	-	56.00	46.00	-28.43	-
5	4.379	0.21	22.22	-	22.43	-	56.00	46.00	-33.57	-
6	6.832	0.25	20.88	-	21.13	-	60.00	50.00	-38.87	-

- REMARKS:**
1. Q.P. and AV. are abbreviations of quasi-peak and average individually.
 2. "-": The Quasi-peak reading value also meets average limit and measurement with the average detector is unnecessary.
 3. The emission levels of other frequencies were very low against the limit.
 4. Margin value = Emission level - Limit value
 5. Correction factor = Insertion loss + Cable loss
 6. Emission Level = Correction Factor + Reading Value.

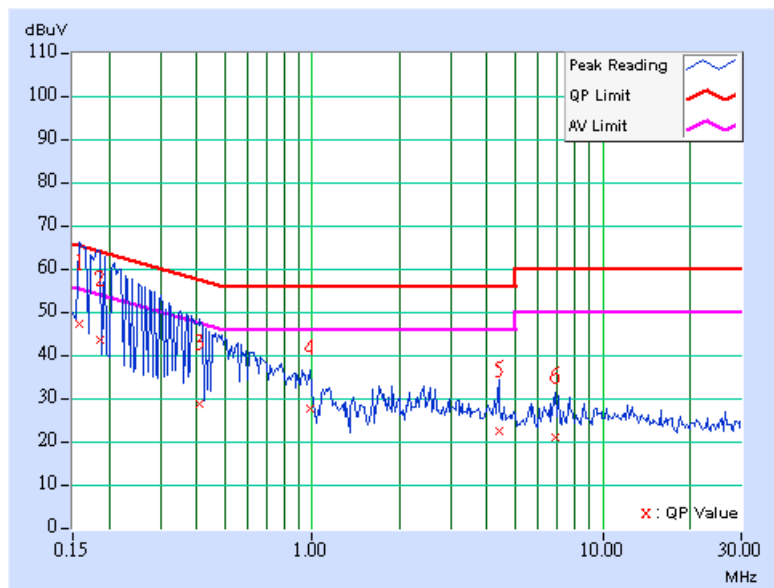



EUT	notebook computer	MEASUREMENT DETAIL	
MODEL	TA1 (with Intel WM3B2915ABG)	PHASE	Line 2
CHANNEL	Channel 5	6dB BANDWIDTH	9 kHz
MODULATION TYPE	BPSK	ENVIRONMENTAL CONDITIONS	25deg. C, 70%RH, 991hPa
TRANSFER RATE	6Mbps	INPUT POWER (SYSTEM)	120Vac, 60 Hz
TEST MODE	1	TESTED BY	Jamison Chan

No	Freq. [MHz]	Corr. Factor (dB)	Reading Value [dB (uV)]		Emission Level [dB (uV)]		Limit [dB (uV)]		Margin (dB)	
			Q.P.	AV.	Q.P.	AV.	Q.P.	AV.	Q.P.	AV.
			1	0.173	0.10	44.64	-	44.74	-	64.79
2	0.193	0.10	42.80	-	42.90	-	63.91	53.91	-21.01	-
3	0.716	0.15	26.49	-	26.64	-	56.00	46.00	-29.36	-
4	1.086	0.20	27.32	-	27.52	-	56.00	46.00	-28.48	-
5	4.555	0.22	18.07	-	18.29	-	56.00	46.00	-37.71	-
6	9.531	0.38	19.18	-	19.56	-	60.00	50.00	-40.44	-

- REMARKS:**
1. Q.P. and AV. are abbreviations of quasi-peak and average individually.
 2. "-": The Quasi-peak reading value also meets average limit and measurement with the average detector is unnecessary.
 3. The emission levels of other frequencies were very low against the limit.
 4. Margin value = Emission level - Limit value
 5. Correction factor = Insertion loss + Cable loss
 6. Emission Level = Correction Factor + Reading Value.

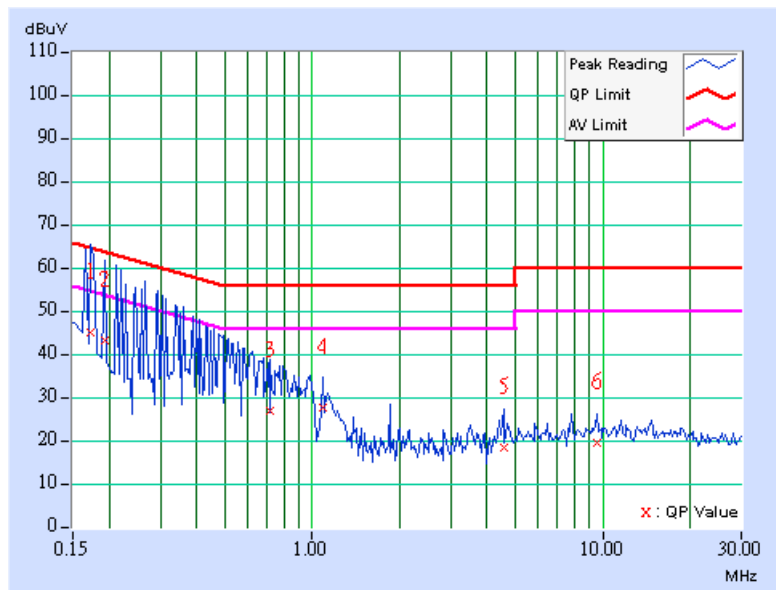



Conducted Worst-Case Data (Power from AC Adapter: PA-1650-01)

EUT	notebook computer	MEASUREMENT DETAIL	
MODEL	TA1 (with Intel WM3B2915ABG)	PHASE	Line 1
CHANNEL	Channel 5	6dB BANDWIDTH	9 kHz
MODULATION TYPE	BPSK	ENVIRONMENTAL CONDITIONS	25deg. C, 70%RH, 991hPa
TRANSFER RATE	6Mbps	INPUT POWER (SYSTEM)	120Vac, 60 Hz
TEST MODE	2	TESTED BY	Jamison Chan

No	Freq. [MHz]	Corr. Factor (dB)	Reading Value [dB (uV)]		Emission Level [dB (uV)]		Limit [dB (uV)]		Margin (dB)	
			Q.P.	AV.	Q.P.	AV.	Q.P.	AV.	Q.P.	AV.
			1	0.200	0.10	44.59	36.43	44.69	36.53	63.63
2	0.267	0.10	39.56	-	39.66	-	61.20	51.20	-21.54	-
3	0.332	0.10	35.37	-	35.47	-	59.39	49.39	-23.92	-
4	1.461	0.20	31.08	-	31.28	-	56.00	46.00	-24.72	-
5	4.383	0.21	28.45	-	28.66	-	56.00	46.00	-27.34	-
6	19.254	0.74	32.09	-	32.83	-	60.00	50.00	-27.17	-

- REMARKS:**
1. Q.P. and AV. are abbreviations of quasi-peak and average individually.
 2. "-": The Quasi-peak reading value also meets average limit and measurement with the average detector is unnecessary.
 3. The emission levels of other frequencies were very low against the limit.
 4. Margin value = Emission level - Limit value
 5. Correction factor = Insertion loss + Cable loss
 6. Emission Level = Correction Factor + Reading Value.

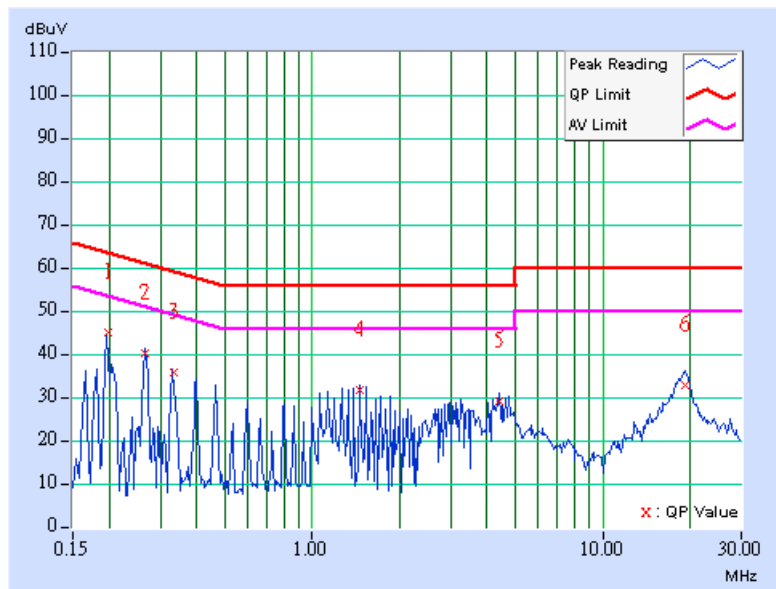



EUT	notebook computer	MEASUREMENT DETAIL	
MODEL	TA1 (with Intel WM3B2915ABG)	PHASE	Line 2
CHANNEL	Channel 5	6dB BANDWIDTH	9 kHz
MODULATION TYPE	BPSK	ENVIRONMENTAL CONDITIONS	25deg. C, 70%RH, 991hPa
TRANSFER RATE	6Mbps	INPUT POWER (SYSTEM)	120Vac, 60 Hz
TEST MODE	2	TESTED BY	Jamison Chan

No	Freq. [MHz]	Corr. Factor (dB)	Reading Value [dB (uV)]		Emission Level [dB (uV)]		Limit [dB (uV)]		Margin (dB)	
			Q.P.	AV.	Q.P.	AV.	Q.P.	AV.	Q.P.	AV.
			1	0.201	0.10	44.93	36.56	45.03	36.66	63.58
2	0.267	0.10	40.06	-	40.16	-	61.20	51.20	-21.04	-
3	0.335	0.10	35.16	-	35.26	-	59.33	49.33	-24.07	-
4	1.395	0.20	31.58	-	31.78	-	56.00	46.00	-24.22	-
5	3.387	0.20	27.53	-	27.73	-	56.00	46.00	-28.27	-
6	18.922	0.74	31.34	-	32.08	-	60.00	50.00	-27.92	-

- REMARKS:**
1. Q.P. and AV. are abbreviations of quasi-peak and average individually.
 2. "-": The Quasi-peak reading value also meets average limit and measurement with the average detector is unnecessary.
 3. The emission levels of other frequencies were very low against the limit.
 4. Margin value = Emission level - Limit value
 5. Correction factor = Insertion loss + Cable loss
 6. Emission Level = Correction Factor + Reading Value.

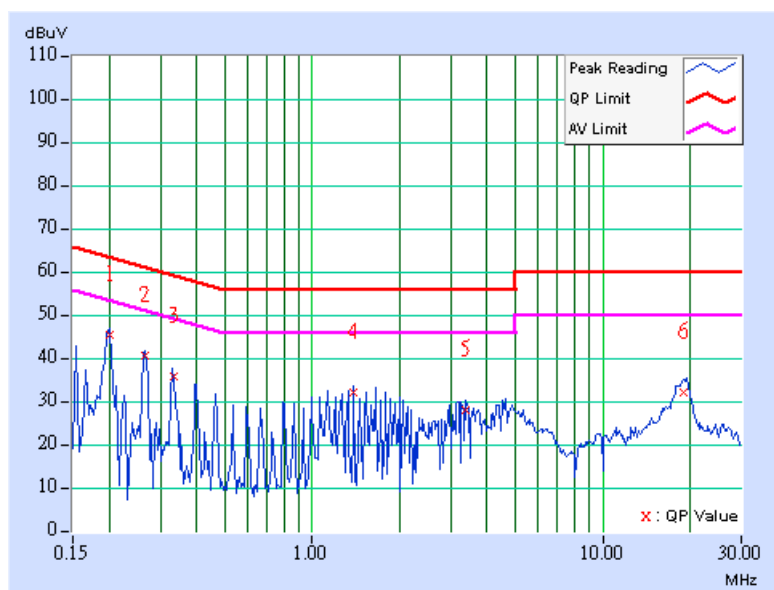



4.2 RADIATED EMISSION MEASUREMENT

4.2.1 LIMITS OF RADIATED EMISSION MEASUREMENT

Emissions radiated outside of the specified bands, shall be according to the general radiated limits in 15.209 as following:

Frequencies (MHz)	Field strength (microvolts/meter)	Measurement distance (meters)
0.009-0.490	2400/F(kHz)	300
0.490-1.705	24000/F(kHz)	30
1.705-30.0	30	30
30-88	100	3
88-216	150	3
216-960	200	3
Above 960	500	3

NOTE:

1. The lower limit shall apply at the transition frequencies.
2. Emission level (dBuV/m) = 20 log Emission level (uV/m).
3. As shown in 15.35(b), for frequencies above 1000MHz, the field strength limits are based on average detector, however, the peak field strength of any emission shall not exceed the maximum permitted average limits, specified above by more than 20dB under any condition of modulation.



4.2.2 LIMITS OF UNWANTED EMISSION OUT OF THE RESTRICTED BANDS

Frequencies (MHz)	EIRP Limit (dBm)	Equivalent Field Strength at 3m (dB μ V/m) *note 3
5150~5250	-27	68.3
5250~5350	-27	68.3
5725~5825	-27 *note 1	68.3
	-17 *note 2	78.3

NOTE:

1. For frequencies 10MHz or greater above or below the band edge.
2. All emissions within the frequency range from the band edge to 10MHz above or below the band edge.
3. The following formula is used to convert the equipment isotropic radiated power (eirp) to field strength

$$E = \frac{1000000\sqrt{30P}}{3} \quad \mu\text{V/m, where P is the eirp (Watts)}$$



4.2.3 TEST INSTRUMENTS

DESCRIPTION & MANUFACTURER	MODEL NO.	SERIAL NO.	CALIBRATED UNTIL
Test Receiver ROHDE & SCHWARZ	ESI7	100033	May. 19, 2006
Spectrum Analyzer ROHDE & SCHWARZ	FSP40	100039	Nov. 21, 2006
BILOG Antenna SCHWARZBECK	VULB9168	9168-160	Jun. 01, 2006
HORN Antenna SCHWARZBECK	9120D	9120D-408	Jan. 17, 2006
HORN Antenna SCHWARZBECK	BBHA 9170	BBHA9170243	Jan. 23, 2006
Preamplifier Agilent	8447D	2944A10633	Nov. 09, 2005
Preamplifier Agilent	8449B	3008A01964	Nov. 06, 2005
RF signal cable HUBER+SUHNNER	SUCOFLEX 104	218183/4	Jan. 26, 2006
RF signal cable HUBER+SUHNNER	SUCOFLEX 104	218195/4	Jan. 26, 2006
Software ADT.	ADT_Radiated_V5.14	NA	NA
Antenna Tower inn-co GmbH	MA 4000	013303	NA
Antenna Tower Controller inn-co GmbH	CO2000	017303	NA
Turn Table ADT.	TT100.	TT93021703	NA
Turn Table Controller ADT.	SC100.	SC93021703	NA

- NOTE:** 1. The calibration interval of the above test instruments is 12 months and the calibrations are traceable to NML/ROC and NIST/USA.
2. The test was performed in HwaYa Chamber 2.
3. The horn antenna and HP preamplifier (model: 8449B) are used only for the measurement of emission frequency above 1GHz if tested.
4. The VCCI Site Registration No. is R-237.
5. The IC Site Registration No. is IC4924-3.



4.2.4 TEST PROCEDURES

- a. The EUT was placed on the top of a rotating table 0.8 meters above the ground at a 3 meter semi-anechoic chamber. The table was rotated 360 degrees to determine the position of the highest radiation.
- b. The EUT was set 3 meters away from the interference-receiving antenna, which was mounted on the top of a variable-height antenna tower.
- c. The antenna is a broadband antenna, and its height is varied from one meter to four meters above the ground to determine the maximum value of the field strength. Both horizontal and vertical polarizations of the antenna are set to make the measurement.
- d. For each suspected emission, the EUT was arranged to its worst case and then the antenna was tuned to heights from 1 meter to 4 meters and the rotatable table was turned from 0 degrees to 360 degrees to find the maximum reading.
- e. The test-receiver system was set to Peak Detect Function and Specified Bandwidth with Maximum Hold Mode.
- f. If the emission level of the EUT in peak mode was lower than the limit specified, then testing could be stopped and the peak values of the EUT would be reported. Otherwise the emissions would be re-tested one by one using peak, quasi-peak or average method as specified and then reported in a data sheet.

NOTE:

1. The resolution bandwidth and video bandwidth of test receiver/spectrum analyzer is 120kHz for Peak detection (PK) and Quasi-peak detection (QP) at frequency below 1GHz.
2. The resolution bandwidth and video bandwidth of test receiver/spectrum analyzer is 1 MHz for Peak detection at frequency above 1GHz.
3. The resolution bandwidth of test receiver/spectrum analyzer is 1 MHz and the video bandwidth is 10 Hz for Average detection (AV) at frequency above 1GHz.

4.2.5 DEVIATION FROM TEST STANDARD

No deviation

4.2.6 TEST SETUP

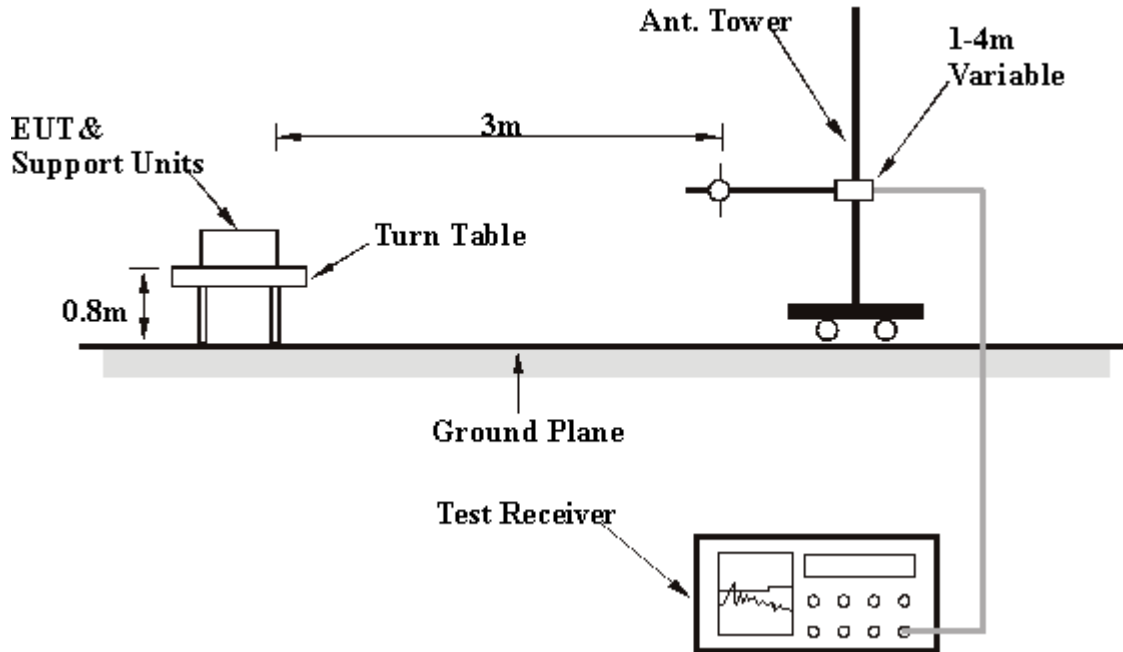

For the actual test configuration, please refer to the related item – Photographs of the Test Configuration.

4.2.7 EUT OPERATING CONDITION

Same as 4.1.6



4.2.8 TEST RESULTS

Below 1GHz Worst-Case Data (Power from AC Adapter PA-1900-03)

EUT	notebook computer	MEASUREMENT DETAIL	
MODEL	TA1 (with Intel WM3B2915ABG)	FREQUENCY RANGE	Below 1000MHz
CHANNEL	Channel 5	DETECTOR FUNCTION	Quasi-Peak
MODULATION TYPE	BPSK	ENVIRONMENTAL CONDITIONS	26deg. C, 65%RH, 991hPa
TRANSFER RATE	6Mbps	INPUT POWER (SYSTEM)	120Vac, 60 Hz
TEST MODE	1	TESTED BY	Brad Wu

ANTENNA POLARITY & TEST DISTANCE: HORIZONTAL AT 3 M

No.	Freq. (MHz)	Emission Level (dBuV/m)	Limit (dBuV/m)	Margin (dB)	Antenna Height (m)	Table Angle (Degree)	Raw Value (dBuV)	Correction Factor (dB/m)
1	152.87	38.77 QP	43.50	-4.73	2.00 H	238	24.30	14.47
2	189.51	38.74 QP	43.50	-4.76	2.00 H	70	26.80	11.94
3	278.97	39.89 QP	46.00	-6.11	1.50 H	76	26.01	13.88
4	367.34	34.70 QP	46.00	-11.30	1.00 H	286	18.99	15.71
5	502.07	36.73 QP	46.00	-9.27	2.00 H	58	18.38	18.35
6	798.46	38.07 QP	46.00	-7.93	1.00 H	10	14.75	23.33

ANTENNA POLARITY & TEST DISTANCE: VERTICAL AT 3 M

No.	Freq. (MHz)	Emission Level (dBuV/m)	Limit (dBuV/m)	Margin (dB)	Antenna Height (m)	Table Angle (Degree)	Raw Value (dBuV)	Correction Factor (dB/m)
1	159.33	41.00 QP	43.50	-2.50	1.00 V	256	26.39	14.61
2	211.07	35.96 QP	43.50	-7.54	2.00 V	166	24.60	11.36
3	278.97	38.80 QP	46.00	-7.20	2.00 V	172	24.92	13.88
4	400.76	36.67 QP	46.00	-9.03	1.00 V	334	20.57	16.40
5	502.07	35.76 QP	46.00	-10.24	1.50 V	22	17.41	18.35
6	800.61	36.67 QP	46.00	-9.33	1.00 V	10	13.33	23.34

- REMARKS:**
1. Emission level(dBuV/m)=Raw Value(dBuV) + Correction Factor(dB/m)
 2. Correction Factor(dB/m) = Antenna Factor (dB/m) + Cable Factor (dB)
 3. The other emission levels were very low against the limit.
 4. Margin value = Emission level – Limit value

Below 1GHz Worst-Case Data (Power from AC Adapter PA-1650-01)

EUT	notebook computer	MEASUREMENT DETAIL	
MODEL	TA1 (with Intel WM3B2915ABG)	FREQUENCY RANGE	Below 1000MHz
CHANNEL	Channel 5	DETECTOR FUNCTION	Quasi-Peak
MODULATION TYPE	BPSK	ENVIRONMENTAL CONDITIONS	25deg. C, 68%RH, 991hPa
TRANSFER RATE	6Mbps	INPUT POWER (SYSTEM)	120Vac, 60 Hz
TEST MODE	2	TESTED BY	Brad Wu

ANTENNA POLARITY & TEST DISTANCE: HORIZONTAL AT 3 M

No.	Freq. (MHz)	Emission Level (dBuV/m)	Limit (dBuV/m)	Margin (dB)	Antenna Height (m)	Table Angle (Degree)	Raw Value (dBuV)	Correction Factor (dB/m)
1	192.74	39.28 QP	43.50	-4.22	1.50 H	70.	27.59	11.69
2	277.89	39.64 QP	46.00	-6.36	1.00 H	76	25.80	13.84
3	368.42	33.81 QP	46.00	-12.19	1.00 H	52	18.07	15.73
4	500.99	36.72 QP	46.00	-9.28	2.00 H	70	18.39	18.33
5	721.93	33.16 QP	46.00	-12.84	1.00 H	322	10.81	22.35
6	797.38	38.98 QP	46.00	-7.02	1.00 H	22	15.66	23.32

ANTENNA POLARITY & TEST DISTANCE: VERTICAL AT 3 M

No.	Freq. (MHz)	Emission Level (dBuV/m)	Limit (dBuV/m)	Margin (dB)	Antenna Height (m)	Table Angle (Degree)	Raw Value (dBuV)	Correction Factor (dB/m)
1	138.86	33.53 QP	43.50	-9.97	1.00 V	64	19.41	14.12
2	187.36	34.95 QP	43.50	-8.55	1.50 V	112	22.83	12.11
3	277.89	39.31 QP	46.00	-6.69	2.00 V	172	25.47	13.84
4	418.00	36.93 QP	46.00	-9.07	1.00 V	334	20.08	16.85
5	499.91	35.95 QP	46.00	-10.05	1.00 V	16	17.64	18.31
6	797.38	35.80 QP	46.00	-10.20	1.00 V	16	12.48	23.32

- REMARKS:**
1. Emission level(dBuV/m)=Raw Value(dBuV) + Correction Factor(dB/m)
 2. Correction Factor(dB/m) = Antenna Factor (dB/m) + Cable Factor (dB)
 3. The other emission levels were very low against the limit.
 4. Margin value = Emission level – Limit value



802.11a OFDM modulation

EUT	notebook computer	MEASUREMENT DETAIL	
MODEL	TA1 (with Intel WM3B2915ABG)	FREQUENCY RANGE	1 ~ 40 GHz
CHANNEL	Channel 1	DETECTOR FUNCTION	Peak(PK) Average (AV)
MODULATION TYPE	BPSK	ENVIRONMENTAL CONDITIONS	25deg.C, 75%RH, 991hPa
TRANSFER RATE	6Mbps	INPUT POWER (SYSTEM)	120Vac, 60 Hz
TESTED BY	Jamison Chan		

ANTENNA POLARITY & TEST DISTANCE: HORIZONTAL AT 3 M								
No.	Freq. (MHz)	Emission Level (dBuV/m)	Limit (dBuV/m)	Margin (dB)	Antenna Height (m)	Table Angle (Degree)	Raw Value (dBuV)	Correction Factor (dB/m)
1	#5150.00	60.41 PK	74.00	-13.59	1.00 H	245	22.30	38.11
1	#5150.00	45.85 AV	54.00	-8.15	1.00 H	245	7.74	38.11
2	*5180.00	105.01 PK			1.00 H	245	66.15	38.86
2	*5180.00	95.14 AV			1.00 H	245	56.28	38.86
3	6906.60	52.66 PK	68.30	-15.64	1.13 H	142	11.18	41.48
4	10360.00	53.93 PK	68.30	-14.37	1.00 H	81	7.60	46.33

ANTENNA POLARITY & TEST DISTANCE: VERTICAL AT 3 M								
No.	Freq. (MHz)	Emission Level (dBuV/m)	Limit (dBuV/m)	Margin (dB)	Antenna Height (m)	Table Angle (Degree)	Raw Value (dBuV)	Correction Factor (dB/m)
1	#5150.00	58.33 PK	74.00	-15.67	1.18 V	209	20.22	38.11
1	#5150.00	42.69 AV	54.00	-11.31	1.18 V	209	4.58	38.11
2	*5180.00	100.50 PK			1.36 V	259	61.64	38.86
2	*5180.00	90.32 AV			1.36 V	259	51.46	38.86
3	6906.60	52.98 PK	68.30	-15.32	1.18 V	209	11.50	41.48
4	10360.00	54.88 PK	68.30	-13.42	1.11 V	206	8.55	46.33

- NOTE:**
1. Emission level(dBuV/m)=Raw Value(dBuV) + Correction Factor(dB/m)
 2. Correction Factor(dB/m) = Antenna Factor (dB/m) + Cable Factor (dB)
 3. The other emission levels were very low against the limit.
 4. Margin value = Emission level – Limit value
 5. “*” : Fundamental frequency
 6. “#”The radiated frequency falling in the restricted band.



EUT	notebook computer	MEASUREMENT DETAIL	
MODEL	TA1 (with Intel WM3B2915ABG)	FREQUENCY RANGE	1 ~ 40 GHz
CHANNEL	Channel 4	DETECTOR FUNCTION	Peak(PK) Average (AV)
MODULATION TYPE	BPSK	ENVIRONMENTAL CONDITIONS	25deg.C, 75%RH, 991hPa
TRANSFER RATE	6Mbps	INPUT POWER (SYSTEM)	120Vac, 60 Hz
TESTED BY	Jamison Chan		

ANTENNA POLARITY & TEST DISTANCE: HORIZONTAL AT 3 M								
No.	Freq. (MHz)	Emission Level (dBuV/m)	Limit (dBuV/m)	Margin (dB)	Antenna Height (m)	Table Angle (Degree)	Raw Value (dBuV)	Correction Factor (dB/m)
1	*5240.00	103.82 PK			1.00 H	165	66.94	36.88
1	*5240.00	94.01 AV			1.00 H	165	57.13	36.88
2	6986.60	50.51 PK	68.30	-17.79	1.43 H	148	9.10	41.40
3	10480.00	54.46 PK	68.30	-13.84	1.05 H	188	8.55	45.91

ANTENNA POLARITY & TEST DISTANCE: VERTICAL AT 3 M								
No.	Freq. (MHz)	Emission Level (dBuV/m)	Limit (dBuV/m)	Margin (dB)	Antenna Height (m)	Table Angle (Degree)	Raw Value (dBuV)	Correction Factor (dB/m)
1	*5240.00	101.30 PK			1.25 V	340	64.42	36.88
1	*5240.00	91.59 AV			1.25 V	340	54.71	36.88
2	6986.60	51.10 PK	68.30	-17.20	1.25 V	193	9.69	41.40
3	10480.00	55.37 PK	68.30	-12.93	1.14 V	242	9.46	45.91

- NOTE:**
1. Emission level(dBuV/m)=Raw Value(dBuV) + Correction Factor(dB/m)
 2. Correction Factor(dB/m) = Antenna Factor (dB/m) + Cable Factor (dB)
 3. The other emission levels were very low against the limit.
 4. Margin value = Emission level – Limit value
 5. "*" : Fundamental frequency
 6. "#":The radiated frequency falling in the restricted band.



EUT	notebook computer	MEASUREMENT DETAIL	
MODEL	TA1 (with Intel WM3B2915ABG)	FREQUENCY RANGE	1 ~ 40 GHz
CHANNEL	Channel 5	DETECTOR FUNCTION	Peak(PK) Average (AV)
MODULATION TYPE	BPSK	ENVIRONMENTAL CONDITIONS	25deg.C, 75%RH, 991hPa
TRANSFER RATE	6Mbps	INPUT POWER (SYSTEM)	120Vac, 60 Hz
TESTED BY	Jamison Chan		

ANTENNA POLARITY & TEST DISTANCE: HORIZONTAL AT 3 M

No.	Freq. (MHz)	Emission Level (dBuV/m)	Limit (dBuV/m)	Margin (dB)	Antenna Height (m)	Table Angle (Degree)	Raw Value (dBuV)	Correction Factor (dB/m)
1	*5260.00	103.66 PK			1.27 H	166	66.77	36.89
1	*5260.00	42.38 AV			1.27 H	166	5.49	36.89
2	7013.30	51.25 PK	68.30	-17.05	1.25 H	182	9.77	41.48
3	10520.00	55.84 PK	68.30	-12.46	1.11 H	160	9.81	46.04

ANTENNA POLARITY & TEST DISTANCE: VERTICAL AT 3 M

No.	Freq. (MHz)	Emission Level (dBuV/m)	Limit (dBuV/m)	Margin (dB)	Antenna Height (m)	Table Angle (Degree)	Raw Value (dBuV)	Correction Factor (dB/m)
1	*5260.00	101.04 PK			1.12 V	339	64.15	36.89
1	*5260.00	90.86 AV			1.12 V	339	53.97	36.89
2	7013.30	51.01 PK	68.30	-17.29	1.00 V	166	9.53	41.48
3	10520.00	55.56 PK	68.30	-12.74	1.00 V	108	9.53	46.04

- NOTE:**
1. Emission level(dBuV/m)=Raw Value(dBuV) + Correction Factor(dB/m)
 2. Correction Factor(dB/m) = Antenna Factor (dB/m) + Cable Factor (dB)
 3. The other emission levels were very low against the limit.
 4. Margin value = Emission level – Limit value
 5. "*" : Fundamental frequency
 6. "#" The radiated frequency falling in the restricted band.

EUT	notebook computer	MEASUREMENT DETAIL	
MODEL	TA1 (with Intel WM3B2915ABG)	FREQUENCY RANGE	1 ~ 40 GHz
CHANNEL	Channel 8	DETECTOR FUNCTION	Peak(PK) Average (AV)
MODULATION TYPE	BPSK	ENVIRONMENTAL CONDITIONS	25deg.C, 75%RH, 991hPa
TRANSFER RATE	6Mbps	INPUT POWER (SYSTEM)	120Vac, 60 Hz
TESTED BY	Jamison Chan		

ANTENNA POLARITY & TEST DISTANCE: HORIZONTAL AT 3 M

No.	Freq. (MHz)	Emission Level (dBuV/m)	Limit (dBuV/m)	Margin (dB)	Antenna Height (m)	Table Angle (Degree)	Raw Value (dBuV)	Correction Factor (dB/m)
1	*5320.00	104.96 PK			1.16 H	166	68.05	36.91
1	*5320.00	94.81 AV			1.16 H	166	57.90	36.91
2	#5350.00	64.36 PK	74.00	-9.64	1.16 H	166	27.44	36.92
2	#5350.00	51.03 AV	54.00	-2.97	1.16 H	166	14.11	36.92
3	7093.30	50.07 PK	68.30	-18.23	1.30 H	83	8.28	41.78
4	#10640.00	55.37 PK	74.00	-18.63	1.00 H	164	9.03	46.35
4	#10640.00	41.79 AV	54.00	-12.21	1.00 H	164	-4.55	46.35

ANTENNA POLARITY & TEST DISTANCE: VERTICAL AT 3 M

No.	Freq. (MHz)	Emission Level (dBuV/m)	Limit (dBuV/m)	Margin (dB)	Antenna Height (m)	Table Angle (Degree)	Raw Value (dBuV)	Correction Factor (dB/m)
1	*5320.00	101.05 PK			1.15 V	173	64.14	36.91
1	*5320.00	91.30 AV			1.15 V	173	54.39	36.91
2	#5350.00	62.90 PK	74.00	-11.10	1.15 V	173	25.98	36.92
2	#5350.00	49.28 AV	54.00	-4.72	1.15 V	173	12.36	36.92
3	7093.30	50.41 PK	68.30	-17.89	1.16 V	199	8.62	41.78
4	#10640.00	55.99 PK	74.00	-18.01	1.15 V	205	9.65	46.35
4	#10640.00	42.80 AV	54.00	-11.20	1.15 V	205	-3.54	46.35

- NOTE:**
1. Emission level(dBuV/m)=Raw Value(dBuV) + Correction Factor(dB/m)
 2. Correction Factor(dB/m) = Antenna Factor (dB/m) + Cable Factor (dB)
 3. The other emission levels were very low against the limit.
 4. Margin value = Emission level – Limit value
 5. "*" : Fundamental frequency
 6. "#" The radiated frequency falling in the restricted band.



4.3 PEAK TRANSMIT POWER MEASUREMENT

4.3.1 LIMITS OF PEAK TRANSMIT POWER MEASUREMENT

Frequency Band	Limit
5.15 – 5.25GHz	The lesser of 50mW (17dBm) or 4dBm + 10logB
5.25 – 5.35GHz	The lesser of 250mW (24dBm) or 11dBm + 10logB
5.725 – 5.825GHz	The lesser of 1W (30dBm) or 17dBm + 10logB

NOTE: Where B is the 26dB emission bandwidth in MHz.

4.3.2 TEST INSTRUMENTS

Description & Manufacturer	Model No.	Serial No.	Calibrated Until
R&S SPECTRUM ANALYZER	FSEK30	100049	Aug. 12, 2005

NOTE: The calibration interval of the above test instruments is 12 months and the calibrations are traceable to NML/ROC and NIST/USA.

4.3.3 TEST PROCEDURE

1. The transmitter output was connected to the spectrum analyzer.
2. Set span to encompass the entire emission bandwidth of the signal.
3. Set RBW to 1MHz, VBW to 3MHz.
4. Using the spectrum analyzer's channel power measurement function to measure the output power.

NOTE:

The test is performed in accordance with FCC Public Notice: APPENDIX A Guidelines for Assessing Unlicensed National Information Infrastructure (U-NII) Devices – Part 15, Subpart E, August 2002.

The transmitter output operates continuously therefore Method # 1 is used.

4.3.4 DEVIATION FROM TEST STANDARD

No deviation

4.3.5 TEST SETUP

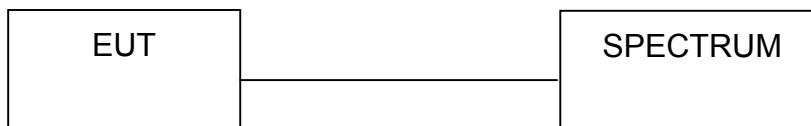

4.3.6 EUT OPERATING CONDITIONS

The software provided by client to enable the EUT under transmission condition continuously at specific channel frequencies individually.



4.3.7 TEST RESULTS

802.11a OFDM modulation

EUT	notebook computer	MODEL	TA1 (with Intel WM3B2915ABG)
MODULATION TYPE	BPSK	TRANSFER RATE	6Mbps
INPUT POWER (SYSTEM)	120Vac, 60 Hz	ENVIRONMENTAL CONDITIONS	25deg.C, 65%RH, 991hPa
TESTED BY	Jamison Chan		

CHANNEL	CHANNEL FREQUENCY (MHz)	PEAK POWER OUTPUT (mW)	PEAK POWER OUTPUT (dBm)	PEAK POWER LIMIT (dBm)	26dBc Occupied Bandwidth (MHz)	PASS/FAIL
1	5180	33.497	15.25	17.00	24.93	PASS
4	5240	32.063	15.06	17.00	29.88	PASS
5	5260	41.020	16.13	24.00	33.75	PASS
8	5320	39.994	16.02	24.00	33.75	PASS

NOTE: The 26dBc Occupied Bandwidth plot, please refer to the following pages.



Peak Power Output:
CH 1

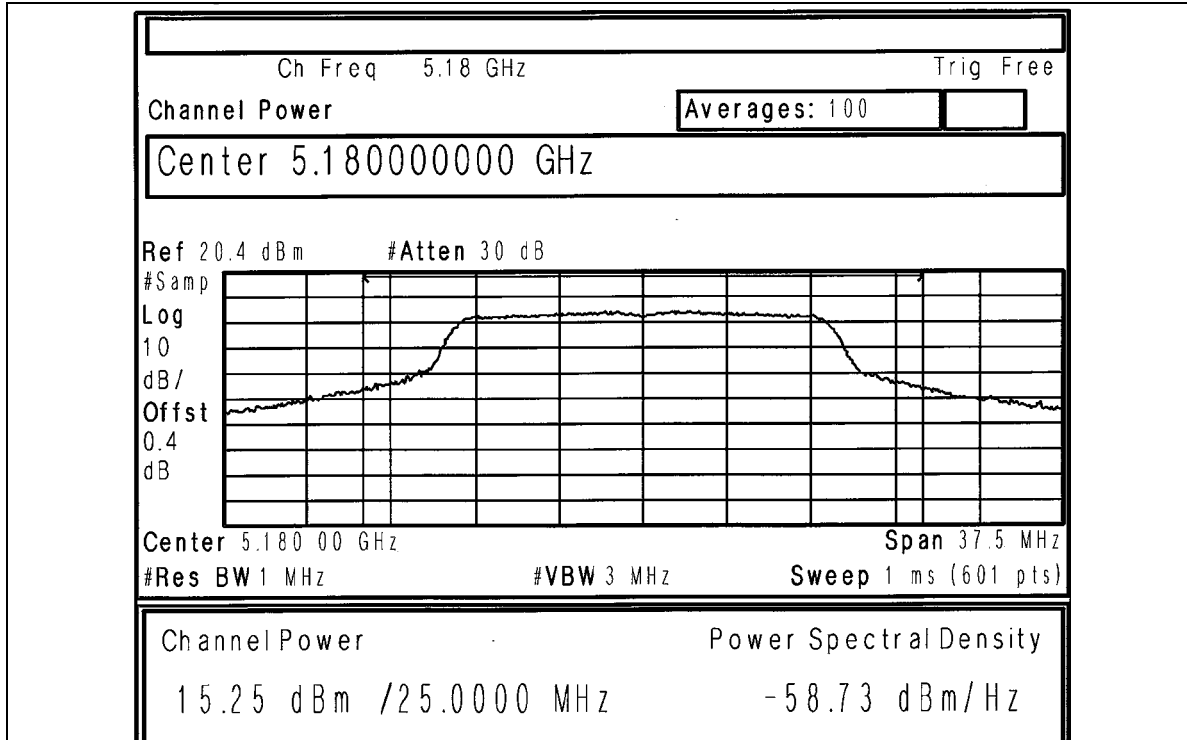

CH 4

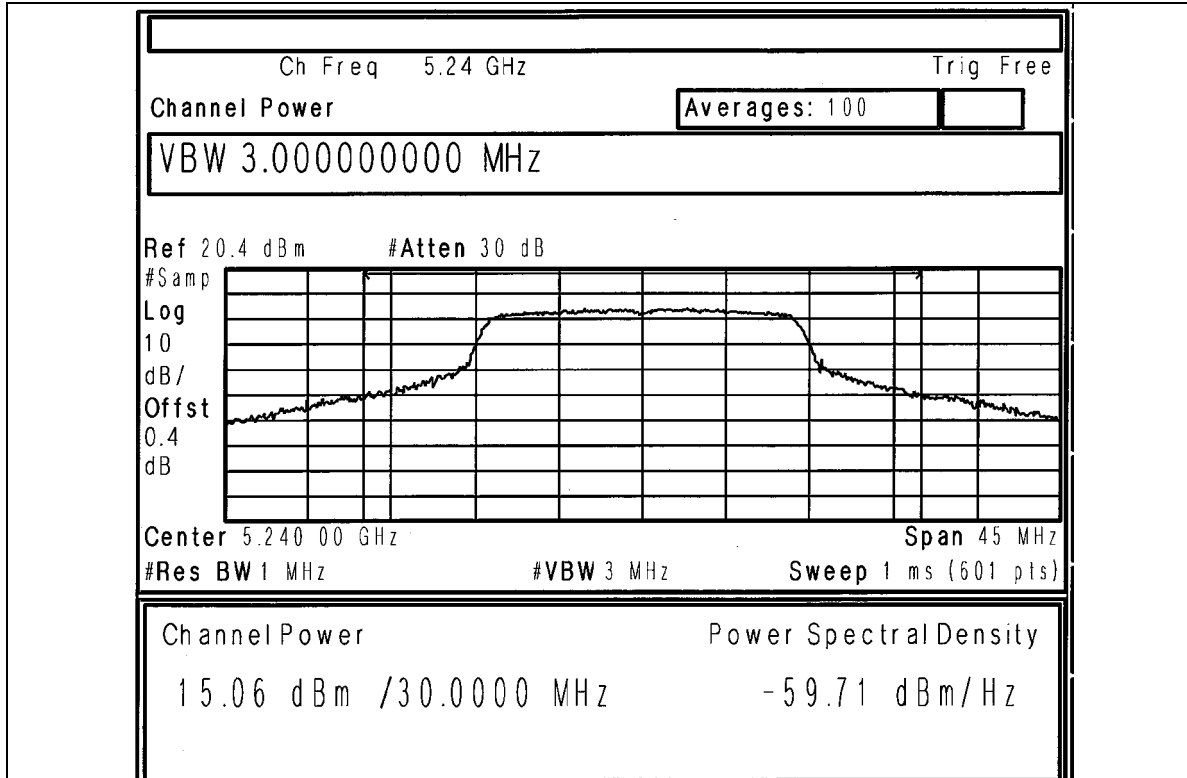



CH 5

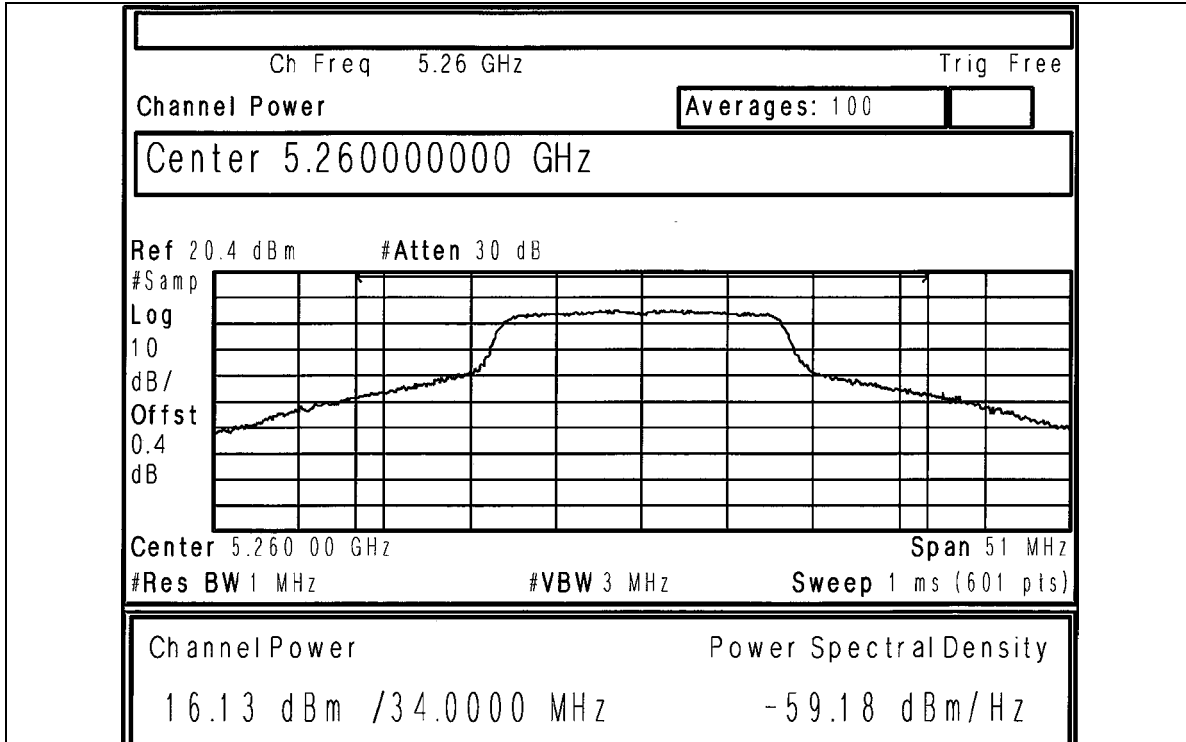

CH 8

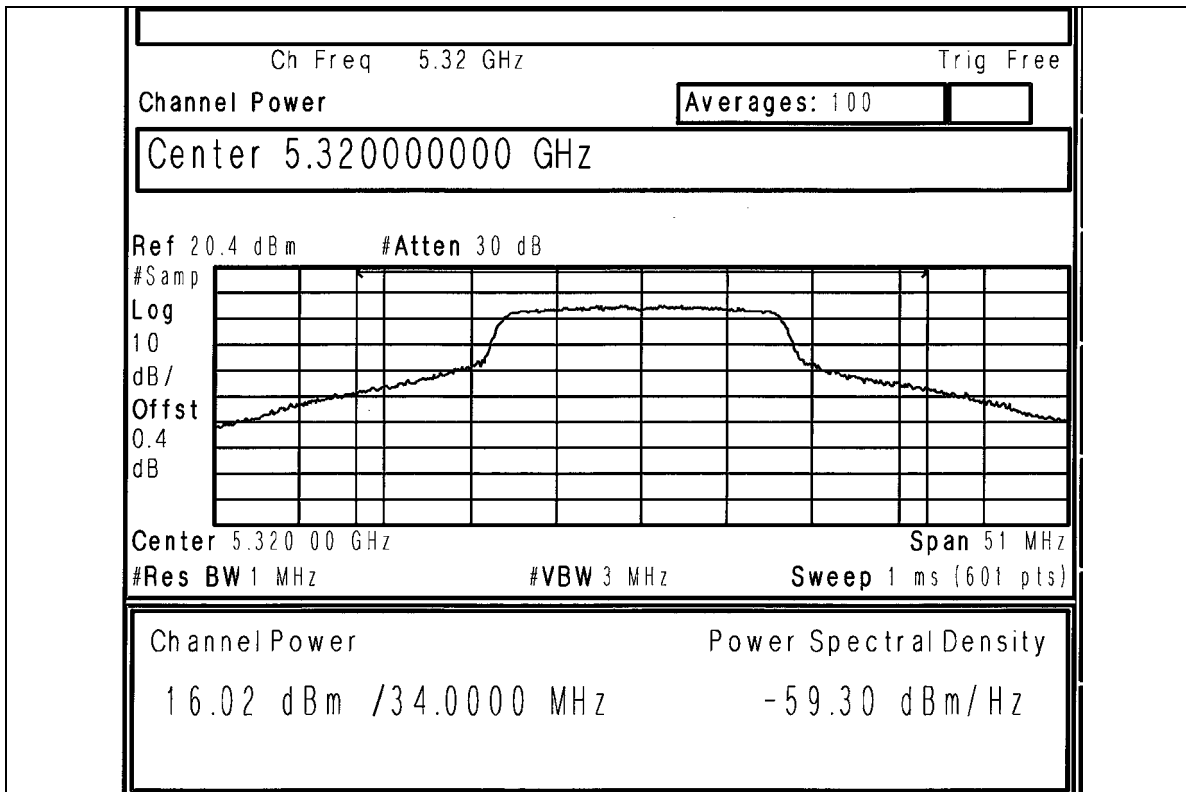



26dB Occupied Bandwidth:
CH 1

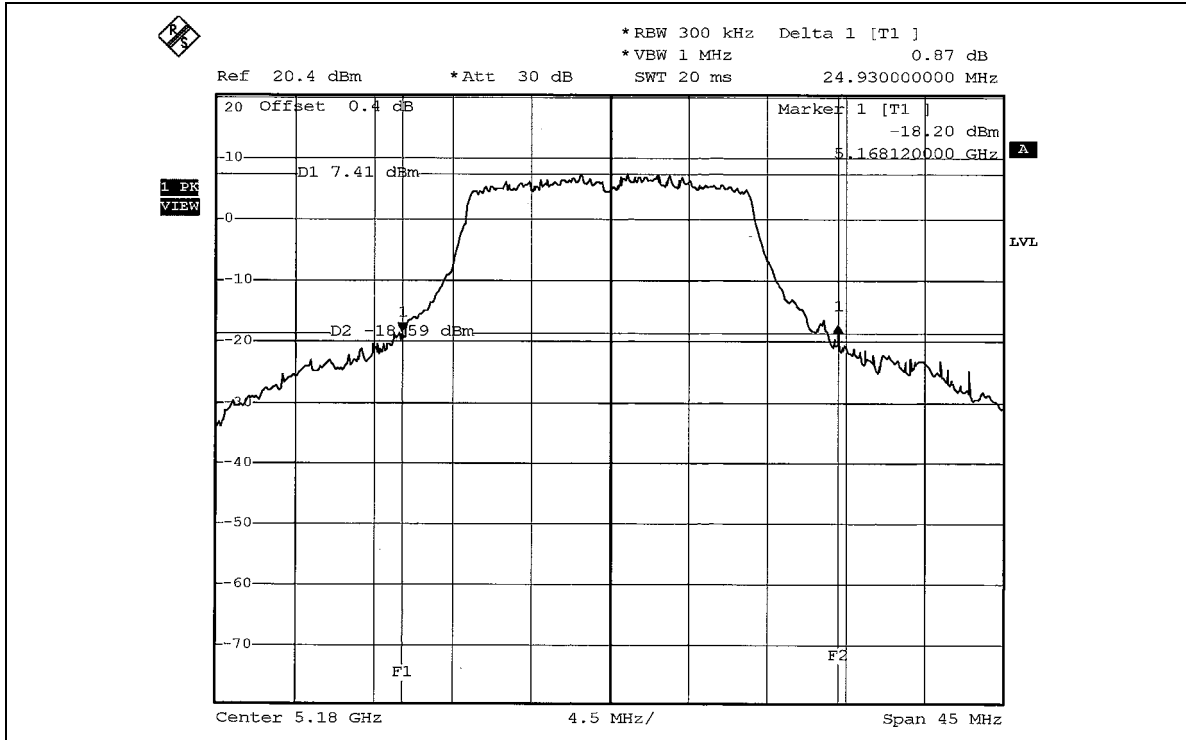

CH 4

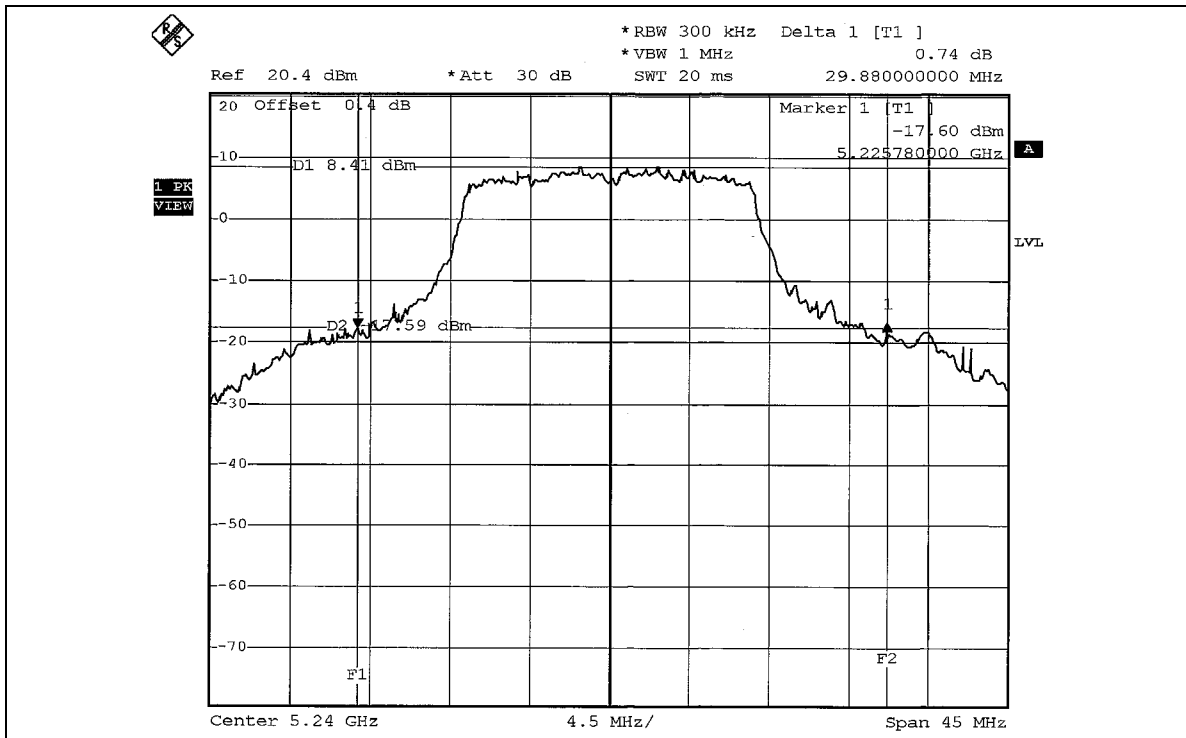



CH 5

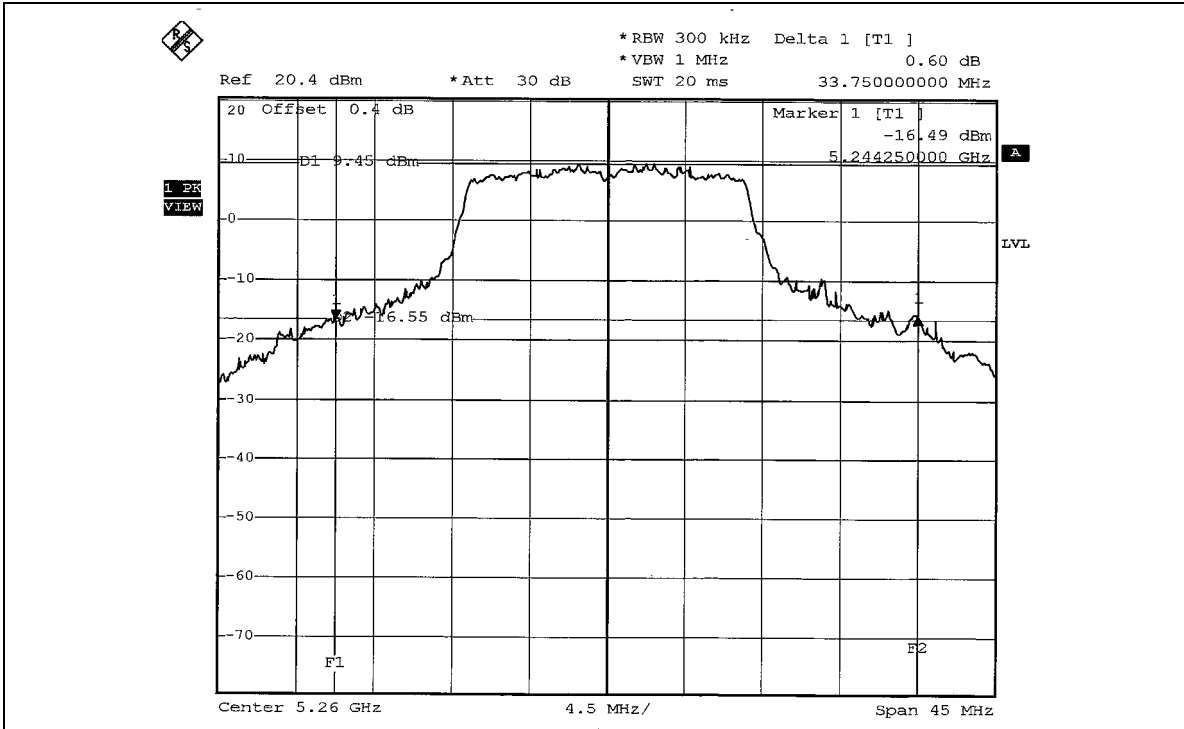

CH 8

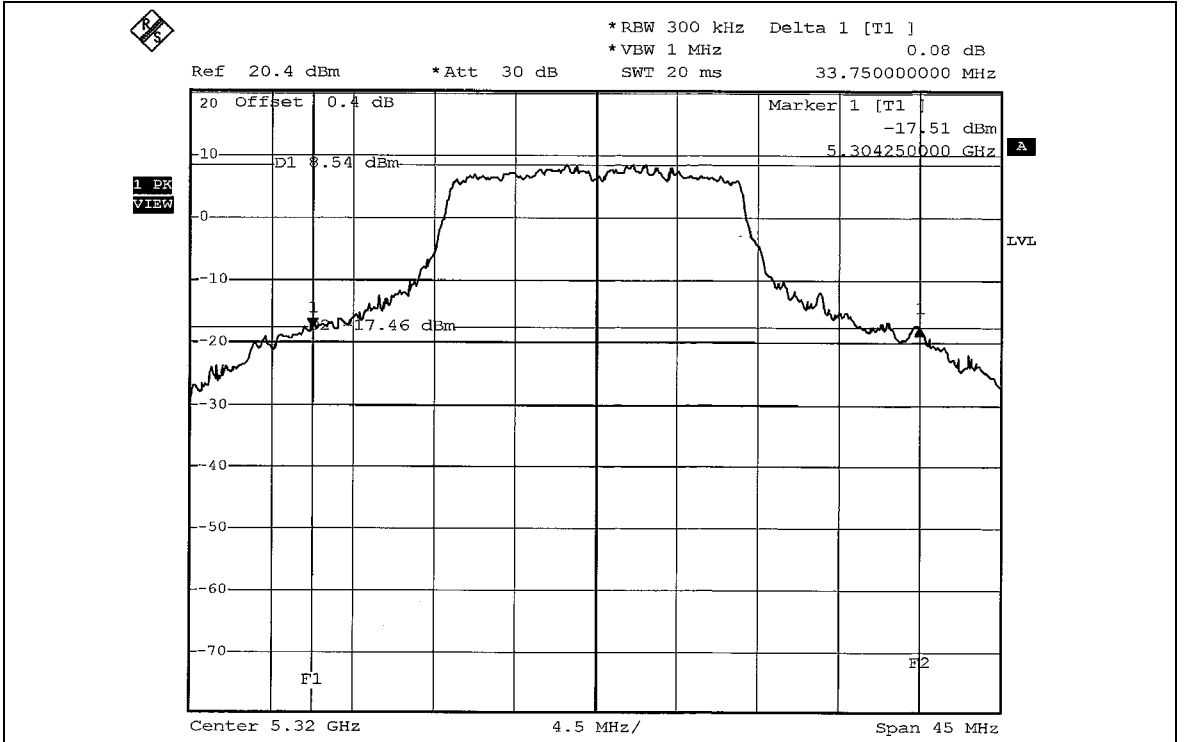



4.4 PEAK POWER EXCURSION MEASUREMENT

4.4.1 LIMITS OF PEAK POWER EXCURSION MEASUREMENT

Frequency Band	Limit
5.15 – 5.25 GHz	13dB
5.25 – 5.35 GHz	13dB
5.725 – 5.825 GHz	13dB

4.4.2 TEST INSTRUMENTS

Description & Manufacturer	Model No.	Serial No.	Calibrated Until
SPECTRUM ANALYZER	FSEK30	100049	Aug. 12, 2005

NOTE: The calibration interval of the above test instruments is 12 months and the calibrations are traceable to NML/ROC and NIST/USA.



4.4.3 TEST PROCEDURE

1. The transmitter output was connected to the spectrum analyzer.
2. Set the spectrum bandwidth span to view the entire spectrum.
3. Using peak detector and Max-hold function for Trace 1 (RB=1MHz, VB=3MHz) and 2 (RB=1MHz, VB=300KHz).
4. The largest difference between Trace 1 and Trace 2 in any 1MHz band on any frequency was recorded.

4.4.4 DEVIATION FROM TEST STANDARD

No deviation

4.4.5 TEST SETUP

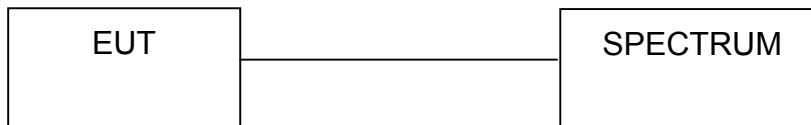

4.4.6 EUT OPERATING CONDITIONS

The software provided by client to enable the EUT under transmission condition continuously at specific channel frequencies individually.



4.4.7 TEST RESULTS

802.11a OFDM modulation

EUT	notebook computer	MODEL	TA1 (with Intel WM3B2915ABG)
MODULATION TYPE	BPSK	TRANSFER RATE	6Mbps
INPUT POWER (SYSTEM)	120Vac, 60 Hz	ENVIRONMENTAL CONDITIONS	25deg.C, 65%RH, 991hPa
TESTED BY	Jamison Chan		

CHANNEL	CHANNEL FREQUENCY (MHz)	PEAK POWER EXCURSION (dB)	PEAK to AVERAGE EXCURSION LIMIT (dB)	PASS/FAIL
1	5180	6.50	13	PASS
4	5240	5.47	13	PASS
5	5260	5.59	13	PASS
8	5320	5.07	13	PASS



CH 1

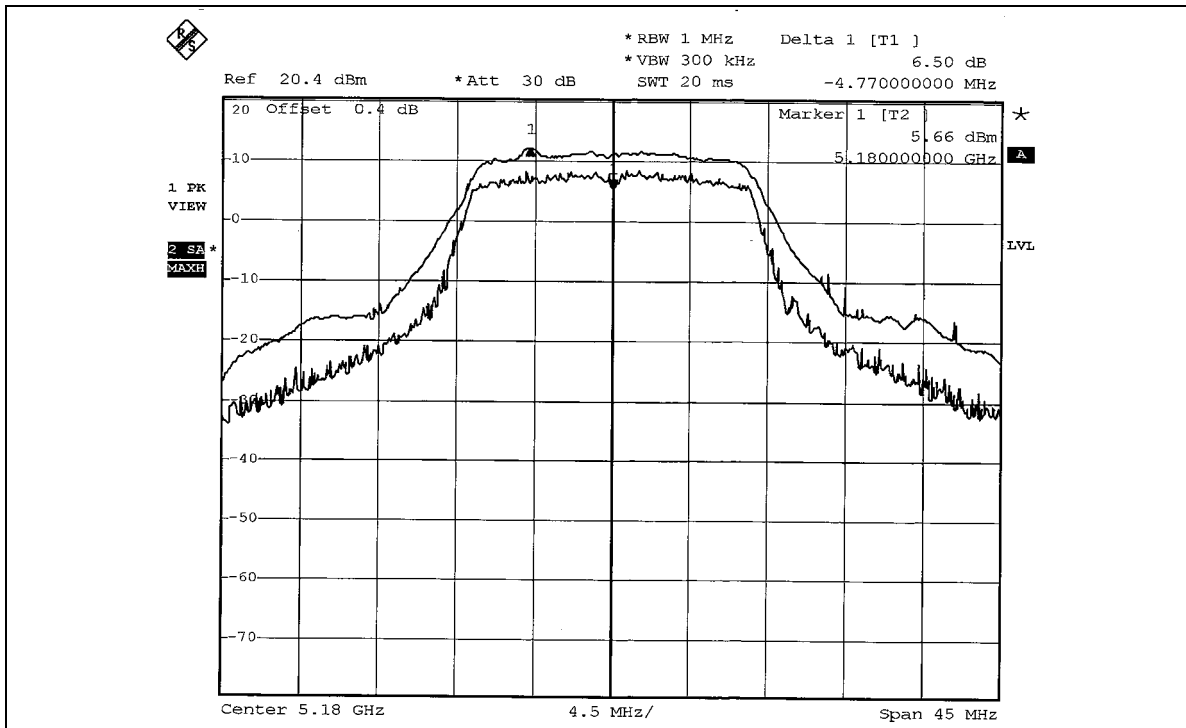

CH 4

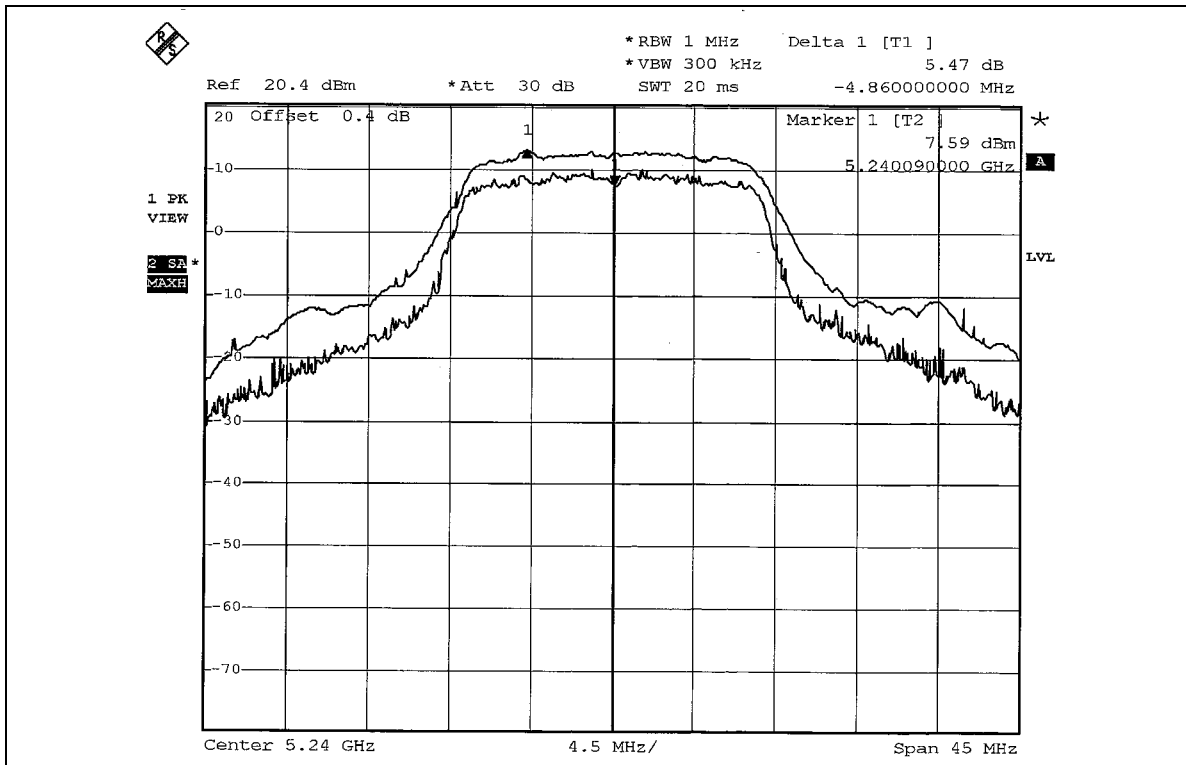



CH 5

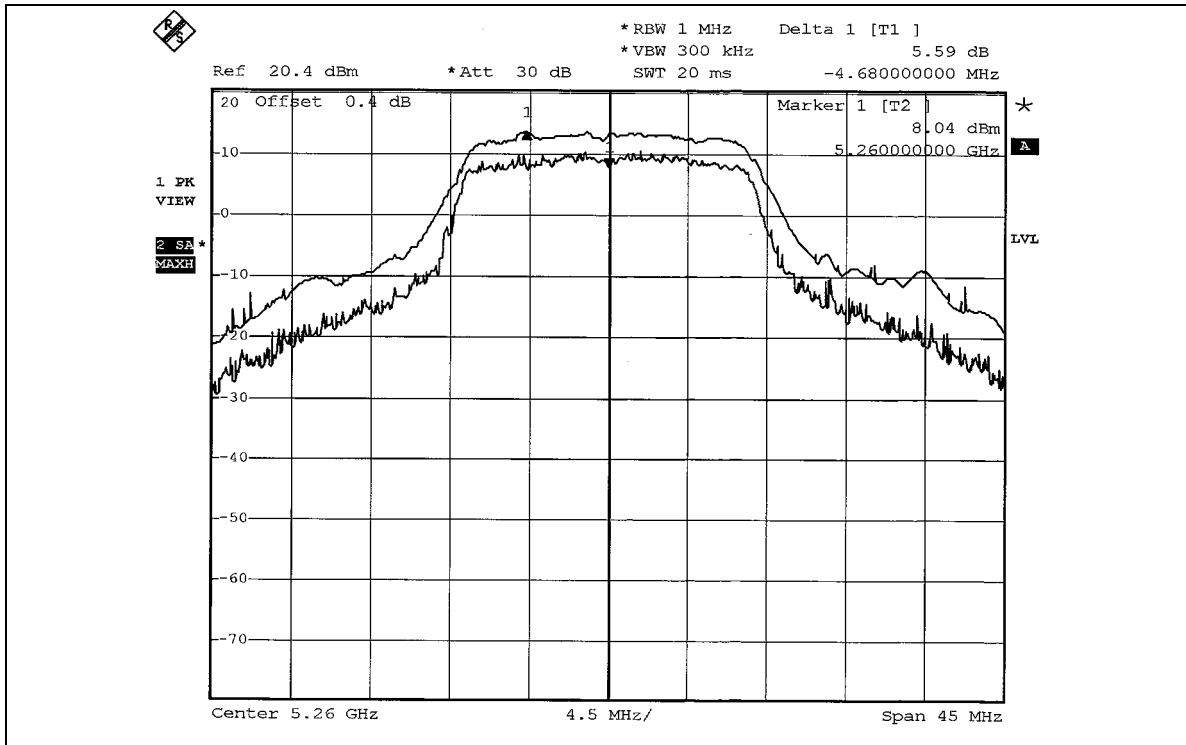

CH 8

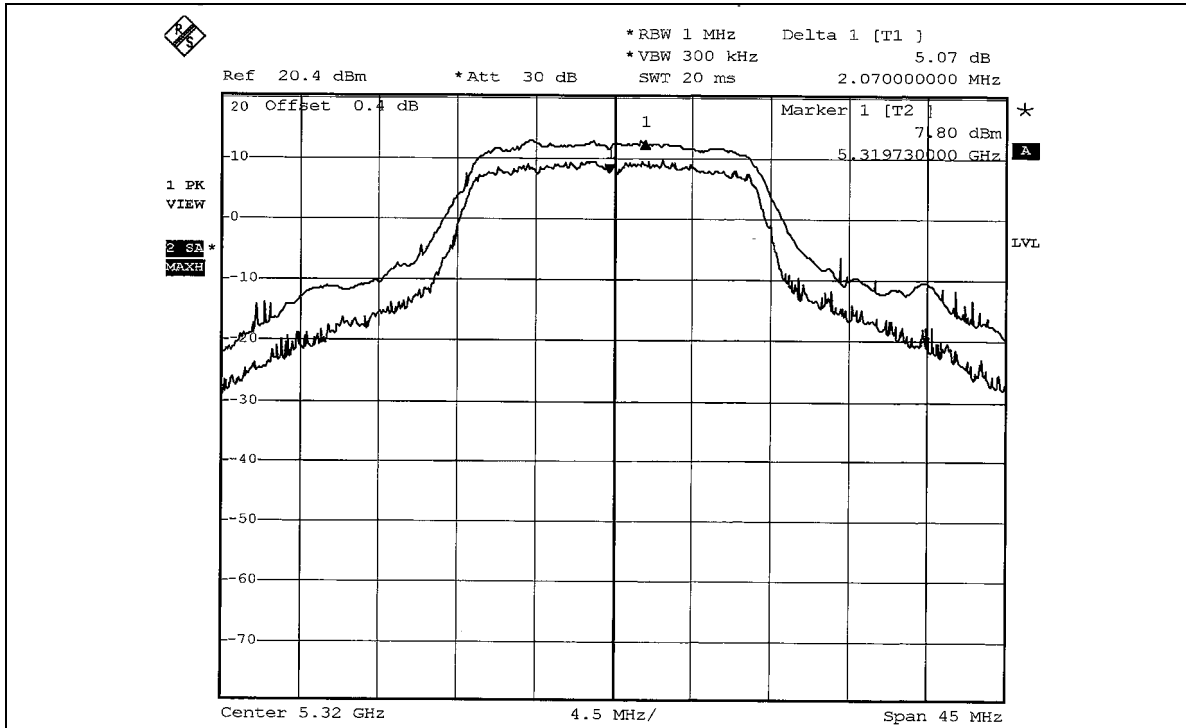



4.5 PEAK POWER SPECTRAL DENSITY MEASUREMENT

4.5.1 LIMITS OF PEAK POWER SPECTRAL DENSITY MEASUREMENT

Frequency Band	Limit
5.15 ~ 5.25GHz	4dBm
5.25 ~ 5.35GHz	11dBm
5.725 ~ 5.825GHz	17dBm

4.5.2 TEST INSTRUMENTS

Description & Manufacturer	Model No.	Serial No.	Calibrated Until
SPECTRUM ANALYZER	FSEK30	100049	Aug. 12, 2005

NOTE: The calibration interval of the above test instruments is 12 months and the calibrations are traceable to NML/ROC and NIST/USA.

4.5.3 TEST PROCEDURES

1. The transmitter output was connected to the spectrum analyzer.
2. Set RBW=1MHz, VBW=3MHz. The PPSD is the highest level found across the emission in any 1MHz band.

4.5.4 DEVIATION FROM TEST STANDARD

No deviation

4.5.5 TEST SETUP

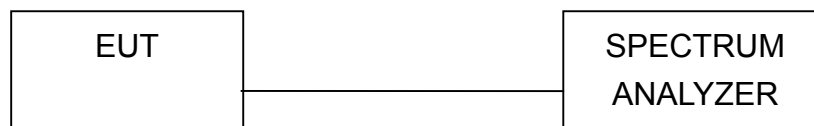

4.5.6 EUT OPERATING CONDITIONS

Same as 5.3.6



4.5.7 TEST RESULTS

802.11a OFDM modulation

EUT	notebook computer	MODEL	TA1 (with Intel WM3B2915ABG)
MODULATION TYPE	BPSK	TRANSFER RATE	6Mbps
INPUT POWER (SYSTEM)	120Vac, 60 Hz	ENVIRONMENTAL CONDITIONS	25deg.C, 65%RH, 991hPa
TESTED BY	Jamison Chan		

CHANNEL	CHANNEL FREQUENCY (MHz)	RF POWER LEVEL IN 1MHz BW (dBm)	MAXIMUM LIMIT (dBm)	PASS/FAIL
1	5180	2.47	4	PASS
4	5240	2.41	4	PASS
5	5260	3.52	11	PASS
8	5320	3.69	11	PASS



CH 1

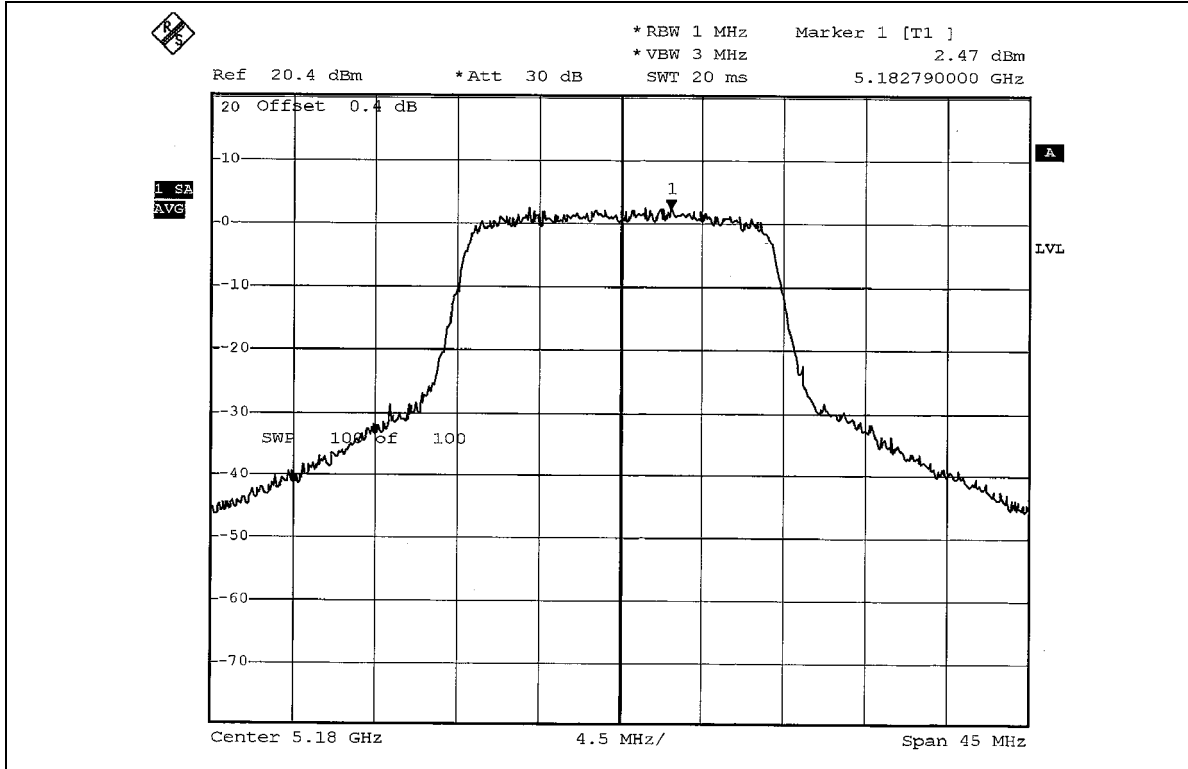

CH 4

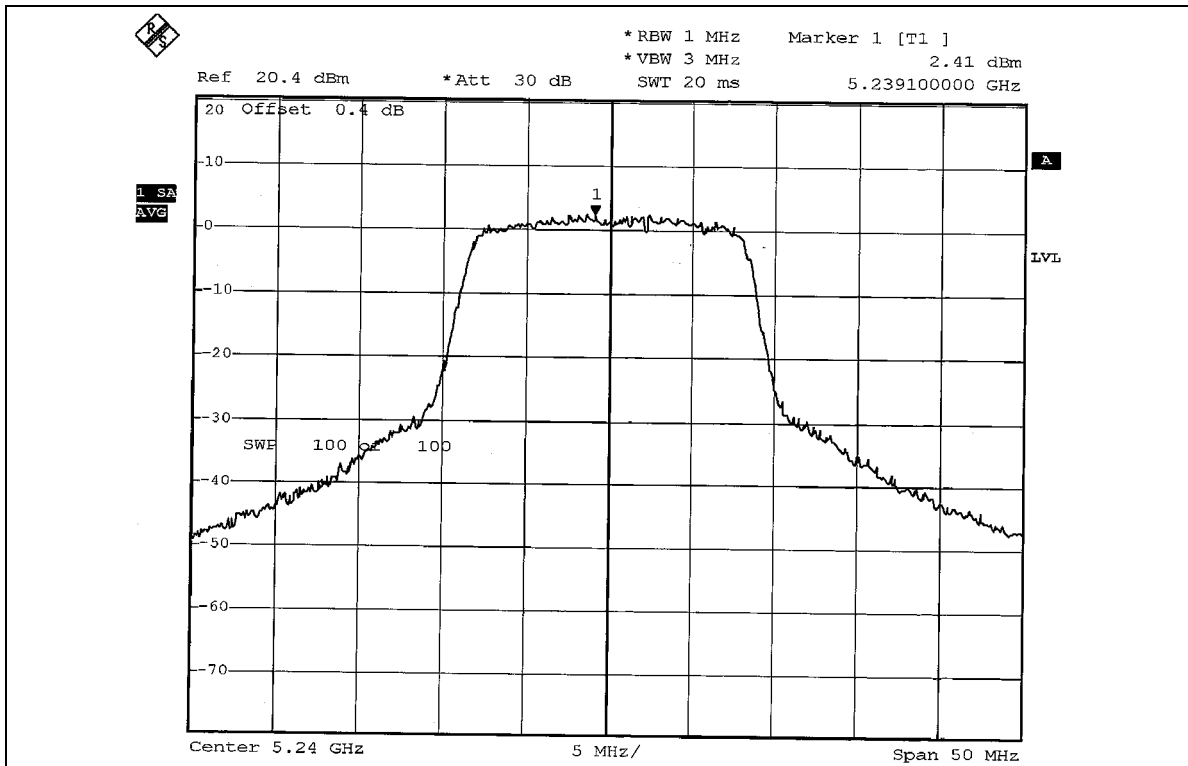



CH 5

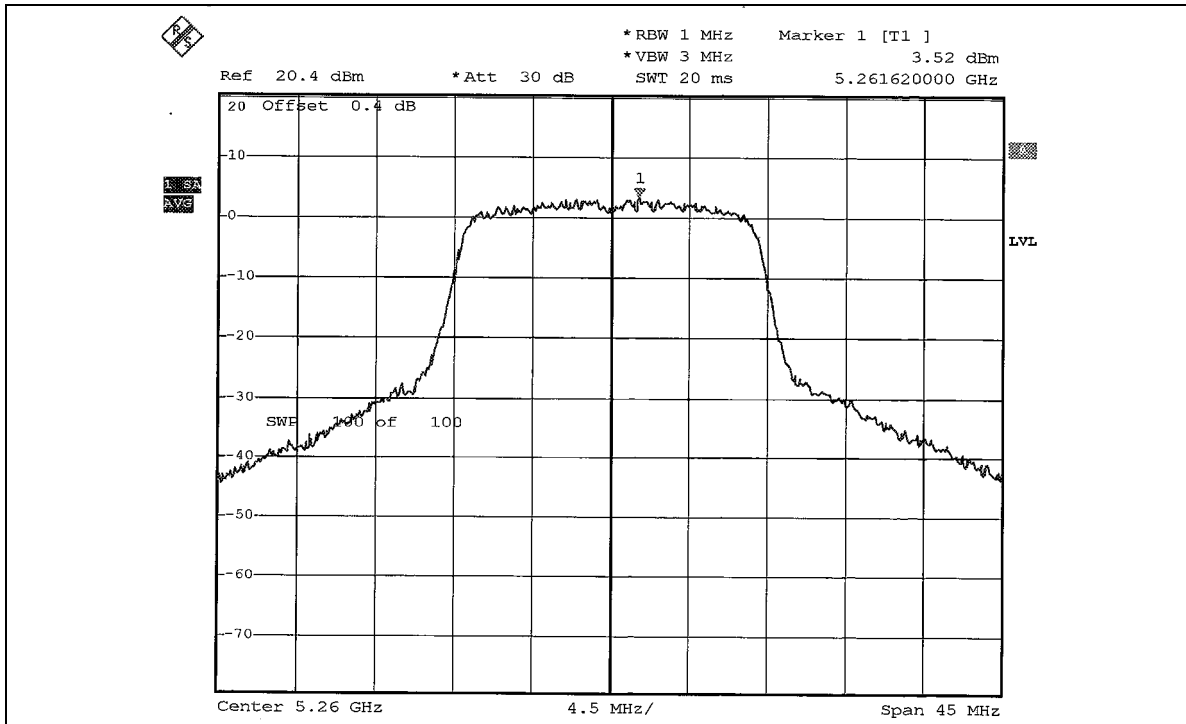

CH 8

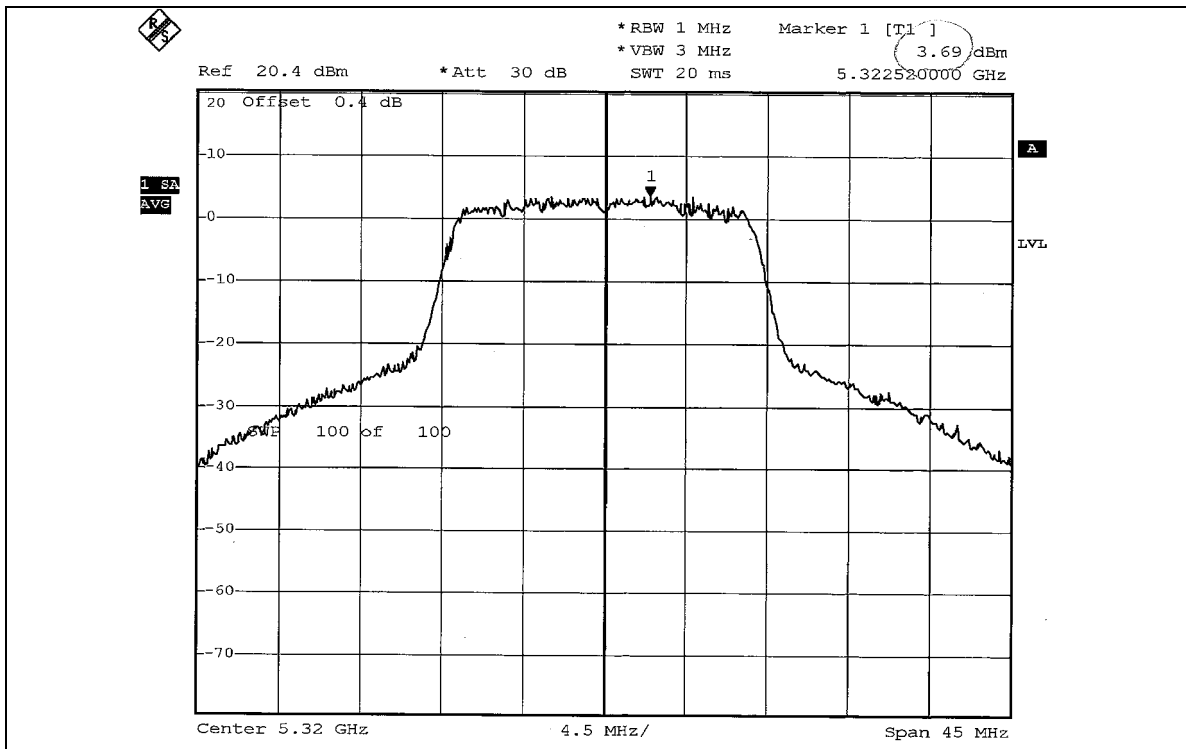



4.6 FREQUENCY STABILITY

4.6.1 LIMITS OF FREQUENCY STABILITY MEASUREMENT

The frequency tolerance of the carrier signal shall be maintained within +/- 0.02% of the operating frequency over a temperature variation of -30 degrees to 50 degrees C at normal supply voltage, and for a variation in the primary supply voltage from 85% to 115% of the rated supply voltage at a temperature of 20 degrees C.

4.6.2 TEST INSTRUMENTS

Description & Manufacturer	Model No.	Serial No.	Calibrated Until
ANRITSU SPECTRUM ANALYZER	MS2667C	M10281	Aug. 12, 2005
WIT STANDARD TEMPERATURE AND HUMIDITY CHAMBER	TH-4S-C	W901030	Aug. 12, 2005

NOTE: The calibration interval of the above test instruments is 12 months and the calibrations are traceable to NML/ROC and NIST/USA.

4.6.3 TEST PROCEDURE

1. The EUT was placed inside the environmental test chamber and powered by nominal DC voltage.
2. Turn the EUT on and couple its output to a spectrum analyzer.
3. Turn the EUT off and set the chamber to the highest temperature specified.
4. Allow sufficient time (approximately 30 min) for the temperature of the chamber to stabilize, turn the EUT on and measure the operating frequency after 2, 5, and 10 minutes.
5. Repeat step 2 and 3 with the temperature chamber set to the lowest temperature.
6. The test chamber was allowed to stabilize at +20 degree C for a minimum of 30 minutes. The supply voltage was then adjusted on the EUT from 85% to 115% and the frequency record.

4.6.4 DEVIATION FROM TEST STANDARD

No deviation

4.6.5 TEST SETUP

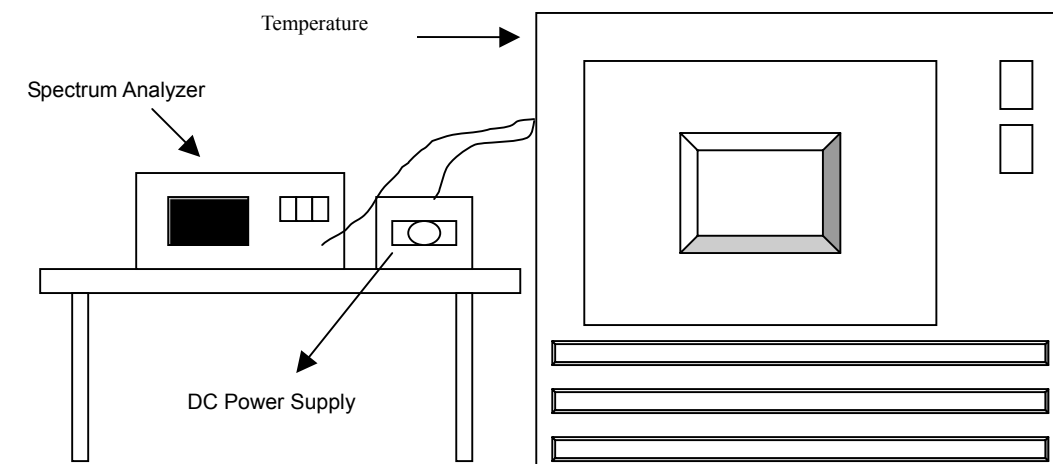

4.6.6 EUT OPERATING CONDITION

Same as Item 4.3.6



4.6.7 TEST RESULTS

		Operating frequency: 5320MHz				Limit : ± 0.015%			
Temp. (°C)	Power supply (Vac)	0 minute		2 minute		5 minute		10 minute	
		(MHz)	(%)	(MHz)	(%)	(MHz)	(%)	(MHz)	(%)
50	138	5319.97632	-0.0004451	5319.97637	-0.0004441	5319.97636	-0.0004445	5319.97638	-0.0004441
	120	5319.97634	-0.0004447	5319.97637	-0.0004442	5319.97632	-0.0004451	5319.97639	-0.0004438
	102	5319.97633	-0.0004450	5319.97636	-0.0004444	5319.97636	-0.0004446	5319.97637	-0.0004442
40	138	5319.97492	-0.0004714	5319.97494	-0.0004710	5319.97556	-0.0004594	5319.97485	-0.0004727
	120	5319.97493	-0.0004712	5319.97494	-0.0004711	5319.97563	-0.0004581	5319.97486	-0.0004726
	102	5319.97495	-0.0004708	5319.97493	-0.0004712	5319.97565	-0.0004577	5319.97488	-0.0004722
30	138	5319.97711	-0.0004303	5319.97724	-0.0004279	5319.97733	-0.0004261	5319.97713	-0.0004298
	120	5319.97711	-0.0004303	5319.97724	-0.0004279	5319.97733	-0.0004261	5319.97713	-0.0004298
	102	5319.97711	-0.0004303	5319.97724	-0.0004279	5319.97733	-0.0004261	5319.97713	-0.0004298
20	138	5319.97747	-0.0004236	5319.97748	-0.0004233	5319.97745	-0.0004238	5319.97754	-0.0004221
	120	5319.97750	-0.0004230	5319.97748	-0.0004234	5319.97745	-0.0004238	5319.97755	-0.0004220
	102	5319.97750	-0.0004230	5319.97748	-0.0003480	5319.97745	-0.0004238	5319.97755	-0.0004221
10	138	5319.98182	-0.0003417	5319.98149	-0.0003482	5319.98187	-0.0003408	5319.98177	-0.0003427
	120	5319.98183	-0.0003415	5319.98148	-0.0003486	5319.98188	-0.0003406	5319.98175	-0.0003430
	102	5319.98184	-0.0003413	5319.98146	-0.0002523	5319.98186	-0.0003407	5319.98140	-0.0003496
0	138	5319.98500	-0.0002820	5319.98658	-0.0002525	5319.98665	-0.0002510	5319.98667	-0.0002506
	120	5319.98650	-0.0002537	5319.98657	-0.0002528	5319.98667	-0.0002507	5319.98677	-0.0002487
	102	5319.98650	-0.0002537	5319.98655	-0.0001908	5319.98665	-0.0002509	5319.98647	-0.0002543
-10	138	5319.98981	-0.0001915	5319.98985	-0.0001905	5319.99056	-0.0001774	5319.99066	-0.0001756
	120	5319.98982	-0.0001913	5319.98987	-0.0001905	5319.99072	-0.0001744	5319.99056	-0.0001774
	102	5319.98982	-0.0001913	5319.98987	0.0004127	5319.99067	-0.0001754	5319.99020	-0.0001842
-20	138	5320.02182	0.0004102	5320.02195	0.0004121	5320.02196	0.0004127	5320.02183	0.0004103
	120	5320.02183	0.0004102	5320.02192	0.0004123	5320.02195	0.0004125	5320.02183	0.0004103
	102	5319.02183	-0.0183867	5320.02193	0.0004108	5320.02195	0.0004125	5320.02183	0.0004102
-30	138	5320.02184	0.0004106	5320.02185	0.0004107	5320.02188	0.0004113	5320.02187	0.0004112
	120	5320.02183	0.0004104	5320.02185	0.0004107	5320.02188	0.0004113	5320.02187	0.0004111
	102	5320.02185	0.0004107	5320.02185	0.0004107	5320.02188	0.0004113	5320.02187	0.0004111

4.7 BAND EDGES MEASUREMENT

4.7.1 TEST INSTRUMENTS

Description & Manufacturer	Model No.	Serial No.	Calibrated Until
SPECTRUM ANALYZER	FSEK30	100049	Aug. 12, 2005

NOTE: The calibration interval of the above test instruments is 12 months and the calibrations are traceable to NML/ROC and NIST/USA.

4.7.2 TEST PROCEDURE

The transmitter output was connected to the spectrum analyzer via a low lose cable. Set both RBW and VBW of spectrum analyzer to 1MHz with suitable frequency span including 100 MHz bandwidth from band edge. The band edges was measured and recorded.

4.7.3 EUT OPERATING CONDITION

The software provided by client to enable the EUT under transmission condition continuously at specific channel frequencies individually.

4.7.4 TEST RESULTS

For signals in the restricted bands above and below the 5.15 to 5.35GHz allocated band a measurement was made of the amplitude of the spurious emissions with respect to the intentional signals. The relative amplitude, in dBc, was applied to the average and peak filed strength of the intentional signal made on the OATS to calculate the field strength of the unintentional signals.

The spectrum plots (Peak RBW=VBW=1MHz; Average RBW=1MHz, VBW=10Hz) are attached on the following pages.

**802.11a OFDM modulation****Channel 1 (5180MHz)**

The band edge emission plot on page 53 shows 47.07dBc between carrier maximum power and local maximum emission in restrict band. The emission of carrier strength list in the test result of channel 1 is 105.01dBuV/m (Peak), so the maximum field strength in restrict band is $105.01 - 47.07 = 57.94$ dBuV/m which is under 74dBuV/m limit.

The band edge emission plot on page 53 shows 53.93dBc between carrier maximum power and local maximum emission in restrict band. The emission of carrier strength list in the test result of channel 1 is 95.14dBuV/m (Average), so the maximum field strength in restrict band is $95.14 - 53.93 = 41.21$ dBuV/m which is under 54dBuV/m limit.

Channel 8 (5320MHz)

The band edge emission plot on page 54 shows 41.61dBc between carrier maximum power and local maximum emission in restrict band. The emission of carrier strength list in the test result of channel 8 is 104.96dBuV/m (Peak), so the maximum field strength in restrict band is $104.96 - 41.61 = 63.35$ dBuV/m which is under 74dBuV/m limit.

The band edge emission plot on page 55 shows 49.75dBc between carrier maximum power and local maximum emission in restrict band. The emission of carrier strength list in the test result of channel 8 is 94.81dBuV/m (Average), so the maximum field strength in restrict band is $94.81 - 49.75 = 45.06$ dBuV/m which is under 54dBuV/m limit.



802.11a OFDM modulation

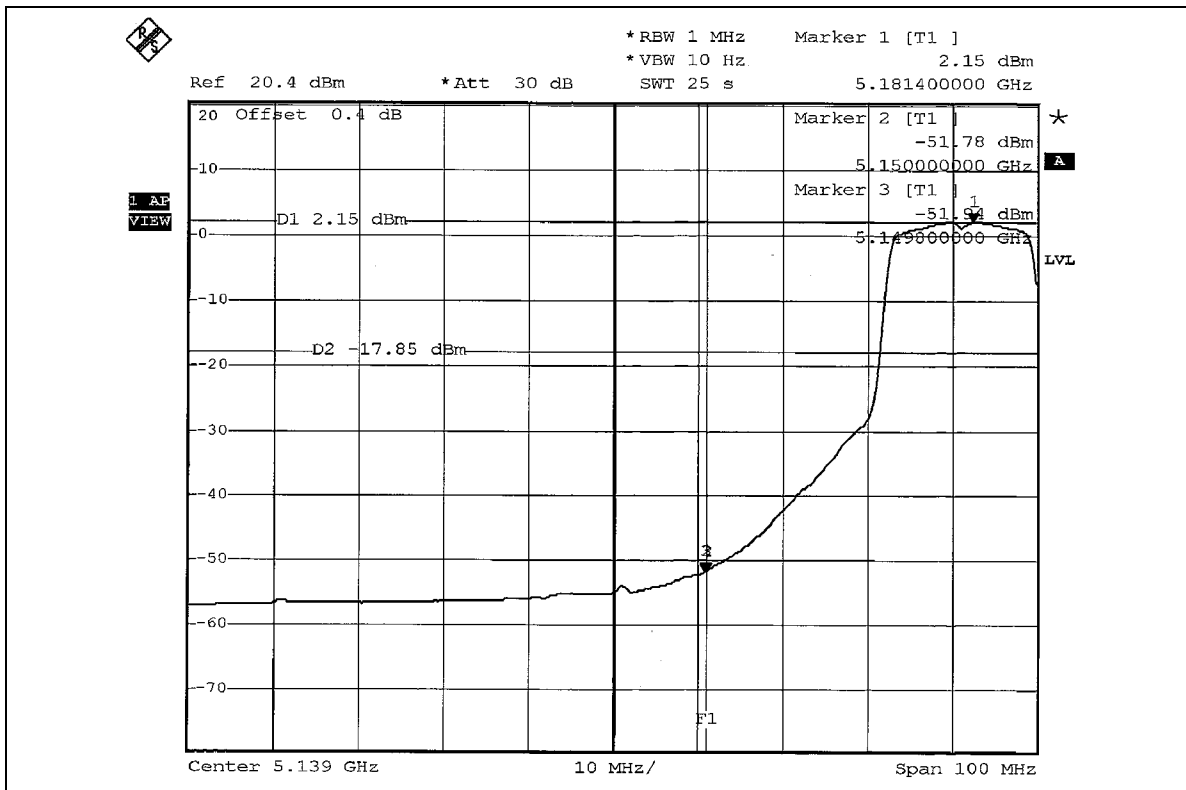
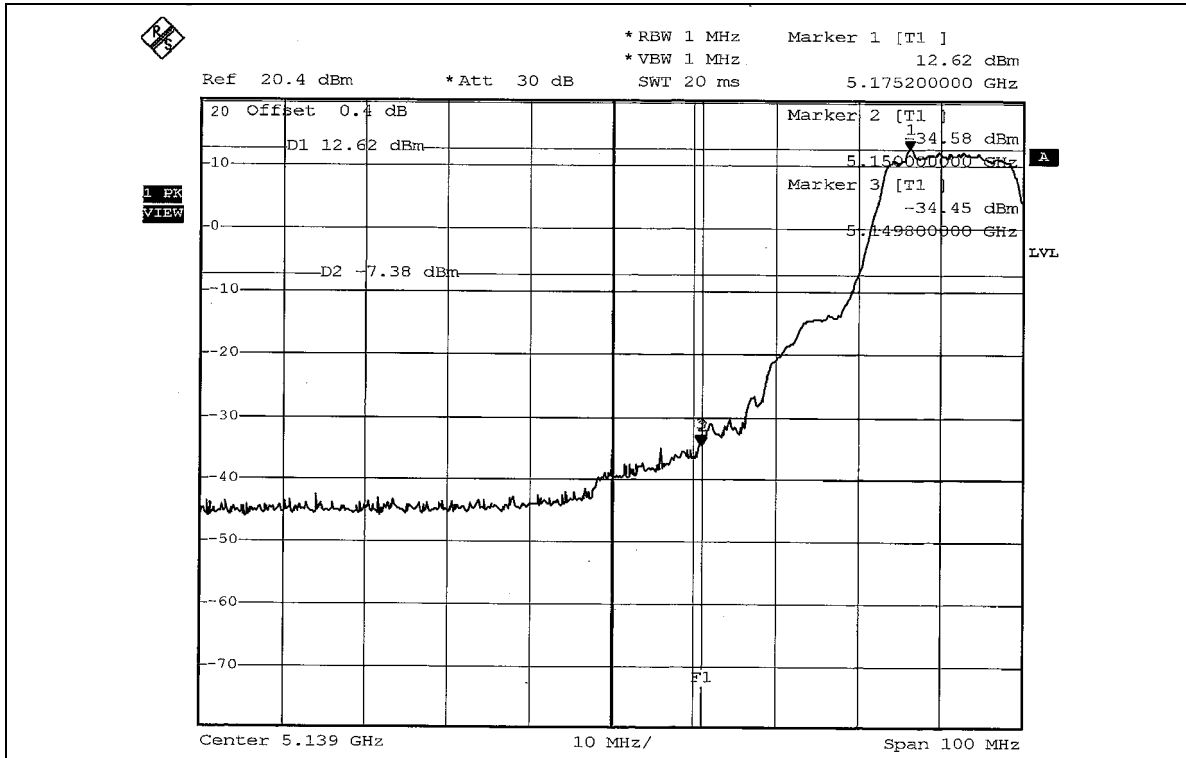

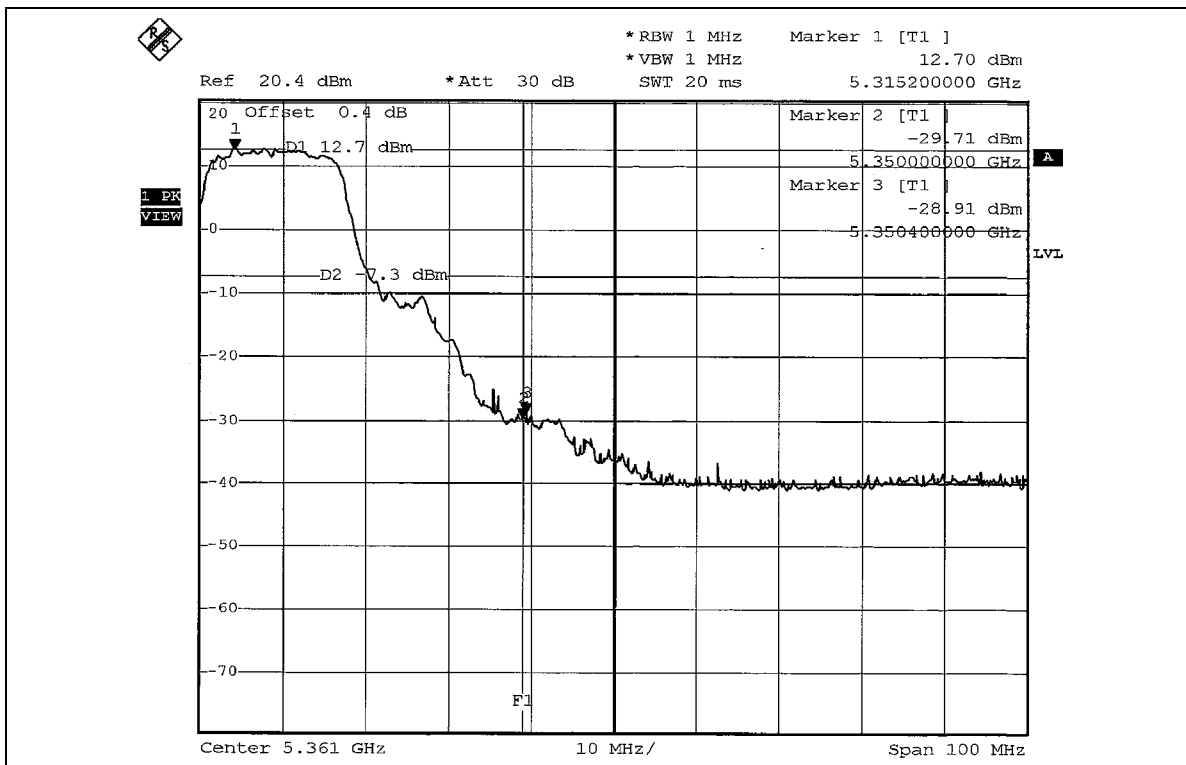
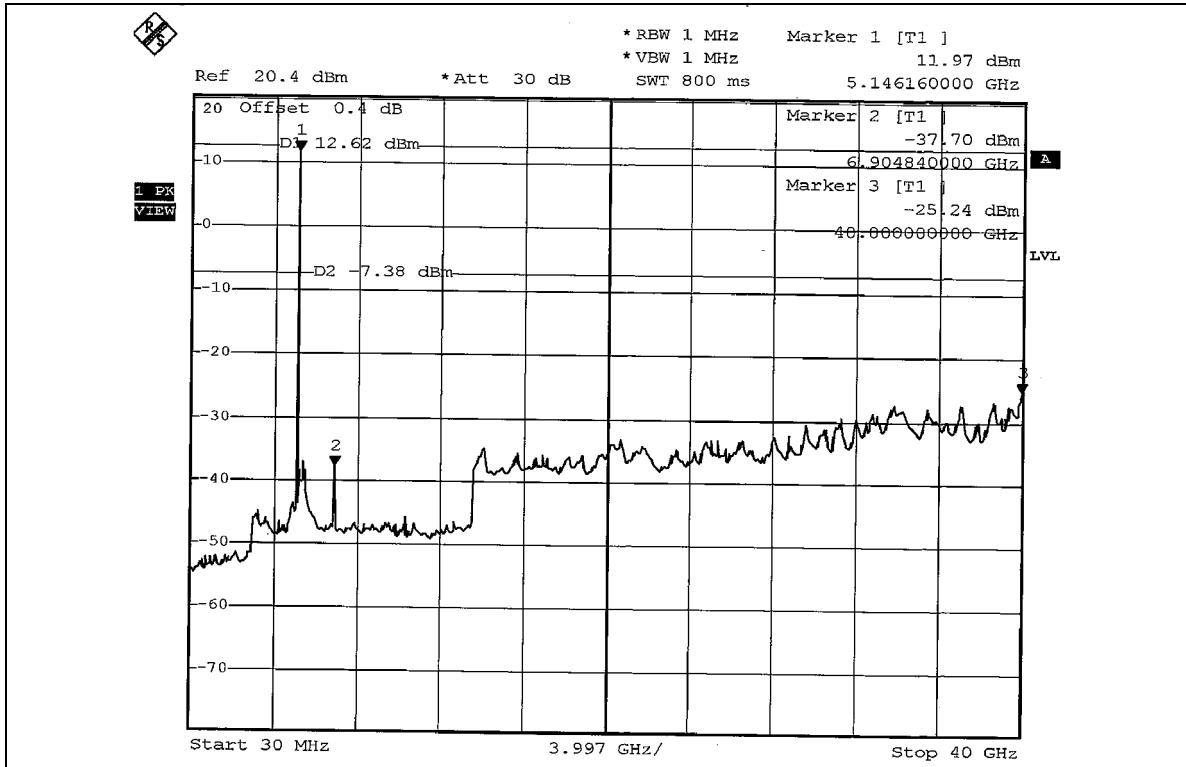

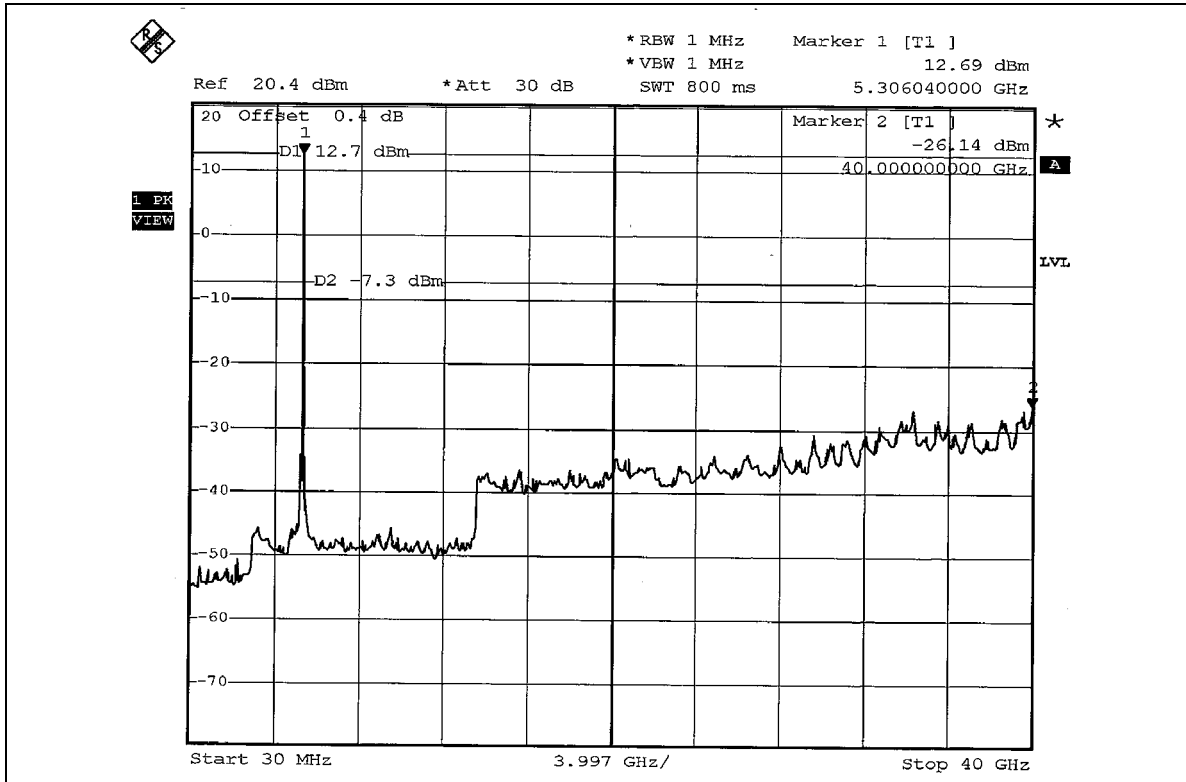
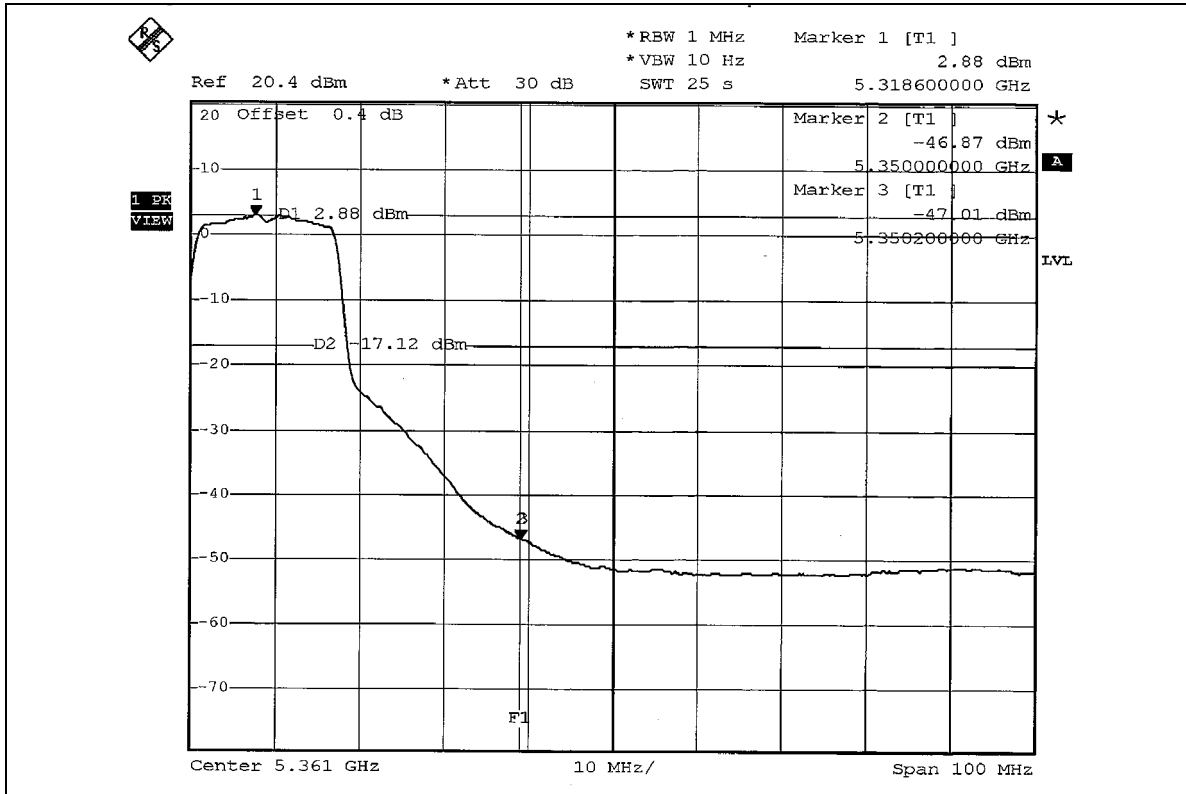



4.8 ANTENNA REQUIREMENT

4.8.1 STANDARD APPLICABLE

For intentional device, according to FCC 47 CFR Section 15.203, an intentional radiator shall be designed to ensure that no antenna other than that furnished by the responsible party shall be used with the device.

And according to FCC 47 CFR Section 15.407(a), if transmitting antennas of directional gain greater than 6dBi are used, the power shall be reduced by the amount in dB that the directional gain of the antenna exceeds 6dBi.

4.8.2 ANTENNA CONNECTED CONSTRUCTION

The antenna used in this product is PIFA antenna with UFL connector. The maximum Gain of the antenna is 1.90dBi.

5. PHOTOGRAPHS OF THE TEST CONFIGURATION

CONDUCTED EMISSION TEST

Test Mode 1

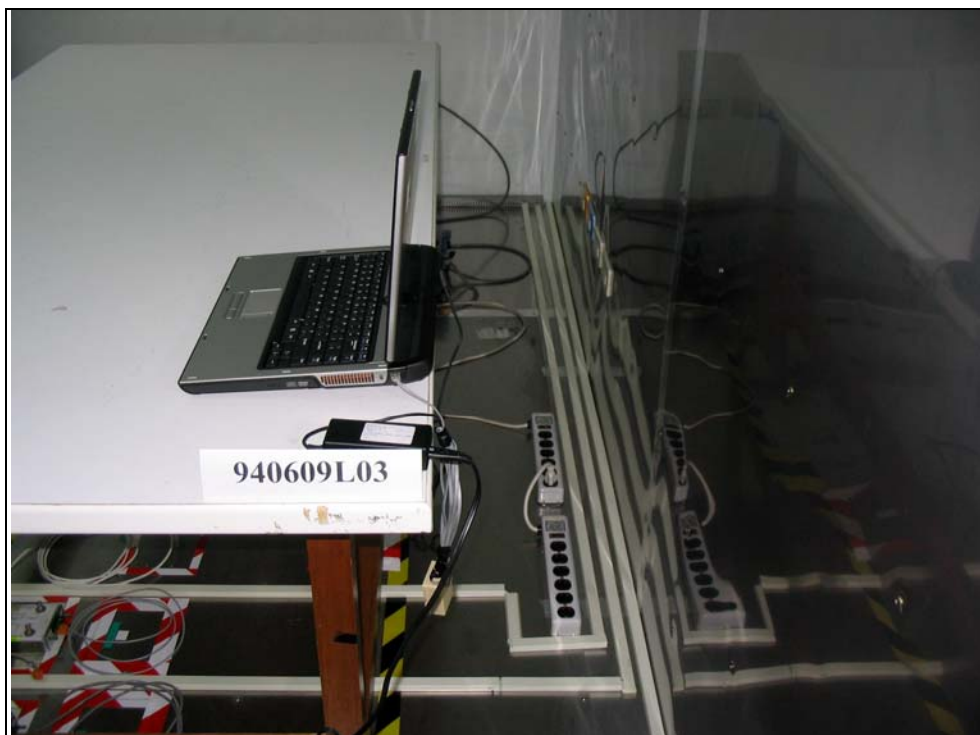

Test Mode 2

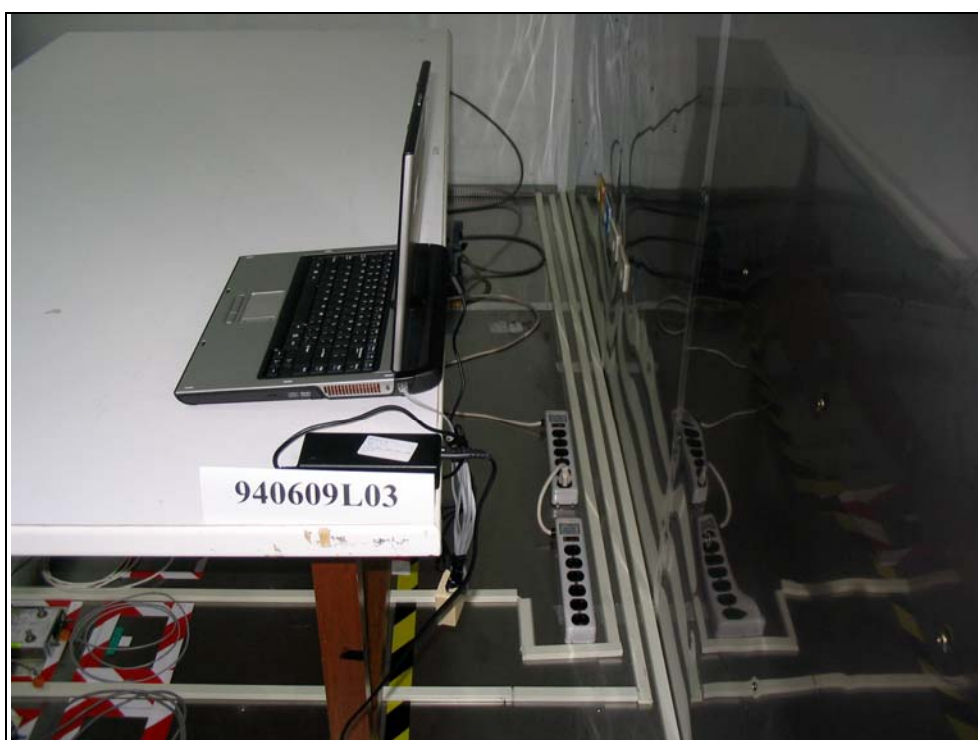
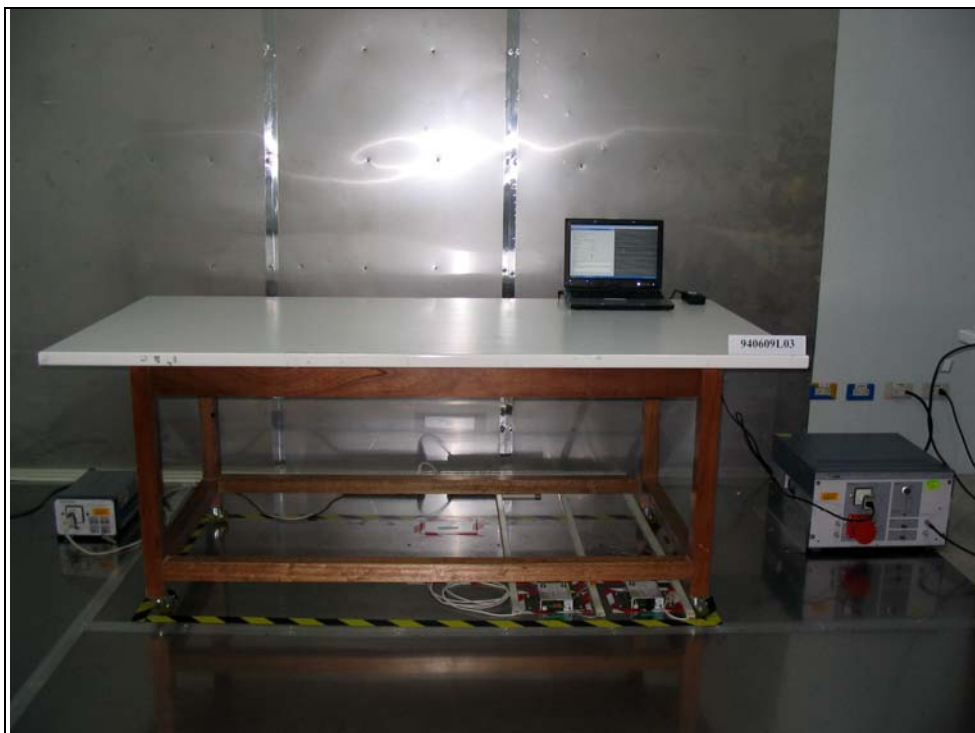

RADIATED EMISSION TEST
Test Mode 1

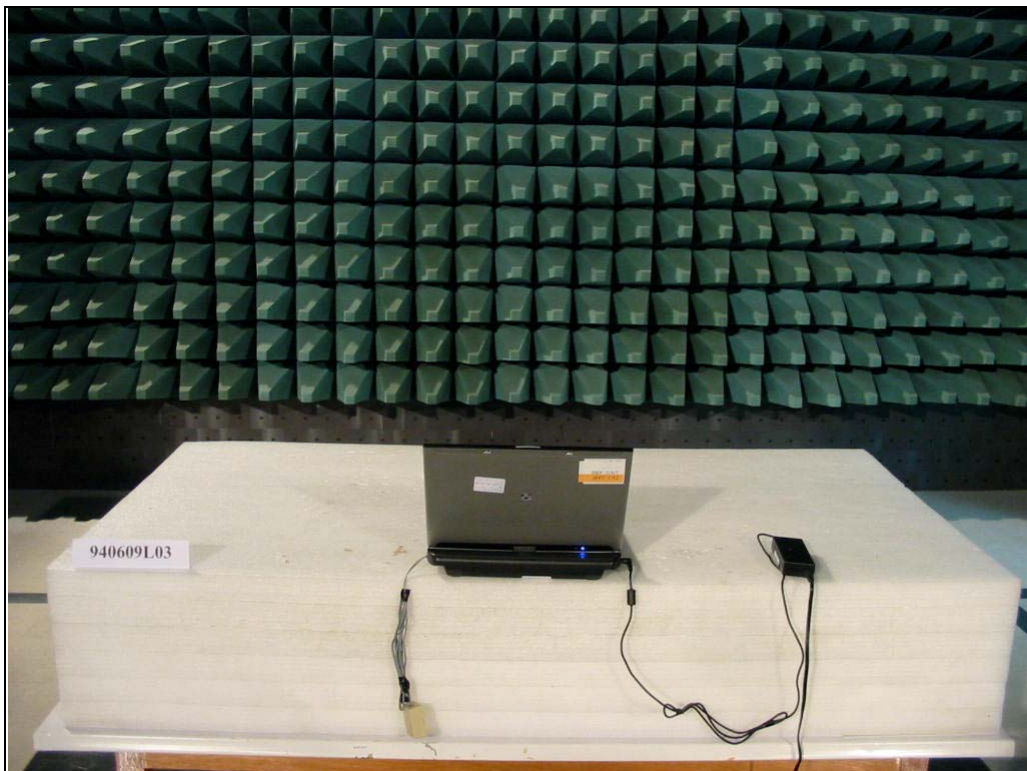
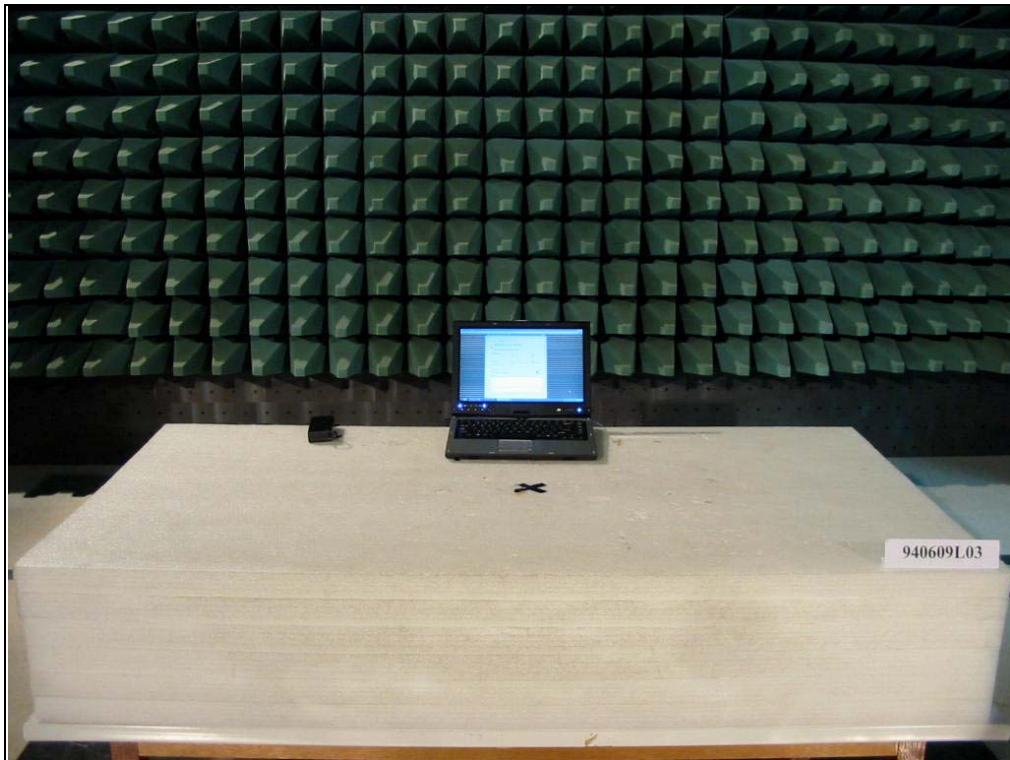

Test Mode 2

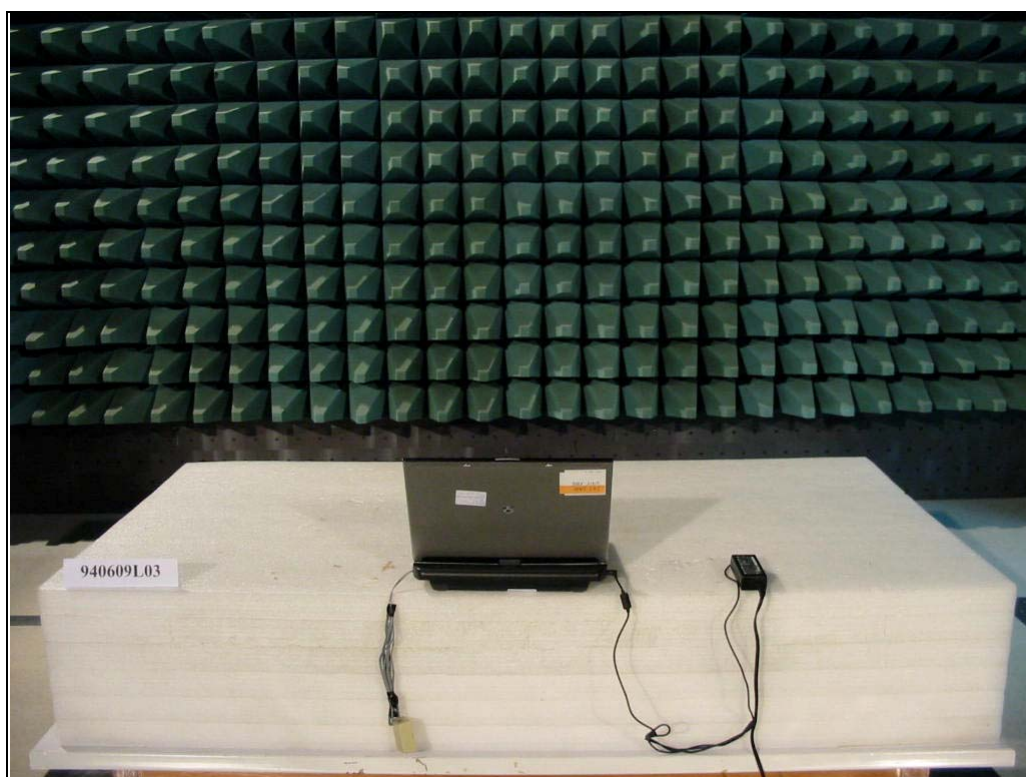
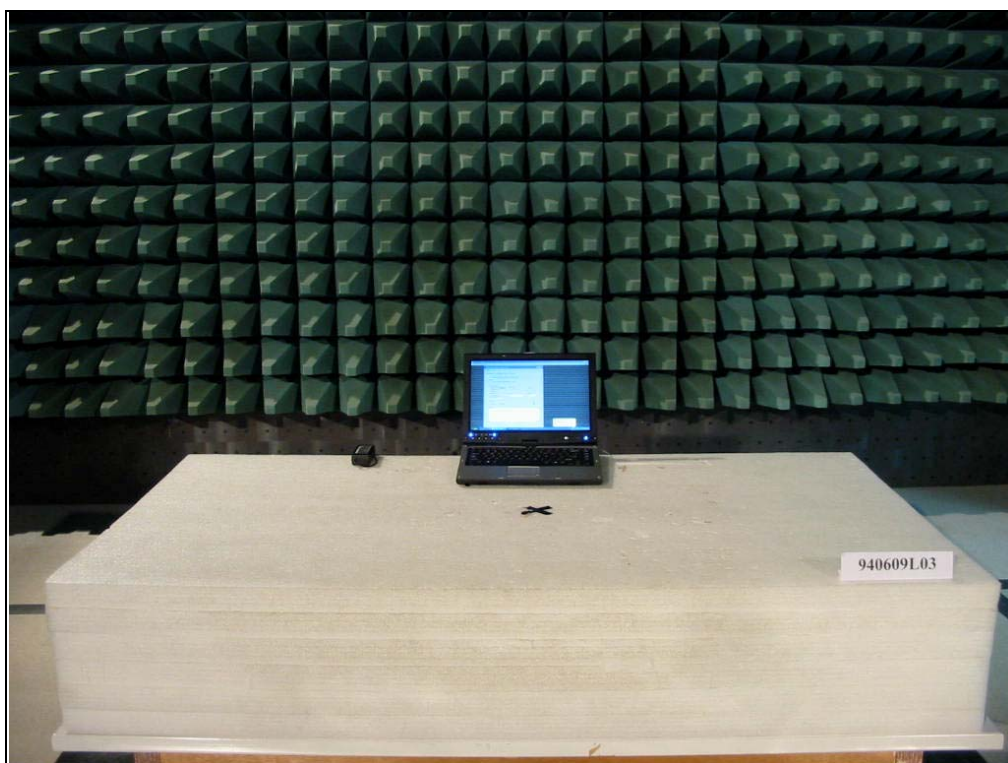



6. INFORMATION ON THE TESTING LABORATORIES

We, ADT Corp., were founded in 1988 to provide our best service in EMC, Radio, Telecom and Safety consultation. Our laboratories are accredited and approved by the following approval agencies according to ISO/IEC 17025:

USA	FCC, NVLAP, UL, A2LA
Germany	TUV Rheinland
Japan	VCCI
Norway	NEMKO
Canada	INDUSTRY CANADA , CSA
R.O.C.	CNLA, BSMI, DGT
Netherlands	Telefication
Singapore	PSB , GOST-ASIA(MOU)
Russia	CERTIS(MOU)

Copies of accreditation certificates of our laboratories obtained from approval agencies can be downloaded from our web site:

www.adt.com.tw/index.5/phtml. If you have any comments, please feel free to contact us at the following:

Linko EMC/RF Lab:

Tel: 886-2-26052180

Fax: 886-2-26052943

Hsin Chu EMC/RF Lab:

Tel: 886-3-5935343

Fax: 886-3-5935342

Hwa Ya EMC/RF/Safety Telecom Lab:

Tel: 886-3-3183232

Fax: 886-3-3185050

Linko RF Lab.

Tel: 886-3-3270910

Fax: 886-3-3270892

Web Site: www.adt.com.tw

The address and road map of all our labs can be found in our web site also