

DFS Test Report

Report No.: RFBCKT-WTW-P22010886-2

FCC ID: HFSQTAD53N

Test Model: QTAD53

Received Date: Feb. 10, 2022

Test Date: Mar. 15 ~ Mar. 23, 2022

Issued Date: Mar. 30, 2022

Applicant: Quanta Computer Inc.

Address: NO.188, Wenhua 2nd Rd., Guishan Dist., Taoyuan City 33377,
Taiwan(R.O.C)

Issued By: Bureau Veritas Consumer Products Services (H.K.) Ltd., Taoyuan Branch
Lin Kou Laboratories

Lab Address: No. 47-2, 14th Ling, Chia Pau Vil., Lin Kou Dist., New Taipei City, Taiwan

Test Location: No. 19, Hwa Ya 2nd Rd., Wen Hwa Vil., Kwei Shan Dist., Taoyuan City
33383, TAIWAN

**FCC Registration /
Designation Number:** 788550 / TW0003



This report is for your exclusive use. Any copying or replication of this report to or for any other person or entity, or use of our name or trademark, is permitted only with our prior written permission. This report sets forth our findings solely with respect to the test samples identified herein. The results set forth in this report are not indicative or representative of the quality or characteristics of the lot from which a test sample was taken or any similar or identical product unless specifically and expressly noted. Our report includes all of the tests requested by you and the results thereof based upon the information that you provided to us. You have 60 days from date of issuance of this report to notify us of any material error or omission caused by our negligence, provided, however, that such notice shall be in writing and shall specifically address the issue you wish to raise. A failure to raise such issue within the prescribed time shall constitute your unqualified acceptance of the completeness of this report, the tests conducted and the correctness of the report contents. Unless specifically mentioned, the uncertainty of measurement has been explicitly taken into account to declare the compliance or non-compliance to the specification.

Table of Contents

| | |
|---------------------------------------------------------------|-----------|
| Release Control Record | 3 |
| 1 Certificate of Conformity | 4 |
| 2 EUT Information | 5 |
| 2.1 Operating Frequency Bands and Mode of EUT..... | 5 |
| 2.2 EUT Software and Firmware Version..... | 5 |
| 2.3 Description of Available Antennas to the EUT..... | 5 |
| 2.4 EUT Maximum Conducted Power..... | 6 |
| 2.5 EUT Maximum E.I.R.P. Power..... | 8 |
| 2.6 Transmit Power Control (TPC)..... | 9 |
| 2.7 Statement of Manufacturer..... | 9 |
| 3 U-NII DFS Rule Requirements | 10 |
| 3.1 Working Modes and Required Test Items..... | 10 |
| 3.2 Test Limits and Radar Signal Parameters..... | 11 |
| 4 Test & Support Equipment List | 14 |
| 4.1 Test Instruments..... | 14 |
| 4.2 Description of Support Units..... | 14 |
| 5 Test Procedure | 15 |
| 5.1 DFS Measurement System..... | 15 |
| 5.2 Calibration of DFS Detection Threshold Level..... | 16 |
| 5.3 Deviation from Test Standard..... | 16 |
| 5.4 Radiated Test Setup Configuration..... | 17 |
| 5.4.1 Master Mode..... | 17 |
| 6 Test Results | 18 |
| 6.1 Summary of Test Results..... | 18 |
| 6.1.1 Master mode..... | 18 |
| 6.2 Test Results..... | 19 |
| 6.2.1 Test Mode: Device Operating In Master Mode..... | 19 |
| 6.2.2 U-NII Detection Bandwidth..... | 24 |
| 6.2.3 Channel Availability Check Time..... | 31 |
| 6.2.4 Channel Closing Transmission and Channel Move Time..... | 33 |
| 6.2.5 Non-Occupancy Period..... | 63 |
| 6.2.6 Uniform Spreading..... | 66 |
| 7 Information of the Testing Laboratories | 67 |
| Appendix-A | 68 |



Release Control Record

| Issue No. | Description | Date Issued |
|------------------------|------------------|---------------|
| RFBCKT-WTW-P22010886-2 | Original Release | Mar. 30, 2022 |

1 Certificate of Conformity

Product: 5G Hotspot
Brand: T-Mobile
Test Model: QTAD53
Sample Status: Engineering Sample
Applicant: Quanta Computer Inc.
Test Date: Mar. 15 ~ Mar. 23, 2022
Standards: FCC Part 15, Subpart E (Section 15.407)
References Test Guidance: KDB 905462 D02 UNII DFS Compliance Procedures New Rules v02
KDB 905462 D03 UNII Clients Without Radar Detection New Rules v01r02

The above equipment has been tested by **Bureau Veritas Consumer Products Services (H.K.) Ltd., Taoyuan Branch**, and found compliance with the requirement of the above standards. The test record, data evaluation & Equipment Under Test (EUT) configurations represented herein are true and accurate accounts of the measurements of the sample's RF characteristics under the conditions specified in this report.

Prepared by :  , **Date:** Mar. 30, 2022
Polly Chien / Specialist

Approved by :  , **Date:** Mar. 30, 2022
Jeremy Lin / Project Engineer

2 EUT Information

2.1 Operating Frequency Bands and Mode of EUT

Table 1: Operating Frequency Bands and Mode of EUT

| Operational Mode | Operating Frequency Range | |
|------------------|---------------------------|--------------|
| | 5250~5350MHz | 5470~5725MHz |
| Master | ✓ | ✓ |

* The bandwidth and modulation are similar for HT20/HT40 on 802.11n mode and VHT20/VHT40/VHT80 on 802.11ac mode and HE20/HE40/HE80 on 802.11ax mode. Therefore the investigated worst case is the representative mode in test report. The worst case was found 802.11ax mode, therefore chosen for the final test.

* This device does not support 802.11ax channel puncturing

NOTE: The EUT doesn't operate in 5600 ~ 5650MHz via software controls.

2.2 EUT Software and Firmware Version

Table 2: The EUT Software/Firmware Version

| No. | Product | Test Model No. | Software/Firmware Version |
|-----|------------|----------------|---------------------------|
| 1 | 5G Hotspot | QTAD53 | ND53.22070601 |

2.3 Description of Available Antennas to the EUT

Table 3: Directional Gain

| ANT No. | Antenna Type | Operation Frequency Range (MHz) | Gain (dBi) |
|---------|--------------|---------------------------------|------------|
| 1 | PIFA | 5250~5350 | 1.09 |
| 1 | PIFA | 5470~5725 | 3.49 |
| 2 | PIFA | 5250~5350 | 1.72 |
| 2 | PIFA | 5470~5725 | 2.48 |

* The above Antenna information is declared by manufacturer and for more detailed features description, please refer to the manufacturer's specifications, the laboratory shall not be held responsible.

* 5250-5350MHz: Directional gain = $10 \log\left[\frac{(10^{G1/20} + 10^{G2/20} + \dots + 10^{GN/20})^2}{2}\right] = 4.42\text{dBi}$.

* 5470-5725MHz: Directional gain = $10 \log\left[\frac{(10^{G1/20} + 10^{G2/20} + \dots + 10^{GN/20})^2}{2}\right] = 6.01\text{dBi}$.

2.4 EUT Maximum Conducted Power

Table 4: The Measured Conducted Output Power

802.11a (1TX)

| Frequency Band (MHz) | Max. Power | |
|----------------------|--------------------|-------------------|
| | Output Power (dBm) | Output Power (mW) |
| 5250~5350 | 19.21 | 83.368 |
| 5470~5725 | 19.33 | 85.704 |

802.11ac VHT20 (2TX)

| Frequency Band (MHz) | Max. Power | |
|----------------------|--------------------|-------------------|
| | Output Power (dBm) | Output Power (mW) |
| 5250~5350 | 20.77 | 119.493 |
| 5470~5725 | 21.15 | 130.464 |

802.11ac VHT40 (2TX)

| Frequency Band (MHz) | Max. Power | |
|----------------------|--------------------|-------------------|
| | Output Power (dBm) | Output Power (mW) |
| 5250~5350 | 21.34 | 135.991 |
| 5470~5725 | 21.85 | 153.152 |

802.11ac VHT80 (2TX)

| Frequency Band (MHz) | Max. Power | |
|----------------------|--------------------|-------------------|
| | Output Power (dBm) | Output Power (mW) |
| 5250~5350 | 17.09 | 51.223 |
| 5470~5725 | 11.67 | 14.673 |

802.11ax HE20 (2TX)

| Frequency Band (MHz) | Max. Power | |
|----------------------|--------------------|-------------------|
| | Output Power (dBm) | Output Power (mW) |
| 5250~5350 | 20.82 | 120.732 |
| 5470~5725 | 21.22 | 132.424 |

802.11ax HE40 (2TX)

| Frequency Band (MHz) | Max. Power | |
|----------------------|--------------------|-------------------|
| | Output Power (dBm) | Output Power (mW) |
| 5250~5350 | 21.40 | 137.968 |
| 5470~5725 | 21.95 | 156.529 |

802.11ax HE80 (2TX)

| Frequency Band (MHz) | Max. Power | |
|----------------------|--------------------|-------------------|
| | Output Power (dBm) | Output Power (mW) |
| 5250~5350 | 17.15 | 51.936 |
| 5470~5725 | 11.75 | 14.946 |

2.5 EUT Maximum E.I.R.P. Power

Table 5: The EIRP Output Power List

802.11a

| Frequency Band (MHz) | Max. EIRP Power | |
|----------------------|--------------------|-------------------|
| | Output Power (dBm) | Output Power (mW) |
| 5250~5350 | 20.93 | 123.880 |
| 5470~5725 | 22.82 | 191.426 |

802.11ac VHT20

| Frequency Band (MHz) | Max. EIRP Power | |
|----------------------|--------------------|-------------------|
| | Output Power (dBm) | Output Power (mW) |
| 5250~5350 | 22.49 | 177.419 |
| 5470~5725 | 24.64 | 291.072 |

802.11ac VHT40

| Frequency Band (MHz) | Max. EIRP Power | |
|----------------------|--------------------|-------------------|
| | Output Power (dBm) | Output Power (mW) |
| 5250~5350 | 23.06 | 202.302 |
| 5470~5725 | 25.34 | 341.979 |

802.11ac VHT80

| Frequency Band (MHz) | Max. EIRP Power | |
|----------------------|--------------------|-------------------|
| | Output Power (dBm) | Output Power (mW) |
| 5250~5350 | 18.81 | 76.033 |
| 5470~5725 | 15.16 | 32.810 |

802.11ax HE20

| Frequency Band (MHz) | Max. EIRP Power | |
|----------------------|--------------------|-------------------|
| | Output Power (dBm) | Output Power (mW) |
| 5250~5350 | 22.54 | 179.473 |
| 5470~5725 | 24.71 | 295.801 |

802.11ax HE40

| Frequency Band (MHz) | Max. EIRP Power | |
|----------------------|--------------------|-------------------|
| | Output Power (dBm) | Output Power (mW) |
| 5250~5350 | 23.12 | 205.116 |
| 5470~5725 | 25.44 | 349.945 |

802.11ax HE80

| Frequency Band (MHz) | Max. EIRP Power | |
|----------------------|--------------------|-------------------|
| | Output Power (dBm) | Output Power (mW) |
| 5250~5350 | 18.87 | 77.090 |
| 5470~5725 | 15.24 | 33.420 |

2.6 Transmit Power Control (TPC)

U-NII devices operating in the 5.25-5.35 GHz band and the 5.47-5.725 GHz band shall employ a TPC mechanism. The U-NII device is required to have the capability to operate at least 6 dB below the mean EIRP value of 30 dBm. A TPC mechanism is not required for systems with an e.i.r.p. of less than 500 mW.

Maximum EIRP of this device is **349.945mW** which is less than 500mW, therefore it's not require TPC function.

The UUT can adjust a transmitter's output power based on the signal level present at the receiver. TPC is auto controlled by software

| Applicable | E.I.R.P | FCC 15.407 (h)(1) |
|------------|---------|----------------------------------------------------------------------------|
| | >500mW | The TPC mechanism is required for system with an E.I.R.P of above 500Mw |
| √ | <500mW | The TPC mechanism is not required for system with an E.I.R.P of less 500mW |

2.7 Statement of Manufacturer

Manufacturer statement confirming that information regarding the parameters of the detected Radar Waveforms is not available to the end user.

3 U-NII DFS Rule Requirements

3.1 Working Modes and Required Test Items

The manufacturer shall state whether the UUT is capable of operating as a Master and/or a Client. If the UUT is capable of operating in more than one operating mode then each operating mode shall be tested separately. See tables 6 and 7 for the applicability of DFS requirements for each of the operational modes.

Table 6: Applicability of DFS Requirements Prior To Use a Channel

| Requirement | Operational Mode | | |
|---------------------------------|------------------|--------------------------------|-----------------------------|
| | Master | Client without radar detection | Client with radar detection |
| Non-Occupancy Period | ✓ | ✓ note | ✓ |
| DFS Detection Threshold | ✓ | Not required | ✓ |
| Channel Availability Check Time | ✓ | Not required | Not required |
| U-NII Detection Bandwidth | ✓ | Not required | ✓ |

Note: Per KDB 905462 D03 UNII Clients Without Radar Detection New Rules v01r02 section (b)(5/6), If the client moves with the master, the device is considered compliant if nothing appears in the client non-occupancy period test. For devices that shut down (rather than moving channels), no beacons should appear. An analyzer plot that contains a single 30-minute sweep on the original channel.

Table 7: Applicability of DFS Requirements during Normal Operation.

| Requirement | Operational Mode | |
|-----------------------------------|---------------------------------------|--------------------------------|
| | Master or Client with radar detection | Client without radar detection |
| DFS Detection Threshold | ✓ | Not required |
| Channel Closing Transmission Time | ✓ | ✓ |
| Channel Move Time | ✓ | ✓ |
| U-NII Detection Bandwidth | ✓ | Not required |

| Additional requirements for devices with multiple bandwidth modes | Master or Client with radar detection | Client without radar detection |
|-------------------------------------------------------------------|---------------------------------------|------------------------------------------------------|
| U-NII Detection Bandwidth and Statistical Performance Check | All BW modes must be tested | Not required |
| Channel Move Time and Channel Closing Transmission Time | Test using widest BW mode available | Test using the widest BW mode available for the link |
| All other tests | Any single BW mode | Not required |

Note: Frequencies selected for statistical performance check (Section 7.8.4) should include several frequencies within the radar detection bandwidth and frequencies near the edge of the radar detection bandwidth. For 802.11 devices it is suggested to select frequencies in each of the bonded 20 MHz channels and the channel center frequency.

3.2 Test Limits and Radar Signal Parameters

Detection Threshold Values

Table 8: DFS Detection Thresholds for Master Devices And Client Devices With Radar Detection

| Maximum Transmit Power | Value (See Notes 1, 2, and 3) |
|------------------------------------------------------------------------------|----------------------------------|
| EIRP \geq 200 milliwatt | -64 dBm |
| EIRP < 200 milliwatt and power spectral density < 10 dBm/MHz | -62 dBm |
| EIRP < 200 milliwatt that do not meet the power spectral density requirement | -64 dBm |

Note 1: This is the level at the input of the receiver assuming a 0 dBi receive antenna.

Note 2: Throughout these test procedures an additional 1 dB has been added to the amplitude of the test transmission waveforms to account for variations in measurement equipment. This will ensure that the test signal is at or above the detection threshold level to trigger a DFS response.

Note3: EIRP is based on the highest antenna gain. For MIMO devices refer to KDB Publication 662911 D01.

Table 9: DFS Response Requirement Values

| Parameter | Value |
|-----------------------------------|-----------------------------------------------------------------------------------------------------------|
| Non-occupancy period | Minimum 30 minutes |
| Channel Availability Check Time | 60 seconds |
| Channel Move Time | 10 seconds See Note 1. |
| Channel Closing Transmission Time | 200 milliseconds + an aggregate of 60 milliseconds over remaining 10 second period. See Notes 1 and 2. |
| U-NII Detection Bandwidth | Minimum 100% of the U-NII 99% transmission power bandwidth. See Note 3 |

Note 1: Channel Move Time and the Channel Closing Transmission Time should be performed with Radar Type 0. The measurement timing begins at the end of the Radar Type 0 burst.

Note 2: The Channel Closing Transmission Time is comprised of 200 milliseconds starting at the beginning of the Channel Move Time plus any additional intermittent control signals required to facilitate a Channel move (an aggregate of 60 milliseconds) during the remainder of the 10 second period. The aggregate duration of control signals will not count quiet periods in between transmissions.

Note 3: During the U-NII Detection Bandwidth detection test, radar type 0 should be used. For each frequency step the minimum percentage of detection is 90 percent. Measurements are performed with no data traffic.

Parameters of DFS Test Signals

Step intervals of 0.1 microsecond for Pulse Width, 1 microsecond for PRI, 1 MHz for chirp width and 1 for the number of pulses will be utilized for the random determination of specific test waveforms.

Table 10: Short Pulse Radar Test Waveforms

| Radar Type | Pulse Width (μsec) | PRI (μsec) | Number of Pulses | Minimum Percentage of Successful Detection | Minimum Number of Trials |
|--------------------------------------------------------------------------------------------------------------------------------------|--------------------|-----------------------------------------------------------------------------------------------------------------------------------------------------------------------------------------------------------------------------------------------------------------------|----------------------------------------------------------------------------------------------------------------------------------------------------------------|--------------------------------------------|--------------------------|
| 0 | 1 | 1428 | 18 | See Note 1 | See Note 1 |
| 1 | 1 | Test A: 15 unique PRI values randomly selected from the list of 23 PRI values in Table 5a ----- Test B: 15 unique PRI values randomly selected within the range of 518-3066 μ sec, with a minimum increment of 1 μ sec, excluding PRI values selected in Test A | $\text{Roundup} \left\{ \begin{array}{l} \left(\frac{1}{360} \right) \\ \left(\frac{19 \cdot 10^6}{\text{PRI}_{\mu\text{sec}}} \right) \end{array} \right\}$ | 60% | 30 |
| 2 | 1-5 | 150-230 | 23-29 | 60% | 30 |
| 3 | 6-10 | 200-500 | 16-18 | 60% | 30 |
| 4 | 11-20 | 200-500 | 12-16 | 60% | 30 |
| Aggregate (Radar Types 1-4) | | | | 80% | 120 |
| Note 1: Short Pulse Radar Type 0 should be used for the detection bandwidth test, channel move time, and channel closing time tests. | | | | | |

Table 11: Long Pulse Radar Test Waveform

| Radar Type | Pulse Width (μsec) | Chirp Width (MHz) | PRI (μsec) | Number Of Pulses Per Burst | Number Of Bursts | Minimum Percentage Of Successful Detection | Minimum Number Of Trials |
|------------|--------------------|-------------------|------------|----------------------------|------------------|--------------------------------------------|--------------------------|
| 5 | 50-100 | 5-20 | 1000-2000 | 1-3 | 8-20 | 80% | 30 |

Three subsets of trials will be performed with a minimum of ten trials per subset. The subset of trials differ in where the Long Pulse Type 5 Signal is tuned in frequency.

- a) the Channel center frequency
- b) tuned frequencies such that 90% of the Long Pulse Type 5 frequency modulation is within the low edge of the UUT Occupied Bandwidth
- c) tuned frequencies such that 90% of the Long Pulse Type 5 frequency modulation is within the high edge of the UUT Occupied Bandwidth

It include 10 trails for every subset, the formula as below,

For subset case 1: the center frequency of the signal generator will remain fixed at the center of the UUT Channel.

For subset case 2: to retain 90% frequency overlap between the radar signal and the UUT Occupied Bandwidth, the center frequency of the signal generator will vary for each of the ten trials in subset case 2. The center frequency of the signal generator for each trial is calculated by:

$$FL+(0.4*Chirp\ Width\ [in\ MHz])$$

For subset case 3: to retain 90% frequency overlap between the radar signal and the UUT Occupied Bandwidth, the center frequency of the signal generator will vary for each of the ten trials in subset case 3. The center frequency of the signal generator for each trial is calculated by:

$$FH-(0.4*Chirp\ Width\ [in\ MHz])$$

Table 12: Frequency Hopping Radar Test Waveform

| Radar Type | Pulse Width (μsec) | PRI (μsec) | Pulses per Hop | Hopping Rate (kHz) | Hopping Sequence Length (msec) | Minimum Percentage Of Successful Detection | Minimum Number Of Trials |
|------------|--------------------|------------|----------------|--------------------|--------------------------------|--------------------------------------------|--------------------------|
| 6 | 1 | 333 | 9 | 0.333 | 300 | 70% | 30 |

4 Test & Support Equipment List

4.1 Test Instruments

Table 13: Test Instruments List

| Description & Manufacturer | Brand | Model No. | Serial No. | Date Of Calibration | Due Date Of Calibration |
|----------------------------|--------------|--------------|---------------------|---------------------|-------------------------|
| Spectrum analyzer | R&S | ESR | 101264 | Mar. 26, 2021 | Mar. 25, 2022 |
| Signal generator | KEYSIGHT | MXG | MY53052282 | Dec. 21, 2021 | Dec. 20, 2022 |
| Horn antenna | Schwarzbeck | BBHA 9120 D | 9120D-563 | Nov. 14, 2021 | Nov. 13, 2022 |
| RF coaxial cable | HUBER SUHNER | SUCOFLEX 104 | CABLE-DFS-01-254644 | NA | NA |

Note: Calibrate the RF coaxial cable before each test and use the radiation or conducted method to calibrate the reference FCC KDB 412172 standard.

4.2 Description of Support Units

Table 14: Support Unit Information.

| No. | Product | Brand | Model No. | FCC ID |
|-----|-----------------|-------|-----------|------------|
| 1 | Wireless module | Intel | AX200 | PD9AX200NG |

Note: This device was functioned as a Master Slave device during the DFS test.

Table 15: Software/Firmware Information.

| No. | Product | Model No. | Software/Firmware Version |
|-----|-----------------|-----------|---------------------------|
| 1. | Wireless module | AX200 | 22.60.0.6 |

Note: This device was functioned as a Master Slave device during the DFS test.

5 Test Procedure

5.1 DFS Measurement System

A complete DFS Measurement System consists of two subsystems: (1) the Radar Signal Generating system and (2) the Traffic Monitoring system. The control PC is necessary for generating the Radar waveforms in Table 10, 11 and 12. The traffic monitoring subsystem is specified to the type of unit under test (UUT).

Radiated Setup Configuration of DFS Measurement System

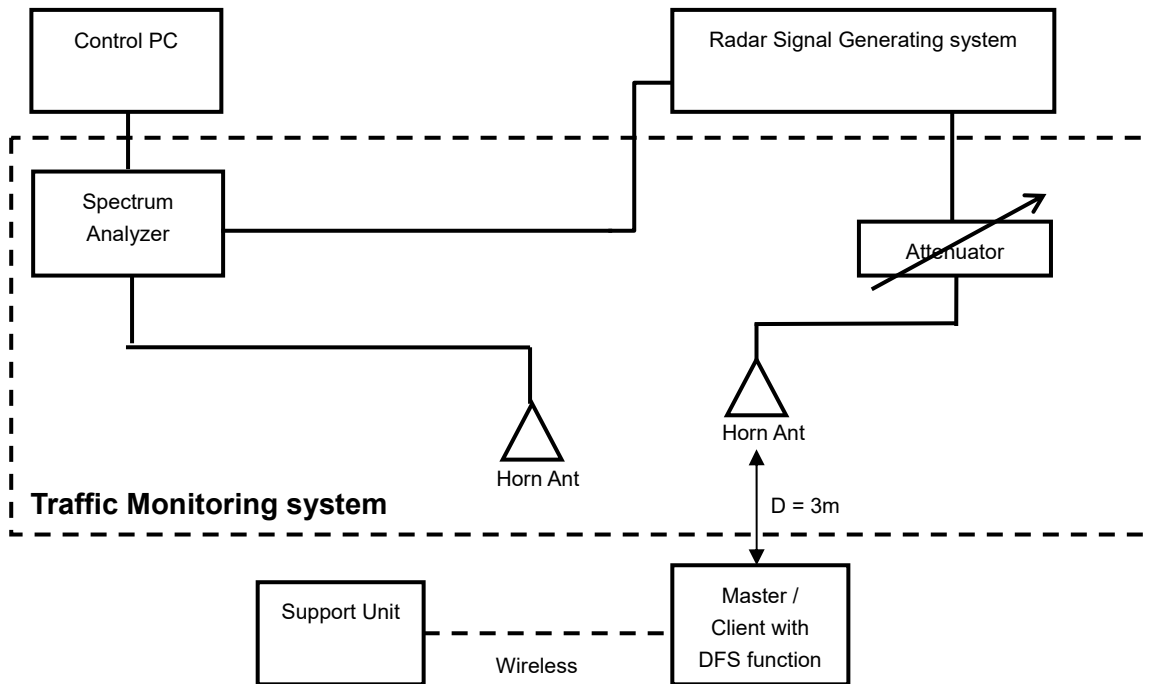

System testing will be performed with channel-loading using means appropriate to the data types that are used by the unlicensed device. The following requirements apply:

| | |
|---|----------------------------------------------------------------------------------------------------------------------------------------------------------------------------|
| | a) The data file must be of a type that is typical for the device (i.e., MPEG-2, MPEG-4, WAV, MP3, MP4, AVI, etc.) and must generally be transmitting in a streaming mode. |
| | b) Software to ping the client is permitted to simulate data transfer but must have random ping intervals. |
| V | c) Timing plots are required with calculations demonstrating a minimum channel loading of approximately 17% or greater. |
| | d) Unicast or Multicast protocols are preferable but other protocols may be used. The appropriate protocol used must be described in the test procedures. |

5.2 Calibration of DFS Detection Threshold Level

The measured channel is 5500MHz and 5510MHz and 5530MHz. The radar signal was the same as transmitted channels, and injected into the antenna of AP (master) or Client Device with Radar Detection, measured the channel closing transmission time and channel move time.

Radiated Setup Configuration of Calibration of DFS Detection Threshold Level

The radar signal generate system is generating waveform pattern of radar types. The amplitude of the radar signal generator system is adjusted to yield a level of -64 dBm as measured on the spectrum analyzer. The interference detection threshold level is lower than -64dBm hence it provides margin to the limit.

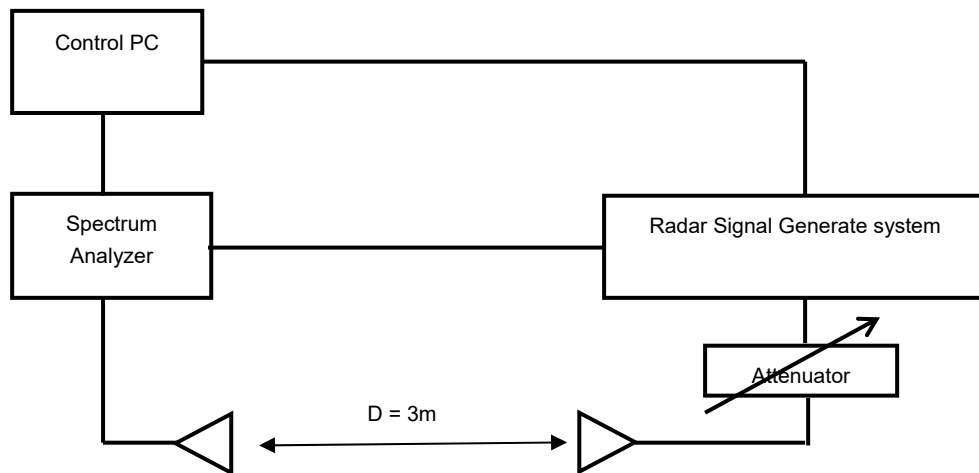

5.3 Deviation from Test Standard

No deviation.

5.4 Radiated Test Setup Configuration

5.4.1 Master Mode

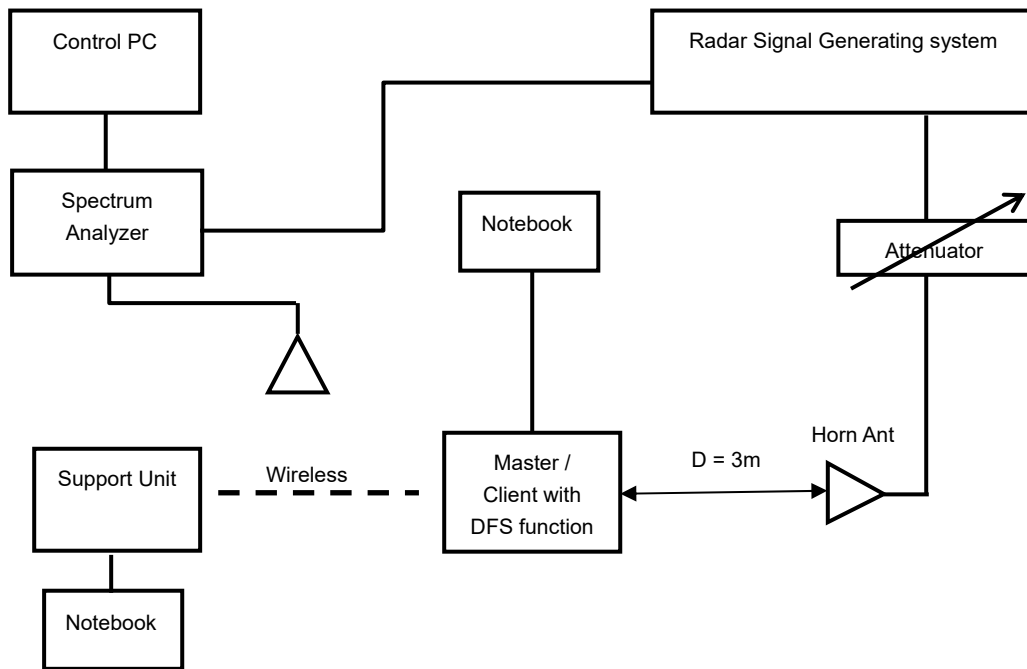

The EUT is a U-NII Device operating in Master mode. The radar test signals are injected into the Master Device.

6 Test Results

6.1 Summary of Test Results

6.1.1 Master mode

| Clause | Test Parameter | Remarks | Pass/Fail |
|--------|-----------------------------------|------------|-----------|
| 15.407 | DFS Detection Threshold | Applicable | Pass |
| 15.407 | U-NII Detection Bandwidth | Applicable | Pass |
| 15.407 | Channel Availability Check Time | Applicable | Pass |
| 15.407 | Channel Move Time | Applicable | Pass |
| 15.407 | Channel Closing Transmission Time | Applicable | Pass |
| 15.407 | Non- Occupancy Period | Applicable | Pass |
| 15.407 | Uniform Spreading | Applicable | Pass |

Note: Determining compliance based on the results of the compliance measurement, not taking into account measurement instrumentation uncertainty.

6.2 Test Results

6.2.1 Test Mode: Device Operating In Master Mode

The radar test waveforms are injected into the Master.

DFS Detection Threshold

For detection threshold level of -64dBm, the tested level is lower than required level for 1dB, hence it provides margin to the limit.

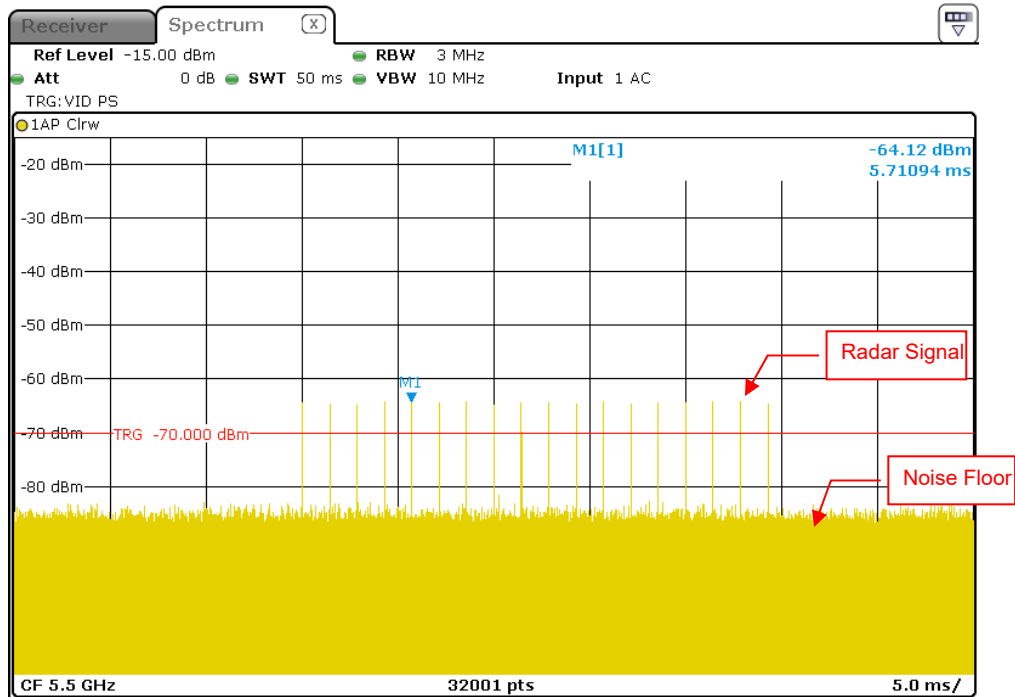

Radar Signal 0

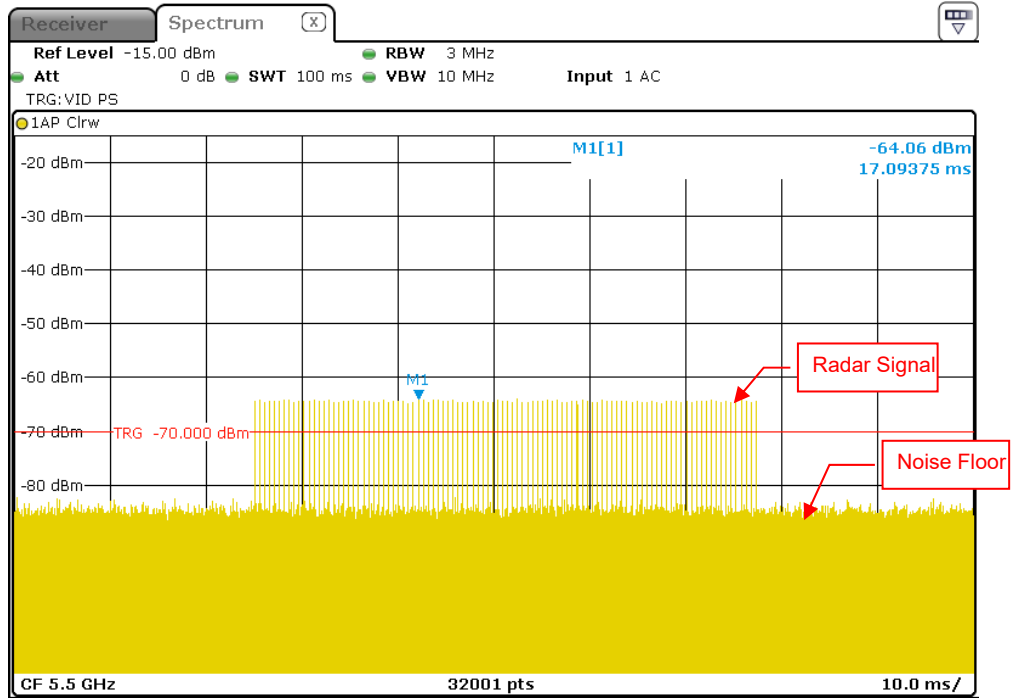

Radar Signal 1 (Test A)

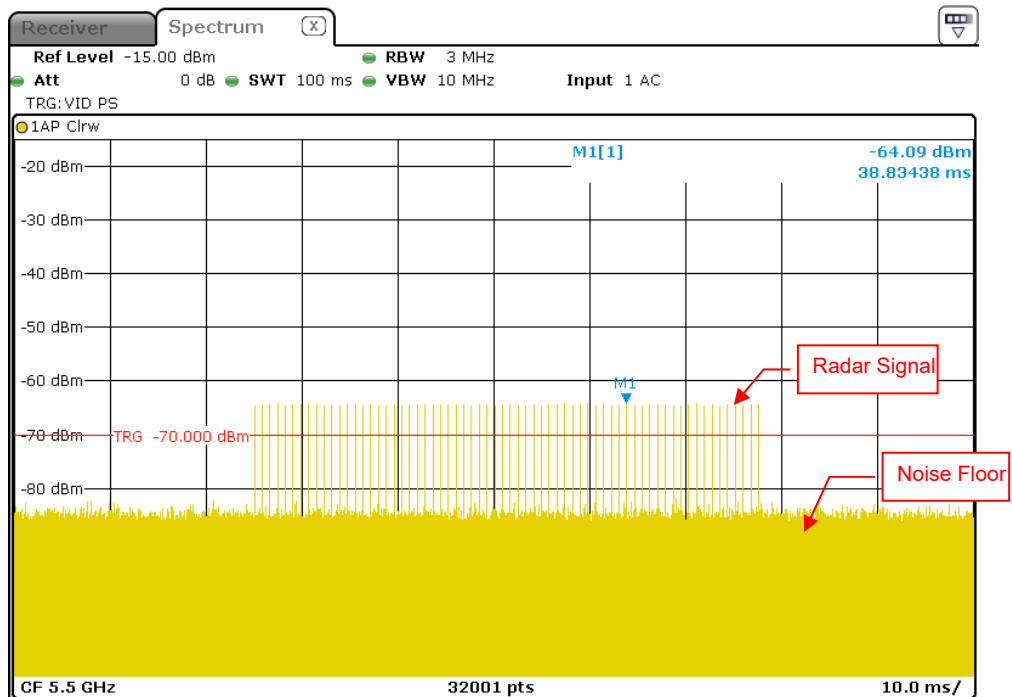

Radar Signal 1 (Test B)

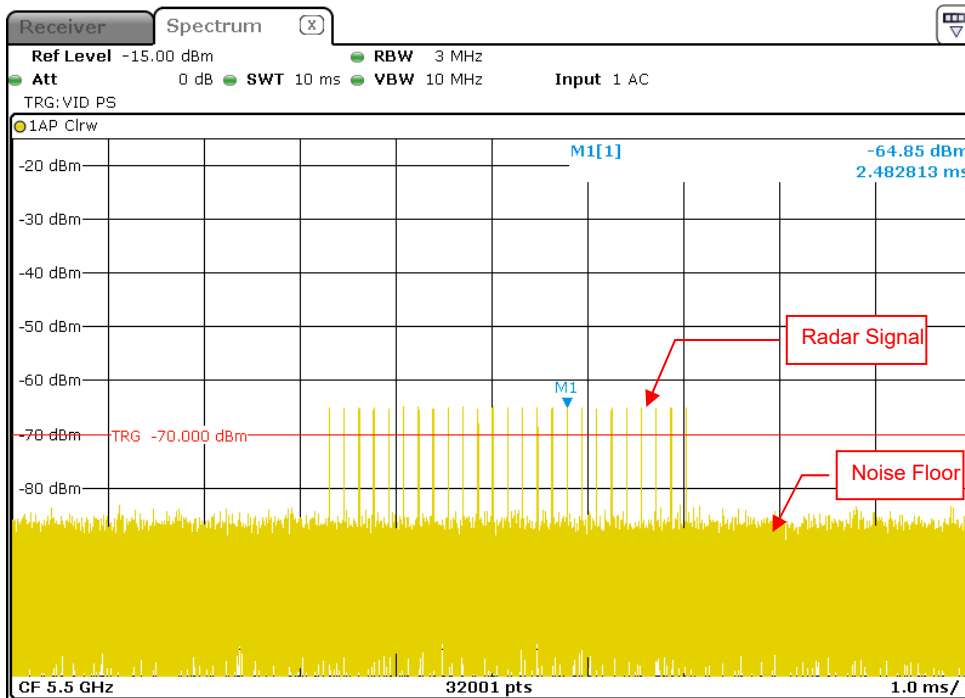

Radar Signal 2

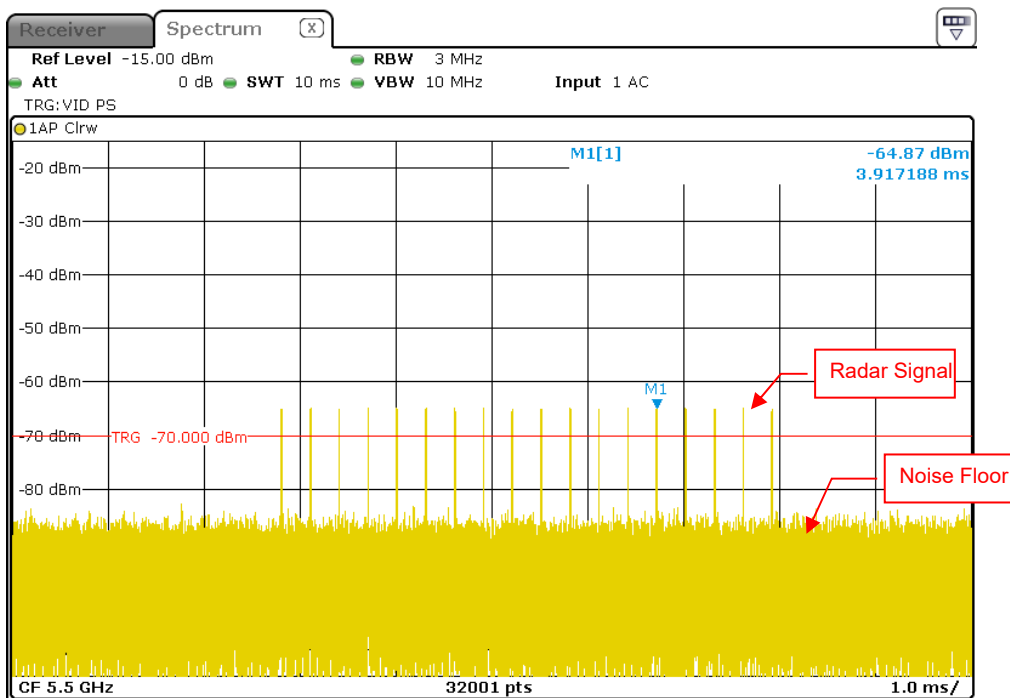

Radar Signal 3



Radar Signal 4

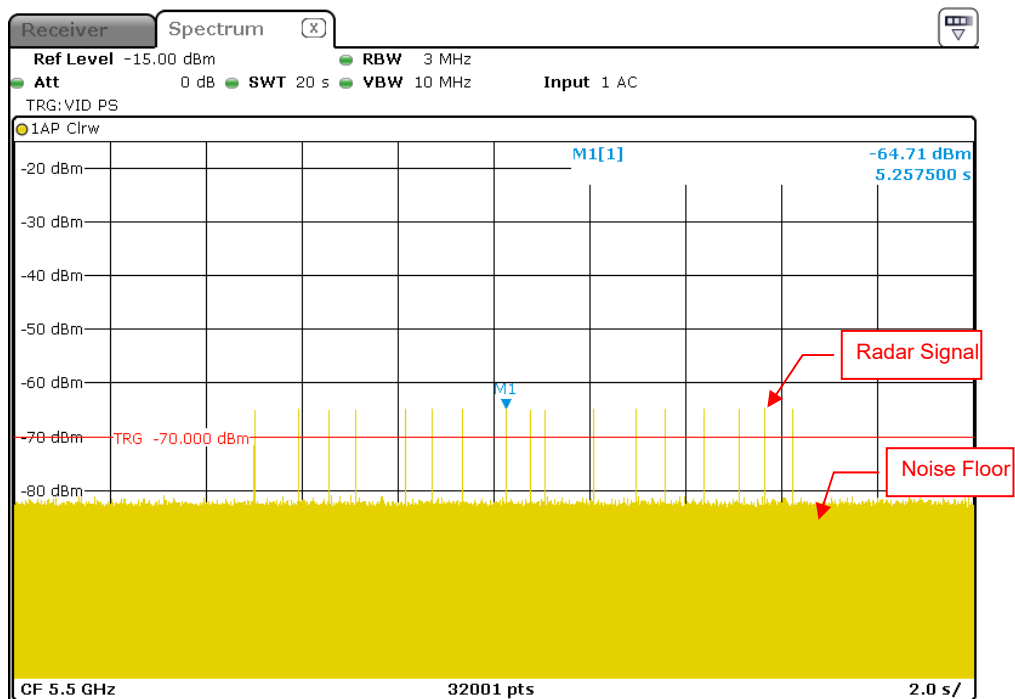

Radar Signal 5

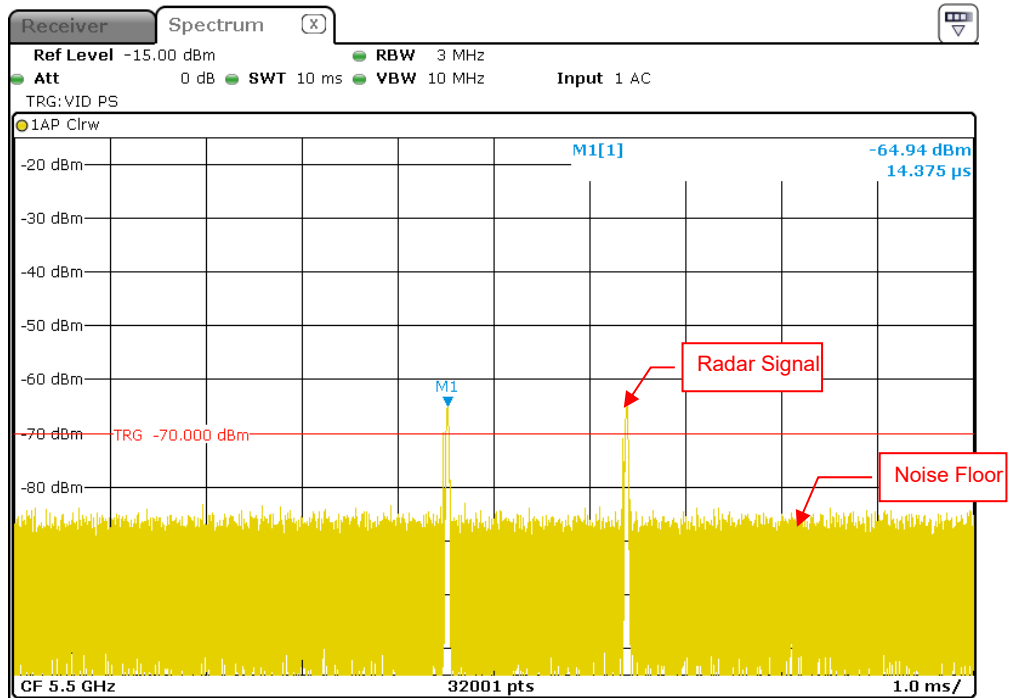

Single Burst of Radar Signal 5

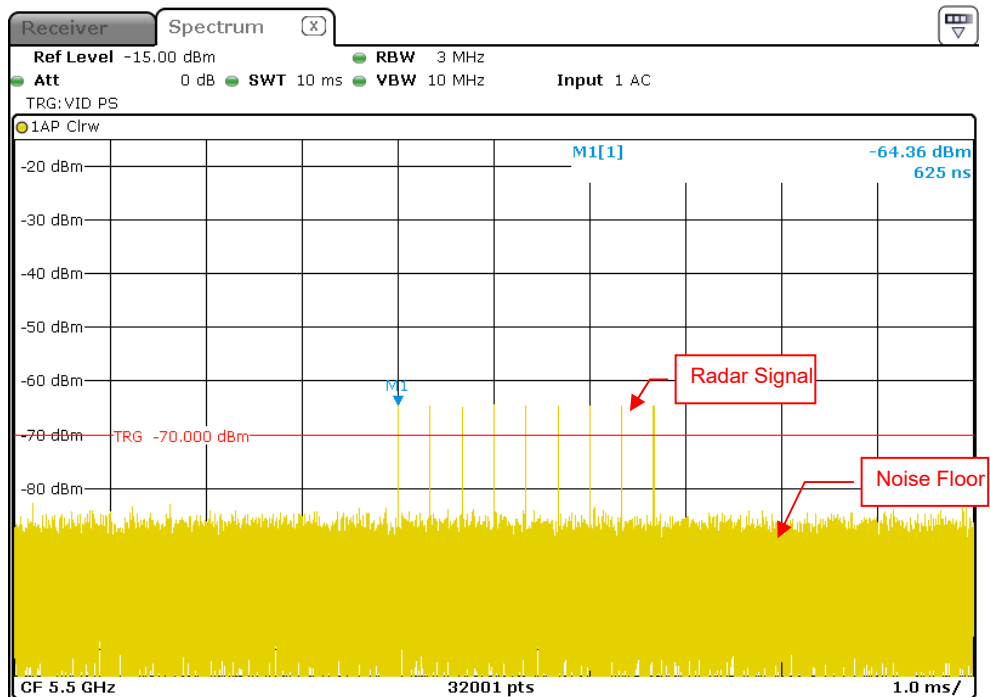

Radar Signal 6

6.2.2 U-NII Detection Bandwidth

IEEE 802.11ax HE20

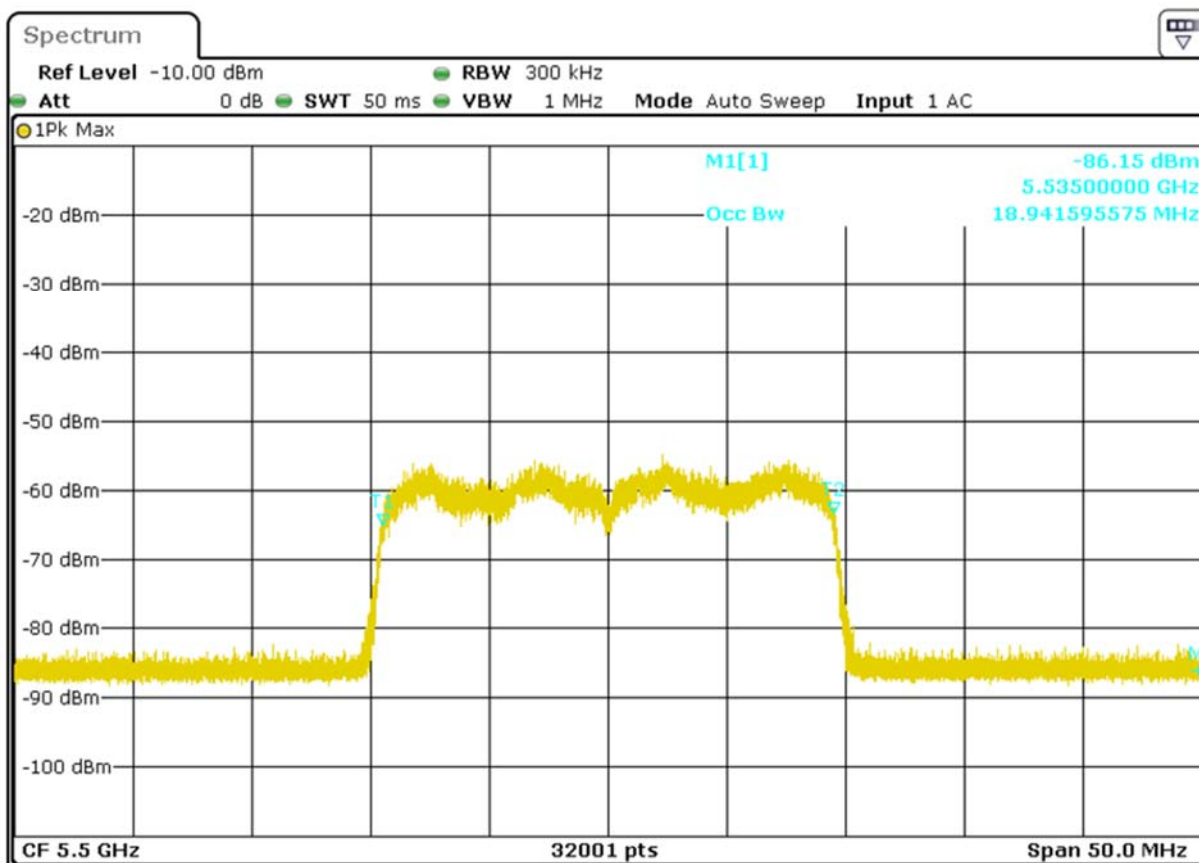

U-NII 99% Channel bandwidth

Notes:

UUT Occupied Bandwidth : 18.94 MHz

UUT Occupied Bandwidth low edge (FL) : 5490.53 MHz

UUT Occupied Bandwidth high edge (FH) : 5509.47 MHz

IEEE 802.11ax HE40

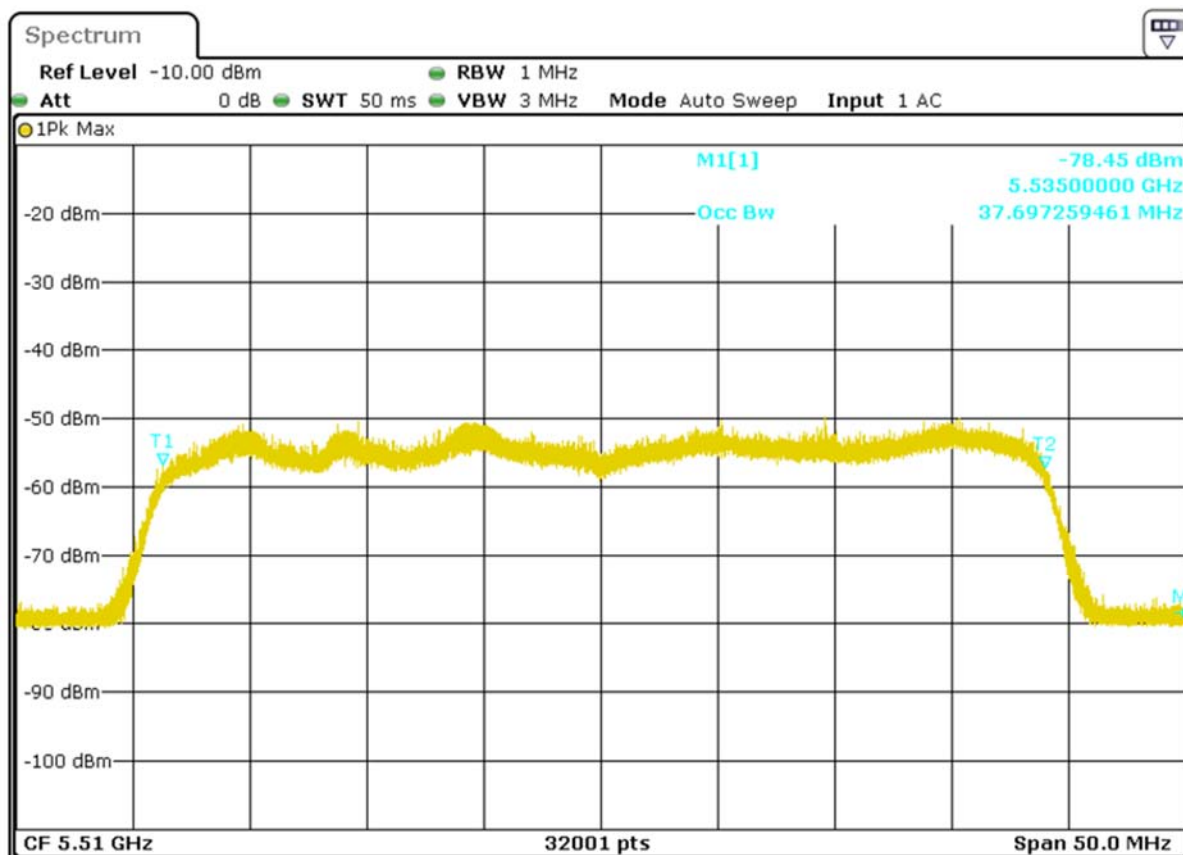

U-NII 99% Channel bandwidth

Notes:

UUT Occupied Bandwidth : 37.70 MHz

UUT Occupied Bandwidth low edge (FL) : 5491.15 MHz

UUT Occupied Bandwidth high edge (FH) : 5528.85 MHz

IEEE 802.11ax HE80

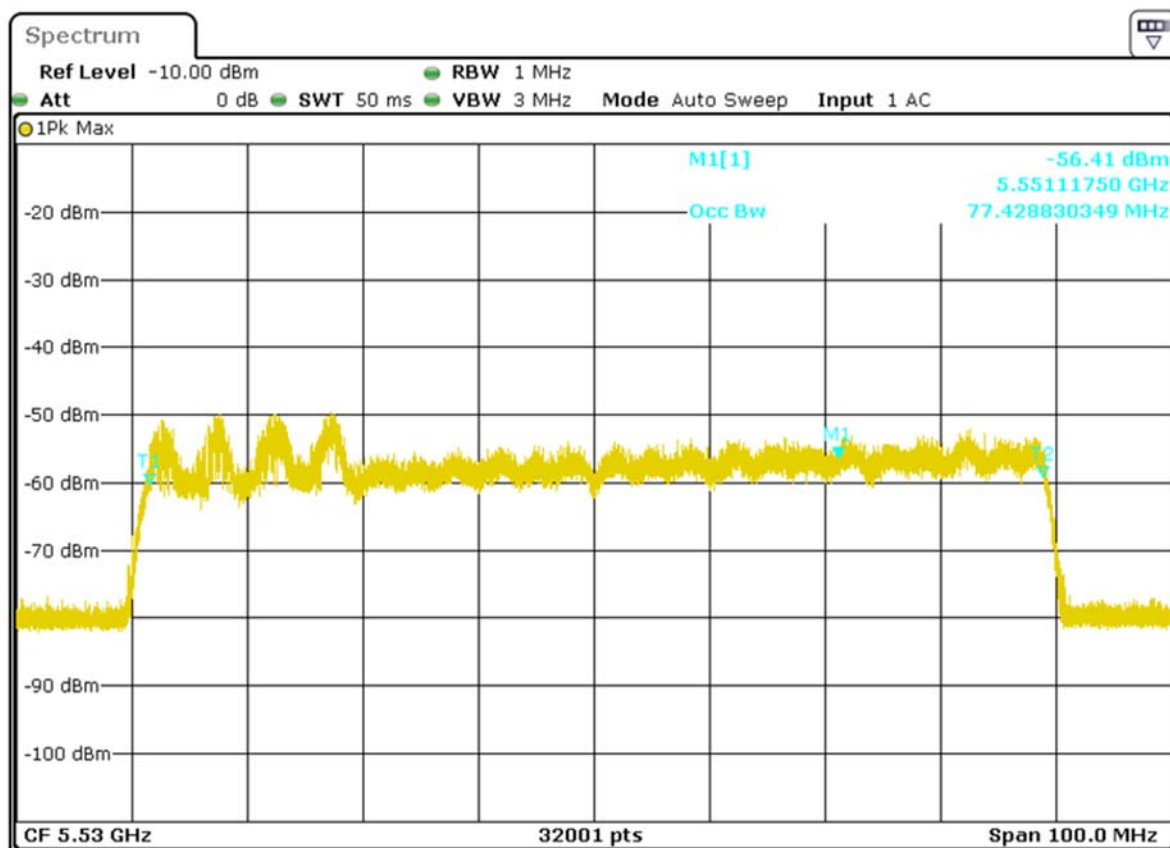

U-NII 99% Channel bandwidth

Notes:

- UUT Occupied Bandwidth : 77.43 MHz
- UUT Occupied Bandwidth low edge (FL) : 5491.29 MHz
- UUT Occupied Bandwidth high edge (FH) : 5568.72 MHz

Detection Bandwidth Test - IEEE 802.11ax HE20

Radar Type 0
 EUT Frequency: 5500MHz
 EUT 99% Power bandwidth: 18.94MHz
 Detection bandwidth limit (100% of EUT 99% Power bandwidth):18.94MHz
 Detection bandwidth (5510(FH) – 5490(FL)) : 20MHz
 Test Result : Pass

| Radar Frequency (MHz) | Trial Number / Detection | | | | | | | | | | Detection Rate (%) |
|-----------------------|--------------------------|-----|-----|-----|-----|-----|-----|-----|-----|-----|--------------------|
| | 1 | 2 | 3 | 4 | 5 | 6 | 7 | 8 | 9 | 10 | |
| 5489 | No | No | No | No | No | No | No | No | No | No | 0.0 |
| 5490 (FL) | Yes | Yes | Yes | Yes | Yes | Yes | Yes | Yes | Yes | Yes | 100.0 |
| 5491 | Yes | Yes | Yes | Yes | Yes | Yes | Yes | Yes | Yes | Yes | 100.0 |
| 5492 | Yes | Yes | Yes | Yes | Yes | Yes | Yes | Yes | Yes | Yes | 100.0 |
| 5493 | Yes | Yes | Yes | Yes | Yes | Yes | Yes | Yes | Yes | Yes | 100.0 |
| 5494 | Yes | Yes | Yes | Yes | Yes | Yes | Yes | Yes | Yes | Yes | 100.0 |
| 5495 | Yes | Yes | Yes | Yes | Yes | Yes | Yes | Yes | Yes | Yes | 100.0 |
| 5496 | Yes | Yes | Yes | Yes | Yes | Yes | Yes | Yes | Yes | Yes | 100.0 |
| 5497 | Yes | Yes | Yes | Yes | Yes | Yes | Yes | Yes | Yes | Yes | 100.0 |
| 5498 | Yes | Yes | Yes | Yes | Yes | Yes | Yes | Yes | Yes | Yes | 100.0 |
| 5499 | Yes | Yes | Yes | Yes | Yes | Yes | Yes | Yes | Yes | Yes | 100.0 |
| 5500 | Yes | Yes | Yes | Yes | Yes | Yes | Yes | Yes | Yes | Yes | 100.0 |
| 5501 | Yes | Yes | Yes | Yes | Yes | Yes | Yes | Yes | Yes | Yes | 100.0 |
| 5502 | Yes | Yes | Yes | Yes | Yes | Yes | Yes | Yes | Yes | Yes | 100.0 |
| 5503 | Yes | Yes | Yes | Yes | Yes | Yes | Yes | Yes | Yes | Yes | 100.0 |
| 5504 | Yes | Yes | Yes | Yes | Yes | Yes | Yes | Yes | Yes | Yes | 100.0 |
| 5505 | Yes | Yes | Yes | Yes | Yes | Yes | Yes | Yes | Yes | Yes | 100.0 |
| 5506 | Yes | Yes | Yes | Yes | Yes | Yes | Yes | Yes | Yes | Yes | 100.0 |
| 5507 | Yes | Yes | Yes | Yes | Yes | Yes | Yes | Yes | Yes | Yes | 100.0 |
| 5508 | Yes | Yes | Yes | Yes | Yes | Yes | Yes | Yes | Yes | Yes | 100.0 |
| 5509 | Yes | Yes | Yes | Yes | Yes | Yes | Yes | Yes | Yes | Yes | 100.0 |
| 5510 (FH) | Yes | Yes | Yes | Yes | Yes | Yes | Yes | Yes | Yes | Yes | 100.0 |
| 5511 | No | No | No | No | No | No | No | No | No | No | 0.0 |

Detection Bandwidth Test - IEEE 802.11ax HE40

Radar Type 0

EUT Frequency: 5510MHz

EUT 99% Power bandwidth: 37.70MHz

Detection bandwidth limit (100% of EUT 99% Power bandwidth): 37.70MHz

Detection bandwidth (5530(FH) – 5490(FL)) : 40MHz

Test Result : Pass

| Radar Frequency (MHz) | Trial Number / Detection | | | | | | | | | | Detection Rate (%) |
|-----------------------|--------------------------|-----|-----|-----|-----|-----|-----|-----|-----|-----|--------------------|
| | 1 | 2 | 3 | 4 | 5 | 6 | 7 | 8 | 9 | 10 | |
| 5489 | No | No | No | No | No | No | No | No | No | No | 0.0 |
| 5490 (FL) | Yes | Yes | Yes | Yes | Yes | Yes | Yes | Yes | Yes | Yes | 100.0 |
| 5491 | Yes | Yes | Yes | Yes | Yes | Yes | Yes | Yes | Yes | Yes | 100.0 |
| 5492 | Yes | Yes | Yes | Yes | Yes | Yes | Yes | Yes | Yes | Yes | 100.0 |
| 5493 | Yes | Yes | Yes | Yes | Yes | Yes | Yes | Yes | Yes | Yes | 100.0 |
| 5494 | Yes | Yes | Yes | Yes | Yes | Yes | Yes | Yes | Yes | Yes | 100.0 |
| 5495 | Yes | Yes | Yes | Yes | Yes | Yes | Yes | Yes | Yes | Yes | 100.0 |
| 5496 | Yes | Yes | Yes | Yes | Yes | Yes | Yes | Yes | Yes | Yes | 100.0 |
| 5497 | Yes | Yes | Yes | Yes | Yes | Yes | Yes | Yes | Yes | Yes | 100.0 |
| 5498 | Yes | Yes | Yes | Yes | Yes | Yes | Yes | Yes | Yes | Yes | 100.0 |
| 5499 | Yes | Yes | Yes | Yes | Yes | Yes | Yes | Yes | Yes | Yes | 100.0 |
| 5500 | Yes | Yes | Yes | Yes | Yes | Yes | Yes | Yes | Yes | Yes | 100.0 |
| 5501 | Yes | Yes | Yes | Yes | Yes | Yes | Yes | Yes | Yes | Yes | 100.0 |
| 5502 | Yes | Yes | Yes | Yes | Yes | Yes | Yes | Yes | Yes | Yes | 100.0 |
| 5503 | Yes | Yes | Yes | Yes | Yes | Yes | Yes | Yes | Yes | Yes | 100.0 |
| 5504 | Yes | Yes | Yes | Yes | Yes | Yes | Yes | Yes | Yes | Yes | 100.0 |
| 5505 | Yes | Yes | Yes | Yes | Yes | Yes | Yes | Yes | Yes | Yes | 100.0 |
| 5506 | Yes | Yes | Yes | Yes | Yes | Yes | Yes | Yes | Yes | Yes | 100.0 |
| 5507 | Yes | Yes | Yes | Yes | Yes | Yes | Yes | Yes | Yes | Yes | 100.0 |
| 5508 | Yes | Yes | Yes | Yes | Yes | Yes | Yes | Yes | Yes | Yes | 100.0 |
| 5509 | Yes | Yes | Yes | Yes | Yes | Yes | Yes | Yes | Yes | Yes | 100.0 |
| 5510 | Yes | Yes | Yes | Yes | Yes | Yes | Yes | Yes | Yes | Yes | 100.0 |
| 5511 | Yes | Yes | Yes | Yes | Yes | Yes | Yes | Yes | Yes | Yes | 100.0 |
| 5512 | Yes | Yes | Yes | Yes | Yes | Yes | Yes | Yes | Yes | Yes | 100.0 |
| 5513 | Yes | Yes | Yes | Yes | Yes | Yes | Yes | Yes | Yes | Yes | 100.0 |
| 5514 | Yes | Yes | Yes | Yes | Yes | Yes | Yes | Yes | Yes | Yes | 100.0 |
| 5515 | Yes | Yes | Yes | Yes | Yes | Yes | Yes | Yes | Yes | Yes | 100.0 |
| 5516 | Yes | Yes | Yes | Yes | Yes | Yes | Yes | Yes | Yes | Yes | 100.0 |
| 5517 | Yes | Yes | Yes | Yes | Yes | Yes | Yes | Yes | Yes | Yes | 100.0 |
| 5518 | Yes | Yes | Yes | Yes | Yes | Yes | Yes | Yes | Yes | Yes | 100.0 |
| 5519 | Yes | Yes | Yes | Yes | Yes | Yes | Yes | Yes | Yes | Yes | 100.0 |
| 5520 | Yes | Yes | Yes | Yes | Yes | Yes | Yes | Yes | Yes | Yes | 100.0 |
| 5521 | Yes | Yes | Yes | Yes | Yes | Yes | Yes | Yes | Yes | Yes | 100.0 |
| 5522 | Yes | Yes | Yes | Yes | Yes | Yes | Yes | Yes | Yes | Yes | 100.0 |
| 5523 | Yes | Yes | Yes | Yes | Yes | Yes | No | Yes | Yes | Yes | 90.0 |
| 5524 | Yes | Yes | Yes | Yes | Yes | Yes | Yes | Yes | Yes | No | 90.0 |
| 5525 | Yes | Yes | Yes | Yes | Yes | Yes | Yes | Yes | Yes | Yes | 100.0 |
| 5526 | Yes | Yes | Yes | Yes | Yes | Yes | Yes | Yes | Yes | Yes | 100.0 |
| 5527 | Yes | Yes | Yes | Yes | Yes | Yes | Yes | Yes | Yes | Yes | 100.0 |
| 5528 | Yes | Yes | Yes | Yes | Yes | Yes | Yes | Yes | Yes | Yes | 100.0 |
| 5529 | Yes | Yes | Yes | Yes | Yes | Yes | Yes | Yes | Yes | Yes | 100.0 |
| 5530 (FH) | Yes | Yes | Yes | Yes | Yes | Yes | Yes | Yes | Yes | Yes | 100.0 |
| 5531 | No | No | No | No | No | No | No | No | No | No | 0.0 |

Detection Bandwidth Test - IEEE 802.11ax HE80

Radar Type 0

EUT Frequency: 5530MHz

EUT 99% Power bandwidth: 77.43 MHz

Detection bandwidth limit (100% of EUT 99% Power bandwidth): 77.43 MHz

Detection bandwidth (5570(FH) – 5490(FL)) : 80MHz

Test Result : Pass

| Radar Frequency (MHz) | Trial Number / Detection | | | | | | | | | | Detection Rate (%) |
|-----------------------|--------------------------|-----|-----|-----|-----|-----|-----|-----|-----|-----|--------------------|
| | 1 | 2 | 3 | 4 | 5 | 6 | 7 | 8 | 9 | 10 | |
| 5489 | No | No | No | No | No | No | No | No | No | No | 0.0 |
| 5490 (FL) | Yes | Yes | Yes | Yes | Yes | Yes | Yes | Yes | Yes | Yes | 100.0 |
| 5491 | Yes | Yes | Yes | Yes | Yes | Yes | Yes | Yes | Yes | Yes | 100.0 |
| 5492 | Yes | Yes | Yes | Yes | Yes | Yes | Yes | Yes | Yes | Yes | 100.0 |
| 5493 | Yes | Yes | Yes | Yes | Yes | Yes | Yes | Yes | Yes | Yes | 100.0 |
| 5494 | Yes | Yes | Yes | Yes | Yes | Yes | Yes | Yes | Yes | Yes | 100.0 |
| 5495 | Yes | Yes | Yes | Yes | Yes | Yes | Yes | Yes | Yes | Yes | 100.0 |
| 5496 | Yes | Yes | Yes | Yes | Yes | Yes | Yes | Yes | Yes | Yes | 100.0 |
| 5497 | Yes | Yes | Yes | Yes | Yes | Yes | Yes | Yes | Yes | Yes | 100.0 |
| 5498 | Yes | Yes | Yes | Yes | Yes | Yes | Yes | Yes | Yes | Yes | 100.0 |
| 5499 | Yes | Yes | Yes | Yes | Yes | Yes | Yes | Yes | Yes | Yes | 100.0 |
| 5500 | Yes | Yes | Yes | Yes | Yes | Yes | Yes | Yes | Yes | Yes | 100.0 |
| 5501 | Yes | Yes | Yes | Yes | Yes | Yes | Yes | Yes | Yes | Yes | 100.0 |
| 5502 | Yes | Yes | Yes | Yes | Yes | Yes | Yes | Yes | Yes | Yes | 100.0 |
| 5503 | Yes | Yes | Yes | Yes | Yes | Yes | Yes | Yes | Yes | Yes | 100.0 |
| 5504 | Yes | Yes | Yes | Yes | Yes | Yes | Yes | Yes | Yes | Yes | 100.0 |
| 5505 | Yes | Yes | Yes | Yes | Yes | Yes | Yes | Yes | Yes | Yes | 100.0 |
| 5506 | Yes | Yes | Yes | Yes | Yes | Yes | Yes | Yes | Yes | Yes | 100.0 |
| 5507 | Yes | Yes | Yes | Yes | Yes | Yes | Yes | Yes | Yes | Yes | 100.0 |
| 5508 | Yes | Yes | Yes | Yes | Yes | Yes | Yes | Yes | Yes | Yes | 100.0 |
| 5509 | Yes | Yes | Yes | Yes | Yes | Yes | Yes | Yes | Yes | Yes | 100.0 |
| 5510 | Yes | Yes | Yes | Yes | Yes | Yes | Yes | Yes | Yes | Yes | 100.0 |
| 5511 | Yes | Yes | Yes | Yes | Yes | Yes | Yes | Yes | Yes | Yes | 100.0 |
| 5512 | Yes | Yes | Yes | Yes | Yes | Yes | Yes | Yes | Yes | Yes | 100.0 |
| 5513 | Yes | Yes | Yes | Yes | Yes | Yes | Yes | Yes | Yes | Yes | 100.0 |
| 5514 | Yes | Yes | Yes | Yes | Yes | Yes | Yes | Yes | Yes | Yes | 100.0 |
| 5515 | Yes | Yes | Yes | Yes | Yes | Yes | Yes | Yes | Yes | Yes | 100.0 |
| 5516 | Yes | Yes | Yes | Yes | Yes | Yes | Yes | Yes | Yes | Yes | 100.0 |
| 5517 | Yes | Yes | Yes | Yes | Yes | Yes | Yes | Yes | Yes | Yes | 100.0 |
| 5518 | Yes | Yes | Yes | Yes | Yes | Yes | Yes | Yes | Yes | Yes | 100.0 |
| 5519 | Yes | Yes | Yes | Yes | Yes | Yes | Yes | Yes | Yes | Yes | 100.0 |
| 5520 | Yes | Yes | Yes | Yes | Yes | Yes | Yes | Yes | Yes | Yes | 100.0 |
| 5521 | Yes | Yes | Yes | Yes | Yes | Yes | Yes | Yes | Yes | Yes | 100.0 |
| 5522 | Yes | Yes | Yes | Yes | Yes | Yes | Yes | Yes | Yes | Yes | 100.0 |
| 5523 | Yes | Yes | Yes | Yes | Yes | Yes | Yes | Yes | Yes | Yes | 100.0 |
| 5524 | Yes | Yes | Yes | Yes | Yes | Yes | Yes | Yes | Yes | Yes | 100.0 |
| 5525 | Yes | Yes | Yes | Yes | Yes | Yes | Yes | Yes | Yes | Yes | 100.0 |
| 5526 | Yes | Yes | Yes | Yes | Yes | Yes | Yes | Yes | Yes | Yes | 100.0 |
| 5527 | Yes | Yes | Yes | Yes | Yes | Yes | Yes | Yes | Yes | Yes | 100.0 |
| 5528 | Yes | Yes | Yes | Yes | Yes | Yes | Yes | Yes | Yes | Yes | 100.0 |
| 5529 | Yes | Yes | Yes | Yes | Yes | Yes | Yes | Yes | Yes | Yes | 100.0 |
| 5530 | Yes | Yes | Yes | Yes | Yes | Yes | Yes | Yes | Yes | Yes | 100.0 |
| 5531 | Yes | Yes | Yes | Yes | Yes | Yes | Yes | Yes | Yes | Yes | 100.0 |
| 5532 | Yes | Yes | Yes | Yes | Yes | Yes | Yes | Yes | Yes | Yes | 100.0 |

| | | | | | | | | | | | |
|-----------|-----|-----|-----|-----|-----|-----|-----|-----|-----|-----|-------|
| 5533 | Yes | Yes | Yes | Yes | Yes | Yes | Yes | Yes | Yes | Yes | 100.0 |
| 5534 | Yes | Yes | Yes | Yes | Yes | Yes | Yes | Yes | Yes | Yes | 100.0 |
| 5535 | Yes | Yes | Yes | Yes | Yes | Yes | Yes | Yes | Yes | Yes | 100.0 |
| 5536 | Yes | Yes | Yes | Yes | Yes | Yes | Yes | Yes | Yes | Yes | 100.0 |
| 5537 | Yes | Yes | Yes | Yes | Yes | Yes | Yes | Yes | Yes | Yes | 100.0 |
| 5538 | Yes | Yes | Yes | Yes | Yes | Yes | Yes | Yes | Yes | Yes | 100.0 |
| 5539 | Yes | Yes | Yes | Yes | Yes | Yes | Yes | Yes | Yes | Yes | 100.0 |
| 5540 | Yes | Yes | Yes | Yes | Yes | Yes | Yes | Yes | Yes | Yes | 100.0 |
| 5541 | Yes | Yes | Yes | Yes | Yes | Yes | Yes | Yes | Yes | Yes | 100.0 |
| 5542 | Yes | Yes | Yes | Yes | Yes | Yes | Yes | Yes | Yes | Yes | 100.0 |
| 5543 | Yes | Yes | Yes | Yes | Yes | Yes | Yes | Yes | Yes | Yes | 100.0 |
| 5544 | Yes | Yes | Yes | Yes | Yes | Yes | Yes | Yes | Yes | Yes | 100.0 |
| 5545 | Yes | Yes | Yes | Yes | Yes | Yes | Yes | Yes | Yes | Yes | 100.0 |
| 5546 | Yes | Yes | Yes | Yes | Yes | Yes | Yes | Yes | Yes | Yes | 100.0 |
| 5547 | Yes | Yes | Yes | Yes | Yes | Yes | Yes | Yes | Yes | Yes | 100.0 |
| 5548 | Yes | Yes | Yes | Yes | Yes | Yes | Yes | Yes | Yes | Yes | 100.0 |
| 5549 | Yes | Yes | Yes | Yes | Yes | Yes | Yes | Yes | Yes | Yes | 100.0 |
| 5550 | Yes | Yes | Yes | Yes | Yes | Yes | Yes | Yes | Yes | Yes | 100.0 |
| 5551 | Yes | Yes | Yes | Yes | Yes | Yes | Yes | Yes | Yes | Yes | 100.0 |
| 5552 | Yes | Yes | Yes | Yes | Yes | Yes | Yes | Yes | Yes | Yes | 100.0 |
| 5553 | Yes | Yes | Yes | Yes | Yes | Yes | Yes | Yes | Yes | Yes | 100.0 |
| 5554 | Yes | Yes | Yes | Yes | Yes | Yes | Yes | Yes | Yes | Yes | 100.0 |
| 5555 | Yes | Yes | Yes | Yes | Yes | Yes | Yes | Yes | Yes | Yes | 100.0 |
| 5556 | Yes | Yes | Yes | Yes | Yes | Yes | Yes | Yes | Yes | Yes | 100.0 |
| 5557 | Yes | Yes | Yes | Yes | Yes | Yes | Yes | Yes | Yes | Yes | 100.0 |
| 5558 | Yes | Yes | Yes | Yes | Yes | Yes | Yes | Yes | Yes | Yes | 100.0 |
| 5559 | Yes | Yes | Yes | Yes | Yes | Yes | Yes | Yes | Yes | Yes | 100.0 |
| 5560 | Yes | Yes | Yes | Yes | Yes | Yes | Yes | Yes | Yes | Yes | 100.0 |
| 5561 | Yes | Yes | Yes | Yes | Yes | Yes | Yes | Yes | Yes | Yes | 100.0 |
| 5562 | Yes | Yes | Yes | Yes | Yes | Yes | Yes | Yes | Yes | Yes | 100.0 |
| 5563 | Yes | Yes | Yes | Yes | Yes | Yes | Yes | Yes | Yes | Yes | 100.0 |
| 5564 | Yes | Yes | Yes | Yes | Yes | Yes | Yes | Yes | Yes | Yes | 100.0 |
| 5565 | Yes | Yes | Yes | Yes | Yes | Yes | Yes | Yes | Yes | Yes | 100.0 |
| 5566 | Yes | Yes | Yes | Yes | Yes | Yes | Yes | Yes | Yes | Yes | 100.0 |
| 5567 | Yes | Yes | Yes | Yes | Yes | Yes | Yes | Yes | Yes | Yes | 100.0 |
| 5568 | Yes | Yes | Yes | Yes | Yes | Yes | Yes | Yes | Yes | Yes | 100.0 |
| 5569 | Yes | Yes | Yes | Yes | Yes | Yes | No | Yes | Yes | Yes | 90.0 |
| 5570 (FH) | Yes | Yes | Yes | Yes | Yes | Yes | Yes | Yes | Yes | Yes | 100.0 |
| 5571 | No | No | No | No | No | No | No | No | No | No | 0.0 |

6.2.3 Channel Availability Check Time

If the EUT successfully detected the radar burst, it should be observed as the EUT has no transmissions occurred until the EUT starts transmitting on another channel.

| Timing of Radar Signal | Observation | |
|------------------------|-------------|-------------------|
| | EUT | Spectrum Analyzer |
| Within 1 to 6 second | Detected | No transmissions |
| Within 54 to 60 second | Detected | No transmissions |

Note: Worst case channel for final "Channel Availability Check" test.

Initial Channel Availability Check Time Channel Availability Check

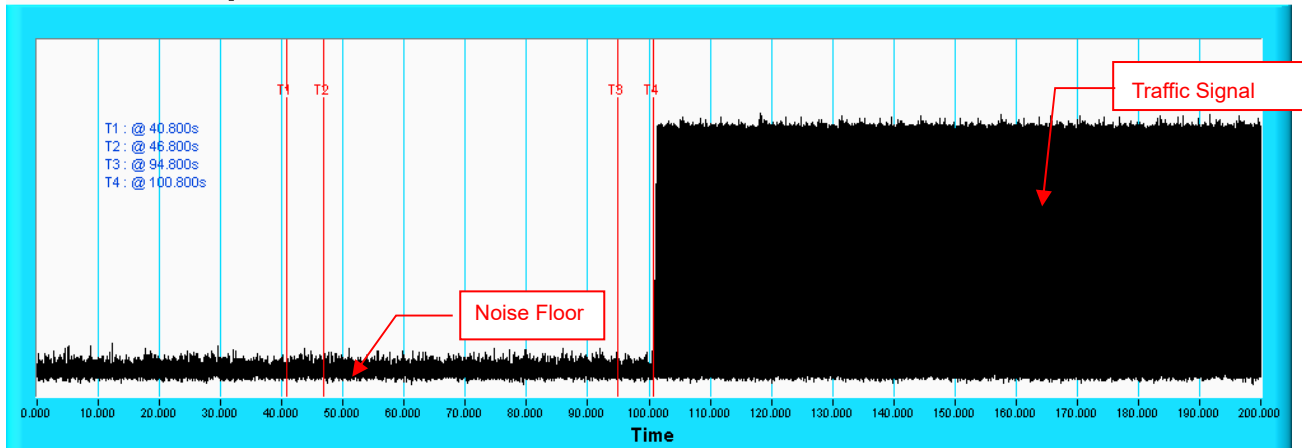

NOTE: T1 denotes the end of power-up time period is 40.8th second. T4 denotes the end of Channel Availability Check time is 100.8th second. Channel Availability Check time is equal to (T4 – T1) 60 seconds.

Radar Burst at the Beginning of the Channel Availability Check Time Channel Availability Check

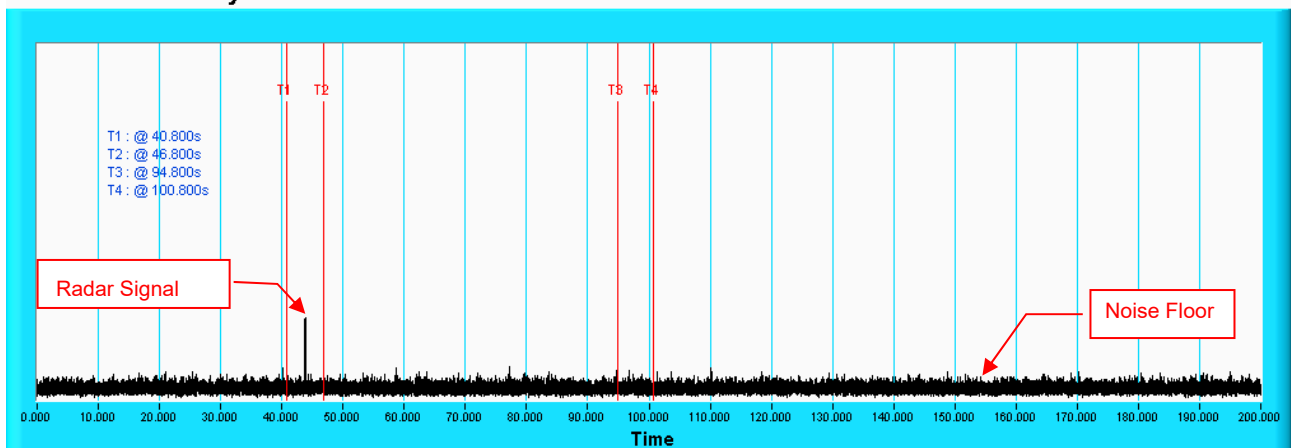

NOTE: T1 denotes the end of power up time period is 40.8th second. T2 denotes 46.8th second and the radar burst was commenced within a 6 second window starting from the end of power-up sequence. T4 denotes the 100.8th second.

Radar Burst at the End of the Channel Availability Check Time Channel Availability Check

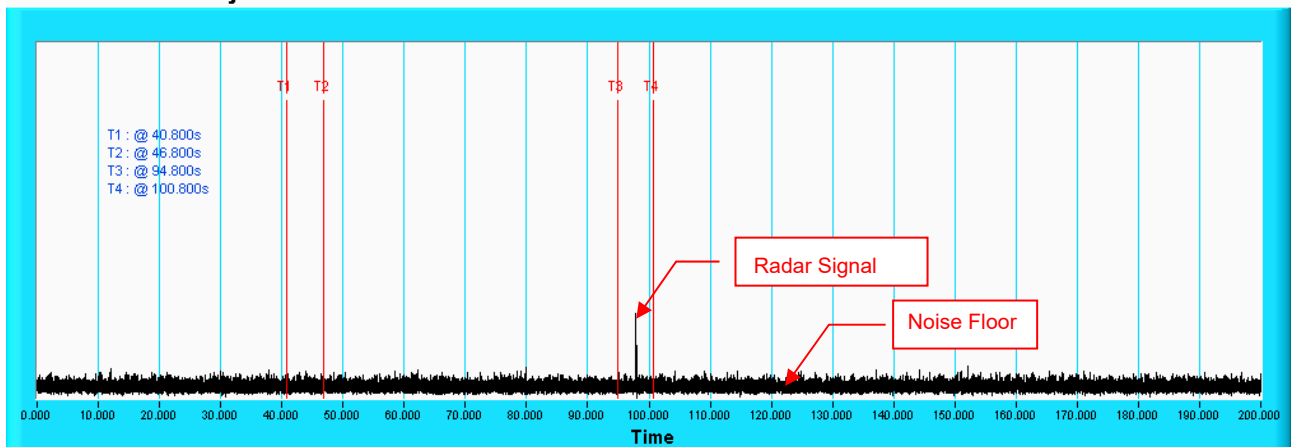

NOTE: T1 denotes the end of power up time period is 40.8th second. T3 denotes 94.8th second and the radar burst was commenced within 54th second to 60th second window starting from the end of power-up sequence.

6.2.4 Channel Closing Transmission and Channel Move Time Wireless Traffic Loading

802.11ax (HE20) Duty Cycle

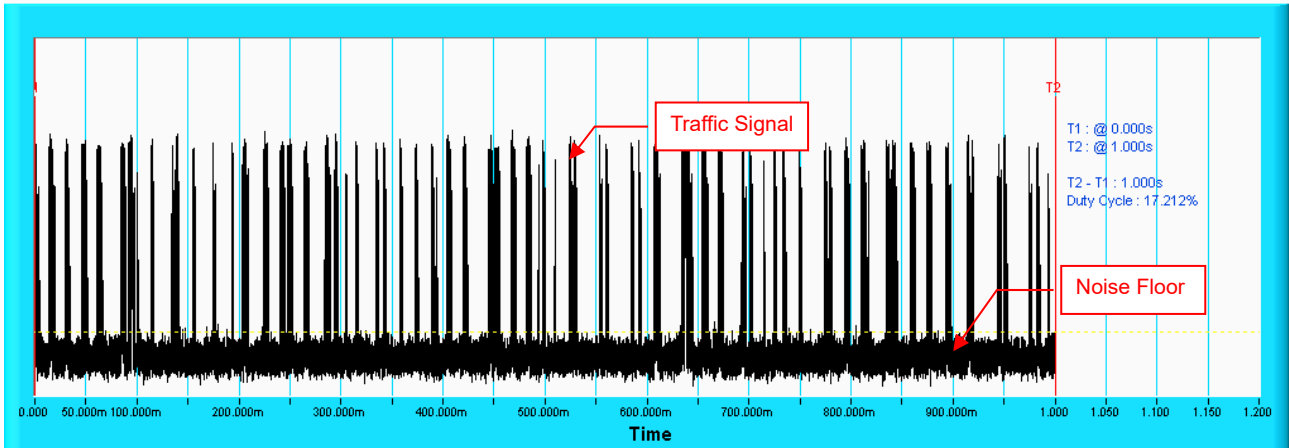

802.11ax (HE40) Duty Cycle

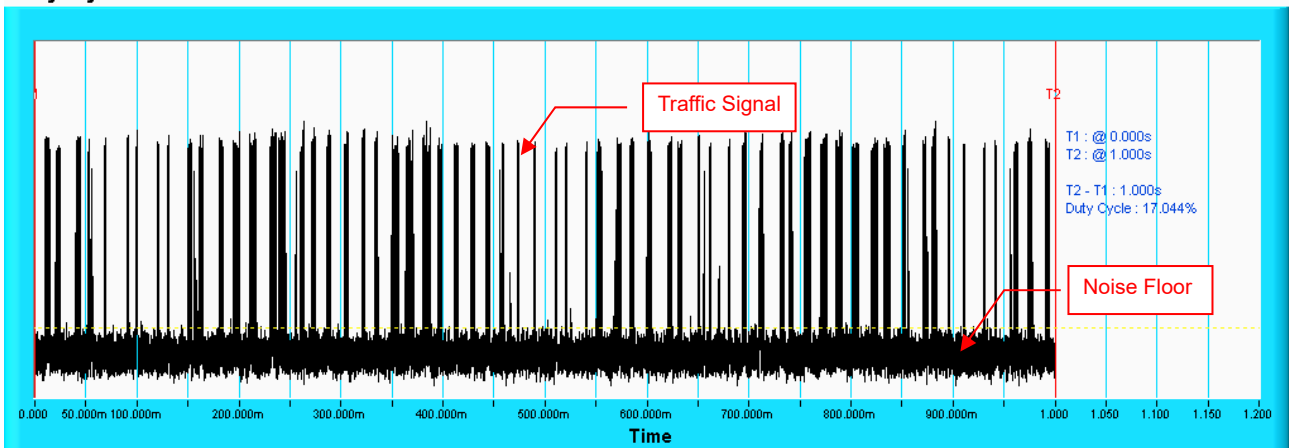

802.11ax (HE80) Duty Cycle

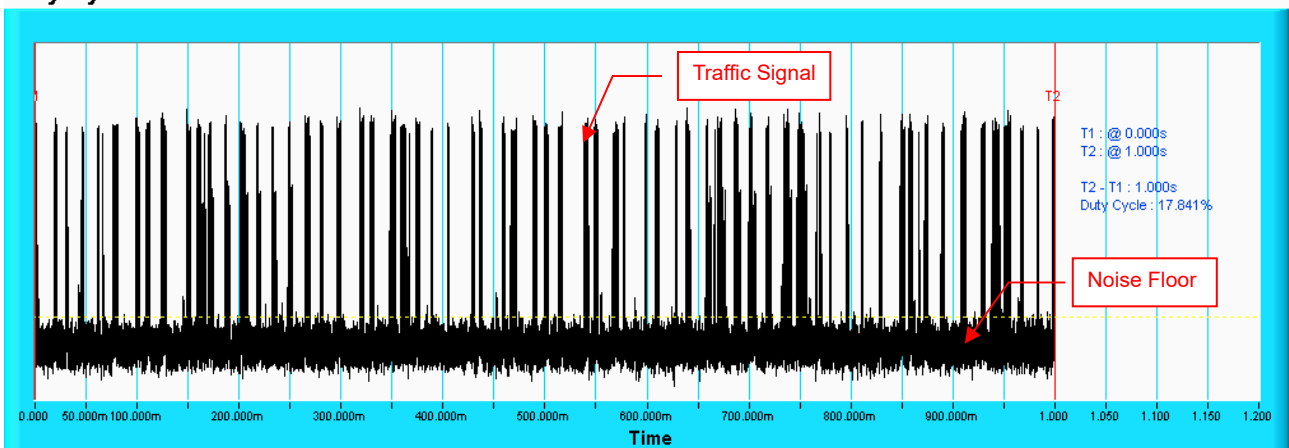

Note: Traffic signal: from master transmit to slave.

IEEE 802.11ax HE20

Table 1: Short Pulse Radar Test Waveforms.

| Radar Type | Pulse Width (µsec) | PRI (µsec) | Number of Pulses | Number of Trials(Times) | Percentage of Successful Detection (%) |
|-----------------------------|------------------------------------------------------------------------------------------------------------------------------------------------------------------------------------------------------------------------------------------------------------------------------------|----------------------------------------------------------------------------------------------------------------|------------------|-------------------------|----------------------------------------|
| 1 | <p>Test A: 15 unique PRI values randomly selected from the list of 23 PRI values in Table 5a</p> <p>-----</p> <p>Test B: 15 unique PRI values randomly selected within the range of 518-3066 µsec, with a minimum increment of 1 µsec, excluding PRI values selected in Test A</p> | $\left\lceil \frac{1}{360} \cdot \left(\frac{19 \cdot 10^6}{\text{PRI}_{\mu\text{sec}}} \right) \right\rceil$ | 18 | 30 | 100 |
| 2 | 1-5 | 150-230 | 23-29 | 30 | 100 |
| 3 | 6-10 | 200-500 | 16-18 | 30 | 93.33 |
| 4 | 11-20 | 200-500 | 12-16 | 30 | 90 |
| Aggregate (Radar Types 1-4) | | | | 120 | 95.83 |

Table 2: Long Pulse Radar Test Waveform

| Radar Type | Pulse Width (µsec) | Chirp Width (MHz) | PRI (µsec) | Number of Pulses per Burst | Number of Bursts | Number of Trials(Times) | Percentage of Successful Detection (%) |
|------------|--------------------|-------------------|------------|----------------------------|------------------|-------------------------|----------------------------------------|
| 5 | 50-100 | 5-20 | 1000-2000 | 1-3 | 8-20 | 30 | 100 |

Table 3: Frequency Hopping Radar Test Waveform

| Radar Type | Pulse Width (µsec) | PRI (µsec) | Pulses per Hop | Hopping Rate (kHz) | Hopping Sequence Length (msec) | Number of Trials(Times) | Percentage of Successful Detection (%) |
|------------|--------------------|------------|----------------|--------------------|--------------------------------|-------------------------|----------------------------------------|
| 6 | 1 | 333 | 9 | 0.333 | 300 | 30 | 100 |

The Detailed Radar pattern and Statistical Performance showed in Annex A.

IEEE 802.11ax HE40

Table 1: Short Pulse Radar Test Waveforms.

| Radar Type | Pulse Width (μsec) | PRI (μsec) | Number of Pulses | Number of Trials(Times) | Percentage of Successful Detection (%) |
|-----------------------------|---------------------------------------------------------------------------------------------------------------------------------------------------------------------------------------------------------------------------------------------------------------------|-------------------------------------------------------------------------------------------------------------------------------|------------------|-------------------------|----------------------------------------|
| 1 | Test A: 15 unique PRI values randomly selected from the list of 23 PRI values in Table 5a ----- Test B: 15 unique PRI values randomly selected within the range of 518-3066 μsec, with a minimum increment of 1 μsec, excluding PRI values selected in Test A | $\left. \begin{array}{c} \frac{1}{360} \\ \\ 19 \cdot 10^6 \\ \text{PRI}_{\mu\text{sec}} \end{array} \right\} \text{Roundup}$ | 18 | 30 | 100 |
| 2 | 1-5 | 150-230 | 23-29 | 30 | 96.67 |
| 3 | 6-10 | 200-500 | 16-18 | 30 | 96.67 |
| 4 | 11-20 | 200-500 | 12-16 | 30 | 93.33 |
| Aggregate (Radar Types 1-4) | | | | 120 | 96.67 |

Table 2: Long Pulse Radar Test Waveform

| Radar Type | Pulse Width (μsec) | Chirp Width (MHz) | PRI (μsec) | Number of Pulses per Burst | Number of Bursts | Number of Trials(Times) | Percentage of Successful Detection (%) |
|------------|--------------------|-------------------|------------|----------------------------|------------------|-------------------------|----------------------------------------|
| 5 | 50-100 | 5-20 | 1000-2000 | 1-3 | 8-20 | 30 | 100 |

Table 3: Frequency Hopping Radar Test Waveform

| Radar Type | Pulse Width (μsec) | PRI (μsec) | Pulses per Hop | Hopping Rate (kHz) | Hopping Sequence Length (msec) | Number of Trials(Times) | Percentage of Successful Detection (%) |
|------------|--------------------|------------|----------------|--------------------|--------------------------------|-------------------------|----------------------------------------|
| 6 | 1 | 333 | 9 | 0.333 | 300 | 30 | 100 |

The Detailed Radar pattern and Statistical Performance showed in Annex A.

IEEE 802.11ax HE80

Table 1: Short Pulse Radar Test Waveforms.

| Radar Type | Pulse Width (μsec) | PRI (μsec) | Number of Pulses | Number of Trials(Times) | Percentage of Successful Detection (%) |
|-----------------------------|------------------------------------------------------------------------------------------------------------------------------------------------------------------------------------------------------------------------------------------------------------------------------------|------------------------------------------------------------------------------------------------------------------------------------------|------------------|-------------------------|----------------------------------------|
| 1 | <p>Test A: 15 unique PRI values randomly selected from the list of 23 PRI values in Table 5a</p> <p>-----</p> <p>Test B: 15 unique PRI values randomly selected within the range of 518-3066 μsec, with a minimum increment of 1 μsec, excluding PRI values selected in Test A</p> | $\text{Roundup} \left\{ \left\{ \frac{1}{360} \right\} \cdot \left\{ \frac{19 \cdot 10^6}{\text{PRI}_{\mu\text{sec}}} \right\} \right\}$ | 18 | 30 | 96.67 |
| 2 | 1-5 | 150-230 | 23-29 | 30 | 96.67 |
| 3 | 6-10 | 200-500 | 16-18 | 30 | 100 |
| 4 | 11-20 | 200-500 | 12-16 | 30 | 90 |
| Aggregate (Radar Types 1-4) | | | | 120 | 95.83 |

Table 2: Long Pulse Radar Test Waveform

| Radar Type | Pulse Width (μsec) | Chirp Width (MHz) | PRI (μsec) | Number of Pulses per Burst | Number of Bursts | Number of Trials(Times) | Percentage of Successful Detection (%) |
|------------|--------------------|-------------------|------------|----------------------------|------------------|-------------------------|----------------------------------------|
| 5 | 50-100 | 5-20 | 1000-2000 | 1-3 | 8-20 | 30 | 100 |

Table 3: Frequency Hopping Radar Test Waveform

| Radar Type | Pulse Width (μsec) | PRI (μsec) | Pulses per Hop | Hopping Rate (kHz) | Hopping Sequence Length (msec) | Number of Trials(Times) | Percentage of Successful Detection (%) |
|------------|--------------------|------------|----------------|--------------------|--------------------------------|-------------------------|----------------------------------------|
| 6 | 1 | 333 | 9 | 0.333 | 300 | 30 | 100 |

The Detailed Radar pattern and Statistical Performance showed in Annex A.

**Radar signal 0
802.11ax (HE80)**

Channel Closing Transmission Time & Channel Move Time

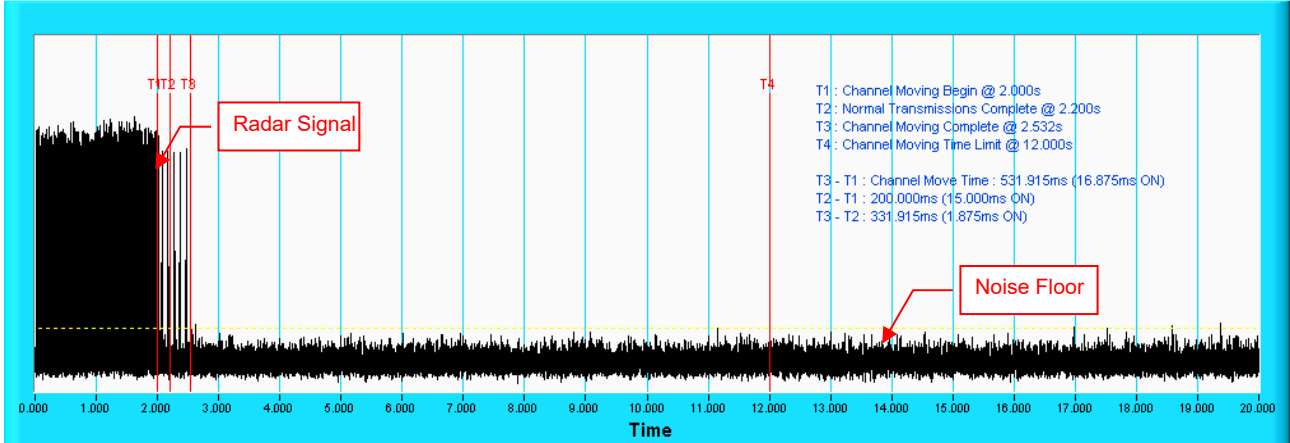

Note: T1 denotes the start of Channel Move Time upon the end of the last Radar burst. T2 denotes the data transmission time of 200ms from T1. T3 denotes the end of Channel Move Time. T4 denotes the 10 second from T1 to observe the aggregate duration of transmissions.

Channel Closing Transmission Time & Channel Move Time

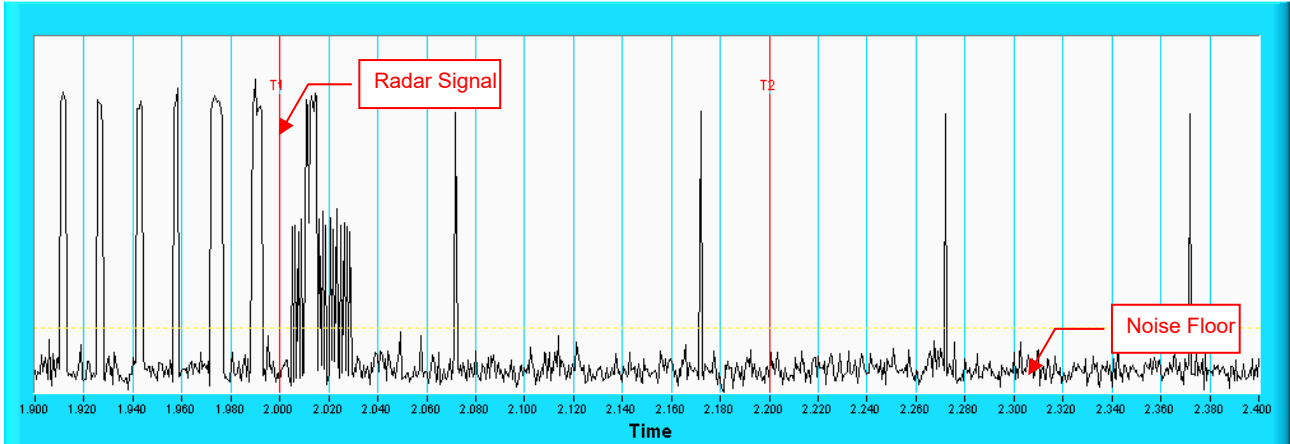

Note: Room-in of the first 500ms after radar signal applied.

**Radar signal 1
802.11ax (HE80)**

Channel Closing Transmission Time & Channel Move Time

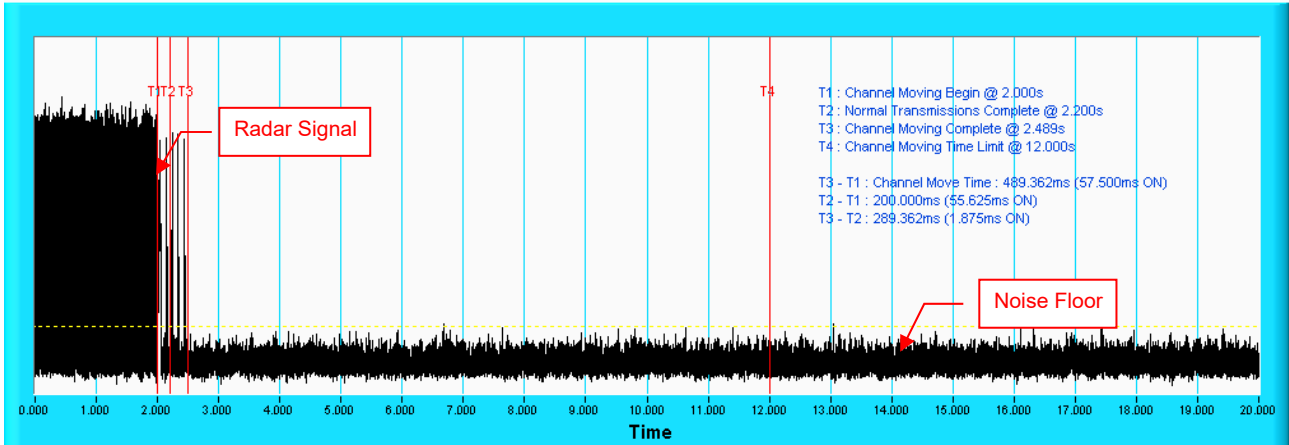

Note: T1 denotes the start of Channel Move Time upon the end of the last Radar burst. T2 denotes the data transmission time of 200ms from T1. T3 denotes the end of Channel Move Time. T4 denotes the 10 second from T1 to observe the aggregate duration of transmissions.

Channel Closing Transmission Time & Channel Move Time

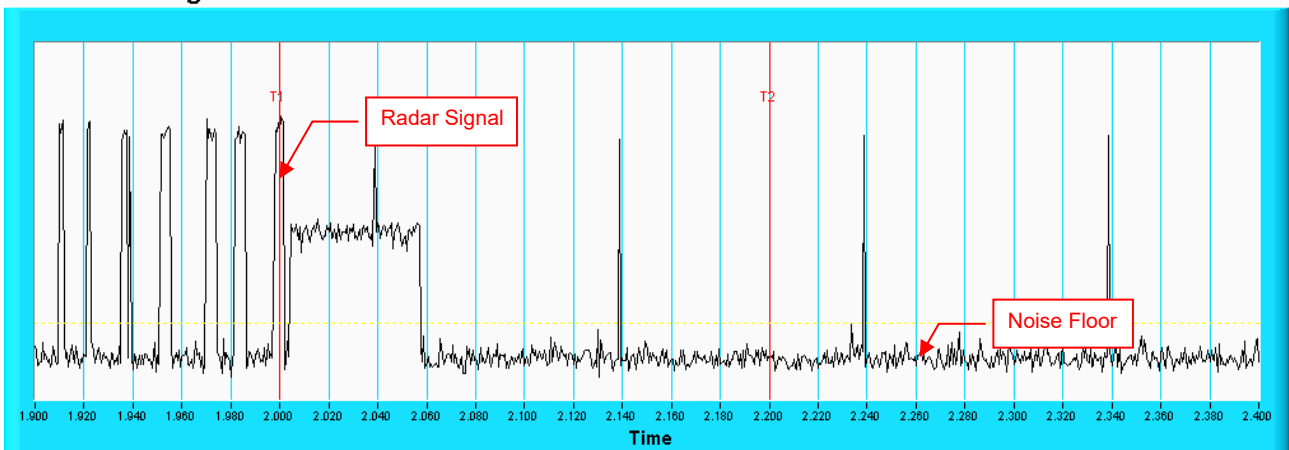

Note: Room-in of the first 500ms after radar signal applied.

Radar signal 2
802.11ax (HE80)
Channel Closing Transmission Time & Channel Move Time

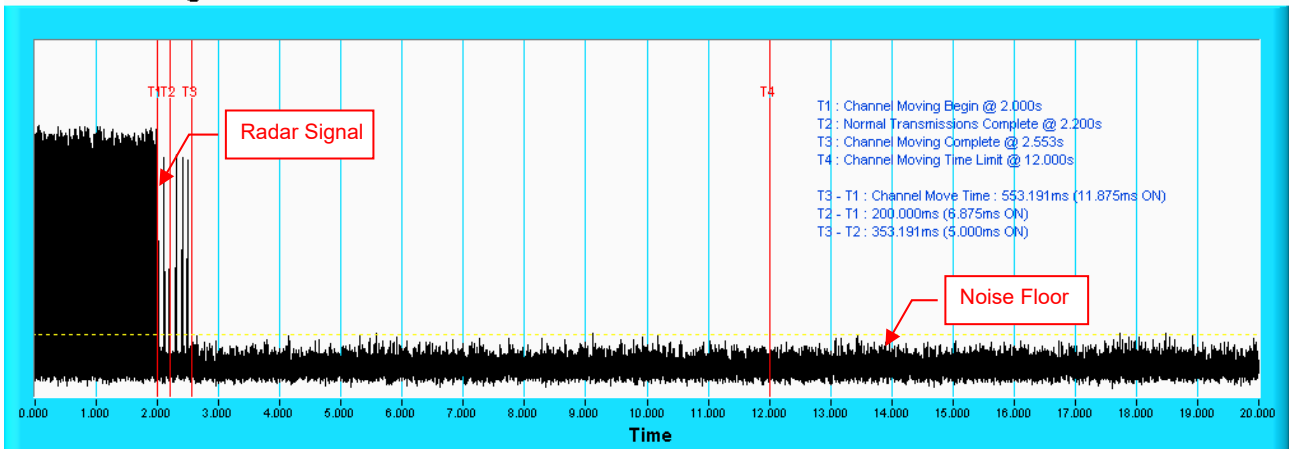

Note: T1 denotes the start of Channel Move Time upon the end of the last Radar burst. T2 denotes the data transmission time of 200ms from T1. T3 denotes the end of Channel Move Time. T4 denotes the 10 second from T1 to observe the aggregate duration of transmissions.

Channel Closing Transmission Time & Channel Move Time

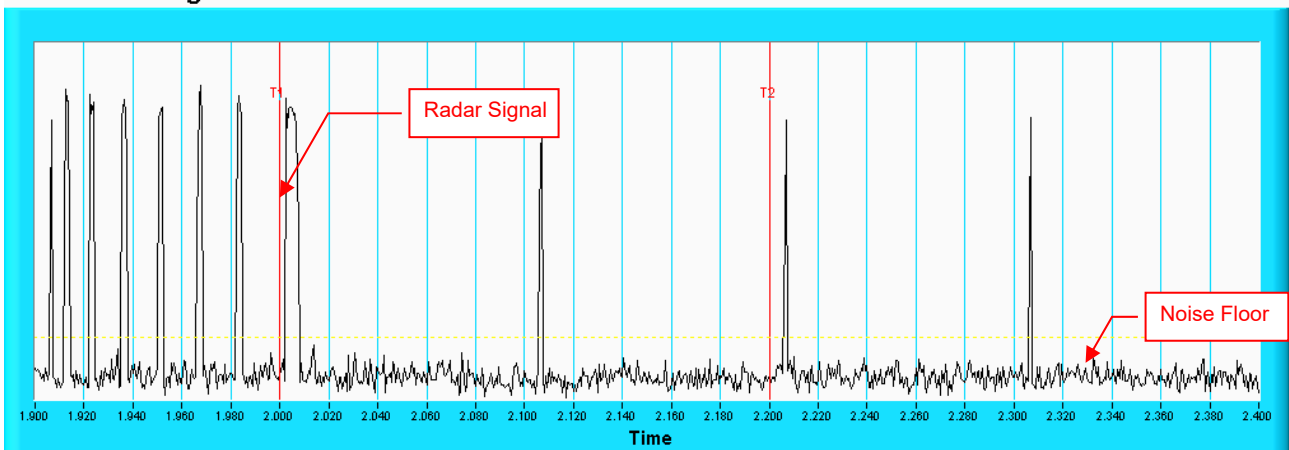

Note: Room-in of the first 500ms after radar signal applied.

Radar signal 3
802.11ax (HE80)
Channel Closing Transmission Time & Channel Move Time

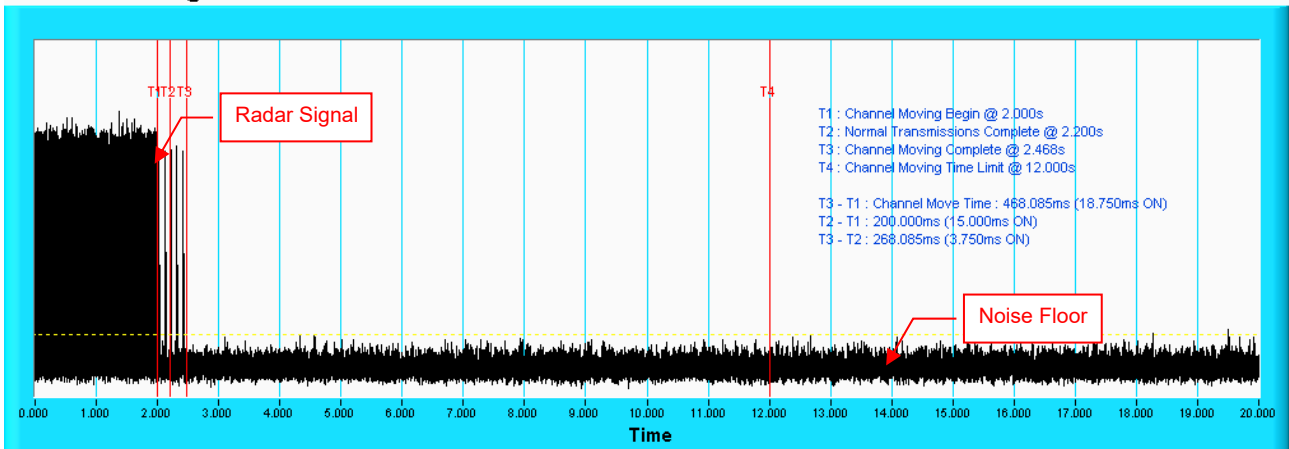

Note: T1 denotes the start of Channel Move Time upon the end of the last Radar burst. T2 denotes the data transmission time of 200ms from T1. T3 denotes the end of Channel Move Time. T4 denotes the 10 second from T1 to observe the aggregate duration of transmissions.

Channel Closing Transmission Time & Channel Move Time

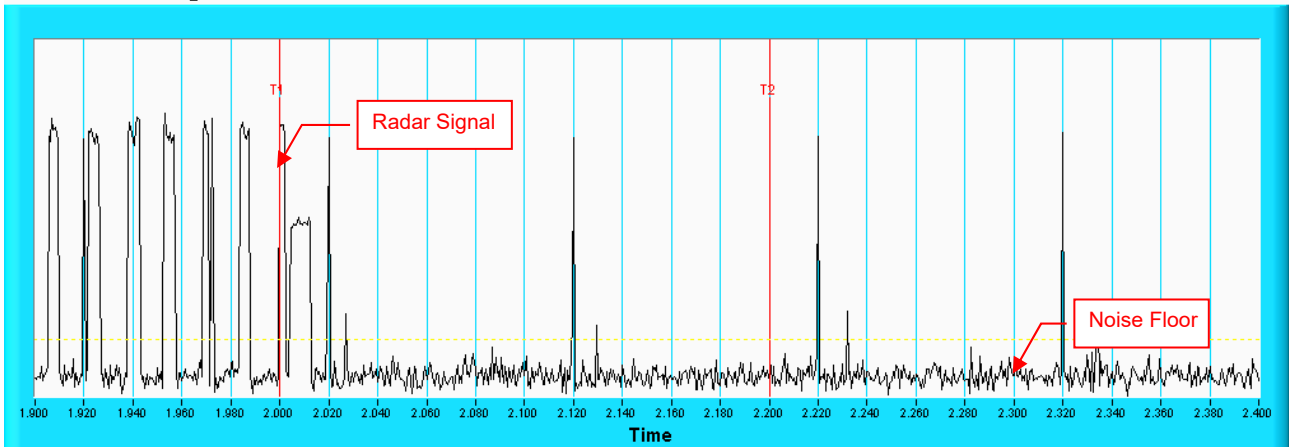

Note: Room-in of the first 500ms after radar signal applied.

Radar signal 4
802.11ax (HE80)
Channel Closing Transmission Time & Channel Move Time

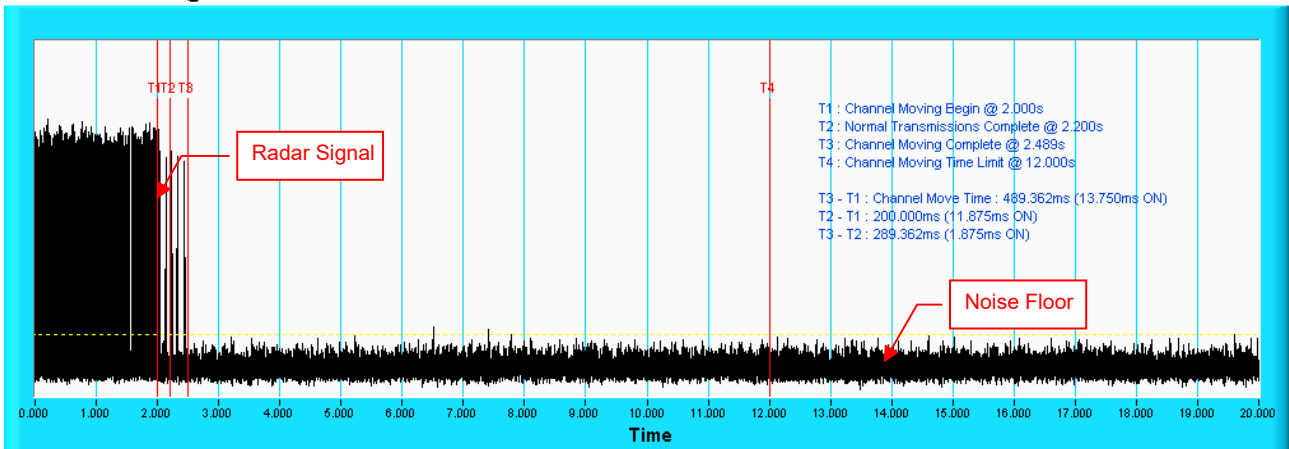

Note: T1 denotes the start of Channel Move Time upon the end of the last Radar burst. T2 denotes the data transmission time of 200ms from T1. T3 denotes the end of Channel Move Time. T4 denotes the 10 second from T1 to observe the aggregate duration of transmissions.

Channel Closing Transmission Time & Channel Move Time

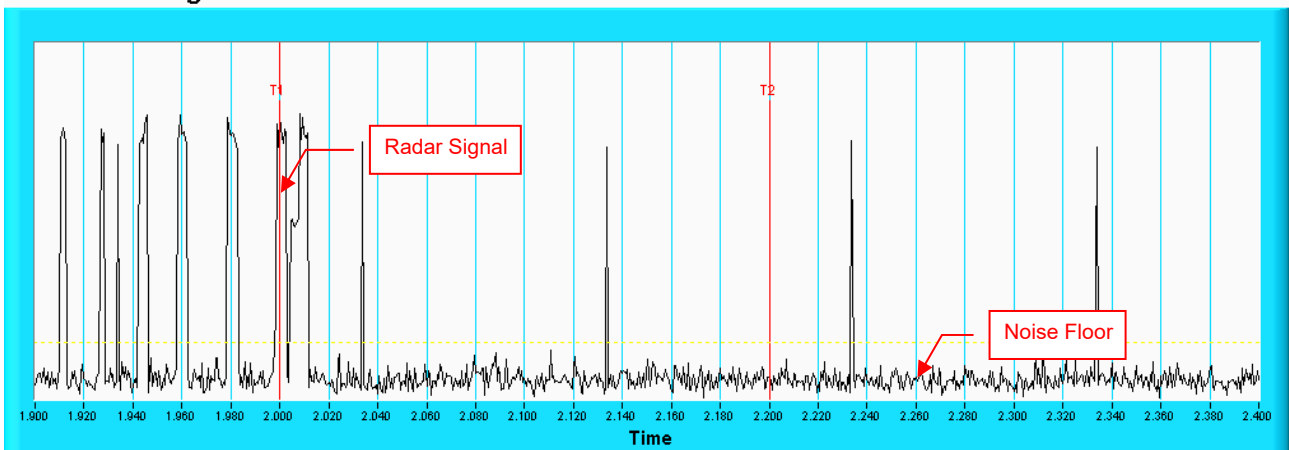

Note: Room-in of the first 500ms after radar signal applied.

802.11ax HE20
Type 1 Radar Statistical Performances

| Trial # | Test Frequency (MHz) | Pulse Repetition Frequency Number (1 to 23) | Pulse Repetition Frequency (Pulse per seconds) | Pulses per Burst | Pulse Repetition Interval (microseconds) | Detection |
|-----------------------|----------------------|---------------------------------------------|------------------------------------------------|------------------|------------------------------------------|-----------|
| 1 | 5498 | 15 | 1253 | 67 | 798 | Yes |
| 2 | 5491 | 16 | 1223 | 65 | 818 | Yes |
| 3 | 5500 | 4 | 1730 | 92 | 578 | Yes |
| 4 | 5506 | 11 | 1393 | 74 | 718 | Yes |
| 5 | 5492 | 22 | 1066 | 57 | 938 | Yes |
| 6 | 5496 | 7 | 1567 | 83 | 638 | Yes |
| 7 | 5510 | 2 | 1859 | 99 | 538 | Yes |
| 8 | 5497 | 8 | 1520 | 81 | 658 | Yes |
| 9 | 5495 | 1 | 1931 | 102 | 518 | Yes |
| 10 | 5502 | 19 | 1139 | 61 | 878 | Yes |
| 11 | 5507 | 21 | 1089 | 58 | 918 | Yes |
| 12 | 5501 | 23 | 326.2 | 18 | 3066 | Yes |
| 13 | 5494 | 9 | 1475 | 78 | 678 | Yes |
| 14 | 5505 | 5 | 1672 | 89 | 598 | Yes |
| 15 | 5499 | 6 | 1618 | 86 | 618 | Yes |
| 16 | 5508 | | 1111 | 59 | 900 | Yes |
| 17 | 5509 | | 1024 | 55 | 977 | Yes |
| 18 | 5503 | | 625.8 | 34 | 1598 | Yes |
| 19 | 5504 | | 730.5 | 39 | 1369 | Yes |
| 20 | 5493 | | 1181 | 63 | 847 | Yes |
| 21 | 5490 | | 400.6 | 22 | 2496 | Yes |
| 22 | 5493 | | 529.4 | 28 | 1889 | Yes |
| 23 | 5505 | | 347.6 | 19 | 2877 | Yes |
| 24 | 5490 | | 641.4 | 34 | 1559 | Yes |
| 25 | 5502 | | 508.9 | 27 | 1965 | Yes |
| 26 | 5497 | | 345.4 | 19 | 2895 | Yes |
| 27 | 5491 | | 580.7 | 31 | 1722 | Yes |
| 28 | 5508 | | 786.8 | 42 | 1271 | Yes |
| 29 | 5501 | | 808.4 | 43 | 1237 | Yes |
| 30 | 5499 | | 517.1 | 28 | 1934 | Yes |
| Detection Rate: 100 % | | | | | | |

Type 2 Radar Statistical Performances

| Trial # | Test Frequency (MHz) | Pulses per Burst | Pulse Width(us) | PRI(us) | Detection |
|-----------------------|----------------------|------------------|-----------------|---------|-----------|
| 1 | 5492 | 24 | 1.7 | 174 | Yes |
| 2 | 5495 | 27 | 3.8 | 176 | Yes |
| 3 | 5503 | 28 | 4 | 161 | Yes |
| 4 | 5510 | 28 | 4.3 | 226 | Yes |
| 5 | 5493 | 24 | 1.9 | 193 | Yes |
| 6 | 5509 | 23 | 1.1 | 230 | Yes |
| 7 | 5506 | 29 | 4.5 | 198 | Yes |
| 8 | 5494 | 26 | 2.9 | 227 | Yes |
| 9 | 5507 | 26 | 2.8 | 171 | Yes |
| 10 | 5499 | 27 | 3.6 | 221 | Yes |
| 11 | 5504 | 23 | 1.1 | 180 | Yes |
| 12 | 5508 | 23 | 1.3 | 189 | Yes |
| 13 | 5505 | 25 | 2.5 | 204 | Yes |
| 14 | 5502 | 29 | 4.5 | 203 | Yes |
| 15 | 5491 | 29 | 5 | 170 | Yes |
| 16 | 5496 | 26 | 3.1 | 201 | Yes |
| 17 | 5501 | 24 | 2.1 | 218 | Yes |
| 18 | 5497 | 25 | 2.6 | 208 | Yes |
| 19 | 5500 | 24 | 1.8 | 223 | Yes |
| 20 | 5490 | 23 | 1.2 | 220 | Yes |
| 21 | 5498 | 26 | 2.9 | 224 | Yes |
| 22 | 5490 | 28 | 4 | 160 | Yes |
| 23 | 5505 | 25 | 2.5 | 209 | Yes |
| 24 | 5500 | 23 | 1 | 205 | Yes |
| 25 | 5509 | 27 | 3.7 | 151 | Yes |
| 26 | 5494 | 25 | 2.5 | 186 | Yes |
| 27 | 5504 | 23 | 1.5 | 190 | Yes |
| 28 | 5496 | 23 | 1.3 | 185 | Yes |
| 29 | 5507 | 23 | 1.2 | 175 | Yes |
| 30 | 5503 | 24 | 1.7 | 216 | Yes |
| Detection Rate: 100 % | | | | | |

Type 3 Radar Statistical Performances

| Trial # | Test Frequency (MHz) | Pulses per Burst | Pulse Width(us) | PRI(us) | Detection |
|-------------------------|----------------------|------------------|-----------------|---------|-----------|
| 1 | 5504 | 16 | 6.7 | 467 | Yes |
| 2 | 5507 | 18 | 8.8 | 304 | Yes |
| 3 | 5510 | 18 | 9 | 316 | Yes |
| 4 | 5493 | 18 | 9.3 | 439 | Yes |
| 5 | 5505 | 16 | 6.9 | 420 | Yes |
| 6 | 5502 | 16 | 6.1 | 249 | Yes |
| 7 | 5494 | 18 | 9.5 | 463 | Yes |
| 8 | 5495 | 17 | 7.9 | 258 | Yes |
| 9 | 5492 | 17 | 7.8 | 212 | Yes |
| 10 | 5499 | 17 | 8.6 | 236 | Yes |
| 11 | 5503 | 16 | 6.1 | 474 | Yes |
| 12 | 5501 | 16 | 6.3 | 461 | Yes |
| 13 | 5506 | 17 | 7.5 | 437 | Yes |
| 14 | 5500 | 18 | 9.5 | 287 | Yes |
| 15 | 5497 | 18 | 10 | 395 | Yes |
| 16 | 5496 | 17 | 8.1 | 322 | Yes |
| 17 | 5491 | 16 | 7.1 | 468 | Yes |
| 18 | 5498 | 17 | 7.6 | 255 | Yes |
| 19 | 5508 | 16 | 6.8 | 423 | Yes |
| 20 | 5509 | 16 | 6.2 | 456 | Yes |
| 21 | 5490 | 17 | 7.9 | 351 | No |
| 22 | 5498 | 18 | 9 | 411 | Yes |
| 23 | 5495 | 17 | 7.5 | 279 | No |
| 24 | 5492 | 16 | 6 | 431 | Yes |
| 25 | 5491 | 17 | 8.7 | 324 | Yes |
| 26 | 5502 | 17 | 7.5 | 419 | Yes |
| 27 | 5505 | 16 | 6.5 | 447 | Yes |
| 28 | 5496 | 16 | 6.3 | 481 | Yes |
| 29 | 5497 | 16 | 6.2 | 438 | Yes |
| 30 | 5504 | 16 | 6.7 | 270 | Yes |
| Detection Rate: 93.33 % | | | | | |

Type 4 Radar Statistical Performances

| Trial # | Test Frequency (MHz) | Pulses per Burst | Pulse Width(us) | PRI(us) | Detection |
|----------------------|----------------------|------------------|-----------------|---------|-----------|
| 1 | 5495 | 12 | 12.5 | 467 | Yes |
| 2 | 5504 | 15 | 17.2 | 304 | Yes |
| 3 | 5492 | 15 | 17.8 | 316 | Yes |
| 4 | 5499 | 16 | 18.5 | 439 | Yes |
| 5 | 5490 | 13 | 13.1 | 420 | No |
| 6 | 5498 | 12 | 11.3 | 249 | Yes |
| 7 | 5508 | 16 | 18.8 | 463 | Yes |
| 8 | 5510 | 14 | 15.3 | 258 | Yes |
| 9 | 5491 | 14 | 15.1 | 212 | Yes |
| 10 | 5496 | 15 | 16.9 | 236 | Yes |
| 11 | 5507 | 12 | 11.2 | 474 | Yes |
| 12 | 5497 | 12 | 11.7 | 461 | Yes |
| 13 | 5502 | 13 | 14.4 | 437 | Yes |
| 14 | 5503 | 16 | 18.9 | 287 | No |
| 15 | 5494 | 16 | 19.9 | 395 | No |
| 16 | 5505 | 14 | 15.7 | 322 | Yes |
| 17 | 5501 | 13 | 13.4 | 468 | Yes |
| 18 | 5493 | 13 | 14.5 | 255 | Yes |
| 19 | 5506 | 13 | 12.9 | 423 | Yes |
| 20 | 5509 | 12 | 11.5 | 456 | Yes |
| 21 | 5500 | 14 | 15.3 | 351 | Yes |
| 22 | 5508 | 15 | 17.8 | 411 | Yes |
| 23 | 5491 | 13 | 14.3 | 279 | Yes |
| 24 | 5492 | 12 | 11.1 | 431 | Yes |
| 25 | 5507 | 15 | 17 | 324 | Yes |
| 26 | 5494 | 13 | 14.5 | 419 | Yes |
| 27 | 5495 | 12 | 12.1 | 447 | Yes |
| 28 | 5501 | 12 | 11.7 | 481 | Yes |
| 29 | 5497 | 12 | 11.6 | 438 | Yes |
| 30 | 5505 | 12 | 12.7 | 270 | Yes |
| Detection Rate: 90 % | | | | | |

Type 5 Radar Statistical Performances

| Trial # | Minimum Chirp Width(MHz) | Chirp Center Frequency(MHz) | Test Signal Name | Detection |
|-----------------------|--------------------------|-----------------------------|------------------|-----------|
| 1 | 12 | 5500.00 | LP_Signal_01 | Yes |
| 2 | 9 | 5500.00 | LP_Signal_02 | Yes |
| 3 | 20 | 5500.00 | LP_Signal_03 | Yes |
| 4 | 7 | 5500.00 | LP_Signal_04 | Yes |
| 5 | 7 | 5500.00 | LP_Signal_05 | Yes |
| 6 | 19 | 5500.00 | LP_Signal_06 | Yes |
| 7 | 15 | 5500.00 | LP_Signal_07 | Yes |
| 8 | 19 | 5500.00 | LP_Signal_08 | Yes |
| 9 | 7 | 5500.00 | LP_Signal_09 | Yes |
| 10 | 12 | 5500.00 | LP_Signal_10 | Yes |
| 11 | 16 | 5496.93 | LP_Signal_11 | Yes |
| 12 | 19 | 5498.13 | LP_Signal_12 | Yes |
| 13 | 13 | 5495.73 | LP_Signal_13 | Yes |
| 14 | 10 | 5494.53 | LP_Signal_14 | Yes |
| 15 | 18 | 5497.73 | LP_Signal_15 | Yes |
| 16 | 12 | 5495.33 | LP_Signal_16 | Yes |
| 17 | 20 | 5498.53 | LP_Signal_17 | Yes |
| 18 | 10 | 5494.53 | LP_Signal_18 | Yes |
| 19 | 12 | 5495.33 | LP_Signal_19 | Yes |
| 20 | 10 | 5494.53 | LP_Signal_20 | Yes |
| 21 | 15 | 5503.47 | LP_Signal_21 | Yes |
| 22 | 9 | 5505.87 | LP_Signal_22 | Yes |
| 23 | 20 | 5501.47 | LP_Signal_23 | Yes |
| 24 | 12 | 5504.67 | LP_Signal_24 | Yes |
| 25 | 11 | 5505.07 | LP_Signal_25 | Yes |
| 26 | 5 | 5507.47 | LP_Signal_26 | Yes |
| 27 | 16 | 5503.07 | LP_Signal_27 | Yes |
| 28 | 19 | 5501.87 | LP_Signal_28 | Yes |
| 29 | 10 | 5505.47 | LP_Signal_29 | Yes |
| 30 | 17 | 5502.67 | LP_Signal_30 | Yes |
| Detection Rate: 100 % | | | | |

The Long Pulse Radar pattern shown in Appendix A.1

Type 6 Radar Statistical Performances

| Trial # | Pulses per Burst | Pulse Width(us) | PRI(us) | Detection |
|-----------------------|------------------|-----------------|---------|-----------|
| 1 | 9 | 1 | 333.3 | Yes |
| 2 | 9 | 1 | 333.3 | Yes |
| 3 | 9 | 1 | 333.3 | Yes |
| 4 | 9 | 1 | 333.3 | Yes |
| 5 | 9 | 1 | 333.3 | Yes |
| 6 | 9 | 1 | 333.3 | Yes |
| 7 | 9 | 1 | 333.3 | Yes |
| 8 | 9 | 1 | 333.3 | Yes |
| 9 | 9 | 1 | 333.3 | Yes |
| 10 | 9 | 1 | 333.3 | Yes |
| 11 | 9 | 1 | 333.3 | Yes |
| 12 | 9 | 1 | 333.3 | Yes |
| 13 | 9 | 1 | 333.3 | Yes |
| 14 | 9 | 1 | 333.3 | Yes |
| 15 | 9 | 1 | 333.3 | Yes |
| 16 | 9 | 1 | 333.3 | Yes |
| 17 | 9 | 1 | 333.3 | Yes |
| 18 | 9 | 1 | 333.3 | Yes |
| 19 | 9 | 1 | 333.3 | Yes |
| 20 | 9 | 1 | 333.3 | Yes |
| 21 | 9 | 1 | 333.3 | Yes |
| 22 | 9 | 1 | 333.3 | Yes |
| 23 | 9 | 1 | 333.3 | Yes |
| 24 | 9 | 1 | 333.3 | Yes |
| 25 | 9 | 1 | 333.3 | Yes |
| 26 | 9 | 1 | 333.3 | Yes |
| 27 | 9 | 1 | 333.3 | Yes |
| 28 | 9 | 1 | 333.3 | Yes |
| 29 | 9 | 1 | 333.3 | Yes |
| 30 | 9 | 1 | 333.3 | Yes |
| Detection Rate: 100 % | | | | |

Type 6 Radar Statistical Performances

| Trial # | Hopping Frequency Sequence Name | Detection |
|-----------------------|---------------------------------|-----------|
| 1 | HOP_FREQ_SEQ_01 | Yes |
| 2 | HOP_FREQ_SEQ_02 | Yes |
| 3 | HOP_FREQ_SEQ_03 | Yes |
| 4 | HOP_FREQ_SEQ_04 | Yes |
| 5 | HOP_FREQ_SEQ_05 | Yes |
| 6 | HOP_FREQ_SEQ_06 | Yes |
| 7 | HOP_FREQ_SEQ_07 | Yes |
| 8 | HOP_FREQ_SEQ_08 | Yes |
| 9 | HOP_FREQ_SEQ_09 | Yes |
| 10 | HOP_FREQ_SEQ_10 | Yes |
| 11 | HOP_FREQ_SEQ_11 | Yes |
| 12 | HOP_FREQ_SEQ_12 | Yes |
| 13 | HOP_FREQ_SEQ_13 | Yes |
| 14 | HOP_FREQ_SEQ_14 | Yes |
| 15 | HOP_FREQ_SEQ_15 | Yes |
| 16 | HOP_FREQ_SEQ_16 | Yes |
| 17 | HOP_FREQ_SEQ_17 | Yes |
| 18 | HOP_FREQ_SEQ_18 | Yes |
| 19 | HOP_FREQ_SEQ_19 | Yes |
| 20 | HOP_FREQ_SEQ_20 | Yes |
| 21 | HOP_FREQ_SEQ_21 | Yes |
| 22 | HOP_FREQ_SEQ_22 | Yes |
| 23 | HOP_FREQ_SEQ_23 | Yes |
| 24 | HOP_FREQ_SEQ_24 | Yes |
| 25 | HOP_FREQ_SEQ_25 | Yes |
| 26 | HOP_FREQ_SEQ_26 | Yes |
| 27 | HOP_FREQ_SEQ_27 | Yes |
| 28 | HOP_FREQ_SEQ_28 | Yes |
| 29 | HOP_FREQ_SEQ_29 | Yes |
| 30 | HOP_FREQ_SEQ_30 | Yes |
| Detection Rate: 100 % | | |

The Frequency Hopping Radar pattern shown in Appendix A.2

802.11ax HE40

Type 1 Radar Statistical Performances

| Trial # | Test Frequency (MHz) | Pulse Repetition Frequency Number (1 to 23) | Pulse Repetition Frequency (Pulse per seconds) | Pulses per Burst | Pulse Repetition Interval (microseconds) | Detection |
|-----------------------|----------------------|---------------------------------------------|------------------------------------------------|------------------|------------------------------------------|-----------|
| 1 | 5490 | 15 | 1253 | 67 | 798 | Yes |
| 2 | 5520 | 16 | 1223 | 65 | 818 | Yes |
| 3 | 5523 | 4 | 1730 | 92 | 578 | Yes |
| 4 | 5505 | 11 | 1393 | 74 | 718 | Yes |
| 5 | 5498 | 22 | 1066 | 57 | 938 | Yes |
| 6 | 5507 | 7 | 1567 | 83 | 638 | Yes |
| 7 | 5528 | 2 | 1859 | 99 | 538 | Yes |
| 8 | 5513 | 8 | 1520 | 81 | 658 | Yes |
| 9 | 5524 | 1 | 1931 | 102 | 518 | Yes |
| 10 | 5495 | 19 | 1139 | 61 | 878 | Yes |
| 11 | 5494 | 21 | 1089 | 58 | 918 | Yes |
| 12 | 5493 | 23 | 326.2 | 18 | 3066 | Yes |
| 13 | 5491 | 9 | 1475 | 78 | 678 | Yes |
| 14 | 5510 | 5 | 1672 | 89 | 598 | Yes |
| 15 | 5504 | 6 | 1618 | 86 | 618 | Yes |
| 16 | 5509 | | 1111 | 59 | 900 | Yes |
| 17 | 5515 | | 1024 | 55 | 977 | Yes |
| 18 | 5502 | | 625.8 | 34 | 1598 | Yes |
| 19 | 5500 | | 730.5 | 39 | 1369 | Yes |
| 20 | 5518 | | 1181 | 63 | 847 | Yes |
| 21 | 5517 | | 400.6 | 22 | 2496 | Yes |
| 22 | 5508 | | 529.4 | 28 | 1889 | Yes |
| 23 | 5521 | | 347.6 | 19 | 2877 | Yes |
| 24 | 5499 | | 641.4 | 34 | 1559 | Yes |
| 25 | 5506 | | 508.9 | 27 | 1965 | Yes |
| 26 | 5529 | | 345.4 | 19 | 2895 | Yes |
| 27 | 5497 | | 580.7 | 31 | 1722 | Yes |
| 28 | 5530 | | 786.8 | 42 | 1271 | Yes |
| 29 | 5503 | | 808.4 | 43 | 1237 | Yes |
| 30 | 5519 | | 517.1 | 28 | 1934 | Yes |
| Detection Rate: 100 % | | | | | | |

Type 2 Radar Statistical Performances

| Trial # | Test Frequency (MHz) | Pulses per Burst | Pulse Width(us) | PRI(us) | Detection |
|-------------------------|----------------------|------------------|-----------------|---------|-----------|
| 1 | 5510 | 24 | 1.7 | 174 | Yes |
| 2 | 5505 | 27 | 3.8 | 176 | Yes |
| 3 | 5491 | 28 | 4 | 161 | Yes |
| 4 | 5512 | 28 | 4.3 | 226 | Yes |
| 5 | 5522 | 24 | 1.9 | 193 | Yes |
| 6 | 5514 | 23 | 1.1 | 230 | Yes |
| 7 | 5521 | 29 | 4.5 | 198 | Yes |
| 8 | 5524 | 26 | 2.9 | 227 | Yes |
| 9 | 5498 | 26 | 2.8 | 171 | Yes |
| 10 | 5518 | 27 | 3.6 | 221 | Yes |
| 11 | 5515 | 23 | 1.1 | 180 | Yes |
| 12 | 5501 | 23 | 1.3 | 189 | Yes |
| 13 | 5502 | 25 | 2.5 | 204 | Yes |
| 14 | 5503 | 29 | 4.5 | 203 | Yes |
| 15 | 5497 | 29 | 5 | 170 | Yes |
| 16 | 5520 | 26 | 3.1 | 201 | Yes |
| 17 | 5504 | 24 | 2.1 | 218 | Yes |
| 18 | 5490 | 25 | 2.6 | 208 | Yes |
| 19 | 5508 | 24 | 1.8 | 223 | Yes |
| 20 | 5527 | 23 | 1.2 | 220 | Yes |
| 21 | 5500 | 26 | 2.9 | 224 | Yes |
| 22 | 5511 | 28 | 4 | 160 | Yes |
| 23 | 5496 | 25 | 2.5 | 209 | Yes |
| 24 | 5517 | 23 | 1 | 205 | Yes |
| 25 | 5525 | 27 | 3.7 | 151 | Yes |
| 26 | 5494 | 25 | 2.5 | 186 | Yes |
| 27 | 5516 | 23 | 1.5 | 190 | Yes |
| 28 | 5513 | 23 | 1.3 | 185 | No |
| 29 | 5507 | 23 | 1.2 | 175 | Yes |
| 30 | 5529 | 24 | 1.7 | 216 | Yes |
| Detection Rate: 96.67 % | | | | | |

Type 3 Radar Statistical Performances

| Trial # | Test Frequency (MHz) | Pulses per Burst | Pulse Width(us) | PRI(us) | Detection |
|-------------------------|----------------------|------------------|-----------------|---------|-----------|
| 1 | 5524 | 16 | 6.7 | 467 | Yes |
| 2 | 5525 | 18 | 8.8 | 304 | Yes |
| 3 | 5492 | 18 | 9 | 316 | Yes |
| 4 | 5493 | 18 | 9.3 | 439 | Yes |
| 5 | 5520 | 16 | 6.9 | 420 | Yes |
| 6 | 5490 | 16 | 6.1 | 249 | No |
| 7 | 5495 | 18 | 9.5 | 463 | Yes |
| 8 | 5526 | 17 | 7.9 | 258 | Yes |
| 9 | 5506 | 17 | 7.8 | 212 | Yes |
| 10 | 5528 | 17 | 8.6 | 236 | Yes |
| 11 | 5498 | 16 | 6.1 | 474 | Yes |
| 12 | 5522 | 16 | 6.3 | 461 | Yes |
| 13 | 5510 | 17 | 7.5 | 437 | Yes |
| 14 | 5496 | 18 | 9.5 | 287 | Yes |
| 15 | 5523 | 18 | 10 | 395 | Yes |
| 16 | 5499 | 17 | 8.1 | 322 | Yes |
| 17 | 5511 | 16 | 7.1 | 468 | Yes |
| 18 | 5507 | 17 | 7.6 | 255 | Yes |
| 19 | 5509 | 16 | 6.8 | 423 | Yes |
| 20 | 5514 | 16 | 6.2 | 456 | Yes |
| 21 | 5497 | 17 | 7.9 | 351 | Yes |
| 22 | 5529 | 18 | 9 | 411 | Yes |
| 23 | 5517 | 17 | 7.5 | 279 | Yes |
| 24 | 5494 | 16 | 6 | 431 | Yes |
| 25 | 5512 | 17 | 8.7 | 324 | Yes |
| 26 | 5519 | 17 | 7.5 | 419 | Yes |
| 27 | 5500 | 16 | 6.5 | 447 | Yes |
| 28 | 5515 | 16 | 6.3 | 481 | Yes |
| 29 | 5521 | 16 | 6.2 | 438 | Yes |
| 30 | 5516 | 16 | 6.7 | 270 | Yes |
| Detection Rate: 96.67 % | | | | | |

Type 4 Radar Statistical Performances

| Trial # | Test Frequency (MHz) | Pulses per Burst | Pulse Width(us) | PRI(us) | Detection |
|-------------------------|----------------------|------------------|-----------------|---------|-----------|
| 1 | 5528 | 12 | 12.5 | 467 | Yes |
| 2 | 5496 | 15 | 17.2 | 304 | Yes |
| 3 | 5514 | 15 | 17.8 | 316 | Yes |
| 4 | 5498 | 16 | 18.5 | 439 | Yes |
| 5 | 5494 | 13 | 13.1 | 420 | Yes |
| 6 | 5500 | 12 | 11.3 | 249 | Yes |
| 7 | 5529 | 16 | 18.8 | 463 | Yes |
| 8 | 5513 | 14 | 15.3 | 258 | Yes |
| 9 | 5505 | 14 | 15.1 | 212 | Yes |
| 10 | 5499 | 15 | 16.9 | 236 | Yes |
| 11 | 5492 | 12 | 11.2 | 474 | Yes |
| 12 | 5509 | 12 | 11.7 | 461 | Yes |
| 13 | 5526 | 13 | 14.4 | 437 | Yes |
| 14 | 5503 | 16 | 18.9 | 287 | Yes |
| 15 | 5512 | 16 | 19.9 | 395 | Yes |
| 16 | 5515 | 14 | 15.7 | 322 | Yes |
| 17 | 5522 | 13 | 13.4 | 468 | Yes |
| 18 | 5507 | 13 | 14.5 | 255 | Yes |
| 19 | 5490 | 13 | 12.9 | 423 | Yes |
| 20 | 5508 | 12 | 11.5 | 456 | Yes |
| 21 | 5519 | 14 | 15.3 | 351 | Yes |
| 22 | 5504 | 15 | 17.8 | 411 | No |
| 23 | 5511 | 13 | 14.3 | 279 | Yes |
| 24 | 5525 | 12 | 11.1 | 431 | Yes |
| 25 | 5502 | 15 | 17 | 324 | Yes |
| 26 | 5491 | 13 | 14.5 | 419 | Yes |
| 27 | 5510 | 12 | 12.1 | 447 | Yes |
| 28 | 5497 | 12 | 11.7 | 481 | Yes |
| 29 | 5518 | 12 | 11.6 | 438 | No |
| 30 | 5501 | 12 | 12.7 | 270 | Yes |
| Detection Rate: 93.33 % | | | | | |

Type 5 Radar Statistical Performances

| Trial # | Minimum Chirp Width(MHz) | Chirp Center Frequency(MHz) | Test Signal Name | Detection |
|-----------------------|--------------------------|-----------------------------|------------------|-----------|
| 1 | 13 | 5510.00 | LP_Signal_01 | Yes |
| 2 | 12 | 5510.00 | LP_Signal_02 | Yes |
| 3 | 14 | 5510.00 | LP_Signal_03 | Yes |
| 4 | 6 | 5510.00 | LP_Signal_04 | Yes |
| 5 | 7 | 5510.00 | LP_Signal_05 | Yes |
| 6 | 11 | 5510.00 | LP_Signal_06 | Yes |
| 7 | 9 | 5510.00 | LP_Signal_07 | Yes |
| 8 | 9 | 5510.00 | LP_Signal_08 | Yes |
| 9 | 12 | 5510.00 | LP_Signal_09 | Yes |
| 10 | 11 | 5510.00 | LP_Signal_10 | Yes |
| 11 | 16 | 5497.55 | LP_Signal_11 | Yes |
| 12 | 19 | 5498.75 | LP_Signal_12 | Yes |
| 13 | 13 | 5496.35 | LP_Signal_13 | Yes |
| 14 | 10 | 5495.15 | LP_Signal_14 | Yes |
| 15 | 18 | 5498.35 | LP_Signal_15 | Yes |
| 16 | 12 | 5495.95 | LP_Signal_16 | Yes |
| 17 | 20 | 5499.15 | LP_Signal_17 | Yes |
| 18 | 10 | 5495.15 | LP_Signal_18 | Yes |
| 19 | 12 | 5495.95 | LP_Signal_19 | Yes |
| 20 | 10 | 5495.15 | LP_Signal_20 | Yes |
| 21 | 15 | 5522.85 | LP_Signal_21 | Yes |
| 22 | 9 | 5525.25 | LP_Signal_22 | Yes |
| 23 | 20 | 5520.85 | LP_Signal_23 | Yes |
| 24 | 12 | 5524.05 | LP_Signal_24 | Yes |
| 25 | 11 | 5524.45 | LP_Signal_25 | Yes |
| 26 | 5 | 5526.85 | LP_Signal_26 | Yes |
| 27 | 16 | 5522.45 | LP_Signal_27 | Yes |
| 28 | 19 | 5521.25 | LP_Signal_28 | Yes |
| 29 | 10 | 5524.85 | LP_Signal_29 | Yes |
| 30 | 17 | 5522.05 | LP_Signal_30 | Yes |
| Detection Rate: 100 % | | | | |

The Long Pulse Radar pattern shown in Appendix A.1

Type 6 Radar Statistical Performances

| Trial # | Pulses per Burst | Pulse Width(us) | PRI(us) | Detection |
|-----------------------|------------------|-----------------|---------|-----------|
| 1 | 9 | 1 | 333.3 | Yes |
| 2 | 9 | 1 | 333.3 | Yes |
| 3 | 9 | 1 | 333.3 | Yes |
| 4 | 9 | 1 | 333.3 | Yes |
| 5 | 9 | 1 | 333.3 | Yes |
| 6 | 9 | 1 | 333.3 | Yes |
| 7 | 9 | 1 | 333.3 | Yes |
| 8 | 9 | 1 | 333.3 | Yes |
| 9 | 9 | 1 | 333.3 | Yes |
| 10 | 9 | 1 | 333.3 | Yes |
| 11 | 9 | 1 | 333.3 | Yes |
| 12 | 9 | 1 | 333.3 | Yes |
| 13 | 9 | 1 | 333.3 | Yes |
| 14 | 9 | 1 | 333.3 | Yes |
| 15 | 9 | 1 | 333.3 | Yes |
| 16 | 9 | 1 | 333.3 | Yes |
| 17 | 9 | 1 | 333.3 | Yes |
| 18 | 9 | 1 | 333.3 | Yes |
| 19 | 9 | 1 | 333.3 | Yes |
| 20 | 9 | 1 | 333.3 | Yes |
| 21 | 9 | 1 | 333.3 | Yes |
| 22 | 9 | 1 | 333.3 | Yes |
| 23 | 9 | 1 | 333.3 | Yes |
| 24 | 9 | 1 | 333.3 | Yes |
| 25 | 9 | 1 | 333.3 | Yes |
| 26 | 9 | 1 | 333.3 | Yes |
| 27 | 9 | 1 | 333.3 | Yes |
| 28 | 9 | 1 | 333.3 | Yes |
| 29 | 9 | 1 | 333.3 | Yes |
| 30 | 9 | 1 | 333.3 | Yes |
| Detection Rate: 100 % | | | | |

Type 6 Radar Statistical Performances

| Trial # | Hopping Frequency Sequence Name | Detection |
|-----------------------|---------------------------------|-----------|
| 1 | HOP_FREQ_SEQ_01 | Yes |
| 2 | HOP_FREQ_SEQ_02 | Yes |
| 3 | HOP_FREQ_SEQ_03 | Yes |
| 4 | HOP_FREQ_SEQ_04 | Yes |
| 5 | HOP_FREQ_SEQ_05 | Yes |
| 6 | HOP_FREQ_SEQ_06 | Yes |
| 7 | HOP_FREQ_SEQ_07 | Yes |
| 8 | HOP_FREQ_SEQ_08 | Yes |
| 9 | HOP_FREQ_SEQ_09 | Yes |
| 10 | HOP_FREQ_SEQ_10 | Yes |
| 11 | HOP_FREQ_SEQ_11 | Yes |
| 12 | HOP_FREQ_SEQ_12 | Yes |
| 13 | HOP_FREQ_SEQ_13 | Yes |
| 14 | HOP_FREQ_SEQ_14 | Yes |
| 15 | HOP_FREQ_SEQ_15 | Yes |
| 16 | HOP_FREQ_SEQ_16 | Yes |
| 17 | HOP_FREQ_SEQ_17 | Yes |
| 18 | HOP_FREQ_SEQ_18 | Yes |
| 19 | HOP_FREQ_SEQ_19 | Yes |
| 20 | HOP_FREQ_SEQ_20 | Yes |
| 21 | HOP_FREQ_SEQ_21 | Yes |
| 22 | HOP_FREQ_SEQ_22 | Yes |
| 23 | HOP_FREQ_SEQ_23 | Yes |
| 24 | HOP_FREQ_SEQ_24 | Yes |
| 25 | HOP_FREQ_SEQ_25 | Yes |
| 26 | HOP_FREQ_SEQ_26 | Yes |
| 27 | HOP_FREQ_SEQ_27 | Yes |
| 28 | HOP_FREQ_SEQ_28 | Yes |
| 29 | HOP_FREQ_SEQ_29 | Yes |
| 30 | HOP_FREQ_SEQ_30 | Yes |
| Detection Rate: 100 % | | |

The Frequency Hopping Radar pattern shown in Appendix A.2

802.11ax HE80

Type 1 Radar Statistical Performances

| Trial # | Test Frequency (MHz) | Pulse Repetition Frequency Number (1 to 23) | Pulse Repetition Frequency (Pulse per seconds) | Pulses per Burst | Pulse Repetition Interval (microseconds) | Detection |
|-------------------------|----------------------|---------------------------------------------|------------------------------------------------|------------------|------------------------------------------|-----------|
| 1 | 5498 | 15 | 1253 | 67 | 798 | Yes |
| 2 | 5524 | 16 | 1223 | 65 | 818 | Yes |
| 3 | 5492 | 4 | 1730 | 92 | 578 | Yes |
| 4 | 5546 | 11 | 1393 | 74 | 718 | Yes |
| 5 | 5502 | 22 | 1066 | 57 | 938 | Yes |
| 6 | 5495 | 7 | 1567 | 83 | 638 | Yes |
| 7 | 5516 | 2 | 1859 | 99 | 538 | Yes |
| 8 | 5527 | 8 | 1520 | 81 | 658 | Yes |
| 9 | 5509 | 1 | 1931 | 102 | 518 | Yes |
| 10 | 5520 | 19 | 1139 | 61 | 878 | Yes |
| 11 | 5567 | 21 | 1089 | 58 | 918 | Yes |
| 12 | 5564 | 23 | 326.2 | 18 | 3066 | Yes |
| 13 | 5566 | 9 | 1475 | 78 | 678 | Yes |
| 14 | 5523 | 5 | 1672 | 89 | 598 | Yes |
| 15 | 5504 | 6 | 1618 | 86 | 618 | Yes |
| 16 | 5561 | | 1111 | 59 | 900 | Yes |
| 17 | 5543 | | 1024 | 55 | 977 | Yes |
| 18 | 5506 | | 625.8 | 34 | 1598 | Yes |
| 19 | 5553 | | 730.5 | 39 | 1369 | Yes |
| 20 | 5507 | | 1181 | 63 | 847 | Yes |
| 21 | 5570 | | 400.6 | 22 | 2496 | Yes |
| 22 | 5494 | | 529.4 | 28 | 1889 | No |
| 23 | 5513 | | 347.6 | 19 | 2877 | Yes |
| 24 | 5496 | | 641.4 | 34 | 1559 | Yes |
| 25 | 5534 | | 508.9 | 27 | 1965 | Yes |
| 26 | 5542 | | 345.4 | 19 | 2895 | Yes |
| 27 | 5493 | | 580.7 | 31 | 1722 | Yes |
| 28 | 5517 | | 786.8 | 42 | 1271 | Yes |
| 29 | 5518 | | 808.4 | 43 | 1237 | Yes |
| 30 | 5541 | | 517.1 | 28 | 1934 | Yes |
| Detection Rate: 96.67 % | | | | | | |

Type 2 Radar Statistical Performances

| Trial # | Test Frequency (MHz) | Pulses per Burst | Pulse Width(us) | PRI(us) | Detection |
|-------------------------|----------------------|------------------|-----------------|---------|-----------|
| 1 | 5558 | 24 | 1.7 | 174 | Yes |
| 2 | 5536 | 27 | 3.8 | 176 | Yes |
| 3 | 5551 | 28 | 4 | 161 | Yes |
| 4 | 5506 | 28 | 4.3 | 226 | Yes |
| 5 | 5513 | 24 | 1.9 | 193 | Yes |
| 6 | 5495 | 23 | 1.1 | 230 | Yes |
| 7 | 5496 | 29 | 4.5 | 198 | Yes |
| 8 | 5510 | 26 | 2.9 | 227 | Yes |
| 9 | 5498 | 26 | 2.8 | 171 | Yes |
| 10 | 5537 | 27 | 3.6 | 221 | Yes |
| 11 | 5554 | 23 | 1.1 | 180 | Yes |
| 12 | 5501 | 23 | 1.3 | 189 | Yes |
| 13 | 5541 | 25 | 2.5 | 204 | Yes |
| 14 | 5543 | 29 | 4.5 | 203 | Yes |
| 15 | 5509 | 29 | 5 | 170 | Yes |
| 16 | 5505 | 26 | 3.1 | 201 | Yes |
| 17 | 5503 | 24 | 2.1 | 218 | Yes |
| 18 | 5491 | 25 | 2.6 | 208 | Yes |
| 19 | 5534 | 24 | 1.8 | 223 | Yes |
| 20 | 5568 | 23 | 1.2 | 220 | Yes |
| 21 | 5508 | 26 | 2.9 | 224 | Yes |
| 22 | 5552 | 28 | 4 | 160 | Yes |
| 23 | 5519 | 25 | 2.5 | 209 | Yes |
| 24 | 5520 | 23 | 1 | 205 | Yes |
| 25 | 5512 | 27 | 3.7 | 151 | Yes |
| 26 | 5517 | 25 | 2.5 | 186 | Yes |
| 27 | 5494 | 23 | 1.5 | 190 | Yes |
| 28 | 5570 | 23 | 1.3 | 185 | No |
| 29 | 5544 | 23 | 1.2 | 175 | Yes |
| 30 | 5524 | 24 | 1.7 | 216 | Yes |
| Detection Rate: 96.67 % | | | | | |

Type 3 Radar Statistical Performances

| Trial # | Test Frequency (MHz) | Pulses per Burst | Pulse Width(us) | PRI(us) | Detection |
|-----------------------|----------------------|------------------|-----------------|---------|-----------|
| 1 | 5521 | 16 | 6.7 | 467 | Yes |
| 2 | 5491 | 18 | 8.8 | 304 | Yes |
| 3 | 5513 | 18 | 9 | 316 | Yes |
| 4 | 5493 | 18 | 9.3 | 439 | Yes |
| 5 | 5563 | 16 | 6.9 | 420 | Yes |
| 6 | 5495 | 16 | 6.1 | 249 | Yes |
| 7 | 5494 | 18 | 9.5 | 463 | Yes |
| 8 | 5497 | 17 | 7.9 | 258 | Yes |
| 9 | 5546 | 17 | 7.8 | 212 | Yes |
| 10 | 5544 | 17 | 8.6 | 236 | Yes |
| 11 | 5562 | 16 | 6.1 | 474 | Yes |
| 12 | 5501 | 16 | 6.3 | 461 | Yes |
| 13 | 5528 | 17 | 7.5 | 437 | Yes |
| 14 | 5511 | 18 | 9.5 | 287 | Yes |
| 15 | 5498 | 18 | 10 | 395 | Yes |
| 16 | 5553 | 17 | 8.1 | 322 | Yes |
| 17 | 5506 | 16 | 7.1 | 468 | Yes |
| 18 | 5509 | 17 | 7.6 | 255 | Yes |
| 19 | 5526 | 16 | 6.8 | 423 | Yes |
| 20 | 5522 | 16 | 6.2 | 456 | Yes |
| 21 | 5531 | 17 | 7.9 | 351 | Yes |
| 22 | 5515 | 18 | 9 | 411 | Yes |
| 23 | 5529 | 17 | 7.5 | 279 | Yes |
| 24 | 5504 | 16 | 6 | 431 | Yes |
| 25 | 5555 | 17 | 8.7 | 324 | Yes |
| 26 | 5550 | 17 | 7.5 | 419 | Yes |
| 27 | 5560 | 16 | 6.5 | 447 | Yes |
| 28 | 5516 | 16 | 6.3 | 481 | Yes |
| 29 | 5549 | 16 | 6.2 | 438 | Yes |
| 30 | 5518 | 16 | 6.7 | 270 | Yes |
| Detection Rate: 100 % | | | | | |

Type 4 Radar Statistical Performances

| Trial # | Test Frequency (MHz) | Pulses per Burst | Pulse Width(us) | PRI(us) | Detection |
|----------------------|----------------------|------------------|-----------------|---------|-----------|
| 1 | 5513 | 12 | 12.5 | 467 | Yes |
| 2 | 5555 | 15 | 17.2 | 304 | Yes |
| 3 | 5492 | 15 | 17.8 | 316 | Yes |
| 4 | 5554 | 16 | 18.5 | 439 | Yes |
| 5 | 5534 | 13 | 13.1 | 420 | Yes |
| 6 | 5547 | 12 | 11.3 | 249 | Yes |
| 7 | 5535 | 16 | 18.8 | 463 | Yes |
| 8 | 5524 | 14 | 15.3 | 258 | No |
| 9 | 5498 | 14 | 15.1 | 212 | Yes |
| 10 | 5514 | 15 | 16.9 | 236 | Yes |
| 11 | 5493 | 12 | 11.2 | 474 | Yes |
| 12 | 5525 | 12 | 11.7 | 461 | Yes |
| 13 | 5510 | 13 | 14.4 | 437 | Yes |
| 14 | 5539 | 16 | 18.9 | 287 | Yes |
| 15 | 5500 | 16 | 19.9 | 395 | No |
| 16 | 5543 | 14 | 15.7 | 322 | Yes |
| 17 | 5570 | 13 | 13.4 | 468 | No |
| 18 | 5541 | 13 | 14.5 | 255 | Yes |
| 19 | 5501 | 13 | 12.9 | 423 | Yes |
| 20 | 5497 | 12 | 11.5 | 456 | Yes |
| 21 | 5552 | 14 | 15.3 | 351 | Yes |
| 22 | 5568 | 15 | 17.8 | 411 | Yes |
| 23 | 5533 | 13 | 14.3 | 279 | Yes |
| 24 | 5496 | 12 | 11.1 | 431 | Yes |
| 25 | 5561 | 15 | 17 | 324 | Yes |
| 26 | 5545 | 13 | 14.5 | 419 | Yes |
| 27 | 5532 | 12 | 12.1 | 447 | Yes |
| 28 | 5551 | 12 | 11.7 | 481 | Yes |
| 29 | 5542 | 12 | 11.6 | 438 | Yes |
| 30 | 5519 | 12 | 12.7 | 270 | Yes |
| Detection Rate: 90 % | | | | | |

Type 5 Radar Statistical Performances

| Trial # | Minimum Chirp Width(MHz) | Chirp Center Frequency(MHz) | Test Signal Name | Detection |
|---------|--------------------------|-----------------------------|------------------|-----------|
| 1 | 11 | 5530.00 | LP_Signal_01 | Yes |
| 2 | 12 | 5530.00 | LP_Signal_02 | Yes |
| 3 | 19 | 5530.00 | LP_Signal_03 | Yes |
| 4 | 14 | 5530.00 | LP_Signal_04 | Yes |
| 5 | 9 | 5530.00 | LP_Signal_05 | Yes |
| 6 | 14 | 5530.00 | LP_Signal_06 | Yes |
| 7 | 9 | 5530.00 | LP_Signal_07 | Yes |
| 8 | 20 | 5530.00 | LP_Signal_08 | Yes |
| 9 | 6 | 5530.00 | LP_Signal_09 | Yes |
| 10 | 19 | 5530.00 | LP_Signal_10 | Yes |
| 11 | 19 | 5498.88 | LP_Signal_11 | Yes |
| 12 | 12 | 5496.08 | LP_Signal_12 | Yes |
| 13 | 18 | 5498.48 | LP_Signal_13 | Yes |
| 14 | 7 | 5494.08 | LP_Signal_14 | Yes |
| 15 | 9 | 5494.88 | LP_Signal_15 | Yes |
| 16 | 15 | 5497.28 | LP_Signal_16 | Yes |
| 17 | 15 | 5497.28 | LP_Signal_17 | Yes |
| 18 | 14 | 5496.88 | LP_Signal_18 | Yes |
| 19 | 19 | 5498.88 | LP_Signal_19 | Yes |
| 20 | 17 | 5498.08 | LP_Signal_20 | Yes |
| 21 | 5 | 5566.72 | LP_Signal_21 | Yes |
| 22 | 5 | 5566.72 | LP_Signal_22 | Yes |
| 23 | 13 | 5563.52 | LP_Signal_23 | Yes |
| 24 | 7 | 5565.92 | LP_Signal_24 | Yes |
| 25 | 14 | 5563.12 | LP_Signal_25 | Yes |
| 26 | 10 | 5564.72 | LP_Signal_26 | Yes |
| 27 | 15 | 5562.72 | LP_Signal_27 | Yes |
| 28 | 9 | 5565.12 | LP_Signal_28 | Yes |
| 29 | 5 | 5566.72 | LP_Signal_29 | Yes |
| 30 | 10 | 5564.72 | LP_Signal_30 | Yes |

Detection Rate: 100 %

The Long Pulse Radar pattern shown in Appendix A.1

Type 6 Radar Statistical Performances

| Trial # | Pulses per Burst | Pulse Width(us) | PRI(us) | Detection |
|-----------------------|------------------|-----------------|---------|-----------|
| 1 | 9 | 1 | 333.3 | Yes |
| 2 | 9 | 1 | 333.3 | Yes |
| 3 | 9 | 1 | 333.3 | Yes |
| 4 | 9 | 1 | 333.3 | Yes |
| 5 | 9 | 1 | 333.3 | Yes |
| 6 | 9 | 1 | 333.3 | Yes |
| 7 | 9 | 1 | 333.3 | Yes |
| 8 | 9 | 1 | 333.3 | Yes |
| 9 | 9 | 1 | 333.3 | Yes |
| 10 | 9 | 1 | 333.3 | Yes |
| 11 | 9 | 1 | 333.3 | Yes |
| 12 | 9 | 1 | 333.3 | Yes |
| 13 | 9 | 1 | 333.3 | Yes |
| 14 | 9 | 1 | 333.3 | Yes |
| 15 | 9 | 1 | 333.3 | Yes |
| 16 | 9 | 1 | 333.3 | Yes |
| 17 | 9 | 1 | 333.3 | Yes |
| 18 | 9 | 1 | 333.3 | Yes |
| 19 | 9 | 1 | 333.3 | Yes |
| 20 | 9 | 1 | 333.3 | Yes |
| 21 | 9 | 1 | 333.3 | Yes |
| 22 | 9 | 1 | 333.3 | Yes |
| 23 | 9 | 1 | 333.3 | Yes |
| 24 | 9 | 1 | 333.3 | Yes |
| 25 | 9 | 1 | 333.3 | Yes |
| 26 | 9 | 1 | 333.3 | Yes |
| 27 | 9 | 1 | 333.3 | Yes |
| 28 | 9 | 1 | 333.3 | Yes |
| 29 | 9 | 1 | 333.3 | Yes |
| 30 | 9 | 1 | 333.3 | Yes |
| Detection Rate: 100 % | | | | |

Type 6 Radar Statistical Performances

| Trial # | Hopping Frequency Sequence Name | Detection |
|-----------------------|---------------------------------|-----------|
| 1 | HOP_FREQ_SEQ_01 | Yes |
| 2 | HOP_FREQ_SEQ_02 | Yes |
| 3 | HOP_FREQ_SEQ_03 | Yes |
| 4 | HOP_FREQ_SEQ_04 | Yes |
| 5 | HOP_FREQ_SEQ_05 | Yes |
| 6 | HOP_FREQ_SEQ_06 | Yes |
| 7 | HOP_FREQ_SEQ_07 | Yes |
| 8 | HOP_FREQ_SEQ_08 | Yes |
| 9 | HOP_FREQ_SEQ_09 | Yes |
| 10 | HOP_FREQ_SEQ_10 | Yes |
| 11 | HOP_FREQ_SEQ_11 | Yes |
| 12 | HOP_FREQ_SEQ_12 | Yes |
| 13 | HOP_FREQ_SEQ_13 | Yes |
| 14 | HOP_FREQ_SEQ_14 | Yes |
| 15 | HOP_FREQ_SEQ_15 | Yes |
| 16 | HOP_FREQ_SEQ_16 | Yes |
| 17 | HOP_FREQ_SEQ_17 | Yes |
| 18 | HOP_FREQ_SEQ_18 | Yes |
| 19 | HOP_FREQ_SEQ_19 | Yes |
| 20 | HOP_FREQ_SEQ_20 | Yes |
| 21 | HOP_FREQ_SEQ_21 | Yes |
| 22 | HOP_FREQ_SEQ_22 | Yes |
| 23 | HOP_FREQ_SEQ_23 | Yes |
| 24 | HOP_FREQ_SEQ_24 | Yes |
| 25 | HOP_FREQ_SEQ_25 | Yes |
| 26 | HOP_FREQ_SEQ_26 | Yes |
| 27 | HOP_FREQ_SEQ_27 | Yes |
| 28 | HOP_FREQ_SEQ_28 | Yes |
| 29 | HOP_FREQ_SEQ_29 | Yes |
| 30 | HOP_FREQ_SEQ_30 | Yes |
| Detection Rate: 100 % | | |

The Frequency Hopping Radar pattern shown in Appendix A.2

6.2.5 Non-Occupancy Period

During the 30 minutes observation time, UUT did not make any transmissions on a channel after a radar signal was detected on that channel by either the Channel Availability Check or the In-Service Monitoring.

- 1) EUT (Master) links with Client on 5500MHz.

Waveform of EUT links up with Client

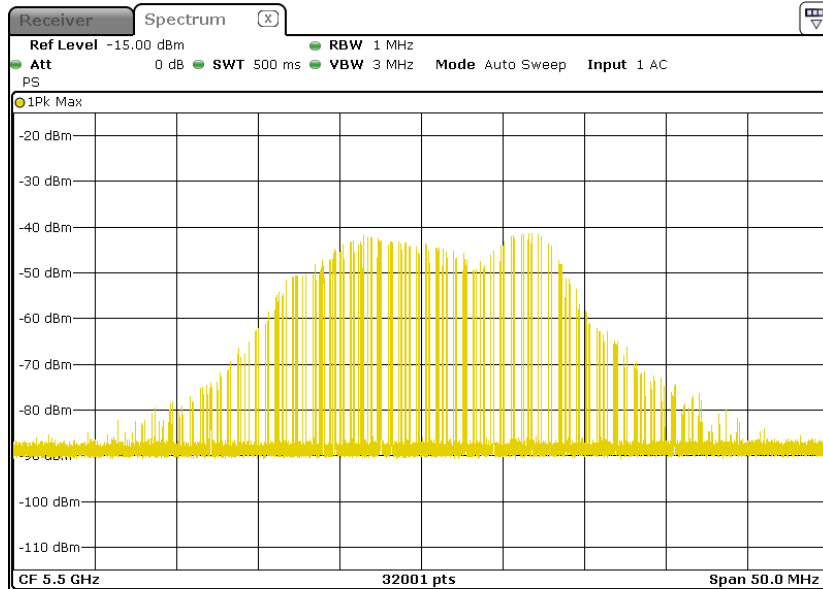

- 2) Client plays specified files via master.

Waveform of transmission

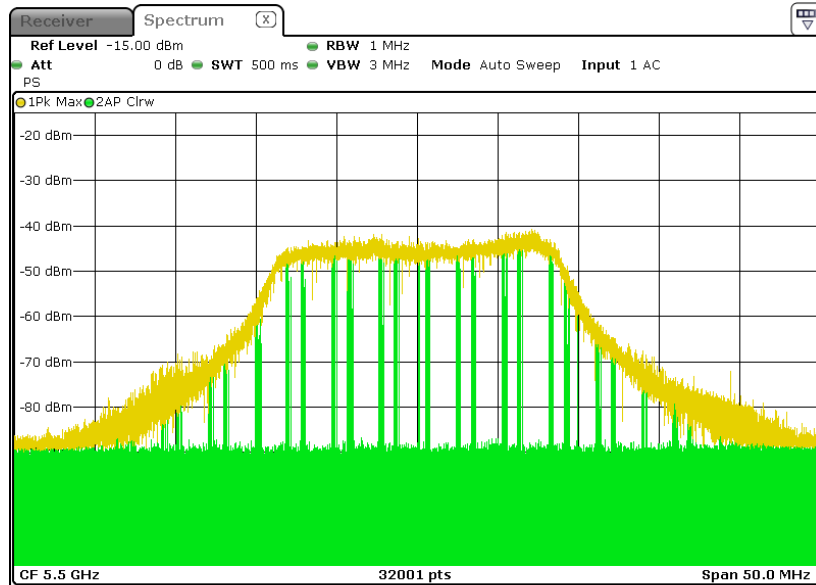

3) Radar signal is applied to the Master device and WiFi traffic signal stop immediately.

Radar 0

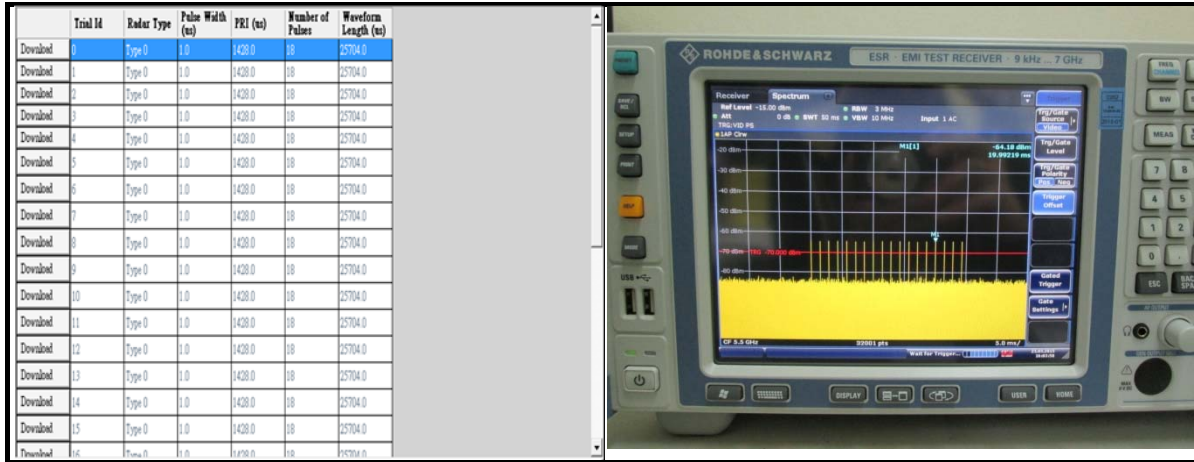

Radar 1

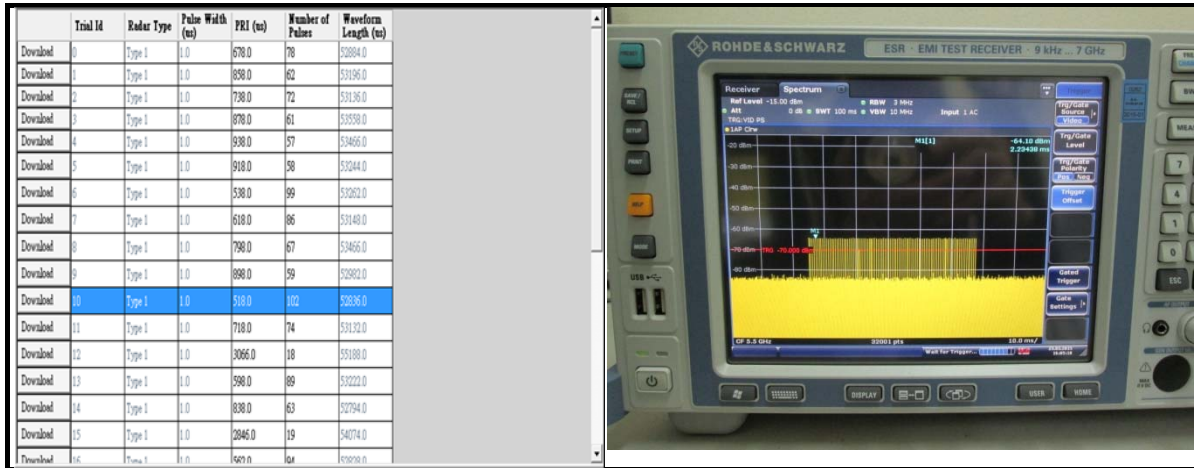

Radar 2

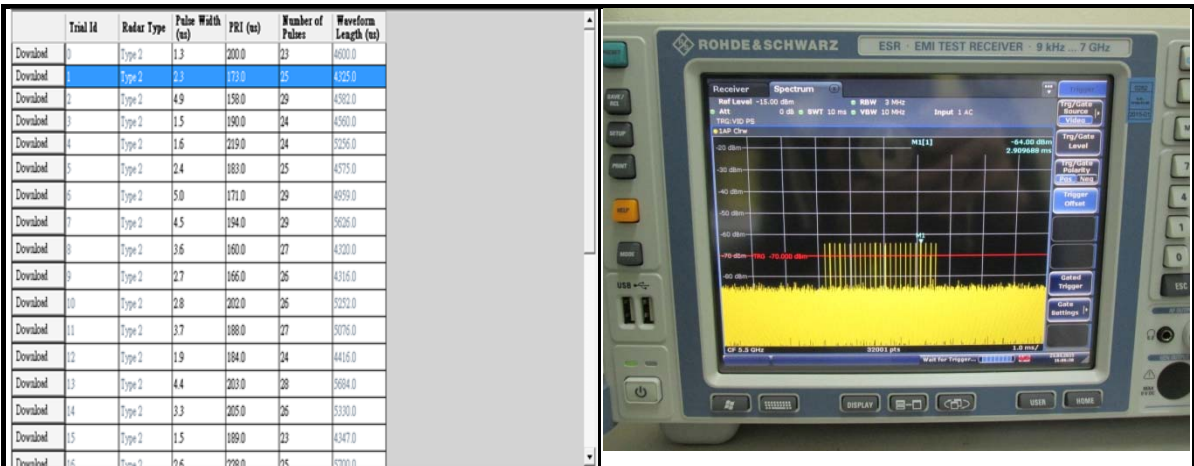

Radar 3

| Trial ID | Radar Type | Pulse Width (ns) | PRI (ns) | Number of Pulses | Waveform Length (ns) |
|-------------|------------|------------------|----------|------------------|----------------------|
| Download 0 | Type 3 | 8.2 | 355.0 | 17 | 6035.0 |
| Download 1 | Type 3 | 6.1 | 487.0 | 16 | 7792.0 |
| Download 2 | Type 3 | 7.1 | 344.0 | 16 | 5504.0 |
| Download 3 | Type 3 | 9.8 | 288.0 | 18 | 5194.0 |
| Download 4 | Type 3 | 8.9 | 230.0 | 18 | 4140.0 |
| Download 5 | Type 3 | 7.9 | 432.0 | 17 | 7344.0 |
| Download 6 | Type 3 | 8.2 | 207.0 | 17 | 3519.0 |
| Download 7 | Type 3 | 7.5 | 443.0 | 17 | 7531.0 |
| Download 8 | Type 3 | 8.1 | 439.0 | 17 | 7463.0 |
| Download 9 | Type 3 | 6.2 | 223.0 | 16 | 3568.0 |
| Download 10 | Type 3 | 8.9 | 208.0 | 18 | 3744.0 |
| Download 11 | Type 3 | 9.6 | 463.0 | 18 | 8334.0 |
| Download 12 | Type 3 | 8.2 | 441.0 | 17 | 7497.0 |
| Download 13 | Type 3 | 7.2 | 323.0 | 16 | 5168.0 |
| Download 14 | Type 3 | 9.5 | 397.0 | 18 | 5346.0 |
| Download 15 | Type 3 | 8.0 | 412.0 | 17 | 7004.0 |
| Download 16 | Type 3 | 10.0 | 358.0 | 18 | 6036.0 |

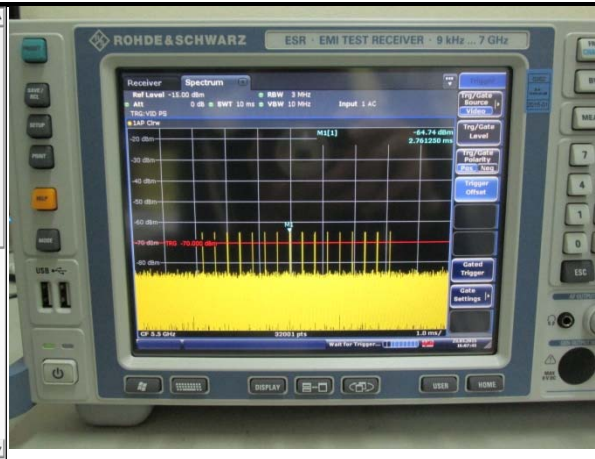

Radar 4

| Trial ID | Radar Type | Pulse Width (ns) | PRI (ns) | Number of Pulses | Waveform Length (ns) |
|-------------|------------|------------------|----------|------------------|----------------------|
| Download 0 | Type 4 | 16.0 | 355.0 | 14 | 4970.0 |
| Download 1 | Type 4 | 11.3 | 487.0 | 12 | 5844.0 |
| Download 2 | Type 4 | 13.5 | 344.0 | 13 | 4472.0 |
| Download 3 | Type 4 | 19.4 | 288.0 | 16 | 4608.0 |
| Download 4 | Type 4 | 17.5 | 230.0 | 15 | 3450.0 |
| Download 5 | Type 4 | 15.3 | 432.0 | 14 | 6048.0 |
| Download 6 | Type 4 | 15.9 | 207.0 | 14 | 2898.0 |
| Download 7 | Type 4 | 14.3 | 443.0 | 13 | 5759.0 |
| Download 8 | Type 4 | 15.8 | 439.0 | 14 | 6146.0 |
| Download 9 | Type 4 | 11.5 | 223.0 | 12 | 2676.0 |
| Download 10 | Type 4 | 17.4 | 208.0 | 15 | 3120.0 |
| Download 11 | Type 4 | 19.0 | 463.0 | 16 | 7408.0 |
| Download 12 | Type 4 | 16.0 | 441.0 | 14 | 6174.0 |
| Download 13 | Type 4 | 13.8 | 323.0 | 13 | 4199.0 |
| Download 14 | Type 4 | 18.9 | 297.0 | 16 | 4752.0 |
| Download 15 | Type 4 | 15.5 | 412.0 | 14 | 5708.0 |
| Download 16 | Type 4 | 10.0 | 358.0 | 14 | 5184.0 |

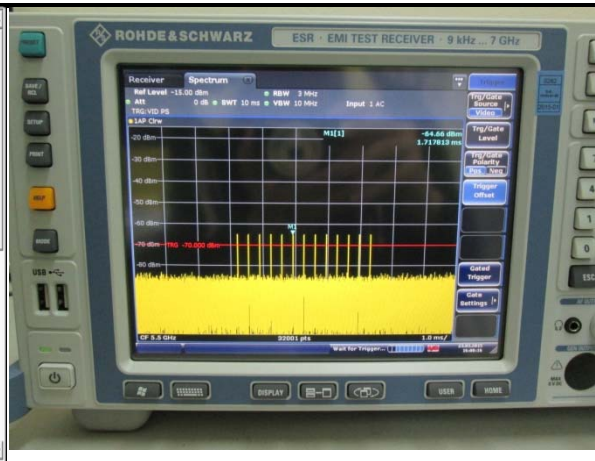

Radar 5

| Trial ID | Radar Type | Number of Bursts | Burst Period (s) | Waveform Length (s) | Center Frequency (GHz) | | | |
|------------|------------|------------------|------------------|---------------------|------------------------|--|--|--|
| Download 0 | Type 5 | 38 | 0.6666667 | 12.0000000 | 5.500000000 | | | |
| 0 | | 38 | 0.6666667 | 12.0000000 | 5.500000000 | | | |
| 1 | | 38 | 0.6666667 | 12.0000000 | 5.500000000 | | | |
| 2 | | 38 | 0.6666667 | 12.0000000 | 5.500000000 | | | |
| 3 | | 38 | 0.6666667 | 12.0000000 | 5.500000000 | | | |
| 4 | | 38 | 0.6666667 | 12.0000000 | 5.500000000 | | | |
| 5 | | 38 | 0.6666667 | 12.0000000 | 5.500000000 | | | |
| 6 | | 38 | 0.6666667 | 12.0000000 | 5.500000000 | | | |
| 7 | | 38 | 0.6666667 | 12.0000000 | 5.500000000 | | | |
| 8 | | 38 | 0.6666667 | 12.0000000 | 5.500000000 | | | |
| 9 | | 38 | 0.6666667 | 12.0000000 | 5.500000000 | | | |
| 10 | | 38 | 0.6666667 | 12.0000000 | 5.500000000 | | | |
| 11 | | 38 | 0.6666667 | 12.0000000 | 5.500000000 | | | |
| 12 | | 38 | 0.6666667 | 12.0000000 | 5.500000000 | | | |
| 13 | | 38 | 0.6666667 | 12.0000000 | 5.500000000 | | | |
| 14 | | 38 | 0.6666667 | 12.0000000 | 5.500000000 | | | |
| 15 | | 38 | 0.6666667 | 12.0000000 | 5.500000000 | | | |
| 16 | | 38 | 0.6666667 | 12.0000000 | 5.500000000 | | | |
| 17 | | 38 | 0.6666667 | 12.0000000 | 5.500000000 | | | |
| 18 | Type 5 | 38 | 0.6666667 | 12.0000000 | 5.500000000 | | | |
| 19 | Type 5 | 10 | 1.2000000 | 12.0000000 | 5.494200000 | | | |
| 20 | Type 5 | 11 | 0.9090909 | 11.0000000 | 5.494200000 | | | |

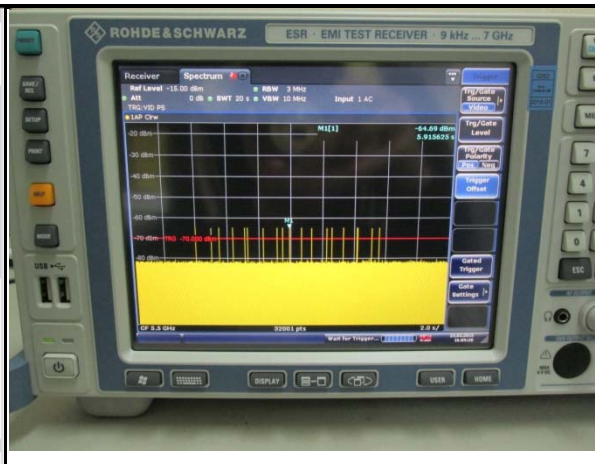

Radar 6

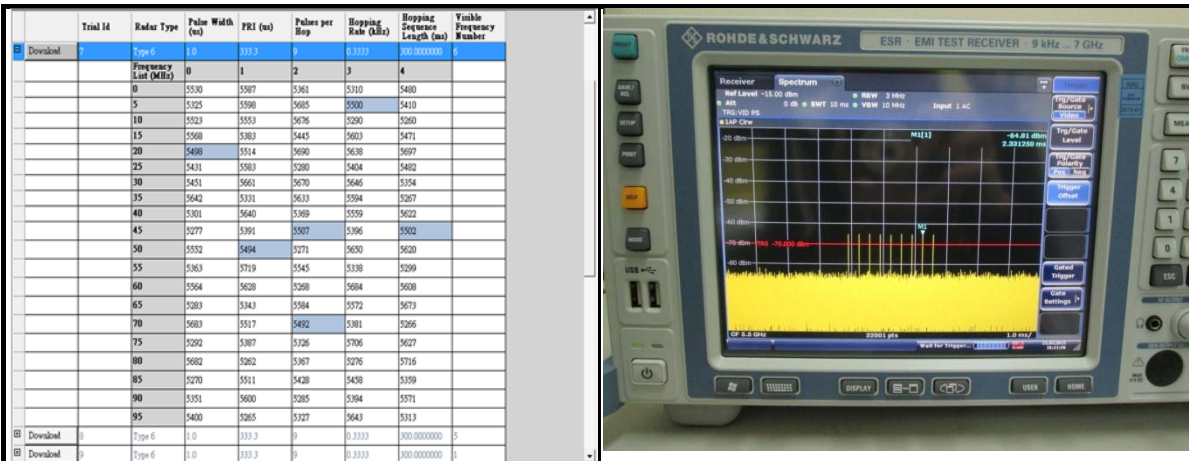

4) 5500MHz has been monitored in 30 minutes period. In this period, no any transmission occurs.

Plot of 30minutes period

802.11ax HE20

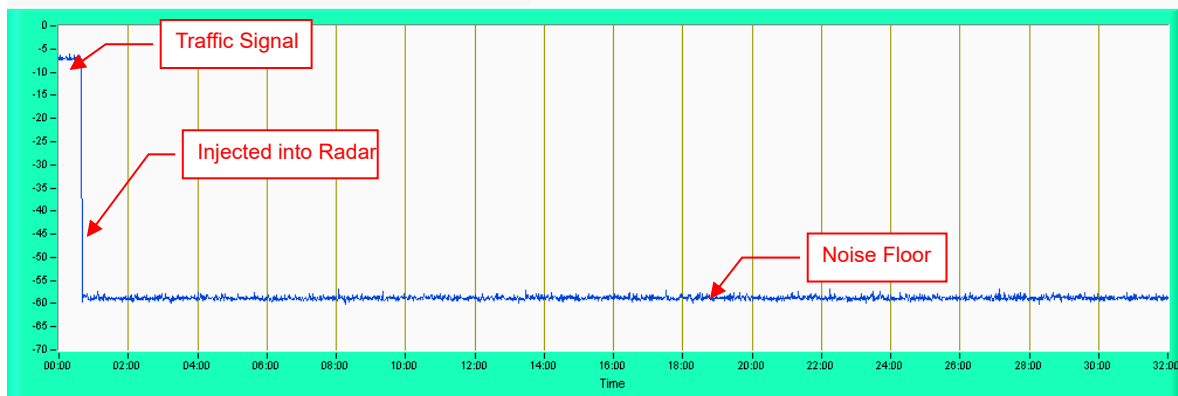

Note: Test setup are shown on Test setup photo.pdf

6.2.6 Uniform Spreading

The intention of the uniform spreading is to provide, on aggregate, a uniform loading of the spectrum. The EUT randomly select next output channel without any bias or fixed pattern, so that all channels in DFS bands (5250 to 5350MHz and 5470 to 5725 MHz) will be used equally.

7 Information of the Testing Laboratories

We, Bureau Veritas Consumer Products Services (H.K.) Ltd., Taoyuan Branch, were founded in 1988 to provide our best service in EMC, Radio, Telecom and Safety consultation. Our laboratories are FCC recognized accredited test firms and accredited and approved according to ISO/IEC 17025.

If you have any comments, please feel free to contact us at the following:

Lin Kou EMC/RF Lab

Tel: 886-2-26052180

Fax: 886-2-26051924

Hsin Chu EMC/RF/Telecom Lab

Tel: 886-3-6668565

Fax: 886-3-6668323

Hwa Ya EMC/RF/Safety Lab

Tel: 886-3-3183232

Fax: 886-3-3270892

Email: service.adt@tw.bureauveritas.com

Web Site: www.bureauveritas-adt.com

The address and road map of all our labs can be found in our web site also.

Appendix-A

RADAR TEST SIGNAL

A.1 The Long Pulse Radar Pattern

802.11ax (HE20)

Long Pulse Radar Test Signal
 Test Signal Name: LP_Signal_01
 Number of Bursts in Trial: 15
 Chrip Center Frequency 5500.0MHz

| Burst | Pulses per Burst | Chrip (MHz) | Pulse Width(us) | PRI-1 (us) | PRI-2 (us) | PRI-3 (us) |
|-------|------------------|-------------|-----------------|------------|------------|------------|
| 1 | 2 | 12 | 77.8 | 1665.0 | 1477.0 | - |
| 2 | 1 | 12 | 51.9 | 1074.0 | - | - |
| 3 | 1 | 12 | 63.8 | 1584.0 | - | - |
| 4 | 3 | 12 | 96.6 | 1682.0 | 1786.0 | 1843.0 |
| 5 | 3 | 12 | 85.9 | 1795.0 | 1215.0 | 1729.0 |
| 6 | 2 | 12 | 73.7 | 1198.0 | 1549.0 | - |
| 7 | 2 | 12 | 77.2 | 1837.0 | 1819.0 | - |
| 8 | 2 | 12 | 68.4 | 1587.0 | 1114.0 | - |
| 9 | 2 | 12 | 76.7 | 2000.0 | 1155.0 | - |
| 10 | 1 | 12 | 53.2 | 1147.0 | - | - |
| 11 | 3 | 12 | 85.7 | 1433.0 | 1695.0 | 1394.0 |
| 12 | 3 | 12 | 94.3 | 1670.0 | 1426.0 | 1935.0 |
| 13 | 2 | 12 | 77.6 | 1294.0 | 1671.0 | - |
| 14 | 1 | 12 | 65.7 | 1512.0 | - | - |
| 15 | 3 | 12 | 93.5 | 1444.0 | 1130.0 | 1468.0 |
| 16 | | | | | | |
| 17 | | | | | | |
| 18 | | | | | | |
| 19 | | | | | | |
| 20 | | | | | | |

Long Pulse Radar Test Signal

Test Signal Name: LP_Signal_02

Number of Bursts in Trial: 8

Chrip Center Frequency: 5500.0MHz

| Burst | Pulses per Burst | Chirp (MHz) | Pulse Width(us) | PRI-1 (us) | PRI-2 (us) | PRI-3 (us) |
|-------|------------------|-------------|-----------------|------------|------------|------------|
| 1 | 2 | 9 | 75.0 | 1880.0 | 1527.0 | - |
| 2 | 3 | 9 | 99.4 | 1401.0 | 1262.0 | 1257.0 |
| 3 | 2 | 9 | 67.4 | 1531.0 | 1403.0 | - |
| 4 | 2 | 9 | 73.6 | 1449.0 | 1041.0 | - |
| 5 | 1 | 9 | 65.9 | 1432.0 | - | - |
| 6 | 3 | 9 | 83.8 | 1356.0 | 1292.0 | 1419.0 |
| 7 | 1 | 9 | 65.5 | 1543.0 | - | - |
| 8 | 3 | 9 | 98.6 | 1548.0 | 1796.0 | 1728.0 |
| 9 | | | | | | |
| 10 | | | | | | |
| 11 | | | | | | |
| 12 | | | | | | |
| 13 | | | | | | |
| 14 | | | | | | |
| 15 | | | | | | |
| 16 | | | | | | |
| 17 | | | | | | |
| 18 | | | | | | |
| 19 | | | | | | |
| 20 | | | | | | |

Long Pulse Radar Test Signal

Test Signal Name: LP_Signal_03

Number of Bursts in Trial: 11

Chirp Center Frequency: 5500.0MHz

| Burst | Pulses per Burst | Chirp (MHz) | Pulse Width(us) | PRI-1 (us) | PRI-2 (us) | PRI-3 (us) |
|-------|------------------|-------------|-----------------|------------|------------|------------|
| 1 | 2 | 20 | 73.8 | 1806.0 | 1538.0 | - |
| 2 | 2 | 20 | 69.5 | 1117.0 | 1649.0 | - |
| 3 | 1 | 20 | 51.9 | 1651.0 | - | - |
| 4 | 3 | 20 | 84.6 | 1976.0 | 1032.0 | 1271.0 |
| 5 | 3 | 20 | 95.4 | 1060.0 | 1903.0 | 1388.0 |
| 6 | 2 | 20 | 68.0 | 1368.0 | 1351.0 | - |
| 7 | 3 | 20 | 89.6 | 1338.0 | 1514.0 | 1573.0 |
| 8 | 2 | 20 | 81.9 | 1022.0 | 1689.0 | - |
| 9 | 3 | 20 | 88.3 | 1810.0 | 1330.0 | 1838.0 |
| 10 | 1 | 20 | 53.7 | 1597.0 | - | - |
| 11 | 3 | 20 | 91.3 | 1961.0 | 1106.0 | 1001.0 |
| 12 | | | | | | |
| 13 | | | | | | |
| 14 | | | | | | |
| 15 | | | | | | |
| 16 | | | | | | |
| 17 | | | | | | |
| 18 | | | | | | |
| 19 | | | | | | |
| 20 | | | | | | |

Long Pulse Radar Test Signal

Test Signal Name: LP_Signal_04

Number of Bursts in Trial: 20

Chrip Center Frequency: 5500.0MHz

| Burst | Pulses per Burst | Chrip (MHz) | Pulse Width(us) | PRI-1 (us) | PRI-2 (us) | PRI-3 (us) |
|-------|------------------|-------------|-----------------|------------|------------|------------|
| 1 | 2 | 7 | 68.1 | 1339.0 | 1355.0 | - |
| 2 | 1 | 7 | 58.7 | 1251.0 | - | - |
| 3 | 2 | 7 | 75.3 | 1136.0 | 1640.0 | - |
| 4 | 1 | 7 | 56.4 | 1753.0 | - | - |
| 5 | 3 | 7 | 99.7 | 1196.0 | 1708.0 | 1159.0 |
| 6 | 1 | 7 | 57.7 | 1013.0 | - | - |
| 7 | 1 | 7 | 59.5 | 1072.0 | - | - |
| 8 | 2 | 7 | 80.0 | 1482.0 | 1369.0 | - |
| 9 | 2 | 7 | 82.0 | 1993.0 | 1197.0 | - |
| 10 | 2 | 7 | 82.8 | 1883.0 | 1005.0 | - |
| 11 | 3 | 7 | 88.0 | 1061.0 | 1928.0 | 1101.0 |
| 12 | 3 | 7 | 93.2 | 1207.0 | 1907.0 | 1223.0 |
| 13 | 2 | 7 | 70.4 | 1526.0 | 1360.0 | - |
| 14 | 3 | 7 | 95.3 | 1171.0 | 1955.0 | 1775.0 |
| 15 | 2 | 7 | 81.9 | 1690.0 | 1545.0 | - |
| 16 | 3 | 7 | 98.5 | 1975.0 | 1169.0 | 1062.0 |
| 17 | 1 | 7 | 65.0 | 1767.0 | - | - |
| 18 | 3 | 7 | 85.4 | 1011.0 | 1637.0 | 1425.0 |
| 19 | 3 | 7 | 91.6 | 1878.0 | 1445.0 | 1325.0 |
| 20 | 2 | 7 | 67.3 | 1091.0 | 1218.0 | - |

Long Pulse Radar Test Signal

Test Signal Name: LP_Signal_05

Number of Bursts in Trial: 17

Chrip Center Frequency: 5500.0MHz

| Burst | Pulses per Burst | Chrip (MHz) | Pulse Width(us) | PRI-1 (us) | PRI-2 (us) | PRI-3 (us) |
|-------|------------------|-------------|-----------------|------------|------------|------------|
| 1 | 2 | 7 | 67.9 | 1320.0 | 1133.0 | - |
| 2 | 1 | 7 | 62.3 | 1957.0 | - | - |
| 3 | 1 | 7 | 53.3 | 1592.0 | - | - |
| 4 | 3 | 7 | 90.0 | 1900.0 | 1153.0 | 1346.0 |
| 5 | 2 | 7 | 77.1 | 1166.0 | 1646.0 | - |
| 6 | 3 | 7 | 83.9 | 1278.0 | 1232.0 | 1459.0 |
| 7 | 3 | 7 | 89.1 | 1240.0 | 1384.0 | 1939.0 |
| 8 | 2 | 7 | 81.8 | 1833.0 | 1676.0 | - |
| 9 | 1 | 7 | 50.3 | 1075.0 | - | - |
| 10 | 3 | 7 | 87.1 | 1116.0 | 1996.0 | 1756.0 |
| 11 | 2 | 7 | 71.3 | 1225.0 | 1815.0 | - |
| 12 | 3 | 7 | 97.5 | 1884.0 | 1465.0 | 1132.0 |
| 13 | 3 | 7 | 90.6 | 1561.0 | 1040.0 | 1354.0 |
| 14 | 3 | 7 | 86.3 | 1596.0 | 1183.0 | 1792.0 |
| 15 | 3 | 7 | 97.6 | 1365.0 | 1073.0 | 1361.0 |
| 16 | 3 | 7 | 84.7 | 1021.0 | 1718.0 | 1854.0 |
| 17 | 3 | 7 | 99.7 | 1150.0 | 1244.0 | 1988.0 |
| 18 | | | | | | |
| 19 | | | | | | |
| 20 | | | | | | |

Long Pulse Radar Test Signal

Test Signal Name: LP_Signal_06

Number of Bursts in Trial: 14

Chrip Center Frequency: 5500.0MHz

| Burst | Pulses per Burst | Chrip (MHz) | Pulse Width(us) | PRI-1 (us) | PRI-2 (us) | PRI-3 (us) |
|-------|------------------|-------------|-----------------|------------|------------|------------|
| 1 | 3 | 19 | 92.9 | 1085.0 | 1564.0 | 1407.0 |
| 2 | 2 | 19 | 67.7 | 1744.0 | 1747.0 | - |
| 3 | 1 | 19 | 65.8 | 1092.0 | - | - |
| 4 | 1 | 19 | 56.3 | 1851.0 | - | - |
| 5 | 1 | 19 | 53.7 | 1727.0 | - | - |
| 6 | 3 | 19 | 83.5 | 1679.0 | 1930.0 | 1025.0 |
| 7 | 1 | 19 | 65.8 | 1519.0 | - | - |
| 8 | 3 | 19 | 85.9 | 1134.0 | 1034.0 | 1808.0 |
| 9 | 2 | 19 | 76.3 | 1606.0 | 1926.0 | - |
| 10 | 2 | 19 | 81.5 | 1891.0 | 1714.0 | - |
| 11 | 3 | 19 | 89.4 | 1310.0 | 1594.0 | 1827.0 |
| 12 | 1 | 19 | 63.4 | 1568.0 | - | - |
| 13 | 2 | 19 | 69.6 | 1307.0 | 1925.0 | - |
| 14 | 2 | 19 | 74.5 | 1264.0 | 1846.0 | - |
| 15 | | | | | | |
| 16 | | | | | | |
| 17 | | | | | | |
| 18 | | | | | | |
| 19 | | | | | | |
| 20 | | | | | | |

Long Pulse Radar Test Signal

Test Signal Name: LP_Signal_07

Number of Bursts in Trial: 15

Chrip Center Frequency: 5500.0MHz

| Burst | Pulses per Burst | Chirp (MHz) | Pulse Width(us) | PRI-1 (us) | PRI-2 (us) | PRI-3 (us) |
|-------|------------------|-------------|-----------------|------------|------------|------------|
| 1 | 3 | 15 | 96.6 | 1182.0 | 1609.0 | 1581.0 |
| 2 | 3 | 15 | 96.7 | 1829.0 | 1799.0 | 1154.0 |
| 3 | 3 | 15 | 86.5 | 1923.0 | 1396.0 | 1865.0 |
| 4 | 2 | 15 | 73.3 | 1908.0 | 1318.0 | - |
| 5 | 1 | 15 | 55.8 | 1688.0 | - | - |
| 6 | 1 | 15 | 55.4 | 1145.0 | - | - |
| 7 | 3 | 15 | 85.3 | 1336.0 | 1504.0 | 1820.0 |
| 8 | 2 | 15 | 79.4 | 1344.0 | 1893.0 | - |
| 9 | 1 | 15 | 65.7 | 1476.0 | - | - |
| 10 | 2 | 15 | 68.6 | 1008.0 | 1028.0 | - |
| 11 | 2 | 15 | 77.7 | 1972.0 | 1835.0 | - |
| 12 | 2 | 15 | 79.6 | 1882.0 | 1331.0 | - |
| 13 | 3 | 15 | 94.9 | 1830.0 | 1070.0 | 1349.0 |
| 14 | 1 | 15 | 61.4 | 1451.0 | - | - |
| 15 | 3 | 15 | 90.6 | 1233.0 | 1562.0 | 1887.0 |
| 16 | | | | | | |
| 17 | | | | | | |
| 18 | | | | | | |
| 19 | | | | | | |
| 20 | | | | | | |

Long Pulse Radar Test Signal

Test Signal Name: LP_Signal_08

Number of Bursts in Trial: 12

Chrip Center Frequency: 5500.0MHz

| Burst | Pulses per Burst | Chrip (MHz) | Pulse Width(us) | PRI-1 (us) | PRI-2 (us) | PRI-3 (us) |
|-------|------------------|-------------|-----------------|------------|------------|------------|
| 1 | 1 | 19 | 52.6 | 1210.0 | - | - |
| 2 | 3 | 19 | 84.1 | 1314.0 | 1725.0 | 1529.0 |
| 3 | 3 | 19 | 97.7 | 1139.0 | 1868.0 | 1805.0 |
| 4 | 3 | 19 | 97.3 | 1341.0 | 1446.0 | 1755.0 |
| 5 | 3 | 19 | 98.8 | 1544.0 | 1386.0 | 1302.0 |
| 6 | 2 | 19 | 72.2 | 1771.0 | 1184.0 | - |
| 7 | 2 | 19 | 67.6 | 1175.0 | 1027.0 | - |
| 8 | 2 | 19 | 75.7 | 1026.0 | 1871.0 | - |
| 9 | 1 | 19 | 60.9 | 1798.0 | - | - |
| 10 | 1 | 19 | 64.2 | 1138.0 | - | - |
| 11 | 2 | 19 | 78.8 | 1784.0 | 1604.0 | - |
| 12 | 3 | 19 | 87.5 | 1511.0 | 1712.0 | 1683.0 |
| 13 | | | | | | |
| 14 | | | | | | |
| 15 | | | | | | |
| 16 | | | | | | |
| 17 | | | | | | |
| 18 | | | | | | |
| 19 | | | | | | |
| 20 | | | | | | |

Long Pulse Radar Test Signal

Test Signal Name: LP_Signal_09

Number of Bursts in Trial: 14

Chrip Center Frequency: 5500.0MHz

| Burst | Pulses per Burst | Chrip (MHz) | Pulse Width(us) | PRI-1 (us) | PRI-2 (us) | PRI-3 (us) |
|-------|------------------|-------------|-----------------|------------|------------|------------|
| 1 | 1 | 7 | 54.1 | 1415.0 | - | - |
| 2 | 1 | 7 | 50.7 | 1221.0 | - | - |
| 3 | 1 | 7 | 52.3 | 1974.0 | - | - |
| 4 | 3 | 7 | 99.8 | 1558.0 | 1696.0 | 1949.0 |
| 5 | 2 | 7 | 68.4 | 1014.0 | 1099.0 | - |
| 6 | 2 | 7 | 80.8 | 1736.0 | 1505.0 | - |
| 7 | 1 | 7 | 62.5 | 1778.0 | - | - |
| 8 | 2 | 7 | 74.8 | 1149.0 | 1204.0 | - |
| 9 | 1 | 7 | 50.8 | 1049.0 | - | - |
| 10 | 1 | 7 | 54.0 | 1417.0 | - | - |
| 11 | 1 | 7 | 63.0 | 1730.0 | - | - |
| 12 | 3 | 7 | 91.8 | 1143.0 | 1270.0 | 1347.0 |
| 13 | 2 | 7 | 79.3 | 1274.0 | 1992.0 | - |
| 14 | 1 | 7 | 64.3 | 1937.0 | - | - |
| 15 | | | | | | |
| 16 | | | | | | |
| 17 | | | | | | |
| 18 | | | | | | |
| 19 | | | | | | |
| 20 | | | | | | |

Long Pulse Radar Test Signal

Test Signal Name: LP_Signal_10

Number of Bursts in Trial: 8

Chrip Center Frequency: 5500.0MHz

| Burst | Pulses per Burst | Chrip (MHz) | Pulse Width(us) | PRI-1 (us) | PRI-2 (us) | PRI-3 (us) |
|-------|------------------|-------------|-----------------|------------|------------|------------|
| 1 | 1 | 12 | 63.4 | 1043.0 | - | - |
| 2 | 1 | 12 | 52.0 | 1863.0 | - | - |
| 3 | 3 | 12 | 97.2 | 1973.0 | 1605.0 | 1583.0 |
| 4 | 2 | 12 | 78.7 | 1466.0 | 1743.0 | - |
| 5 | 2 | 12 | 74.2 | 1280.0 | 1219.0 | - |
| 6 | 3 | 12 | 88.7 | 1293.0 | 1934.0 | 1273.0 |
| 7 | 1 | 12 | 54.3 | 1991.0 | - | - |
| 8 | 3 | 12 | 95.4 | 1580.0 | 1555.0 | 1791.0 |
| 9 | | | | | | |
| 10 | | | | | | |
| 11 | | | | | | |
| 12 | | | | | | |
| 13 | | | | | | |
| 14 | | | | | | |
| 15 | | | | | | |
| 16 | | | | | | |
| 17 | | | | | | |
| 18 | | | | | | |
| 19 | | | | | | |
| 20 | | | | | | |

Long Pulse Radar Test Signal

Test Signal Name: LP_Signal_11

Number of Bursts in Trial: 17

Chrip Center Frequency: 5496.93 MHz

| Burst | Pulses per Burst | Chrip (MHz) | Pulse Width(us) | PRI-1 (us) | PRI-2 (us) | PRI-3 (us) |
|-------|------------------|-------------|-----------------|------------|------------|------------|
| 1 | 2 | 16 | 73.7 | 1208.0 | 1497.0 | - |
| 2 | 3 | 16 | 97.4 | 1942.0 | 1754.0 | 1613.0 |
| 3 | 3 | 16 | 91.7 | 1999.0 | 1702.0 | 1462.0 |
| 4 | 1 | 16 | 66.2 | 1393.0 | - | - |
| 5 | 2 | 16 | 70.8 | 1968.0 | 1821.0 | - |
| 6 | 1 | 16 | 52.3 | 1740.0 | - | - |
| 7 | 2 | 16 | 78.9 | 1308.0 | 1984.0 | - |
| 8 | 2 | 16 | 70.9 | 1050.0 | 1358.0 | - |
| 9 | 2 | 16 | 75.6 | 1437.0 | 1430.0 | - |
| 10 | 1 | 16 | 59.1 | 1697.0 | - | - |
| 11 | 2 | 16 | 77.0 | 1397.0 | 1304.0 | - |
| 12 | 2 | 16 | 67.9 | 1803.0 | 1083.0 | - |
| 13 | 2 | 16 | 81.2 | 1720.0 | 1932.0 | - |
| 14 | 2 | 16 | 78.7 | 1247.0 | 1121.0 | - |
| 15 | 1 | 16 | 63.3 | 1634.0 | - | - |
| 16 | 2 | 16 | 68.9 | 1849.0 | 1423.0 | - |
| 17 | 1 | 16 | 59.3 | 1093.0 | - | - |
| 18 | | | | | | |
| 19 | | | | | | |
| 20 | | | | | | |

Long Pulse Radar Test Signal

Test Signal Name: LP_Signal_12

Number of Bursts in Trial: 19

Chirp Center Frequency: 5498.13 MHz

| Burst | Pulses per Burst | Chirp (MHz) | Pulse Width(us) | PRI-1 (us) | PRI-2 (us) | PRI-3 (us) |
|-------|------------------|-------------|-----------------|------------|------------|------------|
| 1 | 3 | 19 | 98.9 | 1381.0 | 1680.0 | 1488.0 |
| 2 | 2 | 19 | 82.3 | 1716.0 | 1855.0 | - |
| 3 | 3 | 19 | 86.7 | 1211.0 | 1400.0 | 1919.0 |
| 4 | 3 | 19 | 89.7 | 1861.0 | 1068.0 | 1282.0 |
| 5 | 3 | 19 | 98.6 | 1507.0 | 1194.0 | 1461.0 |
| 6 | 2 | 19 | 71.1 | 1921.0 | 1789.0 | - |
| 7 | 1 | 19 | 55.9 | 1947.0 | - | - |
| 8 | 2 | 19 | 67.9 | 1350.0 | 1372.0 | - |
| 9 | 3 | 19 | 84.4 | 1203.0 | 1107.0 | 1443.0 |
| 10 | 1 | 19 | 58.8 | 1715.0 | - | - |
| 11 | 1 | 19 | 65.6 | 1017.0 | - | - |
| 12 | 2 | 19 | 78.5 | 1911.0 | 1704.0 | - |
| 13 | 2 | 19 | 82.3 | 1845.0 | 1686.0 | - |
| 14 | 3 | 19 | 90.1 | 1938.0 | 1071.0 | 1266.0 |
| 15 | 3 | 19 | 90.2 | 1989.0 | 1089.0 | 1950.0 |
| 16 | 2 | 19 | 83.1 | 1943.0 | 1406.0 | - |
| 17 | 1 | 19 | 58.8 | 1742.0 | - | - |
| 18 | 2 | 19 | 77.0 | 1187.0 | 1657.0 | - |
| 19 | 1 | 19 | 55.0 | 1012.0 | - | - |
| 20 | | | | | | |

Long Pulse Radar Test Signal

Test Signal Name: LP_Signal_13

Number of Bursts in Trial: 15

Chrip Center Frequency: 5495.73 MHz

| Burst | Pulses per Burst | Chrip (MHz) | Pulse Width(us) | PRI-1 (us) | PRI-2 (us) | PRI-3 (us) |
|-------|------------------|-------------|-----------------|------------|------------|------------|
| 1 | 1 | 13 | 58.1 | 1929.0 | - | - |
| 2 | 1 | 13 | 52.1 | 1910.0 | - | - |
| 3 | 1 | 13 | 59.9 | 1971.0 | - | - |
| 4 | 1 | 13 | 60.2 | 1812.0 | - | - |
| 5 | 3 | 13 | 95.9 | 1399.0 | 1906.0 | 1608.0 |
| 6 | 2 | 13 | 79.9 | 1626.0 | 1859.0 | - |
| 7 | 2 | 13 | 78.5 | 1238.0 | 1917.0 | - |
| 8 | 1 | 13 | 53.8 | 1763.0 | - | - |
| 9 | 1 | 13 | 64.7 | 1800.0 | - | - |
| 10 | 1 | 13 | 61.4 | 1390.0 | - | - |
| 11 | 2 | 13 | 83.2 | 1692.0 | 1858.0 | - |
| 12 | 3 | 13 | 84.7 | 1533.0 | 1677.0 | 1638.0 |
| 13 | 3 | 13 | 88.7 | 1703.0 | 1528.0 | 1058.0 |
| 14 | 2 | 13 | 78.3 | 1258.0 | 1951.0 | - |
| 15 | 2 | 13 | 69.3 | 1731.0 | 1717.0 | - |
| 16 | | | | | | |
| 17 | | | | | | |
| 18 | | | | | | |
| 19 | | | | | | |
| 20 | | | | | | |

Long Pulse Radar Test Signal

Test Signal Name: LP_Signal_14

Number of Bursts in Trial: 12

Chrip Center Frequency: 5494.53 MHz

| Burst | Pulses per Burst | Chrip (MHz) | Pulse Width(us) | PRI-1 (us) | PRI-2 (us) | PRI-3 (us) |
|-------|------------------|-------------|-----------------|------------|------------|------------|
| 1 | 2 | 10 | 75.3 | 1994.0 | 1612.0 | - |
| 2 | 1 | 10 | 56.3 | 1456.0 | - | - |
| 3 | 2 | 10 | 67.7 | 1617.0 | 1185.0 | - |
| 4 | 1 | 10 | 55.6 | 1337.0 | - | - |
| 5 | 2 | 10 | 75.2 | 1421.0 | 1267.0 | - |
| 6 | 2 | 10 | 76.3 | 1359.0 | 1305.0 | - |
| 7 | 3 | 10 | 85.7 | 1547.0 | 1362.0 | 1924.0 |
| 8 | 3 | 10 | 98.4 | 1873.0 | 1550.0 | 1249.0 |
| 9 | 3 | 10 | 86.4 | 1779.0 | 1439.0 | 1046.0 |
| 10 | 3 | 10 | 93.6 | 1059.0 | 1031.0 | 1452.0 |
| 11 | 1 | 10 | 63.3 | 1328.0 | - | - |
| 12 | 3 | 10 | 92.4 | 1412.0 | 1673.0 | 1322.0 |
| 13 | | | | | | |
| 14 | | | | | | |
| 15 | | | | | | |
| 16 | | | | | | |
| 17 | | | | | | |
| 18 | | | | | | |
| 19 | | | | | | |
| 20 | | | | | | |

Long Pulse Radar Test Signal

Test Signal Name: LP_Signal_15

Number of Bursts in Trial: 19

Chrip Center Frequency: 5497.73 MHz

| Burst | Pulses per Burst | Chrip (MHz) | Pulse Width(us) | PRI-1 (us) | PRI-2 (us) | PRI-3 (us) |
|-------|------------------|-------------|-----------------|------------|------------|------------|
| 1 | 3 | 18 | 93.3 | 1983.0 | 1912.0 | 1535.0 |
| 2 | 2 | 18 | 69.1 | 1102.0 | 1794.0 | - |
| 3 | 3 | 18 | 86.9 | 1044.0 | 1152.0 | 1148.0 |
| 4 | 3 | 18 | 84.9 | 1894.0 | 1948.0 | 1118.0 |
| 5 | 2 | 18 | 72.3 | 1094.0 | 1916.0 | - |
| 6 | 1 | 18 | 51.7 | 1447.0 | - | - |
| 7 | 1 | 18 | 58.3 | 1429.0 | - | - |
| 8 | 1 | 18 | 60.8 | 1979.0 | - | - |
| 9 | 1 | 18 | 57.1 | 1641.0 | - | - |
| 10 | 3 | 18 | 88.9 | 1886.0 | 1964.0 | 1489.0 |
| 11 | 2 | 18 | 72.0 | 1909.0 | 1297.0 | - |
| 12 | 3 | 18 | 90.9 | 1261.0 | 1566.0 | 1370.0 |
| 13 | 1 | 18 | 59.8 | 1552.0 | - | - |
| 14 | 2 | 18 | 70.0 | 1759.0 | 1291.0 | - |
| 15 | 2 | 18 | 67.2 | 1625.0 | 1881.0 | - |
| 16 | 3 | 18 | 91.2 | 1382.0 | 1832.0 | 1661.0 |
| 17 | 1 | 18 | 56.5 | 1483.0 | - | - |
| 18 | 1 | 18 | 51.2 | 1237.0 | - | - |
| 19 | 2 | 18 | 74.1 | 1471.0 | 1245.0 | - |
| 20 | | | | | | |

Long Pulse Radar Test Signal

Test Signal Name: LP_Signal_16

Number of Bursts in Trial: 14

Chrip Center Frequency: 5495.33MHz

| Burst | Pulses per Burst | Chirp (MHz) | Pulse Width(us) | PRI-1 (us) | PRI-2 (us) | PRI-3 (us) |
|-------|------------------|-------------|-----------------|------------|------------|------------|
| 1 | 2 | 12 | 76.9 | 1110.0 | 1140.0 | - |
| 2 | 1 | 12 | 50.2 | 1316.0 | - | - |
| 3 | 1 | 12 | 62.9 | 1520.0 | - | - |
| 4 | 1 | 12 | 64.7 | 1902.0 | - | - |
| 5 | 3 | 12 | 83.8 | 1410.0 | 1097.0 | 1621.0 |
| 6 | 1 | 12 | 65.4 | 1944.0 | - | - |
| 7 | 1 | 12 | 53.2 | 1024.0 | - | - |
| 8 | 1 | 12 | 51.7 | 1603.0 | - | - |
| 9 | 2 | 12 | 78.7 | 1804.0 | 1168.0 | - |
| 10 | 2 | 12 | 72.4 | 1030.0 | 1343.0 | - |
| 11 | 1 | 12 | 53.8 | 1327.0 | - | - |
| 12 | 2 | 12 | 73.6 | 1524.0 | 1553.0 | - |
| 13 | 2 | 12 | 66.7 | 1722.0 | 1122.0 | - |
| 14 | 2 | 12 | 82.5 | 1404.0 | 1019.0 | - |
| 15 | | | | | | |
| 16 | | | | | | |
| 17 | | | | | | |
| 18 | | | | | | |
| 19 | | | | | | |
| 20 | | | | | | |

Long Pulse Radar Test Signal

Test Signal Name: LP_Signal_17

Number of Bursts in Trial: 20

Chrip Center Frequency: 5498.53 MHz

| Burst | Pulses per Burst | Chrip (MHz) | Pulse Width(us) | PRI-1 (us) | PRI-2 (us) | PRI-3 (us) |
|-------|------------------|-------------|-----------------|------------|------------|------------|
| 1 | 3 | 20 | 87.6 | 1565.0 | 1055.0 | 1840.0 |
| 2 | 3 | 20 | 85.2 | 1735.0 | 1541.0 | 1408.0 |
| 3 | 3 | 20 | 84.8 | 1534.0 | 1889.0 | 1463.0 |
| 4 | 2 | 20 | 77.9 | 1749.0 | 1460.0 | - |
| 5 | 2 | 20 | 76.5 | 1518.0 | 1485.0 | - |
| 6 | 1 | 20 | 60.9 | 1540.0 | - | - |
| 7 | 2 | 20 | 83.0 | 1080.0 | 1010.0 | - |
| 8 | 2 | 20 | 80.4 | 1824.0 | 1752.0 | - |
| 9 | 2 | 20 | 67.5 | 1764.0 | 1181.0 | - |
| 10 | 1 | 20 | 62.1 | 1495.0 | - | - |
| 11 | 3 | 20 | 86.4 | 1773.0 | 1966.0 | 1263.0 |
| 12 | 3 | 20 | 84.3 | 1593.0 | 1188.0 | 1788.0 |
| 13 | 2 | 20 | 76.9 | 1226.0 | 1537.0 | - |
| 14 | 3 | 20 | 95.8 | 1192.0 | 1298.0 | 1844.0 |
| 15 | 1 | 20 | 55.2 | 1644.0 | - | - |
| 16 | 1 | 20 | 59.0 | 1402.0 | - | - |
| 17 | 3 | 20 | 94.5 | 1296.0 | 1700.0 | 1283.0 |
| 18 | 3 | 20 | 91.9 | 1970.0 | 1978.0 | 1165.0 |
| 19 | 3 | 20 | 85.2 | 1732.0 | 1551.0 | 1189.0 |
| 20 | 2 | 20 | 69.5 | 1038.0 | 1224.0 | - |

Long Pulse Radar Test Signal

Test Signal Name: LP_Signal_18

Number of Bursts in Trial: 12

Chrip Center Frequency: 5494.53 MHz

| Burst | Pulses per Burst | Chrip (MHz) | Pulse Width(us) | PRI-1 (us) | PRI-2 (us) | PRI-3 (us) |
|-------|------------------|-------------|-----------------|------------|------------|------------|
| 1 | 3 | 10 | 86.4 | 1259.0 | 1918.0 | 1455.0 |
| 2 | 3 | 10 | 92.2 | 1598.0 | 1719.0 | 1895.0 |
| 3 | 2 | 10 | 80.4 | 1816.0 | 1899.0 | - |
| 4 | 1 | 10 | 54.3 | 1335.0 | - | - |
| 5 | 1 | 10 | 53.1 | 1303.0 | - | - |
| 6 | 2 | 10 | 69.4 | 1503.0 | 1546.0 | - |
| 7 | 2 | 10 | 69.1 | 1279.0 | 1639.0 | - |
| 8 | 3 | 10 | 100.0 | 1375.0 | 1438.0 | 1595.0 |
| 9 | 2 | 10 | 79.6 | 1239.0 | 1705.0 | - |
| 10 | 3 | 10 | 88.4 | 1374.0 | 1579.0 | 1623.0 |
| 11 | 1 | 10 | 53.3 | 1016.0 | - | - |
| 12 | 1 | 10 | 65.3 | 1709.0 | - | - |
| 13 | | | | | | |
| 14 | | | | | | |
| 15 | | | | | | |
| 16 | | | | | | |
| 17 | | | | | | |
| 18 | | | | | | |
| 19 | | | | | | |
| 20 | | | | | | |

Long Pulse Radar Test Signal

Test Signal Name: LP_Signal_19

Number of Bursts in Trial: 14

Chrip Center Frequency: 5495.33 MHz

| Burst | Pulses per Burst | Chrip (MHz) | Pulse Width(us) | PRI-1 (us) | PRI-2 (us) | PRI-3 (us) |
|-------|------------------|-------------|-----------------|------------|------------|------------|
| 1 | 1 | 12 | 55.3 | 1920.0 | - | - |
| 2 | 1 | 12 | 58.3 | 1797.0 | - | - |
| 3 | 2 | 12 | 72.3 | 1610.0 | 1039.0 | - |
| 4 | 3 | 12 | 84.8 | 1131.0 | 1761.0 | 1721.0 |
| 5 | 2 | 12 | 82.5 | 1875.0 | 1431.0 | - |
| 6 | 1 | 12 | 63.3 | 1095.0 | - | - |
| 7 | 2 | 12 | 80.0 | 1119.0 | 1913.0 | - |
| 8 | 3 | 12 | 90.3 | 1660.0 | 1853.0 | 1123.0 |
| 9 | 3 | 12 | 91.1 | 1539.0 | 1783.0 | 1172.0 |
| 10 | 3 | 12 | 96.6 | 1525.0 | 1036.0 | 1385.0 |
| 11 | 2 | 12 | 82.7 | 1710.0 | 1990.0 | - |
| 12 | 1 | 12 | 50.7 | 1234.0 | - | - |
| 13 | 2 | 12 | 78.4 | 1047.0 | 1109.0 | - |
| 14 | 3 | 12 | 99.5 | 1299.0 | 1965.0 | 1869.0 |
| 15 | | | | | | |
| 16 | | | | | | |
| 17 | | | | | | |
| 18 | | | | | | |
| 19 | | | | | | |
| 20 | | | | | | |

Long Pulse Radar Test Signal

Test Signal Name: LP_Signal_20

Number of Bursts in Trial: 12

Chirp Center Frequency: 5494.53 MHz

| Burst | Pulses per Burst | Chirp (MHz) | Pulse Width(us) | PRI-1 (us) | PRI-2 (us) | PRI-3 (us) |
|-------|------------------|-------------|-----------------|------------|------------|------------|
| 1 | 3 | 10 | 88.6 | 1501.0 | 1067.0 | 1927.0 |
| 2 | 1 | 10 | 57.4 | 1723.0 | - | - |
| 3 | 3 | 10 | 96.6 | 1086.0 | 1658.0 | 1324.0 |
| 4 | 2 | 10 | 69.7 | 1751.0 | 1945.0 | - |
| 5 | 2 | 10 | 77.9 | 1642.0 | 1317.0 | - |
| 6 | 1 | 10 | 62.0 | 1866.0 | - | - |
| 7 | 3 | 10 | 88.4 | 1997.0 | 1077.0 | 1366.0 |
| 8 | 3 | 10 | 97.3 | 1790.0 | 1896.0 | 1367.0 |
| 9 | 3 | 10 | 96.2 | 1391.0 | 1787.0 | 1672.0 |
| 10 | 3 | 10 | 95.4 | 1020.0 | 1892.0 | 1414.0 |
| 11 | 1 | 10 | 54.8 | 1084.0 | - | - |
| 12 | 2 | 10 | 80.4 | 1850.0 | 1436.0 | - |
| 13 | | | | | | |
| 14 | | | | | | |
| 15 | | | | | | |
| 16 | | | | | | |
| 17 | | | | | | |
| 18 | | | | | | |
| 19 | | | | | | |
| 20 | | | | | | |

Long Pulse Radar Test Signal

Test Signal Name: LP_Signal_21

Number of Bursts in Trial: 16

Chirp Center Frequency: 5503.47 MHz

| Burst | Pulses per Burst | Chirp (MHz) | Pulse Width(us) | PRI-1 (us) | PRI-2 (us) | PRI-3 (us) |
|-------|------------------|-------------|-----------------|------------|------------|------------|
| 1 | 2 | 15 | 74.7 | 1619.0 | 1611.0 | - |
| 2 | 1 | 15 | 57.1 | 1560.0 | - | - |
| 3 | 3 | 15 | 91.9 | 1392.0 | 1475.0 | 1276.0 |
| 4 | 2 | 15 | 83.1 | 1809.0 | 1772.0 | - |
| 5 | 1 | 15 | 50.7 | 1003.0 | - | - |
| 6 | 2 | 15 | 79.2 | 1574.0 | 1600.0 | - |
| 7 | 1 | 15 | 58.7 | 1186.0 | - | - |
| 8 | 2 | 15 | 71.0 | 1521.0 | 1567.0 | - |
| 9 | 2 | 15 | 79.0 | 1777.0 | 1960.0 | - |
| 10 | 2 | 15 | 68.5 | 1284.0 | 1428.0 | - |
| 11 | 2 | 15 | 73.5 | 1904.0 | 1352.0 | - |
| 12 | 2 | 15 | 70.5 | 1864.0 | 1115.0 | - |
| 13 | 2 | 15 | 76.6 | 1045.0 | 1300.0 | - |
| 14 | 2 | 15 | 81.2 | 1160.0 | 1675.0 | - |
| 15 | 1 | 15 | 61.8 | 1277.0 | - | - |
| 16 | 3 | 15 | 94.9 | 1450.0 | 1206.0 | 1860.0 |
| 17 | | | | | | |
| 18 | | | | | | |
| 19 | | | | | | |
| 20 | | | | | | |

Long Pulse Radar Test Signal

Test Signal Name: LP_Signal_22

Number of Bursts in Trial: 12

Chirp Center Frequency: 5505.87 MHz

| Burst | Pulses per Burst | Chirp (MHz) | Pulse Width(us) | PRI-1 (us) | PRI-2 (us) | PRI-3 (us) |
|-------|------------------|-------------|-----------------|------------|------------|------------|
| 1 | 2 | 9 | 78.5 | 1653.0 | 1698.0 | - |
| 2 | 3 | 9 | 89.8 | 1174.0 | 1962.0 | 1167.0 |
| 3 | 1 | 9 | 59.4 | 1982.0 | - | - |
| 4 | 2 | 9 | 79.6 | 1633.0 | 1890.0 | - |
| 5 | 2 | 9 | 76.0 | 1112.0 | 1811.0 | - |
| 6 | 1 | 9 | 53.6 | 1144.0 | - | - |
| 7 | 2 | 9 | 80.9 | 1220.0 | 1053.0 | - |
| 8 | 1 | 9 | 61.6 | 1724.0 | - | - |
| 9 | 1 | 9 | 53.4 | 1901.0 | - | - |
| 10 | 1 | 9 | 59.9 | 1379.0 | - | - |
| 11 | 1 | 9 | 60.4 | 1453.0 | - | - |
| 12 | 3 | 9 | 91.4 | 1768.0 | 1726.0 | 1227.0 |
| 13 | | | | | | |
| 14 | | | | | | |
| 15 | | | | | | |
| 16 | | | | | | |
| 17 | | | | | | |
| 18 | | | | | | |
| 19 | | | | | | |
| 20 | | | | | | |

Long Pulse Radar Test Signal

Test Signal Name: LP_Signal_23

Number of Bursts in Trial: 20

Chrip Center Frequency: 5501.47 MHz

| Burst | Pulses per Burst | Chirp (MHz) | Pulse Width(us) | PRI-1 (us) | PRI-2 (us) | PRI-3 (us) |
|-------|------------------|-------------|-----------------|------------|------------|------------|
| 1 | 2 | 20 | 77.0 | 1191.0 | 1363.0 | - |
| 2 | 1 | 20 | 58.1 | 1248.0 | - | - |
| 3 | 1 | 20 | 62.1 | 1836.0 | - | - |
| 4 | 2 | 20 | 76.9 | 1334.0 | 1236.0 | - |
| 5 | 2 | 20 | 80.0 | 1914.0 | 1852.0 | - |
| 6 | 1 | 20 | 52.0 | 1701.0 | - | - |
| 7 | 3 | 20 | 88.6 | 1693.0 | 1995.0 | 1905.0 |
| 8 | 2 | 20 | 72.9 | 1922.0 | 1387.0 | - |
| 9 | 3 | 20 | 98.5 | 1839.0 | 1746.0 | 1389.0 |
| 10 | 1 | 20 | 57.9 | 1193.0 | - | - |
| 11 | 3 | 20 | 95.9 | 1659.0 | 1870.0 | 1066.0 |
| 12 | 1 | 20 | 53.5 | 1162.0 | - | - |
| 13 | 3 | 20 | 92.0 | 1745.0 | 1654.0 | 1458.0 |
| 14 | 1 | 20 | 57.3 | 1834.0 | - | - |
| 15 | 2 | 20 | 70.5 | 1684.0 | 1586.0 | - |
| 16 | 2 | 20 | 70.0 | 1042.0 | 1664.0 | - |
| 17 | 3 | 20 | 84.0 | 1765.0 | 1630.0 | 1176.0 |
| 18 | 2 | 20 | 76.1 | 1557.0 | 1057.0 | - |
| 19 | 3 | 20 | 93.2 | 1985.0 | 1018.0 | 1340.0 |
| 20 | 3 | 20 | 96.8 | 1760.0 | 1614.0 | 1817.0 |

Long Pulse Radar Test Signal

Test Signal Name: LP_Signal_24

Number of Bursts in Trial: 14

Chrip Center Frequency: 5504.67 MHz

| Burst | Pulses per Burst | Chrip (MHz) | Pulse Width(us) | PRI-1 (us) | PRI-2 (us) | PRI-3 (us) |
|-------|------------------|-------------|-----------------|------------|------------|------------|
| 1 | 1 | 12 | 50.1 | 1841.0 | - | - |
| 2 | 3 | 12 | 93.5 | 1590.0 | 1081.0 | 1413.0 |
| 3 | 2 | 12 | 68.8 | 1707.0 | 1577.0 | - |
| 4 | 1 | 12 | 56.3 | 1056.0 | - | - |
| 5 | 3 | 12 | 86.0 | 1953.0 | 1108.0 | 1987.0 |
| 6 | 2 | 12 | 75.2 | 1572.0 | 1536.0 | - |
| 7 | 1 | 12 | 54.4 | 1517.0 | - | - |
| 8 | 2 | 12 | 71.1 | 1329.0 | 1243.0 | - |
| 9 | 2 | 12 | 76.2 | 1940.0 | 1770.0 | - |
| 10 | 2 | 12 | 80.2 | 1098.0 | 1209.0 | - |
| 11 | 2 | 12 | 79.7 | 1588.0 | 1214.0 | - |
| 12 | 3 | 12 | 90.9 | 1615.0 | 1862.0 | 1601.0 |
| 13 | 2 | 12 | 68.7 | 1377.0 | 1441.0 | - |
| 14 | 2 | 12 | 67.4 | 1872.0 | 1313.0 | - |
| 15 | | | | | | |
| 16 | | | | | | |
| 17 | | | | | | |
| 18 | | | | | | |
| 19 | | | | | | |
| 20 | | | | | | |

Long Pulse Radar Test Signal

Test Signal Name: LP_Signal_25

Number of Bursts in Trial: 13

Chrip Center Frequency: 5505.07 MHz

| Burst | Pulses per Burst | Chrip (MHz) | Pulse Width(us) | PRI-1 (us) | PRI-2 (us) | PRI-3 (us) |
|-------|------------------|-------------|-----------------|------------|------------|------------|
| 1 | 3 | 11 | 94.0 | 1643.0 | 1748.0 | 1941.0 |
| 2 | 2 | 11 | 70.8 | 1177.0 | 1201.0 | - |
| 3 | 1 | 11 | 56.3 | 1006.0 | - | - |
| 4 | 3 | 11 | 96.7 | 1230.0 | 1163.0 | 1332.0 |
| 5 | 3 | 11 | 90.6 | 1217.0 | 1582.0 | 1498.0 |
| 6 | 2 | 11 | 74.5 | 1569.0 | 1281.0 | - |
| 7 | 3 | 11 | 92.6 | 1065.0 | 1669.0 | 1222.0 |
| 8 | 3 | 11 | 89.0 | 1493.0 | 1135.0 | 1380.0 |
| 9 | 3 | 11 | 96.5 | 1607.0 | 1822.0 | 1602.0 |
| 10 | 2 | 11 | 70.5 | 1141.0 | 1178.0 | - |
| 11 | 3 | 11 | 94.0 | 1009.0 | 1629.0 | 1956.0 |
| 12 | 1 | 11 | 55.8 | 1290.0 | - | - |
| 13 | 3 | 11 | 87.7 | 1435.0 | 1963.0 | 1164.0 |
| 14 | | | | | | |
| 15 | | | | | | |
| 16 | | | | | | |
| 17 | | | | | | |
| 18 | | | | | | |
| 19 | | | | | | |
| 20 | | | | | | |

Long Pulse Radar Test Signal

Test Signal Name: LP_Signal_26

Number of Bursts in Trial: 8

Chrip Center Frequency: 5507.47 MHz

| Burst | Pulses per Burst | Chirp (MHz) | Pulse Width(us) | PRI-1 (us) | PRI-2 (us) | PRI-3 (us) |
|-------|------------------|-------------|-----------------|------------|------------|------------|
| 1 | 2 | 5 | 68.6 | 1306.0 | 1161.0 | - |
| 2 | 2 | 5 | 83.1 | 1420.0 | 1315.0 | - |
| 3 | 1 | 5 | 60.9 | 1687.0 | - | - |
| 4 | 2 | 5 | 77.7 | 1776.0 | 1158.0 | - |
| 5 | 2 | 5 | 77.4 | 1793.0 | 1510.0 | - |
| 6 | 2 | 5 | 66.8 | 1576.0 | 1323.0 | - |
| 7 | 1 | 5 | 63.7 | 1333.0 | - | - |
| 8 | 3 | 5 | 91.2 | 1409.0 | 1681.0 | 1275.0 |
| 9 | | | | | | |
| 10 | | | | | | |
| 11 | | | | | | |
| 12 | | | | | | |
| 13 | | | | | | |
| 14 | | | | | | |

Long Pulse Radar Test Signal

Test Signal Name: LP_Signal_27

Number of Bursts in Trial: 17

Chrip Center Frequency: 5503.07 MHz

| Burst | Pulses per Burst | Chrip (MHz) | Pulse Width(us) | PRI-1 (us) | PRI-2 (us) | PRI-3 (us) |
|-------|------------------|-------------|-----------------|------------|------------|------------|
| 1 | 3 | 16 | 83.6 | 1632.0 | 1195.0 | 1000.0 |
| 2 | 3 | 16 | 89.4 | 1173.0 | 1627.0 | 1656.0 |
| 3 | 1 | 16 | 55.8 | 1532.0 | - | - |
| 4 | 3 | 16 | 90.9 | 1981.0 | 1554.0 | 1998.0 |
| 5 | 1 | 16 | 54.7 | 1825.0 | - | - |
| 6 | 3 | 16 | 97.7 | 1734.0 | 1202.0 | 1250.0 |
| 7 | 2 | 16 | 67.5 | 1571.0 | 1434.0 | - |
| 8 | 3 | 16 | 96.7 | 1589.0 | 1469.0 | 1268.0 |
| 9 | 2 | 16 | 68.3 | 1750.0 | 1954.0 | - |
| 10 | 2 | 16 | 78.3 | 1591.0 | 1082.0 | - |
| 11 | 1 | 16 | 55.0 | 1427.0 | - | - |
| 12 | 3 | 16 | 84.9 | 1129.0 | 1936.0 | 1199.0 |
| 13 | 2 | 16 | 74.6 | 1959.0 | 1856.0 | - |
| 14 | 1 | 16 | 63.3 | 1885.0 | - | - |
| 15 | 3 | 16 | 99.8 | 1035.0 | 1515.0 | 1120.0 |
| 16 | 1 | 16 | 63.6 | 1647.0 | - | - |
| 17 | 3 | 16 | 87.3 | 1931.0 | 1051.0 | 1831.0 |
| 18 | | | | | | |

Long Pulse Radar Test Signal

Test Signal Name: LP_Signal_28

Number of Bursts in Trial: 19

Chrip Center Frequency: 5501.87 MHz

| Burst | Pulses per Burst | Chrip (MHz) | Pulse Width(us) | PRI-1 (us) | PRI-2 (us) | PRI-3 (us) |
|-------|------------------|-------------|-----------------|------------|------------|------------|
| 1 | 3 | 19 | 85.6 | 1946.0 | 1078.0 | 1015.0 |
| 2 | 2 | 19 | 68.6 | 1029.0 | 1780.0 | - |
| 3 | 1 | 19 | 54.2 | 1111.0 | - | - |
| 4 | 1 | 19 | 61.2 | 1104.0 | - | - |
| 5 | 3 | 19 | 97.1 | 1157.0 | 1969.0 | 1100.0 |
| 6 | 3 | 19 | 98.3 | 1142.0 | 1699.0 | 1622.0 |
| 7 | 1 | 19 | 62.4 | 1655.0 | - | - |
| 8 | 2 | 19 | 80.2 | 1126.0 | 1769.0 | - |
| 9 | 3 | 19 | 87.5 | 1216.0 | 1448.0 | 1179.0 |
| 10 | 3 | 19 | 85.8 | 1847.0 | 1348.0 | 1472.0 |
| 11 | 3 | 19 | 88.1 | 1023.0 | 1124.0 | 1631.0 |
| 12 | 1 | 19 | 65.3 | 1848.0 | - | - |
| 13 | 1 | 19 | 52.5 | 1470.0 | - | - |
| 14 | 1 | 19 | 52.3 | 1312.0 | - | - |
| 15 | 2 | 19 | 74.1 | 1915.0 | 1200.0 | - |
| 16 | 1 | 19 | 54.9 | 1479.0 | - | - |
| 17 | 2 | 19 | 76.2 | 1376.0 | 1502.0 | - |
| 18 | 1 | 19 | 60.4 | 1758.0 | - | - |
| 19 | 2 | 19 | 81.5 | 1491.0 | 1103.0 | - |
| 20 | | | | | | |

Long Pulse Radar Test Signal

Test Signal Name: LP_Signal_29

Number of Bursts in Trial: 12

Chrip Center Frequency: 5505.47 MHz

| Burst | Pulses per Burst | Chrip (MHz) | Pulse Width(us) | PRI-1 (us) | PRI-2 (us) | PRI-3 (us) |
|-------|------------------|-------------|-----------------|------------|------------|------------|
| 1 | 1 | 10 | 50.5 | 1857.0 | - | - |
| 2 | 1 | 10 | 55.7 | 1246.0 | - | - |
| 3 | 3 | 10 | 85.8 | 1774.0 | 1002.0 | 1967.0 |
| 4 | 2 | 10 | 76.9 | 1125.0 | 1474.0 | - |
| 5 | 2 | 10 | 75.1 | 1254.0 | 1052.0 | - |
| 6 | 3 | 10 | 92.3 | 1180.0 | 1486.0 | 1492.0 |
| 7 | 2 | 10 | 78.1 | 1301.0 | 1757.0 | - |
| 8 | 3 | 10 | 92.2 | 1898.0 | 1252.0 | 1713.0 |
| 9 | 3 | 10 | 89.0 | 1260.0 | 1706.0 | 1411.0 |
| 10 | 2 | 10 | 70.9 | 1578.0 | 1620.0 | - |
| 11 | 1 | 10 | 63.1 | 1782.0 | - | - |
| 12 | 1 | 10 | 55.3 | 1522.0 | - | - |
| 13 | | | | | | |

Long Pulse Radar Test Signal

Test Signal Name: LP_Signal_30

Number of Bursts in Trial: 18

Chrip Center Frequency: 5502.67 MHz

| Burst | Pulses per Burst | Chrip (MHz) | Pulse Width(us) | PRI-1 (us) | PRI-2 (us) | PRI-3 (us) |
|-------|------------------|-------------|-----------------|------------|------------|------------|
| 1 | 3 | 17 | 83.4 | 1454.0 | 1205.0 | 1801.0 |
| 2 | 3 | 17 | 97.3 | 1319.0 | 1826.0 | 1635.0 |
| 3 | 3 | 17 | 90.4 | 1079.0 | 1986.0 | 1674.0 |
| 4 | 3 | 17 | 91.8 | 1563.0 | 1151.0 | 1802.0 |
| 5 | 3 | 17 | 98.2 | 1876.0 | 1977.0 | 1766.0 |
| 6 | 1 | 17 | 59.5 | 1952.0 | - | - |
| 7 | 2 | 17 | 80.0 | 1253.0 | 1137.0 | - |
| 8 | 3 | 17 | 86.5 | 1054.0 | 1128.0 | 1828.0 |
| 9 | 3 | 17 | 91.1 | 1105.0 | 1599.0 | 1442.0 |
| 10 | 3 | 17 | 93.5 | 1867.0 | 1373.0 | 1087.0 |
| 11 | 1 | 17 | 60.7 | 1033.0 | - | - |
| 12 | 2 | 17 | 67.2 | 1288.0 | 1405.0 | - |
| 13 | 1 | 17 | 61.8 | 1585.0 | - | - |
| 14 | 2 | 17 | 79.4 | 1933.0 | 1667.0 | - |
| 15 | 2 | 17 | 81.4 | 1096.0 | 1464.0 | - |
| 16 | 1 | 17 | 65.7 | 1496.0 | - | - |
| 17 | 2 | 17 | 76.0 | 1733.0 | 1255.0 | - |
| 18 | 2 | 17 | 81.0 | 1326.0 | 1668.0 | - |
| 19 | | | | | | - |
| 20 | | | | | | - |

802.11ax (HE40)

Long Pulse Radar Test Signal
 Test Signal Name: LP_Signal_01
 Number of Bursts in Trial: 15
 Chrip Center Frequency 5510.0MHz

| Burst | Pulses per Burst | Chrip (MHz) | Pulse Width(us) | PRI-1 (us) | PRI-2 (us) | PRI-3 (us) |
|-------|------------------|-------------|-----------------|------------|------------|------------|
| 1 | 2 | 13 | 77.8 | 1665.0 | 1477.0 | - |
| 2 | 1 | 13 | 51.9 | 1074.0 | - | - |
| 3 | 1 | 13 | 63.8 | 1584.0 | - | - |
| 4 | 3 | 13 | 96.6 | 1682.0 | 1786.0 | 1843.0 |
| 5 | 3 | 13 | 85.9 | 1795.0 | 1215.0 | 1729.0 |
| 6 | 2 | 13 | 73.7 | 1198.0 | 1549.0 | - |
| 7 | 2 | 13 | 77.2 | 1837.0 | 1819.0 | - |
| 8 | 2 | 13 | 68.4 | 1587.0 | 1114.0 | - |
| 9 | 2 | 13 | 76.7 | 2000.0 | 1155.0 | - |
| 10 | 1 | 13 | 53.2 | 1147.0 | - | - |
| 11 | 3 | 13 | 85.7 | 1433.0 | 1695.0 | 1394.0 |
| 12 | 3 | 13 | 94.3 | 1670.0 | 1426.0 | 1935.0 |
| 13 | 2 | 13 | 77.6 | 1294.0 | 1671.0 | - |
| 14 | 1 | 13 | 65.7 | 1512.0 | - | - |
| 15 | 3 | 13 | 93.5 | 1444.0 | 1130.0 | 1468.0 |
| 16 | | | | | | |
| 17 | | | | | | |
| 18 | | | | | | |
| 19 | | | | | | |
| 20 | | | | | | |

Long Pulse Radar Test Signal

Test Signal Name: LP_Signal_02

Number of Bursts in Trial: 8

Chrip Center Frequency: 5510.0MHz

| Burst | Pulses per Burst | Chirp (MHz) | Pulse Width(us) | PRI-1 (us) | PRI-2 (us) | PRI-3 (us) |
|-------|------------------|-------------|-----------------|------------|------------|------------|
| 1 | 2 | 12 | 75.0 | 1880.0 | 1527.0 | - |
| 2 | 3 | 12 | 99.4 | 1401.0 | 1262.0 | 1257.0 |
| 3 | 2 | 12 | 67.4 | 1531.0 | 1403.0 | - |
| 4 | 2 | 12 | 73.6 | 1449.0 | 1041.0 | - |
| 5 | 1 | 12 | 65.9 | 1432.0 | - | - |
| 6 | 3 | 12 | 83.8 | 1356.0 | 1292.0 | 1419.0 |
| 7 | 1 | 12 | 65.5 | 1543.0 | - | - |
| 8 | 3 | 12 | 98.6 | 1548.0 | 1796.0 | 1728.0 |
| 9 | | | | | | |
| 10 | | | | | | |
| 11 | | | | | | |
| 12 | | | | | | |
| 13 | | | | | | |
| 14 | | | | | | |
| 15 | | | | | | |
| 16 | | | | | | |
| 17 | | | | | | |
| 18 | | | | | | |
| 19 | | | | | | |
| 20 | | | | | | |

Long Pulse Radar Test Signal

Test Signal Name: LP_Signal_03

Number of Bursts in Trial: 11

Chrip Center Frequency: 5510.0MHz

| Burst | Pulses per Burst | Chirp (MHz) | Pulse Width(us) | PRI-1 (us) | PRI-2 (us) | PRI-3 (us) |
|-------|------------------|-------------|-----------------|------------|------------|------------|
| 1 | 2 | 14 | 73.8 | 1806.0 | 1538.0 | - |
| 2 | 2 | 14 | 69.5 | 1117.0 | 1649.0 | - |
| 3 | 1 | 14 | 51.9 | 1651.0 | - | - |
| 4 | 3 | 14 | 84.6 | 1976.0 | 1032.0 | 1271.0 |
| 5 | 3 | 14 | 95.4 | 1060.0 | 1903.0 | 1388.0 |
| 6 | 2 | 14 | 68.0 | 1368.0 | 1351.0 | - |
| 7 | 3 | 14 | 89.6 | 1338.0 | 1514.0 | 1573.0 |
| 8 | 2 | 14 | 81.9 | 1022.0 | 1689.0 | - |
| 9 | 3 | 14 | 88.3 | 1810.0 | 1330.0 | 1838.0 |
| 10 | 1 | 14 | 53.7 | 1597.0 | - | - |
| 11 | 3 | 14 | 91.3 | 1961.0 | 1106.0 | 1001.0 |
| 12 | | | | | | |
| 13 | | | | | | |
| 14 | | | | | | |
| 15 | | | | | | |
| 16 | | | | | | |
| 17 | | | | | | |
| 18 | | | | | | |
| 19 | | | | | | |
| 20 | | | | | | |

Long Pulse Radar Test Signal

Test Signal Name: LP_Signal_04

Number of Bursts in Trial: 20

Chrip Center Frequency: 5510.0MHz

| Burst | Pulses per Burst | Chrip (MHz) | Pulse Width(us) | PRI-1 (us) | PRI-2 (us) | PRI-3 (us) |
|-------|------------------|-------------|-----------------|------------|------------|------------|
| 1 | 2 | 6 | 68.1 | 1339.0 | 1355.0 | - |
| 2 | 1 | 6 | 58.7 | 1251.0 | - | - |
| 3 | 2 | 6 | 75.3 | 1136.0 | 1640.0 | - |
| 4 | 1 | 6 | 56.4 | 1753.0 | - | - |
| 5 | 3 | 6 | 99.7 | 1196.0 | 1708.0 | 1159.0 |
| 6 | 1 | 6 | 57.7 | 1013.0 | - | - |
| 7 | 1 | 6 | 59.5 | 1072.0 | - | - |
| 8 | 2 | 6 | 80.0 | 1482.0 | 1369.0 | - |
| 9 | 2 | 6 | 82.0 | 1993.0 | 1197.0 | - |
| 10 | 2 | 6 | 82.8 | 1883.0 | 1005.0 | - |
| 11 | 3 | 6 | 88.0 | 1061.0 | 1928.0 | 1101.0 |
| 12 | 3 | 6 | 93.2 | 1207.0 | 1907.0 | 1223.0 |
| 13 | 2 | 6 | 70.4 | 1526.0 | 1360.0 | - |
| 14 | 3 | 6 | 95.3 | 1171.0 | 1955.0 | 1775.0 |
| 15 | 2 | 6 | 81.9 | 1690.0 | 1545.0 | - |
| 16 | 3 | 6 | 98.5 | 1975.0 | 1169.0 | 1062.0 |
| 17 | 1 | 6 | 65.0 | 1767.0 | - | - |
| 18 | 3 | 6 | 85.4 | 1011.0 | 1637.0 | 1425.0 |
| 19 | 3 | 6 | 91.6 | 1878.0 | 1445.0 | 1325.0 |
| 20 | 2 | 6 | 67.3 | 1091.0 | 1218.0 | - |

Long Pulse Radar Test Signal

Test Signal Name: LP_Signal_05

Number of Bursts in Trial: 17

Chrip Center Frequency: 5510.0MHz

| Burst | Pulses per Burst | Chrip (MHz) | Pulse Width(us) | PRI-1 (us) | PRI-2 (us) | PRI-3 (us) |
|-------|------------------|-------------|-----------------|------------|------------|------------|
| 1 | 2 | 7 | 67.9 | 1320.0 | 1133.0 | - |
| 2 | 1 | 7 | 62.3 | 1957.0 | - | - |
| 3 | 1 | 7 | 53.3 | 1592.0 | - | - |
| 4 | 3 | 7 | 90.0 | 1900.0 | 1153.0 | 1346.0 |
| 5 | 2 | 7 | 77.1 | 1166.0 | 1646.0 | - |
| 6 | 3 | 7 | 83.9 | 1278.0 | 1232.0 | 1459.0 |
| 7 | 3 | 7 | 89.1 | 1240.0 | 1384.0 | 1939.0 |
| 8 | 2 | 7 | 81.8 | 1833.0 | 1676.0 | - |
| 9 | 1 | 7 | 50.3 | 1075.0 | - | - |
| 10 | 3 | 7 | 87.1 | 1116.0 | 1996.0 | 1756.0 |
| 11 | 2 | 7 | 71.3 | 1225.0 | 1815.0 | - |
| 12 | 3 | 7 | 97.5 | 1884.0 | 1465.0 | 1132.0 |
| 13 | 3 | 7 | 90.6 | 1561.0 | 1040.0 | 1354.0 |
| 14 | 3 | 7 | 86.3 | 1596.0 | 1183.0 | 1792.0 |
| 15 | 3 | 7 | 97.6 | 1365.0 | 1073.0 | 1361.0 |
| 16 | 3 | 7 | 84.7 | 1021.0 | 1718.0 | 1854.0 |
| 17 | 3 | 7 | 99.7 | 1150.0 | 1244.0 | 1988.0 |
| 18 | | | | | | |
| 19 | | | | | | |
| 20 | | | | | | |

Long Pulse Radar Test Signal

Test Signal Name: LP_Signal_06

Number of Bursts in Trial: 14

Chrip Center Frequency: 5510.0MHz

| Burst | Pulses per Burst | Chrip (MHz) | Pulse Width(us) | PRI-1 (us) | PRI-2 (us) | PRI-3 (us) |
|-------|------------------|-------------|-----------------|------------|------------|------------|
| 1 | 3 | 11 | 92.9 | 1085.0 | 1564.0 | 1407.0 |
| 2 | 2 | 11 | 67.7 | 1744.0 | 1747.0 | - |
| 3 | 1 | 11 | 65.8 | 1092.0 | - | - |
| 4 | 1 | 11 | 56.3 | 1851.0 | - | - |
| 5 | 1 | 11 | 53.7 | 1727.0 | - | - |
| 6 | 3 | 11 | 83.5 | 1679.0 | 1930.0 | 1025.0 |
| 7 | 1 | 11 | 65.8 | 1519.0 | - | - |
| 8 | 3 | 11 | 85.9 | 1134.0 | 1034.0 | 1808.0 |
| 9 | 2 | 11 | 76.3 | 1606.0 | 1926.0 | - |
| 10 | 2 | 11 | 81.5 | 1891.0 | 1714.0 | - |
| 11 | 3 | 11 | 89.4 | 1310.0 | 1594.0 | 1827.0 |
| 12 | 1 | 11 | 63.4 | 1568.0 | - | - |
| 13 | 2 | 11 | 69.6 | 1307.0 | 1925.0 | - |
| 14 | 2 | 11 | 74.5 | 1264.0 | 1846.0 | - |
| 15 | | | | | | |
| 16 | | | | | | |
| 17 | | | | | | |
| 18 | | | | | | |
| 19 | | | | | | |
| 20 | | | | | | |

Long Pulse Radar Test Signal

Test Signal Name: LP_Signal_07

Number of Bursts in Trial: 15

Chrip Center Frequency: 5510.0MHz

| Burst | Pulses per Burst | Chirp (MHz) | Pulse Width(us) | PRI-1 (us) | PRI-2 (us) | PRI-3 (us) |
|-------|------------------|-------------|-----------------|------------|------------|------------|
| 1 | 3 | 9 | 96.6 | 1182.0 | 1609.0 | 1581.0 |
| 2 | 3 | 9 | 96.7 | 1829.0 | 1799.0 | 1154.0 |
| 3 | 3 | 9 | 86.5 | 1923.0 | 1396.0 | 1865.0 |
| 4 | 2 | 9 | 73.3 | 1908.0 | 1318.0 | - |
| 5 | 1 | 9 | 55.8 | 1688.0 | - | - |
| 6 | 1 | 9 | 55.4 | 1145.0 | - | - |
| 7 | 3 | 9 | 85.3 | 1336.0 | 1504.0 | 1820.0 |
| 8 | 2 | 9 | 79.4 | 1344.0 | 1893.0 | - |
| 9 | 1 | 9 | 65.7 | 1476.0 | - | - |
| 10 | 2 | 9 | 68.6 | 1008.0 | 1028.0 | - |
| 11 | 2 | 9 | 77.7 | 1972.0 | 1835.0 | - |
| 12 | 2 | 9 | 79.6 | 1882.0 | 1331.0 | - |
| 13 | 3 | 9 | 94.9 | 1830.0 | 1070.0 | 1349.0 |
| 14 | 1 | 9 | 61.4 | 1451.0 | - | - |
| 15 | 3 | 9 | 90.6 | 1233.0 | 1562.0 | 1887.0 |
| 16 | | | | | | |
| 17 | | | | | | |
| 18 | | | | | | |
| 19 | | | | | | |
| 20 | | | | | | |

Long Pulse Radar Test Signal

Test Signal Name: LP_Signal_08

Number of Bursts in Trial: 12

Chrip Center Frequency: 5510.0MHz

| Burst | Pulses per Burst | Chrip (MHz) | Pulse Width(us) | PRI-1 (us) | PRI-2 (us) | PRI-3 (us) |
|-------|------------------|-------------|-----------------|------------|------------|------------|
| 1 | 1 | 9 | 52.6 | 1210.0 | - | - |
| 2 | 3 | 9 | 84.1 | 1314.0 | 1725.0 | 1529.0 |
| 3 | 3 | 9 | 97.7 | 1139.0 | 1868.0 | 1805.0 |
| 4 | 3 | 9 | 97.3 | 1341.0 | 1446.0 | 1755.0 |
| 5 | 3 | 9 | 98.8 | 1544.0 | 1386.0 | 1302.0 |
| 6 | 2 | 9 | 72.2 | 1771.0 | 1184.0 | - |
| 7 | 2 | 9 | 67.6 | 1175.0 | 1027.0 | - |
| 8 | 2 | 9 | 75.7 | 1026.0 | 1871.0 | - |
| 9 | 1 | 9 | 60.9 | 1798.0 | - | - |
| 10 | 1 | 9 | 64.2 | 1138.0 | - | - |
| 11 | 2 | 9 | 78.8 | 1784.0 | 1604.0 | - |
| 12 | 3 | 9 | 87.5 | 1511.0 | 1712.0 | 1683.0 |
| 13 | | | | | | |
| 14 | | | | | | |
| 15 | | | | | | |
| 16 | | | | | | |
| 17 | | | | | | |
| 18 | | | | | | |
| 19 | | | | | | |
| 20 | | | | | | |

Long Pulse Radar Test Signal

Test Signal Name: LP_Signal_09

Number of Bursts in Trial: 14

Chrip Center Frequency: 5510.0MHz

| Burst | Pulses per Burst | Chrip (MHz) | Pulse Width(us) | PRI-1 (us) | PRI-2 (us) | PRI-3 (us) |
|-------|------------------|-------------|-----------------|------------|------------|------------|
| 1 | 1 | 12 | 54.1 | 1415.0 | - | - |
| 2 | 1 | 12 | 50.7 | 1221.0 | - | - |
| 3 | 1 | 12 | 52.3 | 1974.0 | - | - |
| 4 | 3 | 12 | 99.8 | 1558.0 | 1696.0 | 1949.0 |
| 5 | 2 | 12 | 68.4 | 1014.0 | 1099.0 | - |
| 6 | 2 | 12 | 80.8 | 1736.0 | 1505.0 | - |
| 7 | 1 | 12 | 62.5 | 1778.0 | - | - |
| 8 | 2 | 12 | 74.8 | 1149.0 | 1204.0 | - |
| 9 | 1 | 12 | 50.8 | 1049.0 | - | - |
| 10 | 1 | 12 | 54.0 | 1417.0 | - | - |
| 11 | 1 | 12 | 63.0 | 1730.0 | - | - |
| 12 | 3 | 12 | 91.8 | 1143.0 | 1270.0 | 1347.0 |
| 13 | 2 | 12 | 79.3 | 1274.0 | 1992.0 | - |
| 14 | 1 | 12 | 64.3 | 1937.0 | - | - |
| 15 | | | | | | |
| 16 | | | | | | |
| 17 | | | | | | |
| 18 | | | | | | |
| 19 | | | | | | |

Long Pulse Radar Test Signal

Test Signal Name: LP_Signal_10

Number of Bursts in Trial: 8

Chrip Center Frequency: 5510.0MHz

| Burst | Pulses per Burst | Chrip (MHz) | Pulse Width(us) | PRI-1 (us) | PRI-2 (us) | PRI-3 (us) |
|-------|------------------|-------------|-----------------|------------|------------|------------|
| 1 | 1 | 11 | 63.4 | 1043.0 | - | - |
| 2 | 1 | 11 | 52.0 | 1863.0 | - | - |
| 3 | 3 | 11 | 97.2 | 1973.0 | 1605.0 | 1583.0 |
| 4 | 2 | 11 | 78.7 | 1466.0 | 1743.0 | - |
| 5 | 2 | 11 | 74.2 | 1280.0 | 1219.0 | - |
| 6 | 3 | 11 | 88.7 | 1293.0 | 1934.0 | 1273.0 |
| 7 | 1 | 11 | 54.3 | 1991.0 | - | - |
| 8 | 3 | 11 | 95.4 | 1580.0 | 1555.0 | 1791.0 |
| 9 | | | | | | |
| 10 | | | | | | |
| 11 | | | | | | |
| 12 | | | | | | |
| 13 | | | | | | |
| 14 | | | | | | |
| 15 | | | | | | |
| 16 | | | | | | |
| 17 | | | | | | |
| 18 | | | | | | |
| 19 | | | | | | |
| 20 | | | | | | |

Long Pulse Radar Test Signal

Test Signal Name: LP_Signal_11

Number of Bursts in Trial: 17

Chrip Center Frequency: 5497.55MHz

| Burst | Pulses per Burst | Chrip (MHz) | Pulse Width(us) | PRI-1 (us) | PRI-2 (us) | PRI-3 (us) |
|-------|------------------|-------------|-----------------|------------|------------|------------|
| 1 | 2 | 16 | 73.7 | 1208.0 | 1497.0 | - |
| 2 | 3 | 16 | 97.4 | 1942.0 | 1754.0 | 1613.0 |
| 3 | 3 | 16 | 91.7 | 1999.0 | 1702.0 | 1462.0 |
| 4 | 1 | 16 | 66.2 | 1393.0 | - | - |
| 5 | 2 | 16 | 70.8 | 1968.0 | 1821.0 | - |
| 6 | 1 | 16 | 52.3 | 1740.0 | - | - |
| 7 | 2 | 16 | 78.9 | 1308.0 | 1984.0 | - |
| 8 | 2 | 16 | 70.9 | 1050.0 | 1358.0 | - |
| 9 | 2 | 16 | 75.6 | 1437.0 | 1430.0 | - |
| 10 | 1 | 16 | 59.1 | 1697.0 | - | - |
| 11 | 2 | 16 | 77.0 | 1397.0 | 1304.0 | - |
| 12 | 2 | 16 | 67.9 | 1803.0 | 1083.0 | - |
| 13 | 2 | 16 | 81.2 | 1720.0 | 1932.0 | - |
| 14 | 2 | 16 | 78.7 | 1247.0 | 1121.0 | - |
| 15 | 1 | 16 | 63.3 | 1634.0 | - | - |
| 16 | 2 | 16 | 68.9 | 1849.0 | 1423.0 | - |
| 17 | 1 | 16 | 59.3 | 1093.0 | - | - |
| 18 | | | | | | |
| 19 | | | | | | |
| 20 | | | | | | |

Long Pulse Radar Test Signal

Test Signal Name: LP_Signal_12

Number of Bursts in Trial: 19

Chrip Center Frequency: 5498.75MHz

| Burst | Pulses per Burst | Chrip (MHz) | Pulse Width(us) | PRI-1 (us) | PRI-2 (us) | PRI-3 (us) |
|-------|------------------|-------------|-----------------|------------|------------|------------|
| 1 | 3 | 19 | 98.9 | 1381.0 | 1680.0 | 1488.0 |
| 2 | 2 | 19 | 82.3 | 1716.0 | 1855.0 | - |
| 3 | 3 | 19 | 86.7 | 1211.0 | 1400.0 | 1919.0 |
| 4 | 3 | 19 | 89.7 | 1861.0 | 1068.0 | 1282.0 |
| 5 | 3 | 19 | 98.6 | 1507.0 | 1194.0 | 1461.0 |
| 6 | 2 | 19 | 71.1 | 1921.0 | 1789.0 | - |
| 7 | 1 | 19 | 55.9 | 1947.0 | - | - |
| 8 | 2 | 19 | 67.9 | 1350.0 | 1372.0 | - |
| 9 | 3 | 19 | 84.4 | 1203.0 | 1107.0 | 1443.0 |
| 10 | 1 | 19 | 58.8 | 1715.0 | - | - |
| 11 | 1 | 19 | 65.6 | 1017.0 | - | - |
| 12 | 2 | 19 | 78.5 | 1911.0 | 1704.0 | - |
| 13 | 2 | 19 | 82.3 | 1845.0 | 1686.0 | - |
| 14 | 3 | 19 | 90.1 | 1938.0 | 1071.0 | 1266.0 |
| 15 | 3 | 19 | 90.2 | 1989.0 | 1089.0 | 1950.0 |
| 16 | 2 | 19 | 83.1 | 1943.0 | 1406.0 | - |
| 17 | 1 | 19 | 58.8 | 1742.0 | - | - |
| 18 | 2 | 19 | 77.0 | 1187.0 | 1657.0 | - |
| 19 | 1 | 19 | 55.0 | 1012.0 | - | - |
| 20 | | | | | | |

Long Pulse Radar Test Signal

Test Signal Name: LP_Signal_13

Number of Bursts in Trial: 15

Chrip Center Frequency: 5496.35MHz

| Burst | Pulses per Burst | Chrip (MHz) | Pulse Width(us) | PRI-1 (us) | PRI-2 (us) | PRI-3 (us) |
|-------|------------------|-------------|-----------------|------------|------------|------------|
| 1 | 1 | 13 | 58.1 | 1929.0 | - | - |
| 2 | 1 | 13 | 52.1 | 1910.0 | - | - |
| 3 | 1 | 13 | 59.9 | 1971.0 | - | - |
| 4 | 1 | 13 | 60.2 | 1812.0 | - | - |
| 5 | 3 | 13 | 95.9 | 1399.0 | 1906.0 | 1608.0 |
| 6 | 2 | 13 | 79.9 | 1626.0 | 1859.0 | - |
| 7 | 2 | 13 | 78.5 | 1238.0 | 1917.0 | - |
| 8 | 1 | 13 | 53.8 | 1763.0 | - | - |
| 9 | 1 | 13 | 64.7 | 1800.0 | - | - |
| 10 | 1 | 13 | 61.4 | 1390.0 | - | - |
| 11 | 2 | 13 | 83.2 | 1692.0 | 1858.0 | - |
| 12 | 3 | 13 | 84.7 | 1533.0 | 1677.0 | 1638.0 |
| 13 | 3 | 13 | 88.7 | 1703.0 | 1528.0 | 1058.0 |
| 14 | 2 | 13 | 78.3 | 1258.0 | 1951.0 | - |
| 15 | 2 | 13 | 69.3 | 1731.0 | 1717.0 | - |
| 16 | | | | | | |
| 17 | | | | | | |
| 18 | | | | | | |
| 19 | | | | | | |
| 20 | | | | | | |

Long Pulse Radar Test Signal

Test Signal Name: LP_Signal_14

Number of Bursts in Trial: 12

Chrip Center Frequency: 5495.15MHz

| Burst | Pulses per Burst | Chrip (MHz) | Pulse Width(us) | PRI-1 (us) | PRI-2 (us) | PRI-3 (us) |
|-------|------------------|-------------|-----------------|------------|------------|------------|
| 1 | 2 | 10 | 75.3 | 1994.0 | 1612.0 | - |
| 2 | 1 | 10 | 56.3 | 1456.0 | - | - |
| 3 | 2 | 10 | 67.7 | 1617.0 | 1185.0 | - |
| 4 | 1 | 10 | 55.6 | 1337.0 | - | - |
| 5 | 2 | 10 | 75.2 | 1421.0 | 1267.0 | - |
| 6 | 2 | 10 | 76.3 | 1359.0 | 1305.0 | - |
| 7 | 3 | 10 | 85.7 | 1547.0 | 1362.0 | 1924.0 |
| 8 | 3 | 10 | 98.4 | 1873.0 | 1550.0 | 1249.0 |
| 9 | 3 | 10 | 86.4 | 1779.0 | 1439.0 | 1046.0 |
| 10 | 3 | 10 | 93.6 | 1059.0 | 1031.0 | 1452.0 |
| 11 | 1 | 10 | 63.3 | 1328.0 | - | - |
| 12 | 3 | 10 | 92.4 | 1412.0 | 1673.0 | 1322.0 |
| 13 | | | | | | |
| 14 | | | | | | |
| 15 | | | | | | |
| 16 | | | | | | |
| 17 | | | | | | |
| 18 | | | | | | |
| 19 | | | | | | |
| 20 | | | | | | |

Long Pulse Radar Test Signal

Test Signal Name: LP_Signal_15

Number of Bursts in Trial: 19

Chrip Center Frequency: 5498.35MHz

| Burst | Pulses per Burst | Chrip (MHz) | Pulse Width(us) | PRI-1 (us) | PRI-2 (us) | PRI-3 (us) |
|-------|------------------|-------------|-----------------|------------|------------|------------|
| 1 | 3 | 18 | 93.3 | 1983.0 | 1912.0 | 1535.0 |
| 2 | 2 | 18 | 69.1 | 1102.0 | 1794.0 | - |
| 3 | 3 | 18 | 86.9 | 1044.0 | 1152.0 | 1148.0 |
| 4 | 3 | 18 | 84.9 | 1894.0 | 1948.0 | 1118.0 |
| 5 | 2 | 18 | 72.3 | 1094.0 | 1916.0 | - |
| 6 | 1 | 18 | 51.7 | 1447.0 | - | - |
| 7 | 1 | 18 | 58.3 | 1429.0 | - | - |
| 8 | 1 | 18 | 60.8 | 1979.0 | - | - |
| 9 | 1 | 18 | 57.1 | 1641.0 | - | - |
| 10 | 3 | 18 | 88.9 | 1886.0 | 1964.0 | 1489.0 |
| 11 | 2 | 18 | 72.0 | 1909.0 | 1297.0 | - |
| 12 | 3 | 18 | 90.9 | 1261.0 | 1566.0 | 1370.0 |
| 13 | 1 | 18 | 59.8 | 1552.0 | - | - |
| 14 | 2 | 18 | 70.0 | 1759.0 | 1291.0 | - |
| 15 | 2 | 18 | 67.2 | 1625.0 | 1881.0 | - |
| 16 | 3 | 18 | 91.2 | 1382.0 | 1832.0 | 1661.0 |
| 17 | 1 | 18 | 56.5 | 1483.0 | - | - |
| 18 | 1 | 18 | 51.2 | 1237.0 | - | - |
| 19 | 2 | 18 | 74.1 | 1471.0 | 1245.0 | - |
| 20 | | | | | | |

Long Pulse Radar Test Signal

Test Signal Name: LP_Signal_16

Number of Bursts in Trial: 14

Chrip Center Frequency: 5495.95MHz

| Burst | Pulses per Burst | Chirp (MHz) | Pulse Width(us) | PRI-1 (us) | PRI-2 (us) | PRI-3 (us) |
|-------|------------------|-------------|-----------------|------------|------------|------------|
| 1 | 2 | 12 | 76.9 | 1110.0 | 1140.0 | - |
| 2 | 1 | 12 | 50.2 | 1316.0 | - | - |
| 3 | 1 | 12 | 62.9 | 1520.0 | - | - |
| 4 | 1 | 12 | 64.7 | 1902.0 | - | - |
| 5 | 3 | 12 | 83.8 | 1410.0 | 1097.0 | 1621.0 |
| 6 | 1 | 12 | 65.4 | 1944.0 | - | - |
| 7 | 1 | 12 | 53.2 | 1024.0 | - | - |
| 8 | 1 | 12 | 51.7 | 1603.0 | - | - |
| 9 | 2 | 12 | 78.7 | 1804.0 | 1168.0 | - |
| 10 | 2 | 12 | 72.4 | 1030.0 | 1343.0 | - |
| 11 | 1 | 12 | 53.8 | 1327.0 | - | - |
| 12 | 2 | 12 | 73.6 | 1524.0 | 1553.0 | - |
| 13 | 2 | 12 | 66.7 | 1722.0 | 1122.0 | - |
| 14 | 2 | 12 | 82.5 | 1404.0 | 1019.0 | - |
| 15 | | | | | | |
| 16 | | | | | | |
| 17 | | | | | | |
| 18 | | | | | | |
| 19 | | | | | | |
| 20 | | | | | | |

Long Pulse Radar Test Signal

Test Signal Name: LP_Signal_17

Number of Bursts in Trial: 20

Chrip Center Frequency: 5499.15MHz

| Burst | Pulses per Burst | Chirp (MHz) | Pulse Width(us) | PRI-1 (us) | PRI-2 (us) | PRI-3 (us) |
|-------|------------------|-------------|-----------------|------------|------------|------------|
| 1 | 3 | 20 | 87.6 | 1565.0 | 1055.0 | 1840.0 |
| 2 | 3 | 20 | 85.2 | 1735.0 | 1541.0 | 1408.0 |
| 3 | 3 | 20 | 84.8 | 1534.0 | 1889.0 | 1463.0 |
| 4 | 2 | 20 | 77.9 | 1749.0 | 1460.0 | - |
| 5 | 2 | 20 | 76.5 | 1518.0 | 1485.0 | - |
| 6 | 1 | 20 | 60.9 | 1540.0 | - | - |
| 7 | 2 | 20 | 83.0 | 1080.0 | 1010.0 | - |
| 8 | 2 | 20 | 80.4 | 1824.0 | 1752.0 | - |
| 9 | 2 | 20 | 67.5 | 1764.0 | 1181.0 | - |
| 10 | 1 | 20 | 62.1 | 1495.0 | - | - |
| 11 | 3 | 20 | 86.4 | 1773.0 | 1966.0 | 1263.0 |
| 12 | 3 | 20 | 84.3 | 1593.0 | 1188.0 | 1788.0 |
| 13 | 2 | 20 | 76.9 | 1226.0 | 1537.0 | - |
| 14 | 3 | 20 | 95.8 | 1192.0 | 1298.0 | 1844.0 |
| 15 | 1 | 20 | 55.2 | 1644.0 | - | - |
| 16 | 1 | 20 | 59.0 | 1402.0 | - | - |
| 17 | 3 | 20 | 94.5 | 1296.0 | 1700.0 | 1283.0 |
| 18 | 3 | 20 | 91.9 | 1970.0 | 1978.0 | 1165.0 |
| 19 | 3 | 20 | 85.2 | 1732.0 | 1551.0 | 1189.0 |
| 20 | 2 | 20 | 69.5 | 1038.0 | 1224.0 | - |

Long Pulse Radar Test Signal

Test Signal Name: LP_Signal_18

Number of Bursts in Trial: 12

Chrip Center Frequency: 5495.15MHz

| Burst | Pulses per Burst | Chrip (MHz) | Pulse Width(us) | PRI-1 (us) | PRI-2 (us) | PRI-3 (us) |
|-------|------------------|-------------|-----------------|------------|------------|------------|
| 1 | 3 | 10 | 86.4 | 1259.0 | 1918.0 | 1455.0 |
| 2 | 3 | 10 | 92.2 | 1598.0 | 1719.0 | 1895.0 |
| 3 | 2 | 10 | 80.4 | 1816.0 | 1899.0 | - |
| 4 | 1 | 10 | 54.3 | 1335.0 | - | - |
| 5 | 1 | 10 | 53.1 | 1303.0 | - | - |
| 6 | 2 | 10 | 69.4 | 1503.0 | 1546.0 | - |
| 7 | 2 | 10 | 69.1 | 1279.0 | 1639.0 | - |
| 8 | 3 | 10 | 100.0 | 1375.0 | 1438.0 | 1595.0 |
| 9 | 2 | 10 | 79.6 | 1239.0 | 1705.0 | - |
| 10 | 3 | 10 | 88.4 | 1374.0 | 1579.0 | 1623.0 |
| 11 | 1 | 10 | 53.3 | 1016.0 | - | - |
| 12 | 1 | 10 | 65.3 | 1709.0 | - | - |
| 13 | | | | | | |
| 14 | | | | | | |
| 15 | | | | | | |
| 16 | | | | | | |
| 17 | | | | | | |
| 18 | | | | | | |
| 19 | | | | | | |
| 20 | | | | | | |

Long Pulse Radar Test Signal

Test Signal Name: LP_Signal_19

Number of Bursts in Trial: 14

Chrip Center Frequency: 5495.95MHz

| Burst | Pulses per Burst | Chrip (MHz) | Pulse Width(us) | PRI-1 (us) | PRI-2 (us) | PRI-3 (us) |
|-------|------------------|-------------|-----------------|------------|------------|------------|
| 1 | 1 | 12 | 55.3 | 1920.0 | - | - |
| 2 | 1 | 12 | 58.3 | 1797.0 | - | - |
| 3 | 2 | 12 | 72.3 | 1610.0 | 1039.0 | - |
| 4 | 3 | 12 | 84.8 | 1131.0 | 1761.0 | 1721.0 |
| 5 | 2 | 12 | 82.5 | 1875.0 | 1431.0 | - |
| 6 | 1 | 12 | 63.3 | 1095.0 | - | - |
| 7 | 2 | 12 | 80.0 | 1119.0 | 1913.0 | - |
| 8 | 3 | 12 | 90.3 | 1660.0 | 1853.0 | 1123.0 |
| 9 | 3 | 12 | 91.1 | 1539.0 | 1783.0 | 1172.0 |
| 10 | 3 | 12 | 96.6 | 1525.0 | 1036.0 | 1385.0 |
| 11 | 2 | 12 | 82.7 | 1710.0 | 1990.0 | - |
| 12 | 1 | 12 | 50.7 | 1234.0 | - | - |
| 13 | 2 | 12 | 78.4 | 1047.0 | 1109.0 | - |
| 14 | 3 | 12 | 99.5 | 1299.0 | 1965.0 | 1869.0 |
| 15 | | | | | | |
| 16 | | | | | | |
| 17 | | | | | | |
| 18 | | | | | | |
| 19 | | | | | | |
| 20 | | | | | | |

Long Pulse Radar Test Signal
 Test Signal Name: LP_Signal_20
 Number of Bursts in Trial: 12
 Chrip Center Frequency: 5495.15MHz

| Burst | Pulses per Burst | Chirp (MHz) | Pulse Width(us) | PRI-1 (us) | PRI-2 (us) | PRI-3 (us) |
|-------|------------------|-------------|-----------------|------------|------------|------------|
| 1 | 3 | 10 | 88.6 | 1501.0 | 1067.0 | 1927.0 |
| 2 | 1 | 10 | 57.4 | 1723.0 | - | - |
| 3 | 3 | 10 | 96.6 | 1086.0 | 1658.0 | 1324.0 |
| 4 | 2 | 10 | 69.7 | 1751.0 | 1945.0 | - |
| 5 | 2 | 10 | 77.9 | 1642.0 | 1317.0 | - |
| 6 | 1 | 10 | 62.0 | 1866.0 | - | - |
| 7 | 3 | 10 | 88.4 | 1997.0 | 1077.0 | 1366.0 |
| 8 | 3 | 10 | 97.3 | 1790.0 | 1896.0 | 1367.0 |
| 9 | 3 | 10 | 96.2 | 1391.0 | 1787.0 | 1672.0 |
| 10 | 3 | 10 | 95.4 | 1020.0 | 1892.0 | 1414.0 |
| 11 | 1 | 10 | 54.8 | 1084.0 | - | - |
| 12 | 2 | 10 | 80.4 | 1850.0 | 1436.0 | - |
| 13 | | | | | | |
| 14 | | | | | | |
| 15 | | | | | | |
| 16 | | | | | | |
| 17 | | | | | | |
| 18 | | | | | | |
| 19 | | | | | | |
| 20 | | | | | | |

Long Pulse Radar Test Signal

Test Signal Name: LP_Signal_21

Number of Bursts in Trial: 16

Chrip Center Frequency: 5522.85MHz

| Burst | Pulses per Burst | Chirp (MHz) | Pulse Width(us) | PRI-1 (us) | PRI-2 (us) | PRI-3 (us) |
|-------|------------------|-------------|-----------------|------------|------------|------------|
| 1 | 2 | 15 | 74.7 | 1619.0 | 1611.0 | - |
| 2 | 1 | 15 | 57.1 | 1560.0 | - | - |
| 3 | 3 | 15 | 91.9 | 1392.0 | 1475.0 | 1276.0 |
| 4 | 2 | 15 | 83.1 | 1809.0 | 1772.0 | - |
| 5 | 1 | 15 | 50.7 | 1003.0 | - | - |
| 6 | 2 | 15 | 79.2 | 1574.0 | 1600.0 | - |
| 7 | 1 | 15 | 58.7 | 1186.0 | - | - |
| 8 | 2 | 15 | 71.0 | 1521.0 | 1567.0 | - |
| 9 | 2 | 15 | 79.0 | 1777.0 | 1960.0 | - |
| 10 | 2 | 15 | 68.5 | 1284.0 | 1428.0 | - |
| 11 | 2 | 15 | 73.5 | 1904.0 | 1352.0 | - |
| 12 | 2 | 15 | 70.5 | 1864.0 | 1115.0 | - |
| 13 | 2 | 15 | 76.6 | 1045.0 | 1300.0 | - |
| 14 | 2 | 15 | 81.2 | 1160.0 | 1675.0 | - |
| 15 | 1 | 15 | 61.8 | 1277.0 | - | - |
| 16 | 3 | 15 | 94.9 | 1450.0 | 1206.0 | 1860.0 |
| 17 | | | | | | |
| 18 | | | | | | |
| 19 | | | | | | |
| 20 | | | | | | |

Long Pulse Radar Test Signal

Test Signal Name: LP_Signal_22

Number of Bursts in Trial: 12

Chrip Center Frequency: 5525.25MHz

| Burst | Pulses per Burst | Chrip (MHz) | Pulse Width(us) | PRI-1 (us) | PRI-2 (us) | PRI-3 (us) |
|-------|------------------|-------------|-----------------|------------|------------|------------|
| 1 | 2 | 9 | 78.5 | 1653.0 | 1698.0 | - |
| 2 | 3 | 9 | 89.8 | 1174.0 | 1962.0 | 1167.0 |
| 3 | 1 | 9 | 59.4 | 1982.0 | - | - |
| 4 | 2 | 9 | 79.6 | 1633.0 | 1890.0 | - |
| 5 | 2 | 9 | 76.0 | 1112.0 | 1811.0 | - |
| 6 | 1 | 9 | 53.6 | 1144.0 | - | - |
| 7 | 2 | 9 | 80.9 | 1220.0 | 1053.0 | - |
| 8 | 1 | 9 | 61.6 | 1724.0 | - | - |
| 9 | 1 | 9 | 53.4 | 1901.0 | - | - |
| 10 | 1 | 9 | 59.9 | 1379.0 | - | - |
| 11 | 1 | 9 | 60.4 | 1453.0 | - | - |
| 12 | 3 | 9 | 91.4 | 1768.0 | 1726.0 | 1227.0 |
| 13 | | | | | | |
| 14 | | | | | | |
| 15 | | | | | | |
| 16 | | | | | | |
| 17 | | | | | | |
| 18 | | | | | | |
| 19 | | | | | | |
| 20 | | | | | | |

Long Pulse Radar Test Signal

Test Signal Name: LP_Signal_23

Number of Bursts in Trial: 20

Chrip Center Frequency: 5520.85MHz

| Burst | Pulses per Burst | Chirp (MHz) | Pulse Width(us) | PRI-1 (us) | PRI-2 (us) | PRI-3 (us) |
|-------|------------------|-------------|-----------------|------------|------------|------------|
| 1 | 2 | 20 | 77.0 | 1191.0 | 1363.0 | - |
| 2 | 1 | 20 | 58.1 | 1248.0 | - | - |
| 3 | 1 | 20 | 62.1 | 1836.0 | - | - |
| 4 | 2 | 20 | 76.9 | 1334.0 | 1236.0 | - |
| 5 | 2 | 20 | 80.0 | 1914.0 | 1852.0 | - |
| 6 | 1 | 20 | 52.0 | 1701.0 | - | - |
| 7 | 3 | 20 | 88.6 | 1693.0 | 1995.0 | 1905.0 |
| 8 | 2 | 20 | 72.9 | 1922.0 | 1387.0 | - |
| 9 | 3 | 20 | 98.5 | 1839.0 | 1746.0 | 1389.0 |
| 10 | 1 | 20 | 57.9 | 1193.0 | - | - |
| 11 | 3 | 20 | 95.9 | 1659.0 | 1870.0 | 1066.0 |
| 12 | 1 | 20 | 53.5 | 1162.0 | - | - |
| 13 | 3 | 20 | 92.0 | 1745.0 | 1654.0 | 1458.0 |
| 14 | 1 | 20 | 57.3 | 1834.0 | - | - |
| 15 | 2 | 20 | 70.5 | 1684.0 | 1586.0 | - |
| 16 | 2 | 20 | 70.0 | 1042.0 | 1664.0 | - |
| 17 | 3 | 20 | 84.0 | 1765.0 | 1630.0 | 1176.0 |
| 18 | 2 | 20 | 76.1 | 1557.0 | 1057.0 | - |
| 19 | 3 | 20 | 93.2 | 1985.0 | 1018.0 | 1340.0 |
| 20 | 3 | 20 | 96.8 | 1760.0 | 1614.0 | 1817.0 |

Long Pulse Radar Test Signal

Test Signal Name: LP_Signal_24

Number of Bursts in Trial: 14

Chrip Center Frequency: 5524.05MHz

| Burst | Pulses per Burst | Chirp (MHz) | Pulse Width(us) | PRI-1 (us) | PRI-2 (us) | PRI-3 (us) |
|-------|------------------|-------------|-----------------|------------|------------|------------|
| 1 | 1 | 12 | 50.1 | 1841.0 | - | - |
| 2 | 3 | 12 | 93.5 | 1590.0 | 1081.0 | 1413.0 |
| 3 | 2 | 12 | 68.8 | 1707.0 | 1577.0 | - |
| 4 | 1 | 12 | 56.3 | 1056.0 | - | - |
| 5 | 3 | 12 | 86.0 | 1953.0 | 1108.0 | 1987.0 |
| 6 | 2 | 12 | 75.2 | 1572.0 | 1536.0 | - |
| 7 | 1 | 12 | 54.4 | 1517.0 | - | - |
| 8 | 2 | 12 | 71.1 | 1329.0 | 1243.0 | - |
| 9 | 2 | 12 | 76.2 | 1940.0 | 1770.0 | - |
| 10 | 2 | 12 | 80.2 | 1098.0 | 1209.0 | - |
| 11 | 2 | 12 | 79.7 | 1588.0 | 1214.0 | - |
| 12 | 3 | 12 | 90.9 | 1615.0 | 1862.0 | 1601.0 |
| 13 | 2 | 12 | 68.7 | 1377.0 | 1441.0 | - |
| 14 | 2 | 12 | 67.4 | 1872.0 | 1313.0 | - |
| 15 | | | | | | |
| 16 | | | | | | |
| 17 | | | | | | |
| 18 | | | | | | |
| 19 | | | | | | |
| 20 | | | | | | |

Long Pulse Radar Test Signal

Test Signal Name: LP_Signal_25

Number of Bursts in Trial: 13

Chrip Center Frequency: 5524.45MHz

| Burst | Pulses per Burst | Chirp (MHz) | Pulse Width(us) | PRI-1 (us) | PRI-2 (us) | PRI-3 (us) |
|-------|------------------|-------------|-----------------|------------|------------|------------|
| 1 | 3 | 11 | 94.0 | 1643.0 | 1748.0 | 1941.0 |
| 2 | 2 | 11 | 70.8 | 1177.0 | 1201.0 | - |
| 3 | 1 | 11 | 56.3 | 1006.0 | - | - |
| 4 | 3 | 11 | 96.7 | 1230.0 | 1163.0 | 1332.0 |
| 5 | 3 | 11 | 90.6 | 1217.0 | 1582.0 | 1498.0 |
| 6 | 2 | 11 | 74.5 | 1569.0 | 1281.0 | - |
| 7 | 3 | 11 | 92.6 | 1065.0 | 1669.0 | 1222.0 |
| 8 | 3 | 11 | 89.0 | 1493.0 | 1135.0 | 1380.0 |
| 9 | 3 | 11 | 96.5 | 1607.0 | 1822.0 | 1602.0 |
| 10 | 2 | 11 | 70.5 | 1141.0 | 1178.0 | - |
| 11 | 3 | 11 | 94.0 | 1009.0 | 1629.0 | 1956.0 |
| 12 | 1 | 11 | 55.8 | 1290.0 | - | - |
| 13 | 3 | 11 | 87.7 | 1435.0 | 1963.0 | 1164.0 |
| 14 | | | | | | |
| 15 | | | | | | |
| 16 | | | | | | |
| 17 | | | | | | |
| 18 | | | | | | |
| 19 | | | | | | |
| 20 | | | | | | |

Long Pulse Radar Test Signal

Test Signal Name: LP_Signal_26

Number of Bursts in Trial: 8

Chrip Center Frequency: 5526.85MHz

| Burst | Pulses per Burst | Chrip (MHz) | Pulse Width(us) | PRI-1 (us) | PRI-2 (us) | PRI-3 (us) |
|-------|------------------|-------------|-----------------|------------|------------|------------|
| 1 | 2 | 5 | 68.6 | 1306.0 | 1161.0 | - |
| 2 | 2 | 5 | 83.1 | 1420.0 | 1315.0 | - |
| 3 | 1 | 5 | 60.9 | 1687.0 | - | - |
| 4 | 2 | 5 | 77.7 | 1776.0 | 1158.0 | - |
| 5 | 2 | 5 | 77.4 | 1793.0 | 1510.0 | - |
| 6 | 2 | 5 | 66.8 | 1576.0 | 1323.0 | - |
| 7 | 1 | 5 | 63.7 | 1333.0 | - | - |
| 8 | 3 | 5 | 91.2 | 1409.0 | 1681.0 | 1275.0 |
| 9 | | | | | | |
| 10 | | | | | | |
| 11 | | | | | | |
| 12 | | | | | | |

Long Pulse Radar Test Signal

Test Signal Name: LP_Signal_27

Number of Bursts in Trial: 17

Chrip Center Frequency: 5522.45MHz

| Burst | Pulses per Burst | Chrip (MHz) | Pulse Width(us) | PRI-1 (us) | PRI-2 (us) | PRI-3 (us) |
|-------|------------------|-------------|-----------------|------------|------------|------------|
| 1 | 3 | 16 | 83.6 | 1632.0 | 1195.0 | 1000.0 |
| 2 | 3 | 16 | 89.4 | 1173.0 | 1627.0 | 1656.0 |
| 3 | 1 | 16 | 55.8 | 1532.0 | - | - |
| 4 | 3 | 16 | 90.9 | 1981.0 | 1554.0 | 1998.0 |
| 5 | 1 | 16 | 54.7 | 1825.0 | - | - |
| 6 | 3 | 16 | 97.7 | 1734.0 | 1202.0 | 1250.0 |
| 7 | 2 | 16 | 67.5 | 1571.0 | 1434.0 | - |
| 8 | 3 | 16 | 96.7 | 1589.0 | 1469.0 | 1268.0 |
| 9 | 2 | 16 | 68.3 | 1750.0 | 1954.0 | - |
| 10 | 2 | 16 | 78.3 | 1591.0 | 1082.0 | - |
| 11 | 1 | 16 | 55.0 | 1427.0 | - | - |
| 12 | 3 | 16 | 84.9 | 1129.0 | 1936.0 | 1199.0 |
| 13 | 2 | 16 | 74.6 | 1959.0 | 1856.0 | - |
| 14 | 1 | 16 | 63.3 | 1885.0 | - | - |
| 15 | 3 | 16 | 99.8 | 1035.0 | 1515.0 | 1120.0 |
| 16 | 1 | 16 | 63.6 | 1647.0 | - | - |
| 17 | 3 | 16 | 87.3 | 1931.0 | 1051.0 | 1831.0 |
| 18 | | | | | | |
| 19 | | | | | | |
| 20 | | | | | | |

Long Pulse Radar Test Signal

Test Signal Name: LP_Signal_28

Number of Bursts in Trial: 19

Chrip Center Frequency: 5521.25MHz

| Burst | Pulses per Burst | Chrip (MHz) | Pulse Width(us) | PRI-1 (us) | PRI-2 (us) | PRI-3 (us) |
|-------|------------------|-------------|-----------------|------------|------------|------------|
| 1 | 3 | 19 | 85.6 | 1946.0 | 1078.0 | 1015.0 |
| 2 | 2 | 19 | 68.6 | 1029.0 | 1780.0 | - |
| 3 | 1 | 19 | 54.2 | 1111.0 | - | - |
| 4 | 1 | 19 | 61.2 | 1104.0 | - | - |
| 5 | 3 | 19 | 97.1 | 1157.0 | 1969.0 | 1100.0 |
| 6 | 3 | 19 | 98.3 | 1142.0 | 1699.0 | 1622.0 |
| 7 | 1 | 19 | 62.4 | 1655.0 | - | - |
| 8 | 2 | 19 | 80.2 | 1126.0 | 1769.0 | - |
| 9 | 3 | 19 | 87.5 | 1216.0 | 1448.0 | 1179.0 |
| 10 | 3 | 19 | 85.8 | 1847.0 | 1348.0 | 1472.0 |
| 11 | 3 | 19 | 88.1 | 1023.0 | 1124.0 | 1631.0 |
| 12 | 1 | 19 | 65.3 | 1848.0 | - | - |
| 13 | 1 | 19 | 52.5 | 1470.0 | - | - |
| 14 | 1 | 19 | 52.3 | 1312.0 | - | - |
| 15 | 2 | 19 | 74.1 | 1915.0 | 1200.0 | - |
| 16 | 1 | 19 | 54.9 | 1479.0 | - | - |
| 17 | 2 | 19 | 76.2 | 1376.0 | 1502.0 | - |
| 18 | 1 | 19 | 60.4 | 1758.0 | - | - |
| 19 | 2 | 19 | 81.5 | 1491.0 | 1103.0 | - |
| 20 | | | | | | |

Long Pulse Radar Test Signal

Test Signal Name: LP_Signal_29

Number of Bursts in Trial: 12

Chrip Center Frequency: 5524.85MHz

| Burst | Pulses per Burst | Chrip (MHz) | Pulse Width(us) | PRI-1 (us) | PRI-2 (us) | PRI-3 (us) |
|-------|------------------|-------------|-----------------|------------|------------|------------|
| 1 | 1 | 10 | 50.5 | 1857.0 | - | - |
| 2 | 1 | 10 | 55.7 | 1246.0 | - | - |
| 3 | 3 | 10 | 85.8 | 1774.0 | 1002.0 | 1967.0 |
| 4 | 2 | 10 | 76.9 | 1125.0 | 1474.0 | - |
| 5 | 2 | 10 | 75.1 | 1254.0 | 1052.0 | - |
| 6 | 3 | 10 | 92.3 | 1180.0 | 1486.0 | 1492.0 |
| 7 | 2 | 10 | 78.1 | 1301.0 | 1757.0 | - |
| 8 | 3 | 10 | 92.2 | 1898.0 | 1252.0 | 1713.0 |
| 9 | 3 | 10 | 89.0 | 1260.0 | 1706.0 | 1411.0 |
| 10 | 2 | 10 | 70.9 | 1578.0 | 1620.0 | - |
| 11 | 1 | 10 | 63.1 | 1782.0 | - | - |
| 12 | 1 | 10 | 55.3 | 1522.0 | - | - |
| 13 | | | | | | |

Long Pulse Radar Test Signal

Test Signal Name: LP_Signal_30

Number of Bursts in Trial: 18

Chrip Center Frequency: 5522.05MHz

| Burst | Pulses per Burst | Chrip (MHz) | Pulse Width(us) | PRI-1 (us) | PRI-2 (us) | PRI-3 (us) |
|-------|------------------|-------------|-----------------|------------|------------|------------|
| 1 | 3 | 17 | 83.4 | 1454.0 | 1205.0 | 1801.0 |
| 2 | 3 | 17 | 97.3 | 1319.0 | 1826.0 | 1635.0 |
| 3 | 3 | 17 | 90.4 | 1079.0 | 1986.0 | 1674.0 |
| 4 | 3 | 17 | 91.8 | 1563.0 | 1151.0 | 1802.0 |
| 5 | 3 | 17 | 98.2 | 1876.0 | 1977.0 | 1766.0 |
| 6 | 1 | 17 | 59.5 | 1952.0 | - | - |
| 7 | 2 | 17 | 80.0 | 1253.0 | 1137.0 | - |
| 8 | 3 | 17 | 86.5 | 1054.0 | 1128.0 | 1828.0 |
| 9 | 3 | 17 | 91.1 | 1105.0 | 1599.0 | 1442.0 |
| 10 | 3 | 17 | 93.5 | 1867.0 | 1373.0 | 1087.0 |
| 11 | 1 | 17 | 60.7 | 1033.0 | - | - |
| 12 | 2 | 17 | 67.2 | 1288.0 | 1405.0 | - |
| 13 | 1 | 17 | 61.8 | 1585.0 | - | - |
| 14 | 2 | 17 | 79.4 | 1933.0 | 1667.0 | - |
| 15 | 2 | 17 | 81.4 | 1096.0 | 1464.0 | - |
| 16 | 1 | 17 | 65.7 | 1496.0 | - | - |
| 17 | 2 | 17 | 76.0 | 1733.0 | 1255.0 | - |
| 18 | 2 | 17 | 81.0 | 1326.0 | 1668.0 | - |
| 19 | | | | | | |

802.11ax (HE80)

Long Pulse Radar Test Signal

Test Signal Name: LP_Signal_01

Number of Bursts in Trial: 15

Chirp Center Frequency 5530.0MHz

| Burst | Pulses per Burst | Chirp (MHz) | Pulse Width(us) | PRI-1 (us) | PRI-2 (us) | PRI-3 (us) |
|-------|------------------|-------------|-----------------|------------|------------|------------|
| 1 | 2 | 11 | 77.8 | 1665.0 | 1477.0 | - |
| 2 | 1 | 11 | 51.9 | 1074.0 | - | - |
| 3 | 1 | 11 | 63.8 | 1584.0 | - | - |
| 4 | 3 | 11 | 96.6 | 1682.0 | 1786.0 | 1843.0 |
| 5 | 3 | 11 | 85.9 | 1795.0 | 1215.0 | 1729.0 |
| 6 | 2 | 11 | 73.7 | 1198.0 | 1549.0 | - |
| 7 | 2 | 11 | 77.2 | 1837.0 | 1819.0 | - |
| 8 | 2 | 11 | 68.4 | 1587.0 | 1114.0 | - |
| 9 | 2 | 11 | 76.7 | 2000.0 | 1155.0 | - |
| 10 | 1 | 11 | 53.2 | 1147.0 | - | - |
| 11 | 3 | 11 | 85.7 | 1433.0 | 1695.0 | 1394.0 |
| 12 | 3 | 11 | 94.3 | 1670.0 | 1426.0 | 1935.0 |
| 13 | 2 | 11 | 77.6 | 1294.0 | 1671.0 | - |
| 14 | 1 | 11 | 65.7 | 1512.0 | - | - |
| 15 | 3 | 11 | 93.5 | 1444.0 | 1130.0 | 1468.0 |
| 16 | | | | | | |
| 17 | | | | | | |
| 18 | | | | | | |
| 19 | | | | | | |
| 20 | | | | | | |

Long Pulse Radar Test Signal

Test Signal Name: LP_Signal_02

Number of Bursts in Trial: 8

Chrip Center Frequency: 5530.0MHz

| Burst | Pulses per Burst | Chirp (MHz) | Pulse Width(us) | PRI-1 (us) | PRI-2 (us) | PRI-3 (us) |
|-------|------------------|-------------|-----------------|------------|------------|------------|
| 1 | 2 | 12 | 75.0 | 1880.0 | 1527.0 | - |
| 2 | 3 | 12 | 99.4 | 1401.0 | 1262.0 | 1257.0 |
| 3 | 2 | 12 | 67.4 | 1531.0 | 1403.0 | - |
| 4 | 2 | 12 | 73.6 | 1449.0 | 1041.0 | - |
| 5 | 1 | 12 | 65.9 | 1432.0 | - | - |
| 6 | 3 | 12 | 83.8 | 1356.0 | 1292.0 | 1419.0 |
| 7 | 1 | 12 | 65.5 | 1543.0 | - | - |
| 8 | 3 | 12 | 98.6 | 1548.0 | 1796.0 | 1728.0 |
| 9 | | | | | | |
| 10 | | | | | | |
| 11 | | | | | | |
| 12 | | | | | | |
| 13 | | | | | | |
| 14 | | | | | | |
| 15 | | | | | | |
| 16 | | | | | | |
| 17 | | | | | | |
| 18 | | | | | | |
| 19 | | | | | | |
| 20 | | | | | | |

Long Pulse Radar Test Signal

Test Signal Name: LP_Signal_03

Number of Bursts in Trial: 11

Chrip Center Frequency: 5530.0MHz

| Burst | Pulses per Burst | Chirp (MHz) | Pulse Width(us) | PRI-1 (us) | PRI-2 (us) | PRI-3 (us) |
|-------|------------------|-------------|-----------------|------------|------------|------------|
| 1 | 2 | 19 | 73.8 | 1806.0 | 1538.0 | - |
| 2 | 2 | 19 | 69.5 | 1117.0 | 1649.0 | - |
| 3 | 1 | 19 | 51.9 | 1651.0 | - | - |
| 4 | 3 | 19 | 84.6 | 1976.0 | 1032.0 | 1271.0 |
| 5 | 3 | 19 | 95.4 | 1060.0 | 1903.0 | 1388.0 |
| 6 | 2 | 19 | 68.0 | 1368.0 | 1351.0 | - |
| 7 | 3 | 19 | 89.6 | 1338.0 | 1514.0 | 1573.0 |
| 8 | 2 | 19 | 81.9 | 1022.0 | 1689.0 | - |
| 9 | 3 | 19 | 88.3 | 1810.0 | 1330.0 | 1838.0 |
| 10 | 1 | 19 | 53.7 | 1597.0 | - | - |
| 11 | 3 | 19 | 91.3 | 1961.0 | 1106.0 | 1001.0 |
| 12 | | | | | | |
| 13 | | | | | | |
| 14 | | | | | | |
| 15 | | | | | | |
| 16 | | | | | | |
| 17 | | | | | | |
| 18 | | | | | | |
| 19 | | | | | | |
| 20 | | | | | | |

Long Pulse Radar Test Signal

Test Signal Name: LP_Signal_04

Number of Bursts in Trial: 20

Chrip Center Frequency: 5530.0MHz

| Burst | Pulses per Burst | Chirp (MHz) | Pulse Width(us) | PRI-1 (us) | PRI-2 (us) | PRI-3 (us) |
|-------|------------------|-------------|-----------------|------------|------------|------------|
| 1 | 2 | 14 | 68.1 | 1339.0 | 1355.0 | - |
| 2 | 1 | 14 | 58.7 | 1251.0 | - | - |
| 3 | 2 | 14 | 75.3 | 1136.0 | 1640.0 | - |
| 4 | 1 | 14 | 56.4 | 1753.0 | - | - |
| 5 | 3 | 14 | 99.7 | 1196.0 | 1708.0 | 1159.0 |
| 6 | 1 | 14 | 57.7 | 1013.0 | - | - |
| 7 | 1 | 14 | 59.5 | 1072.0 | - | - |
| 8 | 2 | 14 | 80.0 | 1482.0 | 1369.0 | - |
| 9 | 2 | 14 | 82.0 | 1993.0 | 1197.0 | - |
| 10 | 2 | 14 | 82.8 | 1883.0 | 1005.0 | - |
| 11 | 3 | 14 | 88.0 | 1061.0 | 1928.0 | 1101.0 |
| 12 | 3 | 14 | 93.2 | 1207.0 | 1907.0 | 1223.0 |
| 13 | 2 | 14 | 70.4 | 1526.0 | 1360.0 | - |
| 14 | 3 | 14 | 95.3 | 1171.0 | 1955.0 | 1775.0 |
| 15 | 2 | 14 | 81.9 | 1690.0 | 1545.0 | - |
| 16 | 3 | 14 | 98.5 | 1975.0 | 1169.0 | 1062.0 |
| 17 | 1 | 14 | 65.0 | 1767.0 | - | - |
| 18 | 3 | 14 | 85.4 | 1011.0 | 1637.0 | 1425.0 |
| 19 | 3 | 14 | 91.6 | 1878.0 | 1445.0 | 1325.0 |
| 20 | 2 | 14 | 67.3 | 1091.0 | 1218.0 | - |

Long Pulse Radar Test Signal

Test Signal Name: LP_Signal_05

Number of Bursts in Trial: 17

Chirp Center Frequency: 5530.0MHz

| Burst | Pulses per Burst | Chirp (MHz) | Pulse Width(us) | PRI-1 (us) | PRI-2 (us) | PRI-3 (us) |
|-------|------------------|-------------|-----------------|------------|------------|------------|
| 1 | 2 | 9 | 67.9 | 1320.0 | 1133.0 | - |
| 2 | 1 | 9 | 62.3 | 1957.0 | - | - |
| 3 | 1 | 9 | 53.3 | 1592.0 | - | - |
| 4 | 3 | 9 | 90.0 | 1900.0 | 1153.0 | 1346.0 |
| 5 | 2 | 9 | 77.1 | 1166.0 | 1646.0 | - |
| 6 | 3 | 9 | 83.9 | 1278.0 | 1232.0 | 1459.0 |
| 7 | 3 | 9 | 89.1 | 1240.0 | 1384.0 | 1939.0 |
| 8 | 2 | 9 | 81.8 | 1833.0 | 1676.0 | - |
| 9 | 1 | 9 | 50.3 | 1075.0 | - | - |
| 10 | 3 | 9 | 87.1 | 1116.0 | 1996.0 | 1756.0 |
| 11 | 2 | 9 | 71.3 | 1225.0 | 1815.0 | - |
| 12 | 3 | 9 | 97.5 | 1884.0 | 1465.0 | 1132.0 |
| 13 | 3 | 9 | 90.6 | 1561.0 | 1040.0 | 1354.0 |
| 14 | 3 | 9 | 86.3 | 1596.0 | 1183.0 | 1792.0 |
| 15 | 3 | 9 | 97.6 | 1365.0 | 1073.0 | 1361.0 |
| 16 | 3 | 9 | 84.7 | 1021.0 | 1718.0 | 1854.0 |
| 17 | 3 | 9 | 99.7 | 1150.0 | 1244.0 | 1988.0 |
| 18 | | | | | | |
| 19 | | | | | | |
| 20 | | | | | | |

Long Pulse Radar Test Signal

Test Signal Name: LP_Signal_06

Number of Bursts in Trial: 14

Chrip Center Frequency: 5530.0MHz

| Burst | Pulses per Burst | Chirp (MHz) | Pulse Width(us) | PRI-1 (us) | PRI-2 (us) | PRI-3 (us) |
|-------|------------------|-------------|-----------------|------------|------------|------------|
| 1 | 3 | 14 | 92.9 | 1085.0 | 1564.0 | 1407.0 |
| 2 | 2 | 14 | 67.7 | 1744.0 | 1747.0 | - |
| 3 | 1 | 14 | 65.8 | 1092.0 | - | - |
| 4 | 1 | 14 | 56.3 | 1851.0 | - | - |
| 5 | 1 | 14 | 53.7 | 1727.0 | - | - |
| 6 | 3 | 14 | 83.5 | 1679.0 | 1930.0 | 1025.0 |
| 7 | 1 | 14 | 65.8 | 1519.0 | - | - |
| 8 | 3 | 14 | 85.9 | 1134.0 | 1034.0 | 1808.0 |
| 9 | 2 | 14 | 76.3 | 1606.0 | 1926.0 | - |
| 10 | 2 | 14 | 81.5 | 1891.0 | 1714.0 | - |
| 11 | 3 | 14 | 89.4 | 1310.0 | 1594.0 | 1827.0 |
| 12 | 1 | 14 | 63.4 | 1568.0 | - | - |
| 13 | 2 | 14 | 69.6 | 1307.0 | 1925.0 | - |
| 14 | 2 | 14 | 74.5 | 1264.0 | 1846.0 | - |
| 15 | | | | | | |
| 16 | | | | | | |
| 17 | | | | | | |
| 18 | | | | | | |
| 19 | | | | | | |
| 20 | | | | | | |

Long Pulse Radar Test Signal

Test Signal Name: LP_Signal_07

Number of Bursts in Trial: 15

Chrip Center Frequency: 5530.0MHz

| Burst | Pulses per Burst | Chirp (MHz) | Pulse Width(us) | PRI-1 (us) | PRI-2 (us) | PRI-3 (us) |
|-------|------------------|-------------|-----------------|------------|------------|------------|
| 1 | 3 | 9 | 96.6 | 1182.0 | 1609.0 | 1581.0 |
| 2 | 3 | 9 | 96.7 | 1829.0 | 1799.0 | 1154.0 |
| 3 | 3 | 9 | 86.5 | 1923.0 | 1396.0 | 1865.0 |
| 4 | 2 | 9 | 73.3 | 1908.0 | 1318.0 | - |
| 5 | 1 | 9 | 55.8 | 1688.0 | - | - |
| 6 | 1 | 9 | 55.4 | 1145.0 | - | - |
| 7 | 3 | 9 | 85.3 | 1336.0 | 1504.0 | 1820.0 |
| 8 | 2 | 9 | 79.4 | 1344.0 | 1893.0 | - |
| 9 | 1 | 9 | 65.7 | 1476.0 | - | - |
| 10 | 2 | 9 | 68.6 | 1008.0 | 1028.0 | - |
| 11 | 2 | 9 | 77.7 | 1972.0 | 1835.0 | - |
| 12 | 2 | 9 | 79.6 | 1882.0 | 1331.0 | - |
| 13 | 3 | 9 | 94.9 | 1830.0 | 1070.0 | 1349.0 |
| 14 | 1 | 9 | 61.4 | 1451.0 | - | - |
| 15 | 3 | 9 | 90.6 | 1233.0 | 1562.0 | 1887.0 |
| 16 | | | | | | |
| 17 | | | | | | |
| 18 | | | | | | |
| 19 | | | | | | |
| 20 | | | | | | |

Long Pulse Radar Test Signal

Test Signal Name: LP_Signal_08

Number of Bursts in Trial: 12

Chrip Center Frequency: 5530.0MHz

| Burst | Pulses per Burst | Chirp (MHz) | Pulse Width(us) | PRI-1 (us) | PRI-2 (us) | PRI-3 (us) |
|-------|------------------|-------------|-----------------|------------|------------|------------|
| 1 | 1 | 20 | 52.6 | 1210.0 | - | - |
| 2 | 3 | 20 | 84.1 | 1314.0 | 1725.0 | 1529.0 |
| 3 | 3 | 20 | 97.7 | 1139.0 | 1868.0 | 1805.0 |
| 4 | 3 | 20 | 97.3 | 1341.0 | 1446.0 | 1755.0 |
| 5 | 3 | 20 | 98.8 | 1544.0 | 1386.0 | 1302.0 |
| 6 | 2 | 20 | 72.2 | 1771.0 | 1184.0 | - |
| 7 | 2 | 20 | 67.6 | 1175.0 | 1027.0 | - |
| 8 | 2 | 20 | 75.7 | 1026.0 | 1871.0 | - |
| 9 | 1 | 20 | 60.9 | 1798.0 | - | - |
| 10 | 1 | 20 | 64.2 | 1138.0 | - | - |
| 11 | 2 | 20 | 78.8 | 1784.0 | 1604.0 | - |
| 12 | 3 | 20 | 87.5 | 1511.0 | 1712.0 | 1683.0 |
| 13 | | | | | | |
| 14 | | | | | | |
| 15 | | | | | | |
| 16 | | | | | | |
| 17 | | | | | | |
| 18 | | | | | | |
| 19 | | | | | | |
| 20 | | | | | | |

Long Pulse Radar Test Signal

Test Signal Name: LP_Signal_09

Number of Bursts in Trial: 14

Chrip Center Frequency: 5530.0MHz

| Burst | Pulses per Burst | Chrip (MHz) | Pulse Width(us) | PRI-1 (us) | PRI-2 (us) | PRI-3 (us) |
|-------|------------------|-------------|-----------------|------------|------------|------------|
| 1 | 1 | 6 | 54.1 | 1415.0 | - | - |
| 2 | 1 | 6 | 50.7 | 1221.0 | - | - |
| 3 | 1 | 6 | 52.3 | 1974.0 | - | - |
| 4 | 3 | 6 | 99.8 | 1558.0 | 1696.0 | 1949.0 |
| 5 | 2 | 6 | 68.4 | 1014.0 | 1099.0 | - |
| 6 | 2 | 6 | 80.8 | 1736.0 | 1505.0 | - |
| 7 | 1 | 6 | 62.5 | 1778.0 | - | - |
| 8 | 2 | 6 | 74.8 | 1149.0 | 1204.0 | - |
| 9 | 1 | 6 | 50.8 | 1049.0 | - | - |
| 10 | 1 | 6 | 54.0 | 1417.0 | - | - |
| 11 | 1 | 6 | 63.0 | 1730.0 | - | - |
| 12 | 3 | 6 | 91.8 | 1143.0 | 1270.0 | 1347.0 |
| 13 | 2 | 6 | 79.3 | 1274.0 | 1992.0 | - |
| 14 | 1 | 6 | 64.3 | 1937.0 | - | - |
| 15 | | | | | | |
| 16 | | | | | | |
| 17 | | | | | | |
| 18 | | | | | | |
| 19 | | | | | | |
| 20 | | | | | | |

Long Pulse Radar Test Signal

Test Signal Name: LP_Signal_10

Number of Bursts in Trial: 8

Chrip Center Frequency: 5530.0MHz

| Burst | Pulses per Burst | Chrip (MHz) | Pulse Width(us) | PRI-1 (us) | PRI-2 (us) | PRI-3 (us) |
|-------|------------------|-------------|-----------------|------------|------------|------------|
| 1 | 1 | 19 | 63.4 | 1043.0 | - | - |
| 2 | 1 | 19 | 52.0 | 1863.0 | - | - |
| 3 | 3 | 19 | 97.2 | 1973.0 | 1605.0 | 1583.0 |
| 4 | 2 | 19 | 78.7 | 1466.0 | 1743.0 | - |
| 5 | 2 | 19 | 74.2 | 1280.0 | 1219.0 | - |
| 6 | 3 | 19 | 88.7 | 1293.0 | 1934.0 | 1273.0 |
| 7 | 1 | 19 | 54.3 | 1991.0 | - | - |
| 8 | 3 | 19 | 95.4 | 1580.0 | 1555.0 | 1791.0 |
| 9 | | | | | | |
| 10 | | | | | | |
| 11 | | | | | | |
| 12 | | | | | | |
| 13 | | | | | | |
| 14 | | | | | | |
| 15 | | | | | | |
| 16 | | | | | | |
| 17 | | | | | | |
| 18 | | | | | | |
| 19 | | | | | | |
| 20 | | | | | | |

Long Pulse Radar Test Signal

Test Signal Name: LP_Signal_11

Number of Bursts in Trial: 17

Chrip Center Frequency: 5498.88MHz

| Burst | Pulses per Burst | Chirp (MHz) | Pulse Width(us) | PRI-1 (us) | PRI-2 (us) | PRI-3 (us) |
|-------|------------------|-------------|-----------------|------------|------------|------------|
| 1 | 2 | 19 | 73.7 | 1208.0 | 1497.0 | - |
| 2 | 3 | 19 | 97.4 | 1942.0 | 1754.0 | 1613.0 |
| 3 | 3 | 19 | 91.7 | 1999.0 | 1702.0 | 1462.0 |
| 4 | 1 | 19 | 66.2 | 1393.0 | - | - |
| 5 | 2 | 19 | 70.8 | 1968.0 | 1821.0 | - |
| 6 | 1 | 19 | 52.3 | 1740.0 | - | - |
| 7 | 2 | 19 | 78.9 | 1308.0 | 1984.0 | - |
| 8 | 2 | 19 | 70.9 | 1050.0 | 1358.0 | - |
| 9 | 2 | 19 | 75.6 | 1437.0 | 1430.0 | - |
| 10 | 1 | 19 | 59.1 | 1697.0 | - | - |
| 11 | 2 | 19 | 77.0 | 1397.0 | 1304.0 | - |
| 12 | 2 | 19 | 67.9 | 1803.0 | 1083.0 | - |
| 13 | 2 | 19 | 81.2 | 1720.0 | 1932.0 | - |
| 14 | 2 | 19 | 78.7 | 1247.0 | 1121.0 | - |
| 15 | 1 | 19 | 63.3 | 1634.0 | - | - |
| 16 | 2 | 19 | 68.9 | 1849.0 | 1423.0 | - |
| 17 | 1 | 19 | 59.3 | 1093.0 | - | - |
| 18 | | | | | | |
| 19 | | | | | | |
| 20 | | | | | | |

Long Pulse Radar Test Signal

Test Signal Name: LP_Signal_12

Number of Bursts in Trial: 19

Chrip Center Frequency: 5496.08MHz

| Burst | Pulses per Burst | Chrip (MHz) | Pulse Width(us) | PRI-1 (us) | PRI-2 (us) | PRI-3 (us) |
|-------|------------------|-------------|-----------------|------------|------------|------------|
| 1 | 3 | 12 | 98.9 | 1381.0 | 1680.0 | 1488.0 |
| 2 | 2 | 12 | 82.3 | 1716.0 | 1855.0 | - |
| 3 | 3 | 12 | 86.7 | 1211.0 | 1400.0 | 1919.0 |
| 4 | 3 | 12 | 89.7 | 1861.0 | 1068.0 | 1282.0 |
| 5 | 3 | 12 | 98.6 | 1507.0 | 1194.0 | 1461.0 |
| 6 | 2 | 12 | 71.1 | 1921.0 | 1789.0 | - |
| 7 | 1 | 12 | 55.9 | 1947.0 | - | - |
| 8 | 2 | 12 | 67.9 | 1350.0 | 1372.0 | - |
| 9 | 3 | 12 | 84.4 | 1203.0 | 1107.0 | 1443.0 |
| 10 | 1 | 12 | 58.8 | 1715.0 | - | - |
| 11 | 1 | 12 | 65.6 | 1017.0 | - | - |
| 12 | 2 | 12 | 78.5 | 1911.0 | 1704.0 | - |
| 13 | 2 | 12 | 82.3 | 1845.0 | 1686.0 | - |
| 14 | 3 | 12 | 90.1 | 1938.0 | 1071.0 | 1266.0 |
| 15 | 3 | 12 | 90.2 | 1989.0 | 1089.0 | 1950.0 |
| 16 | 2 | 12 | 83.1 | 1943.0 | 1406.0 | - |
| 17 | 1 | 12 | 58.8 | 1742.0 | - | - |
| 18 | 2 | 12 | 77.0 | 1187.0 | 1657.0 | - |
| 19 | 1 | 12 | 55.0 | 1012.0 | - | - |
| 20 | | | | | | |

Long Pulse Radar Test Signal

Test Signal Name: LP_Signal_13

Number of Bursts in Trial: 15

Chrip Center Frequency: 5498.48MHz

| Burst | Pulses per Burst | Chrip (MHz) | Pulse Width(us) | PRI-1 (us) | PRI-2 (us) | PRI-3 (us) |
|-------|------------------|-------------|-----------------|------------|------------|------------|
| 1 | 1 | 18 | 58.1 | 1929.0 | - | - |
| 2 | 1 | 18 | 52.1 | 1910.0 | - | - |
| 3 | 1 | 18 | 59.9 | 1971.0 | - | - |
| 4 | 1 | 18 | 60.2 | 1812.0 | - | - |
| 5 | 3 | 18 | 95.9 | 1399.0 | 1906.0 | 1608.0 |
| 6 | 2 | 18 | 79.9 | 1626.0 | 1859.0 | - |
| 7 | 2 | 18 | 78.5 | 1238.0 | 1917.0 | - |
| 8 | 1 | 18 | 53.8 | 1763.0 | - | - |
| 9 | 1 | 18 | 64.7 | 1800.0 | - | - |
| 10 | 1 | 18 | 61.4 | 1390.0 | - | - |
| 11 | 2 | 18 | 83.2 | 1692.0 | 1858.0 | - |
| 12 | 3 | 18 | 84.7 | 1533.0 | 1677.0 | 1638.0 |
| 13 | 3 | 18 | 88.7 | 1703.0 | 1528.0 | 1058.0 |
| 14 | 2 | 18 | 78.3 | 1258.0 | 1951.0 | - |
| 15 | 2 | 18 | 69.3 | 1731.0 | 1717.0 | - |
| 16 | | | | | | |
| 17 | | | | | | |
| 18 | | | | | | |
| 19 | | | | | | |
| 20 | | | | | | |

Long Pulse Radar Test Signal

Test Signal Name: LP_Signal_14

Number of Bursts in Trial: 12

Chrip Center Frequency: 5494.08MHz

| Burst | Pulses per Burst | Chrip (MHz) | Pulse Width(us) | PRI-1 (us) | PRI-2 (us) | PRI-3 (us) |
|-------|------------------|-------------|-----------------|------------|------------|------------|
| 1 | 2 | 7 | 75.3 | 1994.0 | 1612.0 | - |
| 2 | 1 | 7 | 56.3 | 1456.0 | - | - |
| 3 | 2 | 7 | 67.7 | 1617.0 | 1185.0 | - |
| 4 | 1 | 7 | 55.6 | 1337.0 | - | - |
| 5 | 2 | 7 | 75.2 | 1421.0 | 1267.0 | - |
| 6 | 2 | 7 | 76.3 | 1359.0 | 1305.0 | - |
| 7 | 3 | 7 | 85.7 | 1547.0 | 1362.0 | 1924.0 |
| 8 | 3 | 7 | 98.4 | 1873.0 | 1550.0 | 1249.0 |
| 9 | 3 | 7 | 86.4 | 1779.0 | 1439.0 | 1046.0 |
| 10 | 3 | 7 | 93.6 | 1059.0 | 1031.0 | 1452.0 |
| 11 | 1 | 7 | 63.3 | 1328.0 | - | - |
| 12 | 3 | 7 | 92.4 | 1412.0 | 1673.0 | 1322.0 |
| 13 | | | | | | |
| 14 | | | | | | |
| 15 | | | | | | |
| 16 | | | | | | |
| 17 | | | | | | |
| 18 | | | | | | |
| 19 | | | | | | |
| 20 | | | | | | |

Long Pulse Radar Test Signal

Test Signal Name: LP_Signal_15

Number of Bursts in Trial: 19

Chrip Center Frequency: 5494.88 MHz

| Burst | Pulses per Burst | Chrip (MHz) | Pulse Width(us) | PRI-1 (us) | PRI-2 (us) | PRI-3 (us) |
|-------|------------------|-------------|-----------------|------------|------------|------------|
| 1 | 3 | 9 | 93.3 | 1983.0 | 1912.0 | 1535.0 |
| 2 | 2 | 9 | 69.1 | 1102.0 | 1794.0 | - |
| 3 | 3 | 9 | 86.9 | 1044.0 | 1152.0 | 1148.0 |
| 4 | 3 | 9 | 84.9 | 1894.0 | 1948.0 | 1118.0 |
| 5 | 2 | 9 | 72.3 | 1094.0 | 1916.0 | - |
| 6 | 1 | 9 | 51.7 | 1447.0 | - | - |
| 7 | 1 | 9 | 58.3 | 1429.0 | - | - |
| 8 | 1 | 9 | 60.8 | 1979.0 | - | - |
| 9 | 1 | 9 | 57.1 | 1641.0 | - | - |
| 10 | 3 | 9 | 88.9 | 1886.0 | 1964.0 | 1489.0 |
| 11 | 2 | 9 | 72.0 | 1909.0 | 1297.0 | - |
| 12 | 3 | 9 | 90.9 | 1261.0 | 1566.0 | 1370.0 |
| 13 | 1 | 9 | 59.8 | 1552.0 | - | - |
| 14 | 2 | 9 | 70.0 | 1759.0 | 1291.0 | - |
| 15 | 2 | 9 | 67.2 | 1625.0 | 1881.0 | - |
| 16 | 3 | 9 | 91.2 | 1382.0 | 1832.0 | 1661.0 |
| 17 | 1 | 9 | 56.5 | 1483.0 | - | - |
| 18 | 1 | 9 | 51.2 | 1237.0 | - | - |
| 19 | 2 | 9 | 74.1 | 1471.0 | 1245.0 | - |
| 20 | | | | | | |

Long Pulse Radar Test Signal

Test Signal Name: LP_Signal_16

Number of Bursts in Trial: 14

Chrip Center Frequency: 5497.28 MHz

| Burst | Pulses per Burst | Chrip (MHz) | Pulse Width(us) | PRI-1 (us) | PRI-2 (us) | PRI-3 (us) |
|-------|------------------|-------------|-----------------|------------|------------|------------|
| 1 | 2 | 15 | 76.9 | 1110.0 | 1140.0 | - |
| 2 | 1 | 15 | 50.2 | 1316.0 | - | - |
| 3 | 1 | 15 | 62.9 | 1520.0 | - | - |
| 4 | 1 | 15 | 64.7 | 1902.0 | - | - |
| 5 | 3 | 15 | 83.8 | 1410.0 | 1097.0 | 1621.0 |
| 6 | 1 | 15 | 65.4 | 1944.0 | - | - |
| 7 | 1 | 15 | 53.2 | 1024.0 | - | - |
| 8 | 1 | 15 | 51.7 | 1603.0 | - | - |
| 9 | 2 | 15 | 78.7 | 1804.0 | 1168.0 | - |
| 10 | 2 | 15 | 72.4 | 1030.0 | 1343.0 | - |
| 11 | 1 | 15 | 53.8 | 1327.0 | - | - |
| 12 | 2 | 15 | 73.6 | 1524.0 | 1553.0 | - |
| 13 | 2 | 15 | 66.7 | 1722.0 | 1122.0 | - |
| 14 | 2 | 15 | 82.5 | 1404.0 | 1019.0 | - |
| 15 | | | | | | |
| 16 | | | | | | |
| 17 | | | | | | |
| 18 | | | | | | |
| 19 | | | | | | |
| 20 | | | | | | |

Long Pulse Radar Test Signal

Test Signal Name: LP_Signal_17

Number of Bursts in Trial: 20

Chrip Center Frequency: 5497.28MHz

| Burst | Pulses per Burst | Chrip (MHz) | Pulse Width(us) | PRI-1 (us) | PRI-2 (us) | PRI-3 (us) |
|-------|------------------|-------------|-----------------|------------|------------|------------|
| 1 | 3 | 15 | 87.6 | 1565.0 | 1055.0 | 1840.0 |
| 2 | 3 | 15 | 85.2 | 1735.0 | 1541.0 | 1408.0 |
| 3 | 3 | 15 | 84.8 | 1534.0 | 1889.0 | 1463.0 |
| 4 | 2 | 15 | 77.9 | 1749.0 | 1460.0 | - |
| 5 | 2 | 15 | 76.5 | 1518.0 | 1485.0 | - |
| 6 | 1 | 15 | 60.9 | 1540.0 | - | - |
| 7 | 2 | 15 | 83.0 | 1080.0 | 1010.0 | - |
| 8 | 2 | 15 | 80.4 | 1824.0 | 1752.0 | - |
| 9 | 2 | 15 | 67.5 | 1764.0 | 1181.0 | - |
| 10 | 1 | 15 | 62.1 | 1495.0 | - | - |
| 11 | 3 | 15 | 86.4 | 1773.0 | 1966.0 | 1263.0 |
| 12 | 3 | 15 | 84.3 | 1593.0 | 1188.0 | 1788.0 |
| 13 | 2 | 15 | 76.9 | 1226.0 | 1537.0 | - |
| 14 | 3 | 15 | 95.8 | 1192.0 | 1298.0 | 1844.0 |
| 15 | 1 | 15 | 55.2 | 1644.0 | - | - |
| 16 | 1 | 15 | 59.0 | 1402.0 | - | - |
| 17 | 3 | 15 | 94.5 | 1296.0 | 1700.0 | 1283.0 |
| 18 | 3 | 15 | 91.9 | 1970.0 | 1978.0 | 1165.0 |
| 19 | 3 | 15 | 85.2 | 1732.0 | 1551.0 | 1189.0 |
| 20 | 2 | 15 | 69.5 | 1038.0 | 1224.0 | - |

Long Pulse Radar Test Signal

Test Signal Name: LP_Signal_18

Number of Bursts in Trial: 12

Chrip Center Frequency: 5496.88MHz

| Burst | Pulses per Burst | Chrip (MHz) | Pulse Width(us) | PRI-1 (us) | PRI-2 (us) | PRI-3 (us) |
|-------|------------------|-------------|-----------------|------------|------------|------------|
| 1 | 3 | 14 | 86.4 | 1259.0 | 1918.0 | 1455.0 |
| 2 | 3 | 14 | 92.2 | 1598.0 | 1719.0 | 1895.0 |
| 3 | 2 | 14 | 80.4 | 1816.0 | 1899.0 | - |
| 4 | 1 | 14 | 54.3 | 1335.0 | - | - |
| 5 | 1 | 14 | 53.1 | 1303.0 | - | - |
| 6 | 2 | 14 | 69.4 | 1503.0 | 1546.0 | - |
| 7 | 2 | 14 | 69.1 | 1279.0 | 1639.0 | - |
| 8 | 3 | 14 | 100.0 | 1375.0 | 1438.0 | 1595.0 |
| 9 | 2 | 14 | 79.6 | 1239.0 | 1705.0 | - |
| 10 | 3 | 14 | 88.4 | 1374.0 | 1579.0 | 1623.0 |
| 11 | 1 | 14 | 53.3 | 1016.0 | - | - |
| 12 | 1 | 14 | 65.3 | 1709.0 | - | - |
| 13 | | | | | | |
| 14 | | | | | | |
| 15 | | | | | | |
| 16 | | | | | | |
| 17 | | | | | | |
| 18 | | | | | | |
| 19 | | | | | | |
| 20 | | | | | | |

Long Pulse Radar Test Signal

Test Signal Name: LP_Signal_19

Number of Bursts in Trial: 14

Chrip Center Frequency: 5498.88MHz

| Burst | Pulses per Burst | Chrip (MHz) | Pulse Width(us) | PRI-1 (us) | PRI-2 (us) | PRI-3 (us) |
|-------|------------------|-------------|-----------------|------------|------------|------------|
| 1 | 1 | 19 | 55.3 | 1920.0 | - | - |
| 2 | 1 | 19 | 58.3 | 1797.0 | - | - |
| 3 | 2 | 19 | 72.3 | 1610.0 | 1039.0 | - |
| 4 | 3 | 19 | 84.8 | 1131.0 | 1761.0 | 1721.0 |
| 5 | 2 | 19 | 82.5 | 1875.0 | 1431.0 | - |
| 6 | 1 | 19 | 63.3 | 1095.0 | - | - |
| 7 | 2 | 19 | 80.0 | 1119.0 | 1913.0 | - |
| 8 | 3 | 19 | 90.3 | 1660.0 | 1853.0 | 1123.0 |
| 9 | 3 | 19 | 91.1 | 1539.0 | 1783.0 | 1172.0 |
| 10 | 3 | 19 | 96.6 | 1525.0 | 1036.0 | 1385.0 |
| 11 | 2 | 19 | 82.7 | 1710.0 | 1990.0 | - |
| 12 | 1 | 19 | 50.7 | 1234.0 | - | - |
| 13 | 2 | 19 | 78.4 | 1047.0 | 1109.0 | - |
| 14 | 3 | 19 | 99.5 | 1299.0 | 1965.0 | 1869.0 |
| 15 | | | | | | |
| 16 | | | | | | |
| 17 | | | | | | |
| 18 | | | | | | |
| 19 | | | | | | |
| 20 | | | | | | |

Long Pulse Radar Test Signal
 Test Signal Name: LP_Signal_20
 Number of Bursts in Trial: 12
 Chrip Center Frequency: 5498.08MHz

| Burst | Pulses per Burst | Chirp (MHz) | Pulse Width(us) | PRI-1 (us) | PRI-2 (us) | PRI-3 (us) |
|-------|------------------|-------------|-----------------|------------|------------|------------|
| 1 | 3 | 17 | 88.6 | 1501.0 | 1067.0 | 1927.0 |
| 2 | 1 | 17 | 57.4 | 1723.0 | - | - |
| 3 | 3 | 17 | 96.6 | 1086.0 | 1658.0 | 1324.0 |
| 4 | 2 | 17 | 69.7 | 1751.0 | 1945.0 | - |
| 5 | 2 | 17 | 77.9 | 1642.0 | 1317.0 | - |
| 6 | 1 | 17 | 62.0 | 1866.0 | - | - |
| 7 | 3 | 17 | 88.4 | 1997.0 | 1077.0 | 1366.0 |
| 8 | 3 | 17 | 97.3 | 1790.0 | 1896.0 | 1367.0 |
| 9 | 3 | 17 | 96.2 | 1391.0 | 1787.0 | 1672.0 |
| 10 | 3 | 17 | 95.4 | 1020.0 | 1892.0 | 1414.0 |
| 11 | 1 | 17 | 54.8 | 1084.0 | - | - |
| 12 | 2 | 17 | 80.4 | 1850.0 | 1436.0 | - |
| 13 | | | | | | |
| 14 | | | | | | |
| 15 | | | | | | |
| 16 | | | | | | |
| 17 | | | | | | |
| 18 | | | | | | |
| 19 | | | | | | |
| 20 | | | | | | |

Long Pulse Radar Test Signal

Test Signal Name: LP_Signal_21

Number of Bursts in Trial: 16

Chrip Center Frequency: 5566.72MHz

| Burst | Pulses per Burst | Chrip (MHz) | Pulse Width(us) | PRI-1 (us) | PRI-2 (us) | PRI-3 (us) |
|-------|------------------|-------------|-----------------|------------|------------|------------|
| 1 | 2 | 5 | 74.7 | 1619.0 | 1611.0 | - |
| 2 | 1 | 5 | 57.1 | 1560.0 | - | - |
| 3 | 3 | 5 | 91.9 | 1392.0 | 1475.0 | 1276.0 |
| 4 | 2 | 5 | 83.1 | 1809.0 | 1772.0 | - |
| 5 | 1 | 5 | 50.7 | 1003.0 | - | - |
| 6 | 2 | 5 | 79.2 | 1574.0 | 1600.0 | - |
| 7 | 1 | 5 | 58.7 | 1186.0 | - | - |
| 8 | 2 | 5 | 71.0 | 1521.0 | 1567.0 | - |
| 9 | 2 | 5 | 79.0 | 1777.0 | 1960.0 | - |
| 10 | 2 | 5 | 68.5 | 1284.0 | 1428.0 | - |
| 11 | 2 | 5 | 73.5 | 1904.0 | 1352.0 | - |
| 12 | 2 | 5 | 70.5 | 1864.0 | 1115.0 | - |
| 13 | 2 | 5 | 76.6 | 1045.0 | 1300.0 | - |
| 14 | 2 | 5 | 81.2 | 1160.0 | 1675.0 | - |
| 15 | 1 | 5 | 61.8 | 1277.0 | - | - |
| 16 | 3 | 5 | 94.9 | 1450.0 | 1206.0 | 1860.0 |
| 17 | | | | | | |
| 18 | | | | | | |
| 19 | | | | | | |
| 20 | | | | | | |

Long Pulse Radar Test Signal

Test Signal Name: LP_Signal_22

Number of Bursts in Trial: 12

Chrip Center Frequency: 5566.72MHz

| Burst | Pulses per Burst | Chrip (MHz) | Pulse Width(us) | PRI-1 (us) | PRI-2 (us) | PRI-3 (us) |
|-------|------------------|-------------|-----------------|------------|------------|------------|
| 1 | 2 | 5 | 78.5 | 1653.0 | 1698.0 | - |
| 2 | 3 | 5 | 89.8 | 1174.0 | 1962.0 | 1167.0 |
| 3 | 1 | 5 | 59.4 | 1982.0 | - | - |
| 4 | 2 | 5 | 79.6 | 1633.0 | 1890.0 | - |
| 5 | 2 | 5 | 76.0 | 1112.0 | 1811.0 | - |
| 6 | 1 | 5 | 53.6 | 1144.0 | - | - |
| 7 | 2 | 5 | 80.9 | 1220.0 | 1053.0 | - |
| 8 | 1 | 5 | 61.6 | 1724.0 | - | - |
| 9 | 1 | 5 | 53.4 | 1901.0 | - | - |
| 10 | 1 | 5 | 59.9 | 1379.0 | - | - |
| 11 | 1 | 5 | 60.4 | 1453.0 | - | - |
| 12 | 3 | 5 | 91.4 | 1768.0 | 1726.0 | 1227.0 |
| 13 | | | | | | |
| 14 | | | | | | |
| 15 | | | | | | |
| 16 | | | | | | |
| 17 | | | | | | |
| 18 | | | | | | |
| 19 | | | | | | |
| 20 | | | | | | |

Long Pulse Radar Test Signal

Test Signal Name: LP_Signal_23

Number of Bursts in Trial: 20

Chrip Center Frequency: 5563.52MHz

| Burst | Pulses per Burst | Chirp (MHz) | Pulse Width(us) | PRI-1 (us) | PRI-2 (us) | PRI-3 (us) |
|-------|------------------|-------------|-----------------|------------|------------|------------|
| 1 | 2 | 13 | 77.0 | 1191.0 | 1363.0 | - |
| 2 | 1 | 13 | 58.1 | 1248.0 | - | - |
| 3 | 1 | 13 | 62.1 | 1836.0 | - | - |
| 4 | 2 | 13 | 76.9 | 1334.0 | 1236.0 | - |
| 5 | 2 | 13 | 80.0 | 1914.0 | 1852.0 | - |
| 6 | 1 | 13 | 52.0 | 1701.0 | - | - |
| 7 | 3 | 13 | 88.6 | 1693.0 | 1995.0 | 1905.0 |
| 8 | 2 | 13 | 72.9 | 1922.0 | 1387.0 | - |
| 9 | 3 | 13 | 98.5 | 1839.0 | 1746.0 | 1389.0 |
| 10 | 1 | 13 | 57.9 | 1193.0 | - | - |
| 11 | 3 | 13 | 95.9 | 1659.0 | 1870.0 | 1066.0 |
| 12 | 1 | 13 | 53.5 | 1162.0 | - | - |
| 13 | 3 | 13 | 92.0 | 1745.0 | 1654.0 | 1458.0 |
| 14 | 1 | 13 | 57.3 | 1834.0 | - | - |
| 15 | 2 | 13 | 70.5 | 1684.0 | 1586.0 | - |
| 16 | 2 | 13 | 70.0 | 1042.0 | 1664.0 | - |
| 17 | 3 | 13 | 84.0 | 1765.0 | 1630.0 | 1176.0 |
| 18 | 2 | 13 | 76.1 | 1557.0 | 1057.0 | - |
| 19 | 3 | 13 | 93.2 | 1985.0 | 1018.0 | 1340.0 |
| 20 | 3 | 13 | 96.8 | 1760.0 | 1614.0 | 1817.0 |

Long Pulse Radar Test Signal

Test Signal Name: LP_Signal_24

Number of Bursts in Trial: 14

Chrip Center Frequency: 5565.92 MHz

| Burst | Pulses per Burst | Chrip (MHz) | Pulse Width(us) | PRI-1 (us) | PRI-2 (us) | PRI-3 (us) |
|-------|------------------|-------------|-----------------|------------|------------|------------|
| 1 | 1 | 7 | 50.1 | 1841.0 | - | - |
| 2 | 3 | 7 | 93.5 | 1590.0 | 1081.0 | 1413.0 |
| 3 | 2 | 7 | 68.8 | 1707.0 | 1577.0 | - |
| 4 | 1 | 7 | 56.3 | 1056.0 | - | - |
| 5 | 3 | 7 | 86.0 | 1953.0 | 1108.0 | 1987.0 |
| 6 | 2 | 7 | 75.2 | 1572.0 | 1536.0 | - |
| 7 | 1 | 7 | 54.4 | 1517.0 | - | - |
| 8 | 2 | 7 | 71.1 | 1329.0 | 1243.0 | - |
| 9 | 2 | 7 | 76.2 | 1940.0 | 1770.0 | - |
| 10 | 2 | 7 | 80.2 | 1098.0 | 1209.0 | - |
| 11 | 2 | 7 | 79.7 | 1588.0 | 1214.0 | - |
| 12 | 3 | 7 | 90.9 | 1615.0 | 1862.0 | 1601.0 |
| 13 | 2 | 7 | 68.7 | 1377.0 | 1441.0 | - |
| 14 | 2 | 7 | 67.4 | 1872.0 | 1313.0 | - |
| 15 | | | | | | |
| 16 | | | | | | |
| 17 | | | | | | |
| 18 | | | | | | |
| 19 | | | | | | |
| 20 | | | | | | |

Long Pulse Radar Test Signal

Test Signal Name: LP_Signal_25

Number of Bursts in Trial: 13

Chrip Center Frequency: 5563.12 MHz

| Burst | Pulses per Burst | Chrip (MHz) | Pulse Width(us) | PRI-1 (us) | PRI-2 (us) | PRI-3 (us) |
|-------|------------------|-------------|-----------------|------------|------------|------------|
| 1 | 3 | 14 | 94.0 | 1643.0 | 1748.0 | 1941.0 |
| 2 | 2 | 14 | 70.8 | 1177.0 | 1201.0 | - |
| 3 | 1 | 14 | 56.3 | 1006.0 | - | - |
| 4 | 3 | 14 | 96.7 | 1230.0 | 1163.0 | 1332.0 |
| 5 | 3 | 14 | 90.6 | 1217.0 | 1582.0 | 1498.0 |
| 6 | 2 | 14 | 74.5 | 1569.0 | 1281.0 | - |
| 7 | 3 | 14 | 92.6 | 1065.0 | 1669.0 | 1222.0 |
| 8 | 3 | 14 | 89.0 | 1493.0 | 1135.0 | 1380.0 |
| 9 | 3 | 14 | 96.5 | 1607.0 | 1822.0 | 1602.0 |
| 10 | 2 | 14 | 70.5 | 1141.0 | 1178.0 | - |
| 11 | 3 | 14 | 94.0 | 1009.0 | 1629.0 | 1956.0 |
| 12 | 1 | 14 | 55.8 | 1290.0 | - | - |
| 13 | 3 | 14 | 87.7 | 1435.0 | 1963.0 | 1164.0 |
| 14 | | | | | | |
| 15 | | | | | | |
| 16 | | | | | | |
| 17 | | | | | | |
| 18 | | | | | | |
| 19 | | | | | | |
| 20 | | | | | | |

Long Pulse Radar Test Signal

Test Signal Name: LP_Signal_26

Number of Bursts in Trial: 8

Chirp Center Frequency: 5564.72 MHz

| Burst | Pulses per Burst | Chirp (MHz) | Pulse Width(us) | PRI-1 (us) | PRI-2 (us) | PRI-3 (us) |
|-------|------------------|-------------|-----------------|------------|------------|------------|
| 1 | 2 | 10 | 68.6 | 1306.0 | 1161.0 | - |
| 2 | 2 | 10 | 83.1 | 1420.0 | 1315.0 | - |
| 3 | 1 | 10 | 60.9 | 1687.0 | - | - |
| 4 | 2 | 10 | 77.7 | 1776.0 | 1158.0 | - |
| 5 | 2 | 10 | 77.4 | 1793.0 | 1510.0 | - |
| 6 | 2 | 10 | 66.8 | 1576.0 | 1323.0 | - |
| 7 | 1 | 10 | 63.7 | 1333.0 | - | - |
| 8 | 3 | 10 | 91.2 | 1409.0 | 1681.0 | 1275.0 |
| 9 | | | | | | |
| 10 | | | | | | |
| 11 | | | | | | |
| 12 | | | | | | |
| 13 | | | | | | |
| 14 | | | | | | |
| 15 | | | | | | |
| 16 | | | | | | |
| 17 | | | | | | |
| 18 | | | | | | |
| 19 | | | | | | |
| 20 | | | | | | |

Long Pulse Radar Test Signal

Test Signal Name: LP_Signal_27

Number of Bursts in Trial: 17

Chrip Center Frequency: 5562.72 MHz

| Burst | Pulses per Burst | Chrip (MHz) | Pulse Width(us) | PRI-1 (us) | PRI-2 (us) | PRI-3 (us) |
|-------|------------------|-------------|-----------------|------------|------------|------------|
| 1 | 3 | 15 | 83.6 | 1632.0 | 1195.0 | 1000.0 |
| 2 | 3 | 15 | 89.4 | 1173.0 | 1627.0 | 1656.0 |
| 3 | 1 | 15 | 55.8 | 1532.0 | - | - |
| 4 | 3 | 15 | 90.9 | 1981.0 | 1554.0 | 1998.0 |
| 5 | 1 | 15 | 54.7 | 1825.0 | - | - |
| 6 | 3 | 15 | 97.7 | 1734.0 | 1202.0 | 1250.0 |
| 7 | 2 | 15 | 67.5 | 1571.0 | 1434.0 | - |
| 8 | 3 | 15 | 96.7 | 1589.0 | 1469.0 | 1268.0 |
| 9 | 2 | 15 | 68.3 | 1750.0 | 1954.0 | - |
| 10 | 2 | 15 | 78.3 | 1591.0 | 1082.0 | - |
| 11 | 1 | 15 | 55.0 | 1427.0 | - | - |
| 12 | 3 | 15 | 84.9 | 1129.0 | 1936.0 | 1199.0 |
| 13 | 2 | 15 | 74.6 | 1959.0 | 1856.0 | - |
| 14 | 1 | 15 | 63.3 | 1885.0 | - | - |
| 15 | 3 | 15 | 99.8 | 1035.0 | 1515.0 | 1120.0 |
| 16 | 1 | 15 | 63.6 | 1647.0 | - | - |
| 17 | 3 | 15 | 87.3 | 1931.0 | 1051.0 | 1831.0 |
| 18 | | | | | | |
| 19 | | | | | | |
| 20 | | | | | | |

Long Pulse Radar Test Signal

Test Signal Name: LP_Signal_28

Number of Bursts in Trial: 19

Chirp Center Frequency: 5565.12 MHz

| Burst | Pulses per Burst | Chirp (MHz) | Pulse Width(us) | PRI-1 (us) | PRI-2 (us) | PRI-3 (us) |
|-------|------------------|-------------|-----------------|------------|------------|------------|
| 1 | 3 | 9 | 85.6 | 1946.0 | 1078.0 | 1015.0 |
| 2 | 2 | 9 | 68.6 | 1029.0 | 1780.0 | - |
| 3 | 1 | 9 | 54.2 | 1111.0 | - | - |
| 4 | 1 | 9 | 61.2 | 1104.0 | - | - |
| 5 | 3 | 9 | 97.1 | 1157.0 | 1969.0 | 1100.0 |
| 6 | 3 | 9 | 98.3 | 1142.0 | 1699.0 | 1622.0 |
| 7 | 1 | 9 | 62.4 | 1655.0 | - | - |
| 8 | 2 | 9 | 80.2 | 1126.0 | 1769.0 | - |
| 9 | 3 | 9 | 87.5 | 1216.0 | 1448.0 | 1179.0 |
| 10 | 3 | 9 | 85.8 | 1847.0 | 1348.0 | 1472.0 |
| 11 | 3 | 9 | 88.1 | 1023.0 | 1124.0 | 1631.0 |
| 12 | 1 | 9 | 65.3 | 1848.0 | - | - |
| 13 | 1 | 9 | 52.5 | 1470.0 | - | - |
| 14 | 1 | 9 | 52.3 | 1312.0 | - | - |
| 15 | 2 | 9 | 74.1 | 1915.0 | 1200.0 | - |
| 16 | 1 | 9 | 54.9 | 1479.0 | - | - |
| 17 | 2 | 9 | 76.2 | 1376.0 | 1502.0 | - |
| 18 | 1 | 9 | 60.4 | 1758.0 | - | - |
| 19 | 2 | 9 | 81.5 | 1491.0 | 1103.0 | - |
| 20 | | | | | | |

Long Pulse Radar Test Signal

Test Signal Name: LP_Signal_29

Number of Bursts in Trial: 12

Chrip Center Frequency: 5566.72MHz

| Burst | Pulses per Burst | Chrip (MHz) | Pulse Width(us) | PRI-1 (us) | PRI-2 (us) | PRI-3 (us) |
|-------|------------------|-------------|-----------------|------------|------------|------------|
| 1 | 1 | 5 | 50.5 | 1857.0 | - | - |
| 2 | 1 | 5 | 55.7 | 1246.0 | - | - |
| 3 | 3 | 5 | 85.8 | 1774.0 | 1002.0 | 1967.0 |
| 4 | 2 | 5 | 76.9 | 1125.0 | 1474.0 | - |
| 5 | 2 | 5 | 75.1 | 1254.0 | 1052.0 | - |
| 6 | 3 | 5 | 92.3 | 1180.0 | 1486.0 | 1492.0 |
| 7 | 2 | 5 | 78.1 | 1301.0 | 1757.0 | - |
| 8 | 3 | 5 | 92.2 | 1898.0 | 1252.0 | 1713.0 |
| 9 | 3 | 5 | 89.0 | 1260.0 | 1706.0 | 1411.0 |
| 10 | 2 | 5 | 70.9 | 1578.0 | 1620.0 | - |
| 11 | 1 | 5 | 63.1 | 1782.0 | - | - |
| 12 | 1 | 5 | 55.3 | 1522.0 | - | - |
| 13 | | | | | | |
| 14 | | | | | | |
| 15 | | | | | | |
| 16 | | | | | | |
| 17 | | | | | | |
| 18 | | | | | | |
| 19 | | | | | | |

Long Pulse Radar Test Signal

Test Signal Name: LP_Signal_30

Number of Bursts in Trial: 18

Chrip Center Frequency: 5564.72MHz

| Burst | Pulses per Burst | Chirp (MHz) | Pulse Width(us) | PRI-1 (us) | PRI-2 (us) | PRI-3 (us) |
|-------|------------------|-------------|-----------------|------------|------------|------------|
| 1 | 3 | 10 | 83.4 | 1454.0 | 1205.0 | 1801.0 |
| 2 | 3 | 10 | 97.3 | 1319.0 | 1826.0 | 1635.0 |
| 3 | 3 | 10 | 90.4 | 1079.0 | 1986.0 | 1674.0 |
| 4 | 3 | 10 | 91.8 | 1563.0 | 1151.0 | 1802.0 |
| 5 | 3 | 10 | 98.2 | 1876.0 | 1977.0 | 1766.0 |
| 6 | 1 | 10 | 59.5 | 1952.0 | - | - |
| 7 | 2 | 10 | 80.0 | 1253.0 | 1137.0 | - |
| 8 | 3 | 10 | 86.5 | 1054.0 | 1128.0 | 1828.0 |
| 9 | 3 | 10 | 91.1 | 1105.0 | 1599.0 | 1442.0 |
| 10 | 3 | 10 | 93.5 | 1867.0 | 1373.0 | 1087.0 |
| 11 | 1 | 10 | 60.7 | 1033.0 | - | - |
| 12 | 2 | 10 | 67.2 | 1288.0 | 1405.0 | - |
| 13 | 1 | 10 | 61.8 | 1585.0 | - | - |
| 14 | 2 | 10 | 79.4 | 1933.0 | 1667.0 | - |
| 15 | 2 | 10 | 81.4 | 1096.0 | 1464.0 | - |
| 16 | 1 | 10 | 65.7 | 1496.0 | - | - |
| 17 | 2 | 10 | 76.0 | 1733.0 | 1255.0 | - |
| 18 | 2 | 10 | 81.0 | 1326.0 | 1668.0 | - |

A.2 The Frequency Hopping Radar pattern

802.11ax (HE20)

| Hopping Frequency Sequence Name: HOP_FREQ_SEQ_01 | | | | | | | |
|--------------------------------------------------|-----------------|------|-----------------|------|-----------------|------|-----------------|
| SEQ# | Frequency (GHz) | SEQ# | Frequency (GHz) | SEQ# | Frequency (GHz) | SEQ# | Frequency (GHz) |
| 1 | 5.505 | 2 | 5.674 | 3 | 5.257 | 4 | 5.690 |
| 5 | 5.520 | 6 | 5.262 | 7 | 5.356 | 8 | 5.439 |
| 9 | 5.685 | 10 | 5.332 | 11 | 5.720 | 12 | 5.579 |
| 13 | 5.313 | 14 | 5.383 | 15 | 5.697 | 16 | 5.318 |
| 17 | 5.695 | 18 | 5.461 | 19 | 5.719 | 20 | 5.606 |
| 21 | 5.533 | 22 | 5.287 | 23 | 5.675 | 24 | 5.540 |
| 25 | 5.604 | 26 | 5.591 | 27 | 5.564 | 28 | 5.612 |
| 29 | 5.399 | 30 | 5.593 | 31 | 5.600 | 32 | 5.478 |
| 33 | 5.667 | 34 | 5.434 | 35 | 5.299 | 36 | 5.387 |
| 37 | 5.319 | 38 | 5.376 | 39 | 5.710 | 40 | 5.581 |
| 41 | 5.624 | 42 | 5.302 | 43 | 5.406 | 44 | 5.272 |
| 45 | 5.531 | 46 | 5.298 | 47 | 5.303 | 48 | 5.265 |
| 49 | 5.688 | 50 | 5.372 | 51 | 5.699 | 52 | 5.550 |
| 53 | 5.336 | 54 | 5.308 | 55 | 5.565 | 56 | 5.269 |
| 57 | 5.635 | 58 | 5.650 | 59 | 5.357 | 60 | 5.462 |
| 61 | 5.389 | 62 | 5.626 | 63 | 5.411 | 64 | 5.386 |
| 65 | 5.665 | 66 | 5.481 | 67 | 5.354 | 68 | 5.267 |
| 69 | 5.279 | 70 | 5.558 | 71 | 5.578 | 72 | 5.647 |
| 73 | 5.717 | 74 | 5.382 | 75 | 5.297 | 76 | 5.601 |
| 77 | 5.630 | 78 | 5.603 | 79 | 5.676 | 80 | 5.657 |
| 81 | 5.608 | 82 | 5.329 | 83 | 5.388 | 84 | 5.602 |
| 85 | 5.549 | 86 | 5.451 | 87 | 5.709 | 88 | 5.716 |
| 89 | 5.643 | 90 | 5.285 | 91 | 5.377 | 92 | 5.443 |
| 93 | 5.535 | 94 | 5.584 | 95 | 5.506 | 96 | 5.723 |
| 97 | 5.507 | 98 | 5.712 | 99 | 5.680 | 100 | 5.724 |

Hopping Frequency Sequence Name: HOP_FREQ_SEQ_02

| SEQ# | Frequency (GHz) | SEQ# | Frequency (GHz) | SEQ# | Frequency (GHz) | SEQ# | Frequency (GHz) |
|------|-----------------|------|-----------------|------|-----------------|------|-----------------|
| 1 | 5.350 | 2 | 5.673 | 3 | 5.251 | 4 | 5.286 |
| 5 | 5.699 | 6 | 5.714 | 7 | 5.500 | 8 | 5.265 |
| 9 | 5.299 | 10 | 5.455 | 11 | 5.359 | 12 | 5.611 |
| 13 | 5.487 | 14 | 5.448 | 15 | 5.663 | 16 | 5.373 |
| 17 | 5.269 | 18 | 5.614 | 19 | 5.439 | 20 | 5.385 |
| 21 | 5.680 | 22 | 5.603 | 23 | 5.363 | 24 | 5.341 |
| 25 | 5.303 | 26 | 5.504 | 27 | 5.576 | 28 | 5.584 |
| 29 | 5.632 | 30 | 5.535 | 31 | 5.402 | 32 | 5.597 |
| 33 | 5.308 | 34 | 5.566 | 35 | 5.689 | 36 | 5.301 |
| 37 | 5.494 | 38 | 5.400 | 39 | 5.513 | 40 | 5.691 |
| 41 | 5.553 | 42 | 5.343 | 43 | 5.532 | 44 | 5.520 |
| 45 | 5.664 | 46 | 5.718 | 47 | 5.612 | 48 | 5.444 |
| 49 | 5.452 | 50 | 5.588 | 51 | 5.307 | 52 | 5.422 |
| 53 | 5.662 | 54 | 5.275 | 55 | 5.583 | 56 | 5.578 |
| 57 | 5.595 | 58 | 5.479 | 59 | 5.410 | 60 | 5.693 |
| 61 | 5.465 | 62 | 5.312 | 63 | 5.268 | 64 | 5.629 |
| 65 | 5.671 | 66 | 5.284 | 67 | 5.406 | 68 | 5.624 |
| 69 | 5.300 | 70 | 5.568 | 71 | 5.318 | 72 | 5.711 |
| 73 | 5.330 | 74 | 5.399 | 75 | 5.694 | 76 | 5.631 |
| 77 | 5.416 | 78 | 5.723 | 79 | 5.637 | 80 | 5.339 |
| 81 | 5.252 | 82 | 5.703 | 83 | 5.654 | 84 | 5.538 |
| 85 | 5.478 | 86 | 5.482 | 87 | 5.474 | 88 | 5.407 |
| 89 | 5.279 | 90 | 5.316 | 91 | 5.592 | 92 | 5.627 |
| 93 | 5.594 | 94 | 5.633 | 95 | 5.380 | 96 | 5.598 |
| 97 | 5.533 | 98 | 5.446 | 99 | 5.526 | 100 | 5.555 |

Hopping Frequency Sequence Name: HOP_FREQ_SEQ_03

| SEQ# | Frequency (GHz) | SEQ# | Frequency (GHz) | SEQ# | Frequency (GHz) | SEQ# | Frequency (GHz) |
|------|-----------------|------|-----------------|------|-----------------|------|-----------------|
| 1 | 5.501 | 2 | 5.592 | 3 | 5.263 | 4 | 5.484 |
| 5 | 5.549 | 6 | 5.346 | 7 | 5.361 | 8 | 5.576 |
| 9 | 5.264 | 10 | 5.700 | 11 | 5.623 | 12 | 5.324 |
| 13 | 5.640 | 14 | 5.669 | 15 | 5.344 | 16 | 5.579 |
| 17 | 5.703 | 18 | 5.585 | 19 | 5.382 | 20 | 5.601 |
| 21 | 5.364 | 22 | 5.296 | 23 | 5.524 | 24 | 5.532 |
| 25 | 5.546 | 26 | 5.555 | 27 | 5.710 | 28 | 5.644 |
| 29 | 5.465 | 30 | 5.456 | 31 | 5.526 | 32 | 5.627 |
| 33 | 5.621 | 34 | 5.717 | 35 | 5.667 | 36 | 5.652 |
| 37 | 5.659 | 38 | 5.498 | 39 | 5.478 | 40 | 5.386 |
| 41 | 5.654 | 42 | 5.508 | 43 | 5.716 | 44 | 5.599 |
| 45 | 5.408 | 46 | 5.427 | 47 | 5.306 | 48 | 5.402 |
| 49 | 5.337 | 50 | 5.464 | 51 | 5.712 | 52 | 5.358 |
| 53 | 5.278 | 54 | 5.680 | 55 | 5.365 | 56 | 5.442 |
| 57 | 5.432 | 58 | 5.538 | 59 | 5.315 | 60 | 5.587 |
| 61 | 5.342 | 62 | 5.615 | 63 | 5.674 | 64 | 5.563 |
| 65 | 5.668 | 66 | 5.460 | 67 | 5.590 | 68 | 5.542 |
| 69 | 5.685 | 70 | 5.469 | 71 | 5.453 | 72 | 5.429 |
| 73 | 5.504 | 74 | 5.660 | 75 | 5.353 | 76 | 5.616 |
| 77 | 5.417 | 78 | 5.672 | 79 | 5.331 | 80 | 5.393 |
| 81 | 5.449 | 82 | 5.347 | 83 | 5.610 | 84 | 5.706 |
| 85 | 5.314 | 86 | 5.321 | 87 | 5.415 | 88 | 5.724 |
| 89 | 5.392 | 90 | 5.437 | 91 | 5.691 | 92 | 5.407 |
| 93 | 5.625 | 94 | 5.463 | 95 | 5.582 | 96 | 5.646 |
| 97 | 5.622 | 98 | 5.688 | 99 | 5.266 | 100 | 5.428 |

Hopping Frequency Sequence Name: HOP_FREQ_SEQ_04

| SEQ# | Frequency (GHz) | SEQ# | Frequency (GHz) | SEQ# | Frequency (GHz) | SEQ# | Frequency (GHz) |
|------|-----------------|------|-----------------|------|-----------------|------|-----------------|
| 1 | 5.487 | 2 | 5.498 | 3 | 5.707 | 4 | 5.277 |
| 5 | 5.312 | 6 | 5.447 | 7 | 5.259 | 8 | 5.548 |
| 9 | 5.492 | 10 | 5.699 | 11 | 5.308 | 12 | 5.677 |
| 13 | 5.328 | 14 | 5.520 | 15 | 5.318 | 16 | 5.433 |
| 17 | 5.440 | 18 | 5.294 | 19 | 5.486 | 20 | 5.258 |
| 21 | 5.370 | 22 | 5.405 | 23 | 5.266 | 24 | 5.380 |
| 25 | 5.292 | 26 | 5.590 | 27 | 5.459 | 28 | 5.495 |
| 29 | 5.541 | 30 | 5.564 | 31 | 5.472 | 32 | 5.680 |
| 33 | 5.558 | 34 | 5.319 | 35 | 5.645 | 36 | 5.475 |
| 37 | 5.591 | 38 | 5.375 | 39 | 5.678 | 40 | 5.649 |
| 41 | 5.437 | 42 | 5.674 | 43 | 5.706 | 44 | 5.460 |
| 45 | 5.316 | 46 | 5.636 | 47 | 5.301 | 48 | 5.660 |
| 49 | 5.416 | 50 | 5.284 | 51 | 5.321 | 52 | 5.545 |
| 53 | 5.260 | 54 | 5.353 | 55 | 5.489 | 56 | 5.334 |
| 57 | 5.256 | 58 | 5.600 | 59 | 5.307 | 60 | 5.683 |
| 61 | 5.288 | 62 | 5.637 | 63 | 5.631 | 64 | 5.253 |
| 65 | 5.604 | 66 | 5.709 | 67 | 5.568 | 68 | 5.697 |
| 69 | 5.404 | 70 | 5.508 | 71 | 5.681 | 72 | 5.345 |
| 73 | 5.300 | 74 | 5.497 | 75 | 5.633 | 76 | 5.655 |
| 77 | 5.415 | 78 | 5.333 | 79 | 5.251 | 80 | 5.374 |
| 81 | 5.451 | 82 | 5.443 | 83 | 5.625 | 84 | 5.473 |
| 85 | 5.584 | 86 | 5.338 | 87 | 5.647 | 88 | 5.304 |
| 89 | 5.525 | 90 | 5.542 | 91 | 5.361 | 92 | 5.650 |
| 93 | 5.482 | 94 | 5.666 | 95 | 5.608 | 96 | 5.589 |
| 97 | 5.427 | 98 | 5.384 | 99 | 5.457 | 100 | 5.355 |

Hopping Frequency Sequence Name: HOP_FREQ_SEQ_05

| SEQ# | Frequency (GHz) | SEQ# | Frequency (GHz) | SEQ# | Frequency (GHz) | SEQ# | Frequency (GHz) |
|------|-----------------|------|-----------------|------|-----------------|------|-----------------|
| 1 | 5.583 | 2 | 5.381 | 3 | 5.662 | 4 | 5.649 |
| 5 | 5.275 | 6 | 5.678 | 7 | 5.287 | 8 | 5.452 |
| 9 | 5.461 | 10 | 5.670 | 11 | 5.279 | 12 | 5.702 |
| 13 | 5.399 | 14 | 5.420 | 15 | 5.479 | 16 | 5.278 |
| 17 | 5.487 | 18 | 5.484 | 19 | 5.320 | 20 | 5.433 |
| 21 | 5.550 | 22 | 5.333 | 23 | 5.573 | 24 | 5.456 |
| 25 | 5.299 | 26 | 5.261 | 27 | 5.263 | 28 | 5.614 |
| 29 | 5.321 | 30 | 5.300 | 31 | 5.391 | 32 | 5.551 |
| 33 | 5.600 | 34 | 5.509 | 35 | 5.718 | 36 | 5.522 |
| 37 | 5.396 | 38 | 5.713 | 39 | 5.457 | 40 | 5.717 |
| 41 | 5.659 | 42 | 5.607 | 43 | 5.536 | 44 | 5.370 |
| 45 | 5.329 | 46 | 5.708 | 47 | 5.534 | 48 | 5.429 |
| 49 | 5.492 | 50 | 5.379 | 51 | 5.653 | 52 | 5.545 |
| 53 | 5.620 | 54 | 5.681 | 55 | 5.546 | 56 | 5.715 |
| 57 | 5.616 | 58 | 5.591 | 59 | 5.508 | 60 | 5.375 |
| 61 | 5.271 | 62 | 5.596 | 63 | 5.500 | 64 | 5.455 |
| 65 | 5.318 | 66 | 5.585 | 67 | 5.336 | 68 | 5.657 |
| 69 | 5.598 | 70 | 5.251 | 71 | 5.512 | 72 | 5.668 |
| 73 | 5.665 | 74 | 5.667 | 75 | 5.682 | 76 | 5.407 |
| 77 | 5.489 | 78 | 5.309 | 79 | 5.490 | 80 | 5.418 |
| 81 | 5.257 | 82 | 5.697 | 83 | 5.719 | 84 | 5.341 |
| 85 | 5.689 | 86 | 5.647 | 87 | 5.568 | 88 | 5.699 |
| 89 | 5.674 | 90 | 5.572 | 91 | 5.619 | 92 | 5.408 |
| 93 | 5.664 | 94 | 5.706 | 95 | 5.360 | 96 | 5.439 |
| 97 | 5.284 | 98 | 5.312 | 99 | 5.367 | 100 | 5.478 |

Hopping Frequency Sequence Name: HOP_FREQ_SEQ_06

| SEQ# | Frequency (GHz) | SEQ# | Frequency (GHz) | SEQ# | Frequency (GHz) | SEQ# | Frequency (GHz) |
|------|-----------------|------|-----------------|------|-----------------|------|-----------------|
| 1 | 5.493 | 2 | 5.665 | 3 | 5.291 | 4 | 5.553 |
| 5 | 5.367 | 6 | 5.518 | 7 | 5.444 | 8 | 5.350 |
| 9 | 5.338 | 10 | 5.467 | 11 | 5.262 | 12 | 5.629 |
| 13 | 5.439 | 14 | 5.406 | 15 | 5.267 | 16 | 5.293 |
| 17 | 5.384 | 18 | 5.447 | 19 | 5.647 | 20 | 5.716 |
| 21 | 5.583 | 22 | 5.697 | 23 | 5.260 | 24 | 5.609 |
| 25 | 5.465 | 26 | 5.632 | 27 | 5.268 | 28 | 5.593 |
| 29 | 5.611 | 30 | 5.546 | 31 | 5.466 | 32 | 5.478 |
| 33 | 5.653 | 34 | 5.660 | 35 | 5.357 | 36 | 5.454 |
| 37 | 5.605 | 38 | 5.502 | 39 | 5.604 | 40 | 5.703 |
| 41 | 5.637 | 42 | 5.519 | 43 | 5.258 | 44 | 5.601 |
| 45 | 5.516 | 46 | 5.346 | 47 | 5.645 | 48 | 5.638 |
| 49 | 5.418 | 50 | 5.354 | 51 | 5.644 | 52 | 5.456 |
| 53 | 5.682 | 54 | 5.702 | 55 | 5.607 | 56 | 5.503 |
| 57 | 5.396 | 58 | 5.441 | 59 | 5.273 | 60 | 5.548 |
| 61 | 5.314 | 62 | 5.371 | 63 | 5.306 | 64 | 5.360 |
| 65 | 5.691 | 66 | 5.413 | 67 | 5.551 | 68 | 5.485 |
| 69 | 5.495 | 70 | 5.419 | 71 | 5.531 | 72 | 5.492 |
| 73 | 5.499 | 74 | 5.392 | 75 | 5.347 | 76 | 5.497 |
| 77 | 5.692 | 78 | 5.342 | 79 | 5.723 | 80 | 5.356 |
| 81 | 5.484 | 82 | 5.491 | 83 | 5.705 | 84 | 5.563 |
| 85 | 5.394 | 86 | 5.397 | 87 | 5.534 | 88 | 5.269 |
| 89 | 5.471 | 90 | 5.514 | 91 | 5.339 | 92 | 5.640 |
| 93 | 5.332 | 94 | 5.680 | 95 | 5.482 | 96 | 5.488 |
| 97 | 5.429 | 98 | 5.430 | 99 | 5.464 | 100 | 5.295 |

Hopping Frequency Sequence Name: HOP_FREQ_SEQ_07

| SEQ# | Frequency (GHz) | SEQ# | Frequency (GHz) | SEQ# | Frequency (GHz) | SEQ# | Frequency (GHz) |
|------|-----------------|------|-----------------|------|-----------------|------|-----------------|
| 1 | 5.320 | 2 | 5.390 | 3 | 5.286 | 4 | 5.418 |
| 5 | 5.603 | 6 | 5.488 | 7 | 5.457 | 8 | 5.410 |
| 9 | 5.299 | 10 | 5.545 | 11 | 5.358 | 12 | 5.355 |
| 13 | 5.454 | 14 | 5.277 | 15 | 5.687 | 16 | 5.582 |
| 17 | 5.434 | 18 | 5.475 | 19 | 5.619 | 20 | 5.627 |
| 21 | 5.307 | 22 | 5.317 | 23 | 5.319 | 24 | 5.421 |
| 25 | 5.556 | 26 | 5.541 | 27 | 5.623 | 28 | 5.546 |
| 29 | 5.336 | 30 | 5.578 | 31 | 5.304 | 32 | 5.325 |
| 33 | 5.574 | 34 | 5.382 | 35 | 5.570 | 36 | 5.544 |
| 37 | 5.700 | 38 | 5.571 | 39 | 5.491 | 40 | 5.465 |
| 41 | 5.272 | 42 | 5.536 | 43 | 5.279 | 44 | 5.402 |
| 45 | 5.628 | 46 | 5.595 | 47 | 5.479 | 48 | 5.401 |
| 49 | 5.451 | 50 | 5.356 | 51 | 5.309 | 52 | 5.561 |
| 53 | 5.539 | 54 | 5.685 | 55 | 5.648 | 56 | 5.693 |
| 57 | 5.414 | 58 | 5.679 | 59 | 5.362 | 60 | 5.695 |
| 61 | 5.256 | 62 | 5.283 | 63 | 5.376 | 64 | 5.706 |
| 65 | 5.504 | 66 | 5.441 | 67 | 5.284 | 68 | 5.449 |
| 69 | 5.476 | 70 | 5.462 | 71 | 5.381 | 72 | 5.343 |
| 73 | 5.638 | 74 | 5.689 | 75 | 5.357 | 76 | 5.389 |
| 77 | 5.255 | 78 | 5.303 | 79 | 5.592 | 80 | 5.675 |
| 81 | 5.450 | 82 | 5.611 | 83 | 5.566 | 84 | 5.265 |
| 85 | 5.510 | 86 | 5.724 | 87 | 5.680 | 88 | 5.392 |
| 89 | 5.296 | 90 | 5.605 | 91 | 5.490 | 92 | 5.631 |
| 93 | 5.560 | 94 | 5.612 | 95 | 5.555 | 96 | 5.487 |
| 97 | 5.530 | 98 | 5.327 | 99 | 5.573 | 100 | 5.704 |

Hopping Frequency Sequence Name: HOP_FREQ_SEQ_08

| SEQ# | Frequency (GHz) | SEQ# | Frequency (GHz) | SEQ# | Frequency (GHz) | SEQ# | Frequency (GHz) |
|------|-----------------|------|-----------------|------|-----------------|------|-----------------|
| 1 | 5.537 | 2 | 5.669 | 3 | 5.683 | 4 | 5.517 |
| 5 | 5.583 | 6 | 5.304 | 7 | 5.607 | 8 | 5.656 |
| 9 | 5.424 | 10 | 5.441 | 11 | 5.256 | 12 | 5.552 |
| 13 | 5.599 | 14 | 5.277 | 15 | 5.349 | 16 | 5.707 |
| 17 | 5.521 | 18 | 5.478 | 19 | 5.612 | 20 | 5.302 |
| 21 | 5.677 | 22 | 5.581 | 23 | 5.300 | 24 | 5.412 |
| 25 | 5.381 | 26 | 5.259 | 27 | 5.637 | 28 | 5.251 |
| 29 | 5.296 | 30 | 5.565 | 31 | 5.306 | 32 | 5.285 |
| 33 | 5.648 | 34 | 5.563 | 35 | 5.452 | 36 | 5.555 |
| 37 | 5.650 | 38 | 5.495 | 39 | 5.503 | 40 | 5.594 |
| 41 | 5.469 | 42 | 5.582 | 43 | 5.307 | 44 | 5.255 |
| 45 | 5.253 | 46 | 5.323 | 47 | 5.676 | 48 | 5.709 |
| 49 | 5.720 | 50 | 5.712 | 51 | 5.679 | 52 | 5.482 |
| 53 | 5.438 | 54 | 5.415 | 55 | 5.268 | 56 | 5.636 |
| 57 | 5.593 | 58 | 5.427 | 59 | 5.383 | 60 | 5.661 |
| 61 | 5.560 | 62 | 5.697 | 63 | 5.675 | 64 | 5.468 |
| 65 | 5.649 | 66 | 5.298 | 67 | 5.651 | 68 | 5.400 |
| 69 | 5.647 | 70 | 5.467 | 71 | 5.329 | 72 | 5.652 |
| 73 | 5.589 | 74 | 5.347 | 75 | 5.628 | 76 | 5.500 |
| 77 | 5.689 | 78 | 5.368 | 79 | 5.611 | 80 | 5.387 |
| 81 | 5.608 | 82 | 5.473 | 83 | 5.575 | 84 | 5.278 |
| 85 | 5.704 | 86 | 5.662 | 87 | 5.342 | 88 | 5.592 |
| 89 | 5.686 | 90 | 5.702 | 91 | 5.624 | 92 | 5.434 |
| 93 | 5.416 | 94 | 5.553 | 95 | 5.576 | 96 | 5.477 |
| 97 | 5.464 | 98 | 5.396 | 99 | 5.386 | 100 | 5.432 |

Hopping Frequency Sequence Name: HOP_FREQ_SEQ_09

| SEQ# | Frequency (GHz) | SEQ# | Frequency (GHz) | SEQ# | Frequency (GHz) | SEQ# | Frequency (GHz) |
|------|-----------------|------|-----------------|------|-----------------|------|-----------------|
| 1 | 5.349 | 2 | 5.590 | 3 | 5.466 | 4 | 5.546 |
| 5 | 5.530 | 6 | 5.355 | 7 | 5.575 | 8 | 5.709 |
| 9 | 5.350 | 10 | 5.724 | 11 | 5.456 | 12 | 5.682 |
| 13 | 5.625 | 14 | 5.554 | 15 | 5.713 | 16 | 5.477 |
| 17 | 5.432 | 18 | 5.412 | 19 | 5.454 | 20 | 5.402 |
| 21 | 5.357 | 22 | 5.389 | 23 | 5.626 | 24 | 5.717 |
| 25 | 5.282 | 26 | 5.524 | 27 | 5.697 | 28 | 5.264 |
| 29 | 5.467 | 30 | 5.720 | 31 | 5.459 | 32 | 5.313 |
| 33 | 5.640 | 34 | 5.329 | 35 | 5.605 | 36 | 5.427 |
| 37 | 5.295 | 38 | 5.567 | 39 | 5.302 | 40 | 5.635 |
| 41 | 5.278 | 42 | 5.578 | 43 | 5.461 | 44 | 5.700 |
| 45 | 5.455 | 46 | 5.327 | 47 | 5.592 | 48 | 5.275 |
| 49 | 5.632 | 50 | 5.453 | 51 | 5.422 | 52 | 5.300 |
| 53 | 5.721 | 54 | 5.650 | 55 | 5.704 | 56 | 5.380 |
| 57 | 5.403 | 58 | 5.373 | 59 | 5.367 | 60 | 5.372 |
| 61 | 5.492 | 62 | 5.690 | 63 | 5.618 | 64 | 5.540 |
| 65 | 5.508 | 66 | 5.485 | 67 | 5.496 | 68 | 5.548 |
| 69 | 5.512 | 70 | 5.687 | 71 | 5.296 | 72 | 5.676 |
| 73 | 5.499 | 74 | 5.440 | 75 | 5.579 | 76 | 5.604 |
| 77 | 5.608 | 78 | 5.723 | 79 | 5.576 | 80 | 5.703 |
| 81 | 5.433 | 82 | 5.612 | 83 | 5.482 | 84 | 5.583 |
| 85 | 5.633 | 86 | 5.582 | 87 | 5.437 | 88 | 5.521 |
| 89 | 5.601 | 90 | 5.391 | 91 | 5.647 | 92 | 5.393 |
| 93 | 5.419 | 94 | 5.598 | 95 | 5.434 | 96 | 5.597 |
| 97 | 5.446 | 98 | 5.478 | 99 | 5.551 | 100 | 5.621 |

Hopping Frequency Sequence Name: HOP_FREQ_SEQ_10

| SEQ# | Frequency (GHz) | SEQ# | Frequency (GHz) | SEQ# | Frequency (GHz) | SEQ# | Frequency (GHz) |
|------|-----------------|------|-----------------|------|-----------------|------|-----------------|
| 1 | 5.550 | 2 | 5.265 | 3 | 5.435 | 4 | 5.470 |
| 5 | 5.657 | 6 | 5.490 | 7 | 5.566 | 8 | 5.303 |
| 9 | 5.400 | 10 | 5.263 | 11 | 5.271 | 12 | 5.372 |
| 13 | 5.448 | 14 | 5.659 | 15 | 5.549 | 16 | 5.571 |
| 17 | 5.381 | 18 | 5.398 | 19 | 5.278 | 20 | 5.511 |
| 21 | 5.583 | 22 | 5.333 | 23 | 5.482 | 24 | 5.494 |
| 25 | 5.353 | 26 | 5.668 | 27 | 5.460 | 28 | 5.563 |
| 29 | 5.706 | 30 | 5.421 | 31 | 5.283 | 32 | 5.703 |
| 33 | 5.554 | 34 | 5.503 | 35 | 5.513 | 36 | 5.461 |
| 37 | 5.355 | 38 | 5.341 | 39 | 5.532 | 40 | 5.528 |
| 41 | 5.380 | 42 | 5.698 | 43 | 5.392 | 44 | 5.582 |
| 45 | 5.285 | 46 | 5.425 | 47 | 5.454 | 48 | 5.617 |
| 49 | 5.323 | 50 | 5.281 | 51 | 5.544 | 52 | 5.466 |
| 53 | 5.447 | 54 | 5.420 | 55 | 5.600 | 56 | 5.676 |
| 57 | 5.422 | 58 | 5.638 | 59 | 5.324 | 60 | 5.295 |
| 61 | 5.359 | 62 | 5.483 | 63 | 5.628 | 64 | 5.350 |
| 65 | 5.690 | 66 | 5.389 | 67 | 5.495 | 68 | 5.252 |
| 69 | 5.603 | 70 | 5.688 | 71 | 5.266 | 72 | 5.696 |
| 73 | 5.713 | 74 | 5.649 | 75 | 5.465 | 76 | 5.413 |
| 77 | 5.551 | 78 | 5.615 | 79 | 5.620 | 80 | 5.358 |
| 81 | 5.567 | 82 | 5.442 | 83 | 5.524 | 84 | 5.506 |
| 85 | 5.296 | 86 | 5.597 | 87 | 5.360 | 88 | 5.484 |
| 89 | 5.430 | 90 | 5.407 | 91 | 5.612 | 92 | 5.619 |
| 93 | 5.488 | 94 | 5.631 | 95 | 5.375 | 96 | 5.432 |
| 97 | 5.641 | 98 | 5.342 | 99 | 5.443 | 100 | 5.590 |

Hopping Frequency Sequence Name: HOP_FREQ_SEQ_11

| SEQ# | Frequency (GHz) | SEQ# | Frequency (GHz) | SEQ# | Frequency (GHz) | SEQ# | Frequency (GHz) |
|------|-----------------|------|-----------------|------|-----------------|------|-----------------|
| 1 | 5.408 | 2 | 5.306 | 3 | 5.263 | 4 | 5.393 |
| 5 | 5.321 | 6 | 5.559 | 7 | 5.525 | 8 | 5.427 |
| 9 | 5.723 | 10 | 5.451 | 11 | 5.696 | 12 | 5.626 |
| 13 | 5.709 | 14 | 5.553 | 15 | 5.257 | 16 | 5.474 |
| 17 | 5.261 | 18 | 5.669 | 19 | 5.462 | 20 | 5.348 |
| 21 | 5.487 | 22 | 5.589 | 23 | 5.625 | 24 | 5.294 |
| 25 | 5.262 | 26 | 5.711 | 27 | 5.362 | 28 | 5.623 |
| 29 | 5.568 | 30 | 5.564 | 31 | 5.666 | 32 | 5.413 |
| 33 | 5.538 | 34 | 5.484 | 35 | 5.641 | 36 | 5.520 |
| 37 | 5.721 | 38 | 5.483 | 39 | 5.659 | 40 | 5.339 |
| 41 | 5.300 | 42 | 5.478 | 43 | 5.563 | 44 | 5.269 |
| 45 | 5.684 | 46 | 5.663 | 47 | 5.252 | 48 | 5.254 |
| 49 | 5.480 | 50 | 5.655 | 51 | 5.521 | 52 | 5.377 |
| 53 | 5.603 | 54 | 5.627 | 55 | 5.314 | 56 | 5.364 |
| 57 | 5.629 | 58 | 5.365 | 59 | 5.351 | 60 | 5.528 |
| 61 | 5.657 | 62 | 5.447 | 63 | 5.270 | 64 | 5.477 |
| 65 | 5.515 | 66 | 5.295 | 67 | 5.268 | 68 | 5.383 |
| 69 | 5.251 | 70 | 5.458 | 71 | 5.320 | 72 | 5.374 |
| 73 | 5.492 | 74 | 5.358 | 75 | 5.357 | 76 | 5.410 |
| 77 | 5.676 | 78 | 5.588 | 79 | 5.414 | 80 | 5.399 |
| 81 | 5.498 | 82 | 5.491 | 83 | 5.604 | 84 | 5.658 |
| 85 | 5.330 | 86 | 5.613 | 87 | 5.317 | 88 | 5.539 |
| 89 | 5.652 | 90 | 5.403 | 91 | 5.675 | 92 | 5.642 |
| 93 | 5.551 | 94 | 5.343 | 95 | 5.460 | 96 | 5.543 |
| 97 | 5.369 | 98 | 5.276 | 99 | 5.532 | 100 | 5.708 |

Hopping Frequency Sequence Name: HOP_FREQ_SEQ_12

| SEQ# | Frequency (GHz) | SEQ# | Frequency (GHz) | SEQ# | Frequency (GHz) | SEQ# | Frequency (GHz) |
|------|-----------------|------|-----------------|------|-----------------|------|-----------------|
| 1 | 5.603 | 2 | 5.666 | 3 | 5.522 | 4 | 5.502 |
| 5 | 5.678 | 6 | 5.480 | 7 | 5.479 | 8 | 5.281 |
| 9 | 5.364 | 10 | 5.297 | 11 | 5.713 | 12 | 5.316 |
| 13 | 5.476 | 14 | 5.662 | 15 | 5.437 | 16 | 5.710 |
| 17 | 5.561 | 18 | 5.306 | 19 | 5.416 | 20 | 5.463 |
| 21 | 5.268 | 22 | 5.498 | 23 | 5.674 | 24 | 5.313 |
| 25 | 5.549 | 26 | 5.294 | 27 | 5.558 | 28 | 5.637 |
| 29 | 5.583 | 30 | 5.462 | 31 | 5.291 | 32 | 5.492 |
| 33 | 5.452 | 34 | 5.260 | 35 | 5.497 | 36 | 5.535 |
| 37 | 5.586 | 38 | 5.577 | 39 | 5.658 | 40 | 5.470 |
| 41 | 5.424 | 42 | 5.264 | 43 | 5.680 | 44 | 5.347 |
| 45 | 5.619 | 46 | 5.500 | 47 | 5.266 | 48 | 5.411 |
| 49 | 5.272 | 50 | 5.353 | 51 | 5.661 | 52 | 5.317 |
| 53 | 5.696 | 54 | 5.576 | 55 | 5.391 | 56 | 5.376 |
| 57 | 5.442 | 58 | 5.432 | 59 | 5.305 | 60 | 5.461 |
| 61 | 5.398 | 62 | 5.394 | 63 | 5.368 | 64 | 5.283 |
| 65 | 5.624 | 66 | 5.414 | 67 | 5.483 | 68 | 5.458 |
| 69 | 5.329 | 70 | 5.634 | 71 | 5.578 | 72 | 5.718 |
| 73 | 5.387 | 74 | 5.596 | 75 | 5.650 | 76 | 5.517 |
| 77 | 5.690 | 78 | 5.453 | 79 | 5.613 | 80 | 5.653 |
| 81 | 5.628 | 82 | 5.451 | 83 | 5.478 | 84 | 5.356 |
| 85 | 5.441 | 86 | 5.381 | 87 | 5.552 | 88 | 5.395 |
| 89 | 5.341 | 90 | 5.496 | 91 | 5.455 | 92 | 5.469 |
| 93 | 5.573 | 94 | 5.365 | 95 | 5.642 | 96 | 5.505 |
| 97 | 5.309 | 98 | 5.397 | 99 | 5.568 | 100 | 5.639 |

Hopping Frequency Sequence Name: HOP_FREQ_SEQ_13

| SEQ# | Frequency (GHz) | SEQ# | Frequency (GHz) | SEQ# | Frequency (GHz) | SEQ# | Frequency (GHz) |
|------|-----------------|------|-----------------|------|-----------------|------|-----------------|
| 1 | 5.375 | 2 | 5.264 | 3 | 5.273 | 4 | 5.293 |
| 5 | 5.612 | 6 | 5.436 | 7 | 5.695 | 8 | 5.549 |
| 9 | 5.422 | 10 | 5.631 | 11 | 5.262 | 12 | 5.490 |
| 13 | 5.589 | 14 | 5.506 | 15 | 5.326 | 16 | 5.282 |
| 17 | 5.657 | 18 | 5.497 | 19 | 5.509 | 20 | 5.660 |
| 21 | 5.474 | 22 | 5.629 | 23 | 5.272 | 24 | 5.314 |
| 25 | 5.433 | 26 | 5.560 | 27 | 5.399 | 28 | 5.357 |
| 29 | 5.668 | 30 | 5.484 | 31 | 5.408 | 32 | 5.325 |
| 33 | 5.434 | 34 | 5.356 | 35 | 5.563 | 36 | 5.285 |
| 37 | 5.401 | 38 | 5.426 | 39 | 5.393 | 40 | 5.621 |
| 41 | 5.277 | 42 | 5.567 | 43 | 5.593 | 44 | 5.559 |
| 45 | 5.496 | 46 | 5.675 | 47 | 5.419 | 48 | 5.319 |
| 49 | 5.690 | 50 | 5.694 | 51 | 5.373 | 52 | 5.661 |
| 53 | 5.367 | 54 | 5.522 | 55 | 5.674 | 56 | 5.265 |
| 57 | 5.300 | 58 | 5.468 | 59 | 5.596 | 60 | 5.324 |
| 61 | 5.528 | 62 | 5.526 | 63 | 5.537 | 64 | 5.669 |
| 65 | 5.599 | 66 | 5.358 | 67 | 5.303 | 68 | 5.648 |
| 69 | 5.378 | 70 | 5.478 | 71 | 5.469 | 72 | 5.407 |
| 73 | 5.513 | 74 | 5.263 | 75 | 5.586 | 76 | 5.360 |
| 77 | 5.571 | 78 | 5.604 | 79 | 5.446 | 80 | 5.479 |
| 81 | 5.482 | 82 | 5.366 | 83 | 5.394 | 84 | 5.693 |
| 85 | 5.288 | 86 | 5.512 | 87 | 5.551 | 88 | 5.585 |
| 89 | 5.723 | 90 | 5.705 | 91 | 5.412 | 92 | 5.711 |
| 93 | 5.345 | 94 | 5.486 | 95 | 5.678 | 96 | 5.361 |
| 97 | 5.390 | 98 | 5.352 | 99 | 5.649 | 100 | 5.647 |

Hopping Frequency Sequence Name: HOP_FREQ_SEQ_14

| SEQ# | Frequency (GHz) | SEQ# | Frequency (GHz) | SEQ# | Frequency (GHz) | SEQ# | Frequency (GHz) |
|------|-----------------|------|-----------------|------|-----------------|------|-----------------|
| 1 | 5.507 | 2 | 5.709 | 3 | 5.352 | 4 | 5.516 |
| 5 | 5.503 | 6 | 5.594 | 7 | 5.415 | 8 | 5.255 |
| 9 | 5.475 | 10 | 5.275 | 11 | 5.657 | 12 | 5.344 |
| 13 | 5.534 | 14 | 5.406 | 15 | 5.612 | 16 | 5.671 |
| 17 | 5.389 | 18 | 5.314 | 19 | 5.323 | 20 | 5.544 |
| 21 | 5.277 | 22 | 5.302 | 23 | 5.545 | 24 | 5.577 |
| 25 | 5.388 | 26 | 5.258 | 27 | 5.386 | 28 | 5.434 |
| 29 | 5.312 | 30 | 5.595 | 31 | 5.689 | 32 | 5.420 |
| 33 | 5.287 | 34 | 5.408 | 35 | 5.464 | 36 | 5.511 |
| 37 | 5.443 | 38 | 5.427 | 39 | 5.416 | 40 | 5.365 |
| 41 | 5.500 | 42 | 5.587 | 43 | 5.457 | 44 | 5.395 |
| 45 | 5.621 | 46 | 5.588 | 47 | 5.442 | 48 | 5.411 |
| 49 | 5.390 | 50 | 5.539 | 51 | 5.425 | 52 | 5.521 |
| 53 | 5.722 | 54 | 5.696 | 55 | 5.413 | 56 | 5.529 |
| 57 | 5.355 | 58 | 5.656 | 59 | 5.704 | 60 | 5.316 |
| 61 | 5.480 | 62 | 5.581 | 63 | 5.632 | 64 | 5.676 |
| 65 | 5.482 | 66 | 5.432 | 67 | 5.259 | 68 | 5.438 |
| 69 | 5.694 | 70 | 5.580 | 71 | 5.536 | 72 | 5.663 |
| 73 | 5.495 | 74 | 5.674 | 75 | 5.347 | 76 | 5.400 |
| 77 | 5.465 | 78 | 5.330 | 79 | 5.589 | 80 | 5.519 |
| 81 | 5.699 | 82 | 5.645 | 83 | 5.380 | 84 | 5.672 |
| 85 | 5.635 | 86 | 5.548 | 87 | 5.563 | 88 | 5.710 |
| 89 | 5.348 | 90 | 5.629 | 91 | 5.641 | 92 | 5.509 |
| 93 | 5.317 | 94 | 5.384 | 95 | 5.562 | 96 | 5.666 |
| 97 | 5.332 | 98 | 5.456 | 99 | 5.262 | 100 | 5.701 |

Hopping Frequency Sequence Name: HOP_FREQ_SEQ_15

| SEQ# | Frequency (GHz) | SEQ# | Frequency (GHz) | SEQ# | Frequency (GHz) | SEQ# | Frequency (GHz) |
|------|-----------------|------|-----------------|------|-----------------|------|-----------------|
| 1 | 5.332 | 2 | 5.253 | 3 | 5.256 | 4 | 5.368 |
| 5 | 5.366 | 6 | 5.427 | 7 | 5.495 | 8 | 5.322 |
| 9 | 5.496 | 10 | 5.474 | 11 | 5.448 | 12 | 5.678 |
| 13 | 5.410 | 14 | 5.687 | 15 | 5.686 | 16 | 5.533 |
| 17 | 5.269 | 18 | 5.385 | 19 | 5.429 | 20 | 5.261 |
| 21 | 5.585 | 22 | 5.509 | 23 | 5.255 | 24 | 5.478 |
| 25 | 5.360 | 26 | 5.339 | 27 | 5.335 | 28 | 5.512 |
| 29 | 5.604 | 30 | 5.462 | 31 | 5.479 | 32 | 5.562 |
| 33 | 5.693 | 34 | 5.337 | 35 | 5.671 | 36 | 5.260 |
| 37 | 5.382 | 38 | 5.556 | 39 | 5.523 | 40 | 5.292 |
| 41 | 5.273 | 42 | 5.313 | 43 | 5.586 | 44 | 5.668 |
| 45 | 5.317 | 46 | 5.324 | 47 | 5.505 | 48 | 5.486 |
| 49 | 5.358 | 50 | 5.493 | 51 | 5.456 | 52 | 5.610 |
| 53 | 5.528 | 54 | 5.590 | 55 | 5.506 | 56 | 5.517 |
| 57 | 5.530 | 58 | 5.640 | 59 | 5.318 | 60 | 5.274 |
| 61 | 5.381 | 62 | 5.579 | 63 | 5.667 | 64 | 5.661 |
| 65 | 5.415 | 66 | 5.442 | 67 | 5.621 | 68 | 5.552 |
| 69 | 5.455 | 70 | 5.300 | 71 | 5.441 | 72 | 5.491 |
| 73 | 5.722 | 74 | 5.305 | 75 | 5.331 | 76 | 5.365 |
| 77 | 5.390 | 78 | 5.637 | 79 | 5.266 | 80 | 5.591 |
| 81 | 5.563 | 82 | 5.607 | 83 | 5.461 | 84 | 5.262 |
| 85 | 5.605 | 86 | 5.617 | 87 | 5.403 | 88 | 5.600 |
| 89 | 5.492 | 90 | 5.294 | 91 | 5.706 | 92 | 5.507 |
| 93 | 5.284 | 94 | 5.298 | 95 | 5.564 | 96 | 5.650 |
| 97 | 5.537 | 98 | 5.611 | 99 | 5.645 | 100 | 5.413 |

Hopping Frequency Sequence Name: HOP_FREQ_SEQ_16

| SEQ# | Frequency (GHz) | SEQ# | Frequency (GHz) | SEQ# | Frequency (GHz) | SEQ# | Frequency (GHz) |
|------|-----------------|------|-----------------|------|-----------------|------|-----------------|
| 1 | 5.469 | 2 | 5.426 | 3 | 5.347 | 4 | 5.449 |
| 5 | 5.330 | 6 | 5.537 | 7 | 5.391 | 8 | 5.687 |
| 9 | 5.666 | 10 | 5.332 | 11 | 5.651 | 12 | 5.341 |
| 13 | 5.352 | 14 | 5.457 | 15 | 5.686 | 16 | 5.531 |
| 17 | 5.693 | 18 | 5.631 | 19 | 5.269 | 20 | 5.525 |
| 21 | 5.702 | 22 | 5.403 | 23 | 5.536 | 24 | 5.363 |
| 25 | 5.516 | 26 | 5.538 | 27 | 5.490 | 28 | 5.511 |
| 29 | 5.724 | 30 | 5.704 | 31 | 5.442 | 32 | 5.441 |
| 33 | 5.411 | 34 | 5.717 | 35 | 5.571 | 36 | 5.647 |
| 37 | 5.649 | 38 | 5.606 | 39 | 5.319 | 40 | 5.448 |
| 41 | 5.504 | 42 | 5.472 | 43 | 5.609 | 44 | 5.438 |
| 45 | 5.545 | 46 | 5.480 | 47 | 5.256 | 48 | 5.679 |
| 49 | 5.382 | 50 | 5.284 | 51 | 5.543 | 52 | 5.424 |
| 53 | 5.317 | 54 | 5.520 | 55 | 5.604 | 56 | 5.397 |
| 57 | 5.505 | 58 | 5.463 | 59 | 5.685 | 60 | 5.602 |
| 61 | 5.270 | 62 | 5.618 | 63 | 5.662 | 64 | 5.273 |
| 65 | 5.707 | 66 | 5.664 | 67 | 5.552 | 68 | 5.294 |
| 69 | 5.320 | 70 | 5.464 | 71 | 5.641 | 72 | 5.476 |
| 73 | 5.661 | 74 | 5.566 | 75 | 5.299 | 76 | 5.584 |
| 77 | 5.619 | 78 | 5.420 | 79 | 5.488 | 80 | 5.593 |
| 81 | 5.654 | 82 | 5.714 | 83 | 5.287 | 84 | 5.657 |
| 85 | 5.337 | 86 | 5.644 | 87 | 5.648 | 88 | 5.659 |
| 89 | 5.251 | 90 | 5.265 | 91 | 5.279 | 92 | 5.359 |
| 93 | 5.460 | 94 | 5.413 | 95 | 5.308 | 96 | 5.544 |
| 97 | 5.640 | 98 | 5.394 | 99 | 5.348 | 100 | 5.613 |

Hopping Frequency Sequence Name: HOP_FREQ_SEQ_17

| SEQ# | Frequency (GHz) | SEQ# | Frequency (GHz) | SEQ# | Frequency (GHz) | SEQ# | Frequency (GHz) |
|------|-----------------|------|-----------------|------|-----------------|------|-----------------|
| 1 | 5.421 | 2 | 5.498 | 3 | 5.713 | 4 | 5.660 |
| 5 | 5.583 | 6 | 5.662 | 7 | 5.657 | 8 | 5.641 |
| 9 | 5.268 | 10 | 5.654 | 11 | 5.517 | 12 | 5.259 |
| 13 | 5.485 | 14 | 5.419 | 15 | 5.276 | 16 | 5.649 |
| 17 | 5.467 | 18 | 5.646 | 19 | 5.359 | 20 | 5.642 |
| 21 | 5.659 | 22 | 5.620 | 23 | 5.345 | 24 | 5.257 |
| 25 | 5.288 | 26 | 5.478 | 27 | 5.637 | 28 | 5.252 |
| 29 | 5.489 | 30 | 5.274 | 31 | 5.703 | 32 | 5.534 |
| 33 | 5.376 | 34 | 5.719 | 35 | 5.682 | 36 | 5.413 |
| 37 | 5.614 | 38 | 5.448 | 39 | 5.256 | 40 | 5.365 |
| 41 | 5.587 | 42 | 5.350 | 43 | 5.605 | 44 | 5.447 |
| 45 | 5.328 | 46 | 5.710 | 47 | 5.330 | 48 | 5.679 |
| 49 | 5.557 | 50 | 5.674 | 51 | 5.437 | 52 | 5.668 |
| 53 | 5.714 | 54 | 5.353 | 55 | 5.488 | 56 | 5.427 |
| 57 | 5.577 | 58 | 5.482 | 59 | 5.700 | 60 | 5.626 |
| 61 | 5.307 | 62 | 5.464 | 63 | 5.423 | 64 | 5.336 |
| 65 | 5.617 | 66 | 5.608 | 67 | 5.562 | 68 | 5.443 |
| 69 | 5.446 | 70 | 5.561 | 71 | 5.493 | 72 | 5.560 |
| 73 | 5.304 | 74 | 5.354 | 75 | 5.495 | 76 | 5.680 |
| 77 | 5.397 | 78 | 5.344 | 79 | 5.426 | 80 | 5.425 |
| 81 | 5.599 | 82 | 5.567 | 83 | 5.510 | 84 | 5.555 |
| 85 | 5.625 | 86 | 5.324 | 87 | 5.707 | 88 | 5.262 |
| 89 | 5.501 | 90 | 5.651 | 91 | 5.292 | 92 | 5.424 |
| 93 | 5.573 | 94 | 5.411 | 95 | 5.597 | 96 | 5.691 |
| 97 | 5.435 | 98 | 5.459 | 99 | 5.282 | 100 | 5.600 |

Hopping Frequency Sequence Name: HOP_FREQ_SEQ_18

| SEQ# | Frequency (GHz) | SEQ# | Frequency (GHz) | SEQ# | Frequency (GHz) | SEQ# | Frequency (GHz) |
|------|-----------------|------|-----------------|------|-----------------|------|-----------------|
| 1 | 5.471 | 2 | 5.678 | 3 | 5.410 | 4 | 5.537 |
| 5 | 5.446 | 6 | 5.666 | 7 | 5.563 | 8 | 5.355 |
| 9 | 5.484 | 10 | 5.489 | 11 | 5.556 | 12 | 5.596 |
| 13 | 5.454 | 14 | 5.682 | 15 | 5.554 | 16 | 5.595 |
| 17 | 5.270 | 18 | 5.610 | 19 | 5.586 | 20 | 5.549 |
| 21 | 5.264 | 22 | 5.415 | 23 | 5.266 | 24 | 5.339 |
| 25 | 5.662 | 26 | 5.697 | 27 | 5.379 | 28 | 5.392 |
| 29 | 5.301 | 30 | 5.334 | 31 | 5.573 | 32 | 5.643 |
| 33 | 5.253 | 34 | 5.439 | 35 | 5.300 | 36 | 5.519 |
| 37 | 5.267 | 38 | 5.689 | 39 | 5.539 | 40 | 5.455 |
| 41 | 5.468 | 42 | 5.613 | 43 | 5.496 | 44 | 5.665 |
| 45 | 5.381 | 46 | 5.250 | 47 | 5.298 | 48 | 5.272 |
| 49 | 5.592 | 50 | 5.360 | 51 | 5.532 | 52 | 5.324 |
| 53 | 5.710 | 54 | 5.409 | 55 | 5.517 | 56 | 5.467 |
| 57 | 5.647 | 58 | 5.668 | 59 | 5.309 | 60 | 5.548 |
| 61 | 5.317 | 62 | 5.428 | 63 | 5.597 | 64 | 5.314 |
| 65 | 5.481 | 66 | 5.308 | 67 | 5.584 | 68 | 5.622 |
| 69 | 5.358 | 70 | 5.466 | 71 | 5.616 | 72 | 5.295 |
| 73 | 5.364 | 74 | 5.261 | 75 | 5.655 | 76 | 5.660 |
| 77 | 5.457 | 78 | 5.672 | 79 | 5.565 | 80 | 5.652 |
| 81 | 5.260 | 82 | 5.683 | 83 | 5.343 | 84 | 5.401 |
| 85 | 5.325 | 86 | 5.686 | 87 | 5.353 | 88 | 5.315 |
| 89 | 5.373 | 90 | 5.402 | 91 | 5.352 | 92 | 5.599 |
| 93 | 5.626 | 94 | 5.702 | 95 | 5.258 | 96 | 5.460 |
| 97 | 5.724 | 98 | 5.670 | 99 | 5.444 | 100 | 5.388 |

Hopping Frequency Sequence Name: HOP_FREQ_SEQ_19

| SEQ# | Frequency (GHz) | SEQ# | Frequency (GHz) | SEQ# | Frequency (GHz) | SEQ# | Frequency (GHz) |
|------|-----------------|------|-----------------|------|-----------------|------|-----------------|
| 1 | 5.550 | 2 | 5.672 | 3 | 5.305 | 4 | 5.508 |
| 5 | 5.713 | 6 | 5.500 | 7 | 5.312 | 8 | 5.704 |
| 9 | 5.291 | 10 | 5.288 | 11 | 5.664 | 12 | 5.468 |
| 13 | 5.405 | 14 | 5.558 | 15 | 5.313 | 16 | 5.308 |
| 17 | 5.390 | 18 | 5.685 | 19 | 5.526 | 20 | 5.394 |
| 21 | 5.616 | 22 | 5.333 | 23 | 5.419 | 24 | 5.461 |
| 25 | 5.417 | 26 | 5.393 | 27 | 5.427 | 28 | 5.650 |
| 29 | 5.376 | 30 | 5.351 | 31 | 5.656 | 32 | 5.494 |
| 33 | 5.700 | 34 | 5.365 | 35 | 5.624 | 36 | 5.551 |
| 37 | 5.259 | 38 | 5.657 | 39 | 5.470 | 40 | 5.666 |
| 41 | 5.250 | 42 | 5.501 | 43 | 5.681 | 44 | 5.496 |
| 45 | 5.370 | 46 | 5.689 | 47 | 5.535 | 48 | 5.271 |
| 49 | 5.444 | 50 | 5.696 | 51 | 5.337 | 52 | 5.621 |
| 53 | 5.265 | 54 | 5.399 | 55 | 5.609 | 56 | 5.722 |
| 57 | 5.401 | 58 | 5.667 | 59 | 5.473 | 60 | 5.511 |
| 61 | 5.350 | 62 | 5.614 | 63 | 5.516 | 64 | 5.409 |
| 65 | 5.260 | 66 | 5.709 | 67 | 5.677 | 68 | 5.590 |
| 69 | 5.671 | 70 | 5.418 | 71 | 5.297 | 72 | 5.623 |
| 73 | 5.539 | 74 | 5.371 | 75 | 5.280 | 76 | 5.422 |
| 77 | 5.607 | 78 | 5.407 | 79 | 5.533 | 80 | 5.316 |
| 81 | 5.301 | 82 | 5.640 | 83 | 5.610 | 84 | 5.454 |
| 85 | 5.413 | 86 | 5.512 | 87 | 5.577 | 88 | 5.557 |
| 89 | 5.471 | 90 | 5.622 | 91 | 5.439 | 92 | 5.361 |
| 93 | 5.582 | 94 | 5.360 | 95 | 5.440 | 96 | 5.537 |
| 97 | 5.406 | 98 | 5.585 | 99 | 5.342 | 100 | 5.462 |

Hopping Frequency Sequence Name: HOP_FREQ_SEQ_20

| SEQ# | Frequency (GHz) | SEQ# | Frequency (GHz) | SEQ# | Frequency (GHz) | SEQ# | Frequency (GHz) |
|------|-----------------|------|-----------------|------|-----------------|------|-----------------|
| 1 | 5.664 | 2 | 5.377 | 3 | 5.595 | 4 | 5.701 |
| 5 | 5.596 | 6 | 5.490 | 7 | 5.573 | 8 | 5.706 |
| 9 | 5.594 | 10 | 5.393 | 11 | 5.581 | 12 | 5.592 |
| 13 | 5.403 | 14 | 5.547 | 15 | 5.428 | 16 | 5.314 |
| 17 | 5.643 | 18 | 5.585 | 19 | 5.444 | 20 | 5.405 |
| 21 | 5.279 | 22 | 5.294 | 23 | 5.477 | 24 | 5.277 |
| 25 | 5.543 | 26 | 5.338 | 27 | 5.720 | 28 | 5.613 |
| 29 | 5.323 | 30 | 5.541 | 31 | 5.496 | 32 | 5.270 |
| 33 | 5.499 | 34 | 5.410 | 35 | 5.530 | 36 | 5.339 |
| 37 | 5.452 | 38 | 5.287 | 39 | 5.423 | 40 | 5.375 |
| 41 | 5.328 | 42 | 5.644 | 43 | 5.620 | 44 | 5.333 |
| 45 | 5.635 | 46 | 5.566 | 47 | 5.645 | 48 | 5.497 |
| 49 | 5.325 | 50 | 5.417 | 51 | 5.523 | 52 | 5.562 |
| 53 | 5.605 | 54 | 5.495 | 55 | 5.271 | 56 | 5.693 |
| 57 | 5.442 | 58 | 5.524 | 59 | 5.637 | 60 | 5.407 |
| 61 | 5.421 | 62 | 5.342 | 63 | 5.435 | 64 | 5.590 |
| 65 | 5.636 | 66 | 5.711 | 67 | 5.468 | 68 | 5.288 |
| 69 | 5.488 | 70 | 5.719 | 71 | 5.699 | 72 | 5.400 |
| 73 | 5.343 | 74 | 5.589 | 75 | 5.379 | 76 | 5.408 |
| 77 | 5.406 | 78 | 5.712 | 79 | 5.370 | 80 | 5.268 |
| 81 | 5.299 | 82 | 5.576 | 83 | 5.619 | 84 | 5.332 |
| 85 | 5.361 | 86 | 5.465 | 87 | 5.517 | 88 | 5.485 |
| 89 | 5.724 | 90 | 5.557 | 91 | 5.297 | 92 | 5.586 |
| 93 | 5.321 | 94 | 5.368 | 95 | 5.683 | 96 | 5.526 |
| 97 | 5.649 | 98 | 5.587 | 99 | 5.582 | 100 | 5.681 |

Hopping Frequency Sequence Name: HOP_FREQ_SEQ_21

| SEQ# | Frequency (GHz) | SEQ# | Frequency (GHz) | SEQ# | Frequency (GHz) | SEQ# | Frequency (GHz) |
|------|-----------------|------|-----------------|------|-----------------|------|-----------------|
| 1 | 5.265 | 2 | 5.645 | 3 | 5.335 | 4 | 5.680 |
| 5 | 5.551 | 6 | 5.661 | 7 | 5.669 | 8 | 5.387 |
| 9 | 5.352 | 10 | 5.635 | 11 | 5.451 | 12 | 5.534 |
| 13 | 5.511 | 14 | 5.708 | 15 | 5.721 | 16 | 5.644 |
| 17 | 5.524 | 18 | 5.634 | 19 | 5.453 | 20 | 5.698 |
| 21 | 5.631 | 22 | 5.445 | 23 | 5.279 | 24 | 5.582 |
| 25 | 5.488 | 26 | 5.687 | 27 | 5.292 | 28 | 5.673 |
| 29 | 5.361 | 30 | 5.256 | 31 | 5.471 | 32 | 5.523 |
| 33 | 5.464 | 34 | 5.330 | 35 | 5.555 | 36 | 5.499 |
| 37 | 5.700 | 38 | 5.613 | 39 | 5.695 | 40 | 5.672 |
| 41 | 5.591 | 42 | 5.399 | 43 | 5.432 | 44 | 5.664 |
| 45 | 5.578 | 46 | 5.571 | 47 | 5.478 | 48 | 5.463 |
| 49 | 5.431 | 50 | 5.516 | 51 | 5.371 | 52 | 5.652 |
| 53 | 5.709 | 54 | 5.692 | 55 | 5.421 | 56 | 5.480 |
| 57 | 5.425 | 58 | 5.293 | 59 | 5.285 | 60 | 5.693 |
| 61 | 5.666 | 62 | 5.609 | 63 | 5.377 | 64 | 5.338 |
| 65 | 5.597 | 66 | 5.430 | 67 | 5.568 | 68 | 5.489 |
| 69 | 5.495 | 70 | 5.479 | 71 | 5.304 | 72 | 5.527 |
| 73 | 5.473 | 74 | 5.397 | 75 | 5.643 | 76 | 5.626 |
| 77 | 5.411 | 78 | 5.702 | 79 | 5.409 | 80 | 5.512 |
| 81 | 5.599 | 82 | 5.497 | 83 | 5.393 | 84 | 5.351 |
| 85 | 5.706 | 86 | 5.327 | 87 | 5.660 | 88 | 5.437 |
| 89 | 5.322 | 90 | 5.566 | 91 | 5.553 | 92 | 5.501 |
| 93 | 5.315 | 94 | 5.590 | 95 | 5.385 | 96 | 5.650 |
| 97 | 5.614 | 98 | 5.705 | 99 | 5.276 | 100 | 5.469 |

Hopping Frequency Sequence Name: HOP_FREQ_SEQ_22

| SEQ# | Frequency (GHz) | SEQ# | Frequency (GHz) | SEQ# | Frequency (GHz) | SEQ# | Frequency (GHz) |
|------|-----------------|------|-----------------|------|-----------------|------|-----------------|
| 1 | 5.609 | 2 | 5.255 | 3 | 5.447 | 4 | 5.276 |
| 5 | 5.345 | 6 | 5.385 | 7 | 5.526 | 8 | 5.623 |
| 9 | 5.601 | 10 | 5.535 | 11 | 5.657 | 12 | 5.300 |
| 13 | 5.306 | 14 | 5.708 | 15 | 5.495 | 16 | 5.422 |
| 17 | 5.658 | 18 | 5.379 | 19 | 5.692 | 20 | 5.502 |
| 21 | 5.253 | 22 | 5.498 | 23 | 5.380 | 24 | 5.670 |
| 25 | 5.460 | 26 | 5.514 | 27 | 5.545 | 28 | 5.319 |
| 29 | 5.252 | 30 | 5.457 | 31 | 5.478 | 32 | 5.707 |
| 33 | 5.722 | 34 | 5.681 | 35 | 5.329 | 36 | 5.390 |
| 37 | 5.367 | 38 | 5.622 | 39 | 5.286 | 40 | 5.472 |
| 41 | 5.435 | 42 | 5.427 | 43 | 5.458 | 44 | 5.715 |
| 45 | 5.537 | 46 | 5.312 | 47 | 5.671 | 48 | 5.521 |
| 49 | 5.322 | 50 | 5.655 | 51 | 5.308 | 52 | 5.484 |
| 53 | 5.361 | 54 | 5.304 | 55 | 5.259 | 56 | 5.418 |
| 57 | 5.360 | 58 | 5.724 | 59 | 5.594 | 60 | 5.420 |
| 61 | 5.549 | 62 | 5.454 | 63 | 5.314 | 64 | 5.569 |
| 65 | 5.467 | 66 | 5.450 | 67 | 5.519 | 68 | 5.444 |
| 69 | 5.268 | 70 | 5.663 | 71 | 5.709 | 72 | 5.610 |
| 73 | 5.621 | 74 | 5.647 | 75 | 5.648 | 76 | 5.557 |
| 77 | 5.529 | 78 | 5.483 | 79 | 5.589 | 80 | 5.377 |
| 81 | 5.338 | 82 | 5.698 | 83 | 5.433 | 84 | 5.446 |
| 85 | 5.618 | 86 | 5.597 | 87 | 5.393 | 88 | 5.554 |
| 89 | 5.477 | 90 | 5.403 | 91 | 5.280 | 92 | 5.719 |
| 93 | 5.263 | 94 | 5.465 | 95 | 5.305 | 96 | 5.646 |
| 97 | 5.550 | 98 | 5.396 | 99 | 5.637 | 100 | 5.716 |

Hopping Frequency Sequence Name: HOP_FREQ_SEQ_23

| SEQ# | Frequency (GHz) | SEQ# | Frequency (GHz) | SEQ# | Frequency (GHz) | SEQ# | Frequency (GHz) |
|------|-----------------|------|-----------------|------|-----------------|------|-----------------|
| 1 | 5.401 | 2 | 5.459 | 3 | 5.412 | 4 | 5.639 |
| 5 | 5.383 | 6 | 5.630 | 7 | 5.689 | 8 | 5.673 |
| 9 | 5.441 | 10 | 5.384 | 11 | 5.432 | 12 | 5.451 |
| 13 | 5.608 | 14 | 5.440 | 15 | 5.593 | 16 | 5.398 |
| 17 | 5.590 | 18 | 5.280 | 19 | 5.339 | 20 | 5.257 |
| 21 | 5.702 | 22 | 5.422 | 23 | 5.648 | 24 | 5.683 |
| 25 | 5.642 | 26 | 5.479 | 27 | 5.354 | 28 | 5.718 |
| 29 | 5.633 | 30 | 5.620 | 31 | 5.562 | 32 | 5.334 |
| 33 | 5.515 | 34 | 5.546 | 35 | 5.585 | 36 | 5.486 |
| 37 | 5.366 | 38 | 5.409 | 39 | 5.375 | 40 | 5.392 |
| 41 | 5.482 | 42 | 5.313 | 43 | 5.660 | 44 | 5.279 |
| 45 | 5.563 | 46 | 5.617 | 47 | 5.694 | 48 | 5.307 |
| 49 | 5.314 | 50 | 5.376 | 51 | 5.447 | 52 | 5.697 |
| 53 | 5.393 | 54 | 5.698 | 55 | 5.335 | 56 | 5.358 |
| 57 | 5.503 | 58 | 5.605 | 59 | 5.712 | 60 | 5.413 |
| 61 | 5.285 | 62 | 5.662 | 63 | 5.576 | 64 | 5.429 |
| 65 | 5.365 | 66 | 5.653 | 67 | 5.284 | 68 | 5.687 |
| 69 | 5.415 | 70 | 5.315 | 71 | 5.347 | 72 | 5.722 |
| 73 | 5.613 | 74 | 5.372 | 75 | 5.425 | 76 | 5.504 |
| 77 | 5.723 | 78 | 5.330 | 79 | 5.672 | 80 | 5.473 |
| 81 | 5.423 | 82 | 5.618 | 83 | 5.526 | 84 | 5.452 |
| 85 | 5.301 | 86 | 5.460 | 87 | 5.652 | 88 | 5.592 |
| 89 | 5.547 | 90 | 5.286 | 91 | 5.614 | 92 | 5.603 |
| 93 | 5.696 | 94 | 5.484 | 95 | 5.721 | 96 | 5.343 |
| 97 | 5.519 | 98 | 5.667 | 99 | 5.407 | 100 | 5.489 |

Hopping Frequency Sequence Name: HOP_FREQ_SEQ_24

| SEQ# | Frequency (GHz) | SEQ# | Frequency (GHz) | SEQ# | Frequency (GHz) | SEQ# | Frequency (GHz) |
|------|-----------------|------|-----------------|------|-----------------|------|-----------------|
| 1 | 5.338 | 2 | 5.690 | 3 | 5.513 | 4 | 5.614 |
| 5 | 5.452 | 6 | 5.451 | 7 | 5.357 | 8 | 5.646 |
| 9 | 5.375 | 10 | 5.403 | 11 | 5.400 | 12 | 5.341 |
| 13 | 5.469 | 14 | 5.723 | 15 | 5.707 | 16 | 5.314 |
| 17 | 5.708 | 18 | 5.474 | 19 | 5.336 | 20 | 5.416 |
| 21 | 5.427 | 22 | 5.521 | 23 | 5.593 | 24 | 5.611 |
| 25 | 5.598 | 26 | 5.558 | 27 | 5.652 | 28 | 5.581 |
| 29 | 5.383 | 30 | 5.642 | 31 | 5.313 | 32 | 5.649 |
| 33 | 5.722 | 34 | 5.664 | 35 | 5.561 | 36 | 5.594 |
| 37 | 5.266 | 38 | 5.334 | 39 | 5.685 | 40 | 5.701 |
| 41 | 5.437 | 42 | 5.544 | 43 | 5.332 | 44 | 5.603 |
| 45 | 5.465 | 46 | 5.379 | 47 | 5.579 | 48 | 5.262 |
| 49 | 5.250 | 50 | 5.724 | 51 | 5.283 | 52 | 5.291 |
| 53 | 5.587 | 54 | 5.391 | 55 | 5.329 | 56 | 5.382 |
| 57 | 5.372 | 58 | 5.645 | 59 | 5.455 | 60 | 5.596 |
| 61 | 5.422 | 62 | 5.251 | 63 | 5.609 | 64 | 5.559 |
| 65 | 5.497 | 66 | 5.253 | 67 | 5.545 | 68 | 5.438 |
| 69 | 5.488 | 70 | 5.697 | 71 | 5.503 | 72 | 5.348 |
| 73 | 5.583 | 74 | 5.390 | 75 | 5.647 | 76 | 5.377 |
| 77 | 5.535 | 78 | 5.298 | 79 | 5.556 | 80 | 5.571 |
| 81 | 5.644 | 82 | 5.625 | 83 | 5.490 | 84 | 5.610 |
| 85 | 5.592 | 86 | 5.426 | 87 | 5.280 | 88 | 5.591 |
| 89 | 5.305 | 90 | 5.564 | 91 | 5.721 | 92 | 5.285 |
| 93 | 5.526 | 94 | 5.315 | 95 | 5.698 | 96 | 5.624 |
| 97 | 5.258 | 98 | 5.505 | 99 | 5.606 | 100 | 5.516 |

Hopping Frequency Sequence Name: HOP_FREQ_SEQ_25

| SEQ# | Frequency (GHz) | SEQ# | Frequency (GHz) | SEQ# | Frequency (GHz) | SEQ# | Frequency (GHz) |
|------|-----------------|------|-----------------|------|-----------------|------|-----------------|
| 1 | 5.337 | 2 | 5.639 | 3 | 5.406 | 4 | 5.583 |
| 5 | 5.403 | 6 | 5.551 | 7 | 5.705 | 8 | 5.571 |
| 9 | 5.488 | 10 | 5.253 | 11 | 5.519 | 12 | 5.369 |
| 13 | 5.575 | 14 | 5.445 | 15 | 5.511 | 16 | 5.419 |
| 17 | 5.619 | 18 | 5.261 | 19 | 5.473 | 20 | 5.710 |
| 21 | 5.580 | 22 | 5.657 | 23 | 5.446 | 24 | 5.508 |
| 25 | 5.355 | 26 | 5.634 | 27 | 5.334 | 28 | 5.460 |
| 29 | 5.648 | 30 | 5.546 | 31 | 5.608 | 32 | 5.674 |
| 33 | 5.534 | 34 | 5.723 | 35 | 5.256 | 36 | 5.629 |
| 37 | 5.459 | 38 | 5.352 | 39 | 5.293 | 40 | 5.517 |
| 41 | 5.322 | 42 | 5.467 | 43 | 5.557 | 44 | 5.672 |
| 45 | 5.703 | 46 | 5.415 | 47 | 5.296 | 48 | 5.547 |
| 49 | 5.435 | 50 | 5.465 | 51 | 5.260 | 52 | 5.282 |
| 53 | 5.374 | 54 | 5.430 | 55 | 5.494 | 56 | 5.640 |
| 57 | 5.268 | 58 | 5.432 | 59 | 5.392 | 60 | 5.307 |
| 61 | 5.393 | 62 | 5.344 | 63 | 5.416 | 64 | 5.285 |
| 65 | 5.638 | 66 | 5.597 | 67 | 5.516 | 68 | 5.690 |
| 69 | 5.449 | 70 | 5.504 | 71 | 5.572 | 72 | 5.669 |
| 73 | 5.594 | 74 | 5.532 | 75 | 5.628 | 76 | 5.673 |
| 77 | 5.448 | 78 | 5.537 | 79 | 5.326 | 80 | 5.266 |
| 81 | 5.697 | 82 | 5.522 | 83 | 5.678 | 84 | 5.655 |
| 85 | 5.422 | 86 | 5.317 | 87 | 5.602 | 88 | 5.264 |
| 89 | 5.589 | 90 | 5.627 | 91 | 5.491 | 92 | 5.701 |
| 93 | 5.436 | 94 | 5.680 | 95 | 5.478 | 96 | 5.558 |
| 97 | 5.320 | 98 | 5.662 | 99 | 5.525 | 100 | 5.434 |

Hopping Frequency Sequence Name: HOP_FREQ_SEQ_26

| SEQ# | Frequency (GHz) | SEQ# | Frequency (GHz) | SEQ# | Frequency (GHz) | SEQ# | Frequency (GHz) |
|------|-----------------|------|-----------------|------|-----------------|------|-----------------|
| 1 | 5.518 | 2 | 5.489 | 3 | 5.280 | 4 | 5.598 |
| 5 | 5.417 | 6 | 5.447 | 7 | 5.418 | 8 | 5.400 |
| 9 | 5.674 | 10 | 5.631 | 11 | 5.668 | 12 | 5.577 |
| 13 | 5.654 | 14 | 5.251 | 15 | 5.570 | 16 | 5.649 |
| 17 | 5.318 | 18 | 5.373 | 19 | 5.558 | 20 | 5.544 |
| 21 | 5.331 | 22 | 5.695 | 23 | 5.395 | 24 | 5.628 |
| 25 | 5.551 | 26 | 5.338 | 27 | 5.678 | 28 | 5.375 |
| 29 | 5.448 | 30 | 5.254 | 31 | 5.693 | 32 | 5.273 |
| 33 | 5.501 | 34 | 5.596 | 35 | 5.406 | 36 | 5.295 |
| 37 | 5.253 | 38 | 5.430 | 39 | 5.315 | 40 | 5.650 |
| 41 | 5.565 | 42 | 5.504 | 43 | 5.533 | 44 | 5.664 |
| 45 | 5.547 | 46 | 5.307 | 47 | 5.385 | 48 | 5.561 |
| 49 | 5.521 | 50 | 5.303 | 51 | 5.383 | 52 | 5.525 |
| 53 | 5.300 | 54 | 5.641 | 55 | 5.613 | 56 | 5.291 |
| 57 | 5.614 | 58 | 5.588 | 59 | 5.365 | 60 | 5.294 |
| 61 | 5.600 | 62 | 5.445 | 63 | 5.387 | 64 | 5.468 |
| 65 | 5.405 | 66 | 5.429 | 67 | 5.450 | 68 | 5.288 |
| 69 | 5.462 | 70 | 5.464 | 71 | 5.443 | 72 | 5.659 |
| 73 | 5.344 | 74 | 5.636 | 75 | 5.611 | 76 | 5.432 |
| 77 | 5.341 | 78 | 5.532 | 79 | 5.420 | 80 | 5.449 |
| 81 | 5.284 | 82 | 5.414 | 83 | 5.724 | 84 | 5.440 |
| 85 | 5.556 | 86 | 5.455 | 87 | 5.499 | 88 | 5.474 |
| 89 | 5.481 | 90 | 5.363 | 91 | 5.478 | 92 | 5.456 |
| 93 | 5.264 | 94 | 5.633 | 95 | 5.589 | 96 | 5.686 |
| 97 | 5.538 | 98 | 5.569 | 99 | 5.524 | 100 | 5.578 |

Hopping Frequency Sequence Name: HOP_FREQ_SEQ_27

| SEQ# | Frequency (GHz) | SEQ# | Frequency (GHz) | SEQ# | Frequency (GHz) | SEQ# | Frequency (GHz) |
|------|-----------------|------|-----------------|------|-----------------|------|-----------------|
| 1 | 5.368 | 2 | 5.583 | 3 | 5.564 | 4 | 5.520 |
| 5 | 5.428 | 6 | 5.366 | 7 | 5.611 | 8 | 5.390 |
| 9 | 5.616 | 10 | 5.556 | 11 | 5.539 | 12 | 5.485 |
| 13 | 5.360 | 14 | 5.302 | 15 | 5.581 | 16 | 5.614 |
| 17 | 5.353 | 18 | 5.358 | 19 | 5.582 | 20 | 5.325 |
| 21 | 5.348 | 22 | 5.292 | 23 | 5.287 | 24 | 5.567 |
| 25 | 5.615 | 26 | 5.346 | 27 | 5.531 | 28 | 5.263 |
| 29 | 5.272 | 30 | 5.282 | 31 | 5.657 | 32 | 5.554 |
| 33 | 5.618 | 34 | 5.580 | 35 | 5.525 | 36 | 5.291 |
| 37 | 5.715 | 38 | 5.343 | 39 | 5.534 | 40 | 5.312 |
| 41 | 5.275 | 42 | 5.270 | 43 | 5.718 | 44 | 5.696 |
| 45 | 5.671 | 46 | 5.307 | 47 | 5.332 | 48 | 5.721 |
| 49 | 5.462 | 50 | 5.714 | 51 | 5.451 | 52 | 5.679 |
| 53 | 5.422 | 54 | 5.317 | 55 | 5.640 | 56 | 5.695 |
| 57 | 5.722 | 58 | 5.598 | 59 | 5.607 | 60 | 5.648 |
| 61 | 5.547 | 62 | 5.396 | 63 | 5.523 | 64 | 5.659 |
| 65 | 5.624 | 66 | 5.584 | 67 | 5.660 | 68 | 5.452 |
| 69 | 5.550 | 70 | 5.440 | 71 | 5.683 | 72 | 5.382 |
| 73 | 5.562 | 74 | 5.578 | 75 | 5.513 | 76 | 5.393 |
| 77 | 5.379 | 78 | 5.409 | 79 | 5.362 | 80 | 5.297 |
| 81 | 5.597 | 82 | 5.337 | 83 | 5.711 | 84 | 5.460 |
| 85 | 5.576 | 86 | 5.605 | 87 | 5.645 | 88 | 5.591 |
| 89 | 5.667 | 90 | 5.398 | 91 | 5.456 | 92 | 5.380 |
| 93 | 5.710 | 94 | 5.636 | 95 | 5.315 | 96 | 5.277 |
| 97 | 5.441 | 98 | 5.676 | 99 | 5.593 | 100 | 5.394 |

Hopping Frequency Sequence Name: HOP_FREQ_SEQ_28

| SEQ# | Frequency (GHz) | SEQ# | Frequency (GHz) | SEQ# | Frequency (GHz) | SEQ# | Frequency (GHz) |
|------|-----------------|------|-----------------|------|-----------------|------|-----------------|
| 1 | 5.336 | 2 | 5.506 | 3 | 5.514 | 4 | 5.286 |
| 5 | 5.715 | 6 | 5.452 | 7 | 5.408 | 8 | 5.722 |
| 9 | 5.332 | 10 | 5.606 | 11 | 5.608 | 12 | 5.630 |
| 13 | 5.676 | 14 | 5.547 | 15 | 5.568 | 16 | 5.436 |
| 17 | 5.503 | 18 | 5.344 | 19 | 5.723 | 20 | 5.331 |
| 21 | 5.637 | 22 | 5.454 | 23 | 5.589 | 24 | 5.517 |
| 25 | 5.586 | 26 | 5.474 | 27 | 5.267 | 28 | 5.686 |
| 29 | 5.333 | 30 | 5.540 | 31 | 5.585 | 32 | 5.678 |
| 33 | 5.482 | 34 | 5.549 | 35 | 5.473 | 36 | 5.695 |
| 37 | 5.412 | 38 | 5.600 | 39 | 5.620 | 40 | 5.272 |
| 41 | 5.499 | 42 | 5.424 | 43 | 5.366 | 44 | 5.594 |
| 45 | 5.526 | 46 | 5.625 | 47 | 5.632 | 48 | 5.572 |
| 49 | 5.260 | 50 | 5.463 | 51 | 5.679 | 52 | 5.444 |
| 53 | 5.716 | 54 | 5.388 | 55 | 5.587 | 56 | 5.592 |
| 57 | 5.399 | 58 | 5.327 | 59 | 5.607 | 60 | 5.529 |
| 61 | 5.455 | 62 | 5.554 | 63 | 5.688 | 64 | 5.534 |
| 65 | 5.250 | 66 | 5.295 | 67 | 5.541 | 68 | 5.402 |
| 69 | 5.551 | 70 | 5.595 | 71 | 5.459 | 72 | 5.516 |
| 73 | 5.467 | 74 | 5.544 | 75 | 5.358 | 76 | 5.393 |
| 77 | 5.490 | 78 | 5.656 | 79 | 5.493 | 80 | 5.639 |
| 81 | 5.410 | 82 | 5.494 | 83 | 5.346 | 84 | 5.304 |
| 85 | 5.357 | 86 | 5.616 | 87 | 5.339 | 88 | 5.316 |
| 89 | 5.318 | 90 | 5.510 | 91 | 5.405 | 92 | 5.697 |
| 93 | 5.483 | 94 | 5.535 | 95 | 5.672 | 96 | 5.645 |
| 97 | 5.558 | 98 | 5.284 | 99 | 5.460 | 100 | 5.519 |

Hopping Frequency Sequence Name: HOP_FREQ_SEQ_29

| SEQ# | Frequency (GHz) | SEQ# | Frequency (GHz) | SEQ# | Frequency (GHz) | SEQ# | Frequency (GHz) |
|------|-----------------|------|-----------------|------|-----------------|------|-----------------|
| 1 | 5.666 | 2 | 5.685 | 3 | 5.395 | 4 | 5.370 |
| 5 | 5.611 | 6 | 5.291 | 7 | 5.687 | 8 | 5.327 |
| 9 | 5.307 | 10 | 5.486 | 11 | 5.389 | 12 | 5.604 |
| 13 | 5.319 | 14 | 5.463 | 15 | 5.445 | 16 | 5.357 |
| 17 | 5.415 | 18 | 5.721 | 19 | 5.587 | 20 | 5.585 |
| 21 | 5.558 | 22 | 5.574 | 23 | 5.675 | 24 | 5.566 |
| 25 | 5.679 | 26 | 5.570 | 27 | 5.488 | 28 | 5.640 |
| 29 | 5.406 | 30 | 5.617 | 31 | 5.386 | 32 | 5.592 |
| 33 | 5.382 | 34 | 5.448 | 35 | 5.479 | 36 | 5.461 |
| 37 | 5.273 | 38 | 5.671 | 39 | 5.458 | 40 | 5.432 |
| 41 | 5.544 | 42 | 5.271 | 43 | 5.628 | 44 | 5.343 |
| 45 | 5.689 | 46 | 5.709 | 47 | 5.691 | 48 | 5.529 |
| 49 | 5.540 | 50 | 5.633 | 51 | 5.623 | 52 | 5.667 |
| 53 | 5.536 | 54 | 5.277 | 55 | 5.577 | 56 | 5.625 |
| 57 | 5.454 | 58 | 5.595 | 59 | 5.660 | 60 | 5.564 |
| 61 | 5.673 | 62 | 5.362 | 63 | 5.692 | 64 | 5.252 |
| 65 | 5.680 | 66 | 5.304 | 67 | 5.459 | 68 | 5.436 |
| 69 | 5.314 | 70 | 5.723 | 71 | 5.423 | 72 | 5.651 |
| 73 | 5.435 | 74 | 5.553 | 75 | 5.562 | 76 | 5.602 |
| 77 | 5.368 | 78 | 5.646 | 79 | 5.441 | 80 | 5.412 |
| 81 | 5.718 | 82 | 5.552 | 83 | 5.430 | 84 | 5.607 |
| 85 | 5.404 | 86 | 5.393 | 87 | 5.420 | 88 | 5.672 |
| 89 | 5.669 | 90 | 5.596 | 91 | 5.384 | 92 | 5.428 |
| 93 | 5.495 | 94 | 5.268 | 95 | 5.606 | 96 | 5.551 |
| 97 | 5.377 | 98 | 5.588 | 99 | 5.352 | 100 | 5.477 |

Hopping Frequency Sequence Name: HOP_FREQ_SEQ_30

| SEQ# | Frequency (GHz) | SEQ# | Frequency (GHz) | SEQ# | Frequency (GHz) | SEQ# | Frequency (GHz) |
|------|-----------------|------|-----------------|------|-----------------|------|-----------------|
| 1 | 5.458 | 2 | 5.613 | 3 | 5.717 | 4 | 5.475 |
| 5 | 5.607 | 6 | 5.589 | 7 | 5.417 | 8 | 5.406 |
| 9 | 5.298 | 10 | 5.318 | 11 | 5.710 | 12 | 5.667 |
| 13 | 5.351 | 14 | 5.347 | 15 | 5.300 | 16 | 5.619 |
| 17 | 5.309 | 18 | 5.502 | 19 | 5.578 | 20 | 5.639 |
| 21 | 5.573 | 22 | 5.448 | 23 | 5.462 | 24 | 5.721 |
| 25 | 5.389 | 26 | 5.509 | 27 | 5.414 | 28 | 5.443 |
| 29 | 5.262 | 30 | 5.571 | 31 | 5.558 | 32 | 5.285 |
| 33 | 5.529 | 34 | 5.606 | 35 | 5.419 | 36 | 5.352 |
| 37 | 5.566 | 38 | 5.459 | 39 | 5.304 | 40 | 5.398 |
| 41 | 5.339 | 42 | 5.408 | 43 | 5.281 | 44 | 5.663 |
| 45 | 5.690 | 46 | 5.405 | 47 | 5.335 | 48 | 5.577 |
| 49 | 5.491 | 50 | 5.424 | 51 | 5.411 | 52 | 5.581 |
| 53 | 5.715 | 54 | 5.686 | 55 | 5.267 | 56 | 5.594 |
| 57 | 5.277 | 58 | 5.596 | 59 | 5.457 | 60 | 5.554 |
| 61 | 5.388 | 62 | 5.669 | 63 | 5.474 | 64 | 5.720 |
| 65 | 5.453 | 66 | 5.658 | 67 | 5.500 | 68 | 5.677 |
| 69 | 5.358 | 70 | 5.287 | 71 | 5.338 | 72 | 5.394 |
| 73 | 5.609 | 74 | 5.676 | 75 | 5.353 | 76 | 5.379 |
| 77 | 5.616 | 78 | 5.625 | 79 | 5.257 | 80 | 5.595 |
| 81 | 5.588 | 82 | 5.426 | 83 | 5.556 | 84 | 5.680 |
| 85 | 5.373 | 86 | 5.674 | 87 | 5.350 | 88 | 5.628 |
| 89 | 5.423 | 90 | 5.418 | 91 | 5.260 | 92 | 5.590 |
| 93 | 5.392 | 94 | 5.532 | 95 | 5.478 | 96 | 5.582 |
| 97 | 5.562 | 98 | 5.326 | 99 | 5.548 | 100 | 5.286 |

802.11ax (HE40)

Hopping Frequency Sequence Name: HOP_FREQ_SEQ_01

| SEQ# | Frequency (GHz) | SEQ# | Frequency (GHz) | SEQ# | Frequency (GHz) | SEQ# | Frequency (GHz) |
|------|-----------------|------|-----------------|------|-----------------|------|-----------------|
| 1 | 5.603 | 2 | 5.405 | 3 | 5.498 | 4 | 5.670 |
| 5 | 5.630 | 6 | 5.712 | 7 | 5.653 | 8 | 5.285 |
| 9 | 5.399 | 10 | 5.541 | 11 | 5.704 | 12 | 5.323 |
| 13 | 5.532 | 14 | 5.366 | 15 | 5.410 | 16 | 5.581 |
| 17 | 5.612 | 18 | 5.467 | 19 | 5.312 | 20 | 5.554 |
| 21 | 5.520 | 22 | 5.551 | 23 | 5.575 | 24 | 5.448 |
| 25 | 5.414 | 26 | 5.598 | 27 | 5.354 | 28 | 5.708 |
| 29 | 5.332 | 30 | 5.288 | 31 | 5.310 | 32 | 5.456 |
| 33 | 5.397 | 34 | 5.361 | 35 | 5.390 | 36 | 5.380 |
| 37 | 5.620 | 38 | 5.652 | 39 | 5.666 | 40 | 5.457 |
| 41 | 5.296 | 42 | 5.631 | 43 | 5.411 | 44 | 5.470 |
| 45 | 5.526 | 46 | 5.472 | 47 | 5.628 | 48 | 5.375 |
| 49 | 5.649 | 50 | 5.656 | 51 | 5.408 | 52 | 5.393 |
| 53 | 5.514 | 54 | 5.348 | 55 | 5.523 | 56 | 5.709 |
| 57 | 5.311 | 58 | 5.284 | 59 | 5.552 | 60 | 5.427 |
| 61 | 5.255 | 62 | 5.395 | 63 | 5.536 | 64 | 5.626 |
| 65 | 5.389 | 66 | 5.297 | 67 | 5.679 | 68 | 5.545 |
| 69 | 5.496 | 70 | 5.617 | 71 | 5.283 | 72 | 5.508 |
| 73 | 5.299 | 74 | 5.319 | 75 | 5.624 | 76 | 5.440 |
| 77 | 5.677 | 78 | 5.643 | 79 | 5.558 | 80 | 5.252 |
| 81 | 5.671 | 82 | 5.378 | 83 | 5.680 | 84 | 5.547 |
| 85 | 5.683 | 86 | 5.453 | 87 | 5.466 | 88 | 5.471 |
| 89 | 5.548 | 90 | 5.356 | 91 | 5.486 | 92 | 5.684 |
| 93 | 5.669 | 94 | 5.349 | 95 | 5.504 | 96 | 5.641 |
| 97 | 5.495 | 98 | 5.578 | 99 | 5.702 | 100 | 5.706 |

Hopping Frequency Sequence Name: HOP_FREQ_SEQ_02

| SEQ# | Frequency (GHz) | SEQ# | Frequency (GHz) | SEQ# | Frequency (GHz) | SEQ# | Frequency (GHz) |
|------|-----------------|------|-----------------|------|-----------------|------|-----------------|
| 1 | 5.328 | 2 | 5.655 | 3 | 5.570 | 4 | 5.291 |
| 5 | 5.485 | 6 | 5.342 | 7 | 5.365 | 8 | 5.720 |
| 9 | 5.647 | 10 | 5.264 | 11 | 5.362 | 12 | 5.403 |
| 13 | 5.392 | 14 | 5.284 | 15 | 5.363 | 16 | 5.461 |
| 17 | 5.346 | 18 | 5.381 | 19 | 5.598 | 20 | 5.528 |
| 21 | 5.640 | 22 | 5.315 | 23 | 5.500 | 24 | 5.539 |
| 25 | 5.531 | 26 | 5.459 | 27 | 5.603 | 28 | 5.372 |
| 29 | 5.499 | 30 | 5.263 | 31 | 5.329 | 32 | 5.366 |
| 33 | 5.431 | 34 | 5.586 | 35 | 5.536 | 36 | 5.266 |
| 37 | 5.376 | 38 | 5.654 | 39 | 5.701 | 40 | 5.285 |
| 41 | 5.699 | 42 | 5.327 | 43 | 5.450 | 44 | 5.567 |
| 45 | 5.680 | 46 | 5.581 | 47 | 5.270 | 48 | 5.633 |
| 49 | 5.676 | 50 | 5.353 | 51 | 5.456 | 52 | 5.454 |
| 53 | 5.446 | 54 | 5.532 | 55 | 5.665 | 56 | 5.443 |
| 57 | 5.432 | 58 | 5.371 | 59 | 5.269 | 60 | 5.559 |
| 61 | 5.386 | 62 | 5.535 | 63 | 5.308 | 64 | 5.451 |
| 65 | 5.276 | 66 | 5.718 | 67 | 5.719 | 68 | 5.287 |
| 69 | 5.636 | 70 | 5.292 | 71 | 5.490 | 72 | 5.700 |
| 73 | 5.303 | 74 | 5.569 | 75 | 5.489 | 76 | 5.364 |
| 77 | 5.564 | 78 | 5.335 | 79 | 5.340 | 80 | 5.326 |
| 81 | 5.677 | 82 | 5.375 | 83 | 5.664 | 84 | 5.427 |
| 85 | 5.538 | 86 | 5.509 | 87 | 5.420 | 88 | 5.344 |
| 89 | 5.462 | 90 | 5.682 | 91 | 5.565 | 92 | 5.691 |
| 93 | 5.355 | 94 | 5.687 | 95 | 5.652 | 96 | 5.352 |
| 97 | 5.416 | 98 | 5.286 | 99 | 5.684 | 100 | 5.425 |

Hopping Frequency Sequence Name: HOP_FREQ_SEQ_03

| SEQ# | Frequency (GHz) | SEQ# | Frequency (GHz) | SEQ# | Frequency (GHz) | SEQ# | Frequency (GHz) |
|------|-----------------|------|-----------------|------|-----------------|------|-----------------|
| 1 | 5.715 | 2 | 5.431 | 3 | 5.262 | 4 | 5.608 |
| 5 | 5.436 | 6 | 5.354 | 7 | 5.555 | 8 | 5.545 |
| 9 | 5.322 | 10 | 5.379 | 11 | 5.513 | 12 | 5.254 |
| 13 | 5.468 | 14 | 5.449 | 15 | 5.470 | 16 | 5.616 |
| 17 | 5.287 | 18 | 5.393 | 19 | 5.560 | 20 | 5.256 |
| 21 | 5.689 | 22 | 5.647 | 23 | 5.707 | 24 | 5.413 |
| 25 | 5.364 | 26 | 5.445 | 27 | 5.485 | 28 | 5.615 |
| 29 | 5.566 | 30 | 5.610 | 31 | 5.359 | 32 | 5.723 |
| 33 | 5.629 | 34 | 5.312 | 35 | 5.296 | 36 | 5.341 |
| 37 | 5.400 | 38 | 5.611 | 39 | 5.475 | 40 | 5.463 |
| 41 | 5.625 | 42 | 5.412 | 43 | 5.573 | 44 | 5.434 |
| 45 | 5.457 | 46 | 5.540 | 47 | 5.264 | 48 | 5.496 |
| 49 | 5.706 | 50 | 5.724 | 51 | 5.597 | 52 | 5.299 |
| 53 | 5.324 | 54 | 5.539 | 55 | 5.455 | 56 | 5.547 |
| 57 | 5.542 | 58 | 5.631 | 59 | 5.367 | 60 | 5.363 |
| 61 | 5.601 | 62 | 5.714 | 63 | 5.590 | 64 | 5.365 |
| 65 | 5.578 | 66 | 5.453 | 67 | 5.416 | 68 | 5.471 |
| 69 | 5.698 | 70 | 5.323 | 71 | 5.605 | 72 | 5.635 |
| 73 | 5.537 | 74 | 5.352 | 75 | 5.339 | 76 | 5.378 |
| 77 | 5.317 | 78 | 5.257 | 79 | 5.717 | 80 | 5.637 |
| 81 | 5.654 | 82 | 5.361 | 83 | 5.511 | 84 | 5.510 |
| 85 | 5.380 | 86 | 5.594 | 87 | 5.699 | 88 | 5.600 |
| 89 | 5.648 | 90 | 5.683 | 91 | 5.671 | 92 | 5.283 |
| 93 | 5.684 | 94 | 5.508 | 95 | 5.337 | 96 | 5.342 |
| 97 | 5.617 | 98 | 5.278 | 99 | 5.398 | 100 | 5.497 |

Hopping Frequency Sequence Name: HOP_FREQ_SEQ_04

| SEQ# | Frequency (GHz) | SEQ# | Frequency (GHz) | SEQ# | Frequency (GHz) | SEQ# | Frequency (GHz) |
|------|-----------------|------|-----------------|------|-----------------|------|-----------------|
| 1 | 5.267 | 2 | 5.612 | 3 | 5.554 | 4 | 5.569 |
| 5 | 5.698 | 6 | 5.718 | 7 | 5.288 | 8 | 5.716 |
| 9 | 5.621 | 10 | 5.723 | 11 | 5.322 | 12 | 5.511 |
| 13 | 5.570 | 14 | 5.683 | 15 | 5.721 | 16 | 5.530 |
| 17 | 5.508 | 18 | 5.451 | 19 | 5.416 | 20 | 5.521 |
| 21 | 5.501 | 22 | 5.460 | 23 | 5.527 | 24 | 5.699 |
| 25 | 5.363 | 26 | 5.470 | 27 | 5.304 | 28 | 5.623 |
| 29 | 5.453 | 30 | 5.426 | 31 | 5.441 | 32 | 5.579 |
| 33 | 5.398 | 34 | 5.669 | 35 | 5.333 | 36 | 5.468 |
| 37 | 5.557 | 38 | 5.517 | 39 | 5.665 | 40 | 5.610 |
| 41 | 5.448 | 42 | 5.629 | 43 | 5.380 | 44 | 5.262 |
| 45 | 5.597 | 46 | 5.285 | 47 | 5.318 | 48 | 5.266 |
| 49 | 5.270 | 50 | 5.381 | 51 | 5.315 | 52 | 5.401 |
| 53 | 5.463 | 54 | 5.298 | 55 | 5.607 | 56 | 5.700 |
| 57 | 5.711 | 58 | 5.417 | 59 | 5.717 | 60 | 5.360 |
| 61 | 5.429 | 62 | 5.654 | 63 | 5.524 | 64 | 5.496 |
| 65 | 5.445 | 66 | 5.499 | 67 | 5.280 | 68 | 5.386 |
| 69 | 5.351 | 70 | 5.687 | 71 | 5.584 | 72 | 5.356 |
| 73 | 5.661 | 74 | 5.589 | 75 | 5.663 | 76 | 5.657 |
| 77 | 5.478 | 78 | 5.659 | 79 | 5.389 | 80 | 5.513 |
| 81 | 5.555 | 82 | 5.458 | 83 | 5.502 | 84 | 5.420 |
| 85 | 5.549 | 86 | 5.690 | 87 | 5.641 | 88 | 5.648 |
| 89 | 5.452 | 90 | 5.473 | 91 | 5.542 | 92 | 5.588 |
| 93 | 5.632 | 94 | 5.439 | 95 | 5.250 | 96 | 5.348 |
| 97 | 5.466 | 98 | 5.541 | 99 | 5.481 | 100 | 5.562 |

Hopping Frequency Sequence Name: HOP_FREQ_SEQ_05

| SEQ# | Frequency (GHz) | SEQ# | Frequency (GHz) | SEQ# | Frequency (GHz) | SEQ# | Frequency (GHz) |
|------|-----------------|------|-----------------|------|-----------------|------|-----------------|
| 1 | 5.538 | 2 | 5.423 | 3 | 5.481 | 4 | 5.307 |
| 5 | 5.357 | 6 | 5.593 | 7 | 5.615 | 8 | 5.404 |
| 9 | 5.711 | 10 | 5.490 | 11 | 5.550 | 12 | 5.416 |
| 13 | 5.519 | 14 | 5.541 | 15 | 5.339 | 16 | 5.612 |
| 17 | 5.699 | 18 | 5.653 | 19 | 5.350 | 20 | 5.369 |
| 21 | 5.373 | 22 | 5.656 | 23 | 5.672 | 24 | 5.688 |
| 25 | 5.403 | 26 | 5.522 | 27 | 5.665 | 28 | 5.675 |
| 29 | 5.297 | 30 | 5.402 | 31 | 5.588 | 32 | 5.673 |
| 33 | 5.421 | 34 | 5.512 | 35 | 5.537 | 36 | 5.715 |
| 37 | 5.299 | 38 | 5.686 | 39 | 5.263 | 40 | 5.679 |
| 41 | 5.391 | 42 | 5.313 | 43 | 5.480 | 44 | 5.561 |
| 45 | 5.523 | 46 | 5.389 | 47 | 5.692 | 48 | 5.569 |
| 49 | 5.556 | 50 | 5.578 | 51 | 5.425 | 52 | 5.517 |
| 53 | 5.475 | 54 | 5.532 | 55 | 5.255 | 56 | 5.375 |
| 57 | 5.349 | 58 | 5.436 | 59 | 5.424 | 60 | 5.271 |
| 61 | 5.390 | 62 | 5.585 | 63 | 5.652 | 64 | 5.486 |
| 65 | 5.722 | 66 | 5.280 | 67 | 5.554 | 68 | 5.514 |
| 69 | 5.587 | 70 | 5.683 | 71 | 5.321 | 72 | 5.547 |
| 73 | 5.590 | 74 | 5.432 | 75 | 5.548 | 76 | 5.657 |
| 77 | 5.279 | 78 | 5.693 | 79 | 5.671 | 80 | 5.539 |
| 81 | 5.438 | 82 | 5.301 | 83 | 5.544 | 84 | 5.670 |
| 85 | 5.346 | 86 | 5.463 | 87 | 5.394 | 88 | 5.567 |
| 89 | 5.526 | 90 | 5.434 | 91 | 5.467 | 92 | 5.611 |
| 93 | 5.295 | 94 | 5.647 | 95 | 5.602 | 96 | 5.318 |
| 97 | 5.714 | 98 | 5.649 | 99 | 5.695 | 100 | 5.630 |

Hopping Frequency Sequence Name: HOP_FREQ_SEQ_06

| SEQ# | Frequency (GHz) | SEQ# | Frequency (GHz) | SEQ# | Frequency (GHz) | SEQ# | Frequency (GHz) |
|------|-----------------|------|-----------------|------|-----------------|------|-----------------|
| 1 | 5.527 | 2 | 5.604 | 3 | 5.380 | 4 | 5.393 |
| 5 | 5.280 | 6 | 5.665 | 7 | 5.273 | 8 | 5.473 |
| 9 | 5.566 | 10 | 5.647 | 11 | 5.694 | 12 | 5.645 |
| 13 | 5.528 | 14 | 5.359 | 15 | 5.369 | 16 | 5.564 |
| 17 | 5.497 | 18 | 5.669 | 19 | 5.508 | 20 | 5.459 |
| 21 | 5.342 | 22 | 5.563 | 23 | 5.531 | 24 | 5.605 |
| 25 | 5.322 | 26 | 5.436 | 27 | 5.394 | 28 | 5.611 |
| 29 | 5.295 | 30 | 5.441 | 31 | 5.622 | 32 | 5.469 |
| 33 | 5.652 | 34 | 5.638 | 35 | 5.308 | 36 | 5.375 |
| 37 | 5.374 | 38 | 5.309 | 39 | 5.439 | 40 | 5.626 |
| 41 | 5.688 | 42 | 5.345 | 43 | 5.514 | 44 | 5.646 |
| 45 | 5.602 | 46 | 5.666 | 47 | 5.254 | 48 | 5.271 |
| 49 | 5.347 | 50 | 5.470 | 51 | 5.408 | 52 | 5.700 |
| 53 | 5.467 | 54 | 5.480 | 55 | 5.337 | 56 | 5.673 |
| 57 | 5.506 | 58 | 5.417 | 59 | 5.512 | 60 | 5.348 |
| 61 | 5.317 | 62 | 5.621 | 63 | 5.368 | 64 | 5.557 |
| 65 | 5.722 | 66 | 5.266 | 67 | 5.363 | 68 | 5.678 |
| 69 | 5.305 | 70 | 5.485 | 71 | 5.352 | 72 | 5.668 |
| 73 | 5.720 | 74 | 5.509 | 75 | 5.403 | 76 | 5.460 |
| 77 | 5.351 | 78 | 5.556 | 79 | 5.259 | 80 | 5.629 |
| 81 | 5.454 | 82 | 5.723 | 83 | 5.291 | 84 | 5.356 |
| 85 | 5.496 | 86 | 5.681 | 87 | 5.376 | 88 | 5.689 |
| 89 | 5.461 | 90 | 5.711 | 91 | 5.381 | 92 | 5.279 |
| 93 | 5.267 | 94 | 5.533 | 95 | 5.367 | 96 | 5.361 |
| 97 | 5.468 | 98 | 5.389 | 99 | 5.261 | 100 | 5.357 |

Hopping Frequency Sequence Name: HOP_FREQ_SEQ_07

| SEQ# | Frequency (GHz) | SEQ# | Frequency (GHz) | SEQ# | Frequency (GHz) | SEQ# | Frequency (GHz) |
|------|-----------------|------|-----------------|------|-----------------|------|-----------------|
| 1 | 5.273 | 2 | 5.275 | 3 | 5.630 | 4 | 5.277 |
| 5 | 5.532 | 6 | 5.396 | 7 | 5.342 | 8 | 5.379 |
| 9 | 5.283 | 10 | 5.475 | 11 | 5.423 | 12 | 5.571 |
| 13 | 5.516 | 14 | 5.382 | 15 | 5.467 | 16 | 5.429 |
| 17 | 5.537 | 18 | 5.386 | 19 | 5.678 | 20 | 5.544 |
| 21 | 5.657 | 22 | 5.527 | 23 | 5.340 | 24 | 5.470 |
| 25 | 5.440 | 26 | 5.332 | 27 | 5.406 | 28 | 5.373 |
| 29 | 5.299 | 30 | 5.385 | 31 | 5.314 | 32 | 5.255 |
| 33 | 5.503 | 34 | 5.507 | 35 | 5.335 | 36 | 5.476 |
| 37 | 5.310 | 38 | 5.383 | 39 | 5.337 | 40 | 5.518 |
| 41 | 5.464 | 42 | 5.674 | 43 | 5.560 | 44 | 5.322 |
| 45 | 5.631 | 46 | 5.446 | 47 | 5.270 | 48 | 5.708 |
| 49 | 5.590 | 50 | 5.365 | 51 | 5.591 | 52 | 5.706 |
| 53 | 5.318 | 54 | 5.402 | 55 | 5.703 | 56 | 5.662 |
| 57 | 5.457 | 58 | 5.414 | 59 | 5.278 | 60 | 5.308 |
| 61 | 5.569 | 62 | 5.407 | 63 | 5.426 | 64 | 5.376 |
| 65 | 5.321 | 66 | 5.384 | 67 | 5.381 | 68 | 5.542 |
| 69 | 5.558 | 70 | 5.472 | 71 | 5.684 | 72 | 5.553 |
| 73 | 5.306 | 74 | 5.401 | 75 | 5.715 | 76 | 5.458 |
| 77 | 5.575 | 78 | 5.654 | 79 | 5.352 | 80 | 5.671 |
| 81 | 5.710 | 82 | 5.479 | 83 | 5.690 | 84 | 5.297 |
| 85 | 5.528 | 86 | 5.276 | 87 | 5.368 | 88 | 5.585 |
| 89 | 5.596 | 90 | 5.353 | 91 | 5.681 | 92 | 5.442 |
| 93 | 5.266 | 94 | 5.268 | 95 | 5.291 | 96 | 5.615 |
| 97 | 5.416 | 98 | 5.699 | 99 | 5.663 | 100 | 5.293 |

Hopping Frequency Sequence Name: HOP_FREQ_SEQ_08

| SEQ# | Frequency (GHz) | SEQ# | Frequency (GHz) | SEQ# | Frequency (GHz) | SEQ# | Frequency (GHz) |
|------|-----------------|------|-----------------|------|-----------------|------|-----------------|
| 1 | 5.706 | 2 | 5.662 | 3 | 5.360 | 4 | 5.585 |
| 5 | 5.609 | 6 | 5.471 | 7 | 5.569 | 8 | 5.485 |
| 9 | 5.292 | 10 | 5.673 | 11 | 5.486 | 12 | 5.626 |
| 13 | 5.430 | 14 | 5.563 | 15 | 5.659 | 16 | 5.287 |
| 17 | 5.687 | 18 | 5.719 | 19 | 5.616 | 20 | 5.668 |
| 21 | 5.621 | 22 | 5.591 | 23 | 5.329 | 24 | 5.558 |
| 25 | 5.540 | 26 | 5.623 | 27 | 5.393 | 28 | 5.712 |
| 29 | 5.689 | 30 | 5.370 | 31 | 5.451 | 32 | 5.545 |
| 33 | 5.448 | 34 | 5.394 | 35 | 5.588 | 36 | 5.633 |
| 37 | 5.561 | 38 | 5.418 | 39 | 5.522 | 40 | 5.707 |
| 41 | 5.480 | 42 | 5.414 | 43 | 5.491 | 44 | 5.312 |
| 45 | 5.704 | 46 | 5.317 | 47 | 5.291 | 48 | 5.319 |
| 49 | 5.321 | 50 | 5.681 | 51 | 5.273 | 52 | 5.473 |
| 53 | 5.547 | 54 | 5.457 | 55 | 5.404 | 56 | 5.456 |
| 57 | 5.296 | 58 | 5.299 | 59 | 5.358 | 60 | 5.684 |
| 61 | 5.705 | 62 | 5.581 | 63 | 5.355 | 64 | 5.592 |
| 65 | 5.575 | 66 | 5.436 | 67 | 5.284 | 68 | 5.381 |
| 69 | 5.542 | 70 | 5.388 | 71 | 5.267 | 72 | 5.254 |
| 73 | 5.643 | 74 | 5.257 | 75 | 5.618 | 76 | 5.332 |
| 77 | 5.560 | 78 | 5.647 | 79 | 5.362 | 80 | 5.677 |
| 81 | 5.670 | 82 | 5.651 | 83 | 5.656 | 84 | 5.425 |
| 85 | 5.584 | 86 | 5.612 | 87 | 5.379 | 88 | 5.368 |
| 89 | 5.600 | 90 | 5.489 | 91 | 5.657 | 92 | 5.357 |
| 93 | 5.263 | 94 | 5.277 | 95 | 5.583 | 96 | 5.555 |
| 97 | 5.307 | 98 | 5.658 | 99 | 5.286 | 100 | 5.487 |

Hopping Frequency Sequence Name: HOP_FREQ_SEQ_09

| SEQ# | Frequency (GHz) | SEQ# | Frequency (GHz) | SEQ# | Frequency (GHz) | SEQ# | Frequency (GHz) |
|------|-----------------|------|-----------------|------|-----------------|------|-----------------|
| 1 | 5.358 | 2 | 5.423 | 3 | 5.255 | 4 | 5.380 |
| 5 | 5.477 | 6 | 5.387 | 7 | 5.724 | 8 | 5.629 |
| 9 | 5.466 | 10 | 5.254 | 11 | 5.611 | 12 | 5.379 |
| 13 | 5.395 | 14 | 5.702 | 15 | 5.508 | 16 | 5.543 |
| 17 | 5.261 | 18 | 5.360 | 19 | 5.696 | 20 | 5.411 |
| 21 | 5.394 | 22 | 5.460 | 23 | 5.592 | 24 | 5.528 |
| 25 | 5.692 | 26 | 5.449 | 27 | 5.281 | 28 | 5.285 |
| 29 | 5.279 | 30 | 5.558 | 31 | 5.348 | 32 | 5.496 |
| 33 | 5.418 | 34 | 5.647 | 35 | 5.661 | 36 | 5.517 |
| 37 | 5.607 | 38 | 5.359 | 39 | 5.636 | 40 | 5.650 |
| 41 | 5.559 | 42 | 5.642 | 43 | 5.713 | 44 | 5.274 |
| 45 | 5.322 | 46 | 5.604 | 47 | 5.667 | 48 | 5.674 |
| 49 | 5.564 | 50 | 5.414 | 51 | 5.627 | 52 | 5.489 |
| 53 | 5.431 | 54 | 5.298 | 55 | 5.439 | 56 | 5.353 |
| 57 | 5.339 | 58 | 5.398 | 59 | 5.457 | 60 | 5.497 |
| 61 | 5.511 | 62 | 5.390 | 63 | 5.710 | 64 | 5.407 |
| 65 | 5.334 | 66 | 5.609 | 67 | 5.665 | 68 | 5.263 |
| 69 | 5.706 | 70 | 5.259 | 71 | 5.484 | 72 | 5.479 |
| 73 | 5.381 | 74 | 5.693 | 75 | 5.341 | 76 | 5.351 |
| 77 | 5.614 | 78 | 5.566 | 79 | 5.422 | 80 | 5.475 |
| 81 | 5.467 | 82 | 5.386 | 83 | 5.492 | 84 | 5.705 |
| 85 | 5.504 | 86 | 5.399 | 87 | 5.286 | 88 | 5.610 |
| 89 | 5.267 | 90 | 5.670 | 91 | 5.646 | 92 | 5.265 |
| 93 | 5.486 | 94 | 5.635 | 95 | 5.615 | 96 | 5.608 |
| 97 | 5.633 | 98 | 5.514 | 99 | 5.723 | 100 | 5.372 |

Hopping Frequency Sequence Name: HOP_FREQ_SEQ_10

| SEQ# | Frequency (GHz) | SEQ# | Frequency (GHz) | SEQ# | Frequency (GHz) | SEQ# | Frequency (GHz) |
|------|-----------------|------|-----------------|------|-----------------|------|-----------------|
| 1 | 5.597 | 2 | 5.266 | 3 | 5.337 | 4 | 5.578 |
| 5 | 5.512 | 6 | 5.712 | 7 | 5.553 | 8 | 5.671 |
| 9 | 5.628 | 10 | 5.713 | 11 | 5.392 | 12 | 5.346 |
| 13 | 5.681 | 14 | 5.520 | 15 | 5.356 | 16 | 5.488 |
| 17 | 5.257 | 18 | 5.393 | 19 | 5.458 | 20 | 5.605 |
| 21 | 5.297 | 22 | 5.287 | 23 | 5.637 | 24 | 5.710 |
| 25 | 5.505 | 26 | 5.549 | 27 | 5.455 | 28 | 5.385 |
| 29 | 5.344 | 30 | 5.402 | 31 | 5.534 | 32 | 5.452 |
| 33 | 5.404 | 34 | 5.461 | 35 | 5.363 | 36 | 5.322 |
| 37 | 5.309 | 38 | 5.638 | 39 | 5.299 | 40 | 5.445 |
| 41 | 5.368 | 42 | 5.288 | 43 | 5.624 | 44 | 5.516 |
| 45 | 5.298 | 46 | 5.548 | 47 | 5.694 | 48 | 5.685 |
| 49 | 5.716 | 50 | 5.500 | 51 | 5.618 | 52 | 5.431 |
| 53 | 5.286 | 54 | 5.547 | 55 | 5.328 | 56 | 5.351 |
| 57 | 5.595 | 58 | 5.253 | 59 | 5.723 | 60 | 5.350 |
| 61 | 5.613 | 62 | 5.542 | 63 | 5.325 | 64 | 5.255 |
| 65 | 5.433 | 66 | 5.469 | 67 | 5.539 | 68 | 5.420 |
| 69 | 5.487 | 70 | 5.345 | 71 | 5.634 | 72 | 5.483 |
| 73 | 5.606 | 74 | 5.722 | 75 | 5.399 | 76 | 5.386 |
| 77 | 5.342 | 78 | 5.459 | 79 | 5.689 | 80 | 5.658 |
| 81 | 5.599 | 82 | 5.557 | 83 | 5.478 | 84 | 5.477 |
| 85 | 5.603 | 86 | 5.473 | 87 | 5.410 | 88 | 5.540 |
| 89 | 5.446 | 90 | 5.443 | 91 | 5.623 | 92 | 5.550 |
| 93 | 5.616 | 94 | 5.670 | 95 | 5.376 | 96 | 5.341 |
| 97 | 5.412 | 98 | 5.596 | 99 | 5.693 | 100 | 5.347 |

Hopping Frequency Sequence Name: HOP_FREQ_SEQ_11

| SEQ# | Frequency (GHz) | SEQ# | Frequency (GHz) | SEQ# | Frequency (GHz) | SEQ# | Frequency (GHz) |
|------|-----------------|------|-----------------|------|-----------------|------|-----------------|
| 1 | 5.481 | 2 | 5.267 | 3 | 5.677 | 4 | 5.358 |
| 5 | 5.424 | 6 | 5.457 | 7 | 5.486 | 8 | 5.285 |
| 9 | 5.455 | 10 | 5.632 | 11 | 5.637 | 12 | 5.679 |
| 13 | 5.534 | 14 | 5.651 | 15 | 5.341 | 16 | 5.376 |
| 17 | 5.580 | 18 | 5.705 | 19 | 5.505 | 20 | 5.438 |
| 21 | 5.610 | 22 | 5.606 | 23 | 5.682 | 24 | 5.578 |
| 25 | 5.627 | 26 | 5.674 | 27 | 5.410 | 28 | 5.370 |
| 29 | 5.631 | 30 | 5.475 | 31 | 5.514 | 32 | 5.694 |
| 33 | 5.405 | 34 | 5.555 | 35 | 5.659 | 36 | 5.420 |
| 37 | 5.533 | 38 | 5.575 | 39 | 5.508 | 40 | 5.266 |
| 41 | 5.471 | 42 | 5.657 | 43 | 5.392 | 44 | 5.339 |
| 45 | 5.562 | 46 | 5.348 | 47 | 5.497 | 48 | 5.278 |
| 49 | 5.628 | 50 | 5.643 | 51 | 5.292 | 52 | 5.528 |
| 53 | 5.595 | 54 | 5.450 | 55 | 5.461 | 56 | 5.387 |
| 57 | 5.665 | 58 | 5.257 | 59 | 5.454 | 60 | 5.301 |
| 61 | 5.540 | 62 | 5.571 | 63 | 5.391 | 64 | 5.568 |
| 65 | 5.343 | 66 | 5.347 | 67 | 5.565 | 68 | 5.718 |
| 69 | 5.646 | 70 | 5.488 | 71 | 5.608 | 72 | 5.710 |
| 73 | 5.569 | 74 | 5.377 | 75 | 5.408 | 76 | 5.572 |
| 77 | 5.626 | 78 | 5.666 | 79 | 5.412 | 80 | 5.284 |
| 81 | 5.473 | 82 | 5.459 | 83 | 5.402 | 84 | 5.416 |
| 85 | 5.480 | 86 | 5.525 | 87 | 5.413 | 88 | 5.519 |
| 89 | 5.375 | 90 | 5.602 | 91 | 5.640 | 92 | 5.478 |
| 93 | 5.418 | 94 | 5.653 | 95 | 5.681 | 96 | 5.421 |
| 97 | 5.638 | 98 | 5.714 | 99 | 5.536 | 100 | 5.673 |

Hopping Frequency Sequence Name: HOP_FREQ_SEQ_12

| SEQ# | Frequency (GHz) | SEQ# | Frequency (GHz) | SEQ# | Frequency (GHz) | SEQ# | Frequency (GHz) |
|------|-----------------|------|-----------------|------|-----------------|------|-----------------|
| 1 | 5.585 | 2 | 5.257 | 3 | 5.621 | 4 | 5.720 |
| 5 | 5.611 | 6 | 5.538 | 7 | 5.556 | 8 | 5.427 |
| 9 | 5.657 | 10 | 5.628 | 11 | 5.508 | 12 | 5.367 |
| 13 | 5.291 | 14 | 5.341 | 15 | 5.300 | 16 | 5.485 |
| 17 | 5.630 | 18 | 5.648 | 19 | 5.697 | 20 | 5.378 |
| 21 | 5.386 | 22 | 5.711 | 23 | 5.584 | 24 | 5.350 |
| 25 | 5.365 | 26 | 5.337 | 27 | 5.501 | 28 | 5.272 |
| 29 | 5.463 | 30 | 5.420 | 31 | 5.668 | 32 | 5.283 |
| 33 | 5.323 | 34 | 5.640 | 35 | 5.629 | 36 | 5.502 |
| 37 | 5.612 | 38 | 5.329 | 39 | 5.469 | 40 | 5.701 |
| 41 | 5.588 | 42 | 5.295 | 43 | 5.418 | 44 | 5.683 |
| 45 | 5.315 | 46 | 5.573 | 47 | 5.517 | 48 | 5.592 |
| 49 | 5.387 | 50 | 5.311 | 51 | 5.595 | 52 | 5.580 |
| 53 | 5.445 | 54 | 5.381 | 55 | 5.318 | 56 | 5.523 |
| 57 | 5.271 | 58 | 5.705 | 59 | 5.712 | 60 | 5.669 |
| 61 | 5.715 | 62 | 5.507 | 63 | 5.623 | 64 | 5.491 |
| 65 | 5.515 | 66 | 5.604 | 67 | 5.267 | 68 | 5.368 |
| 69 | 5.625 | 70 | 5.714 | 71 | 5.581 | 72 | 5.407 |
| 73 | 5.665 | 74 | 5.475 | 75 | 5.616 | 76 | 5.276 |
| 77 | 5.474 | 78 | 5.716 | 79 | 5.423 | 80 | 5.302 |
| 81 | 5.410 | 82 | 5.496 | 83 | 5.471 | 84 | 5.413 |
| 85 | 5.339 | 86 | 5.565 | 87 | 5.266 | 88 | 5.352 |
| 89 | 5.521 | 90 | 5.275 | 91 | 5.652 | 92 | 5.653 |
| 93 | 5.601 | 94 | 5.593 | 95 | 5.681 | 96 | 5.656 |
| 97 | 5.476 | 98 | 5.498 | 99 | 5.348 | 100 | 5.446 |

Hopping Frequency Sequence Name: HOP_FREQ_SEQ_13

| SEQ# | Frequency (GHz) | SEQ# | Frequency (GHz) | SEQ# | Frequency (GHz) | SEQ# | Frequency (GHz) |
|------|-----------------|------|-----------------|------|-----------------|------|-----------------|
| 1 | 5.303 | 2 | 5.525 | 3 | 5.524 | 4 | 5.392 |
| 5 | 5.396 | 6 | 5.518 | 7 | 5.534 | 8 | 5.685 |
| 9 | 5.573 | 10 | 5.406 | 11 | 5.468 | 12 | 5.389 |
| 13 | 5.492 | 14 | 5.341 | 15 | 5.585 | 16 | 5.540 |
| 17 | 5.323 | 18 | 5.653 | 19 | 5.652 | 20 | 5.269 |
| 21 | 5.460 | 22 | 5.387 | 23 | 5.443 | 24 | 5.424 |
| 25 | 5.643 | 26 | 5.678 | 27 | 5.312 | 28 | 5.526 |
| 29 | 5.675 | 30 | 5.626 | 31 | 5.515 | 32 | 5.668 |
| 33 | 5.495 | 34 | 5.611 | 35 | 5.633 | 36 | 5.408 |
| 37 | 5.344 | 38 | 5.305 | 39 | 5.493 | 40 | 5.623 |
| 41 | 5.717 | 42 | 5.411 | 43 | 5.569 | 44 | 5.516 |
| 45 | 5.478 | 46 | 5.538 | 47 | 5.673 | 48 | 5.255 |
| 49 | 5.566 | 50 | 5.340 | 51 | 5.512 | 52 | 5.463 |
| 53 | 5.561 | 54 | 5.661 | 55 | 5.624 | 56 | 5.713 |
| 57 | 5.256 | 58 | 5.533 | 59 | 5.322 | 60 | 5.503 |
| 61 | 5.487 | 62 | 5.394 | 63 | 5.638 | 64 | 5.436 |
| 65 | 5.311 | 66 | 5.635 | 67 | 5.298 | 68 | 5.284 |
| 69 | 5.375 | 70 | 5.336 | 71 | 5.694 | 72 | 5.456 |
| 73 | 5.295 | 74 | 5.577 | 75 | 5.605 | 76 | 5.625 |
| 77 | 5.417 | 78 | 5.592 | 79 | 5.437 | 80 | 5.627 |
| 81 | 5.629 | 82 | 5.388 | 83 | 5.414 | 84 | 5.264 |
| 85 | 5.572 | 86 | 5.701 | 87 | 5.360 | 88 | 5.508 |
| 89 | 5.689 | 90 | 5.266 | 91 | 5.707 | 92 | 5.543 |
| 93 | 5.671 | 94 | 5.632 | 95 | 5.596 | 96 | 5.407 |
| 97 | 5.510 | 98 | 5.612 | 99 | 5.337 | 100 | 5.576 |

Hopping Frequency Sequence Name: HOP_FREQ_SEQ_14

| SEQ# | Frequency (GHz) | SEQ# | Frequency (GHz) | SEQ# | Frequency (GHz) | SEQ# | Frequency (GHz) |
|------|-----------------|------|-----------------|------|-----------------|------|-----------------|
| 1 | 5.320 | 2 | 5.569 | 3 | 5.430 | 4 | 5.515 |
| 5 | 5.378 | 6 | 5.686 | 7 | 5.418 | 8 | 5.682 |
| 9 | 5.367 | 10 | 5.715 | 11 | 5.444 | 12 | 5.405 |
| 13 | 5.695 | 14 | 5.421 | 15 | 5.574 | 16 | 5.293 |
| 17 | 5.266 | 18 | 5.450 | 19 | 5.462 | 20 | 5.524 |
| 21 | 5.499 | 22 | 5.520 | 23 | 5.455 | 24 | 5.270 |
| 25 | 5.345 | 26 | 5.560 | 27 | 5.466 | 28 | 5.491 |
| 29 | 5.498 | 30 | 5.602 | 31 | 5.274 | 32 | 5.550 |
| 33 | 5.393 | 34 | 5.454 | 35 | 5.268 | 36 | 5.590 |
| 37 | 5.608 | 38 | 5.424 | 39 | 5.600 | 40 | 5.276 |
| 41 | 5.305 | 42 | 5.374 | 43 | 5.588 | 44 | 5.662 |
| 45 | 5.541 | 46 | 5.516 | 47 | 5.463 | 48 | 5.677 |
| 49 | 5.555 | 50 | 5.540 | 51 | 5.649 | 52 | 5.484 |
| 53 | 5.639 | 54 | 5.641 | 55 | 5.655 | 56 | 5.316 |
| 57 | 5.678 | 58 | 5.357 | 59 | 5.547 | 60 | 5.269 |
| 61 | 5.397 | 62 | 5.318 | 63 | 5.302 | 64 | 5.596 |
| 65 | 5.411 | 66 | 5.538 | 67 | 5.568 | 68 | 5.626 |
| 69 | 5.694 | 70 | 5.671 | 71 | 5.323 | 72 | 5.267 |
| 73 | 5.693 | 74 | 5.643 | 75 | 5.443 | 76 | 5.598 |
| 77 | 5.502 | 78 | 5.528 | 79 | 5.341 | 80 | 5.445 |
| 81 | 5.691 | 82 | 5.353 | 83 | 5.368 | 84 | 5.575 |
| 85 | 5.344 | 86 | 5.440 | 87 | 5.489 | 88 | 5.501 |
| 89 | 5.292 | 90 | 5.355 | 91 | 5.534 | 92 | 5.642 |
| 93 | 5.423 | 94 | 5.545 | 95 | 5.470 | 96 | 5.409 |
| 97 | 5.425 | 98 | 5.612 | 99 | 5.651 | 100 | 5.688 |

Hopping Frequency Sequence Name: HOP_FREQ_SEQ_15

| SEQ# | Frequency (GHz) | SEQ# | Frequency (GHz) | SEQ# | Frequency (GHz) | SEQ# | Frequency (GHz) |
|------|-----------------|------|-----------------|------|-----------------|------|-----------------|
| 1 | 5.679 | 2 | 5.438 | 3 | 5.375 | 4 | 5.447 |
| 5 | 5.698 | 6 | 5.642 | 7 | 5.366 | 8 | 5.662 |
| 9 | 5.653 | 10 | 5.250 | 11 | 5.299 | 12 | 5.427 |
| 13 | 5.303 | 14 | 5.277 | 15 | 5.283 | 16 | 5.574 |
| 17 | 5.720 | 18 | 5.279 | 19 | 5.455 | 20 | 5.470 |
| 21 | 5.638 | 22 | 5.639 | 23 | 5.323 | 24 | 5.643 |
| 25 | 5.619 | 26 | 5.575 | 27 | 5.633 | 28 | 5.710 |
| 29 | 5.411 | 30 | 5.645 | 31 | 5.712 | 32 | 5.510 |
| 33 | 5.604 | 34 | 5.680 | 35 | 5.284 | 36 | 5.357 |
| 37 | 5.397 | 38 | 5.322 | 39 | 5.294 | 40 | 5.681 |
| 41 | 5.555 | 42 | 5.523 | 43 | 5.591 | 44 | 5.593 |
| 45 | 5.392 | 46 | 5.342 | 47 | 5.401 | 48 | 5.255 |
| 49 | 5.363 | 50 | 5.345 | 51 | 5.348 | 52 | 5.281 |
| 53 | 5.449 | 54 | 5.319 | 55 | 5.671 | 56 | 5.498 |
| 57 | 5.558 | 58 | 5.350 | 59 | 5.464 | 60 | 5.405 |
| 61 | 5.717 | 62 | 5.317 | 63 | 5.669 | 64 | 5.526 |
| 65 | 5.530 | 66 | 5.597 | 67 | 5.329 | 68 | 5.508 |
| 69 | 5.270 | 70 | 5.552 | 71 | 5.634 | 72 | 5.355 |
| 73 | 5.646 | 74 | 5.461 | 75 | 5.516 | 76 | 5.380 |
| 77 | 5.263 | 78 | 5.387 | 79 | 5.306 | 80 | 5.341 |
| 81 | 5.605 | 82 | 5.606 | 83 | 5.687 | 84 | 5.637 |
| 85 | 5.362 | 86 | 5.325 | 87 | 5.305 | 88 | 5.326 |
| 89 | 5.688 | 90 | 5.390 | 91 | 5.477 | 92 | 5.567 |
| 93 | 5.320 | 94 | 5.651 | 95 | 5.499 | 96 | 5.721 |
| 97 | 5.296 | 98 | 5.410 | 99 | 5.673 | 100 | 5.586 |

Hopping Frequency Sequence Name: HOP_FREQ_SEQ_16

| SEQ# | Frequency (GHz) | SEQ# | Frequency (GHz) | SEQ# | Frequency (GHz) | SEQ# | Frequency (GHz) |
|------|-----------------|------|-----------------|------|-----------------|------|-----------------|
| 1 | 5.426 | 2 | 5.604 | 3 | 5.396 | 4 | 5.259 |
| 5 | 5.410 | 6 | 5.543 | 7 | 5.666 | 8 | 5.395 |
| 9 | 5.569 | 10 | 5.340 | 11 | 5.348 | 12 | 5.690 |
| 13 | 5.679 | 14 | 5.628 | 15 | 5.515 | 16 | 5.588 |
| 17 | 5.436 | 18 | 5.547 | 19 | 5.555 | 20 | 5.385 |
| 21 | 5.456 | 22 | 5.563 | 23 | 5.499 | 24 | 5.573 |
| 25 | 5.526 | 26 | 5.264 | 27 | 5.521 | 28 | 5.528 |
| 29 | 5.334 | 30 | 5.363 | 31 | 5.470 | 32 | 5.386 |
| 33 | 5.275 | 34 | 5.693 | 35 | 5.493 | 36 | 5.427 |
| 37 | 5.665 | 38 | 5.446 | 39 | 5.681 | 40 | 5.382 |
| 41 | 5.336 | 42 | 5.416 | 43 | 5.447 | 44 | 5.390 |
| 45 | 5.278 | 46 | 5.685 | 47 | 5.263 | 48 | 5.342 |
| 49 | 5.345 | 50 | 5.343 | 51 | 5.497 | 52 | 5.653 |
| 53 | 5.417 | 54 | 5.309 | 55 | 5.509 | 56 | 5.579 |
| 57 | 5.441 | 58 | 5.684 | 59 | 5.397 | 60 | 5.341 |
| 61 | 5.372 | 62 | 5.315 | 63 | 5.554 | 64 | 5.540 |
| 65 | 5.546 | 66 | 5.268 | 67 | 5.299 | 68 | 5.561 |
| 69 | 5.317 | 70 | 5.656 | 71 | 5.318 | 72 | 5.703 |
| 73 | 5.516 | 74 | 5.544 | 75 | 5.454 | 76 | 5.414 |
| 77 | 5.273 | 78 | 5.574 | 79 | 5.535 | 80 | 5.380 |
| 81 | 5.457 | 82 | 5.595 | 83 | 5.548 | 84 | 5.466 |
| 85 | 5.672 | 86 | 5.271 | 87 | 5.486 | 88 | 5.650 |
| 89 | 5.490 | 90 | 5.699 | 91 | 5.381 | 92 | 5.581 |
| 93 | 5.276 | 94 | 5.550 | 95 | 5.487 | 96 | 5.402 |
| 97 | 5.257 | 98 | 5.406 | 99 | 5.323 | 100 | 5.371 |

Hopping Frequency Sequence Name: HOP_FREQ_SEQ_17

| SEQ# | Frequency (GHz) | SEQ# | Frequency (GHz) | SEQ# | Frequency (GHz) | SEQ# | Frequency (GHz) |
|------|-----------------|------|-----------------|------|-----------------|------|-----------------|
| 1 | 5.421 | 2 | 5.452 | 3 | 5.547 | 4 | 5.598 |
| 5 | 5.335 | 6 | 5.378 | 7 | 5.572 | 8 | 5.279 |
| 9 | 5.419 | 10 | 5.605 | 11 | 5.553 | 12 | 5.461 |
| 13 | 5.406 | 14 | 5.397 | 15 | 5.293 | 16 | 5.401 |
| 17 | 5.435 | 18 | 5.596 | 19 | 5.683 | 20 | 5.352 |
| 21 | 5.480 | 22 | 5.416 | 23 | 5.575 | 24 | 5.543 |
| 25 | 5.708 | 26 | 5.449 | 27 | 5.652 | 28 | 5.372 |
| 29 | 5.661 | 30 | 5.483 | 31 | 5.588 | 32 | 5.315 |
| 33 | 5.251 | 34 | 5.611 | 35 | 5.667 | 36 | 5.264 |
| 37 | 5.283 | 38 | 5.339 | 39 | 5.592 | 40 | 5.363 |
| 41 | 5.629 | 42 | 5.594 | 43 | 5.518 | 44 | 5.674 |
| 45 | 5.573 | 46 | 5.531 | 47 | 5.323 | 48 | 5.405 |
| 49 | 5.353 | 50 | 5.617 | 51 | 5.468 | 52 | 5.671 |
| 53 | 5.695 | 54 | 5.269 | 55 | 5.515 | 56 | 5.580 |
| 57 | 5.649 | 58 | 5.673 | 59 | 5.299 | 60 | 5.644 |
| 61 | 5.509 | 62 | 5.650 | 63 | 5.500 | 64 | 5.467 |
| 65 | 5.344 | 66 | 5.614 | 67 | 5.538 | 68 | 5.622 |
| 69 | 5.645 | 70 | 5.721 | 71 | 5.368 | 72 | 5.627 |
| 73 | 5.260 | 74 | 5.620 | 75 | 5.601 | 76 | 5.356 |
| 77 | 5.413 | 78 | 5.340 | 79 | 5.451 | 80 | 5.697 |
| 81 | 5.643 | 82 | 5.519 | 83 | 5.444 | 84 | 5.578 |
| 85 | 5.624 | 86 | 5.556 | 87 | 5.551 | 88 | 5.355 |
| 89 | 5.677 | 90 | 5.439 | 91 | 5.548 | 92 | 5.338 |
| 93 | 5.277 | 94 | 5.387 | 95 | 5.252 | 96 | 5.311 |
| 97 | 5.651 | 98 | 5.599 | 99 | 5.574 | 100 | 5.600 |

Hopping Frequency Sequence Name: HOP_FREQ_SEQ_18

| SEQ# | Frequency (GHz) | SEQ# | Frequency (GHz) | SEQ# | Frequency (GHz) | SEQ# | Frequency (GHz) |
|------|-----------------|------|-----------------|------|-----------------|------|-----------------|
| 1 | 5.487 | 2 | 5.444 | 3 | 5.562 | 4 | 5.715 |
| 5 | 5.662 | 6 | 5.308 | 7 | 5.379 | 8 | 5.453 |
| 9 | 5.368 | 10 | 5.629 | 11 | 5.514 | 12 | 5.329 |
| 13 | 5.538 | 14 | 5.356 | 15 | 5.588 | 16 | 5.391 |
| 17 | 5.413 | 18 | 5.700 | 19 | 5.381 | 20 | 5.618 |
| 21 | 5.455 | 22 | 5.558 | 23 | 5.352 | 24 | 5.582 |
| 25 | 5.283 | 26 | 5.709 | 27 | 5.542 | 28 | 5.394 |
| 29 | 5.663 | 30 | 5.689 | 31 | 5.288 | 32 | 5.262 |
| 33 | 5.370 | 34 | 5.371 | 35 | 5.577 | 36 | 5.702 |
| 37 | 5.299 | 38 | 5.465 | 39 | 5.325 | 40 | 5.503 |
| 41 | 5.312 | 42 | 5.549 | 43 | 5.451 | 44 | 5.314 |
| 45 | 5.319 | 46 | 5.274 | 47 | 5.682 | 48 | 5.388 |
| 49 | 5.546 | 50 | 5.513 | 51 | 5.474 | 52 | 5.713 |
| 53 | 5.260 | 54 | 5.251 | 55 | 5.722 | 56 | 5.408 |
| 57 | 5.625 | 58 | 5.392 | 59 | 5.418 | 60 | 5.389 |
| 61 | 5.492 | 62 | 5.668 | 63 | 5.697 | 64 | 5.482 |
| 65 | 5.300 | 66 | 5.647 | 67 | 5.599 | 68 | 5.494 |
| 69 | 5.571 | 70 | 5.348 | 71 | 5.460 | 72 | 5.716 |
| 73 | 5.551 | 74 | 5.327 | 75 | 5.366 | 76 | 5.509 |
| 77 | 5.600 | 78 | 5.406 | 79 | 5.622 | 80 | 5.495 |
| 81 | 5.712 | 82 | 5.404 | 83 | 5.421 | 84 | 5.464 |
| 85 | 5.393 | 86 | 5.470 | 87 | 5.676 | 88 | 5.617 |
| 89 | 5.594 | 90 | 5.637 | 91 | 5.425 | 92 | 5.691 |
| 93 | 5.278 | 94 | 5.410 | 95 | 5.486 | 96 | 5.632 |
| 97 | 5.653 | 98 | 5.400 | 99 | 5.572 | 100 | 5.426 |

Hopping Frequency Sequence Name: HOP_FREQ_SEQ_19

| SEQ# | Frequency (GHz) | SEQ# | Frequency (GHz) | SEQ# | Frequency (GHz) | SEQ# | Frequency (GHz) |
|------|-----------------|------|-----------------|------|-----------------|------|-----------------|
| 1 | 5.329 | 2 | 5.351 | 3 | 5.639 | 4 | 5.713 |
| 5 | 5.256 | 6 | 5.715 | 7 | 5.672 | 8 | 5.430 |
| 9 | 5.291 | 10 | 5.665 | 11 | 5.459 | 12 | 5.427 |
| 13 | 5.693 | 14 | 5.462 | 15 | 5.571 | 16 | 5.573 |
| 17 | 5.474 | 18 | 5.262 | 19 | 5.596 | 20 | 5.287 |
| 21 | 5.327 | 22 | 5.341 | 23 | 5.326 | 24 | 5.701 |
| 25 | 5.457 | 26 | 5.576 | 27 | 5.681 | 28 | 5.620 |
| 29 | 5.325 | 30 | 5.671 | 31 | 5.543 | 32 | 5.720 |
| 33 | 5.521 | 34 | 5.360 | 35 | 5.485 | 36 | 5.509 |
| 37 | 5.408 | 38 | 5.334 | 39 | 5.555 | 40 | 5.315 |
| 41 | 5.417 | 42 | 5.694 | 43 | 5.623 | 44 | 5.654 |
| 45 | 5.253 | 46 | 5.499 | 47 | 5.544 | 48 | 5.293 |
| 49 | 5.708 | 50 | 5.372 | 51 | 5.366 | 52 | 5.520 |
| 53 | 5.302 | 54 | 5.711 | 55 | 5.590 | 56 | 5.477 |
| 57 | 5.349 | 58 | 5.712 | 59 | 5.305 | 60 | 5.281 |
| 61 | 5.383 | 62 | 5.467 | 63 | 5.397 | 64 | 5.388 |
| 65 | 5.527 | 66 | 5.540 | 67 | 5.651 | 68 | 5.511 |
| 69 | 5.386 | 70 | 5.370 | 71 | 5.580 | 72 | 5.517 |
| 73 | 5.684 | 74 | 5.519 | 75 | 5.435 | 76 | 5.444 |
| 77 | 5.535 | 78 | 5.298 | 79 | 5.699 | 80 | 5.554 |
| 81 | 5.514 | 82 | 5.319 | 83 | 5.473 | 84 | 5.348 |
| 85 | 5.705 | 86 | 5.594 | 87 | 5.323 | 88 | 5.484 |
| 89 | 5.506 | 90 | 5.714 | 91 | 5.411 | 92 | 5.359 |
| 93 | 5.421 | 94 | 5.487 | 95 | 5.258 | 96 | 5.312 |
| 97 | 5.491 | 98 | 5.269 | 99 | 5.320 | 100 | 5.641 |

Hopping Frequency Sequence Name: HOP_FREQ_SEQ_20

| SEQ# | Frequency (GHz) | SEQ# | Frequency (GHz) | SEQ# | Frequency (GHz) | SEQ# | Frequency (GHz) |
|------|-----------------|------|-----------------|------|-----------------|------|-----------------|
| 1 | 5.288 | 2 | 5.291 | 3 | 5.457 | 4 | 5.252 |
| 5 | 5.596 | 6 | 5.598 | 7 | 5.306 | 8 | 5.434 |
| 9 | 5.633 | 10 | 5.625 | 11 | 5.374 | 12 | 5.477 |
| 13 | 5.684 | 14 | 5.272 | 15 | 5.664 | 16 | 5.441 |
| 17 | 5.399 | 18 | 5.586 | 19 | 5.261 | 20 | 5.656 |
| 21 | 5.621 | 22 | 5.373 | 23 | 5.280 | 24 | 5.376 |
| 25 | 5.349 | 26 | 5.530 | 27 | 5.632 | 28 | 5.348 |
| 29 | 5.333 | 30 | 5.618 | 31 | 5.391 | 32 | 5.283 |
| 33 | 5.265 | 34 | 5.273 | 35 | 5.594 | 36 | 5.440 |
| 37 | 5.548 | 38 | 5.651 | 39 | 5.724 | 40 | 5.584 |
| 41 | 5.676 | 42 | 5.682 | 43 | 5.506 | 44 | 5.294 |
| 45 | 5.679 | 46 | 5.323 | 47 | 5.649 | 48 | 5.497 |
| 49 | 5.361 | 50 | 5.337 | 51 | 5.286 | 52 | 5.268 |
| 53 | 5.524 | 54 | 5.513 | 55 | 5.257 | 56 | 5.300 |
| 57 | 5.697 | 58 | 5.504 | 59 | 5.492 | 60 | 5.607 |
| 61 | 5.525 | 62 | 5.377 | 63 | 5.432 | 64 | 5.310 |
| 65 | 5.320 | 66 | 5.661 | 67 | 5.250 | 68 | 5.493 |
| 69 | 5.593 | 70 | 5.346 | 71 | 5.456 | 72 | 5.307 |
| 73 | 5.368 | 74 | 5.281 | 75 | 5.636 | 76 | 5.382 |
| 77 | 5.540 | 78 | 5.538 | 79 | 5.502 | 80 | 5.573 |
| 81 | 5.692 | 82 | 5.445 | 83 | 5.590 | 84 | 5.370 |
| 85 | 5.570 | 86 | 5.439 | 87 | 5.654 | 88 | 5.443 |
| 89 | 5.352 | 90 | 5.581 | 91 | 5.295 | 92 | 5.681 |
| 93 | 5.322 | 94 | 5.680 | 95 | 5.327 | 96 | 5.561 |
| 97 | 5.345 | 98 | 5.550 | 99 | 5.356 | 100 | 5.609 |

Hopping Frequency Sequence Name: HOP_FREQ_SEQ_21

| SEQ# | Frequency (GHz) | SEQ# | Frequency (GHz) | SEQ# | Frequency (GHz) | SEQ# | Frequency (GHz) |
|------|-----------------|------|-----------------|------|-----------------|------|-----------------|
| 1 | 5.269 | 2 | 5.285 | 3 | 5.400 | 4 | 5.637 |
| 5 | 5.564 | 6 | 5.523 | 7 | 5.255 | 8 | 5.461 |
| 9 | 5.563 | 10 | 5.552 | 11 | 5.625 | 12 | 5.421 |
| 13 | 5.531 | 14 | 5.695 | 15 | 5.271 | 16 | 5.590 |
| 17 | 5.484 | 18 | 5.456 | 19 | 5.352 | 20 | 5.409 |
| 21 | 5.672 | 22 | 5.459 | 23 | 5.292 | 24 | 5.359 |
| 25 | 5.486 | 26 | 5.422 | 27 | 5.650 | 28 | 5.407 |
| 29 | 5.633 | 30 | 5.532 | 31 | 5.720 | 32 | 5.493 |
| 33 | 5.357 | 34 | 5.439 | 35 | 5.472 | 36 | 5.628 |
| 37 | 5.442 | 38 | 5.668 | 39 | 5.343 | 40 | 5.638 |
| 41 | 5.466 | 42 | 5.470 | 43 | 5.585 | 44 | 5.611 |
| 45 | 5.471 | 46 | 5.524 | 47 | 5.307 | 48 | 5.441 |
| 49 | 5.398 | 50 | 5.529 | 51 | 5.545 | 52 | 5.325 |
| 53 | 5.641 | 54 | 5.688 | 55 | 5.657 | 56 | 5.429 |
| 57 | 5.302 | 58 | 5.719 | 59 | 5.687 | 60 | 5.494 |
| 61 | 5.328 | 62 | 5.397 | 63 | 5.475 | 64 | 5.626 |
| 65 | 5.693 | 66 | 5.265 | 67 | 5.608 | 68 | 5.337 |
| 69 | 5.485 | 70 | 5.703 | 71 | 5.554 | 72 | 5.294 |
| 73 | 5.505 | 74 | 5.314 | 75 | 5.324 | 76 | 5.405 |
| 77 | 5.355 | 78 | 5.389 | 79 | 5.649 | 80 | 5.620 |
| 81 | 5.259 | 82 | 5.566 | 83 | 5.645 | 84 | 5.701 |
| 85 | 5.510 | 86 | 5.370 | 87 | 5.539 | 88 | 5.423 |
| 89 | 5.342 | 90 | 5.609 | 91 | 5.384 | 92 | 5.629 |
| 93 | 5.369 | 94 | 5.613 | 95 | 5.718 | 96 | 5.381 |
| 97 | 5.424 | 98 | 5.578 | 99 | 5.568 | 100 | 5.427 |

Hopping Frequency Sequence Name: HOP_FREQ_SEQ_22

| SEQ# | Frequency (GHz) | SEQ# | Frequency (GHz) | SEQ# | Frequency (GHz) | SEQ# | Frequency (GHz) |
|------|-----------------|------|-----------------|------|-----------------|------|-----------------|
| 1 | 5.576 | 2 | 5.614 | 3 | 5.255 | 4 | 5.381 |
| 5 | 5.450 | 6 | 5.715 | 7 | 5.545 | 8 | 5.517 |
| 9 | 5.647 | 10 | 5.317 | 11 | 5.546 | 12 | 5.375 |
| 13 | 5.530 | 14 | 5.439 | 15 | 5.344 | 16 | 5.541 |
| 17 | 5.323 | 18 | 5.513 | 19 | 5.480 | 20 | 5.586 |
| 21 | 5.300 | 22 | 5.565 | 23 | 5.341 | 24 | 5.472 |
| 25 | 5.283 | 26 | 5.524 | 27 | 5.307 | 28 | 5.284 |
| 29 | 5.388 | 30 | 5.583 | 31 | 5.663 | 32 | 5.332 |
| 33 | 5.484 | 34 | 5.362 | 35 | 5.658 | 36 | 5.295 |
| 37 | 5.446 | 38 | 5.491 | 39 | 5.441 | 40 | 5.570 |
| 41 | 5.351 | 42 | 5.533 | 43 | 5.349 | 44 | 5.655 |
| 45 | 5.563 | 46 | 5.638 | 47 | 5.613 | 48 | 5.646 |
| 49 | 5.285 | 50 | 5.696 | 51 | 5.417 | 52 | 5.358 |
| 53 | 5.703 | 54 | 5.669 | 55 | 5.662 | 56 | 5.713 |
| 57 | 5.335 | 58 | 5.321 | 59 | 5.438 | 60 | 5.355 |
| 61 | 5.628 | 62 | 5.412 | 63 | 5.700 | 64 | 5.674 |
| 65 | 5.536 | 66 | 5.334 | 67 | 5.626 | 68 | 5.465 |
| 69 | 5.310 | 70 | 5.518 | 71 | 5.282 | 72 | 5.551 |
| 73 | 5.585 | 74 | 5.548 | 75 | 5.680 | 76 | 5.376 |
| 77 | 5.338 | 78 | 5.440 | 79 | 5.266 | 80 | 5.648 |
| 81 | 5.516 | 82 | 5.468 | 83 | 5.644 | 84 | 5.414 |
| 85 | 5.579 | 86 | 5.393 | 87 | 5.643 | 88 | 5.537 |
| 89 | 5.487 | 90 | 5.592 | 91 | 5.590 | 92 | 5.423 |
| 93 | 5.430 | 94 | 5.288 | 95 | 5.387 | 96 | 5.636 |
| 97 | 5.456 | 98 | 5.508 | 99 | 5.359 | 100 | 5.425 |

Hopping Frequency Sequence Name: HOP_FREQ_SEQ_23

| SEQ# | Frequency (GHz) | SEQ# | Frequency (GHz) | SEQ# | Frequency (GHz) | SEQ# | Frequency (GHz) |
|------|-----------------|------|-----------------|------|-----------------|------|-----------------|
| 1 | 5.650 | 2 | 5.457 | 3 | 5.366 | 4 | 5.672 |
| 5 | 5.654 | 6 | 5.255 | 7 | 5.381 | 8 | 5.432 |
| 9 | 5.701 | 10 | 5.639 | 11 | 5.310 | 12 | 5.598 |
| 13 | 5.405 | 14 | 5.576 | 15 | 5.464 | 16 | 5.529 |
| 17 | 5.659 | 18 | 5.278 | 19 | 5.251 | 20 | 5.525 |
| 21 | 5.530 | 22 | 5.528 | 23 | 5.567 | 24 | 5.486 |
| 25 | 5.394 | 26 | 5.690 | 27 | 5.713 | 28 | 5.315 |
| 29 | 5.533 | 30 | 5.614 | 31 | 5.623 | 32 | 5.395 |
| 33 | 5.620 | 34 | 5.308 | 35 | 5.379 | 36 | 5.281 |
| 37 | 5.677 | 38 | 5.304 | 39 | 5.537 | 40 | 5.364 |
| 41 | 5.352 | 42 | 5.339 | 43 | 5.284 | 44 | 5.456 |
| 45 | 5.626 | 46 | 5.632 | 47 | 5.287 | 48 | 5.592 |
| 49 | 5.452 | 50 | 5.470 | 51 | 5.329 | 52 | 5.388 |
| 53 | 5.356 | 54 | 5.585 | 55 | 5.593 | 56 | 5.283 |
| 57 | 5.603 | 58 | 5.361 | 59 | 5.408 | 60 | 5.717 |
| 61 | 5.404 | 62 | 5.298 | 63 | 5.347 | 64 | 5.332 |
| 65 | 5.412 | 66 | 5.697 | 67 | 5.674 | 68 | 5.263 |
| 69 | 5.499 | 70 | 5.372 | 71 | 5.676 | 72 | 5.609 |
| 73 | 5.619 | 74 | 5.468 | 75 | 5.692 | 76 | 5.577 |
| 77 | 5.578 | 78 | 5.268 | 79 | 5.428 | 80 | 5.552 |
| 81 | 5.413 | 82 | 5.482 | 83 | 5.579 | 84 | 5.662 |
| 85 | 5.621 | 86 | 5.572 | 87 | 5.682 | 88 | 5.625 |
| 89 | 5.644 | 90 | 5.279 | 91 | 5.253 | 92 | 5.652 |
| 93 | 5.678 | 94 | 5.360 | 95 | 5.627 | 96 | 5.270 |
| 97 | 5.721 | 98 | 5.261 | 99 | 5.497 | 100 | 5.441 |

Hopping Frequency Sequence Name: HOP_FREQ_SEQ_24

| SEQ# | Frequency (GHz) | SEQ# | Frequency (GHz) | SEQ# | Frequency (GHz) | SEQ# | Frequency (GHz) |
|------|-----------------|------|-----------------|------|-----------------|------|-----------------|
| 1 | 5.564 | 2 | 5.702 | 3 | 5.585 | 4 | 5.465 |
| 5 | 5.407 | 6 | 5.670 | 7 | 5.522 | 8 | 5.466 |
| 9 | 5.628 | 10 | 5.659 | 11 | 5.485 | 12 | 5.704 |
| 13 | 5.640 | 14 | 5.367 | 15 | 5.510 | 16 | 5.722 |
| 17 | 5.412 | 18 | 5.355 | 19 | 5.430 | 20 | 5.549 |
| 21 | 5.361 | 22 | 5.329 | 23 | 5.389 | 24 | 5.587 |
| 25 | 5.621 | 26 | 5.720 | 27 | 5.451 | 28 | 5.320 |
| 29 | 5.321 | 30 | 5.424 | 31 | 5.508 | 32 | 5.618 |
| 33 | 5.278 | 34 | 5.556 | 35 | 5.387 | 36 | 5.374 |
| 37 | 5.562 | 38 | 5.553 | 39 | 5.470 | 40 | 5.276 |
| 41 | 5.457 | 42 | 5.439 | 43 | 5.711 | 44 | 5.518 |
| 45 | 5.458 | 46 | 5.513 | 47 | 5.500 | 48 | 5.376 |
| 49 | 5.402 | 50 | 5.447 | 51 | 5.669 | 52 | 5.524 |
| 53 | 5.400 | 54 | 5.515 | 55 | 5.625 | 56 | 5.652 |
| 57 | 5.449 | 58 | 5.301 | 59 | 5.484 | 60 | 5.529 |
| 61 | 5.541 | 62 | 5.333 | 63 | 5.255 | 64 | 5.354 |
| 65 | 5.695 | 66 | 5.365 | 67 | 5.701 | 68 | 5.494 |
| 69 | 5.646 | 70 | 5.454 | 71 | 5.613 | 72 | 5.721 |
| 73 | 5.595 | 74 | 5.688 | 75 | 5.690 | 76 | 5.487 |
| 77 | 5.415 | 78 | 5.428 | 79 | 5.548 | 80 | 5.591 |
| 81 | 5.277 | 82 | 5.496 | 83 | 5.323 | 84 | 5.302 |
| 85 | 5.719 | 86 | 5.298 | 87 | 5.299 | 88 | 5.614 |
| 89 | 5.405 | 90 | 5.497 | 91 | 5.563 | 92 | 5.291 |
| 93 | 5.724 | 94 | 5.483 | 95 | 5.271 | 96 | 5.297 |
| 97 | 5.559 | 98 | 5.311 | 99 | 5.426 | 100 | 5.360 |

Hopping Frequency Sequence Name: HOP_FREQ_SEQ_25

| SEQ# | Frequency (GHz) | SEQ# | Frequency (GHz) | SEQ# | Frequency (GHz) | SEQ# | Frequency (GHz) |
|------|-----------------|------|-----------------|------|-----------------|------|-----------------|
| 1 | 5.336 | 2 | 5.277 | 3 | 5.619 | 4 | 5.303 |
| 5 | 5.685 | 6 | 5.545 | 7 | 5.356 | 8 | 5.341 |
| 9 | 5.471 | 10 | 5.533 | 11 | 5.724 | 12 | 5.716 |
| 13 | 5.267 | 14 | 5.495 | 15 | 5.253 | 16 | 5.460 |
| 17 | 5.600 | 18 | 5.279 | 19 | 5.333 | 20 | 5.335 |
| 21 | 5.566 | 22 | 5.384 | 23 | 5.718 | 24 | 5.616 |
| 25 | 5.598 | 26 | 5.588 | 27 | 5.722 | 28 | 5.591 |
| 29 | 5.621 | 30 | 5.475 | 31 | 5.366 | 32 | 5.692 |
| 33 | 5.681 | 34 | 5.306 | 35 | 5.595 | 36 | 5.594 |
| 37 | 5.673 | 38 | 5.291 | 39 | 5.400 | 40 | 5.269 |
| 41 | 5.426 | 42 | 5.491 | 43 | 5.281 | 44 | 5.395 |
| 45 | 5.515 | 46 | 5.288 | 47 | 5.519 | 48 | 5.334 |
| 49 | 5.711 | 50 | 5.550 | 51 | 5.464 | 52 | 5.525 |
| 53 | 5.377 | 54 | 5.265 | 55 | 5.452 | 56 | 5.596 |
| 57 | 5.297 | 58 | 5.305 | 59 | 5.565 | 60 | 5.579 |
| 61 | 5.345 | 62 | 5.703 | 63 | 5.719 | 64 | 5.298 |
| 65 | 5.541 | 66 | 5.456 | 67 | 5.282 | 68 | 5.645 |
| 69 | 5.421 | 70 | 5.357 | 71 | 5.351 | 72 | 5.431 |
| 73 | 5.674 | 74 | 5.449 | 75 | 5.576 | 76 | 5.539 |
| 77 | 5.264 | 78 | 5.257 | 79 | 5.439 | 80 | 5.562 |
| 81 | 5.493 | 82 | 5.642 | 83 | 5.668 | 84 | 5.477 |
| 85 | 5.450 | 86 | 5.311 | 87 | 5.544 | 88 | 5.707 |
| 89 | 5.402 | 90 | 5.567 | 91 | 5.442 | 92 | 5.343 |
| 93 | 5.720 | 94 | 5.397 | 95 | 5.665 | 96 | 5.582 |
| 97 | 5.405 | 98 | 5.467 | 99 | 5.444 | 100 | 5.693 |

Hopping Frequency Sequence Name: HOP_FREQ_SEQ_26

| SEQ# | Frequency (GHz) | SEQ# | Frequency (GHz) | SEQ# | Frequency (GHz) | SEQ# | Frequency (GHz) |
|------|-----------------|------|-----------------|------|-----------------|------|-----------------|
| 1 | 5.474 | 2 | 5.271 | 3 | 5.495 | 4 | 5.592 |
| 5 | 5.560 | 6 | 5.447 | 7 | 5.713 | 8 | 5.561 |
| 9 | 5.389 | 10 | 5.526 | 11 | 5.400 | 12 | 5.715 |
| 13 | 5.672 | 14 | 5.388 | 15 | 5.450 | 16 | 5.325 |
| 17 | 5.706 | 18 | 5.556 | 19 | 5.621 | 20 | 5.522 |
| 21 | 5.532 | 22 | 5.357 | 23 | 5.587 | 24 | 5.258 |
| 25 | 5.435 | 26 | 5.329 | 27 | 5.716 | 28 | 5.571 |
| 29 | 5.344 | 30 | 5.250 | 31 | 5.649 | 32 | 5.639 |
| 33 | 5.611 | 34 | 5.466 | 35 | 5.612 | 36 | 5.274 |
| 37 | 5.263 | 38 | 5.539 | 39 | 5.434 | 40 | 5.645 |
| 41 | 5.615 | 42 | 5.572 | 43 | 5.574 | 44 | 5.549 |
| 45 | 5.420 | 46 | 5.646 | 47 | 5.501 | 48 | 5.402 |
| 49 | 5.453 | 50 | 5.320 | 51 | 5.674 | 52 | 5.491 |
| 53 | 5.683 | 54 | 5.700 | 55 | 5.607 | 56 | 5.441 |
| 57 | 5.625 | 58 | 5.464 | 59 | 5.699 | 60 | 5.490 |
| 61 | 5.265 | 62 | 5.719 | 63 | 5.470 | 64 | 5.494 |
| 65 | 5.302 | 66 | 5.391 | 67 | 5.541 | 68 | 5.641 |
| 69 | 5.338 | 70 | 5.722 | 71 | 5.475 | 72 | 5.295 |
| 73 | 5.352 | 74 | 5.692 | 75 | 5.583 | 76 | 5.529 |
| 77 | 5.665 | 78 | 5.603 | 79 | 5.423 | 80 | 5.465 |
| 81 | 5.487 | 82 | 5.415 | 83 | 5.381 | 84 | 5.354 |
| 85 | 5.624 | 86 | 5.502 | 87 | 5.533 | 88 | 5.688 |
| 89 | 5.375 | 90 | 5.272 | 91 | 5.622 | 92 | 5.437 |
| 93 | 5.499 | 94 | 5.714 | 95 | 5.578 | 96 | 5.576 |
| 97 | 5.278 | 98 | 5.513 | 99 | 5.419 | 100 | 5.383 |

Hopping Frequency Sequence Name: HOP_FREQ_SEQ_27

| SEQ# | Frequency (GHz) | SEQ# | Frequency (GHz) | SEQ# | Frequency (GHz) | SEQ# | Frequency (GHz) |
|------|-----------------|------|-----------------|------|-----------------|------|-----------------|
| 1 | 5.668 | 2 | 5.412 | 3 | 5.577 | 4 | 5.421 |
| 5 | 5.372 | 6 | 5.376 | 7 | 5.363 | 8 | 5.645 |
| 9 | 5.696 | 10 | 5.596 | 11 | 5.650 | 12 | 5.587 |
| 13 | 5.306 | 14 | 5.691 | 15 | 5.341 | 16 | 5.256 |
| 17 | 5.399 | 18 | 5.429 | 19 | 5.392 | 20 | 5.632 |
| 21 | 5.263 | 22 | 5.466 | 23 | 5.567 | 24 | 5.265 |
| 25 | 5.522 | 26 | 5.661 | 27 | 5.700 | 28 | 5.511 |
| 29 | 5.536 | 30 | 5.326 | 31 | 5.709 | 32 | 5.695 |
| 33 | 5.669 | 34 | 5.523 | 35 | 5.582 | 36 | 5.580 |
| 37 | 5.550 | 38 | 5.277 | 39 | 5.285 | 40 | 5.557 |
| 41 | 5.574 | 42 | 5.461 | 43 | 5.425 | 44 | 5.551 |
| 45 | 5.608 | 46 | 5.261 | 47 | 5.317 | 48 | 5.260 |
| 49 | 5.439 | 50 | 5.562 | 51 | 5.324 | 52 | 5.414 |
| 53 | 5.527 | 54 | 5.497 | 55 | 5.686 | 56 | 5.259 |
| 57 | 5.664 | 58 | 5.590 | 59 | 5.478 | 60 | 5.404 |
| 61 | 5.589 | 62 | 5.607 | 63 | 5.481 | 64 | 5.689 |
| 65 | 5.389 | 66 | 5.640 | 67 | 5.720 | 68 | 5.697 |
| 69 | 5.402 | 70 | 5.452 | 71 | 5.313 | 72 | 5.717 |
| 73 | 5.257 | 74 | 5.287 | 75 | 5.534 | 76 | 5.553 |
| 77 | 5.304 | 78 | 5.684 | 79 | 5.374 | 80 | 5.390 |
| 81 | 5.441 | 82 | 5.506 | 83 | 5.444 | 84 | 5.329 |
| 85 | 5.250 | 86 | 5.503 | 87 | 5.588 | 88 | 5.442 |
| 89 | 5.611 | 90 | 5.561 | 91 | 5.406 | 92 | 5.663 |
| 93 | 5.297 | 94 | 5.619 | 95 | 5.405 | 96 | 5.677 |
| 97 | 5.501 | 98 | 5.508 | 99 | 5.262 | 100 | 5.474 |

Hopping Frequency Sequence Name: HOP_FREQ_SEQ_28

| SEQ# | Frequency (GHz) | SEQ# | Frequency (GHz) | SEQ# | Frequency (GHz) | SEQ# | Frequency (GHz) |
|------|-----------------|------|-----------------|------|-----------------|------|-----------------|
| 1 | 5.307 | 2 | 5.649 | 3 | 5.482 | 4 | 5.315 |
| 5 | 5.443 | 6 | 5.285 | 7 | 5.390 | 8 | 5.326 |
| 9 | 5.654 | 10 | 5.581 | 11 | 5.263 | 12 | 5.687 |
| 13 | 5.679 | 14 | 5.486 | 15 | 5.279 | 16 | 5.680 |
| 17 | 5.387 | 18 | 5.608 | 19 | 5.487 | 20 | 5.724 |
| 21 | 5.683 | 22 | 5.430 | 23 | 5.436 | 24 | 5.320 |
| 25 | 5.281 | 26 | 5.257 | 27 | 5.539 | 28 | 5.255 |
| 29 | 5.622 | 30 | 5.359 | 31 | 5.251 | 32 | 5.418 |
| 33 | 5.456 | 34 | 5.569 | 35 | 5.628 | 36 | 5.643 |
| 37 | 5.301 | 38 | 5.488 | 39 | 5.338 | 40 | 5.584 |
| 41 | 5.685 | 42 | 5.503 | 43 | 5.411 | 44 | 5.697 |
| 45 | 5.574 | 46 | 5.558 | 47 | 5.468 | 48 | 5.355 |
| 49 | 5.478 | 50 | 5.549 | 51 | 5.283 | 52 | 5.648 |
| 53 | 5.695 | 54 | 5.371 | 55 | 5.304 | 56 | 5.705 |
| 57 | 5.722 | 58 | 5.349 | 59 | 5.453 | 60 | 5.591 |
| 61 | 5.678 | 62 | 5.401 | 63 | 5.284 | 64 | 5.481 |
| 65 | 5.381 | 66 | 5.644 | 67 | 5.422 | 68 | 5.590 |
| 69 | 5.547 | 70 | 5.458 | 71 | 5.274 | 72 | 5.446 |
| 73 | 5.523 | 74 | 5.391 | 75 | 5.719 | 76 | 5.296 |
| 77 | 5.521 | 78 | 5.286 | 79 | 5.435 | 80 | 5.336 |
| 81 | 5.619 | 82 | 5.668 | 83 | 5.565 | 84 | 5.343 |
| 85 | 5.434 | 86 | 5.356 | 87 | 5.374 | 88 | 5.278 |
| 89 | 5.449 | 90 | 5.660 | 91 | 5.544 | 92 | 5.363 |
| 93 | 5.604 | 94 | 5.314 | 95 | 5.499 | 96 | 5.531 |
| 97 | 5.322 | 98 | 5.347 | 99 | 5.675 | 100 | 5.273 |

Hopping Frequency Sequence Name: HOP_FREQ_SEQ_29

| SEQ# | Frequency (GHz) | SEQ# | Frequency (GHz) | SEQ# | Frequency (GHz) | SEQ# | Frequency (GHz) |
|------|-----------------|------|-----------------|------|-----------------|------|-----------------|
| 1 | 5.587 | 2 | 5.271 | 3 | 5.622 | 4 | 5.676 |
| 5 | 5.627 | 6 | 5.604 | 7 | 5.309 | 8 | 5.666 |
| 9 | 5.449 | 10 | 5.613 | 11 | 5.340 | 12 | 5.579 |
| 13 | 5.372 | 14 | 5.263 | 15 | 5.252 | 16 | 5.665 |
| 17 | 5.568 | 18 | 5.386 | 19 | 5.639 | 20 | 5.480 |
| 21 | 5.251 | 22 | 5.270 | 23 | 5.614 | 24 | 5.698 |
| 25 | 5.549 | 26 | 5.451 | 27 | 5.335 | 28 | 5.685 |
| 29 | 5.464 | 30 | 5.424 | 31 | 5.291 | 32 | 5.400 |
| 33 | 5.555 | 34 | 5.530 | 35 | 5.510 | 36 | 5.278 |
| 37 | 5.257 | 38 | 5.595 | 39 | 5.724 | 40 | 5.645 |
| 41 | 5.675 | 42 | 5.317 | 43 | 5.695 | 44 | 5.722 |
| 45 | 5.277 | 46 | 5.522 | 47 | 5.686 | 48 | 5.597 |
| 49 | 5.588 | 50 | 5.517 | 51 | 5.518 | 52 | 5.707 |
| 53 | 5.431 | 54 | 5.364 | 55 | 5.542 | 56 | 5.513 |
| 57 | 5.322 | 58 | 5.405 | 59 | 5.402 | 60 | 5.560 |
| 61 | 5.677 | 62 | 5.492 | 63 | 5.446 | 64 | 5.268 |
| 65 | 5.717 | 66 | 5.459 | 67 | 5.357 | 68 | 5.655 |
| 69 | 5.650 | 70 | 5.314 | 71 | 5.688 | 72 | 5.528 |
| 73 | 5.535 | 74 | 5.715 | 75 | 5.380 | 76 | 5.648 |
| 77 | 5.556 | 78 | 5.531 | 79 | 5.616 | 80 | 5.586 |
| 81 | 5.612 | 82 | 5.435 | 83 | 5.656 | 84 | 5.659 |
| 85 | 5.546 | 86 | 5.407 | 87 | 5.346 | 88 | 5.516 |
| 89 | 5.623 | 90 | 5.634 | 91 | 5.325 | 92 | 5.420 |
| 93 | 5.720 | 94 | 5.558 | 95 | 5.478 | 96 | 5.644 |
| 97 | 5.311 | 98 | 5.607 | 99 | 5.273 | 100 | 5.444 |

Hopping Frequency Sequence Name: HOP_FREQ_SEQ_30

| SEQ# | Frequency (GHz) | SEQ# | Frequency (GHz) | SEQ# | Frequency (GHz) | SEQ# | Frequency (GHz) |
|------|-----------------|------|-----------------|------|-----------------|------|-----------------|
| 1 | 5.490 | 2 | 5.296 | 3 | 5.458 | 4 | 5.553 |
| 5 | 5.430 | 6 | 5.516 | 7 | 5.414 | 8 | 5.618 |
| 9 | 5.521 | 10 | 5.544 | 11 | 5.721 | 12 | 5.438 |
| 13 | 5.311 | 14 | 5.677 | 15 | 5.386 | 16 | 5.382 |
| 17 | 5.600 | 18 | 5.446 | 19 | 5.549 | 20 | 5.422 |
| 21 | 5.291 | 22 | 5.581 | 23 | 5.316 | 24 | 5.359 |
| 25 | 5.637 | 26 | 5.588 | 27 | 5.612 | 28 | 5.288 |
| 29 | 5.455 | 30 | 5.541 | 31 | 5.385 | 32 | 5.557 |
| 33 | 5.413 | 34 | 5.701 | 35 | 5.515 | 36 | 5.254 |
| 37 | 5.459 | 38 | 5.714 | 39 | 5.502 | 40 | 5.528 |
| 41 | 5.536 | 42 | 5.260 | 43 | 5.614 | 44 | 5.451 |
| 45 | 5.663 | 46 | 5.532 | 47 | 5.273 | 48 | 5.482 |
| 49 | 5.689 | 50 | 5.326 | 51 | 5.578 | 52 | 5.537 |
| 53 | 5.266 | 54 | 5.387 | 55 | 5.299 | 56 | 5.513 |
| 57 | 5.355 | 58 | 5.297 | 59 | 5.569 | 60 | 5.262 |
| 61 | 5.699 | 62 | 5.551 | 63 | 5.648 | 64 | 5.679 |
| 65 | 5.389 | 66 | 5.607 | 67 | 5.450 | 68 | 5.421 |
| 69 | 5.571 | 70 | 5.629 | 71 | 5.345 | 72 | 5.623 |
| 73 | 5.380 | 74 | 5.643 | 75 | 5.656 | 76 | 5.500 |
| 77 | 5.664 | 78 | 5.550 | 79 | 5.554 | 80 | 5.269 |
| 81 | 5.435 | 82 | 5.442 | 83 | 5.715 | 84 | 5.284 |
| 85 | 5.277 | 86 | 5.582 | 87 | 5.460 | 88 | 5.412 |
| 89 | 5.638 | 90 | 5.354 | 91 | 5.265 | 92 | 5.323 |
| 93 | 5.585 | 94 | 5.539 | 95 | 5.711 | 96 | 5.390 |
| 97 | 5.697 | 98 | 5.619 | 99 | 5.552 | 100 | 5.650 |

802.11ax (HE80)

Hopping Frequency Sequence Name: HOP_FREQ_SEQ_01

| SEQ# | Frequency (GHz) | SEQ# | Frequency (GHz) | SEQ# | Frequency (GHz) | SEQ# | Frequency (GHz) |
|------|-----------------|------|-----------------|------|-----------------|------|-----------------|
| 1 | 5.540 | 2 | 5.513 | 3 | 5.526 | 4 | 5.574 |
| 5 | 5.501 | 6 | 5.717 | 7 | 5.590 | 8 | 5.373 |
| 9 | 5.338 | 10 | 5.534 | 11 | 5.388 | 12 | 5.493 |
| 13 | 5.447 | 14 | 5.554 | 15 | 5.593 | 16 | 5.566 |
| 17 | 5.688 | 18 | 5.715 | 19 | 5.350 | 20 | 5.713 |
| 21 | 5.404 | 22 | 5.374 | 23 | 5.571 | 24 | 5.420 |
| 25 | 5.588 | 26 | 5.277 | 27 | 5.407 | 28 | 5.610 |
| 29 | 5.278 | 30 | 5.710 | 31 | 5.366 | 32 | 5.301 |
| 33 | 5.666 | 34 | 5.551 | 35 | 5.531 | 36 | 5.339 |
| 37 | 5.410 | 38 | 5.303 | 39 | 5.267 | 40 | 5.538 |
| 41 | 5.327 | 42 | 5.701 | 43 | 5.358 | 44 | 5.581 |
| 45 | 5.408 | 46 | 5.584 | 47 | 5.477 | 48 | 5.357 |
| 49 | 5.703 | 50 | 5.376 | 51 | 5.683 | 52 | 5.413 |
| 53 | 5.662 | 54 | 5.423 | 55 | 5.632 | 56 | 5.668 |
| 57 | 5.619 | 58 | 5.281 | 59 | 5.429 | 60 | 5.289 |
| 61 | 5.306 | 62 | 5.337 | 63 | 5.596 | 64 | 5.286 |
| 65 | 5.592 | 66 | 5.379 | 67 | 5.362 | 68 | 5.351 |
| 69 | 5.433 | 70 | 5.271 | 71 | 5.384 | 72 | 5.614 |
| 73 | 5.504 | 74 | 5.296 | 75 | 5.712 | 76 | 5.452 |
| 77 | 5.687 | 78 | 5.533 | 79 | 5.599 | 80 | 5.561 |
| 81 | 5.293 | 82 | 5.300 | 83 | 5.302 | 84 | 5.718 |
| 85 | 5.291 | 86 | 5.456 | 87 | 5.505 | 88 | 5.636 |
| 89 | 5.367 | 90 | 5.348 | 91 | 5.527 | 92 | 5.558 |
| 93 | 5.640 | 94 | 5.559 | 95 | 5.436 | 96 | 5.613 |
| 97 | 5.472 | 98 | 5.707 | 99 | 5.607 | 100 | 5.680 |

Hopping Frequency Sequence Name: HOP_FREQ_SEQ_02

| SEQ# | Frequency (GHz) | SEQ# | Frequency (GHz) | SEQ# | Frequency (GHz) | SEQ# | Frequency (GHz) |
|------|-----------------|------|-----------------|------|-----------------|------|-----------------|
| 1 | 5.641 | 2 | 5.581 | 3 | 5.679 | 4 | 5.580 |
| 5 | 5.429 | 6 | 5.315 | 7 | 5.582 | 8 | 5.604 |
| 9 | 5.353 | 10 | 5.255 | 11 | 5.260 | 12 | 5.425 |
| 13 | 5.366 | 14 | 5.343 | 15 | 5.478 | 16 | 5.310 |
| 17 | 5.367 | 18 | 5.288 | 19 | 5.595 | 20 | 5.719 |
| 21 | 5.514 | 22 | 5.630 | 23 | 5.327 | 24 | 5.606 |
| 25 | 5.424 | 26 | 5.662 | 27 | 5.482 | 28 | 5.683 |
| 29 | 5.528 | 30 | 5.289 | 31 | 5.700 | 32 | 5.541 |
| 33 | 5.356 | 34 | 5.585 | 35 | 5.506 | 36 | 5.297 |
| 37 | 5.391 | 38 | 5.505 | 39 | 5.511 | 40 | 5.333 |
| 41 | 5.292 | 42 | 5.572 | 43 | 5.329 | 44 | 5.553 |
| 45 | 5.408 | 46 | 5.612 | 47 | 5.532 | 48 | 5.423 |
| 49 | 5.594 | 50 | 5.495 | 51 | 5.499 | 52 | 5.607 |
| 53 | 5.706 | 54 | 5.525 | 55 | 5.692 | 56 | 5.390 |
| 57 | 5.576 | 58 | 5.270 | 59 | 5.549 | 60 | 5.468 |
| 61 | 5.407 | 62 | 5.455 | 63 | 5.448 | 64 | 5.565 |
| 65 | 5.687 | 66 | 5.656 | 67 | 5.335 | 68 | 5.649 |
| 69 | 5.360 | 70 | 5.349 | 71 | 5.504 | 72 | 5.661 |
| 73 | 5.422 | 74 | 5.328 | 75 | 5.311 | 76 | 5.307 |
| 77 | 5.669 | 78 | 5.561 | 79 | 5.521 | 80 | 5.342 |
| 81 | 5.337 | 82 | 5.518 | 83 | 5.441 | 84 | 5.436 |
| 85 | 5.682 | 86 | 5.562 | 87 | 5.466 | 88 | 5.539 |
| 89 | 5.372 | 90 | 5.534 | 91 | 5.284 | 92 | 5.537 |
| 93 | 5.701 | 94 | 5.384 | 95 | 5.251 | 96 | 5.445 |
| 97 | 5.473 | 98 | 5.388 | 99 | 5.280 | 100 | 5.285 |

Hopping Frequency Sequence Name: HOP_FREQ_SEQ_03

| SEQ# | Frequency (GHz) | SEQ# | Frequency (GHz) | SEQ# | Frequency (GHz) | SEQ# | Frequency (GHz) |
|------|-----------------|------|-----------------|------|-----------------|------|-----------------|
| 1 | 5.284 | 2 | 5.304 | 3 | 5.456 | 4 | 5.489 |
| 5 | 5.670 | 6 | 5.409 | 7 | 5.574 | 8 | 5.448 |
| 9 | 5.581 | 10 | 5.467 | 11 | 5.637 | 12 | 5.651 |
| 13 | 5.641 | 14 | 5.407 | 15 | 5.281 | 16 | 5.321 |
| 17 | 5.428 | 18 | 5.355 | 19 | 5.260 | 20 | 5.276 |
| 21 | 5.435 | 22 | 5.640 | 23 | 5.683 | 24 | 5.333 |
| 25 | 5.382 | 26 | 5.712 | 27 | 5.391 | 28 | 5.401 |
| 29 | 5.554 | 30 | 5.383 | 31 | 5.261 | 32 | 5.315 |
| 33 | 5.563 | 34 | 5.326 | 35 | 5.652 | 36 | 5.393 |
| 37 | 5.280 | 38 | 5.352 | 39 | 5.588 | 40 | 5.595 |
| 41 | 5.498 | 42 | 5.618 | 43 | 5.596 | 44 | 5.307 |
| 45 | 5.720 | 46 | 5.495 | 47 | 5.542 | 48 | 5.469 |
| 49 | 5.617 | 50 | 5.623 | 51 | 5.723 | 52 | 5.440 |
| 53 | 5.350 | 54 | 5.338 | 55 | 5.332 | 56 | 5.602 |
| 57 | 5.277 | 58 | 5.367 | 59 | 5.572 | 60 | 5.611 |
| 61 | 5.294 | 62 | 5.584 | 63 | 5.529 | 64 | 5.678 |
| 65 | 5.501 | 66 | 5.267 | 67 | 5.536 | 68 | 5.301 |
| 69 | 5.516 | 70 | 5.650 | 71 | 5.664 | 72 | 5.662 |
| 73 | 5.263 | 74 | 5.458 | 75 | 5.528 | 76 | 5.707 |
| 77 | 5.717 | 78 | 5.418 | 79 | 5.560 | 80 | 5.604 |
| 81 | 5.644 | 82 | 5.396 | 83 | 5.416 | 84 | 5.514 |
| 85 | 5.526 | 86 | 5.699 | 87 | 5.443 | 88 | 5.674 |
| 89 | 5.411 | 90 | 5.671 | 91 | 5.510 | 92 | 5.257 |
| 93 | 5.436 | 94 | 5.424 | 95 | 5.459 | 96 | 5.273 |
| 97 | 5.685 | 98 | 5.463 | 99 | 5.288 | 100 | 5.275 |

Hopping Frequency Sequence Name: HOP_FREQ_SEQ_04

| SEQ# | Frequency (GHz) | SEQ# | Frequency (GHz) | SEQ# | Frequency (GHz) | SEQ# | Frequency (GHz) |
|------|-----------------|------|-----------------|------|-----------------|------|-----------------|
| 1 | 5.278 | 2 | 5.505 | 3 | 5.563 | 4 | 5.422 |
| 5 | 5.685 | 6 | 5.270 | 7 | 5.545 | 8 | 5.321 |
| 9 | 5.641 | 10 | 5.680 | 11 | 5.568 | 12 | 5.284 |
| 13 | 5.675 | 14 | 5.542 | 15 | 5.406 | 16 | 5.426 |
| 17 | 5.346 | 18 | 5.327 | 19 | 5.558 | 20 | 5.423 |
| 21 | 5.285 | 22 | 5.434 | 23 | 5.720 | 24 | 5.538 |
| 25 | 5.357 | 26 | 5.286 | 27 | 5.362 | 28 | 5.522 |
| 29 | 5.520 | 30 | 5.438 | 31 | 5.418 | 32 | 5.448 |
| 33 | 5.605 | 34 | 5.451 | 35 | 5.516 | 36 | 5.319 |
| 37 | 5.694 | 38 | 5.671 | 39 | 5.518 | 40 | 5.553 |
| 41 | 5.252 | 42 | 5.395 | 43 | 5.482 | 44 | 5.419 |
| 45 | 5.397 | 46 | 5.716 | 47 | 5.349 | 48 | 5.661 |
| 49 | 5.296 | 50 | 5.693 | 51 | 5.414 | 52 | 5.670 |
| 53 | 5.356 | 54 | 5.527 | 55 | 5.704 | 56 | 5.566 |
| 57 | 5.429 | 58 | 5.592 | 59 | 5.353 | 60 | 5.361 |
| 61 | 5.475 | 62 | 5.636 | 63 | 5.508 | 64 | 5.718 |
| 65 | 5.484 | 66 | 5.405 | 67 | 5.348 | 68 | 5.650 |
| 69 | 5.412 | 70 | 5.607 | 71 | 5.294 | 72 | 5.721 |
| 73 | 5.565 | 74 | 5.379 | 75 | 5.279 | 76 | 5.433 |
| 77 | 5.578 | 78 | 5.610 | 79 | 5.477 | 80 | 5.571 |
| 81 | 5.276 | 82 | 5.495 | 83 | 5.308 | 84 | 5.698 |
| 85 | 5.572 | 86 | 5.398 | 87 | 5.387 | 88 | 5.597 |
| 89 | 5.688 | 90 | 5.590 | 91 | 5.485 | 92 | 5.497 |
| 93 | 5.253 | 94 | 5.617 | 95 | 5.632 | 96 | 5.363 |
| 97 | 5.628 | 98 | 5.376 | 99 | 5.282 | 100 | 5.490 |

Hopping Frequency Sequence Name: HOP_FREQ_SEQ_05

| SEQ# | Frequency (GHz) | SEQ# | Frequency (GHz) | SEQ# | Frequency (GHz) | SEQ# | Frequency (GHz) |
|------|-----------------|------|-----------------|------|-----------------|------|-----------------|
| 1 | 5.535 | 2 | 5.444 | 3 | 5.468 | 4 | 5.719 |
| 5 | 5.264 | 6 | 5.349 | 7 | 5.554 | 8 | 5.387 |
| 9 | 5.462 | 10 | 5.632 | 11 | 5.490 | 12 | 5.478 |
| 13 | 5.340 | 14 | 5.494 | 15 | 5.323 | 16 | 5.320 |
| 17 | 5.560 | 18 | 5.435 | 19 | 5.367 | 20 | 5.544 |
| 21 | 5.519 | 22 | 5.401 | 23 | 5.616 | 24 | 5.485 |
| 25 | 5.477 | 26 | 5.482 | 27 | 5.669 | 28 | 5.553 |
| 29 | 5.682 | 30 | 5.308 | 31 | 5.293 | 32 | 5.496 |
| 33 | 5.480 | 34 | 5.593 | 35 | 5.268 | 36 | 5.324 |
| 37 | 5.657 | 38 | 5.587 | 39 | 5.712 | 40 | 5.635 |
| 41 | 5.473 | 42 | 5.441 | 43 | 5.442 | 44 | 5.649 |
| 45 | 5.597 | 46 | 5.517 | 47 | 5.279 | 48 | 5.454 |
| 49 | 5.689 | 50 | 5.456 | 51 | 5.529 | 52 | 5.391 |
| 53 | 5.515 | 54 | 5.350 | 55 | 5.434 | 56 | 5.505 |
| 57 | 5.539 | 58 | 5.582 | 59 | 5.604 | 60 | 5.370 |
| 61 | 5.413 | 62 | 5.414 | 63 | 5.285 | 64 | 5.605 |
| 65 | 5.648 | 66 | 5.345 | 67 | 5.489 | 68 | 5.671 |
| 69 | 5.540 | 70 | 5.289 | 71 | 5.598 | 72 | 5.542 |
| 73 | 5.636 | 74 | 5.381 | 75 | 5.347 | 76 | 5.522 |
| 77 | 5.711 | 78 | 5.693 | 79 | 5.319 | 80 | 5.431 |
| 81 | 5.501 | 82 | 5.486 | 83 | 5.280 | 84 | 5.647 |
| 85 | 5.398 | 86 | 5.259 | 87 | 5.570 | 88 | 5.504 |
| 89 | 5.558 | 90 | 5.426 | 91 | 5.706 | 92 | 5.291 |
| 93 | 5.253 | 94 | 5.662 | 95 | 5.362 | 96 | 5.667 |
| 97 | 5.590 | 98 | 5.569 | 99 | 5.531 | 100 | 5.405 |

Hopping Frequency Sequence Name: HOP_FREQ_SEQ_06

| SEQ# | Frequency (GHz) | SEQ# | Frequency (GHz) | SEQ# | Frequency (GHz) | SEQ# | Frequency (GHz) |
|------|-----------------|------|-----------------|------|-----------------|------|-----------------|
| 1 | 5.642 | 2 | 5.685 | 3 | 5.613 | 4 | 5.701 |
| 5 | 5.526 | 6 | 5.604 | 7 | 5.329 | 8 | 5.551 |
| 9 | 5.624 | 10 | 5.389 | 11 | 5.696 | 12 | 5.599 |
| 13 | 5.323 | 14 | 5.274 | 15 | 5.293 | 16 | 5.416 |
| 17 | 5.720 | 18 | 5.453 | 19 | 5.655 | 20 | 5.608 |
| 21 | 5.344 | 22 | 5.349 | 23 | 5.399 | 24 | 5.605 |
| 25 | 5.326 | 26 | 5.693 | 27 | 5.674 | 28 | 5.255 |
| 29 | 5.370 | 30 | 5.285 | 31 | 5.666 | 32 | 5.578 |
| 33 | 5.260 | 34 | 5.275 | 35 | 5.409 | 36 | 5.715 |
| 37 | 5.660 | 38 | 5.460 | 39 | 5.324 | 40 | 5.509 |
| 41 | 5.712 | 42 | 5.312 | 43 | 5.480 | 44 | 5.375 |
| 45 | 5.681 | 46 | 5.631 | 47 | 5.714 | 48 | 5.512 |
| 49 | 5.445 | 50 | 5.514 | 51 | 5.354 | 52 | 5.483 |
| 53 | 5.490 | 54 | 5.654 | 55 | 5.386 | 56 | 5.291 |
| 57 | 5.476 | 58 | 5.716 | 59 | 5.362 | 60 | 5.265 |
| 61 | 5.680 | 62 | 5.439 | 63 | 5.541 | 64 | 5.573 |
| 65 | 5.682 | 66 | 5.644 | 67 | 5.414 | 68 | 5.422 |
| 69 | 5.668 | 70 | 5.677 | 71 | 5.609 | 72 | 5.705 |
| 73 | 5.473 | 74 | 5.517 | 75 | 5.482 | 76 | 5.549 |
| 77 | 5.360 | 78 | 5.485 | 79 | 5.684 | 80 | 5.317 |
| 81 | 5.264 | 82 | 5.711 | 83 | 5.355 | 84 | 5.596 |
| 85 | 5.300 | 86 | 5.592 | 87 | 5.303 | 88 | 5.594 |
| 89 | 5.579 | 90 | 5.649 | 91 | 5.340 | 92 | 5.667 |
| 93 | 5.643 | 94 | 5.575 | 95 | 5.396 | 96 | 5.436 |
| 97 | 5.437 | 98 | 5.408 | 99 | 5.561 | 100 | 5.421 |

Hopping Frequency Sequence Name: HOP_FREQ_SEQ_07

| SEQ# | Frequency (GHz) | SEQ# | Frequency (GHz) | SEQ# | Frequency (GHz) | SEQ# | Frequency (GHz) |
|------|-----------------|------|-----------------|------|-----------------|------|-----------------|
| 1 | 5.597 | 2 | 5.360 | 3 | 5.666 | 4 | 5.431 |
| 5 | 5.587 | 6 | 5.521 | 7 | 5.471 | 8 | 5.553 |
| 9 | 5.676 | 10 | 5.338 | 11 | 5.722 | 12 | 5.347 |
| 13 | 5.458 | 14 | 5.498 | 15 | 5.620 | 16 | 5.641 |
| 17 | 5.596 | 18 | 5.295 | 19 | 5.317 | 20 | 5.605 |
| 21 | 5.532 | 22 | 5.650 | 23 | 5.558 | 24 | 5.700 |
| 25 | 5.495 | 26 | 5.481 | 27 | 5.485 | 28 | 5.390 |
| 29 | 5.656 | 30 | 5.648 | 31 | 5.365 | 32 | 5.708 |
| 33 | 5.371 | 34 | 5.441 | 35 | 5.702 | 36 | 5.504 |
| 37 | 5.261 | 38 | 5.398 | 39 | 5.392 | 40 | 5.572 |
| 41 | 5.683 | 42 | 5.567 | 43 | 5.585 | 44 | 5.623 |
| 45 | 5.569 | 46 | 5.256 | 47 | 5.505 | 48 | 5.649 |
| 49 | 5.426 | 50 | 5.264 | 51 | 5.640 | 52 | 5.690 |
| 53 | 5.520 | 54 | 5.466 | 55 | 5.593 | 56 | 5.568 |
| 57 | 5.325 | 58 | 5.383 | 59 | 5.300 | 60 | 5.389 |
| 61 | 5.469 | 62 | 5.253 | 63 | 5.285 | 64 | 5.724 |
| 65 | 5.538 | 66 | 5.467 | 67 | 5.519 | 68 | 5.686 |
| 69 | 5.539 | 70 | 5.313 | 71 | 5.713 | 72 | 5.312 |
| 73 | 5.654 | 74 | 5.299 | 75 | 5.446 | 76 | 5.366 |
| 77 | 5.320 | 78 | 5.479 | 79 | 5.492 | 80 | 5.340 |
| 81 | 5.548 | 82 | 5.671 | 83 | 5.698 | 84 | 5.674 |
| 85 | 5.343 | 86 | 5.710 | 87 | 5.443 | 88 | 5.503 |
| 89 | 5.599 | 90 | 5.474 | 91 | 5.502 | 92 | 5.437 |
| 93 | 5.263 | 94 | 5.604 | 95 | 5.393 | 96 | 5.372 |
| 97 | 5.369 | 98 | 5.262 | 99 | 5.711 | 100 | 5.527 |

Hopping Frequency Sequence Name: HOP_FREQ_SEQ_08

| SEQ# | Frequency (GHz) | SEQ# | Frequency (GHz) | SEQ# | Frequency (GHz) | SEQ# | Frequency (GHz) |
|------|-----------------|------|-----------------|------|-----------------|------|-----------------|
| 1 | 5.667 | 2 | 5.626 | 3 | 5.314 | 4 | 5.440 |
| 5 | 5.527 | 6 | 5.365 | 7 | 5.653 | 8 | 5.652 |
| 9 | 5.469 | 10 | 5.694 | 11 | 5.496 | 12 | 5.634 |
| 13 | 5.517 | 14 | 5.354 | 15 | 5.481 | 16 | 5.505 |
| 17 | 5.292 | 18 | 5.254 | 19 | 5.569 | 20 | 5.649 |
| 21 | 5.433 | 22 | 5.604 | 23 | 5.404 | 24 | 5.349 |
| 25 | 5.416 | 26 | 5.551 | 27 | 5.603 | 28 | 5.561 |
| 29 | 5.386 | 30 | 5.648 | 31 | 5.369 | 32 | 5.252 |
| 33 | 5.635 | 34 | 5.605 | 35 | 5.399 | 36 | 5.485 |
| 37 | 5.391 | 38 | 5.641 | 39 | 5.518 | 40 | 5.607 |
| 41 | 5.529 | 42 | 5.590 | 43 | 5.520 | 44 | 5.514 |
| 45 | 5.409 | 46 | 5.336 | 47 | 5.567 | 48 | 5.679 |
| 49 | 5.698 | 50 | 5.594 | 51 | 5.564 | 52 | 5.419 |
| 53 | 5.657 | 54 | 5.668 | 55 | 5.689 | 56 | 5.306 |
| 57 | 5.385 | 58 | 5.278 | 59 | 5.688 | 60 | 5.423 |
| 61 | 5.674 | 62 | 5.536 | 63 | 5.544 | 64 | 5.435 |
| 65 | 5.251 | 66 | 5.601 | 67 | 5.438 | 68 | 5.280 |
| 69 | 5.260 | 70 | 5.288 | 71 | 5.711 | 72 | 5.389 |
| 73 | 5.640 | 74 | 5.556 | 75 | 5.664 | 76 | 5.718 |
| 77 | 5.677 | 78 | 5.651 | 79 | 5.277 | 80 | 5.420 |
| 81 | 5.300 | 82 | 5.683 | 83 | 5.573 | 84 | 5.702 |
| 85 | 5.256 | 86 | 5.684 | 87 | 5.533 | 88 | 5.362 |
| 89 | 5.443 | 90 | 5.712 | 91 | 5.612 | 92 | 5.606 |
| 93 | 5.491 | 94 | 5.364 | 95 | 5.338 | 96 | 5.417 |
| 97 | 5.428 | 98 | 5.553 | 99 | 5.595 | 100 | 5.583 |

Hopping Frequency Sequence Name: HOP_FREQ_SEQ_09

| SEQ# | Frequency (GHz) | SEQ# | Frequency (GHz) | SEQ# | Frequency (GHz) | SEQ# | Frequency (GHz) |
|------|-----------------|------|-----------------|------|-----------------|------|-----------------|
| 1 | 5.652 | 2 | 5.260 | 3 | 5.508 | 4 | 5.643 |
| 5 | 5.653 | 6 | 5.659 | 7 | 5.381 | 8 | 5.683 |
| 9 | 5.724 | 10 | 5.711 | 11 | 5.577 | 12 | 5.333 |
| 13 | 5.682 | 14 | 5.307 | 15 | 5.258 | 16 | 5.603 |
| 17 | 5.605 | 18 | 5.534 | 19 | 5.520 | 20 | 5.491 |
| 21 | 5.367 | 22 | 5.672 | 23 | 5.355 | 24 | 5.372 |
| 25 | 5.651 | 26 | 5.541 | 27 | 5.274 | 28 | 5.666 |
| 29 | 5.498 | 30 | 5.336 | 31 | 5.420 | 32 | 5.701 |
| 33 | 5.496 | 34 | 5.707 | 35 | 5.361 | 36 | 5.608 |
| 37 | 5.582 | 38 | 5.631 | 39 | 5.289 | 40 | 5.386 |
| 41 | 5.568 | 42 | 5.671 | 43 | 5.455 | 44 | 5.279 |
| 45 | 5.558 | 46 | 5.595 | 47 | 5.363 | 48 | 5.352 |
| 49 | 5.549 | 50 | 5.434 | 51 | 5.602 | 52 | 5.362 |
| 53 | 5.379 | 54 | 5.419 | 55 | 5.554 | 56 | 5.686 |
| 57 | 5.366 | 58 | 5.516 | 59 | 5.285 | 60 | 5.405 |
| 61 | 5.319 | 62 | 5.596 | 63 | 5.394 | 64 | 5.385 |
| 65 | 5.356 | 66 | 5.300 | 67 | 5.641 | 68 | 5.280 |
| 69 | 5.332 | 70 | 5.626 | 71 | 5.674 | 72 | 5.295 |
| 73 | 5.664 | 74 | 5.600 | 75 | 5.523 | 76 | 5.440 |
| 77 | 5.286 | 78 | 5.490 | 79 | 5.259 | 80 | 5.593 |
| 81 | 5.531 | 82 | 5.634 | 83 | 5.489 | 84 | 5.559 |
| 85 | 5.527 | 86 | 5.578 | 87 | 5.322 | 88 | 5.589 |
| 89 | 5.709 | 90 | 5.525 | 91 | 5.535 | 92 | 5.537 |
| 93 | 5.636 | 94 | 5.521 | 95 | 5.323 | 96 | 5.716 |
| 97 | 5.611 | 98 | 5.632 | 99 | 5.282 | 100 | 5.598 |

Hopping Frequency Sequence Name: HOP_FREQ_SEQ_10

| SEQ# | Frequency (GHz) | SEQ# | Frequency (GHz) | SEQ# | Frequency (GHz) | SEQ# | Frequency (GHz) |
|------|-----------------|------|-----------------|------|-----------------|------|-----------------|
| 1 | 5.448 | 2 | 5.353 | 3 | 5.542 | 4 | 5.384 |
| 5 | 5.676 | 6 | 5.609 | 7 | 5.518 | 8 | 5.454 |
| 9 | 5.662 | 10 | 5.516 | 11 | 5.357 | 12 | 5.406 |
| 13 | 5.491 | 14 | 5.438 | 15 | 5.408 | 16 | 5.263 |
| 17 | 5.625 | 18 | 5.559 | 19 | 5.652 | 20 | 5.280 |
| 21 | 5.577 | 22 | 5.254 | 23 | 5.556 | 24 | 5.472 |
| 25 | 5.672 | 26 | 5.282 | 27 | 5.639 | 28 | 5.527 |
| 29 | 5.612 | 30 | 5.569 | 31 | 5.555 | 32 | 5.630 |
| 33 | 5.347 | 34 | 5.607 | 35 | 5.647 | 36 | 5.425 |
| 37 | 5.422 | 38 | 5.329 | 39 | 5.501 | 40 | 5.704 |
| 41 | 5.364 | 42 | 5.374 | 43 | 5.702 | 44 | 5.554 |
| 45 | 5.644 | 46 | 5.277 | 47 | 5.626 | 48 | 5.418 |
| 49 | 5.587 | 50 | 5.604 | 51 | 5.677 | 52 | 5.558 |
| 53 | 5.568 | 54 | 5.534 | 55 | 5.497 | 56 | 5.401 |
| 57 | 5.252 | 58 | 5.466 | 59 | 5.571 | 60 | 5.584 |
| 61 | 5.714 | 62 | 5.682 | 63 | 5.552 | 64 | 5.610 |
| 65 | 5.597 | 66 | 5.392 | 67 | 5.370 | 68 | 5.456 |
| 69 | 5.316 | 70 | 5.274 | 71 | 5.506 | 72 | 5.523 |
| 73 | 5.537 | 74 | 5.533 | 75 | 5.546 | 76 | 5.645 |
| 77 | 5.276 | 78 | 5.505 | 79 | 5.484 | 80 | 5.684 |
| 81 | 5.679 | 82 | 5.259 | 83 | 5.285 | 84 | 5.668 |
| 85 | 5.723 | 86 | 5.656 | 87 | 5.673 | 88 | 5.255 |
| 89 | 5.594 | 90 | 5.339 | 91 | 5.268 | 92 | 5.502 |
| 93 | 5.496 | 94 | 5.503 | 95 | 5.323 | 96 | 5.273 |
| 97 | 5.342 | 98 | 5.711 | 99 | 5.410 | 100 | 5.661 |

Hopping Frequency Sequence Name: HOP_FREQ_SEQ_11

| SEQ# | Frequency (GHz) | SEQ# | Frequency (GHz) | SEQ# | Frequency (GHz) | SEQ# | Frequency (GHz) |
|------|-----------------|------|-----------------|------|-----------------|------|-----------------|
| 1 | 5.407 | 2 | 5.441 | 3 | 5.498 | 4 | 5.515 |
| 5 | 5.358 | 6 | 5.316 | 7 | 5.659 | 8 | 5.695 |
| 9 | 5.542 | 10 | 5.393 | 11 | 5.592 | 12 | 5.682 |
| 13 | 5.332 | 14 | 5.675 | 15 | 5.608 | 16 | 5.588 |
| 17 | 5.578 | 18 | 5.291 | 19 | 5.614 | 20 | 5.282 |
| 21 | 5.648 | 22 | 5.476 | 23 | 5.273 | 24 | 5.312 |
| 25 | 5.697 | 26 | 5.658 | 27 | 5.349 | 28 | 5.600 |
| 29 | 5.279 | 30 | 5.431 | 31 | 5.484 | 32 | 5.372 |
| 33 | 5.283 | 34 | 5.378 | 35 | 5.401 | 36 | 5.505 |
| 37 | 5.471 | 38 | 5.295 | 39 | 5.470 | 40 | 5.341 |
| 41 | 5.669 | 42 | 5.366 | 43 | 5.290 | 44 | 5.475 |
| 45 | 5.549 | 46 | 5.633 | 47 | 5.430 | 48 | 5.539 |
| 49 | 5.425 | 50 | 5.387 | 51 | 5.511 | 52 | 5.373 |
| 53 | 5.514 | 54 | 5.634 | 55 | 5.297 | 56 | 5.461 |
| 57 | 5.392 | 58 | 5.516 | 59 | 5.270 | 60 | 5.280 |
| 61 | 5.427 | 62 | 5.570 | 63 | 5.289 | 64 | 5.310 |
| 65 | 5.411 | 66 | 5.412 | 67 | 5.711 | 68 | 5.568 |
| 69 | 5.386 | 70 | 5.655 | 71 | 5.409 | 72 | 5.374 |
| 73 | 5.437 | 74 | 5.302 | 75 | 5.617 | 76 | 5.572 |
| 77 | 5.370 | 78 | 5.667 | 79 | 5.601 | 80 | 5.447 |
| 81 | 5.551 | 82 | 5.525 | 83 | 5.292 | 84 | 5.481 |
| 85 | 5.571 | 86 | 5.605 | 87 | 5.395 | 88 | 5.496 |
| 89 | 5.402 | 90 | 5.644 | 91 | 5.631 | 92 | 5.432 |
| 93 | 5.694 | 94 | 5.662 | 95 | 5.540 | 96 | 5.489 |
| 97 | 5.463 | 98 | 5.521 | 99 | 5.486 | 100 | 5.616 |

Hopping Frequency Sequence Name: HOP_FREQ_SEQ_12

| SEQ# | Frequency (GHz) | SEQ# | Frequency (GHz) | SEQ# | Frequency (GHz) | SEQ# | Frequency (GHz) |
|------|-----------------|------|-----------------|------|-----------------|------|-----------------|
| 1 | 5.544 | 2 | 5.339 | 3 | 5.529 | 4 | 5.472 |
| 5 | 5.508 | 6 | 5.431 | 7 | 5.596 | 8 | 5.270 |
| 9 | 5.327 | 10 | 5.379 | 11 | 5.662 | 12 | 5.462 |
| 13 | 5.273 | 14 | 5.617 | 15 | 5.651 | 16 | 5.377 |
| 17 | 5.686 | 18 | 5.415 | 19 | 5.488 | 20 | 5.380 |
| 21 | 5.351 | 22 | 5.688 | 23 | 5.260 | 24 | 5.530 |
| 25 | 5.589 | 26 | 5.703 | 27 | 5.632 | 28 | 5.609 |
| 29 | 5.333 | 30 | 5.286 | 31 | 5.507 | 32 | 5.693 |
| 33 | 5.664 | 34 | 5.582 | 35 | 5.461 | 36 | 5.358 |
| 37 | 5.667 | 38 | 5.555 | 39 | 5.367 | 40 | 5.570 |
| 41 | 5.711 | 42 | 5.372 | 43 | 5.537 | 44 | 5.267 |
| 45 | 5.301 | 46 | 5.585 | 47 | 5.288 | 48 | 5.583 |
| 49 | 5.398 | 50 | 5.421 | 51 | 5.291 | 52 | 5.445 |
| 53 | 5.541 | 54 | 5.504 | 55 | 5.384 | 56 | 5.299 |
| 57 | 5.543 | 58 | 5.556 | 59 | 5.496 | 60 | 5.477 |
| 61 | 5.423 | 62 | 5.678 | 63 | 5.624 | 64 | 5.353 |
| 65 | 5.413 | 66 | 5.296 | 67 | 5.706 | 68 | 5.685 |
| 69 | 5.473 | 70 | 5.722 | 71 | 5.424 | 72 | 5.525 |
| 73 | 5.674 | 74 | 5.359 | 75 | 5.325 | 76 | 5.489 |
| 77 | 5.614 | 78 | 5.622 | 79 | 5.294 | 80 | 5.573 |
| 81 | 5.494 | 82 | 5.326 | 83 | 5.394 | 84 | 5.482 |
| 85 | 5.650 | 86 | 5.435 | 87 | 5.659 | 88 | 5.400 |
| 89 | 5.637 | 90 | 5.355 | 91 | 5.258 | 92 | 5.449 |
| 93 | 5.718 | 94 | 5.676 | 95 | 5.447 | 96 | 5.549 |
| 97 | 5.640 | 98 | 5.645 | 99 | 5.276 | 100 | 5.533 |

Hopping Frequency Sequence Name: HOP_FREQ_SEQ_13

| SEQ# | Frequency (GHz) | SEQ# | Frequency (GHz) | SEQ# | Frequency (GHz) | SEQ# | Frequency (GHz) |
|------|-----------------|------|-----------------|------|-----------------|------|-----------------|
| 1 | 5.358 | 2 | 5.430 | 3 | 5.615 | 4 | 5.653 |
| 5 | 5.439 | 6 | 5.310 | 7 | 5.399 | 8 | 5.722 |
| 9 | 5.721 | 10 | 5.494 | 11 | 5.352 | 12 | 5.449 |
| 13 | 5.538 | 14 | 5.337 | 15 | 5.438 | 16 | 5.262 |
| 17 | 5.307 | 18 | 5.409 | 19 | 5.503 | 20 | 5.419 |
| 21 | 5.487 | 22 | 5.282 | 23 | 5.417 | 24 | 5.295 |
| 25 | 5.644 | 26 | 5.622 | 27 | 5.383 | 28 | 5.334 |
| 29 | 5.692 | 30 | 5.658 | 31 | 5.598 | 32 | 5.372 |
| 33 | 5.573 | 34 | 5.576 | 35 | 5.491 | 36 | 5.621 |
| 37 | 5.380 | 38 | 5.586 | 39 | 5.527 | 40 | 5.698 |
| 41 | 5.342 | 42 | 5.275 | 43 | 5.492 | 44 | 5.630 |
| 45 | 5.529 | 46 | 5.724 | 47 | 5.269 | 48 | 5.411 |
| 49 | 5.474 | 50 | 5.608 | 51 | 5.553 | 52 | 5.602 |
| 53 | 5.429 | 54 | 5.478 | 55 | 5.312 | 56 | 5.318 |
| 57 | 5.673 | 58 | 5.297 | 59 | 5.369 | 60 | 5.377 |
| 61 | 5.375 | 62 | 5.285 | 63 | 5.558 | 64 | 5.260 |
| 65 | 5.390 | 66 | 5.268 | 67 | 5.656 | 68 | 5.370 |
| 69 | 5.596 | 70 | 5.605 | 71 | 5.591 | 72 | 5.629 |
| 73 | 5.506 | 74 | 5.351 | 75 | 5.281 | 76 | 5.336 |
| 77 | 5.524 | 78 | 5.521 | 79 | 5.461 | 80 | 5.367 |
| 81 | 5.296 | 82 | 5.347 | 83 | 5.435 | 84 | 5.329 |
| 85 | 5.340 | 86 | 5.299 | 87 | 5.680 | 88 | 5.448 |
| 89 | 5.261 | 90 | 5.510 | 91 | 5.265 | 92 | 5.555 |
| 93 | 5.595 | 94 | 5.457 | 95 | 5.280 | 96 | 5.359 |
| 97 | 5.410 | 98 | 5.509 | 99 | 5.379 | 100 | 5.447 |

Hopping Frequency Sequence Name: HOP_FREQ_SEQ_14

| SEQ# | Frequency (GHz) | SEQ# | Frequency (GHz) | SEQ# | Frequency (GHz) | SEQ# | Frequency (GHz) |
|------|-----------------|------|-----------------|------|-----------------|------|-----------------|
| 1 | 5.393 | 2 | 5.673 | 3 | 5.362 | 4 | 5.390 |
| 5 | 5.528 | 6 | 5.625 | 7 | 5.315 | 8 | 5.383 |
| 9 | 5.653 | 10 | 5.342 | 11 | 5.572 | 12 | 5.613 |
| 13 | 5.252 | 14 | 5.520 | 15 | 5.685 | 16 | 5.292 |
| 17 | 5.268 | 18 | 5.450 | 19 | 5.259 | 20 | 5.674 |
| 21 | 5.321 | 22 | 5.371 | 23 | 5.531 | 24 | 5.381 |
| 25 | 5.284 | 26 | 5.403 | 27 | 5.599 | 28 | 5.549 |
| 29 | 5.400 | 30 | 5.482 | 31 | 5.281 | 32 | 5.454 |
| 33 | 5.689 | 34 | 5.290 | 35 | 5.481 | 36 | 5.540 |
| 37 | 5.571 | 38 | 5.368 | 39 | 5.440 | 40 | 5.555 |
| 41 | 5.607 | 42 | 5.399 | 43 | 5.713 | 44 | 5.301 |
| 45 | 5.423 | 46 | 5.369 | 47 | 5.445 | 48 | 5.566 |
| 49 | 5.574 | 50 | 5.724 | 51 | 5.639 | 52 | 5.406 |
| 53 | 5.407 | 54 | 5.543 | 55 | 5.476 | 56 | 5.660 |
| 57 | 5.633 | 58 | 5.700 | 59 | 5.417 | 60 | 5.439 |
| 61 | 5.589 | 62 | 5.585 | 63 | 5.435 | 64 | 5.500 |
| 65 | 5.715 | 66 | 5.280 | 67 | 5.697 | 68 | 5.366 |
| 69 | 5.442 | 70 | 5.558 | 71 | 5.286 | 72 | 5.448 |
| 73 | 5.716 | 74 | 5.508 | 75 | 5.634 | 76 | 5.488 |
| 77 | 5.657 | 78 | 5.554 | 79 | 5.461 | 80 | 5.721 |
| 81 | 5.517 | 82 | 5.269 | 83 | 5.584 | 84 | 5.693 |
| 85 | 5.587 | 86 | 5.502 | 87 | 5.431 | 88 | 5.405 |
| 89 | 5.272 | 90 | 5.707 | 91 | 5.667 | 92 | 5.418 |
| 93 | 5.662 | 94 | 5.387 | 95 | 5.610 | 96 | 5.536 |
| 97 | 5.485 | 98 | 5.605 | 99 | 5.526 | 100 | 5.279 |

Hopping Frequency Sequence Name: HOP_FREQ_SEQ_15

| SEQ# | Frequency (GHz) | SEQ# | Frequency (GHz) | SEQ# | Frequency (GHz) | SEQ# | Frequency (GHz) |
|------|-----------------|------|-----------------|------|-----------------|------|-----------------|
| 1 | 5.293 | 2 | 5.401 | 3 | 5.260 | 4 | 5.640 |
| 5 | 5.308 | 6 | 5.684 | 7 | 5.527 | 8 | 5.417 |
| 9 | 5.419 | 10 | 5.660 | 11 | 5.495 | 12 | 5.628 |
| 13 | 5.363 | 14 | 5.470 | 15 | 5.517 | 16 | 5.412 |
| 17 | 5.446 | 18 | 5.302 | 19 | 5.567 | 20 | 5.712 |
| 21 | 5.272 | 22 | 5.335 | 23 | 5.582 | 24 | 5.500 |
| 25 | 5.311 | 26 | 5.550 | 27 | 5.378 | 28 | 5.601 |
| 29 | 5.671 | 30 | 5.667 | 31 | 5.452 | 32 | 5.271 |
| 33 | 5.283 | 34 | 5.719 | 35 | 5.536 | 36 | 5.652 |
| 37 | 5.526 | 38 | 5.481 | 39 | 5.657 | 40 | 5.254 |
| 41 | 5.343 | 42 | 5.505 | 43 | 5.542 | 44 | 5.483 |
| 45 | 5.342 | 46 | 5.259 | 47 | 5.710 | 48 | 5.545 |
| 49 | 5.410 | 50 | 5.516 | 51 | 5.489 | 52 | 5.696 |
| 53 | 5.512 | 54 | 5.554 | 55 | 5.571 | 56 | 5.433 |
| 57 | 5.445 | 58 | 5.634 | 59 | 5.345 | 60 | 5.434 |
| 61 | 5.716 | 62 | 5.613 | 63 | 5.541 | 64 | 5.268 |
| 65 | 5.282 | 66 | 5.252 | 67 | 5.442 | 68 | 5.488 |
| 69 | 5.703 | 70 | 5.586 | 71 | 5.349 | 72 | 5.544 |
| 73 | 5.325 | 74 | 5.514 | 75 | 5.456 | 76 | 5.508 |
| 77 | 5.403 | 78 | 5.387 | 79 | 5.406 | 80 | 5.653 |
| 81 | 5.497 | 82 | 5.454 | 83 | 5.307 | 84 | 5.430 |
| 85 | 5.377 | 86 | 5.431 | 87 | 5.382 | 88 | 5.539 |
| 89 | 5.251 | 90 | 5.420 | 91 | 5.638 | 92 | 5.676 |
| 93 | 5.592 | 94 | 5.579 | 95 | 5.463 | 96 | 5.678 |
| 97 | 5.262 | 98 | 5.364 | 99 | 5.388 | 100 | 5.261 |

Hopping Frequency Sequence Name: HOP_FREQ_SEQ_16

| SEQ# | Frequency (GHz) | SEQ# | Frequency (GHz) | SEQ# | Frequency (GHz) | SEQ# | Frequency (GHz) |
|------|-----------------|------|-----------------|------|-----------------|------|-----------------|
| 1 | 5.700 | 2 | 5.350 | 3 | 5.410 | 4 | 5.401 |
| 5 | 5.669 | 6 | 5.409 | 7 | 5.462 | 8 | 5.338 |
| 9 | 5.266 | 10 | 5.526 | 11 | 5.681 | 12 | 5.337 |
| 13 | 5.420 | 14 | 5.267 | 15 | 5.516 | 16 | 5.629 |
| 17 | 5.389 | 18 | 5.299 | 19 | 5.490 | 20 | 5.398 |
| 21 | 5.380 | 22 | 5.418 | 23 | 5.523 | 24 | 5.655 |
| 25 | 5.360 | 26 | 5.328 | 27 | 5.397 | 28 | 5.639 |
| 29 | 5.417 | 30 | 5.423 | 31 | 5.540 | 32 | 5.342 |
| 33 | 5.656 | 34 | 5.296 | 35 | 5.491 | 36 | 5.635 |
| 37 | 5.395 | 38 | 5.255 | 39 | 5.556 | 40 | 5.254 |
| 41 | 5.278 | 42 | 5.648 | 43 | 5.295 | 44 | 5.576 |
| 45 | 5.686 | 46 | 5.569 | 47 | 5.439 | 48 | 5.476 |
| 49 | 5.614 | 50 | 5.422 | 51 | 5.336 | 52 | 5.367 |
| 53 | 5.259 | 54 | 5.461 | 55 | 5.566 | 56 | 5.702 |
| 57 | 5.345 | 58 | 5.307 | 59 | 5.319 | 60 | 5.289 |
| 61 | 5.517 | 62 | 5.281 | 63 | 5.581 | 64 | 5.673 |
| 65 | 5.489 | 66 | 5.339 | 67 | 5.436 | 68 | 5.352 |
| 69 | 5.440 | 70 | 5.634 | 71 | 5.504 | 72 | 5.411 |
| 73 | 5.407 | 74 | 5.625 | 75 | 5.601 | 76 | 5.678 |
| 77 | 5.671 | 78 | 5.282 | 79 | 5.710 | 80 | 5.324 |
| 81 | 5.264 | 82 | 5.536 | 83 | 5.633 | 84 | 5.499 |
| 85 | 5.271 | 86 | 5.568 | 87 | 5.559 | 88 | 5.644 |
| 89 | 5.514 | 90 | 5.664 | 91 | 5.326 | 92 | 5.294 |
| 93 | 5.646 | 94 | 5.315 | 95 | 5.340 | 96 | 5.408 |
| 97 | 5.638 | 98 | 5.599 | 99 | 5.670 | 100 | 5.561 |

Hopping Frequency Sequence Name: HOP_FREQ_SEQ_17

| SEQ# | Frequency (GHz) | SEQ# | Frequency (GHz) | SEQ# | Frequency (GHz) | SEQ# | Frequency (GHz) |
|------|-----------------|------|-----------------|------|-----------------|------|-----------------|
| 1 | 5.563 | 2 | 5.478 | 3 | 5.723 | 4 | 5.319 |
| 5 | 5.374 | 6 | 5.492 | 7 | 5.469 | 8 | 5.292 |
| 9 | 5.525 | 10 | 5.252 | 11 | 5.350 | 12 | 5.608 |
| 13 | 5.323 | 14 | 5.681 | 15 | 5.388 | 16 | 5.545 |
| 17 | 5.291 | 18 | 5.517 | 19 | 5.253 | 20 | 5.383 |
| 21 | 5.489 | 22 | 5.654 | 23 | 5.704 | 24 | 5.616 |
| 25 | 5.621 | 26 | 5.593 | 27 | 5.435 | 28 | 5.332 |
| 29 | 5.420 | 30 | 5.375 | 31 | 5.587 | 32 | 5.610 |
| 33 | 5.498 | 34 | 5.376 | 35 | 5.661 | 36 | 5.596 |
| 37 | 5.413 | 38 | 5.269 | 39 | 5.701 | 40 | 5.510 |
| 41 | 5.266 | 42 | 5.626 | 43 | 5.516 | 44 | 5.483 |
| 45 | 5.467 | 46 | 5.518 | 47 | 5.586 | 48 | 5.255 |
| 49 | 5.512 | 50 | 5.315 | 51 | 5.639 | 52 | 5.316 |
| 53 | 5.667 | 54 | 5.625 | 55 | 5.495 | 56 | 5.560 |
| 57 | 5.455 | 58 | 5.286 | 59 | 5.324 | 60 | 5.678 |
| 61 | 5.555 | 62 | 5.594 | 63 | 5.662 | 64 | 5.505 |
| 65 | 5.320 | 66 | 5.685 | 67 | 5.282 | 68 | 5.335 |
| 69 | 5.677 | 70 | 5.585 | 71 | 5.526 | 72 | 5.670 |
| 73 | 5.400 | 74 | 5.541 | 75 | 5.488 | 76 | 5.477 |
| 77 | 5.480 | 78 | 5.507 | 79 | 5.449 | 80 | 5.385 |
| 81 | 5.473 | 82 | 5.412 | 83 | 5.714 | 84 | 5.549 |
| 85 | 5.690 | 86 | 5.295 | 87 | 5.619 | 88 | 5.683 |
| 89 | 5.411 | 90 | 5.343 | 91 | 5.664 | 92 | 5.637 |
| 93 | 5.351 | 94 | 5.285 | 95 | 5.691 | 96 | 5.554 |
| 97 | 5.415 | 98 | 5.530 | 99 | 5.692 | 100 | 5.452 |

Hopping Frequency Sequence Name: HOP_FREQ_SEQ_18

| SEQ# | Frequency (GHz) | SEQ# | Frequency (GHz) | SEQ# | Frequency (GHz) | SEQ# | Frequency (GHz) |
|------|-----------------|------|-----------------|------|-----------------|------|-----------------|
| 1 | 5.497 | 2 | 5.599 | 3 | 5.670 | 4 | 5.665 |
| 5 | 5.351 | 6 | 5.278 | 7 | 5.388 | 8 | 5.600 |
| 9 | 5.263 | 10 | 5.572 | 11 | 5.364 | 12 | 5.532 |
| 13 | 5.643 | 14 | 5.487 | 15 | 5.486 | 16 | 5.631 |
| 17 | 5.515 | 18 | 5.492 | 19 | 5.373 | 20 | 5.442 |
| 21 | 5.358 | 22 | 5.293 | 23 | 5.562 | 24 | 5.355 |
| 25 | 5.496 | 26 | 5.467 | 27 | 5.679 | 28 | 5.707 |
| 29 | 5.607 | 30 | 5.513 | 31 | 5.489 | 32 | 5.485 |
| 33 | 5.320 | 34 | 5.418 | 35 | 5.621 | 36 | 5.416 |
| 37 | 5.522 | 38 | 5.407 | 39 | 5.303 | 40 | 5.357 |
| 41 | 5.378 | 42 | 5.542 | 43 | 5.678 | 44 | 5.452 |
| 45 | 5.574 | 46 | 5.449 | 47 | 5.546 | 48 | 5.610 |
| 49 | 5.434 | 50 | 5.613 | 51 | 5.650 | 52 | 5.469 |
| 53 | 5.281 | 54 | 5.608 | 55 | 5.524 | 56 | 5.529 |
| 57 | 5.428 | 58 | 5.661 | 59 | 5.544 | 60 | 5.512 |
| 61 | 5.393 | 62 | 5.411 | 63 | 5.471 | 64 | 5.462 |
| 65 | 5.504 | 66 | 5.399 | 67 | 5.638 | 68 | 5.298 |
| 69 | 5.395 | 70 | 5.553 | 71 | 5.273 | 72 | 5.578 |
| 73 | 5.463 | 74 | 5.423 | 75 | 5.307 | 76 | 5.516 |
| 77 | 5.507 | 78 | 5.480 | 79 | 5.360 | 80 | 5.721 |
| 81 | 5.598 | 82 | 5.376 | 83 | 5.494 | 84 | 5.398 |
| 85 | 5.595 | 86 | 5.521 | 87 | 5.305 | 88 | 5.446 |
| 89 | 5.275 | 90 | 5.443 | 91 | 5.316 | 92 | 5.437 |
| 93 | 5.549 | 94 | 5.693 | 95 | 5.269 | 96 | 5.295 |
| 97 | 5.668 | 98 | 5.586 | 99 | 5.719 | 100 | 5.615 |

Hopping Frequency Sequence Name: HOP_FREQ_SEQ_19

| SEQ# | Frequency (GHz) | SEQ# | Frequency (GHz) | SEQ# | Frequency (GHz) | SEQ# | Frequency (GHz) |
|------|-----------------|------|-----------------|------|-----------------|------|-----------------|
| 1 | 5.691 | 2 | 5.551 | 3 | 5.579 | 4 | 5.350 |
| 5 | 5.688 | 6 | 5.622 | 7 | 5.294 | 8 | 5.547 |
| 9 | 5.460 | 10 | 5.446 | 11 | 5.270 | 12 | 5.541 |
| 13 | 5.620 | 14 | 5.571 | 15 | 5.384 | 16 | 5.633 |
| 17 | 5.477 | 18 | 5.503 | 19 | 5.553 | 20 | 5.629 |
| 21 | 5.472 | 22 | 5.542 | 23 | 5.528 | 24 | 5.544 |
| 25 | 5.613 | 26 | 5.700 | 27 | 5.434 | 28 | 5.358 |
| 29 | 5.525 | 30 | 5.305 | 31 | 5.644 | 32 | 5.516 |
| 33 | 5.648 | 34 | 5.684 | 35 | 5.488 | 36 | 5.478 |
| 37 | 5.498 | 38 | 5.335 | 39 | 5.441 | 40 | 5.361 |
| 41 | 5.411 | 42 | 5.420 | 43 | 5.396 | 44 | 5.515 |
| 45 | 5.353 | 46 | 5.266 | 47 | 5.451 | 48 | 5.386 |
| 49 | 5.617 | 50 | 5.588 | 51 | 5.374 | 52 | 5.532 |
| 53 | 5.666 | 54 | 5.669 | 55 | 5.314 | 56 | 5.431 |
| 57 | 5.520 | 58 | 5.306 | 59 | 5.272 | 60 | 5.279 |
| 61 | 5.634 | 62 | 5.654 | 63 | 5.619 | 64 | 5.504 |
| 65 | 5.334 | 66 | 5.685 | 67 | 5.690 | 68 | 5.646 |
| 69 | 5.575 | 70 | 5.641 | 71 | 5.297 | 72 | 5.282 |
| 73 | 5.713 | 74 | 5.479 | 75 | 5.663 | 76 | 5.695 |
| 77 | 5.492 | 78 | 5.493 | 79 | 5.668 | 80 | 5.327 |
| 81 | 5.288 | 82 | 5.296 | 83 | 5.413 | 84 | 5.511 |
| 85 | 5.486 | 86 | 5.597 | 87 | 5.286 | 88 | 5.661 |
| 89 | 5.421 | 90 | 5.405 | 91 | 5.536 | 92 | 5.719 |
| 93 | 5.518 | 94 | 5.590 | 95 | 5.608 | 96 | 5.408 |
| 97 | 5.582 | 98 | 5.303 | 99 | 5.449 | 100 | 5.414 |

Hopping Frequency Sequence Name: HOP_FREQ_SEQ_20

| SEQ# | Frequency (GHz) | SEQ# | Frequency (GHz) | SEQ# | Frequency (GHz) | SEQ# | Frequency (GHz) |
|------|-----------------|------|-----------------|------|-----------------|------|-----------------|
| 1 | 5.680 | 2 | 5.483 | 3 | 5.416 | 4 | 5.549 |
| 5 | 5.475 | 6 | 5.321 | 7 | 5.633 | 8 | 5.278 |
| 9 | 5.311 | 10 | 5.524 | 11 | 5.678 | 12 | 5.521 |
| 13 | 5.605 | 14 | 5.367 | 15 | 5.691 | 16 | 5.672 |
| 17 | 5.370 | 18 | 5.504 | 19 | 5.488 | 20 | 5.433 |
| 21 | 5.465 | 22 | 5.282 | 23 | 5.266 | 24 | 5.701 |
| 25 | 5.709 | 26 | 5.267 | 27 | 5.445 | 28 | 5.385 |
| 29 | 5.623 | 30 | 5.299 | 31 | 5.419 | 32 | 5.707 |
| 33 | 5.617 | 34 | 5.322 | 35 | 5.498 | 36 | 5.632 |
| 37 | 5.649 | 38 | 5.546 | 39 | 5.446 | 40 | 5.541 |
| 41 | 5.599 | 42 | 5.630 | 43 | 5.256 | 44 | 5.568 |
| 45 | 5.566 | 46 | 5.537 | 47 | 5.534 | 48 | 5.277 |
| 49 | 5.618 | 50 | 5.374 | 51 | 5.455 | 52 | 5.283 |
| 53 | 5.564 | 54 | 5.312 | 55 | 5.693 | 56 | 5.436 |
| 57 | 5.338 | 58 | 5.372 | 59 | 5.272 | 60 | 5.369 |
| 61 | 5.696 | 62 | 5.507 | 63 | 5.695 | 64 | 5.529 |
| 65 | 5.317 | 66 | 5.384 | 67 | 5.297 | 68 | 5.494 |
| 69 | 5.366 | 70 | 5.705 | 71 | 5.300 | 72 | 5.715 |
| 73 | 5.481 | 74 | 5.287 | 75 | 5.698 | 76 | 5.301 |
| 77 | 5.655 | 78 | 5.670 | 79 | 5.264 | 80 | 5.420 |
| 81 | 5.262 | 82 | 5.676 | 83 | 5.683 | 84 | 5.394 |
| 85 | 5.540 | 86 | 5.337 | 87 | 5.326 | 88 | 5.431 |
| 89 | 5.381 | 90 | 5.505 | 91 | 5.515 | 92 | 5.275 |
| 93 | 5.408 | 94 | 5.690 | 95 | 5.306 | 96 | 5.359 |
| 97 | 5.427 | 98 | 5.342 | 99 | 5.356 | 100 | 5.462 |

Hopping Frequency Sequence Name: HOP_FREQ_SEQ_21

| SEQ# | Frequency (GHz) | SEQ# | Frequency (GHz) | SEQ# | Frequency (GHz) | SEQ# | Frequency (GHz) |
|------|-----------------|------|-----------------|------|-----------------|------|-----------------|
| 1 | 5.600 | 2 | 5.680 | 3 | 5.444 | 4 | 5.459 |
| 5 | 5.718 | 6 | 5.298 | 7 | 5.441 | 8 | 5.605 |
| 9 | 5.622 | 10 | 5.505 | 11 | 5.286 | 12 | 5.634 |
| 13 | 5.683 | 14 | 5.583 | 15 | 5.428 | 16 | 5.667 |
| 17 | 5.570 | 18 | 5.549 | 19 | 5.553 | 20 | 5.353 |
| 21 | 5.602 | 22 | 5.544 | 23 | 5.377 | 24 | 5.341 |
| 25 | 5.677 | 26 | 5.713 | 27 | 5.629 | 28 | 5.321 |
| 29 | 5.483 | 30 | 5.363 | 31 | 5.636 | 32 | 5.504 |
| 33 | 5.595 | 34 | 5.384 | 35 | 5.474 | 36 | 5.625 |
| 37 | 5.269 | 38 | 5.624 | 39 | 5.665 | 40 | 5.375 |
| 41 | 5.712 | 42 | 5.345 | 43 | 5.418 | 44 | 5.457 |
| 45 | 5.311 | 46 | 5.656 | 47 | 5.507 | 48 | 5.429 |
| 49 | 5.440 | 50 | 5.320 | 51 | 5.540 | 52 | 5.477 |
| 53 | 5.411 | 54 | 5.561 | 55 | 5.352 | 56 | 5.317 |
| 57 | 5.497 | 58 | 5.423 | 59 | 5.576 | 60 | 5.367 |
| 61 | 5.509 | 62 | 5.472 | 63 | 5.641 | 64 | 5.597 |
| 65 | 5.559 | 66 | 5.585 | 67 | 5.626 | 68 | 5.336 |
| 69 | 5.271 | 70 | 5.313 | 71 | 5.420 | 72 | 5.448 |
| 73 | 5.443 | 74 | 5.381 | 75 | 5.647 | 76 | 5.431 |
| 77 | 5.370 | 78 | 5.580 | 79 | 5.323 | 80 | 5.548 |
| 81 | 5.430 | 82 | 5.596 | 83 | 5.523 | 84 | 5.530 |
| 85 | 5.560 | 86 | 5.592 | 87 | 5.314 | 88 | 5.422 |
| 89 | 5.607 | 90 | 5.385 | 91 | 5.628 | 92 | 5.421 |
| 93 | 5.463 | 94 | 5.437 | 95 | 5.646 | 96 | 5.648 |
| 97 | 5.536 | 98 | 5.296 | 99 | 5.312 | 100 | 5.409 |

Hopping Frequency Sequence Name: HOP_FREQ_SEQ_22

| SEQ# | Frequency (GHz) | SEQ# | Frequency (GHz) | SEQ# | Frequency (GHz) | SEQ# | Frequency (GHz) |
|------|-----------------|------|-----------------|------|-----------------|------|-----------------|
| 1 | 5.290 | 2 | 5.317 | 3 | 5.630 | 4 | 5.724 |
| 5 | 5.411 | 6 | 5.700 | 7 | 5.507 | 8 | 5.263 |
| 9 | 5.308 | 10 | 5.568 | 11 | 5.400 | 12 | 5.252 |
| 13 | 5.499 | 14 | 5.570 | 15 | 5.528 | 16 | 5.461 |
| 17 | 5.638 | 18 | 5.399 | 19 | 5.398 | 20 | 5.254 |
| 21 | 5.684 | 22 | 5.616 | 23 | 5.659 | 24 | 5.285 |
| 25 | 5.640 | 26 | 5.647 | 27 | 5.357 | 28 | 5.279 |
| 29 | 5.324 | 30 | 5.323 | 31 | 5.327 | 32 | 5.626 |
| 33 | 5.722 | 34 | 5.345 | 35 | 5.302 | 36 | 5.483 |
| 37 | 5.702 | 38 | 5.384 | 39 | 5.305 | 40 | 5.651 |
| 41 | 5.498 | 42 | 5.693 | 43 | 5.255 | 44 | 5.564 |
| 45 | 5.299 | 46 | 5.482 | 47 | 5.446 | 48 | 5.704 |
| 49 | 5.459 | 50 | 5.582 | 51 | 5.288 | 52 | 5.720 |
| 53 | 5.335 | 54 | 5.286 | 55 | 5.541 | 56 | 5.457 |
| 57 | 5.272 | 58 | 5.365 | 59 | 5.529 | 60 | 5.618 |
| 61 | 5.441 | 62 | 5.581 | 63 | 5.386 | 64 | 5.650 |
| 65 | 5.580 | 66 | 5.612 | 67 | 5.601 | 68 | 5.557 |
| 69 | 5.486 | 70 | 5.608 | 71 | 5.511 | 72 | 5.664 |
| 73 | 5.675 | 74 | 5.525 | 75 | 5.567 | 76 | 5.678 |
| 77 | 5.586 | 78 | 5.336 | 79 | 5.291 | 80 | 5.387 |
| 81 | 5.625 | 82 | 5.356 | 83 | 5.412 | 84 | 5.706 |
| 85 | 5.591 | 86 | 5.688 | 87 | 5.374 | 88 | 5.401 |
| 89 | 5.510 | 90 | 5.624 | 91 | 5.321 | 92 | 5.339 |
| 93 | 5.466 | 94 | 5.475 | 95 | 5.655 | 96 | 5.328 |
| 97 | 5.513 | 98 | 5.686 | 99 | 5.352 | 100 | 5.261 |

Hopping Frequency Sequence Name: HOP_FREQ_SEQ_23

| SEQ# | Frequency (GHz) | SEQ# | Frequency (GHz) | SEQ# | Frequency (GHz) | SEQ# | Frequency (GHz) |
|------|-----------------|------|-----------------|------|-----------------|------|-----------------|
| 1 | 5.367 | 2 | 5.276 | 3 | 5.659 | 4 | 5.686 |
| 5 | 5.388 | 6 | 5.552 | 7 | 5.452 | 8 | 5.285 |
| 9 | 5.475 | 10 | 5.441 | 11 | 5.514 | 12 | 5.266 |
| 13 | 5.432 | 14 | 5.462 | 15 | 5.545 | 16 | 5.348 |
| 17 | 5.442 | 18 | 5.489 | 19 | 5.271 | 20 | 5.277 |
| 21 | 5.542 | 22 | 5.594 | 23 | 5.411 | 24 | 5.517 |
| 25 | 5.613 | 26 | 5.275 | 27 | 5.426 | 28 | 5.661 |
| 29 | 5.286 | 30 | 5.595 | 31 | 5.645 | 32 | 5.688 |
| 33 | 5.357 | 34 | 5.690 | 35 | 5.543 | 36 | 5.364 |
| 37 | 5.497 | 38 | 5.393 | 39 | 5.435 | 40 | 5.345 |
| 41 | 5.482 | 42 | 5.344 | 43 | 5.570 | 44 | 5.593 |
| 45 | 5.715 | 46 | 5.602 | 47 | 5.548 | 48 | 5.451 |
| 49 | 5.633 | 50 | 5.471 | 51 | 5.605 | 52 | 5.324 |
| 53 | 5.550 | 54 | 5.526 | 55 | 5.445 | 56 | 5.651 |
| 57 | 5.289 | 58 | 5.582 | 59 | 5.535 | 60 | 5.251 |
| 61 | 5.549 | 62 | 5.362 | 63 | 5.527 | 64 | 5.294 |
| 65 | 5.539 | 66 | 5.423 | 67 | 5.268 | 68 | 5.400 |
| 69 | 5.368 | 70 | 5.684 | 71 | 5.553 | 72 | 5.703 |
| 73 | 5.460 | 74 | 5.436 | 75 | 5.448 | 76 | 5.309 |
| 77 | 5.290 | 78 | 5.260 | 79 | 5.444 | 80 | 5.588 |
| 81 | 5.530 | 82 | 5.682 | 83 | 5.418 | 84 | 5.560 |
| 85 | 5.320 | 86 | 5.486 | 87 | 5.404 | 88 | 5.428 |
| 89 | 5.663 | 90 | 5.401 | 91 | 5.580 | 92 | 5.484 |
| 93 | 5.495 | 94 | 5.319 | 95 | 5.267 | 96 | 5.618 |
| 97 | 5.431 | 98 | 5.327 | 99 | 5.252 | 100 | 5.547 |

Hopping Frequency Sequence Name: HOP_FREQ_SEQ_24

| SEQ# | Frequency (GHz) | SEQ# | Frequency (GHz) | SEQ# | Frequency (GHz) | SEQ# | Frequency (GHz) |
|------|-----------------|------|-----------------|------|-----------------|------|-----------------|
| 1 | 5.280 | 2 | 5.283 | 3 | 5.409 | 4 | 5.651 |
| 5 | 5.340 | 6 | 5.620 | 7 | 5.366 | 8 | 5.353 |
| 9 | 5.501 | 10 | 5.456 | 11 | 5.573 | 12 | 5.583 |
| 13 | 5.375 | 14 | 5.630 | 15 | 5.291 | 16 | 5.333 |
| 17 | 5.477 | 18 | 5.453 | 19 | 5.513 | 20 | 5.510 |
| 21 | 5.445 | 22 | 5.407 | 23 | 5.401 | 24 | 5.671 |
| 25 | 5.523 | 26 | 5.428 | 27 | 5.655 | 28 | 5.603 |
| 29 | 5.650 | 30 | 5.270 | 31 | 5.348 | 32 | 5.367 |
| 33 | 5.564 | 34 | 5.673 | 35 | 5.362 | 36 | 5.378 |
| 37 | 5.528 | 38 | 5.334 | 39 | 5.365 | 40 | 5.568 |
| 41 | 5.341 | 42 | 5.636 | 43 | 5.411 | 44 | 5.549 |
| 45 | 5.394 | 46 | 5.271 | 47 | 5.420 | 48 | 5.724 |
| 49 | 5.467 | 50 | 5.423 | 51 | 5.427 | 52 | 5.580 |
| 53 | 5.611 | 54 | 5.313 | 55 | 5.584 | 56 | 5.553 |
| 57 | 5.396 | 58 | 5.688 | 59 | 5.516 | 60 | 5.433 |
| 61 | 5.487 | 62 | 5.308 | 63 | 5.296 | 64 | 5.338 |
| 65 | 5.666 | 66 | 5.464 | 67 | 5.389 | 68 | 5.421 |
| 69 | 5.721 | 70 | 5.605 | 71 | 5.555 | 72 | 5.447 |
| 73 | 5.455 | 74 | 5.567 | 75 | 5.585 | 76 | 5.656 |
| 77 | 5.469 | 78 | 5.640 | 79 | 5.629 | 80 | 5.424 |
| 81 | 5.481 | 82 | 5.329 | 83 | 5.342 | 84 | 5.610 |
| 85 | 5.710 | 86 | 5.489 | 87 | 5.343 | 88 | 5.442 |
| 89 | 5.692 | 90 | 5.292 | 91 | 5.702 | 92 | 5.601 |
| 93 | 5.491 | 94 | 5.626 | 95 | 5.644 | 96 | 5.641 |
| 97 | 5.406 | 98 | 5.450 | 99 | 5.569 | 100 | 5.690 |

Hopping Frequency Sequence Name: HOP_FREQ_SEQ_25

| SEQ# | Frequency (GHz) | SEQ# | Frequency (GHz) | SEQ# | Frequency (GHz) | SEQ# | Frequency (GHz) |
|------|-----------------|------|-----------------|------|-----------------|------|-----------------|
| 1 | 5.615 | 2 | 5.657 | 3 | 5.676 | 4 | 5.592 |
| 5 | 5.327 | 6 | 5.300 | 7 | 5.337 | 8 | 5.680 |
| 9 | 5.448 | 10 | 5.690 | 11 | 5.417 | 12 | 5.567 |
| 13 | 5.604 | 14 | 5.694 | 15 | 5.516 | 16 | 5.503 |
| 17 | 5.312 | 18 | 5.598 | 19 | 5.696 | 20 | 5.383 |
| 21 | 5.718 | 22 | 5.475 | 23 | 5.603 | 24 | 5.464 |
| 25 | 5.425 | 26 | 5.677 | 27 | 5.320 | 28 | 5.367 |
| 29 | 5.313 | 30 | 5.436 | 31 | 5.463 | 32 | 5.699 |
| 33 | 5.565 | 34 | 5.371 | 35 | 5.411 | 36 | 5.659 |
| 37 | 5.661 | 38 | 5.649 | 39 | 5.391 | 40 | 5.589 |
| 41 | 5.452 | 42 | 5.410 | 43 | 5.484 | 44 | 5.302 |
| 45 | 5.692 | 46 | 5.270 | 47 | 5.386 | 48 | 5.279 |
| 49 | 5.601 | 50 | 5.513 | 51 | 5.602 | 52 | 5.673 |
| 53 | 5.501 | 54 | 5.557 | 55 | 5.494 | 56 | 5.254 |
| 57 | 5.571 | 58 | 5.264 | 59 | 5.573 | 60 | 5.440 |
| 61 | 5.281 | 62 | 5.423 | 63 | 5.358 | 64 | 5.500 |
| 65 | 5.701 | 66 | 5.525 | 67 | 5.446 | 68 | 5.369 |
| 69 | 5.499 | 70 | 5.582 | 71 | 5.717 | 72 | 5.664 |
| 73 | 5.515 | 74 | 5.514 | 75 | 5.461 | 76 | 5.631 |
| 77 | 5.719 | 78 | 5.606 | 79 | 5.483 | 80 | 5.449 |
| 81 | 5.458 | 82 | 5.447 | 83 | 5.616 | 84 | 5.482 |
| 85 | 5.453 | 86 | 5.263 | 87 | 5.542 | 88 | 5.399 |
| 89 | 5.469 | 90 | 5.275 | 91 | 5.295 | 92 | 5.291 |
| 93 | 5.416 | 94 | 5.444 | 95 | 5.599 | 96 | 5.522 |
| 97 | 5.640 | 98 | 5.632 | 99 | 5.472 | 100 | 5.583 |

Hopping Frequency Sequence Name: HOP_FREQ_SEQ_26

| SEQ# | Frequency (GHz) | SEQ# | Frequency (GHz) | SEQ# | Frequency (GHz) | SEQ# | Frequency (GHz) |
|------|-----------------|------|-----------------|------|-----------------|------|-----------------|
| 1 | 5.339 | 2 | 5.672 | 3 | 5.594 | 4 | 5.694 |
| 5 | 5.660 | 6 | 5.647 | 7 | 5.656 | 8 | 5.705 |
| 9 | 5.551 | 10 | 5.542 | 11 | 5.295 | 12 | 5.316 |
| 13 | 5.454 | 14 | 5.592 | 15 | 5.582 | 16 | 5.303 |
| 17 | 5.465 | 18 | 5.417 | 19 | 5.512 | 20 | 5.710 |
| 21 | 5.289 | 22 | 5.286 | 23 | 5.277 | 24 | 5.440 |
| 25 | 5.584 | 26 | 5.518 | 27 | 5.505 | 28 | 5.597 |
| 29 | 5.326 | 30 | 5.371 | 31 | 5.374 | 32 | 5.639 |
| 33 | 5.355 | 34 | 5.609 | 35 | 5.618 | 36 | 5.463 |
| 37 | 5.425 | 38 | 5.404 | 39 | 5.711 | 40 | 5.506 |
| 41 | 5.394 | 42 | 5.431 | 43 | 5.703 | 44 | 5.489 |
| 45 | 5.596 | 46 | 5.575 | 47 | 5.515 | 48 | 5.655 |
| 49 | 5.652 | 50 | 5.494 | 51 | 5.358 | 52 | 5.648 |
| 53 | 5.376 | 54 | 5.457 | 55 | 5.279 | 56 | 5.707 |
| 57 | 5.412 | 58 | 5.396 | 59 | 5.319 | 60 | 5.430 |
| 61 | 5.363 | 62 | 5.379 | 63 | 5.544 | 64 | 5.364 |
| 65 | 5.499 | 66 | 5.622 | 67 | 5.476 | 68 | 5.536 |
| 69 | 5.487 | 70 | 5.587 | 71 | 5.452 | 72 | 5.418 |
| 73 | 5.333 | 74 | 5.321 | 75 | 5.528 | 76 | 5.574 |
| 77 | 5.619 | 78 | 5.386 | 79 | 5.633 | 80 | 5.467 |
| 81 | 5.600 | 82 | 5.500 | 83 | 5.504 | 84 | 5.265 |
| 85 | 5.625 | 86 | 5.359 | 87 | 5.485 | 88 | 5.372 |
| 89 | 5.569 | 90 | 5.456 | 91 | 5.573 | 92 | 5.581 |
| 93 | 5.281 | 94 | 5.314 | 95 | 5.721 | 96 | 5.650 |
| 97 | 5.713 | 98 | 5.275 | 99 | 5.686 | 100 | 5.708 |

Hopping Frequency Sequence Name: HOP_FREQ_SEQ_27

| SEQ# | Frequency (GHz) | SEQ# | Frequency (GHz) | SEQ# | Frequency (GHz) | SEQ# | Frequency (GHz) |
|------|-----------------|------|-----------------|------|-----------------|------|-----------------|
| 1 | 5.452 | 2 | 5.650 | 3 | 5.373 | 4 | 5.568 |
| 5 | 5.602 | 6 | 5.448 | 7 | 5.593 | 8 | 5.367 |
| 9 | 5.529 | 10 | 5.515 | 11 | 5.598 | 12 | 5.338 |
| 13 | 5.380 | 14 | 5.524 | 15 | 5.371 | 16 | 5.401 |
| 17 | 5.522 | 18 | 5.411 | 19 | 5.715 | 20 | 5.590 |
| 21 | 5.300 | 22 | 5.691 | 23 | 5.433 | 24 | 5.430 |
| 25 | 5.670 | 26 | 5.318 | 27 | 5.319 | 28 | 5.333 |
| 29 | 5.260 | 30 | 5.425 | 31 | 5.530 | 32 | 5.708 |
| 33 | 5.722 | 34 | 5.712 | 35 | 5.501 | 36 | 5.654 |
| 37 | 5.485 | 38 | 5.424 | 39 | 5.638 | 40 | 5.445 |
| 41 | 5.564 | 42 | 5.439 | 43 | 5.376 | 44 | 5.442 |
| 45 | 5.619 | 46 | 5.552 | 47 | 5.347 | 48 | 5.408 |
| 49 | 5.316 | 50 | 5.643 | 51 | 5.269 | 52 | 5.484 |
| 53 | 5.687 | 54 | 5.419 | 55 | 5.573 | 56 | 5.473 |
| 57 | 5.327 | 58 | 5.293 | 59 | 5.611 | 60 | 5.475 |
| 61 | 5.537 | 62 | 5.583 | 63 | 5.444 | 64 | 5.661 |
| 65 | 5.551 | 66 | 5.255 | 67 | 5.364 | 68 | 5.349 |
| 69 | 5.574 | 70 | 5.588 | 71 | 5.680 | 72 | 5.497 |
| 73 | 5.585 | 74 | 5.534 | 75 | 5.365 | 76 | 5.721 |
| 77 | 5.469 | 78 | 5.488 | 79 | 5.406 | 80 | 5.348 |
| 81 | 5.504 | 82 | 5.671 | 83 | 5.651 | 84 | 5.375 |
| 85 | 5.286 | 86 | 5.507 | 87 | 5.414 | 88 | 5.519 |
| 89 | 5.684 | 90 | 5.438 | 91 | 5.520 | 92 | 5.265 |
| 93 | 5.404 | 94 | 5.711 | 95 | 5.586 | 96 | 5.657 |
| 97 | 5.302 | 98 | 5.575 | 99 | 5.490 | 100 | 5.464 |

Hopping Frequency Sequence Name: HOP_FREQ_SEQ_28

| SEQ# | Frequency (GHz) | SEQ# | Frequency (GHz) | SEQ# | Frequency (GHz) | SEQ# | Frequency (GHz) |
|------|-----------------|------|-----------------|------|-----------------|------|-----------------|
| 1 | 5.434 | 2 | 5.680 | 3 | 5.335 | 4 | 5.560 |
| 5 | 5.369 | 6 | 5.305 | 7 | 5.710 | 8 | 5.275 |
| 9 | 5.315 | 10 | 5.475 | 11 | 5.269 | 12 | 5.460 |
| 13 | 5.533 | 14 | 5.627 | 15 | 5.702 | 16 | 5.661 |
| 17 | 5.707 | 18 | 5.356 | 19 | 5.687 | 20 | 5.328 |
| 21 | 5.656 | 22 | 5.563 | 23 | 5.581 | 24 | 5.361 |
| 25 | 5.694 | 26 | 5.468 | 27 | 5.456 | 28 | 5.304 |
| 29 | 5.499 | 30 | 5.255 | 31 | 5.391 | 32 | 5.647 |
| 33 | 5.320 | 34 | 5.653 | 35 | 5.298 | 36 | 5.536 |
| 37 | 5.665 | 38 | 5.268 | 39 | 5.623 | 40 | 5.721 |
| 41 | 5.620 | 42 | 5.611 | 43 | 5.313 | 44 | 5.570 |
| 45 | 5.545 | 46 | 5.716 | 47 | 5.524 | 48 | 5.628 |
| 49 | 5.698 | 50 | 5.558 | 51 | 5.278 | 52 | 5.723 |
| 53 | 5.420 | 54 | 5.359 | 55 | 5.722 | 56 | 5.492 |
| 57 | 5.446 | 58 | 5.354 | 59 | 5.474 | 60 | 5.638 |
| 61 | 5.720 | 62 | 5.618 | 63 | 5.582 | 64 | 5.326 |
| 65 | 5.398 | 66 | 5.410 | 67 | 5.634 | 68 | 5.344 |
| 69 | 5.697 | 70 | 5.253 | 71 | 5.519 | 72 | 5.424 |
| 73 | 5.594 | 74 | 5.286 | 75 | 5.599 | 76 | 5.264 |
| 77 | 5.718 | 78 | 5.576 | 79 | 5.682 | 80 | 5.432 |
| 81 | 5.584 | 82 | 5.462 | 83 | 5.525 | 84 | 5.336 |
| 85 | 5.577 | 86 | 5.459 | 87 | 5.714 | 88 | 5.449 |
| 89 | 5.483 | 90 | 5.490 | 91 | 5.347 | 92 | 5.277 |
| 93 | 5.478 | 94 | 5.292 | 95 | 5.274 | 96 | 5.377 |
| 97 | 5.617 | 98 | 5.367 | 99 | 5.472 | 100 | 5.337 |

Hopping Frequency Sequence Name: HOP_FREQ_SEQ_29

| SEQ# | Frequency (GHz) | SEQ# | Frequency (GHz) | SEQ# | Frequency (GHz) | SEQ# | Frequency (GHz) |
|------|-----------------|------|-----------------|------|-----------------|------|-----------------|
| 1 | 5.410 | 2 | 5.585 | 3 | 5.609 | 4 | 5.523 |
| 5 | 5.304 | 6 | 5.466 | 7 | 5.262 | 8 | 5.617 |
| 9 | 5.311 | 10 | 5.677 | 11 | 5.590 | 12 | 5.283 |
| 13 | 5.305 | 14 | 5.601 | 15 | 5.404 | 16 | 5.690 |
| 17 | 5.302 | 18 | 5.655 | 19 | 5.668 | 20 | 5.389 |
| 21 | 5.412 | 22 | 5.709 | 23 | 5.286 | 24 | 5.631 |
| 25 | 5.626 | 26 | 5.487 | 27 | 5.257 | 28 | 5.491 |
| 29 | 5.328 | 30 | 5.345 | 31 | 5.651 | 32 | 5.275 |
| 33 | 5.605 | 34 | 5.430 | 35 | 5.588 | 36 | 5.705 |
| 37 | 5.289 | 38 | 5.694 | 39 | 5.365 | 40 | 5.307 |
| 41 | 5.673 | 42 | 5.288 | 43 | 5.458 | 44 | 5.363 |
| 45 | 5.573 | 46 | 5.424 | 47 | 5.654 | 48 | 5.354 |
| 49 | 5.548 | 50 | 5.696 | 51 | 5.440 | 52 | 5.701 |
| 53 | 5.629 | 54 | 5.390 | 55 | 5.334 | 56 | 5.507 |
| 57 | 5.434 | 58 | 5.724 | 59 | 5.485 | 60 | 5.444 |
| 61 | 5.527 | 62 | 5.428 | 63 | 5.360 | 64 | 5.377 |
| 65 | 5.542 | 66 | 5.641 | 67 | 5.423 | 68 | 5.446 |
| 69 | 5.483 | 70 | 5.478 | 71 | 5.537 | 72 | 5.293 |
| 73 | 5.612 | 74 | 5.476 | 75 | 5.445 | 76 | 5.702 |
| 77 | 5.596 | 78 | 5.388 | 79 | 5.544 | 80 | 5.499 |
| 81 | 5.621 | 82 | 5.353 | 83 | 5.402 | 84 | 5.603 |
| 85 | 5.650 | 86 | 5.469 | 87 | 5.327 | 88 | 5.313 |
| 89 | 5.721 | 90 | 5.432 | 91 | 5.646 | 92 | 5.680 |
| 93 | 5.640 | 94 | 5.295 | 95 | 5.606 | 96 | 5.604 |
| 97 | 5.539 | 98 | 5.325 | 99 | 5.468 | 100 | 5.484 |

Hopping Frequency Sequence Name: HOP_FREQ_SEQ_30

| SEQ# | Frequency (GHz) | SEQ# | Frequency (GHz) | SEQ# | Frequency (GHz) | SEQ# | Frequency (GHz) |
|------|-----------------|------|-----------------|------|-----------------|------|-----------------|
| 1 | 5.631 | 2 | 5.628 | 3 | 5.645 | 4 | 5.347 |
| 5 | 5.591 | 6 | 5.427 | 7 | 5.333 | 8 | 5.692 |
| 9 | 5.441 | 10 | 5.504 | 11 | 5.600 | 12 | 5.551 |
| 13 | 5.271 | 14 | 5.647 | 15 | 5.646 | 16 | 5.406 |
| 17 | 5.613 | 18 | 5.291 | 19 | 5.362 | 20 | 5.394 |
| 21 | 5.470 | 22 | 5.458 | 23 | 5.546 | 24 | 5.563 |
| 25 | 5.318 | 26 | 5.397 | 27 | 5.260 | 28 | 5.636 |
| 29 | 5.576 | 30 | 5.430 | 31 | 5.391 | 32 | 5.460 |
| 33 | 5.361 | 34 | 5.708 | 35 | 5.698 | 36 | 5.544 |
| 37 | 5.258 | 38 | 5.474 | 39 | 5.703 | 40 | 5.416 |
| 41 | 5.657 | 42 | 5.328 | 43 | 5.277 | 44 | 5.617 |
| 45 | 5.449 | 46 | 5.489 | 47 | 5.575 | 48 | 5.268 |
| 49 | 5.294 | 50 | 5.723 | 51 | 5.644 | 52 | 5.590 |
| 53 | 5.256 | 54 | 5.721 | 55 | 5.261 | 56 | 5.259 |
| 57 | 5.514 | 58 | 5.476 | 59 | 5.345 | 60 | 5.459 |
| 61 | 5.462 | 62 | 5.266 | 63 | 5.407 | 64 | 5.488 |
| 65 | 5.286 | 66 | 5.371 | 67 | 5.571 | 68 | 5.556 |
| 69 | 5.588 | 70 | 5.654 | 71 | 5.678 | 72 | 5.354 |
| 73 | 5.472 | 74 | 5.526 | 75 | 5.487 | 76 | 5.468 |
| 77 | 5.508 | 78 | 5.388 | 79 | 5.446 | 80 | 5.520 |
| 81 | 5.418 | 82 | 5.390 | 83 | 5.550 | 84 | 5.482 |
| 85 | 5.337 | 86 | 5.404 | 87 | 5.664 | 88 | 5.465 |
| 89 | 5.598 | 90 | 5.257 | 91 | 5.392 | 92 | 5.516 |
| 93 | 5.448 | 94 | 5.327 | 95 | 5.614 | 96 | 5.594 |
| 97 | 5.633 | 98 | 5.637 | 99 | 5.715 | 100 | 5.329 |

--- END ---