

FCC Test Report (ENDC: n25 + LTE B66)

Report No.: RFBCKT-WTW-P21031102-10

FCC ID: HFSQTAD53

Test Model: QTAD53

Received Date: Mar. 31, 2021

Test Date: Apr. 28 ~ May 25, 2021

Issued Date: May 25, 2021

Applicant: QUANTA COMPUTER INC

Address: No. 211, Wenhua 2nd Rd., Guishan Dist., Taoyuan City 33377, Taiwan

Issued By: Bureau Veritas Consumer Products Services (H.K.) Ltd., Taoyuan Branch
Lin Kou Laboratories

Lab Address: No. 47-2, 14th Ling, Chia Pau Vil., Lin Kou Dist., New Taipei City, Taiwan

Test Location: No. 19, Hwa Ya 2nd Rd., Wen Hwa Vil., Kwei Shan Dist., Taoyuan City
33383, TAIWAN

**FCC Registration /
Designation Number:** 788550 / TW0003



This report is for your exclusive use. Any copying or replication of this report to or for any other person or entity, or use of our name or trademark, is permitted only with our prior written permission. This report sets forth our findings solely with respect to the test samples identified herein. The results set forth in this report are not indicative or representative of the quality or characteristics of the lot from which a test sample was taken or any similar or identical product specifically and expressly noted. Our report includes all of the tests requested by you and the results thereof based upon the information that you provided to us. You have 60 days from date of issuance of this report to notify us of any material error or omission caused by our negligence, provided, however, that such notice shall be in writing and shall specifically address the issue you wish to raise. A failure to raise such issue within the prescribed time shall constitute your unqualified acceptance of the completeness of this report, the tests conducted and the correctness of the report contents. Unless specific mention, the uncertainty of measurement has been explicitly taken into account to declare the compliance or non-compliance to the specification.

Table of Contents

Release Control Record	4
1 Certificate of Conformity	5
2 Summary of Test Results	6
2.1 Measurement Uncertainty.....	7
2.2 Test Site and Instruments.....	8
3 General Information	9
3.1 General Description of EUT.....	9
3.2 Configuration of System under Test.....	12
3.2.1 Description of Support Units.....	12
3.3 Test Mode Applicability and Tested Channel Detail.....	13
3.4 EUT Operating Conditions.....	18
3.5 General Description of Applied Standards and References.....	18
4 Test Types and Results	19
4.1 Output Power Measurement.....	19
4.1.1 Limits of Output Power Measurement.....	19
4.1.2 Test Procedures.....	19
4.1.3 Test Setup.....	19
4.1.4 Test Results.....	20
4.2 Modulation Characteristics Measurement.....	36
4.2.1 Limits of Modulation Characteristics.....	36
4.2.2 Test Procedure.....	36
4.2.3 Test Setup.....	36
4.2.4 Test Results.....	37
4.3 Frequency Stability Measurement.....	38
4.3.1 Limits of Frequency Stability Measurement.....	38
4.3.2 Test Procedure.....	38
4.3.3 Conducted Setup.....	38
4.3.4 Test Results.....	39
4.4 Occupied Bandwidth Measurement.....	43
4.4.1 Test Procedure.....	43
4.4.2 Test Setup.....	43
4.4.3 Test Result.....	44
4.5 Band Edge Measurement.....	48
4.5.1 Limits of Band Edge Measurement.....	48
4.5.2 Test Setup.....	48
4.5.3 Test Procedures.....	48
4.5.4 Test Results.....	49
4.6 Peak to Average Ratio.....	53
4.6.1 Limits of Peak to Average Ratio Measurement.....	53
4.6.2 Test Setup.....	53
4.6.3 Test Procedures.....	53
4.6.4 Test Results.....	54
4.7 Conducted Spurious Emissions.....	56
4.7.1 Limits of Conducted Spurious Emissions Measurement.....	56
4.7.2 Test Setup.....	56
4.7.3 Test Procedure.....	56
4.7.4 Test Results.....	57
4.8 Radiated Emission Measurement.....	61
4.8.1 Limits of Radiated Emission Measurement.....	61
4.8.2 Test Procedure.....	61
4.8.3 Deviation from Test Standard.....	61
4.8.4 Test Setup.....	62
4.8.5 Test Results.....	63

5	Pictures of Test Arrangements.....	77
	Appendix – Information of the Testing Laboratories	78

Release Control Record

Issue No.	Description	Date Issued
RFBCKT-WTW-P21031102-10	Original release	May 25, 2021

1 Certificate of Conformity

Product: 5G Hotspot

Brand: T-Mobile

Test Model: QTAD53

Sample Status: Engineering sample

Applicant: QUANTA COMPUTER INC

Test Date: Apr. 28 ~ May 25, 2021

Standards: FCC Part 24, Subpart E
FCC Part 27, Subpart C, L

The above equipment has been tested by **Bureau Veritas Consumer Products Services (H.K.) Ltd., Taoyuan Branch**, and found compliance with the requirement of the above standards. The test record, data evaluation & Equipment Under Test (EUT) configurations represented herein are true and accurate accounts of the measurements of the sample's RF characteristics under the conditions specified in this report.

Prepared by : Celine Chou , **Date:** May 25, 2021
Celine Chou / Senior Specialist

Approved by : Bruce Chen , **Date:** May 25, 2021
Bruce Chen / Senior Project Engineer

2 Summary of Test Results

For n25

Applied Standard: FCC Part 24 & Part 2			
FCC Clause	Test Item	Result	Remarks
2.1046 24.232	Effective Isotropically Radiated Power	Pass	Meet the requirement of limit.
2.1046 24.232 (d)	Peak To Average Ratio	Pass	Meet the requirement of limit.
2.1047	Modulation Characteristics	Pass	Meet the requirement
2.1055 24.235	Frequency Stability	Pass	Meet the requirement of limit.
2.1049	Occupied Bandwidth	Pass	Meet the requirement of limit.
24.238	Band Edge Measurements	Pass	Meet the requirement of limit.
2.1051 24.238	Conducted Spurious Emissions	Pass	Meet the requirement of limit.
2.1053 24.238	Radiated Spurious Emissions	Pass	Meet the requirement of limit. Minimum passing margin is -33.34dB at 37.03MHz.

Note: Determining compliance based on the results of the compliance measurement, not taking into account measurement instrumentation uncertainty.

For LTE Band 66

Applied Standard: FCC Part 27 & Part 2			
FCC Clause	Test Item	Result	Remarks
2.1046 27.50 (d)(4)	Equivalent Isotropically Radiated Power	Pass	Meet the requirement of limit.
2.1047	Modulation Characteristics	Pass	Refer to Note 1
27.50 (d)(5)	Peak To Average Ratio	Pass	Refer to Note 1
2.1055 27.54	Frequency Stability Stay with the authorized bands of operation	Pass	Refer to Note 1
2.1049	Occupied Bandwidth	Pass	Refer to Note 1
2.1051 27.53 (h)	Band Edge / Out of Band Emissions Measurements	Pass	Refer to Note 1
2.1051 27.53 (h)	Conducted Spurious Emissions	Pass	Refer to Note 1
2.1053 27.53 (h)	Radiated Spurious Emissions	Pass	Meet the requirement of limit. Minimum passing margin is -31.67dB at 35.62MHz.

Note:

1. This report is a partial report. Therefore, only test item of Transmitter Output Power and Equivalent Isotropically Radiated Power and Radiated Spurious Emissions tests were performed for this report. Other testing data please refer to BV CPS report no.: RFBCKT-WTW-P21031102-5.
2. Determining compliance based on the results of the compliance measurement, not taking into account measurement instrumentation uncertainty.

2.1 Measurement Uncertainty

Where relevant, the following measurement uncertainty levels have been estimated for tests performed on the EUT as specified in CISPR 16-4-2:

Measurement	Frequency	Expanded Uncertainty (k=2) (±)
Radiated Emissions up to 1 GHz	9kHz ~ 30MHz	3.04 dB
	30MHz ~ 200MHz	3.86 dB
	200MHz ~ 1000MHz	3.87 dB
Radiated Emissions above 1 GHz	1GHz ~ 18GHz	2.29 dB
	18GHz ~ 40GHz	2.29 dB

2.2 Test Site and Instruments

Description & Manufacturer	Model No.	Serial No.	Cal. Date	Cal. Due
Test Receiver ROHDE & SCHWARZ	ESR3	102579	Jul. 07, 2020	Jul. 06, 2021
Spectrum Analyzer ROHDE & SCHWARZ	FSP40	100269	Jun. 09, 2020	Jun. 08, 2021
MXG Vector signal generator Agilent	N5182B	MY53050430	Nov. 25, 2020	Nov. 24, 2021
5G Wireless Test Platforms Keysight	E7515B	MY60102114	May 28, 2020	May 27, 2021
BILOG Antenna SCHWARZBECK	VULB9168	9168-171	Nov. 04, 2020	Nov. 03, 2021
HORN Antenna SCHWARZBECK	9120D	209	Nov. 22, 2020	Nov. 21, 2021
HORN Antenna SCHWARZBECK	BBHA 9170	BBHA9170241	Nov. 22, 2020	Nov. 21, 2021
Loop Antenna TESEQ	HLA 6121	45745	Jul. 06, 2020	Jul. 05, 2021
Preamplifier Agilent (Below 1GHz)	8447D	2944A10738	Aug. 16, 2020	Aug. 15, 2021
Preamplifier Agilent (Above 1GHz)	8449B	3008A02465	Mar. 22, 2021	Mar. 21, 2022
RF Coaxial Cable WOKEN With 5dB PAD	8D-FB	Cable-CH3-01	Aug. 16, 2020	Aug. 15, 2021
RF signal cable HUBER+SUHNER	SUCOFLEX 104	Cable-CH3-03 (223653/4)	Aug. 16, 2020	Aug. 15, 2021
RF signal cable HUBER+SUHNER& EMCI	SUCOFLEX 104&EMC104-SM-S M-8000	Cable-CH3-03 (309224+170907)	Aug. 16, 2020	Aug. 15, 2021
Software BV ADT	ADT_Radiated_ V7.6.15.9.5	NA	NA	NA
Antenna Tower inn-co GmbH	MA 4000	013303	NA	NA
Antenna Tower Controller BV ADT	AT100	AT93021702	NA	NA
Turn Table BV ADT	TT100	TT93021702	NA	NA
Turn Table Controller BV ADT	SC100	SC93021702	NA	NA
Boresight Antenna Fixture	FBA-01	FBA-SIP01	NA	NA
Standard Temperature And Humidity Chamber GIANT FORCE	GTH-120-40-CP-AR	MAA1306-019	Sep. 10, 2020	Sep. 09, 2021
JFW 20dB attenuation	50HF-020-SMA	NA	NA	NA
True RMS Clamp Meter Fluke	325	31130711WS	Jun 06, 2020	Jun 05, 2021
DC power supply Keysight	U8002A	MY56330015	NA	NA

Note: 1. The calibration interval of the above test instruments is 12 months and the calibrations are traceable to NML/ROC and NIST/USA.
2. The test was performed in HwaYa Chamber 3.

3 General Information

3.1 General Description of EUT

Product	5G Hotspot
Brand	T-Mobile
Test Model	QTAD53
Sample Status	Engineering sample
Power Supply Rating	5Vdc / 9Vdc / 12Vdc (Adapter) 3.85Vdc (Battery)

n25

Modulation Type	$\pi/2$ BPSK, QPSK, 16QAM, 64QAM, 256QAM					
Waveform Type	CP-OFDM, DFT-s-OFDM					
Operating Frequency	n25 (Channel Bandwidth 5MHz)	1852.5MHz ~ 1912.5MHz				
	n25 (Channel Bandwidth 10MHz)	1855.0MHz ~ 1910.0MHz				
	n25 (Channel Bandwidth 15MHz)	1857.5MHz ~ 1907.5MHz				
	n25 (Channel Bandwidth 20MHz)	1860.0MHz ~ 1905.0MHz				
Max. EIRP Power		$\pi/2$ BPSK	QPSK	16QAM	64QAM	256QAM
	n25 (Channel Bandwidth 5MHz)	281.838mW (24.50dBm)	282.488mW (24.51dBm)	260.615mW (24.16dBm)	204.644mW (23.11dBm)	119.399mW (20.77dBm)
	n25 (Channel Bandwidth 10MHz)	280.543mW (24.48dBm)	289.734mW (24.62dBm)	257.632mW (24.11dBm)	206.063mW (23.14dBm)	118.850mW (20.75dBm)
	n25 (Channel Bandwidth 15MHz)	279.254mW (24.46dBm)	285.102mW (24.55dBm)	260.615mW (24.16dBm)	203.236mW (23.08dBm)	117.220mW (20.69dBm)
	n25 (Channel Bandwidth 20MHz)	286.418mW (24.57dBm)	289.068mW (24.61dBm)	263.027mW (24.20dBm)	205.116mW (23.12dBm)	120.226mW (20.80dBm)
Emission Designator		$\pi/2$ BPSK	QPSK	16QAM	64QAM	256QAM
	n25 (Channel Bandwidth 5MHz)	4M47G7D	4M47G7D	4M46D7W	4M46D7W	4M47D7W
	n25 (Channel Bandwidth 10MHz)	8M91G7D	9M28G7D	9M28D7W	9M28D7W	9M27D7W
	n25 (Channel Bandwidth 15MHz)	13M4G7D	14M1G7D	14M1D7W	14M1D7W	14M1D7W
	n25 (Channel Bandwidth 20MHz)	17M8G7D	18M9G7D	18M9D7W	18M9D7W	18M9D7W

LTE Band

Modulation Type	QPSK, 16QAM, 64QAM, 256QAM				
Operating Frequency	LTE Band 66 (Channel Bandwidth 1.4MHz)	1710.7MHz ~ 1779.3MHz			
	LTE Band 66 (Channel Bandwidth 3MHz)	1711.5MHz ~ 1778.5MHz			
	LTE Band 66 (Channel Bandwidth 5MHz)	1712.5MHz ~ 1777.5MHz			
	LTE Band 66 (Channel Bandwidth 10MHz)	1715.0MHz ~ 1775.0MHz			
	LTE Band 66 (Channel Bandwidth 15MHz)	1717.5MHz ~ 1772.5MHz			
	LTE Band 66 (Channel Bandwidth 20MHz)	1720.0MHz ~ 1770.0MHz			
Max. EIRP Power		QPSK	16QAM	64QAM	256QAM
	LTE Band 66 (Channel Bandwidth 1.4MHz)	388.150mW (25.89dBm)	363.915mW (25.61dBm)	265.461mW (24.24dBm)	145.546mW (21.63dBm)
	LTE Band 66 (Channel Bandwidth 3MHz)	384.592mW (25.85dBm)	365.595mW (25.63dBm)	264.241mW (24.22dBm)	147.231mW (21.68dBm)
	LTE Band 66 (Channel Bandwidth 5MHz)	388.150mW (25.89dBm)	341.979mW (25.34dBm)	267.301mW (24.27dBm)	140.281mW (21.47dBm)
	LTE Band 66 (Channel Bandwidth 10MHz)	382.825mW (25.83dBm)	356.451mW (25.52dBm)	276.058mW (24.41dBm)	143.880mW (21.58dBm)
	LTE Band 66 (Channel Bandwidth 15MHz)	380.189mW (25.80dBm)	334.965mW (25.25dBm)	266.686mW (24.26dBm)	143.549mW (21.57dBm)
	LTE Band 66 (Channel Bandwidth 20MHz)	389.045mW (25.90dBm)	362.243mW (25.59dBm)	263.633mW (24.21dBm)	150.661mW (21.78dBm)
Antenna Type	Refer to Note as below				
Antenna Connector	Refer to Note as below				
Accessory Device	Refer to Note as below				
Cable Supplied	Refer to Note as below				

Note:

- The EUT contains following accessory devices.

Product	Brand	Model	Description
Adapter 1	TEN PAO INTERNATIONAL LTD.	S018BYU1200150	I/P: 100-240Vac, 50/60Hz, 600mA O/P: 5Vdc/9Vdc/12Vdc=3A/2A/1.5A
Adapter 2	Aohai Technology Co., Ltd	A138A-120150U-US2	I/P: 100-240V~50/60Hz, 0.5A O/P: 5Vdc, 2.5A/9Vdc, 2A/12Vdc, 1.5A
USB Cable	Electronics Taiwai Ltd.	DDEMU110079	0.95m shielded USB cable without core
Battery	VEKEN	141033	3.85Vdc, 6240mAh, 24.02Wh

- There are two sources for EUT's main board and memory. Only the supplier is different and the rest of the specifications are the same.

Sample	Item	Brand	Model
A	PCB - Main	Unimicron Technology Corporation.	12VPL4024C for MODEM board, 06VPL4028C for Main board
	Memory - Main	Nanya Technology Corporation	NM4888KSPAXAI-3E
B	PCB -Second	AKM Meadville	HI12C124A for MODEM board, HI06T221A for Main board
	Memory - Second	Jeju Semiconductor Corp.	JSFDDQ5QHAFGD-405

* After pre-tested, sample A was the worse and chosen for final test.

3. The following antennas were provided to the EUT.

LTE Band														
Ant. No.	Type	Connector	Gain (dBi)											
			B2	B4	B5	B7	B12	B13	B25	B26	B38	B41	B66	B71
0	PIFA	MUR	1.23871	3.16163	0.345671	1.15435	0.154297	-3.23099	1.23871	0.702007	0.371642	1.15435	3.16163	0.426023
1	PIFA	IPEX	-	-	-	-	-	-	-	-	-	-	-	-
2	PIFA	IPEX	0.861738	0.805343	-	-	-	-	-	-	-	-	0.805343	-
3	PIFA	MUR	-	-	-	-	-	-	-	-	-	-	-	-
4	PIFA	IPEX	-	-	-	-	-	-	-	-	-	-	-	-

5G FR1 Band							
Ant. No.	Type	Connector	Gain (dBi)				
			n25	n41	n66	n71	
0	PIFA	MUR	1.23871	-	3.16163	0.426023	
1	PIFA	IPEX	-	-	-	-	
2	PIFA	IPEX	-	0.854078	-	-	
3	PIFA	MUR	-	-	-	-	
4	PIFA	IPEX	-	-0.283214	-	-	

* The above Antenna information is declared by manufacturer and for more detailed features description, please refer to the manufacturer's specifications, the laboratory shall not be held responsible.

4. The EUT supports the following ENDC configuration.

5G NR	FCC 5G FR1			ENDC
	Band	SCS	Bandwidth (MHz)	
	n25	15kHz	5/10/15/20	Band 66
	n41	30kHz	10/15/20/40/50/60/80/90/100	Band 2/66
	n66	15kHz	5/10/15/20/30/40	Band 2
n71	15kHz	5/10/15/20	Band 2/66	

3.2 Configuration of System under Test

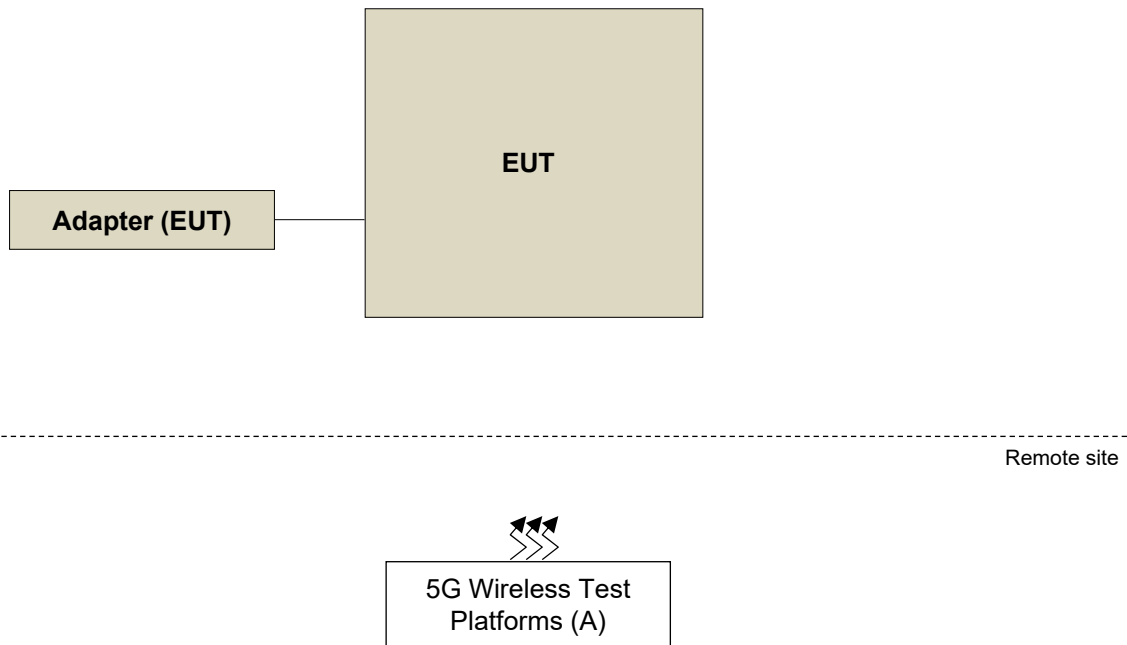

3.2.1 Description of Support Units

The EUT has been tested as an independent unit together with other necessary accessories or support units. The following support units or accessories were used to form a representative test configuration during the tests.

ID	Product	Brand	Model No.	Serial No.	FCC ID	Remarks
A.	5G Wireless Test Platforms	Keysight	E7515B	MY58300759	NA	-

Note:

1. All power cords of the above support units are non-shielded (1.8m).
2. Item A acted as a communication partner to transfer data.

3.3 Test Mode Applicability and Tested Channel Detail

Pre-Scan has been conducted to determine the worst-case mode from all possible combinations between available modulations, data rates, XYZ axis and antenna ports. The worst case was found when positioned as the table below. Following channel(s) was (were) selected for the final test as listed below:

Band	Radiated Emission
n25	X-plane
LTE Band 66	X-plane

n25

EUT Configure Mode	Test item	Available channel	Tested channel	Channel Bandwidth	Modulation	Mode
-	EIRP	370500 to 382500	370500 (1852.5MHz), 376500 (1882.5MHz), 382500 (1912.5MHz)	5MHz	$\pi/2$ BPSK / QPSK / 16QAM / 64QAM / 256QAM	1 RB / 1 RB Offset 1 RB / 13 RB Offset 1 RB / 23 RB Offset 12 RB / 0 RB Offset 12 RB / 7 RB Offset 12 RB / 13 RB Offset 25 RB / 0 RB Offset
		371000 to 382000	371000 (1855.0MHz), 376500 (1882.5MHz), 382000 (1910.0MHz)	10MHz	$\pi/2$ BPSK / QPSK / 16QAM / 64QAM / 256QAM	1 RB / 1 RB Offset 1 RB / 26 RB Offset 1 RB / 50 RB Offset 25 RB / 0 RB Offset 25 RB / 14 RB Offset 25 RB / 27 RB Offset 50 RB / 0 RB Offset
		371500 to 381500	371500 (1857.5MHz), 376500 (1882.5MHz), 381500 (1907.5MHz)	15MHz	$\pi/2$ BPSK / QPSK / 16QAM / 64QAM / 256QAM	1 RB / 1 RB Offset 1 RB / 40 RB Offset 1 RB / 77 RB Offset 36 RB / 0 RB Offset 36 RB / 22 RB Offset 36 RB / 43 RB Offset 75 RB / 0 RB Offset
		372000 to 381000	372000 (1860.0MHz), 376500 (1882.5MHz), 381000 (1905.0MHz)	20MHz	$\pi/2$ BPSK / QPSK / 16QAM / 64QAM / 256QAM	1 RB / 1 RB Offset 1 RB / 53 RB Offset 1 RB / 104 RB Offset 50RB / 0 RB Offset 50 RB / 28 RB Offset 50 RB / 56 RB Offset 100 RB / 0 RB Offset
-	Modulation characteristics	372000 to 381000	376500 (1882.5MHz)	20MHz	$\pi/2$ BPSK / QPSK / 16QAM / 64QAM / 256QAM	100 RB / 0 RB Offset
-	Frequency Stability	370500 to 382500	370500 (1852.5MHz), 382500 (1912.5MHz)	5MHz	QPSK	25 RB / 0 RB Offset
		371000 to 382000	371000 (1855.0MHz), 382000 (1910.0MHz)	10MHz	QPSK	52 RB / 0 RB Offset
		371500 to 381500	371500 (1857.5MHz), 381500 (1907.5MHz)	15MHz	QPSK	79 RB / 0 RB Offset
		372000 to 381000	372000 (1860.0MHz), 381000 (1905.0MHz)	20MHz	QPSK	106 RB / 0 RB Offset

EUT Configure Mode	Test item	Available channel	Tested channel	Channel Bandwidth	Modulation	Mode
-	Occupied Bandwidth	370500 to 382500	370500 (1852.5MHz), 376500 (1882.5MHz), 382500 (1912.5MHz)	5MHz	$\pi/2$ BPSK / QPSK / 16QAM / 64QAM / 256QAM	25 RB / 0 RB Offset
		371000 to 382000	371000 (1855.0MHz), 376500 (1882.5MHz), 382000 (1910.0MHz)	10MHz	$\pi/2$ BPSK / QPSK / 16QAM / 64QAM / 256QAM	52 RB / 0 RB Offset
		371500 to 381500	371500 (1857.5MHz), 376500 (1882.5MHz), 381500 (1907.5MHz)	15MHz	$\pi/2$ BPSK / QPSK / 16QAM / 64QAM / 256QAM	79 RB / 0 RB Offset
		372000 to 381000	372000 (1860.0MHz), 376500 (1882.5MHz), 381000 (1905.0MHz)	20MHz	$\pi/2$ BPSK / QPSK / 16QAM / 64QAM / 256QAM	106 RB / 0 RB Offset
-	Band Edge	370500 to 382500	370500 (1852.5MHz), 382500 (1912.5MHz)	5MHz	QPSK	1 RB / 0 RB Offset 1 RB / 24 RB Offset 25 RB / 0 RB Offset
		371000 to 382000	371000 (1855.0MHz), 382000 (1910.0MHz)	10MHz	QPSK	1 RB / 0 RB Offset 1 RB / 51 RB Offset 52 RB / 0 RB Offset
		371500 to 381500	371500 (1857.5MHz), 381500 (1907.5MHz)	15MHz	QPSK	1 RB / 0 RB Offset 1 RB / 78 RB Offset 79 RB / 0 RB Offset
		372000 to 381000	372000 (1860.0MHz), 381000 (1905.0MHz)	20MHz	QPSK	1 RB / 0 RB Offset 1 RB / 105 RB Offset 106 RB / 0 RB Offset
-	Peak to Average Ratio	370500 to 382500	370500 (1852.5MHz), 376500 (1882.5MHz), 382500 (1912.5MHz)	5MHz	$\pi/2$ BPSK / QPSK / 16QAM / 64QAM / 256QAM	1 RB / 1 RB Offset
		371000 to 382000	371000 (1855.0MHz), 376500 (1882.5MHz), 382000 (1910.0MHz)	10MHz	$\pi/2$ BPSK / QPSK / 16QAM / 64QAM / 256QAM	1 RB / 1 RB Offset
		371500 to 381500	371500 (1857.5MHz), 376500 (1882.5MHz), 381500 (1907.5MHz)	15MHz	$\pi/2$ BPSK / QPSK / 16QAM / 64QAM / 256QAM	1 RB / 1 RB Offset
		372000 to 381000	372000 (1860.0MHz), 376500 (1882.5MHz), 381000 (1905.0MHz)	20MHz	$\pi/2$ BPSK / QPSK / 16QAM / 64QAM / 256QAM	1 RB / 1 RB Offset

EUT Configure Mode	Test item	Available channel	Tested channel	Channel Bandwidth	Modulation	Mode
-	Conducted Emission	370500 to 382500	370500 (1852.5MHz), 376500 (1882.5MHz), 382500 (1912.5MHz)	5MHz	QPSK	1 RB / 1 RB Offset
		371000 to 382000	371000 (1855.0MHz), 376500 (1882.5MHz), 382000 (1910.0MHz)	10MHz	QPSK	1 RB / 1 RB Offset
		371500 to 381500	371500 (1857.5MHz), 376500 (1882.5MHz), 381500 (1907.5MHz)	15MHz	QPSK	1 RB / 1 RB Offset
		372000 to 381000	372000 (1860.0MHz), 376500 (1882.5MHz), 381000 (1905.0MHz)	20MHz	QPSK	1 RB / 1 RB Offset
-	Radiated Emission Below 1GHz	370500 to 382500	382500 (1912.5MHz)	5MHz	QPSK	1 RB / 1 RB Offset
-	Radiated Emission Above 1GHz	370500 to 382500	370500 (1852.5MHz), 376500 (1882.5MHz), 382500 (1912.5MHz)	5MHz	QPSK	1 RB / 1 RB Offset
		372000 to 381000	372000 (1860.0MHz), 376500 (1882.5MHz), 381000 (1905.0MHz)	20MHz	QPSK	1 RB / 1 RB Offset

Note:

1. For radiated emission below 1GHz, select the worst radiated emission channel (above 1GHz) for final testing.
2. For radiated emission above 1GHz, according to 3GPP 38.521-1 Section 6.5.3.1.4, choose the lowest and highest channel bandwidth for final test.
3. Only output power, modulation characteristics, occupied bandwidth and Peak to average ratio items had been tested under $\pi/2$ BPSK, QPSK, 16QAM, 64QAM and 256QAM modes, the other test items were performed under worse mode according to the maximum output power.

LTE Band 66

EUT Configure Mode	Test Item	Available Channel	Tested Channel	Channel Bandwidth	Modulation	Mode
-	EIRP	131979 to 132665	131979 (1710.7MHz), 132322 (1745.0MHz), 132665 (1779.3MHz)	1.4MHz	QPSK / 16QAM / 64QAM / 256QAM	1 RB / 0 RB Offset 1 RB / 2 RB Offset 1 RB / 5 RB Offset 3 RB / 0 RB Offset 3 RB / 1 RB Offset 3 RB / 3 RB Offset 6 RB / 0 RB Offset
		131987 to 132657	131987 (1711.5MHz), 132322 (1745.0MHz), 132657 (1778.5MHz)	3MHz	QPSK / 16QAM / 64QAM / 256QAM	1 RB / 0 RB Offset 1 RB / 7 RB Offset 1 RB / 14 RB Offset 8 RB / 0 RB Offset 8 RB / 3 RB Offset 8 RB / 7 RB Offset 15 RB / 0 RB Offset
		131997 to 132647	131997 (1712.5MHz), 132322 (1745.0MHz), 132647 (1777.5MHz)	5MHz	QPSK / 16QAM / 64QAM / 256QAM	1 RB / 0 RB Offset 1 RB / 12 RB Offset 1 RB / 24 RB Offset 12 RB / 0 RB Offset 12 RB / 6 RB Offset 12 RB / 13 RB Offset 25 RB / 0 RB Offset
		132022 to 132622	132022 (1715.0MHz), 132322 (1745.0MHz), 132622 (1775.0MHz)	10MHz	QPSK / 16QAM / 64QAM / 256QAM	1 RB / 0 RB Offset 1 RB / 24 RB Offset 1 RB / 49 RB Offset 25 RB / 0 RB Offset 25 RB / 12 RB Offset 25 RB / 25 RB Offset 50 RB / 0 RB Offset
		132047 to 132597	132047 (1717.5MHz), 132322 (1745.0MHz), 132597 (1772.5MHz)	15MHz	QPSK / 16QAM / 64QAM / 256QAM	1 RB / 0 RB Offset 1 RB / 37 RB Offset 1 RB / 74 RB Offset 36 RB / 0 RB Offset 36 RB / 19 RB Offset 36 RB / 39 RB Offset 75 RB / 0 RB Offset
		132072 to 132572	132072 (1720.0MHz), 132322 (1745.0MHz), 132572 (1770.0MHz)	20MHz	QPSK / 16QAM / 64QAM / 256QAM	1 RB / 0 RB Offset 1 RB / 50 RB Offset 1 RB / 99 RB Offset 50 RB / 0 RB Offset 50 RB / 25 RB Offset 50 RB / 50 RB Offset 100 RB / 0 RB Offset

EUT Configure Mode	Test Item	Available Channel	Tested Channel	Channel Bandwidth	Modulation	Mode
-	Radiated Emission Below 1GHz	131997 to 132647	131997 (1712.5MHz)	5MHz	QPSK	1 RB / 0 RB Offset
-	Radiated Emission Above 1GHz	131979 to 132665	131979 (1710.7MHz), 132322 (1745.0MHz), 132665 (1779.3MHz)	1.4MHz	QPSK	1 RB / 0 RB Offset
		131997 to 132647	131997 (1712.5MHz), 132322 (1745.0MHz), 132647 (1777.5MHz)	5MHz	QPSK	1 RB / 0 RB Offset
		132072 to 132572	132072 (1720.0MHz), 132322 (1745.0MHz), 132572 (1770.0MHz)	20MHz	QPSK	1 RB / 0 RB Offset

Note:

1. For radiated emission below 1GHz, select the worst radiated emission channel (above 1GHz) for final testing.
2. For radiated emission above 1GHz, according to 3GPP 36.521 Section 6.6.3.1.4, choose the lowest, 5MHz & highest channel bandwidth for final test.
3. The output power for QPSK, 16QAM, 64QAM and 256QAM, measured value of QPSK is higher than 16QAM, 64QAM and 256QAM mode. Therefore the radiated emission test items was performed under QPSK mode only.

Test Condition:

Test Item	Environmental Conditions	Input Power	Tested By
EIRP / ERP	25deg. C, 60%RH	120Vac, 60Hz	James Yang
Modulation Characteristics	25deg. C, 60%RH	120Vac, 60Hz	James Yang
Frequency Stability	25deg. C, 60%RH	3.85Vdc	James Yang
Occupied Bandwidth	25deg. C, 60%RH	120Vac, 60Hz	James Yang
Band Edge	25deg. C, 60%RH	120Vac, 60Hz	James Yang
Peak To Average Ratio	25deg. C, 60%RH	120Vac, 60Hz	James Yang
Conducted Emission	25deg. C, 60%RH	120Vac, 60Hz	James Yang
Radiated Emission	23deg. C, 67%RH 23deg. C, 66%RH	120Vac, 60Hz	Adair Peng Titan Hsu

3.4 EUT Operating Conditions

The EUT makes a call to the communication simulator. The communication simulator station system controlled a EUT to export maximum output power under transmission mode and specific channel frequency

3.5 General Description of Applied Standards and References

The EUT is a RF Product. According to the specifications of the manufacturer, it must comply with the requirements of the following standards:

Test Standard:

FCC 47 CFR Part 2

FCC 47 CFR Part 24

FCC 47 CFR Part 27

ANSI/TIA/EIA-603-D-2010

ANSI/TIA/EIA-603-E 2016

ANSI 63.26-2015

All test items have been performed and recorded as per the above standards.

References Test Guidance:

KDB 971168 D01 Power Meas License Digital Systems v03r01

KDB 971168 D02 Misc Rev Approv License Devices v02r01

All test items have been performed and recorded as per the above standards.

4 Test Types and Results

4.1 Output Power Measurement

4.1.1 Limits of Output Power Measurement

For n25:

Mobile / Portable station are limited to 2 watts e.i.r.p.

For LTE Band 66:

Mobile / Portable station are limited to 1 watts e.i.r.p.

4.1.2 Test Procedures

Conducted Power Measurement:

The EUT was set up for the maximum power with 5GNR and LTE link data modulation and link up with simulator. Set the EUT to transmit under low, middle and high channel and record the power level shown on simulator.

Maximum EIRP / ERP

The relevant equation for determining the maximum ERP or EIRP from the measured RF output power is given in Equation as follows:

$$\text{EIRP} = P_{\text{Meas}} + G_{\text{T}}$$

$$\text{ERP} = P_{\text{Meas}} + G_{\text{T}} - 2.15$$

where

ERP or EIRP effective radiated power or equivalent isotropically radiated power, respectively
(expressed in the same units as P_{Meas} , e.g., dBm or dBW)

P_{Meas} measured transmitter output power or PSD, in dBm or dBW

G_{T} gain of the transmitting antenna, in dBd (ERP) or dBi (EIRP)

4.1.3 Test Setup

Conducted Power Measurement:



4.1.4 Test Results

Conducted Output Power (dBm)

NR Band 25						
BW	MCS Index	RB Size	RB Offset	Low	Mid	High
		Channel		372000	376500	381000
		Frequency (MHz)		1860	1882.5	1905
20M	$\pi/2$ BPSK	1	1	23.01	23.19	23.34
20M	QPSK	1	1	23.10	23.30	23.38
		1	53	22.87	23.08	23.17
		1	104	22.86	23.05	23.11
		50	0	22.85	23.02	23.12
		50	28	22.91	23.10	23.18
		50	56	22.71	22.92	22.96
		100	0	22.90	23.12	23.16
20M	16QAM	1	1	22.69	22.89	22.97
20M	64QAM	1	1	21.63	21.83	21.89
20M	256QAM	1	1	19.30	19.48	19.57
BW	MCS Index	Channel		371500	376500	381500
		Frequency (MHz)		1857.5	1882.5	1907.5
		15M	$\pi/2$ BPSK	1	1	23.02
15M	QPSK	1	1	23.10	23.30	23.32
		1	40	22.86	23.01	23.15
		1	77	22.85	22.97	23.05
		36	0	22.82	23.07	23.09
		36	22	22.86	22.99	23.06
		36	43	22.64	22.90	22.91
		75	0	22.84	23.05	23.07
15M	16QAM	1	1	22.60	22.80	22.93
15M	64QAM	1	1	21.60	21.80	21.85
15M	256QAM	1	1	19.30	19.41	19.46
BW	MCS Index	Channel		371000	376500	382000
		Frequency (MHz)		1855	1882.5	1910
		10M	$\pi/2$ BPSK	1	1	23.08
10M	QPSK	1	1	23.05	23.23	23.39
		1	26	22.81	23.03	23.06
		1	50	22.78	22.97	23.03
		25	0	22.87	23.04	23.18
		25	14	22.77	22.97	23.01
		25	27	22.67	22.89	22.94
		50	0	22.87	23.03	23.11
10M	16QAM	1	1	22.62	22.83	22.88
10M	64QAM	1	1	21.51	21.77	21.91
10M	256QAM	1	1	19.20	19.52	19.51

NR Band 25						
BW	MCS Index	RB Size	RB Offset	Low	Mid	High
		Channel		370500	376500	382500
		Frequency (MHz)		1852.5	1882.5	1912.5
5M	$\pi/2$ BPSK	1	1	22.94	23.25	23.27
5M	QPSK	1	1	22.99	23.28	23.28
		1	13	22.85	22.99	23.11
		1	23	22.85	22.97	23.04
		12	0	22.86	23.09	23.20
		12	7	22.80	22.96	23.11
		12	13	22.62	22.79	22.94
		25	0	22.89	23.07	23.12
5M	16QAM	1	1	22.71	22.81	22.93
5M	64QAM	1	1	21.54	21.78	21.88
5M	256QAM	1	1	19.31	19.43	19.54

LTE Band 66						
BW	MCS Index	RB Size	RB Offset	Low	Mid	High
		Channel		132072	132322	132572
		Frequency (MHz)		1720	1745	1770
20M	QPSK	1	0	22.72	22.74	22.42
		1	50	22.51	22.72	22.46
		1	99	22.62	22.65	22.70
		50	0	21.92	22.10	22.00
		50	25	22.14	22.19	22.09
		50	50	21.92	22.04	22.39
		100	0	21.85	21.79	21.94
20M	16QAM	1	0	22.14	22.12	21.50
		1	50	21.86	22.17	22.32
		1	99	22.43	21.65	21.54
		50	0	21.03	21.11	20.70
		50	25	20.87	21.05	21.08
		50	50	20.60	20.78	20.50
		100	0	20.56	20.43	20.94
20M	64QAM	1	0	21.05	21.05	21.05
		1	50	20.72	20.65	20.84
		1	99	20.66	20.74	20.94
		50	0	20.15	19.96	20.16
		50	25	19.84	19.76	20.35
		50	50	20.23	20.09	19.45
		100	0	20.12	19.91	19.43
20M	256QAM	1	0	17.79	18.41	18.10
		1	50	18.62	18.52	17.86
		1	99	18.43	18.14	18.00
		50	0	18.53	18.03	18.27
		50	25	18.43	18.37	18.15
		50	50	18.02	18.43	17.81
		100	0	17.85	18.18	17.87

LTE Band 66						
BW	MCS Index	RB Size	RB Offset	Low	Mid	High
		Channel		132047	132322	132597
		Frequency (MHz)		1717.5	1745	1772.5
15M	QPSK	1	0	22.50	22.64	22.37
		1	37	22.48	22.46	22.60
		1	74	22.57	22.61	22.42
		36	0	22.46	21.83	21.57
		36	19	22.16	22.41	22.38
		36	39	21.92	21.72	22.05
		75	0	22.24	22.18	21.61
15M	16QAM	1	0	22.05	22.09	21.89
		1	37	21.65	21.70	21.75
		1	74	21.95	21.59	21.45
		36	0	20.92	21.35	20.60
		36	19	21.09	20.67	21.25
		36	39	20.52	20.90	20.47
		75	0	20.91	21.04	20.24
15M	64QAM	1	0	20.80	20.65	21.10
		1	37	20.69	20.58	20.82
		1	74	20.42	20.98	20.38
		36	0	19.92	20.28	20.26
		36	19	19.71	20.34	19.74
		36	39	20.13	19.59	20.03
		75	0	19.63	19.55	19.67
15M	256QAM	1	0	18.13	17.62	18.34
		1	37	18.21	18.28	17.64
		1	74	18.41	18.16	18.16
		36	0	18.41	17.84	17.69
		36	19	18.16	18.37	17.99
		36	39	17.90	17.74	17.80
		75	0	17.93	17.61	18.25

LTE Band 66						
BW	MCS Index	RB Size	RB Offset	Low	Mid	High
		Channel		132022	132322	132622
		Frequency (MHz)		1715	1745	1775
10M	QPSK	1	0	22.67	22.57	22.66
		1	24	22.62	22.55	22.61
		1	49	22.60	22.57	22.61
		25	0	22.32	22.36	21.71
		25	12	22.48	22.04	21.83
		25	25	22.10	22.27	21.87
		50	0	22.37	21.90	21.65
10M	16QAM	1	0	22.31	22.36	22.15
		1	24	22.07	22.35	22.03
		1	49	22.15	21.70	21.97
		25	0	20.72	20.71	21.01
		25	12	20.74	21.04	20.93
		25	25	20.66	21.00	20.31
		50	0	21.06	20.55	20.21
10M	64QAM	1	0	20.99	21.25	21.03
		1	24	21.02	20.76	20.38
		1	49	20.65	20.97	20.25
		25	0	20.49	19.70	19.85
		25	12	20.08	19.84	19.85
		25	25	20.40	19.81	19.99
		50	0	19.99	20.28	19.55
10M	256QAM	1	0	18.07	17.87	17.80
		1	24	17.93	17.94	18.33
		1	49	18.42	17.60	18.23
		25	0	17.89	18.12	17.72
		25	12	17.95	17.69	17.91
		25	25	18.36	17.92	17.59
		50	0	18.01	18.16	18.29

LTE Band 66						
BW	MCS Index	RB Size	RB Offset	Low	Mid	High
		Channel		131997	132322	132647
		Frequency (MHz)		1712.5	1745	1777.5
5M	QPSK	1	0	22.73	22.56	22.62
		1	12	22.69	22.57	22.67
		1	24	22.69	22.60	22.65
		12	0	21.79	22.22	21.98
		12	6	22.34	21.66	21.70
		12	13	22.29	22.08	21.70
		25	0	21.76	22.15	22.16
5M	16QAM	1	0	22.18	21.73	21.45
		1	12	21.72	21.94	21.51
		1	24	22.05	21.67	21.49
		12	0	20.87	20.73	21.10
		12	6	20.57	21.28	20.40
		12	13	20.52	20.98	20.45
		25	0	20.95	20.69	20.38
5M	64QAM	1	0	20.85	20.39	20.80
		1	12	21.11	20.80	20.63
		1	24	20.70	20.85	20.45
		12	0	20.30	19.92	20.31
		12	6	20.11	20.18	19.68
		12	13	20.11	20.30	19.95
		25	0	19.72	19.53	20.21
5M	256QAM	1	0	17.80	18.31	17.93
		1	12	18.20	17.93	17.93
		1	24	17.88	17.91	18.23
		12	0	17.83	18.12	18.21
		12	6	17.79	17.91	17.66
		12	13	17.98	17.78	17.63
		25	0	18.26	17.96	17.66

LTE Band 66						
BW	MCS Index	RB Size	RB Offset	Low	Mid	High
		Channel		131987	132322	132657
		Frequency (MHz)		1711.5	1745	1778.5
3M	QPSK	1	0	22.64	22.68	22.69
		1	7	22.48	22.69	22.56
		1	14	22.45	22.68	22.41
		8	0	21.70	22.25	21.52
		8	3	22.36	21.81	21.55
		8	7	22.25	21.85	22.21
		15	0	22.20	21.59	21.83
3M	16QAM	1	0	22.13	22.47	21.74
		1	7	22.01	22.10	22.25
		1	14	22.21	21.77	21.73
		8	0	20.61	20.90	20.38
		8	3	20.64	21.23	21.09
		8	7	20.59	21.00	20.96
		15	0	20.45	20.54	20.54
3M	64QAM	1	0	21.04	20.94	20.78
		1	7	20.68	21.06	20.25
		1	14	20.79	20.49	20.37
		8	0	20.50	19.77	19.67
		8	3	19.93	19.61	20.24
		8	7	19.73	19.56	20.23
		15	0	20.22	20.27	20.09
3M	256QAM	1	0	18.22	17.67	17.67
		1	7	18.22	18.17	18.36
		1	14	18.23	17.85	17.75
		8	0	18.13	18.28	18.11
		8	3	18.52	17.89	17.51
		8	7	17.73	18.15	18.11
		15	0	17.80	18.14	17.57

LTE Band 66						
BW	MCS Index	RB Size	RB Offset	Low	Mid	High
		Channel		131979	132322	132665
		Frequency (MHz)		1710.7	1745	1779.3
1.4M	QPSK	1	0	22.73	22.49	22.50
		1	2	22.70	22.56	22.55
		1	5	22.63	22.61	22.53
		3	0	21.71	22.24	22.45
		3	1	22.46	22.39	21.68
		3	3	22.05	22.43	21.42
		6	0	21.59	22.13	22.20
1.4M	16QAM	1	0	22.35	22.45	21.48
		1	2	22.38	22.20	21.78
		1	5	22.25	21.88	21.71
		3	0	20.82	21.27	20.75
		3	1	20.60	20.71	21.06
		3	3	20.60	20.47	20.73
		6	0	20.64	20.94	20.69
1.4M	64QAM	1	0	20.58	20.57	20.38
		1	2	20.58	20.60	20.74
		1	5	20.79	21.08	20.51
		3	0	20.56	19.80	19.48
		3	1	20.30	19.77	19.99
		3	3	20.17	19.59	20.19
		6	0	19.66	19.79	19.39
1.4M	256QAM	1	0	17.91	17.61	17.58
		1	2	18.44	18.14	18.22
		1	5	17.76	18.43	18.19
		3	0	17.90	17.97	18.13
		3	1	18.00	17.95	18.34
		3	3	18.22	18.18	18.28
		6	0	18.47	17.79	17.44

EIRP Power (dBm)

NR Band 25						
BW	MCS Index	RB Size	RB Offset	Low	Mid	High
		Channel		372000	376500	381000
		Frequency (MHz)		1860	1882.5	1905
20M	$\pi/2$ BPSK	1	1	24.24	24.42	24.57
20M	QPSK	1	1	24.33	24.53	24.61
		1	53	24.10	24.31	24.40
		1	104	24.09	24.28	24.34
		50	0	24.08	24.25	24.35
		50	28	24.14	24.33	24.41
		50	56	23.94	24.15	24.19
		100	0	24.13	24.35	24.39
20M	16QAM	1	1	23.92	24.12	24.20
20M	64QAM	1	1	22.86	23.06	23.12
20M	256QAM	1	1	20.53	20.71	20.80
BW	MCS Index	Channel		371500	376500	381500
		Frequency (MHz)		1857.5	1882.5	1907.5
15M	$\pi/2$ BPSK	1	1	24.25	24.40	24.46
15M	QPSK	1	1	24.33	24.53	24.55
		1	40	24.09	24.24	24.38
		1	77	24.08	24.20	24.28
		36	0	24.05	24.30	24.32
		36	22	24.09	24.22	24.29
		36	43	23.87	24.13	24.14
		75	0	24.07	24.28	24.30
15M	16QAM	1	1	23.83	24.03	24.16
15M	64QAM	1	1	22.83	23.03	23.08
15M	256QAM	1	1	20.53	20.64	20.69
BW	MCS Index	Channel		371000	376500	382000
		Frequency (MHz)		1855	1882.5	1910
10M	$\pi/2$ BPSK	1	1	24.31	24.45	24.48
10M	QPSK	1	1	24.28	24.46	24.62
		1	26	24.04	24.26	24.29
		1	50	24.01	24.20	24.26
		25	0	24.10	24.27	24.41
		25	14	24.00	24.20	24.24
		25	27	23.90	24.12	24.17
		50	0	24.10	24.26	24.34
10M	16QAM	1	1	23.85	24.06	24.11
10M	64QAM	1	1	22.74	23.00	23.14
10M	256QAM	1	1	20.43	20.75	20.74

NR Band 25						
BW	MCS Index	RB Size	RB Offset	Low	Mid	High
		Channel		370500	376500	382500
		Frequency (MHz)		1852.5	1882.5	1912.5
5M	$\pi/2$ BPSK	1	1	24.17	24.48	24.50
5M	QPSK	1	1	24.22	24.51	24.51
		1	13	24.08	24.22	24.34
		1	23	24.08	24.20	24.27
		12	0	24.09	24.32	24.43
		12	7	24.03	24.19	24.34
		12	13	23.85	24.02	24.17
		25	0	24.12	24.30	24.35
5M	16QAM	1	1	23.94	24.04	24.16
5M	64QAM	1	1	22.77	23.01	23.11
5M	256QAM	1	1	20.54	20.66	20.77

LTE Band 66						
BW	MCS Index	RB Size	RB Offset	Low	Mid	High
		Channel		132072	132322	132572
		Frequency (MHz)		1720	1745	1770
20M	QPSK	1	0	25.88	25.90	25.58
		1	50	25.67	25.88	25.62
		1	99	25.78	25.81	25.86
		50	0	25.08	25.26	25.16
		50	25	25.30	25.35	25.25
		50	50	25.08	25.20	25.55
		100	0	25.01	24.95	25.10
20M	16QAM	1	0	25.30	25.28	24.66
		1	50	25.02	25.33	25.48
		1	99	25.59	24.81	24.70
		50	0	24.19	24.27	23.86
		50	25	24.03	24.21	24.24
		50	50	23.76	23.94	23.66
		100	0	23.72	23.59	24.10
20M	64QAM	1	0	24.21	24.21	24.21
		1	50	23.88	23.81	24.00
		1	99	23.82	23.90	24.10
		50	0	23.31	23.12	23.32
		50	25	23.00	22.92	23.51
		50	50	23.39	23.25	22.61
		100	0	23.28	23.07	22.59
20M	256QAM	1	0	20.95	21.57	21.26
		1	50	21.78	21.68	21.02
		1	99	21.59	21.30	21.16
		50	0	21.69	21.19	21.43
		50	25	21.59	21.53	21.31
		50	50	21.18	21.59	20.97
		100	0	21.01	21.34	21.03

LTE Band 66						
BW	MCS Index	RB Size	RB Offset	Low	Mid	High
		Channel		132047	132322	132597
		Frequency (MHz)		1717.5	1745	1772.5
15M	QPSK	1	0	25.66	25.80	25.53
		1	37	25.64	25.62	25.76
		1	74	25.73	25.77	25.58
		36	0	25.62	24.99	24.73
		36	19	25.32	25.57	25.54
		36	39	25.08	24.88	25.21
		75	0	25.40	25.34	24.77
15M	16QAM	1	0	25.21	25.25	25.05
		1	37	24.81	24.86	24.91
		1	74	25.11	24.75	24.61
		36	0	24.08	24.51	23.76
		36	19	24.25	23.83	24.41
		36	39	23.68	24.06	23.63
		75	0	24.07	24.20	23.40
15M	64QAM	1	0	23.96	23.81	24.26
		1	37	23.85	23.74	23.98
		1	74	23.58	24.14	23.54
		36	0	23.08	23.44	23.42
		36	19	22.87	23.50	22.90
		36	39	23.29	22.75	23.19
		75	0	22.79	22.71	22.83
15M	256QAM	1	0	21.29	20.78	21.50
		1	37	21.37	21.44	20.80
		1	74	21.57	21.32	21.32
		36	0	21.57	21.00	20.85
		36	19	21.32	21.53	21.15
		36	39	21.06	20.90	20.96
		75	0	21.09	20.77	21.41

LTE Band 66						
BW	MCS Index	RB Size	RB Offset	Low	Mid	High
		Channel		132022	132322	132622
		Frequency (MHz)		1715	1745	1775
10M	QPSK	1	0	25.83	25.73	25.82
		1	24	25.78	25.71	25.77
		1	49	25.76	25.73	25.77
		25	0	25.48	25.52	24.87
		25	12	25.64	25.20	24.99
		25	25	25.26	25.43	25.03
		50	0	25.53	25.06	24.81
10M	16QAM	1	0	25.47	25.52	25.31
		1	24	25.23	25.51	25.19
		1	49	25.31	24.86	25.13
		25	0	23.88	23.87	24.17
		25	12	23.90	24.20	24.09
		25	25	23.82	24.16	23.47
		50	0	24.22	23.71	23.37
10M	64QAM	1	0	24.15	24.41	24.19
		1	24	24.18	23.92	23.54
		1	49	23.81	24.13	23.41
		25	0	23.65	22.86	23.01
		25	12	23.24	23.00	23.01
		25	25	23.56	22.97	23.15
		50	0	23.15	23.44	22.71
10M	256QAM	1	0	21.23	21.03	20.96
		1	24	21.09	21.10	21.49
		1	49	21.58	20.76	21.39
		25	0	21.05	21.28	20.88
		25	12	21.11	20.85	21.07
		25	25	21.52	21.08	20.75
		50	0	21.17	21.32	21.45

LTE Band 66						
BW	MCS Index	RB Size	RB Offset	Low	Mid	High
		Channel		131997	132322	132647
		Frequency (MHz)		1712.5	1745	1777.5
5M	QPSK	1	0	25.89	25.72	25.78
		1	12	25.85	25.73	25.83
		1	24	25.85	25.76	25.81
		12	0	24.95	25.38	25.14
		12	6	25.50	24.82	24.86
		12	13	25.45	25.24	24.86
		25	0	24.92	25.31	25.32
5M	16QAM	1	0	25.34	24.89	24.61
		1	12	24.88	25.10	24.67
		1	24	25.21	24.83	24.65
		12	0	24.03	23.89	24.26
		12	6	23.73	24.44	23.56
		12	13	23.68	24.14	23.61
		25	0	24.11	23.85	23.54
5M	64QAM	1	0	24.01	23.55	23.96
		1	12	24.27	23.96	23.79
		1	24	23.86	24.01	23.61
		12	0	23.46	23.08	23.47
		12	6	23.27	23.34	22.84
		12	13	23.27	23.46	23.11
		25	0	22.88	22.69	23.37
5M	256QAM	1	0	20.96	21.47	21.09
		1	12	21.36	21.09	21.09
		1	24	21.04	21.07	21.39
		12	0	20.99	21.28	21.37
		12	6	20.95	21.07	20.82
		12	13	21.14	20.94	20.79
		25	0	21.42	21.12	20.82

LTE Band 66						
BW	MCS Index	RB Size	RB Offset	Low	Mid	High
		Channel		131987	132322	132657
		Frequency (MHz)		1711.5	1745	1778.5
3M	QPSK	1	0	25.80	25.84	25.85
		1	7	25.64	25.85	25.72
		1	14	25.61	25.84	25.57
		8	0	24.86	25.41	24.68
		8	3	25.52	24.97	24.71
		8	7	25.41	25.01	25.37
		15	0	25.36	24.75	24.99
3M	16QAM	1	0	25.29	25.63	24.90
		1	7	25.17	25.26	25.41
		1	14	25.37	24.93	24.89
		8	0	23.77	24.06	23.54
		8	3	23.80	24.39	24.25
		8	7	23.75	24.16	24.12
		15	0	23.61	23.70	23.70
3M	64QAM	1	0	24.20	24.10	23.94
		1	7	23.84	24.22	23.41
		1	14	23.95	23.65	23.53
		8	0	23.66	22.93	22.83
		8	3	23.09	22.77	23.40
		8	7	22.89	22.72	23.39
		15	0	23.38	23.43	23.25
3M	256QAM	1	0	21.38	20.83	20.83
		1	7	21.38	21.33	21.52
		1	14	21.39	21.01	20.91
		8	0	21.29	21.44	21.27
		8	3	21.68	21.05	20.67
		8	7	20.89	21.31	21.27
		15	0	20.96	21.30	20.73

LTE Band 66						
BW	MCS Index	RB Size	RB Offset	Low	Mid	High
		Channel		131979	132322	132665
		Frequency (MHz)		1710.7	1745	1779.3
1.4M	QPSK	1	0	25.89	25.65	25.66
		1	2	25.86	25.72	25.71
		1	5	25.79	25.77	25.69
		3	0	24.87	25.40	25.61
		3	1	25.62	25.55	24.84
		3	3	25.21	25.59	24.58
		6	0	24.75	25.29	25.36
1.4M	16QAM	1	0	25.51	25.61	24.64
		1	2	25.54	25.36	24.94
		1	5	25.41	25.04	24.87
		3	0	23.98	24.43	23.91
		3	1	23.76	23.87	24.22
		3	3	23.76	23.63	23.89
		6	0	23.80	24.10	23.85
1.4M	64QAM	1	0	23.74	23.73	23.54
		1	2	23.74	23.76	23.90
		1	5	23.95	24.24	23.67
		3	0	23.72	22.96	22.64
		3	1	23.46	22.93	23.15
		3	3	23.33	22.75	23.35
		6	0	22.82	22.95	22.55
1.4M	256QAM	1	0	21.07	20.77	20.74
		1	2	21.60	21.30	21.38
		1	5	20.92	21.59	21.35
		3	0	21.06	21.13	21.29
		3	1	21.16	21.11	21.50
		3	3	21.38	21.34	21.44
		6	0	21.63	20.95	20.60

4.2 Modulation Characteristics Measurement

4.2.1 Limits of Modulation Characteristics

N/A

4.2.2 Test Procedure

Connect the EUT to Communication Simulator via the antenna connector, The frequency band is set as EUT supported Modulation and Channels, the EUT output is matched with 50 ohm load, the waveform quality and constellation of the EUT was tested.

4.2.3 Test Setup



4.2.4 Test Results

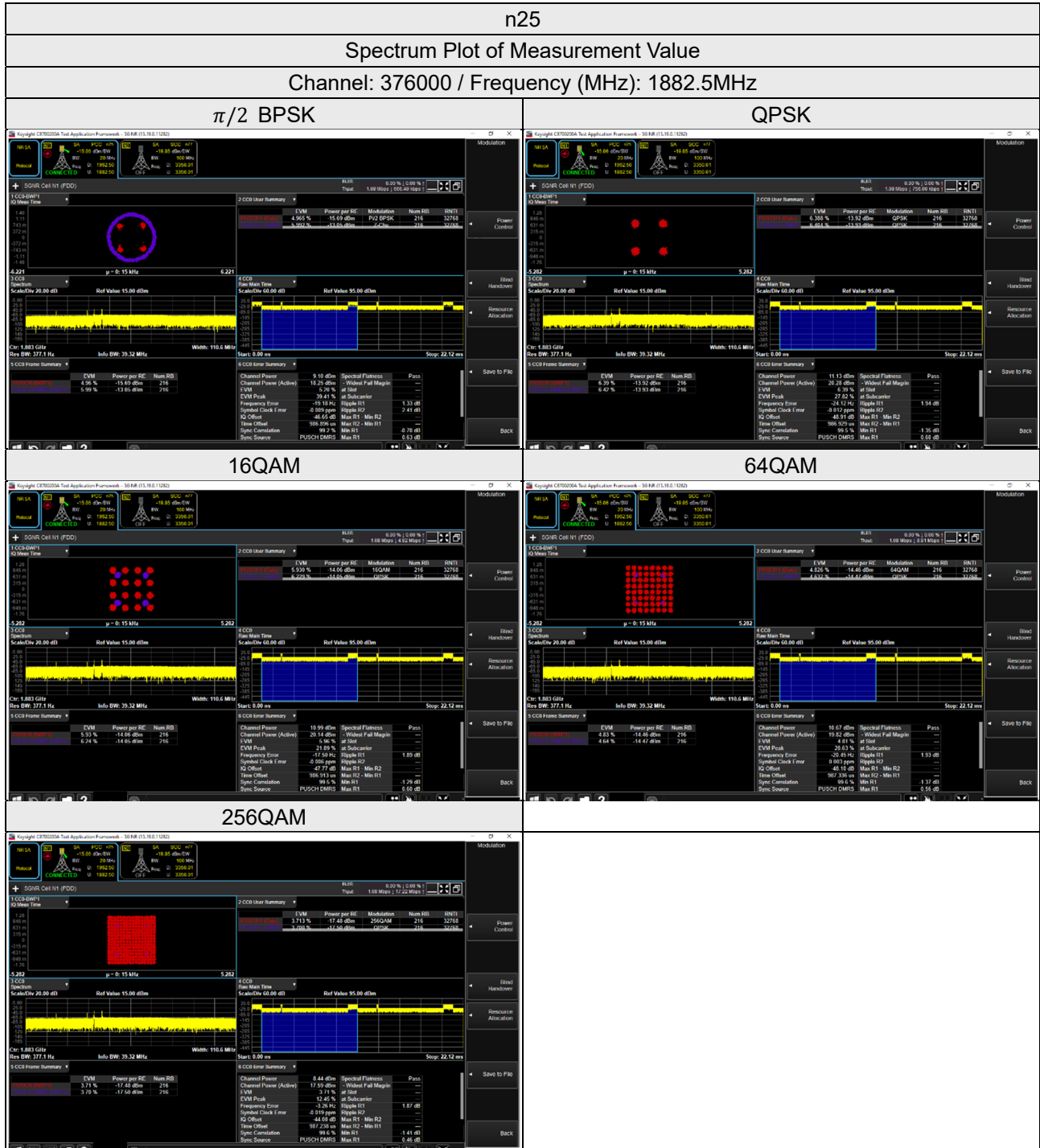

4.3 Frequency Stability Measurement

4.3.1 Limits of Frequency Stability Measurement

The frequency stability shall be sufficient to ensure that the fundamental emission stays within the authorized frequency block.

4.3.2 Test Procedure

- a. Device is placed at the oven room. The oven room could control the temperatures and humidity. Power warm up is at least 15 min and power applied should perform before recording frequency error.
- b. EUT is connected the external power supply to control the DC input power. The test voltage range is from minimum to maximum working voltage. Each step shall be record the frequency error rate.
- c. The temperature range step is 10 degrees in this test items. All temperature levels shall be hold the ± 0.5 °C during the measurement testing. The each temperature step shall be at least 0.5 hours, consider the EUT could be test under the stability condition.

Note: The frequency error was recorded frequency error from the communication simulator.

4.3.3 Conducted Setup

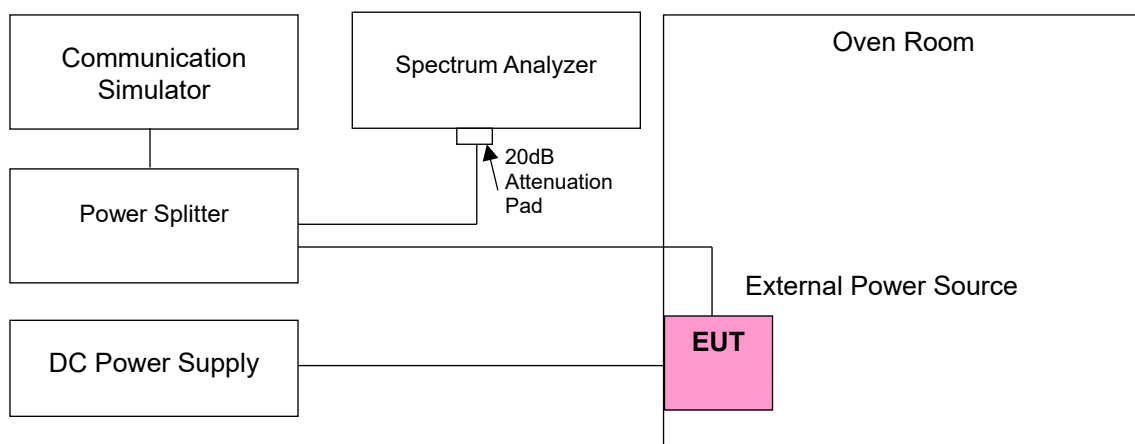

4.3.4 Test Results

Frequency Error vs. Voltage

Voltage (Vdc)	n25			
	Channel Bandwidth 5 MHz			
	Low Channel		High Channel	
	Frequency (MHz)	Frequency Error (ppm)	Frequency (MHz)	Frequency Error (ppm)
4.43	1852.500002	0.001	1912.500000	0.001
3.85	1852.500002	0.001	1912.500000	0.001
3.28	1852.500002	0.001	1912.500000	0.002

Note: The applicant defined the normal working voltage is from 3.28Vdc to 4.43Vdc.

Frequency Error vs. Temperature

Temp. (°C)	n25			
	Channel Bandwidth 5 MHz			
	Low Channel		High Channel	
	Frequency (MHz)	Frequency Error (ppm)	Frequency (MHz)	Frequency Error (ppm)
-30	1852.500002	0.001	1912.500000	0.002
-20	1852.500002	0.001	1912.500000	0.001
-10	1852.500002	0.001	1912.500000	0.001
0	1852.500003	0.002	1912.500000	0.001
10	1852.499998	-0.001	1912.500000	-0.001
20	1852.499998	-0.001	1912.500000	-0.001
30	1852.499998	-0.001	1912.500000	-0.002
40	1852.499998	-0.001	1912.500000	-0.001
50	1852.499998	-0.001	1912.500000	-0.002

Frequency Error vs. Voltage

Voltage (Vdc)	n25			
	Channel Bandwidth 10 MHz			
	Low Channel		High Channel	
	Frequency (MHz)	Frequency Error (ppm)	Frequency (MHz)	Frequency Error (ppm)
4.43	1855.000002	0.001	1910.000003	0.001
3.85	1855.000002	0.001	1910.000001	0.001
3.28	1855.000002	0.001	1910.000002	0.001

Note: The applicant defined the normal working voltage is from 3.28Vdc to 4.43Vdc.

Frequency Error vs. Temperature

Temp. (°C)	n25			
	Channel Bandwidth 10 MHz			
	Low Channel		High Channel	
	Frequency (MHz)	Frequency Error (ppm)	Frequency (MHz)	Frequency Error (ppm)
-30	1855.000001	0.001	1910.000003	0.002
-20	1855.000003	0.002	1910.000003	0.002
-10	1855.000001	0.001	1910.000004	0.002
0	1855.000001	0.001	1910.000002	0.001
10	1854.999999	-0.001	1909.999999	-0.001
20	1854.999997	-0.001	1909.999997	-0.001
30	1854.999997	-0.002	1909.999998	-0.001
40	1854.999996	-0.002	1909.999998	-0.001
50	1854.999996	-0.002	1909.999996	-0.002

Frequency Error vs. Voltage

Voltage (Vdc)	n25			
	Channel Bandwidth 15 MHz			
	Low Channel		High Channel	
	Frequency (MHz)	Frequency Error (ppm)	Frequency (MHz)	Frequency Error (ppm)
4.43	1857.500003	0.002	1907.500001	0.001
3.85	1857.500002	0.001	1907.500002	0.001
3.28	1857.500003	0.002	1907.500003	0.001

Note: The applicant defined the normal working voltage is from 3.28Vdc to 4.43Vdc.

Frequency Error vs. Temperature

Temp. (°C)	n25			
	Channel Bandwidth 15 MHz			
	Low Channel		High Channel	
	Frequency (MHz)	Frequency Error (ppm)	Frequency (MHz)	Frequency Error (ppm)
-30	1857.500002	0.001	1907.500001	0.001
-20	1857.500001	0.001	1907.500004	0.002
-10	1857.500003	0.002	1907.500004	0.002
0	1857.500001	0.001	1907.500003	0.002
10	1857.499997	-0.002	1907.499997	-0.002
20	1857.499996	-0.002	1907.499998	-0.001
30	1857.499998	-0.001	1907.499996	-0.002
40	1857.499999	-0.001	1907.499997	-0.002
50	1857.499996	-0.002	1907.499998	-0.001

Frequency Error vs. Voltage

Voltage (Vdc)	n25			
	Channel Bandwidth 20 MHz			
	Low Channel		High Channel	
	Frequency (MHz)	Frequency Error (ppm)	Frequency (MHz)	Frequency Error (ppm)
4.43	1860.000002	0.001	1905.000003	0.002
3.85	1860.000002	0.001	1905.000003	0.002
3.28	1860.000002	0.001	1905.000004	0.002

Note: The applicant defined the normal working voltage is from 3.28Vdc to 4.43Vdc.

Frequency Error vs. Temperature

Temp. (°C)	n25			
	Channel Bandwidth 20 MHz			
	Low Channel		High Channel	
	Frequency (MHz)	Frequency Error (ppm)	Frequency (MHz)	Frequency Error (ppm)
-30	1860.000002	0.001	1905.000003	0.001
-20	1860.000002	0.001	1905.000001	0.001
-10	1860.000001	0.001	1905.000004	0.002
0	1860.000004	0.002	1905.000003	0.002
10	1859.999997	-0.001	1904.999999	-0.001
20	1859.999997	-0.001	1904.999997	-0.001
30	1859.999996	-0.002	1904.999996	-0.002
40	1859.999997	-0.002	1904.999997	-0.002
50	1859.999998	-0.001	1904.999996	-0.002

4.4 Occupied Bandwidth Measurement

4.4.1 Test Procedure

The EUT makes a call to the communication simulator. All measurements were done at low, middle and high operational frequency range. The communication simulator station system controlled a EUT to export maximum output power under transmission mode and specific channel frequency. Measurement method, please refer to section 5.4.4 of ANSI C63.26. Use OBW measurement function of Spectrum analyzer to measure 99 % occupied bandwidth.

For the 26dBc bandwidth measurement method, please refer to section 5.4.3 of ANSI C63.26.

4.4.2 Test Setup

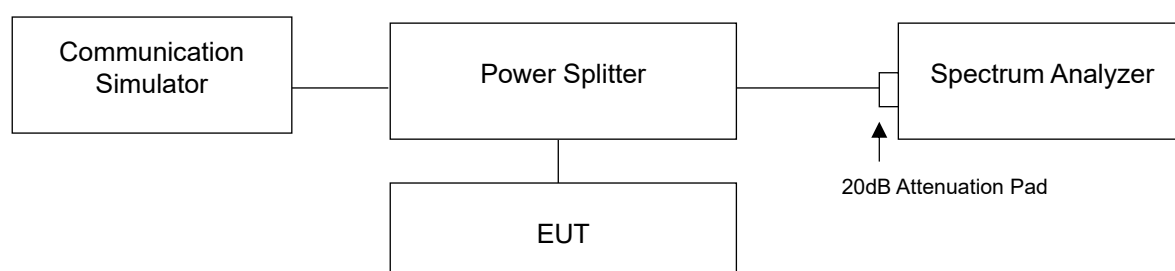

4.4.3 Test Result

Occupied Bandwidth

n25, Channel Bandwidth: 5MHz						
Channel	Frequency (MHz)	99% Occupied Bandwidth (MHz)				
		$\pi/2$ BPSK	QPSK	16QAM	64QAM	256QAM
370500	1852.5	4.46	4.46	4.45	4.45	4.46
376500	1882.5	4.46	4.46	4.45	4.46	4.46
382500	1912.5	4.47	4.47	4.46	4.46	4.47
n25, Channel Bandwidth: 10MHz						
Channel	Frequency (MHz)	99% Occupied Bandwidth (MHz)				
		$\pi/2$ BPSK	QPSK	16QAM	64QAM	256QAM
371000	1855.0	8.89	9.26	9.26	9.27	9.26
376500	1882.5	8.90	9.27	9.27	9.28	9.26
382000	1910.0	8.91	9.28	9.28	9.28	9.27
n25, Channel Bandwidth: 15MHz						
Channel	Frequency (MHz)	99% Occupied Bandwidth (MHz)				
		$\pi/2$ BPSK	QPSK	16QAM	64QAM	256QAM
371500	1857.5	13.36	14.08	14.07	14.07	14.07
376500	1882.5	13.36	14.07	14.08	14.08	14.07
381500	1907.5	13.37	14.08	14.09	14.08	14.08
n25, Channel Bandwidth: 20MHz						
Channel	Frequency (MHz)	99% Occupied Bandwidth (MHz)				
		$\pi/2$ BPSK	QPSK	16QAM	64QAM	256QAM
372000	1860.0	17.82	18.90	18.91	18.90	18.91
376500	1882.5	17.79	18.87	18.87	18.88	18.87
381000	1905.0	17.78	18.85	18.87	18.86	18.86

Spectrum Plot of Worst Value

5MHz / 256QAM

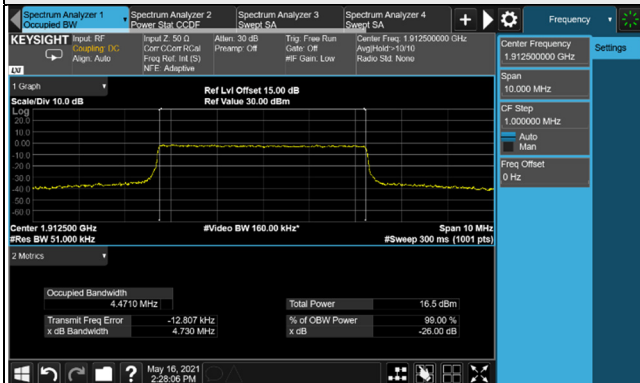

10MHz / 64QAM

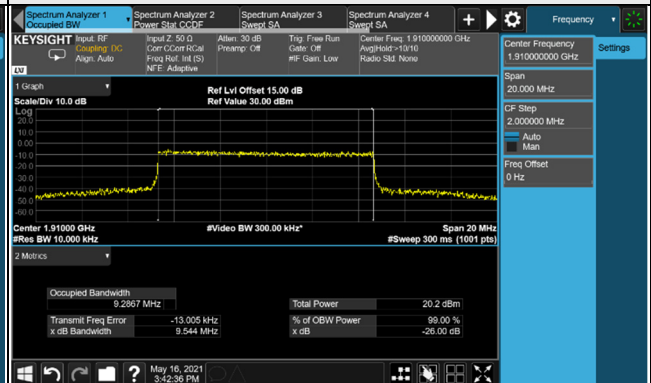

15MHz / 16QAM

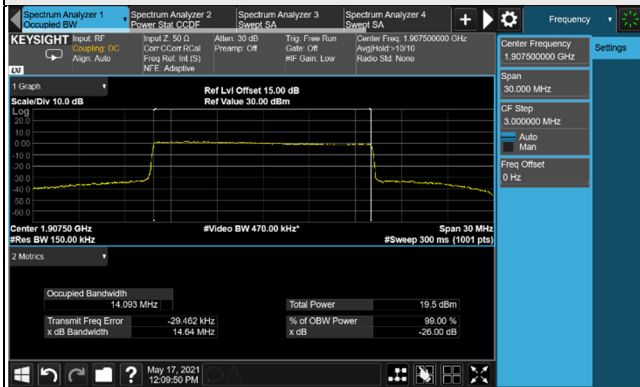

20MHz / 256QAM

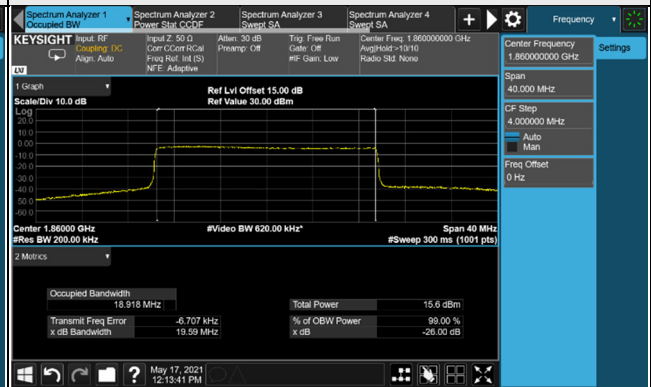

26dB Bandwidth

n25, Channel Bandwidth: 5MHz						
Channel	Frequency (MHz)	26dBc Bandwidth (MHz)				
		$\pi/2$ BPSK	QPSK	16QAM	64QAM	256QAM
370500	1852.5	4.72	4.73	4.70	4.72	4.69
376500	1882.5	4.70	4.76	4.68	4.75	4.68
382500	1912.5	4.76	4.76	4.73	4.75	4.73
n25, Channel Bandwidth: 10MHz						
Channel	Frequency (MHz)	26dBc Bandwidth (MHz)				
		$\pi/2$ BPSK	QPSK	16QAM	64QAM	256QAM
371000	1855.0	9.12	9.57	9.53	9.53	9.51
376500	1882.5	9.18	9.61	9.50	9.55	9.53
382000	1910.0	9.18	9.56	9.51	9.54	9.51
n25, Channel Bandwidth: 15MHz						
Channel	Frequency (MHz)	26dBc Bandwidth (MHz)				
		$\pi/2$ BPSK	QPSK	16QAM	64QAM	256QAM
371500	1857.5	13.90	14.61	14.58	14.60	14.60
376500	1882.5	13.90	14.61	14.60	14.59	14.60
381500	1907.5	13.90	14.61	14.64	14.59	14.60
n25, Channel Bandwidth: 20MHz						
Channel	Frequency (MHz)	26dBc Bandwidth (MHz)				
		$\pi/2$ BPSK	QPSK	16QAM	64QAM	256QAM
372000	1860.0	18.53	19.61	19.60	19.58	19.59
376500	1882.5	18.50	19.59	19.57	19.57	19.60
381000	1905.0	18.49	19.57	19.57	19.56	19.57

Spectrum Plot of Worst Value

5MHz / $\pi/2$ BPSK

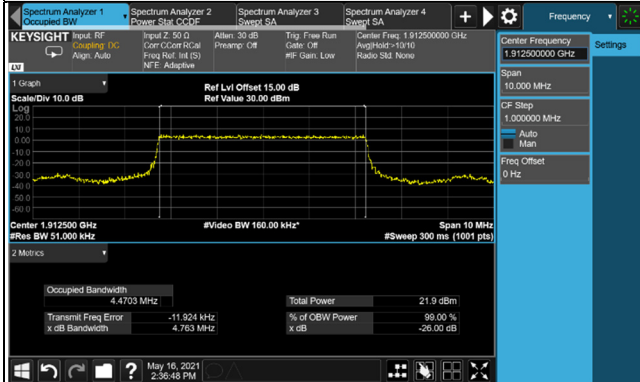

10MHz / QPSK

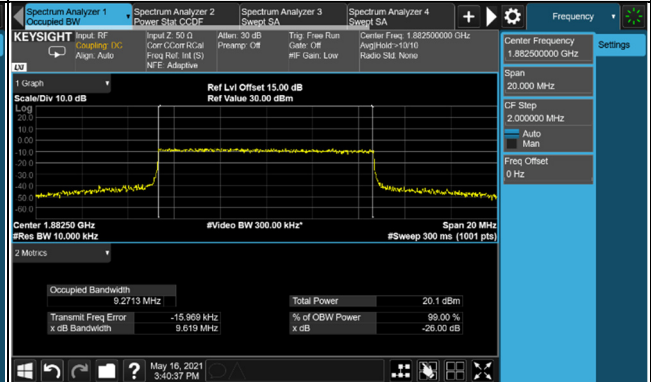

15MHz / QPSK

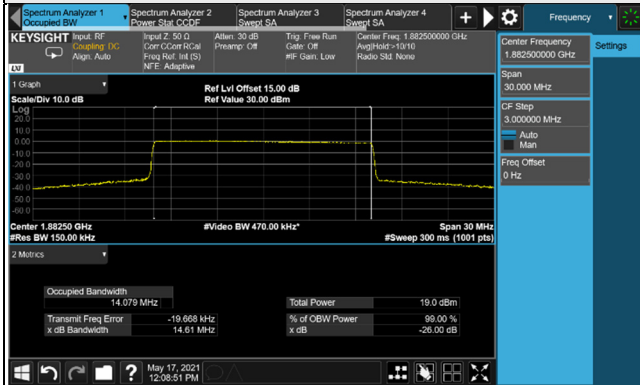

20MHz / QPSK

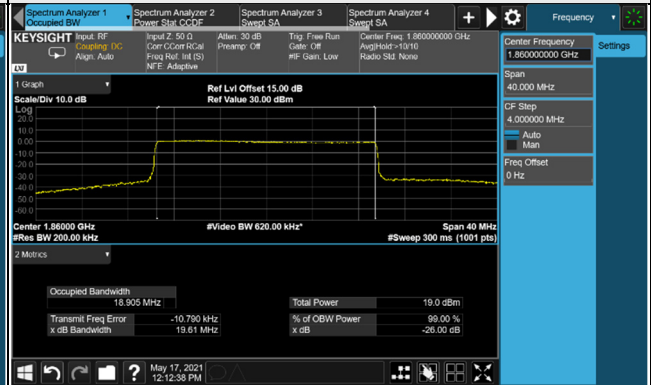

4.5 Band Edge Measurement

4.5.1 Limits of Band Edge Measurement

Power of any emission outside of the authorized operating frequency ranges must be attenuated below the transmitting power (P) by a factor of at least $43 + 10 \log(P)$ dB. In the 1 MHz bands immediately outside and adjacent to the frequency block a resolution bandwidth of at least one percent of the emission bandwidth of the fundamental emission of the transmitter may be employed.

4.5.2 Test Setup

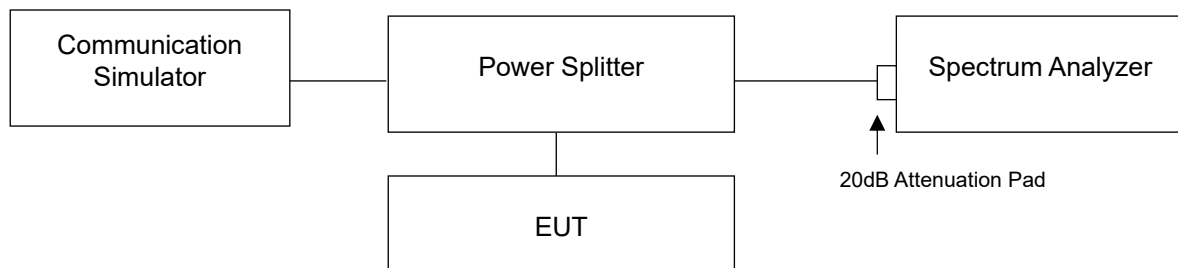

4.5.3 Test Procedures

- All measurements were done at low and high operational frequency range.
- The center frequency of spectrum is the band edge frequency and span is 2MHz. RB of the spectrum is 51kHz and VB of the spectrum is 160kHz (Channel Bandwidth 5MHz).
- The center frequency of spectrum is the band edge frequency and span is 2MHz. RB of the spectrum is 100kHz and VB of the spectrum is 300kHz (Channel Bandwidth 10MHz).
- The center frequency of spectrum is the band edge frequency and span is 2MHz. RB of the spectrum is 150kHz and VB of the spectrum is 470kHz (Channel Bandwidth 15MHz).
- The center frequency of spectrum is the band edge frequency and span is 2MHz. RB of the spectrum is 200kHz and VB of the spectrum is 620kHz (Channel Bandwidth 20MHz).
- Record the max trace plot into the test report.

4.5.4 Test Results

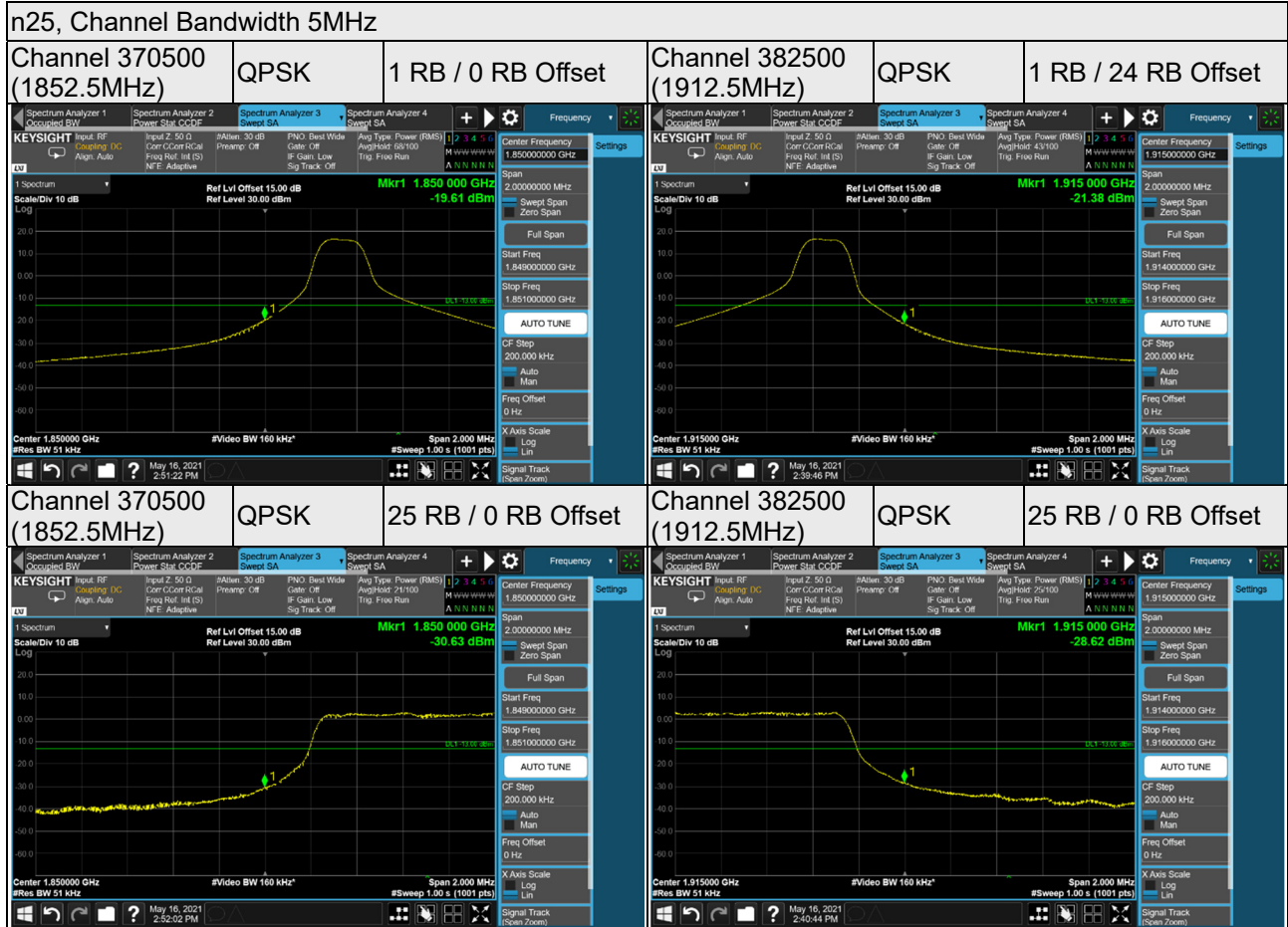

n25, Channel Bandwidth 10MHz

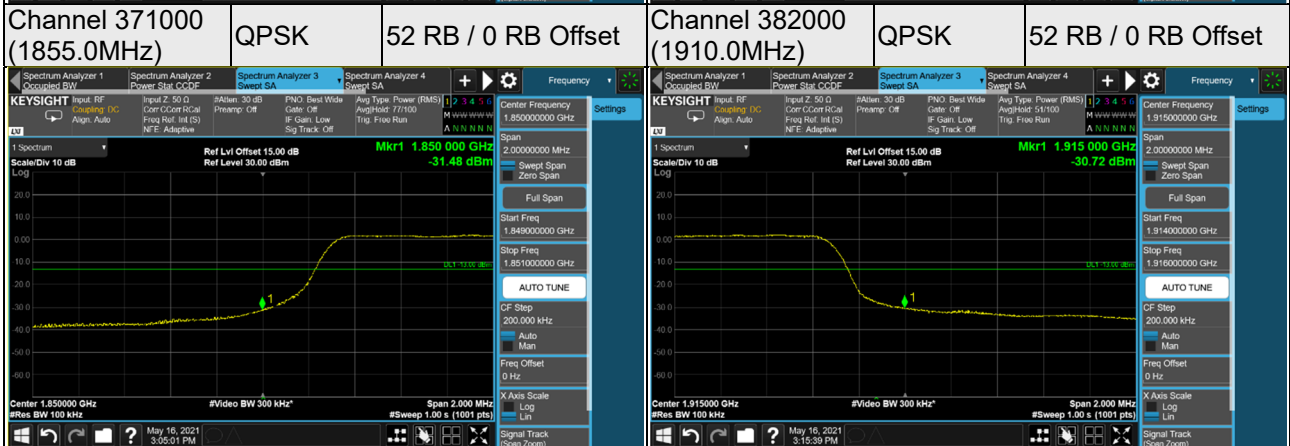
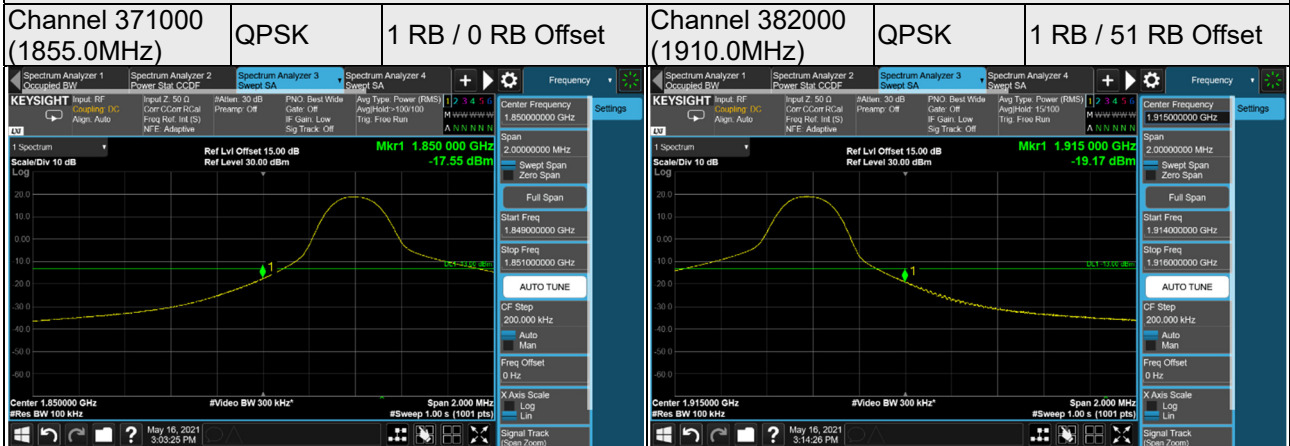

n25, Channel Bandwidth 15MHz

