

MHB Antenna Datasheet

PDC

2022/07/07



Quanta
Product Design Center

Antenna Spec

Project Name		O2b(MHB)		
Antenna Application 天線應用		Bluetooth Antenna		
Antenna Type 天線型式		FPC Antenna		
Supplier 天線製造商		Pulse (Suzhou) Wireless Products co.		
Supplier Address 天線製造商地址		99 Huoju Road, Suzhou New District, Suzhou, Jiangsu, China, 215009		
Part Number		TQ24233		
Antenna and metal distance 天線與金屬距離	Vertical 垂直	0.75mm		
	Horizontal 水平	2.38mm		
PCB Clear Zone PCB淨空區		1.26*26mm		
		L(2402 MHz)	M(2441 MHz)	H(2480 MHz)
Efficiency 天線效率		13.21% (-8.79dB)	13.77% (-8.61dB)	13.12% (-8.82dB)
Peak Gain (dBi)		-3.63 dBi	-3.44 dBi	-3.49 dBi

Radiation Pattern 2402MHz

Total

Azimuth = 0.0
Elevation = -30.0
Roll = -30.0

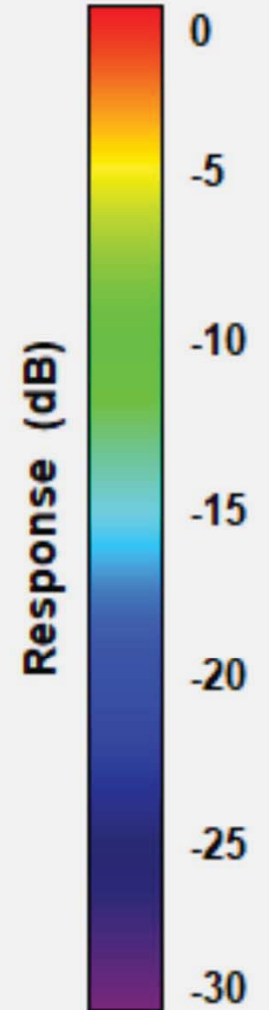
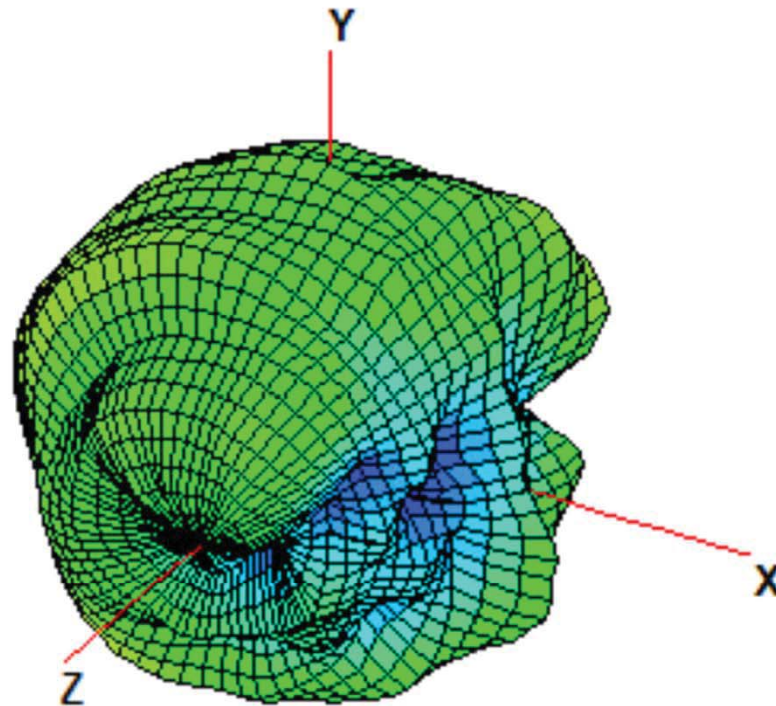

Radiation Pattern 2441MHz

Total

Azimuth = 0.0
Elevation = -30.0
Roll = -30.0

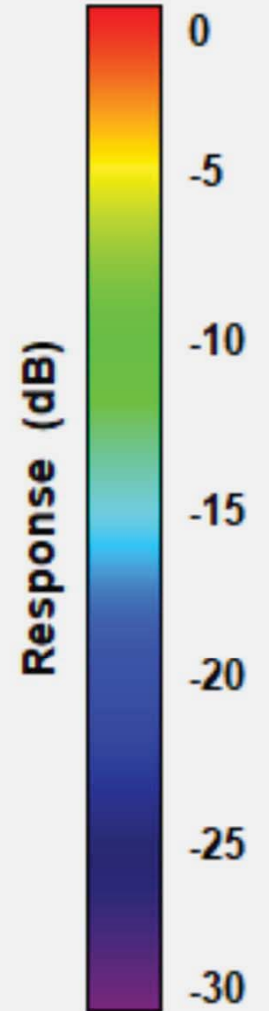
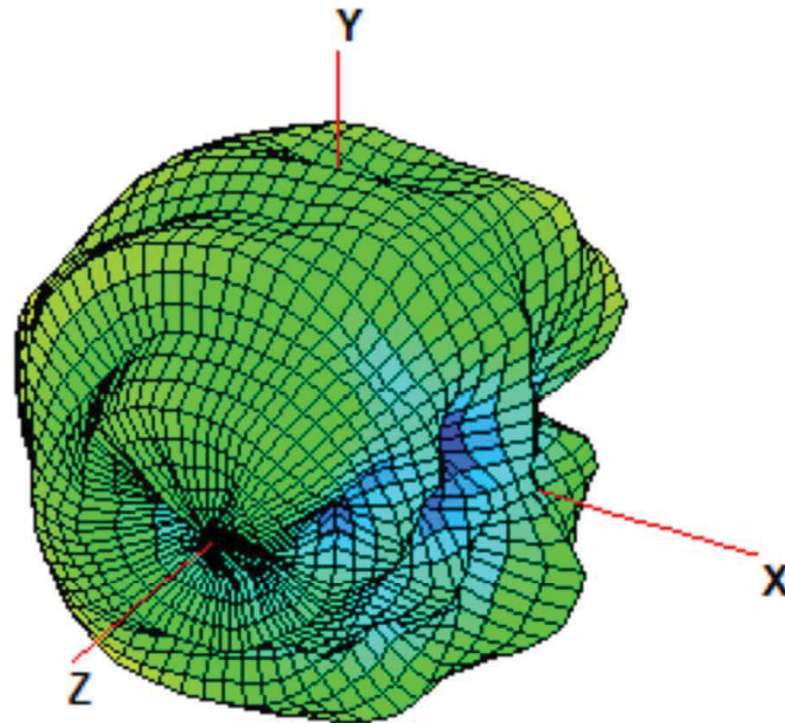

Radiation Pattern 2480MHz

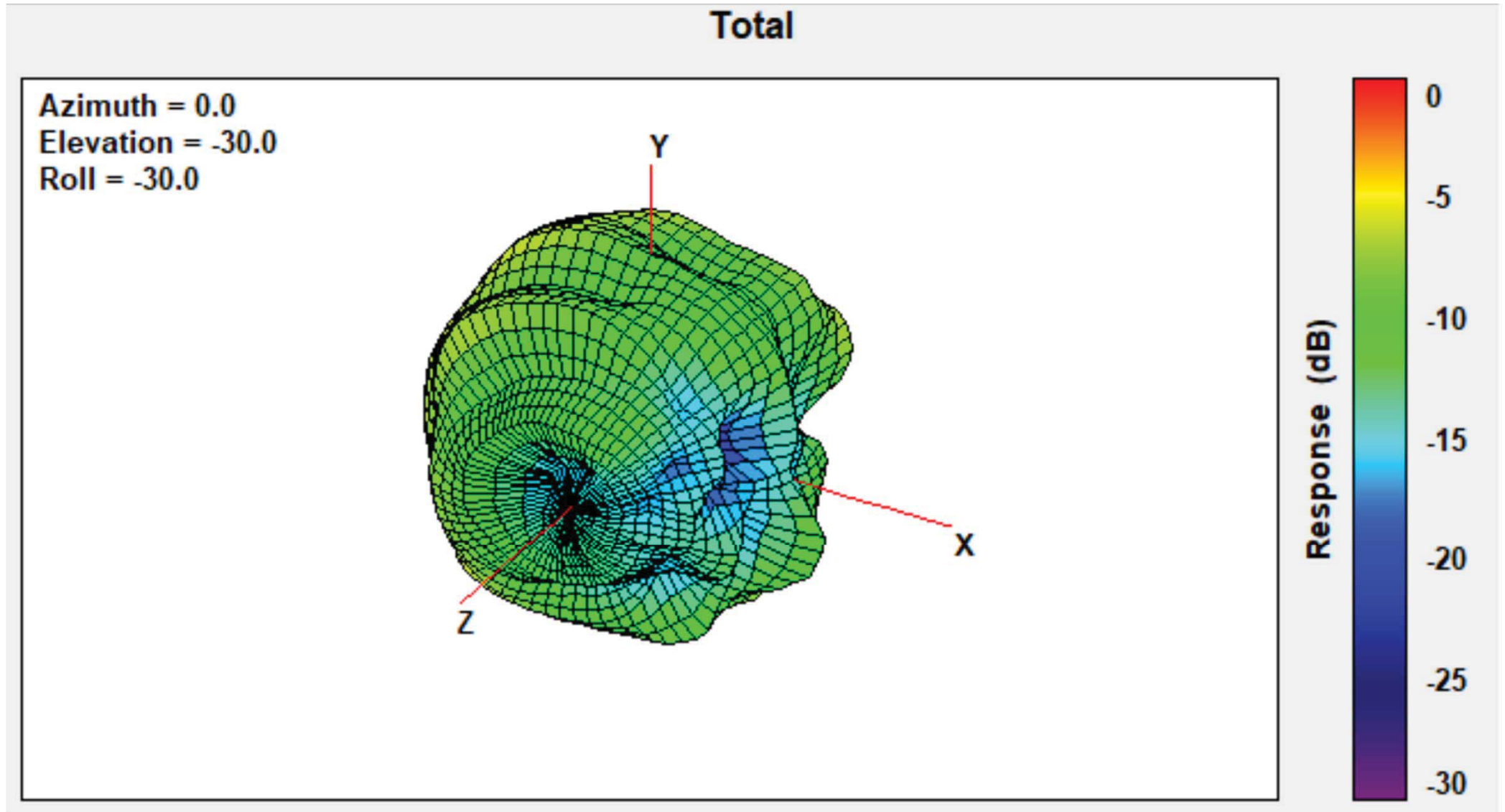

MOD	REVISION DESCRIPTION	DATE / EDITOR
10	New Release	2023.03.22 / Alvin

Please follow Pulse Limits for the hazardous substances (RoHS, halogens) in the document "Pulse Hazardous Substances (HS) Limits (RPG002-03)" and "Vendor Survey Questionnaire, Material Composition (LOM-SAF-L0040)".

Reliability Test Spec according to WIHS7.5.33 (Reliability Test Working Instruction) Default test standard is Test Standard A if no definition

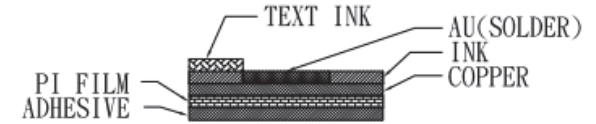

MHB BT ANT YMMDD 10

TEXT INK
SCALE 3:1

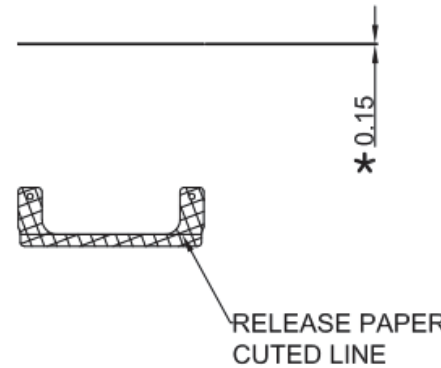
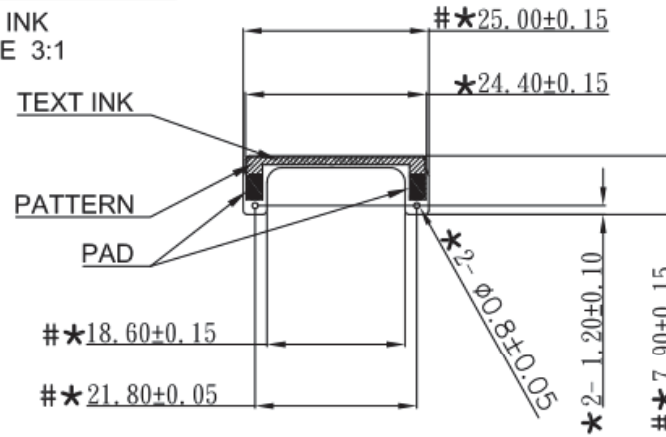

Confidential
This is a proprietary information of Pulse Suzhou.
No reproduction/copying is allowed without permission.

Functional Characteristics Key : (Cpk requirement : Cpk>)

- ◇ Process Capability Studies required(total pcs)
- ◆ Ongoing Statistical Process Control Required (total pcs)
- * Critical dimension need to be measured, no CPK requirement (total pcs)

Pulse (Suzhou) Wireless Products Co., Ltd		THIRD ANGLE PROJECTION		HANDLING	
99 HUOJU RD, SUZHOU NEW DISTRICT SUZHOU 215009 P.R.CHINA WWW.PULSEELECTRONICS.COM/ANTENNAS		GENERAL TOOLS DRAWING		ISO 2768-I	
PRODUCT(S) TQ24233	DESIGN	ALVIN	20220627		
	CHECKED	CHENG	20220627		
	APPROVED	CHENG	20220627		
ITEM NAME MHB - BT ANTENNA	DOCUMENT NUMBER	TQ24233	DRAWING REVISION	V01	DOCUMENT VERSION
			10	20230322	Alvin
			MOD	DATE	NAME

QUANTA PART NO :					
DQ602423300					
SCALE		1:1			
DOCUMENT NUMBER		TQ24233			
DRAWING REVISION		V01			
DOCUMENT VERSION		10			
10	20230322	Alvin			
MOD	DATE	NAME			