



FCC / IC TEST REPORT

for

47 CFR Part 15 Subpart C (Section 15.239) and RSS-210

Equipment : Satellite Radio PnP Receiver
Trade Name : Sirius Satellite Radio
Model No. : SI2 for FCC
SI2C for IC
Product Name : InV2
FCC ID : HFSGS1SI2TK1
IC ID : 1787B-GS1SI2
Filing Type : Certification
Applicant : **Quanta Computer Inc.**
No. 188, Wen Hwa 2nd Rd., Kuei Shan Hsiang, Tao Yuan
Shien, Taiwan, R.O.C.

- The test result refers exclusively to the test presented test model / sample.
- Without written approval of SPORTON International Inc., the test report shall not be reproduced except in full.
- **Certificate or Test Report must not be used by the applicant to claim the product in this test report endorsement by NVLAP or any agency of U.S. government.**
- The data shown in this test report were carried out on Aug. 27, 2007 at **Sporton International Inc. LAB.**
- Report No.: FR781519, Report Version: Rev. 01.

Jones Tsai
Manager

SPORTON International Inc.

6F, No.106, Sec. 1, Hsin Tai Wu Rd., Hsi Chih, Taipei Hsien, Taiwan, R.O.C.



Table of Contents

History of this test report..... ii

1. General Description of Equipment under Test..... 1

 1.1.Applicant..... 1

 1.2.Manufacturer 1

 1.3.Basic Description of Equipment under Test..... 1

 1.4.Feature of Equipment under Test 2

2. Test Configuration of Equipment under Test 3

 2.1.Test Manner 3

 2.2.Test Mode 3

 2.3.Ancillary Equipment List..... 3

 2.4.Connection Diagram of Test System 4

3. RF Utility 5

4. General Information of Test..... 6

 4.1.Test Voltage 6

 4.2.Standard for Methods of Measurement..... 6

 4.3.Test Compliance 6

 4.4.Frequency Range..... 6

 4.5.Test Distance 6

5. Report of Measurements and Examinations 7

 5.1.List of Measurements and Examinations 7

 5.2.200 kHz Bandwidth of Frequency Band Edges 8

 5.3 20dBc and Field Strength..... 17

 5.4 Radiated Emission Measurement 35

6. List of Measuring Equipments 43

7. Uncertainty Evaluation..... 44

Appendix A. External Product Photograph

Appendix B. Internal Product Photograph

Appendix C. Setup Photograph



1. General Description of Equipment under Test

1.1. Applicant

Quanta Computer Inc.

No. 188, Wen Hwa 2nd Rd., Kuei Shan Hsiang, Tao Yuan Shien, Taiwan, R.O.C.

1.2. Manufacturer

Tech-Giant(Shanghai)Computer Co., Ltd

No.68, Sanzhuang Road, Songjiang Export Processing Zone, Shanghai, China

1.3. Basic Description of Equipment under Test

Equipment		Satellite Radio PnP Receiver
Trade Name		Sirius Satellite Radio
Model No.		SI2 for FCC
		SI2C for IC
Product Name		InV2
FCC ID		HFSGS1SI2TK1
IC ID		1787B-GS1SI2
Car Charger	Brand Name	Sirius
	Model Name	SP-C4-CLA-ALT
	Power Rating	I/P: DC 9-16V ; O/P: 5.2V, 1.5A
	DC Power Cord Type	1.6m non-shielded cable with ferrite core
Dot Antenna 1	Brand Name	Sirius
	Model Name	ISGSRA733
Dot Antenna 2	Brand Name	WNC
	Model Name	SIR-3.3WNCMOB02

Remark: Above EUT's information was declared by manufacturer. Please refer to the specifications of manufacturer or User's Manual for more detailed features description.

**1.4. Feature of Equipment under Test**

Product Feature & Specification			
1.	Modulation Type/Data Rate	FM Transmitter	
2.	Frequency Range.	88.1 MHz ~ 107.9 MHz	
3.	Number of Channels	99	
4.	Carrier Frequency of each channel	88.1 + n * 200 kHz, n = 0~99	
5.	HW Version (PCB)	Rev:D	
6.	HW Version (PCBA)	D3A	
7.	SW Version	000.002.015	
8.	Type of Antenna Connector	N/A	
9.	Antenna Type	Monopole Antenna	
10.	Antenna Gain	<0dBd (relative to dipole)	
11.	Fundamental Field Strength	39.13 dBuV/m at 3m (Average) 39.31 dBuV/m at 3m (Peak)	
12.	Function Type	Transmitter	V Transceiver



2. Test Configuration of Equipment under Test

2.1. Test Manner

- a. The EUT has been associated with peripherals pursuant to ANSI C63.4-2003 and configuration operated in a manner tended to maximize its emission characteristics in a typical application.
- b. The EUT is programmed to transmit signal continuously for all tests.
- c. Frequency range investigated: radiation 30 MHz to 1000MHz. The highest tasted frequency is up to 1GHz, beyond the tenth harmonic of the highest fundamental frequency (108MHz).
- d. The EUT is used DC power source, conducted emission is not necessary.

2.2. Test Mode

Application	FM Transmission
Radiated Emission	Mode 1: Tx_Low channel_88.1 MHz_Satellite Radio 2 + Car Charge12V + FEA Mode 2: Tx_Middle channel_98.1 MHz_Satellite Radio 2 + Car Charge12V + FEA Mode 3: Tx_High channel_107.9 MHz_Satellite Radio 2 + Car Charge12V + FEA Mode 4: Tx_Low channel_88.1 MHz_Satellite Radio 2 + Car Charge12V Mode 5: Tx_Middle channel_98.1 MHz_Satellite Radio 2 + Car Charge12V Mode 6: Tx_High channel_107.9 MHz_Satellite Radio 2 + Car Charge12V

2.3. Ancillary Equipment List

Item	Equipment	Trade Name	Model No.	FCC ID	Power Cord / Cable
1.	Car Battery	YUASA	46B24R	N/A	N/A
2.	Satellite Generator	IZT DSG2000	N/A	N/A	N/A

2.4. Connection Diagram of Test System

The test sample was monitored by onsite supervisor for on assurance of producing maximum interference reading. The worst case in testing result can fulfill interference limitation.

<External Antenna>

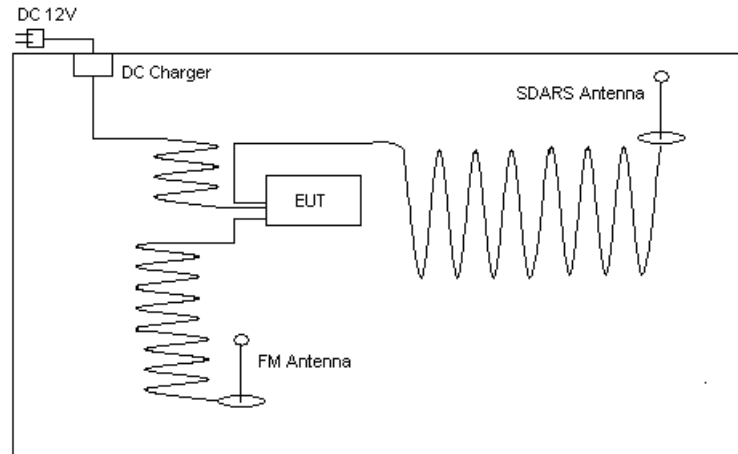

<Internal Antenna>

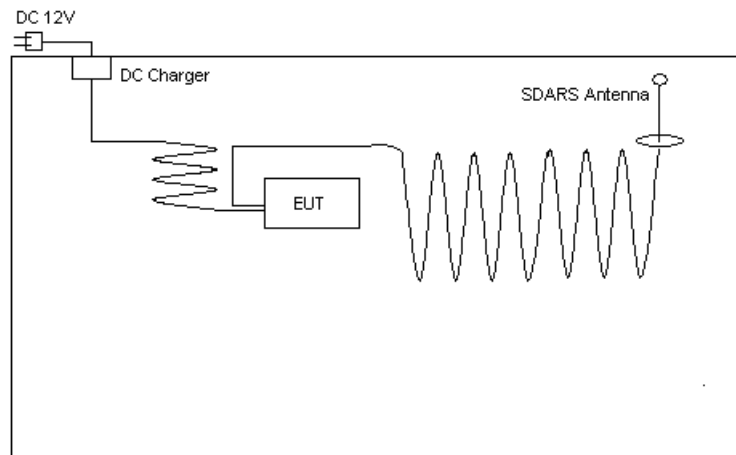



3. RF Utility

The RF Utility is established by using FM transmission in continuous Tx Mode for radiation emission.



4. General Information of Test

Test Site Location : No. 52, Hwa Ya 1st Rd., Hwa Ya Technology Park,
Kwei-Shan Hsiang, Tao Yuan Hsien, Taiwan, R.O.C.
TEL : 886-3-327-3456
FAX : 886-3-318-0055

Test Site No : 03CH06-HY

4.1. Test Voltage

DC 12.0V

4.2. Standard for Methods of Measurement

ANSI C63.4-2003

4.3. Test Compliance

47 CFR Part 15 Subpart C (Section 15.239) and IC RSS-210 Issued 7

4.4. Frequency Range

Radiation: from 30 MHz to 1000MHz

4.5. Test Distance

The test distance of radiated emission from antenna to EUT is 3 m.



5. Report of Measurements and Examinations

5.1. List of Measurements and Examinations

FCC Rule	Description of Test	Result	Section
15.239 (a)	Band Edge	Pass	5.2
15.239 (b)	20 dBc and Field Strength	Pass	5.3
15.239 (c)	Radiated Emission	Pass	5.4



5.2. 200 kHz Bandwidth of Frequency Band Edges

5.2.1 Measuring Instruments

As described in chapter 6 of this test report.

5.2.2 Test Procedure

1. The transmitter output was connected to the spectrum analyzer via a low lose cable.
2. Set both RBW/VBW=10 kHz/30 kHz for peak measurement and Receiver for average measurement in the radiated measurement.
3. The band edges was measured and recorded.

5.2.3 Test Result

- Temperature : 25~27°C
- Relative Humidity : 57~61%
- Test Engineer : Andrew

Emission from the intentional radiator shall be confined within a band 200 kHz wide centered on the operating frequency. The 200 kHz band shall lie wholly within the frequency range of 88-108 MHz.



5.2.4 Frequency Band Edge

>External Antenna

Low channel_88.1 MHz (Horizontal)

Date: 2007-09-06

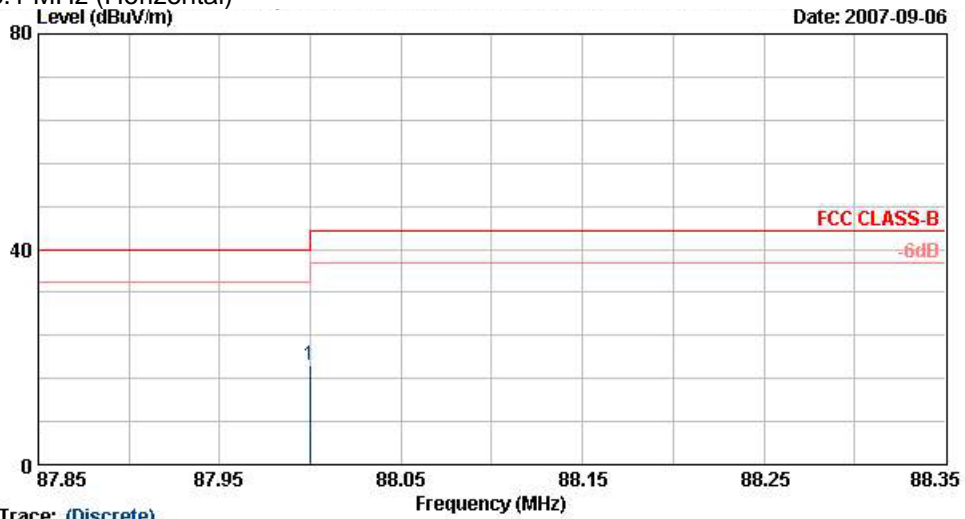

Trace: (Discrete)
 Site : 03CH06-HY
 Condition : LF-ANT(951121) HORIZONTAL
 EUT : Satellite Radio
 Power : 12 Vdc
 Model : FR 781519
 Memo : FM 88.1MHz Tx+ Satellite Radio 2 + FEA
 Memo : + Car Charge(12v)
 SID : 019413613622

	Freq	Level	Over Limit	Limit	Antenna Line Factor	Cable Loss	Preamp Factor	Ant Pos	Table Pos	Remark
	MHz	dBuV/m	dB	dBuV/m	dB/m	dB	dB	cm	deg	
1 @	88.0	18.52	-21.48	40.00	8.73	1.03	31.12	---	---	Peak



Low channel_88.1 MHz (Vertical)

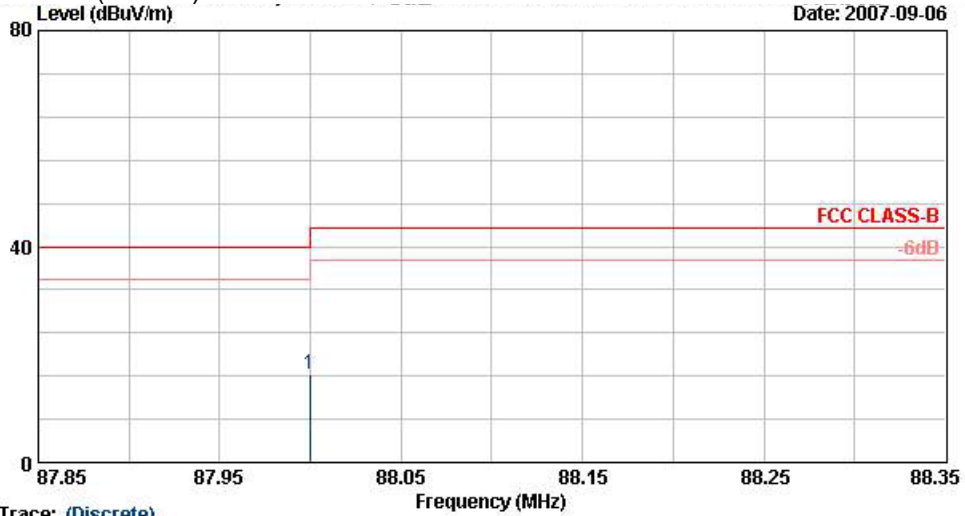

Trace: (Discrete)

Site : 08CH06-HY
 Condition : LP-ANT(951121) VERTICAL
 EUT : Satellite Radio
 Power : 12 Vdc
 Model : FR 781519
 Memo : FM 88.1MHz Tx+ Satellite Radio 2 + FEA
 Memo : + Car Charger(12v)
 SID : 019413613622

	Freq	Level	Over	Limit	Antenna	Cable	Preamp	Ant	Table	Remark
	MHz	dBuV/m	dB	dBuV/m	dB/m	dB	dB	cm	deg	
1 @	88.0	16.43	-23.57	40.00	8.73	1.03	31.12	---	---	Peak



High channel_107.9 MHz (Horizontal)

Date: 2007-09-06

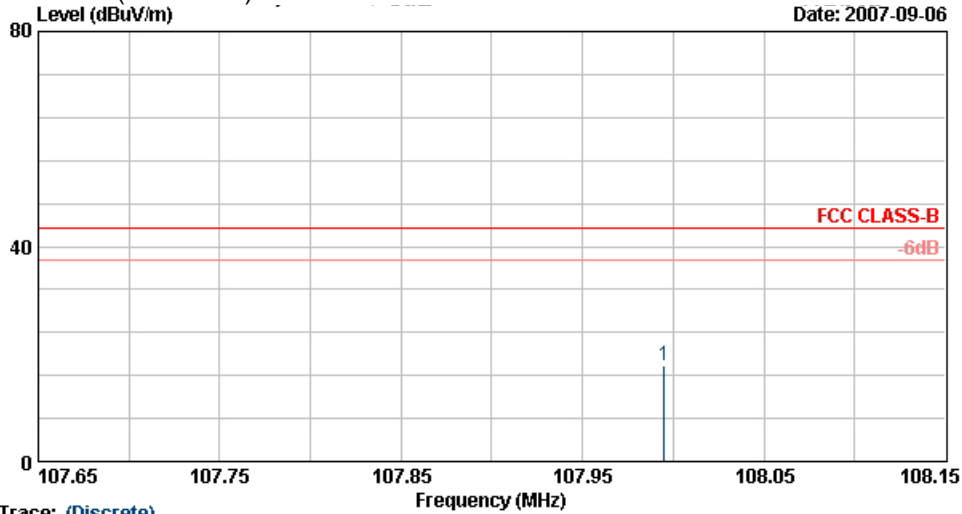

Trace: (Discrete)

Site : 08CH06-HY
 Condition : LP-ANT(951121) HORIZONTAL
 EUT : Satellite Radio
 Power : 12 Vdc
 Model : FR 781519
 Memo : FM 107.9MHz Tx+ (Satellite Radio 2+ FEA
 Memo : + FEA
 SID : 019413613622

	Freq	Level	Over Limit	Limit Line	ReadAntenna	Cable	Preamp	Ant	Table	
	MHz	dBuV/m	dB	dBuV/m	dBuV	dB	dB	cm	deg	Remark
1 @	108.0	17.74	-25.76	43.50	36.09	11.60	1.10	31.06	---	--- Peak



High channel_107.9 MHz (Vertical)

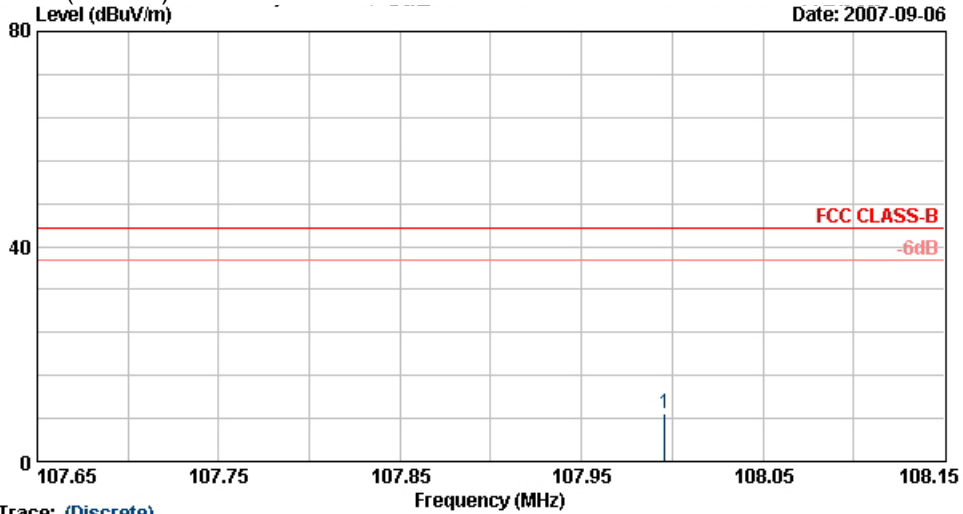

Date: 2007-09-06

Trace: (Discrete)

Site : 08CH06-HY
 Condition : LP-ANT(951121) VERTICAL
 EUT : Satellite Radio
 Power : 12 Vdc
 Model : FR 781519
 Memo : FM 107.9MHz Tx+ Satellite Radio 2+ FEA
 Memo : + FEA
 SID : 019413613622

	Freq	Level	Over	Limit	ReadAntenna	Cable	Preamp	Ant	Table	Remark	
	MHz	dBuV/m	dB	dBuV/m	dBuV	dB/m	dB	dB	cm	deg	
1 @	108.0	8.93	-34.57	43.50	27.28	11.60	1.10	31.06	---	---	Peak



>Internal Antenna

Low channel_88.1 MHz (Horizontal)

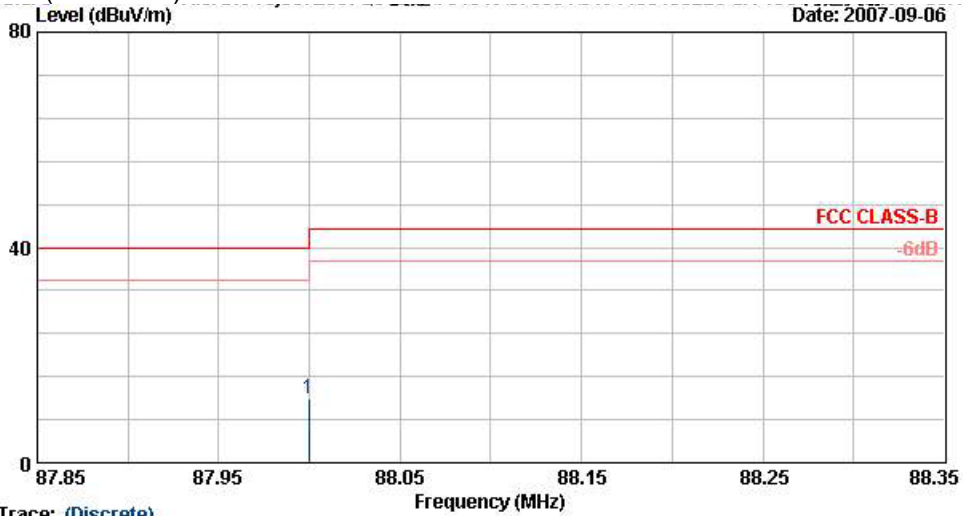

Date: 2007-09-06

Trace: (Discrete)

Site : GCH06-HY
 Condition : LP-ANT(951121) HORIZONTAL
 EUT : Satellite Radio
 Power : 12 Vdc
 Model : FR 781519
 Memo : FM 88.1MHz Tx+ Satellite Radio 2
 SID : + Car Charge(12v)
 : 019413613622

	Freq	Level	Over	Limit	Antenna	Cable	Preamp	Ant	Table	Remark
	MHz	dBuV/m	dB	dBuV/m	dB/m	dB	dB	cm	deg	
1	88.0	12.01	-27.99	40.00	8.73	1.03	31.12	---	---	Peak



Low channel_88.1 MHz (Vertical)

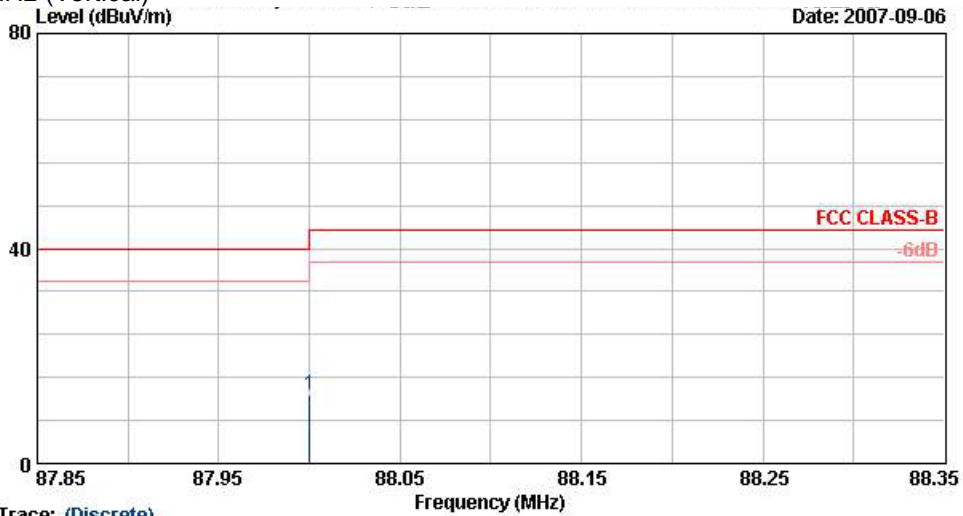

Trace: (Discrete)

Site : 08CH06-HY
 Condition : LP-ANT(951121) VERTICAL
 EUT : Satellite Radio
 Power : 12 Vdc
 Model : FR 781519
 Memo : FM 88.1MHz Tx+ Satellite Radio 2
 SID : + Car Charge(12v)
 : 019413613622

	Freq	Level	Over Limit	Limit	Antenna Line Factor	Cable Loss	Preamp Factor	Ant Pos	Table Pos	Remark
	MHz	dBuV/m	dB	dBuV/m	dB/m	dB	dB	cm	deg	
1 @	88.0	12.67	-27.33	40.00	8.73	1.03	31.12	---	---	Peak



High channel_107.9 MHz (Horizontal)

Date: 2007-09-06

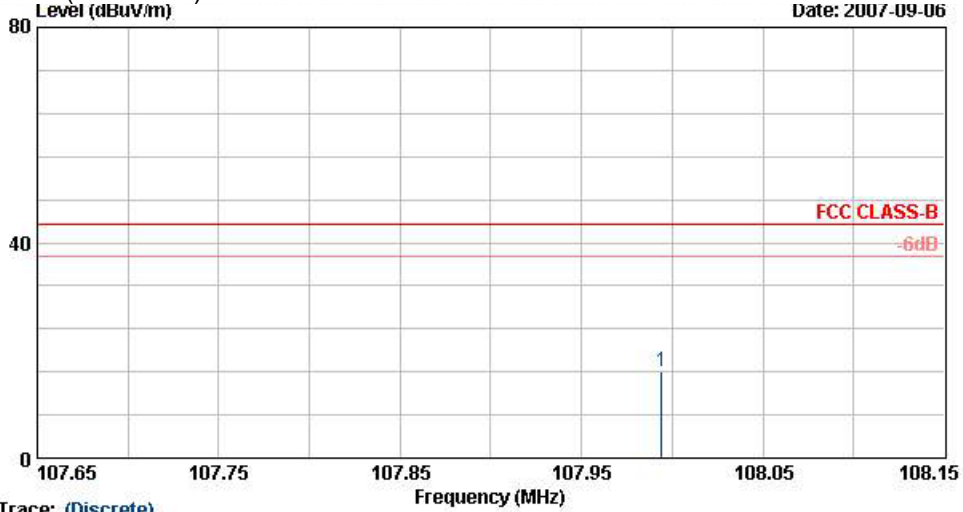

Trace: (Discrete)

Site : 08CH06-HY
 Condition : LF-ANT(951121) HORIZONTAL
 EUT : Satellite Radio
 Power : 12 Vdc
 Model : FR 781519
 Memo : FM 107.9MHz Tx+ Satellite Radio 2
 Memo : + Car Charger(12v)
 SID : 019413613622

	Freq	Level	Over Limit	Limit	Antenna Line Factor	Cable Loss	Preamp Factor	Ant Pos	Table Pos	Remark
	MHz	dBuV/m	dB	dBuV/m	dB/m	dB	dB	cm	deg	
1 @	108.0	15.93	-27.57	43.50	11.60	1.10	31.06	---	---	Peak



High channel_107.9 MHz (Vertical)

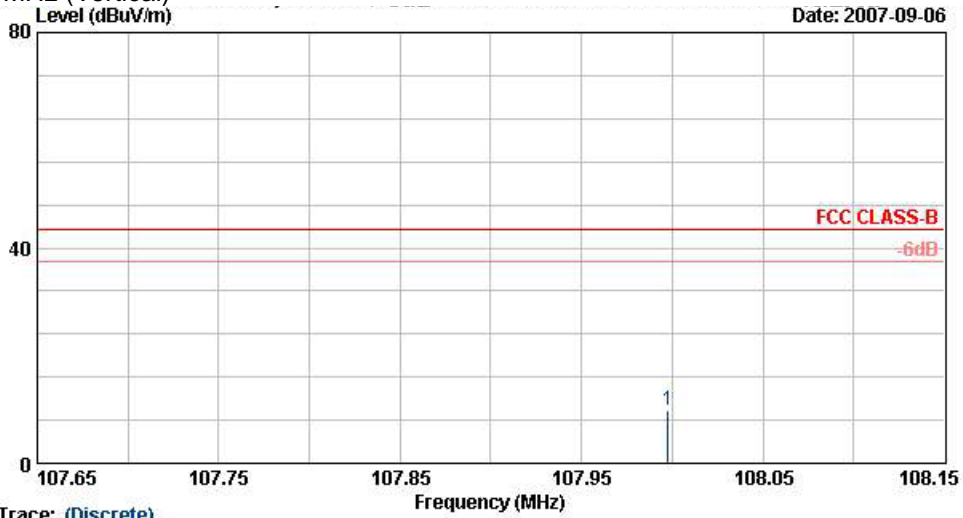

Trace: (Discrete)

Site : 08CH06-HY
 Condition : LP-ANT(951121) VERTICAL
 EUT : Satellite Radio
 Power : 12 Vdc
 Model : FR 781519
 Memo : FM 107.9MHz Tx+ Satellite Radio 2
 + Car Charge(12v)
 SID : 019413613622

	Freq	Level	Over Limit	Limit	Antenna Line Factor	Cable Loss	Preamp Factor	Ant Pos	Table Pos	Remark
	MHz	dBuV/m	dB	dBuV/m	dB/m	dB	dB	cm	deg	
1 @	108.0	9.71	-33.79	43.50	11.60	1.10	31.06	---	---	Peak



5.3 20dBc and Field Strength

5.3.1 Measuring Instruments

As described in chapter 6 of this Report.

5.3.2 Test Description

The field strength of any emissions within the permitted 200 kHz shall not exceed 48 dBuV/m at 3 meters. The emission limit in this paragraph is based on measurement instrumentation employing an average detector.

We show 20dBc bandwidth and field strength for each mode in following test data section

5.3.3 Test Data

- Mode 1
- RBW = 10 kHz
- VBW=30 kHz

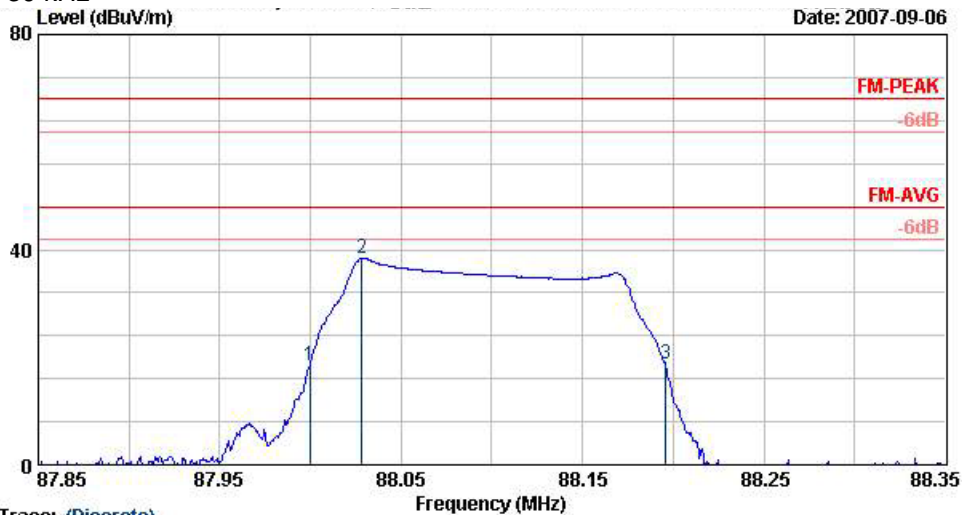

Trace: (Discrete)

Site : 08CH06-HY
 Condition : LF-ANT(951121) HORIZONTAL
 EUT : Satellite Radio
 Power : 12 Vdc
 Model : FR 781519
 Memo : FM 88.1MHz Tx+ Satellite Radio 2+ FEA
 Memo : + Car Charger(12v)
 SID : 019413613622

	Freq	Level	Over	Limit	Antenna	Cable	Preamp	Ant	Table	Remark
	MHz	dBuV/m	dB	dBuV/m	dB/m	dB	dB	cm	deg	
1	88.0	18.52	-49.48	68.00	8.73	1.03	31.12	---	---	Peak
2 @	88.0	38.47	-29.53	68.00	8.73	1.03	31.12	---	---	Peak
3	88.2	18.70	-49.30	68.00	8.73	1.03	31.12	---	---	Peak

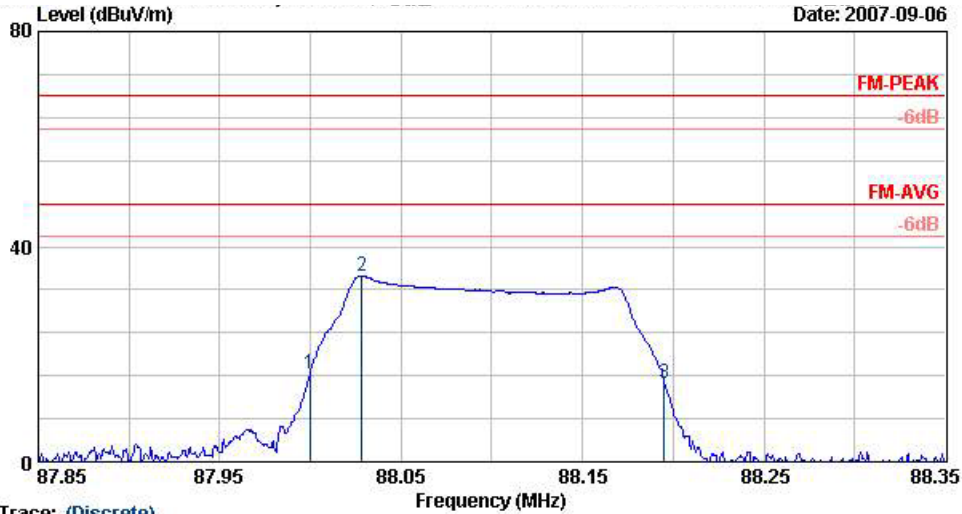

Trace: (Discrete)

Site : 06CH06-HY
 Condition : LP-ANT(951121) VERTICAL
 EUT : Satellite Radio
 Power : 12 Vdc
 Model : FR 781519
 Memo : FM 88.1MHz Tx+ Satellite Radio 2 + FEA
 Memo : + Car Charger(12v)
 SID : 019413613622

	Freq	Level	Over	Limit	Antenna	Cable	Preamp	Ant	Table	Remark
	MHz	dBuV/m	dB	dBuV/m	dB/m	dB	dB	cm	deg	
1	88.0	16.43	-51.57	68.00	8.73	1.03	31.12	---	---	Peak
2	88.0	34.60	-33.40	68.00	8.73	1.03	31.12	---	---	Peak
3	88.2	14.69	-53.31	68.00	8.73	1.03	31.12	---	---	Peak



- RBW = 120 kHz
- VBW=300 kHz

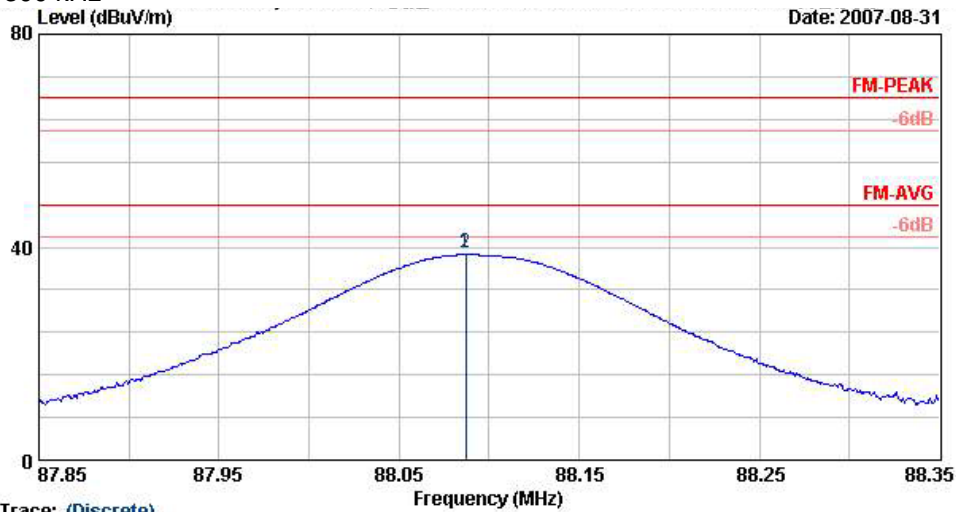

Trace: (Discrete)
 Site : 08CH06-HY
 Condition : LP-ANT(951121) HORIZONTAL
 EUT : Satellite Radio
 Power : 12 Vdc
 Model : FR 781519
 Memo : FM 88.1MHz Tx+ Satellite Radio 2 + FEA
 Memo : + Car Charge(12v)
 SID : 019413613622

	Freq	Level	Over	Limit	Antenna	Cable	Preamp	Ant	Table	Remark
	MHz	dBuV/m	dB	dBuV/m	dB/m	dB	dB	cm	deg	
1	88.1	38.92	-29.08	68.00	8.73	1.03	31.12	---	---	Peak
2 @	88.1	38.83	-9.17	48.00	8.73	1.03	31.12	376	335	Average

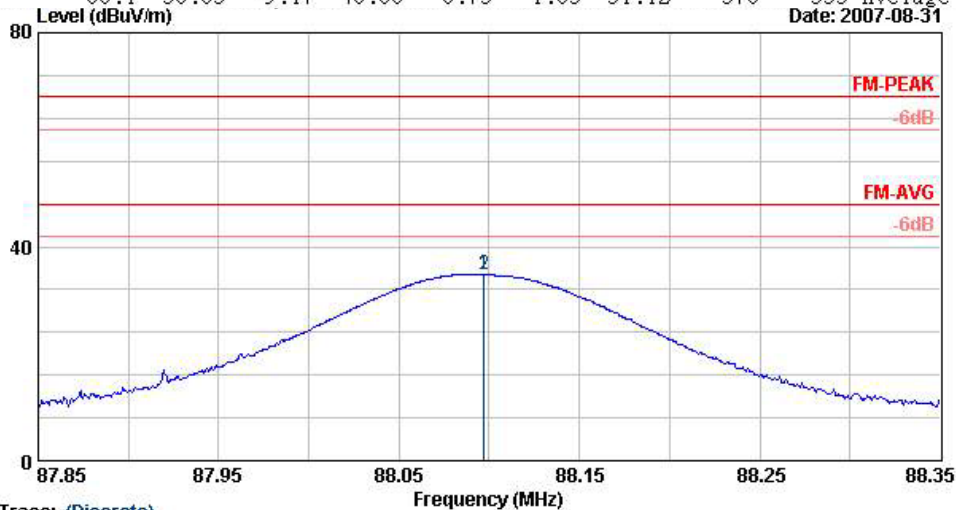

Trace: (Discrete)
 Site : 08CH06-HY
 Condition : LP-ANT(951121) VERTICAL
 EUT : Satellite Radio
 Power : 12 Vdc
 Model : FR 781519
 Memo : FM 88.1MHz Tx+ Satellite Radio 2 + FEA
 Memo : + Car Charge(12v)
 SID : 019413613622

	Freq	Level	Over	Limit	Antenna	Cable	Preamp	Ant	Table	Remark
	MHz	dBuV/m	dB	dBuV/m	dB/m	dB	dB	cm	deg	
1	88.1	34.85	-33.15	68.00	8.73	1.03	31.12	---	---	Peak
2 @	88.1	34.83	-13.17	48.00	8.73	1.03	31.12	314	92	Average



- Mode 2
- RBW = 10 kHz
- VBW=30 kHz

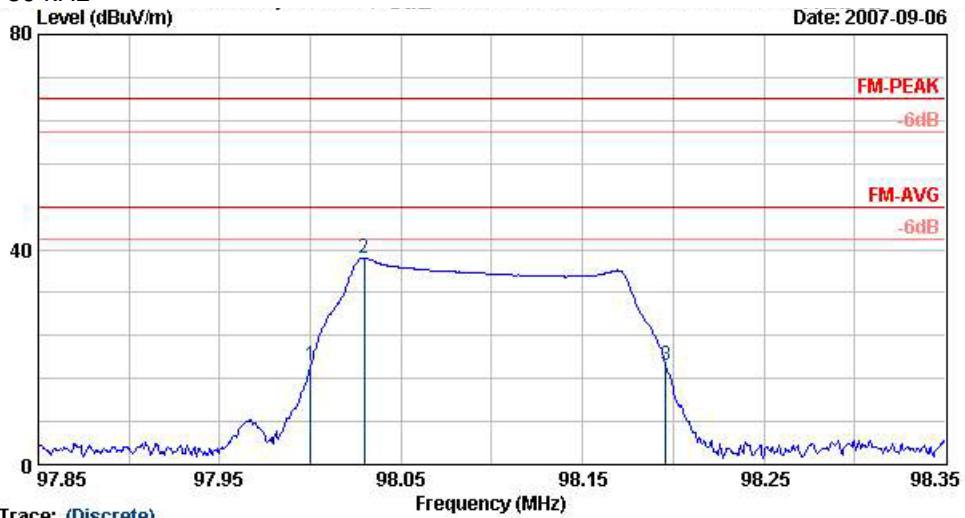

Trace: (Discrete)

Site : 03CH06-HY
 Condition : LP-ANT(951121) HORIZONTAL
 EUT : Satellite Radio
 Power : 12 Vdc
 Model : FR 781519
 Memo : FM 98.1MHz Tx+ Satellite Radio 2 + FEA
 Memo : + Car Charger(12v)
 SID : 019413613622

	Freq	Level	Over	Limit	Antenna	Cable	Preamp	Ant	Table	Remark
	MHz	dBuV/m	dB	dBuV/m	dB/m	dB	dB	cm	deg	
1	98.0	18.46	-49.54	68.00	10.60	1.06	31.12	---	---	Peak
2 @	98.0	38.38	-29.62	68.00	10.60	1.06	31.12	---	---	Peak
3	98.2	18.43	-49.57	68.00	10.60	1.06	31.12	---	---	Peak

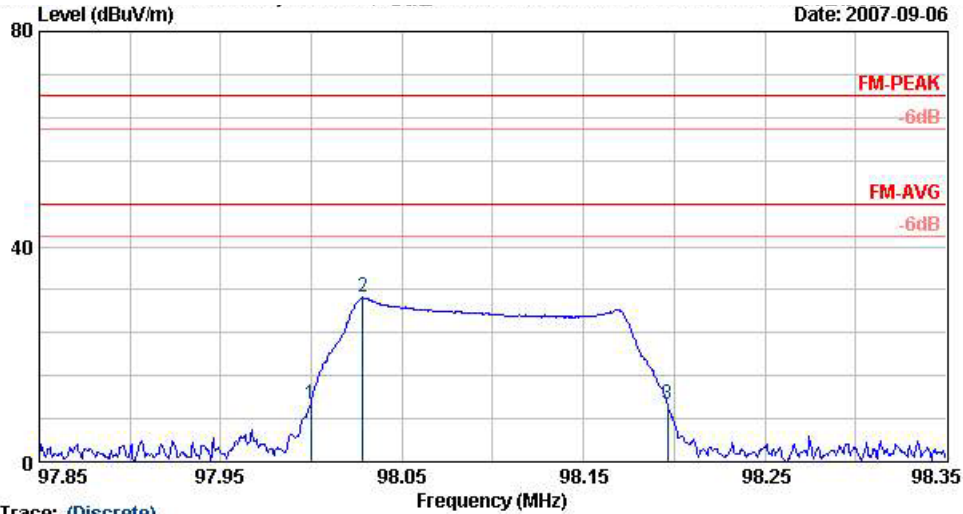

Trace: (Discrete)

Site : 06CH06-HY
 Condition : LP-ANT(951121) VERTICAL
 EUT : Satellite Radio
 Power : 12 Vdc
 Model : FR 781519
 Memo : FM 98.1MHz Tx+ Satellite Radio 2 + FEA
 Memo : + Car Charger(12v)
 SID : 019413613622

	Freq	Level	Over	Limit	Antenna	Cable	Preamp	Ant	Table	Remark
	MHz	dBuV/m	dB	dBuV/m	dB/m	dB	dB	cm	deg	
1	98.0	10.78	-57.22	68.00	10.60	1.06	31.12	---	---	Peak
2 @	98.0	30.49	-37.51	68.00	10.60	1.06	31.12	---	---	Peak
3	98.2	10.58	-57.42	68.00	10.60	1.06	31.12	---	---	Peak



- RBW = 120 kHz
- VBW=300 kHz

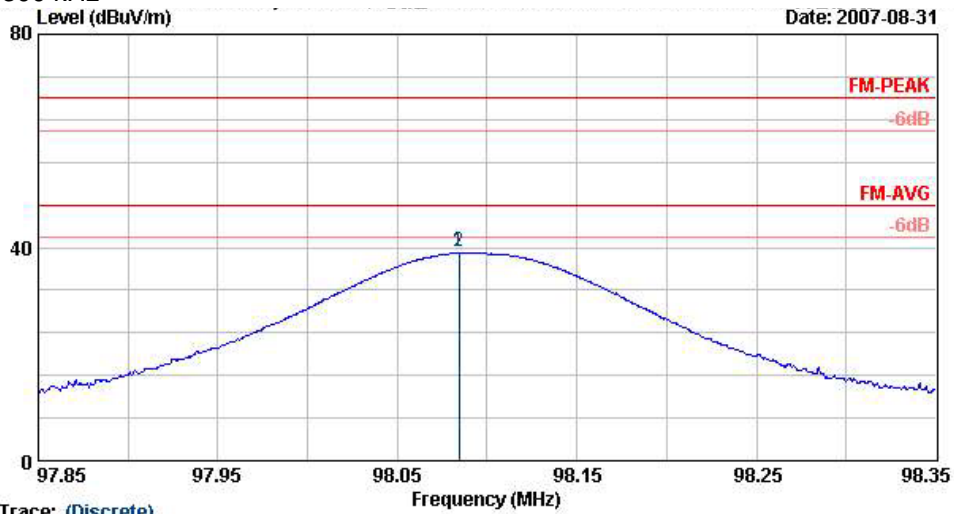

Trace: (Discrete)
 Site : 03CH06-HY
 Condition : LF-ANT(951121) HORIZONTAL
 EUT : Satellite Radio
 Power : 12 Vdc
 Model : FR 781519
 Memo : FM 98.1MHz Tx+ Satellite Radio 2 + FEA
 Memo : + Car Charger(L2v)
 SID : 019413613622

	Freq	Level	Over	Limit	Antenna	Cable	Preamp	Ant	Table	Remark
	MHz	dBuV/m	dB	dBuV/m	dB/m	dB	dB	cm	deg	
1	98.1	39.31	-28.69	68.00	10.60	1.06	31.12	---	---	Peak
2 @	98.1	39.13	-8.87	48.00	10.60	1.06	31.12	241	194	Average

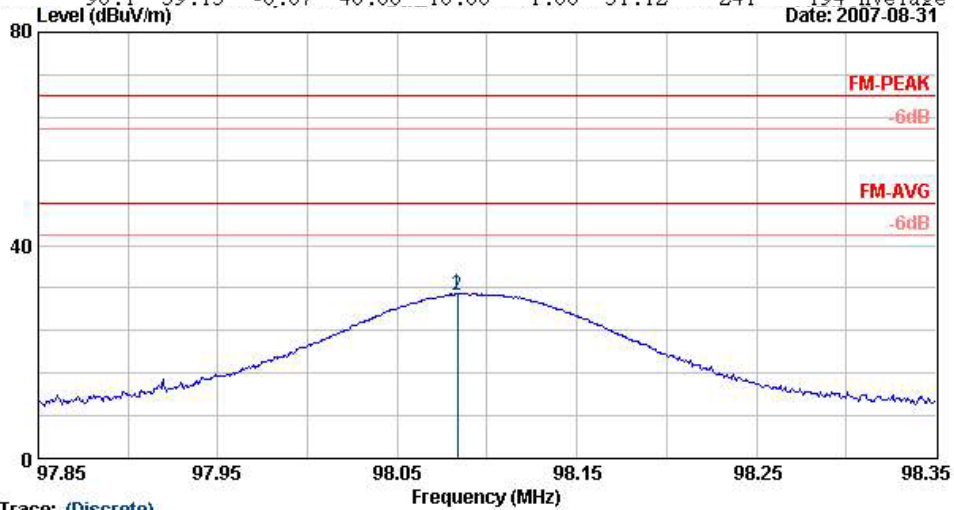

Trace: (Discrete)
 Site : 03CH06-HY
 Condition : LF-ANT(951121) VERTICAL
 EUT : Satellite Radio
 Power : 12 Vdc
 Model : FR 781519
 Memo : FM 98.1MHz Tx+ Satellite Radio 2 + FEA
 Memo : + Car Charger(L2v)
 SID : 019413613622

	Freq	Level	Over	Limit	Antenna	Cable	Preamp	Ant	Table	Remark
	MHz	dBuV/m	dB	dBuV/m	dB/m	dB	dB	cm	deg	
1	98.1	30.88	-37.12	68.00	10.60	1.06	31.12	---	---	Peak
2 @	98.1	30.63	-17.37	48.00	10.60	1.06	31.12	100	297	Average



- Mode 3
- RBW = 10 kHz
- VBW=30 kHz

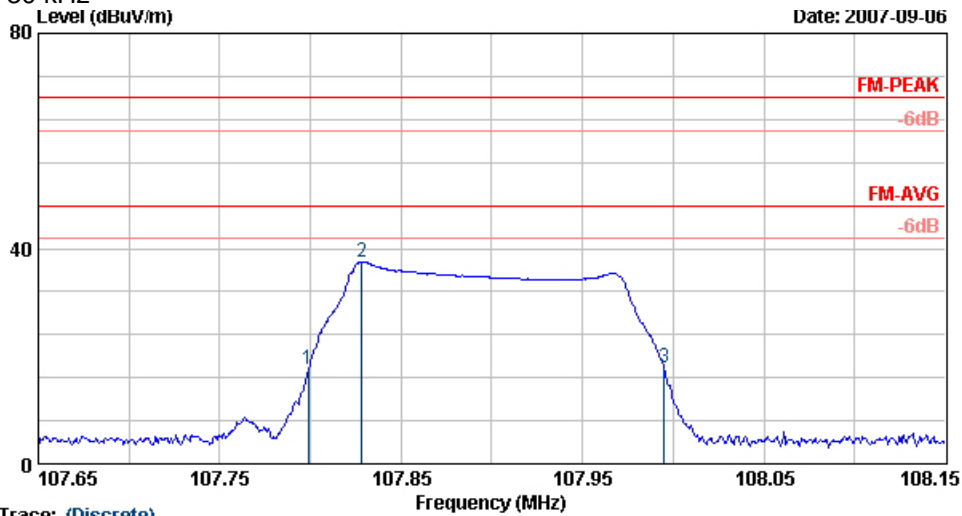

Site : 08CH06-HY
 Condition : LP-ANT(951121) HORIZONTAL
 EUT : Satellite Radio
 Power : 12 Vdc
 Model : FR 781519
 Memo : FM 107.9MHz Tx+ Satellite Radio 2+ FEA
 Memo : + FEA
 SID : 019413613622

	Freq	Level	Over Limit	Limit Line	ReadAntenna Level	Antenna Factor	Cable Loss	Preamp Factor	Ant Pos	Table Pos	Remark
	MHz	dBuV/m	dB	dBuV/m	dBuV	dB/m	dB	dB	cm	deg	
1	107.8	17.61	-50.39	68.00	35.96	11.60	1.10	31.06	---	---	Peak
2 @	107.8	37.57	-30.43	68.00	55.93	11.60	1.10	31.06	---	---	Peak
3	108.0	17.74	-50.26	68.00	36.09	11.60	1.10	31.06	---	---	Peak

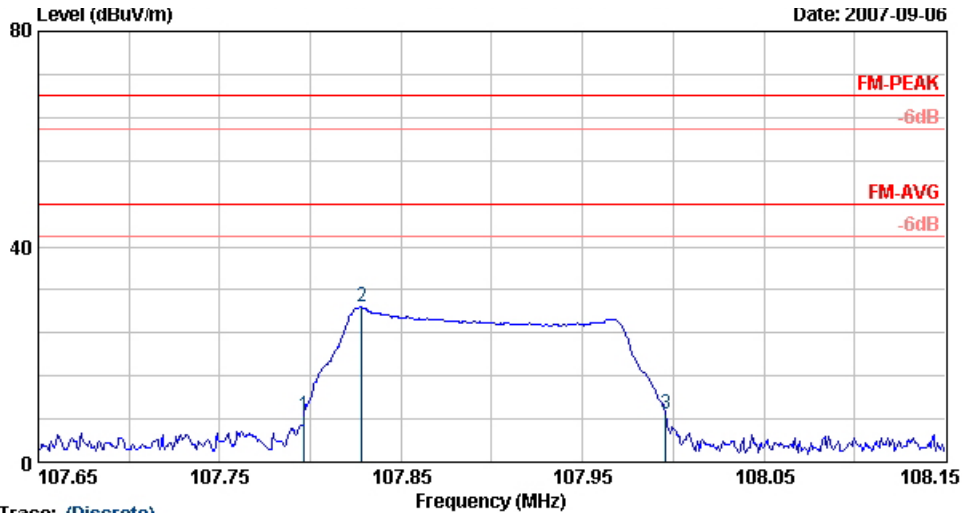

Trace: (Discrete)

Site : 08CH06-HY
 Condition : LP-ANT(951121) VERTICAL
 EUT : Satellite Radio
 Power : 12 Vdc
 Model : FR 781519
 Memo : FM 107.9MHz Tx+ Satellite Radio 2+ FEA
 Memo : + FEA
 SID : 019413613622

	Freq	Level	Over	Limit	ReadAntenna	Cable	Preamp	Ant	Table	Remark
	MHz	dBuV/m	Limit	Line	Level	Loss	Factor	Pos	Pos	
			dB	dBuV/m	dBuV	dB	dB	cm	deg	
1	107.8	8.76	-59.24	68.00	27.12	11.60	1.10	31.06	---	Peak
2	107.8	28.74	-39.26	68.00	47.10	11.60	1.10	31.06	---	Peak
3	108.0	8.93	-59.07	68.00	27.28	11.60	1.10	31.06	---	Peak



- RBW = 120 kHz
- VBW=300 kHz

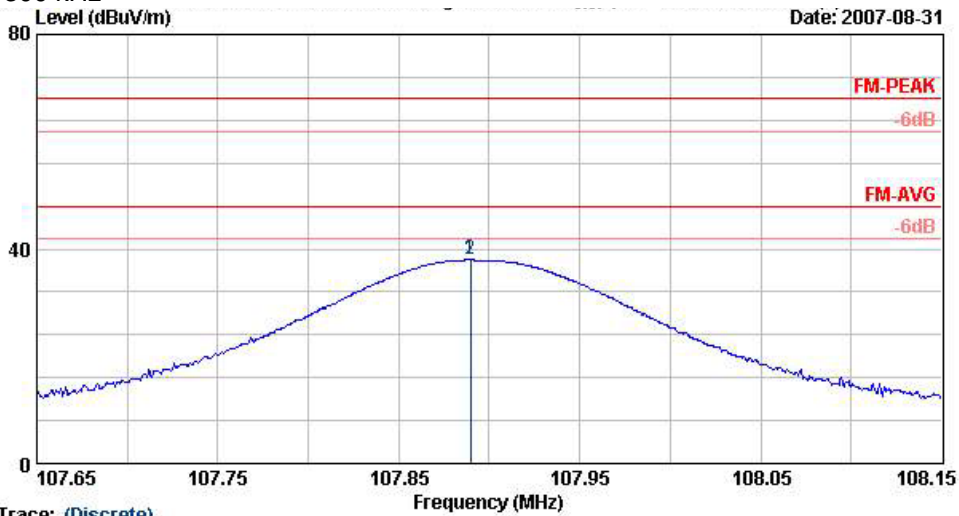

Trace: (Discrete)
 Site : 03CH06-HY
 Condition : LF-ANT(951121) HORIZONTAL
 EUT : Satellite Radio
 Power : 12 Vdc
 Model : FR 781519
 Memo : FM 107.9MHz Tx+ Satellite Radio 2+ FEA
 Memo : + Car Charger(12v)
 SID : 019413613622

	Freq	Level	Over Limit	Limit	Antenna Line Factor	Cable Loss	Preamp Factor	Ant Pos	Table Pos	Remark
	MHz	dBuV/m	dB	dBuV/m	dB/m	dB	dB	cm	deg	
1	107.9	38.21	-29.79	68.00	11.60	1.10	31.06	---	---	Peak
2 @	107.9	38.14	-9.86	48.00	11.60	1.10	31.06	258	355	Average

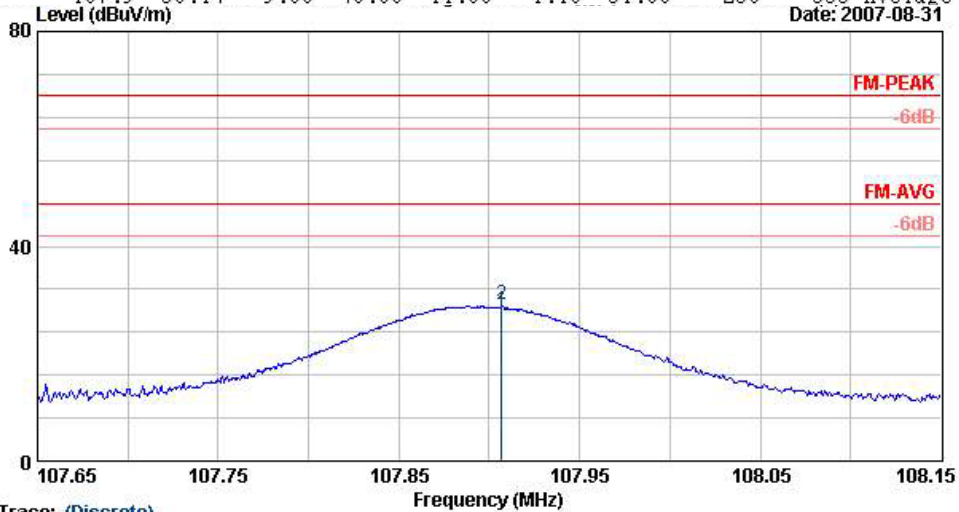

Trace: (Discrete)
 Site : 03CH06-HY
 Condition : LF-ANT(951121) VERTICAL
 EUT : Satellite Radio
 Power : 12 Vdc
 Model : FR 781519
 Memo : FM 107.9MHz Tx+ Satellite Radio 2+ FEA
 Memo : + Car Charger(12v)
 SID : 019413613622

	Freq	Level	Over Limit	Limit	Antenna Line Factor	Cable Loss	Preamp Factor	Ant Pos	Table Pos	Remark
	MHz	dBuV/m	dB	dBuV/m	dB/m	dB	dB	cm	deg	
1	107.9	28.04	-19.96	48.00	11.60	1.10	31.06	224	360	Average
2	107.9	29.15	-38.85	68.00	11.60	1.10	31.06	---	---	Peak



- Mode 4
- RBW = 10 kHz
- VBW=30 kHz

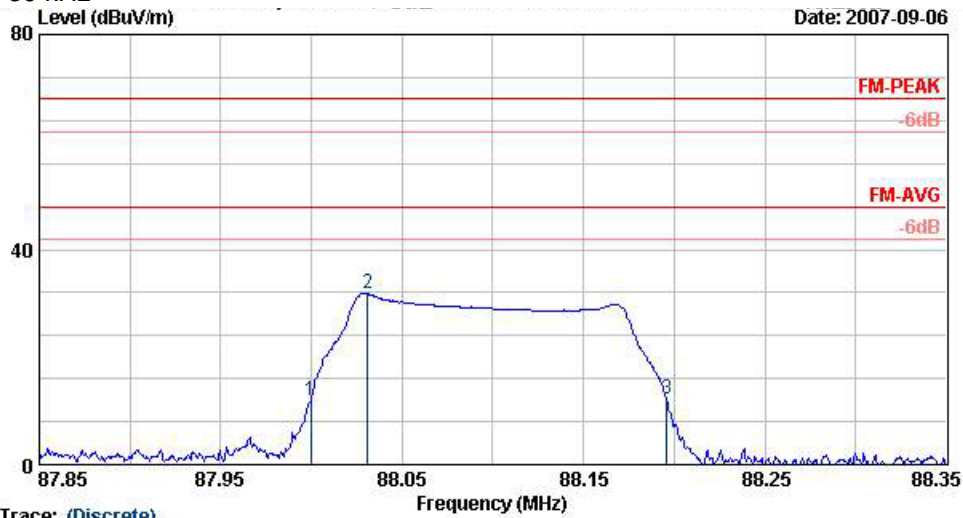

Trace: (Discrete)

Site : 03CH06-HY
 Condition : LP-ANT(951121) HORIZONTAL
 EUT : Satellite Radio
 Power : 12 Vdc
 Model : FR 781519
 Memo : FM 88.1MHz Tx+ Satellite Radio 2
 SID : + Car Charger(12v)
 : 019413613622

	Freq	Level	Over	Limit	Antenna	Cable	Preamp	Ant	Table	Remark
	MHz	dBuV/m	dB	dBuV/m	dB/m	dB	dB	cm	deg	
1	88.0	12.01	-55.99	68.00	8.73	1.03	31.12	---	---	Peak
2	88.0	31.91	-36.09	68.00	8.73	1.03	31.12	---	---	Peak
3	88.2	12.13	-55.87	68.00	8.73	1.03	31.12	---	---	Peak

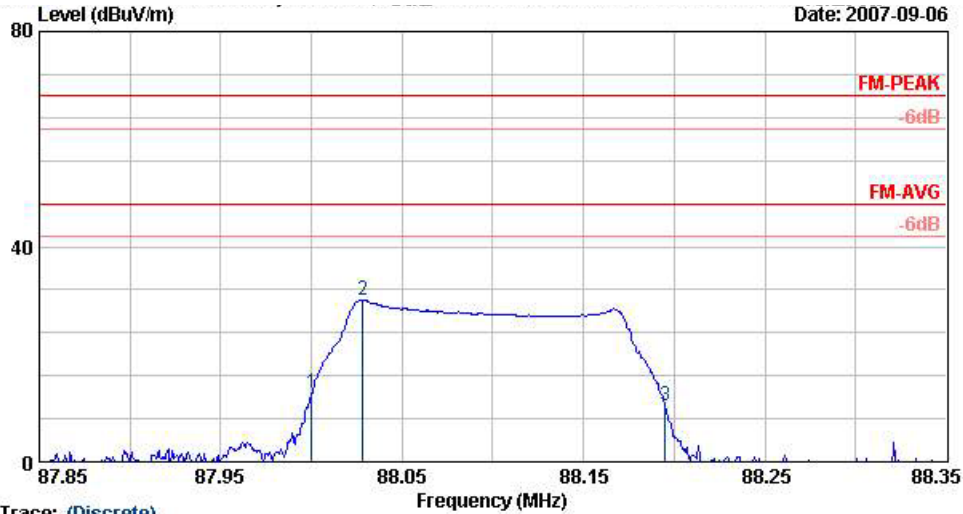

Trace: (Discrete)

Site : 06CH06-HY
 Condition : LP-ANT(951121) VERTICAL
 EUT : Satellite Radio
 Power : 12 Vdc
 Model : FR 781519
 Memo : FM 88.1MHz Tx+ Satellite Radio 2
 SID : + Car Charger(12v)
 : 019413613622

	Freq	Level	Over Limit	Limit Line	Antenna Factor	Cable Loss	Preamp Factor	Ant Pos	Table Pos	Remark
	MHz	dBuV/m	dB	dBuV/m	dB/m	dB	dB	cm	deg	
1	88.0	12.67	-55.33	68.00	8.73	1.03	31.12	---	---	Peak
2	88.0	30.09	-37.91	68.00	8.73	1.03	31.12	---	---	Peak
3	88.2	10.38	-57.62	68.00	8.73	1.03	31.12	---	---	Peak



- RBW = 120 kHz
- VBW=300 kHz

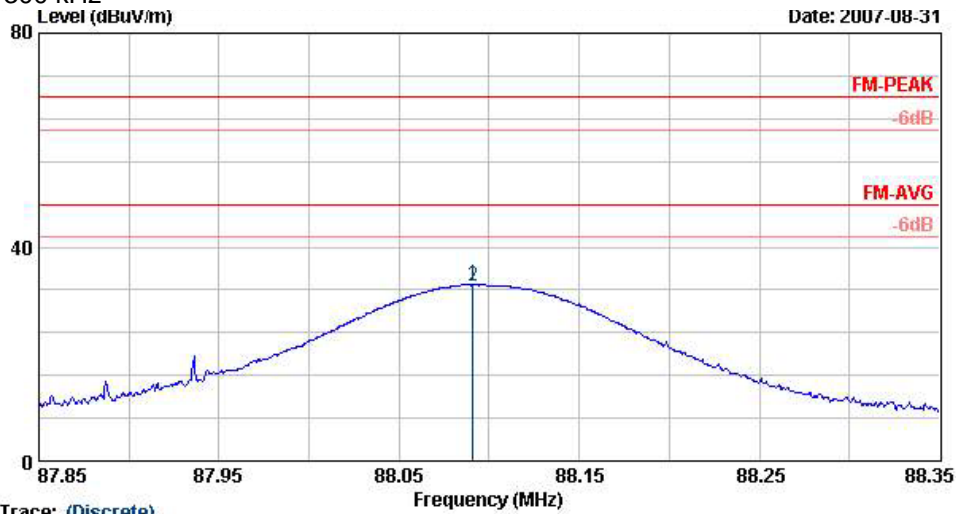

Trace: (Discrete)
 Site : 08CH06-HY
 Condition : LP-ANT(951121) HORIZONTAL
 EUT : Satellite Radio
 Power : 12 Vdc
 Model : FR 781519
 Memo : FM 88.1MHz Tx+ Satellite Radio 2
 SID : + Car Charge(12v)
 019413613622

	Freq	Level	Over Limit	Limit	Antenna Line Factor	Cable Loss	Preamp Factor	Ant Pos	Table Pos	Remark
	MHz	dBuV/m	dB	dBuV/m	dB/m	dB	dB	cm	deg	
1	88.1	32.98	-35.02	68.00	8.73	1.03	31.12	---	---	Peak
2 @	88.1	32.73	-15.27	48.00	8.73	1.03	31.12	388	64	Average

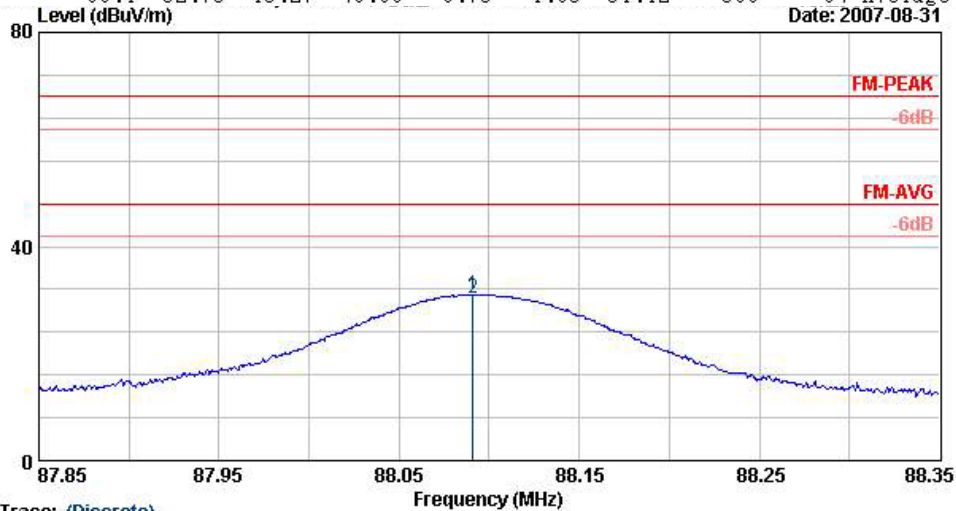

Trace: (Discrete)
 Site : 08CH06-HY
 Condition : LP-ANT(951121) VERTICAL
 EUT : Satellite Radio
 Power : 12 Vdc
 Model : FR 781519
 Memo : FM 88.1MHz Tx+ Satellite Radio 2
 SID : + Car Charge(12v)
 019413613622

	Freq	Level	Over Limit	Limit	Antenna Line Factor	Cable Loss	Preamp Factor	Ant Pos	Table Pos	Remark
	MHz	dBuV/m	dB	dBuV/m	dB/m	dB	dB	cm	deg	
1	88.1	31.03	-36.97	68.00	8.73	1.03	31.12	---	---	Peak
2 @	88.1	30.43	-17.57	48.00	8.73	1.03	31.12	131	49	Average



- Mode 5
- RBW = 10 kHz
- VBW=30 kHz

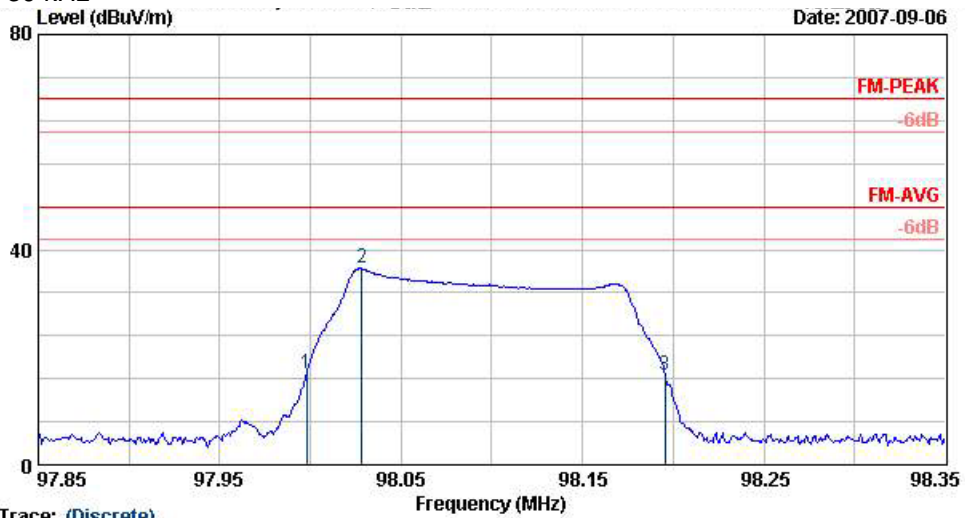

Trace: (Discrete)

Site : 03CH06-HY
 Condition : LP-ANT(951121) HORIZONTAL
 EUT : Satellite Radio
 Power : 12 Vdc
 Model : FR 781519
 Memo : FM 98.1MHz Tx+ Satellite Radio 2
 SID : + Car Charger(12v)
 : 019413613622

	Freq	Level	Over Limit	Limit	Antenna Line Factor	Cable Loss	Preamp Factor	Ant Pos	Table Pos	Remark
	MHz	dBuV/m	dB	dBuV/m	dB/m	dB	dB	cm	deg	
1	98.0	16.92	-51.08	68.00	10.60	1.06	31.12	---	---	Peak
2 @	98.0	36.48	-31.52	68.00	10.60	1.06	31.12	---	---	Peak
3	98.2	16.79	-51.21	68.00	10.60	1.06	31.12	---	---	Peak

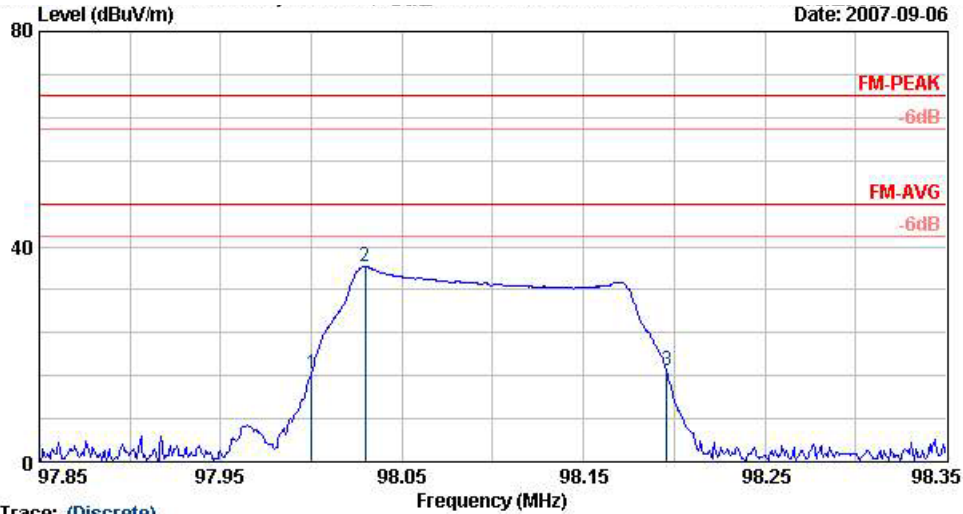

Trace: (Discrete)

Site : 08CH06-HY
 Condition : LP-ANT(951121) VERTICAL
 EUT : Satellite Radio
 Power : 12 Vdc
 Model : FR 781519
 Memo : FM 98.1MHz Tx+ Satellite Radio 2
 SID : + Car Charger(12v)
 : 019413613622

	Freq	Level	Over Limit	Limit	Antenna Line Factor	Cable Loss	Preamp Factor	Ant Pos	Table Pos	Remark
	MHz	dBuV/m	dB	dBuV/m	dB/m	dB	dB	cm	deg	
1	98.0	16.45	-51.55	68.00	10.60	1.06	31.12	---	---	Peak
2 @	98.0	36.30	-31.70	68.00	10.60	1.06	31.12	---	---	Peak
3	98.2	16.90	-51.10	68.00	10.60	1.06	31.12	---	---	Peak



- RBW = 120 kHz
- VBW=300 kHz

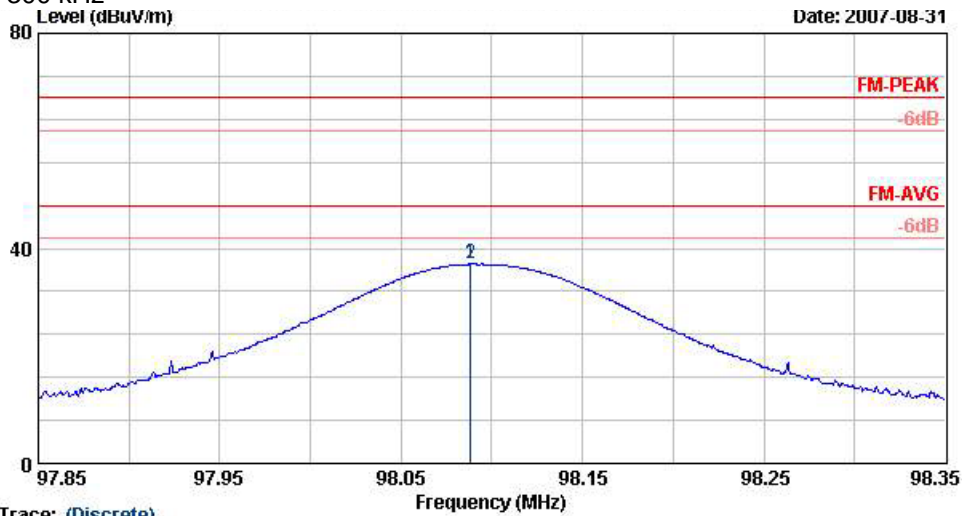

Trace: (Discrete)
 Site : 08CH06-HY
 Condition : LP-ANT(951121) HORIZONTAL
 EUT : Satellite Radio
 Power : 12 Vdc
 Model : FR 781519
 Memo : FM 98.1MHz Tx+ Satellite Radio 2
 SID : + Car Charger(12v)
 : 019413613622

	Freq	Level	Over	Limit	Antenna	Cable	Preamp	Ant	Table	Remark
	MHz	dBuV/m	dB	dBuV/m	dB/m	dB	dB	cm	deg	
1	98.1	37.14	-30.86	68.00	10.60	1.06	31.12	---	---	Peak
2 @	98.1	37.03	-10.97	48.00	10.60	1.06	31.12	236	100	Average

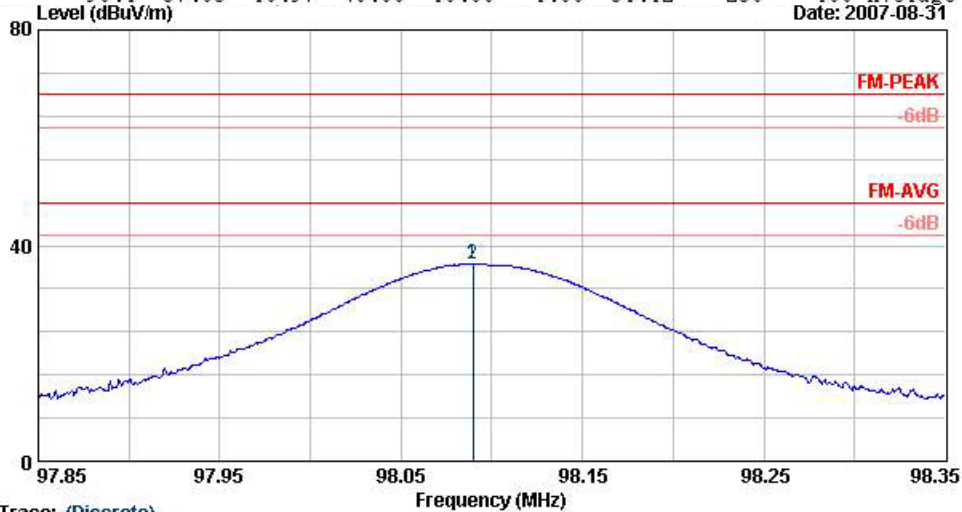

Trace: (Discrete)
 Site : 08CH06-HY
 Condition : LP-ANT(951121) VERTICAL
 EUT : Satellite Radio
 Power : 12 Vdc
 Model : FR 781519
 Memo : FM 98.1MHz Tx+ Satellite Radio 2
 SID : + Car Charger(12v)
 : 019413613622

	Freq	Level	Over	Limit	Antenna	Cable	Preamp	Ant	Table	Remark
	MHz	dBuV/m	dB	dBuV/m	dB/m	dB	dB	cm	deg	
1	98.1	36.71	-31.29	68.00	10.60	1.06	31.12	---	---	Peak
2	98.1	36.63	-11.37	48.00	10.60	1.06	31.12	108	333	Average



- Mode 6
- RBW = 10 kHz
- VBW=30 kHz

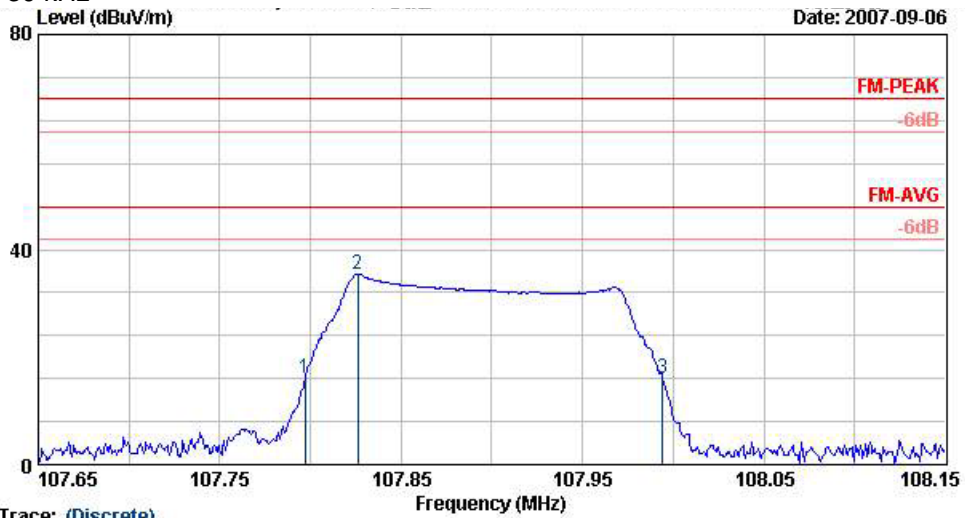

Trace: (Discrete)

Site : 03CH06-HY
 Condition : LP-ANT(951121) HORIZONTAL
 EUT : Satellite Radio
 Power : 12 Vdc
 Model : FR 781519
 Memo : FM 107.9MHz Test Satellite Radio 2
 Memo : + Car Charger(12v)
 SID : 019413613622

	Freq	Level	Over Limit	Limit	Antenna Line Factor	Cable Loss	Preamp Factor	Ant Pos	Table Pos	Remark
	MHz	dBuV/m	dB	dBuV/m	dB/m	dB	dB	cm	deg	
1	107.8	16.11	-51.89	68.00	11.60	1.10	31.06	---	---	Peak
2 @	107.8	35.46	-32.54	68.00	11.60	1.10	31.06	---	---	Peak
3	108.0	15.93	-52.07	68.00	11.60	1.10	31.06	---	---	Peak

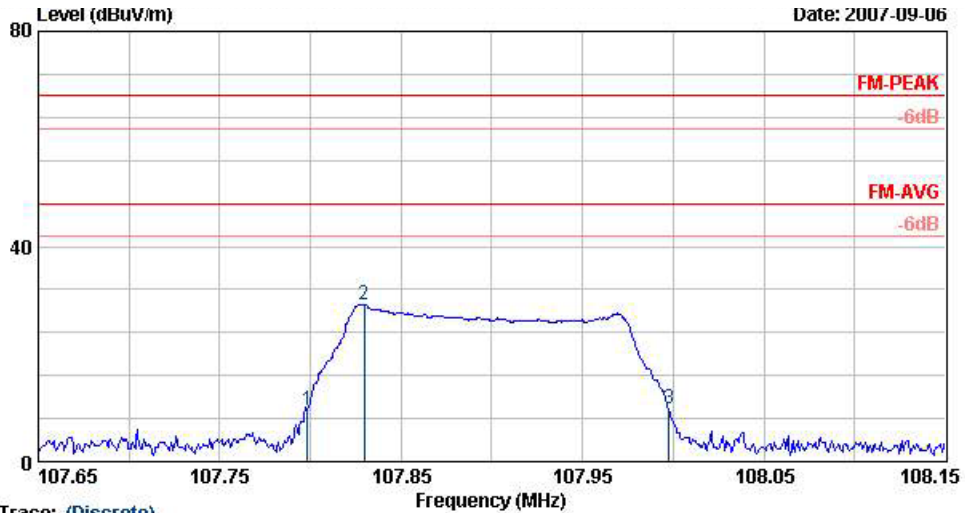

Trace: (Discrete)

Site : 08CH06-HY
 Condition : LP-ANT(951121) VERTICAL
 EUT : Satellite Radio
 Power : 12 Vdc
 Model : FR 781519
 Memo : FM 107.9MHz Test Satellite Radio 2
 Memo : + Car Charger(12v)
 SID : 019413613622

	Freq	Level	Over	Limit	Antenna	Cable	Preamp	Ant	Table	Remark
	MHz	dBuV/m	dB	dBuV/m	dB/m	dB	dB	cm	deg	
1	107.8	9.41	-58.59	68.00	11.60	1.10	31.06	---	---	Peak
2	107.8	29.23	-38.77	68.00	11.60	1.10	31.06	---	---	Peak
3	108.0	9.71	-58.29	68.00	11.60	1.10	31.06	---	---	Peak



- RBW = 120 kHz
- VBW=300 kHz

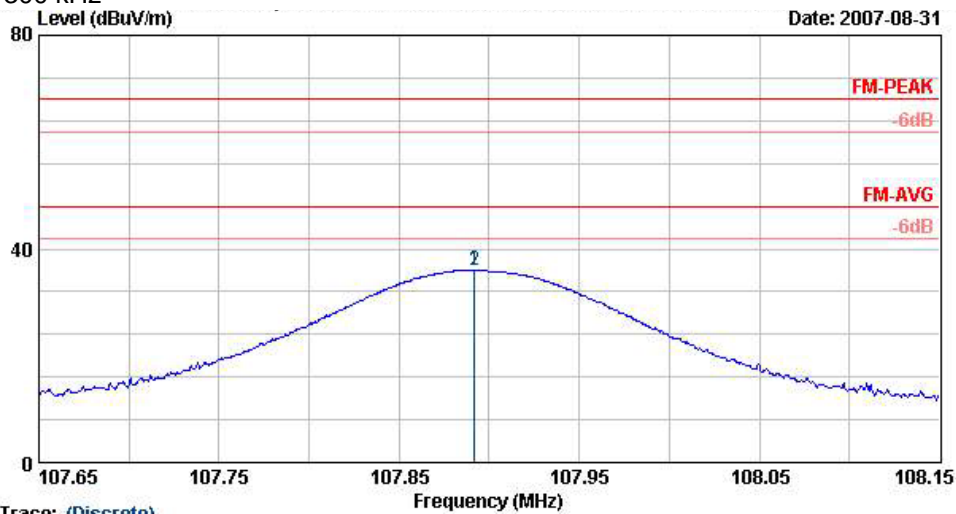

Trace: (Discrete)
 Site : 08CH06-HY
 Condition : LP-ANT(951121) HORIZONTAL
 EUT : Satellite Radio
 Power : 12 Vdc
 Model : FR 781519
 Memo : FM 107.9MHz Tx+ Satellite Radio 2
 SID : + Car Charger(12v)
 : 019413613622

	Freq	Level	Over	Limit	Antenna	Cable	Preamp	Ant	Table	Remark
	MHz	dBUV/m	dB	dBUV/m	dB/m	dB	dB	cm	deg	
1	107.9	36.03	-31.97	68.00	11.60	1.10	31.06	---	---	Peak
2 @	107.9	35.94	-12.06	48.00	11.60	1.10	31.06	156	90	Average

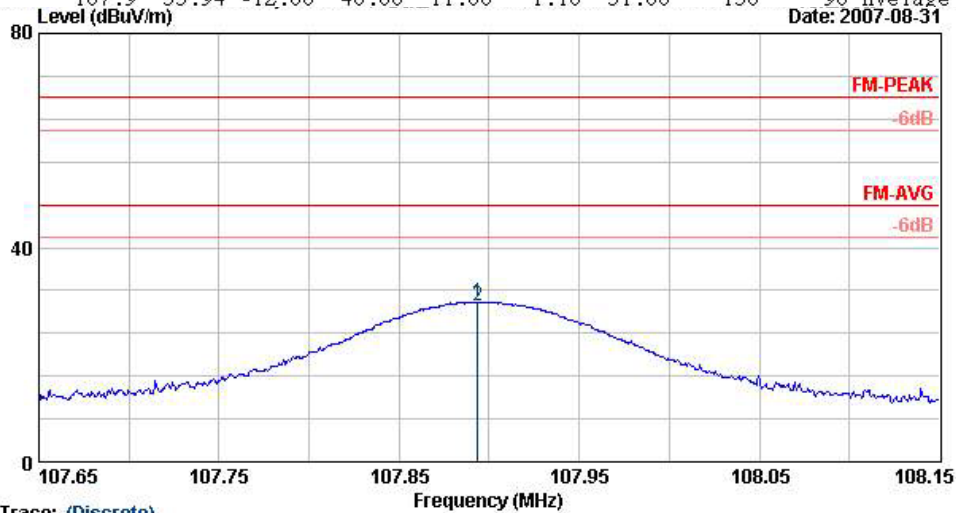

Trace: (Discrete)
 Site : 08CH06-HY
 Condition : LP-ANT(951121) VERTICAL
 EUT : Satellite Radio
 Power : 12 Vdc
 Model : FR 781519
 Memo : FM 107.9MHz Tx+ Satellite Radio 2
 SID : + Car Charger(12v)
 : 019413613622

	Freq	Level	Over	Limit	Antenna	Cable	Preamp	Ant	Table	Remark
	MHz	dBUV/m	dB	dBUV/m	dB/m	dB	dB	cm	deg	
1	107.9	29.88	-38.12	68.00	11.60	1.10	31.06	---	---	Peak
2 @	107.9	29.14	-18.86	48.00	11.60	1.10	31.06	105	351	Average



5.4 Radiated Emission Measurement

5.4.1 Measuring Instruments

As described in chapter 6 of this Report.

5.4.2 Test Procedures

1. The EUT was placed on a turntable with 0.8 meter above ground.
2. The EUT was set 3 meters from the interference receiving antenna which was mounted on the top of a variable height antenna tower.
3. The table was rotated 360 degrees to determine the position of the highest radiation.
4. The antenna is a broadband antenna and its height is varied between one meter and four meters above ground to find the maximum value of the field strength for both horizontal polarization and vertical polarization of the antenna.
5. For each suspected emission, the EUT was arranged to its worst case and then tune the antenna tower (from 1 m to 4 m) and turntable (from 0 degree to 360 degrees) to find the maximum reading.
6. Set the test-receiver system to Peak or CISPR quasi-peak Detect Function and specified bandwidth with Maximum Hold Mode.
7. For testing below 1GHz, If the emission level of the EUT in peak mode was 3 dB lower than the limit specified, then testing will be stopped and peak values of EUT will be reported, otherwise, the emissions will be repeated one by one using the quasi-peak method and reported.
8. For testing above 1GHz, the emission level of the EUT in peak mode was 20dB lower than average limit (that means the emission level in average mode also complies with the limit in average mode), then testing will be stopped and peak values of EUT will be reported, otherwise, the emissions will be measured in average mode again and reported.

5.4.3 Field Strength Limitation

The field strength of any emissions radiated on any frequency outside of the specified 200 kHz band shall not exceed the general radiated emission limits in section 15.209 as below.

Frequency (MHz)	Field Strength (uV/m)	Field Strength (dBuV/m)	Measurement Distance
30 ~ 88	100	40	3
88 ~ 216	150	43.5	3
216 ~ 960	200	46.0	3
Above 960	500	54.0	3

5.4.4 Typical Test Setup Layout of Radiated Emission

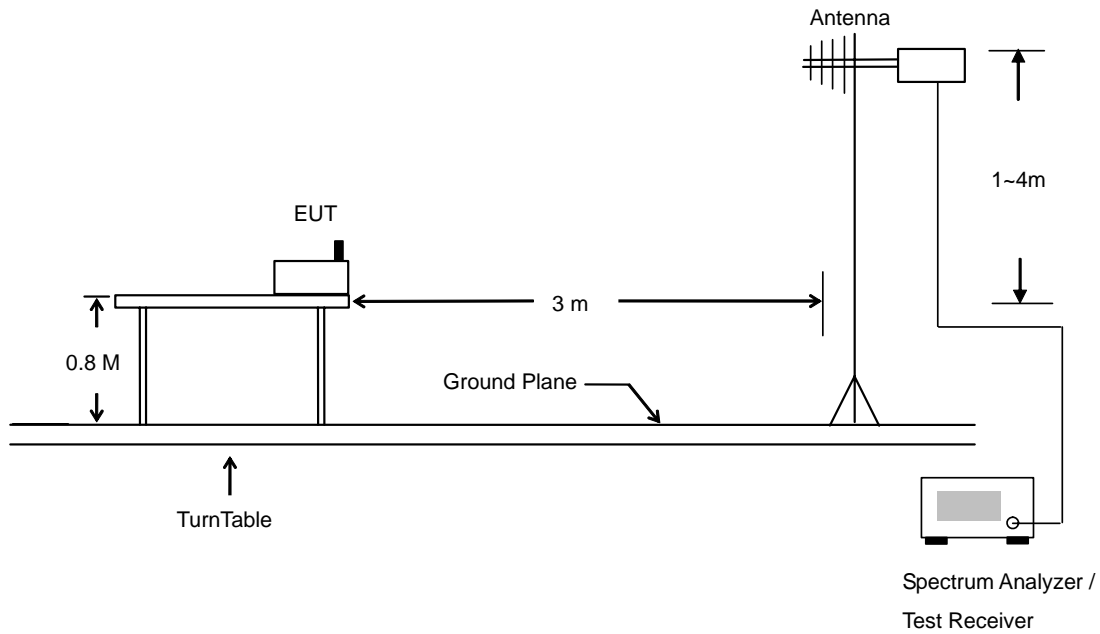



5.4.5 Test Data

- Temperature : 25~27°C
- Relative Humidity : 57~61%
- Test Engineer : Andrew
- Test Mode : Mode 1
- Polarization : Horizontal

The test that passed at the minimum margin was marked by the frame in the following test record

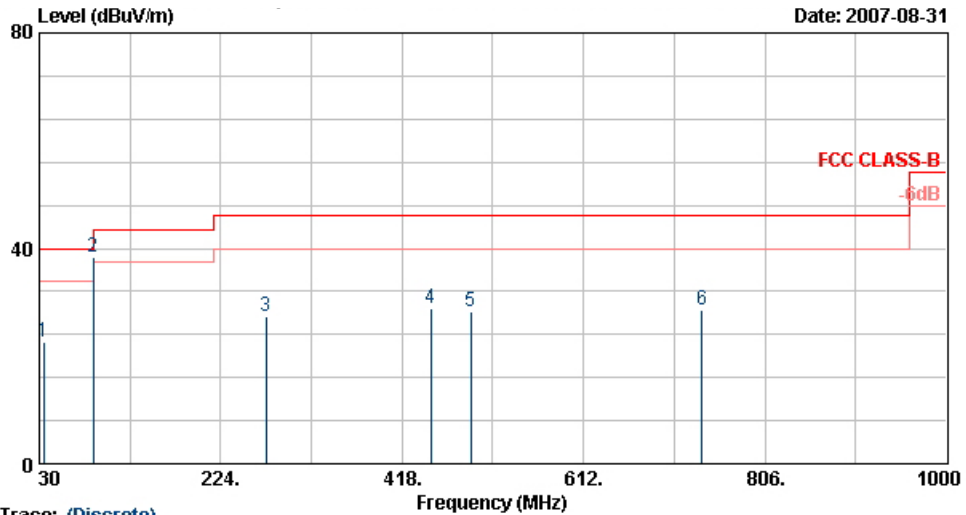

Trace: (Discrete)
 Site : 06CH06-HY
 Condition : LF-ANT(951121) HORIZONTAL
 EUT : Satellite Radio
 Power : 12 Wdc
 Model : FR 781519
 Memo : FM 88.1 MHz Tx+ Satellite Radio 2+ FEA
 : + FEA
 SID : 019413613622

Frequency (MHz)	Level (dBuV/m)	Over Limit (dB)	Limit Line (dBuV/m)	Read Level (dBuV)	Antenna Factor (dB)	Cable Loss (dB)	Preamp Factor (dB)	Ant Pos (cm)	Table Pos (deg)	Remark
34.59	22.56	-17.44	40.00	37.04	16.13	0.68	31.29	---	---	Peak
87.78	38.34	---	---	59.7	8.73	1.03	31.12	---	---	Peak
272.19	27.49	-18.51	46.00	43.94	12.69	1.82	30.96	---	---	Peak
448.4	28.95	-17.05	46.00	40.82	16.56	2.39	30.82	100	277	Peak
491.8	28.13	-17.87	46.00	39.07	17.29	2.57	30.80	---	---	Peak
738.9	28.42	-17.58	46.00	36.40	19.25	3.31	30.54	---	---	Peak

Remark: #2 is Fundamental Signal.



- Test Mode : Mode 1
- Polarization : Vertical

■ The test that passed at minimum margin was marked by the frame in the following table.

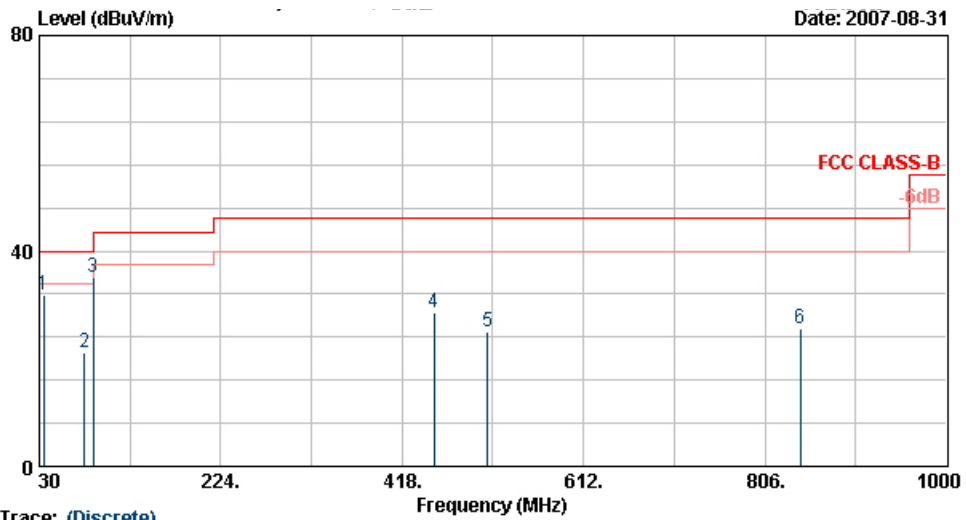

Trace: (Discrete)

Site : 09CH06-HY
 Condition : LP-ANT(951121) VERTICAL
 EUT : Satellite Radio
 Power : 12 Wdc
 Model : FR 781519
 Memo : FM 88.1 MHz Test Satellite Radio 2 + FEA
 : + FEA
 SID : 019413613622

Frequency (MHz)	Level (dBuV/m)	Over Limit (dB)	Limit Line (dBuV/m)	Read Level (dBuV)	Antenna Factor (dB)	Cable Loss (dB)	Preamp Factor (dB)	Ant Pos (cm)	Table Pos (deg)	Remark
34.6	31.76	-8.24	40.00	46.24	16.13	0.68	31.29	100	55	Peak
78.3	21.24	-18.76	40.00	43.98	7.41	0.96	31.10	---	---	Peak
87.8	35.10	---	---	56.46	8.73	1.03	31.12	---	---	Peak
451.9	28.53	-17.47	46.00	40.31	16.63	2.41	30.81	---	---	Peak
509.3	25.05	-20.95	46.00	35.67	17.52	2.64	30.78	---	---	Peak
843.9	25.67	-20.33	46.00	32.39	20.13	3.59	30.44	---	---	Peak

Remark: #3 is Fundamental Signal.



- Test Mode : Mode 2
- Polarization : Horizontal

■ The test that passed at minimum margin was marked by the frame in the following table.

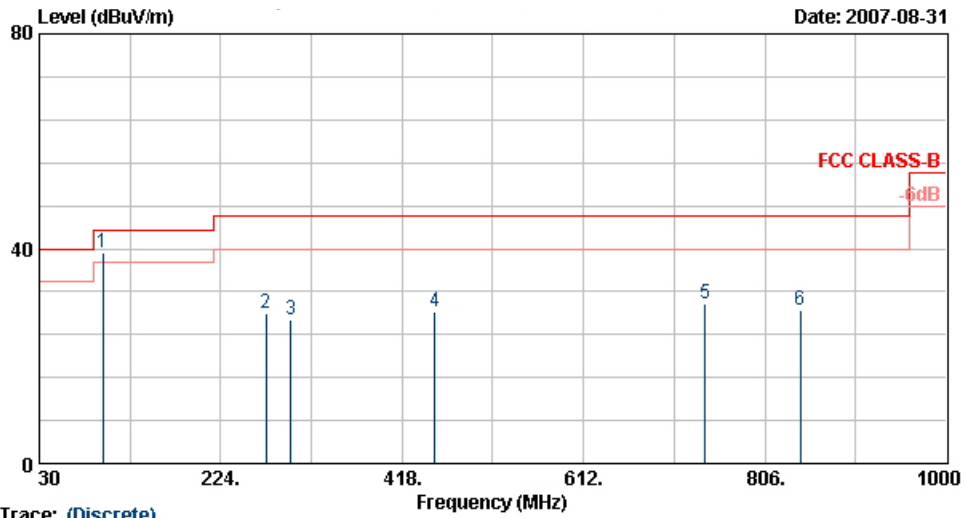

Trace: (Discrete)

Site : 06CH06-HY
 Condition : LP-ANT(951121) HORIZONTAL
 EUT : Satellite Radio
 Power : 12 Wdc
 Model : FR 781519
 Memo : FM 98.1 MHz Tx+ Satellite Radio 2 + FEA
 : + FEA
 SID : 019413613622

Frequency (MHz)	Level (dBuV/m)	Over Limit (dB)	Limit Line (dBuV/m)	Read Level (dBuV)	Antenna Factor (dB)	Cable Loss (dB)	Preamp Factor (dB)	Ant Pos (cm)	Table Pos (deg)	Remark
98.04	39.16	---	---	58.63	10.60	1.06	31.12	---	---	Peak
272.2	28.06	-17.94	46.00	44.51	12.69	1.82	30.96	---	---	Peak
299.2	26.77	-19.23	46.00	42.55	13.21	1.94	30.93	---	---	Peak
452.6	28.29	-17.71	46.00	40.05	16.64	2.41	30.81	---	---	Peak
742.4	29.67	-16.33	46.00	37.61	19.28	3.32	30.54	100	68	Peak
843.9	28.64	-17.36	46.00	35.36	20.13	3.59	30.44	---	---	Peak

Remark: #1 is Fundamental Signal.



- Test Mode : Mode 2
- Polarization : Vertical

■ The test that passed at minimum margin was marked by the frame in the following table.

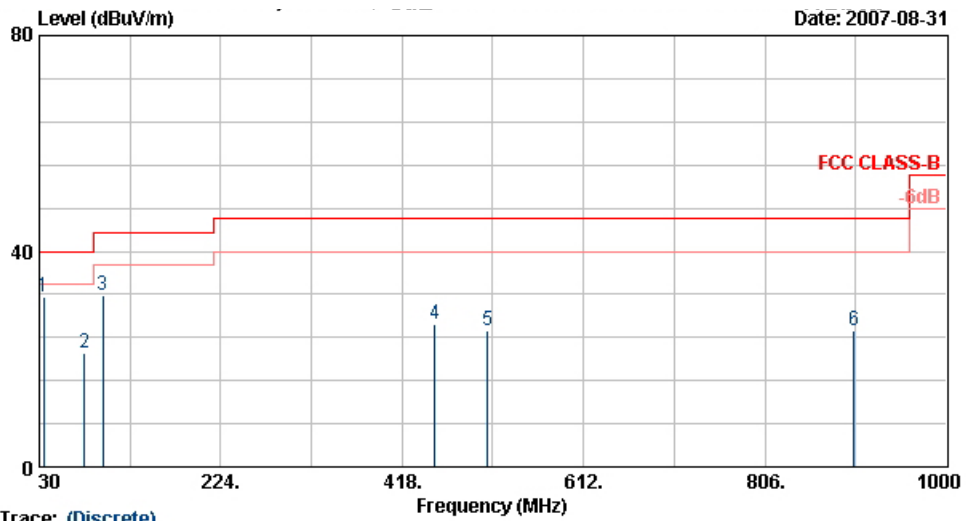

Trace: (Discrete)
 Site : 03CH06-HY
 Condition : LP-ANT(951121) VERTICAL
 EUT : Satellite Radio
 Power : 12 Wdc
 Model : FR 781519
 Memo : FM 98.1 MHz Test Satellite Radio 2 + FEA
 : + FEA
 SID : 019413613622

Frequency (MHz)	Level (dBUV/m)	Over Limit (dB)	Limit Line (dBUV/m)	Read Level (dBUV)	Antenna Factor (dB)	Cable Loss (dB)	Preamp Factor (dB)	Ant Pos (cm)	Table Pos (deg)	Remark
34.59	31.38	-8.62	40.00	45.86	16.13	0.68	31.29	100	254	Peak
78.33	21.22	-18.78	40.00	43.96	7.41	0.96	31.10	---	---	Peak
98.04	31.85	---	---	51.32	10.6	1.06	31.12	---	---	Peak
453.3	26.45	-19.55	46.00	38.21	16.64	2.41	30.81	---	---	Peak
509.3	25.29	-20.71	46.00	35.91	17.52	2.64	30.78	---	---	Peak
901.3	25.19	-20.81	46.00	31.20	20.54	3.82	30.37	---	---	Peak

Remark: #3 is Fundamental Signal.



- Test Mode : Mode 3
- Polarization : Horizontal

■ The test that passed at minimum margin was marked by the frame in the following table.

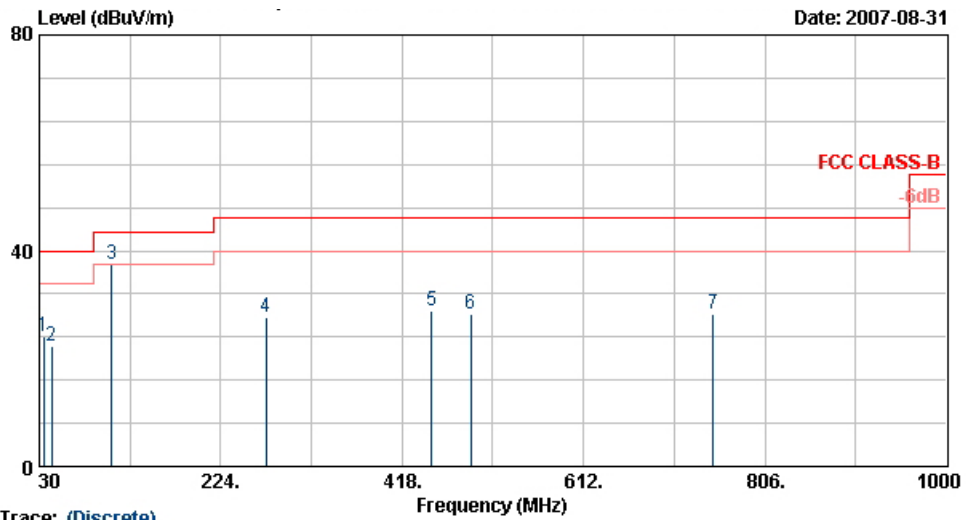

Trace: (Discrete)

Site : 09CH06-HY
 Condition : LP-ANT(951121) HORIZONTAL
 EUT : Satellite Radio
 Power : 12 Wdc
 Model : FR 781519
 Memo : FM 107.9MHz Tx+ Satellite Radio 2+ FEA
 : + FEA
 SID : 019413613622

Frequency (MHz)	Level (dBuV/m)	Over Limit (dB)	Limit Line (dBuV/m)	Read Level (dBuV)	Antenna Factor (dB)	Cable Loss (dB)	Preamp Factor (dB)	Ant Pos (cm)	Table Pos (deg)	Remark
34.59	23.95	-16.05	40.00	38.43	16.13	0.68	31.29	100	283	Peak
43.23	22.19	-17.81	40.00	41.06	11.52	0.75	31.14	---	---	Peak
107.49	37.48	---	---	55.84	11.6	1.1	31.06	---	---	Peak
272.19	27.63	-18.37	46.00	44.08	12.69	1.82	30.96	---	---	Peak
449.8	28.88	-17.12	46.00	40.69	16.6	2.4	30.82	---	---	Peak
491.8	28.33	-17.67	46.00	39.27	17.29	2.57	30.80	---	---	Peak
750.8	28.11	-17.89	46.00	35.95	19.36	3.33	30.53	---	---	Peak

Remark: #3 is Fundamental Signal.



- Test Mode : Mode 3
- Polarization : Vertical

■ The test that passed at minimum margin was marked by the frame in the following table.

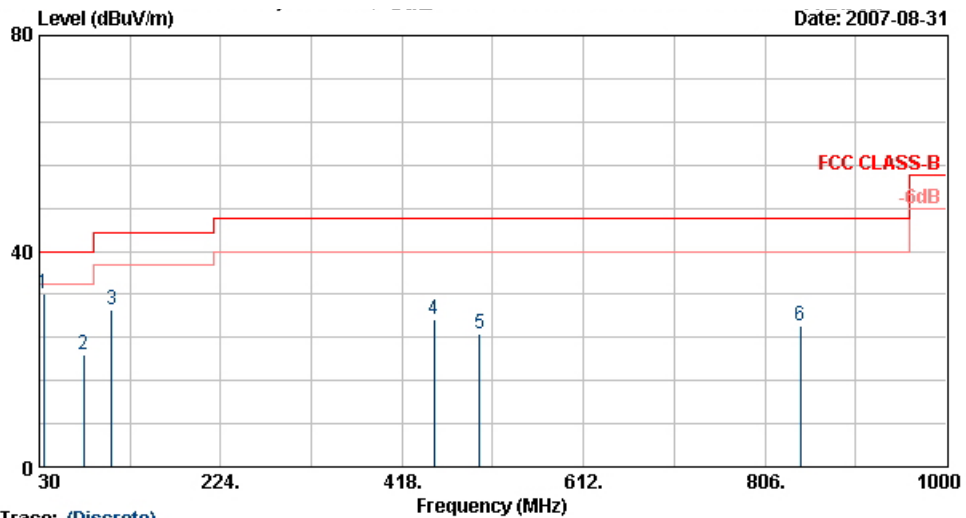

Trace: (Discrete)
 Site : 03CH06-HY
 Condition : LP-ANT(951121) VERTICAL
 EUT : Satellite Radio
 Power : 12 Wdc
 Model : FR 781519
 Memo : FM 107.9MHz Tx+ Satellite Radio 2 + FEA
 : + FEA
 SID : 019413613622

Frequency (MHz)	Level (dBUV/m)	Over Limit (dB)	Limit Line (dBUV/m)	Read Level (dBUV)	Antenna Factor (dB)	Cable Loss (dB)	Preamp Factor (dB)	Ant Pos (cm)	Table Pos (deg)	Remark
34.59	32.10	-7.90	40.00	46.58	16.13	0.68	31.29	100	58	Peak
77.79	20.69	-19.31	40.00	43.51	7.35	0.96	31.12	---	---	Peak
107.49	29.20	---	---	47.56	11.60	1.10	31.06	---	---	Peak
451.9	27.41	-18.59	46.00	39.18	16.63	2.41	30.81	---	---	Peak
500.9	24.60	-21.40	46.00	35.35	17.43	2.61	30.79	---	---	Peak
843.9	26.12	-19.88	46.00	32.84	20.13	3.59	30.44	---	---	Peak

Remark: #3 is Fundamental Signal.



6. List of Measuring Equipments

Instrument	Manufacturer	Model No.	Serial No.	Characteristics	Calibration Date	Due Date	Remark
Spectrum Analyzer	Agilent	E4408B	MY44211030	9KHz – 26.5GHz	Oct. 05, 2006	Oct. 04, 2007	Radiation (03CH06-HY)
EMI Test Receiver	R&S	ESCS30	100356	9KHz – 2.75GHz	Jul. 26, 2007	Jul. 25, 2008	Radiation (03CH06-HY)
Bilog Antenna	SCHAFFNER	CBL6112B	2885	30MHz - 2GHz	Nov. 20, 2006	Nov. 19, 2007	Radiation (03CH06-HY)
Double Ridge Horn Antenna	Com-Power	AH118	071025	1G - 18G	Jun. 04, 2007	Jun. 03, 2008	Radiation (03CH06-HY)
SHF-EHF Horn	SCHWARZBECK	BBHA 9170	9170-249-	1G – 40G	Nov. 20, 2006	Nov. 19, 2008	Radiation (03CH06-HY)
Pre Amplifier	Agilent	8449B	3008A01917	1G – 26.5G	Nov. 15, 2006	Nov. 14, 2007	Radiation (03CH06-HY)
Pre Amplifier	Mini Circuits	ZKL-2	D092004-1	10 – 1000MHz	Nov. 15, 2006	Nov. 14, 2007	Radiation (03CH06-HY)
Base Station Simulator	R&S	CMU200	106656	WCDMA	Nov. 20, 2006	Nov. 19, 2007	Radiation (03CH06-HY)



7. Uncertainty Evaluation

Uncertainty of Conducted Emission Measurement (150kHz ~ 30MHz)

Contribution	Uncertainty of x_i		$u(x_i)$
	dB	Probability Distribution	
Receiver reading	0.10	Normal(k=2)	0.05
Cable loss	0.10	Normal(k=2)	0.05
AMN insertion loss	2.50	Rectangular	0.63
Receiver Spec	1.50	Rectangular	0.43
Site imperfection	1.39	Rectangular	0.80
Mismatch	+0.34/-0.35	U-shape	0.24
Combined standard uncertainty Uc(y)	1.13		
Measuring uncertainty for a level of confidence of 95% U=2Uc(y)	2.26		

Uncertainty of Radiated Emission Evaluation (30MHz ~ 1000MHz)

Contribution	Uncertainty of x_i		$u(x_i)$
	dB	Probability Distribution	
Receiver reading	0.15	Normal(k=2)	0.08
Antenna factor calibration	1.12	Normal(k=2)	0.56
Cable loss calibration	0.12	Normal(k=2)	0.06
Pre Amplifier Gain calibration	0.13	Normal(k=2)	0.07
RCV/SPA specification	2.5	Rectangular	0.72
Antenna Factor Interpolation for Frequency	1	Rectangular	0.29
Site imperfection	2.1	Rectangular	1.21
Mismatch	+0.39/-0.41	U-shaped	0.28
Combined standard uncertainty Uc(y)	1.58		
Measuring uncertainty for a level of confidence of 95% U=2Uc(y)	3.16		