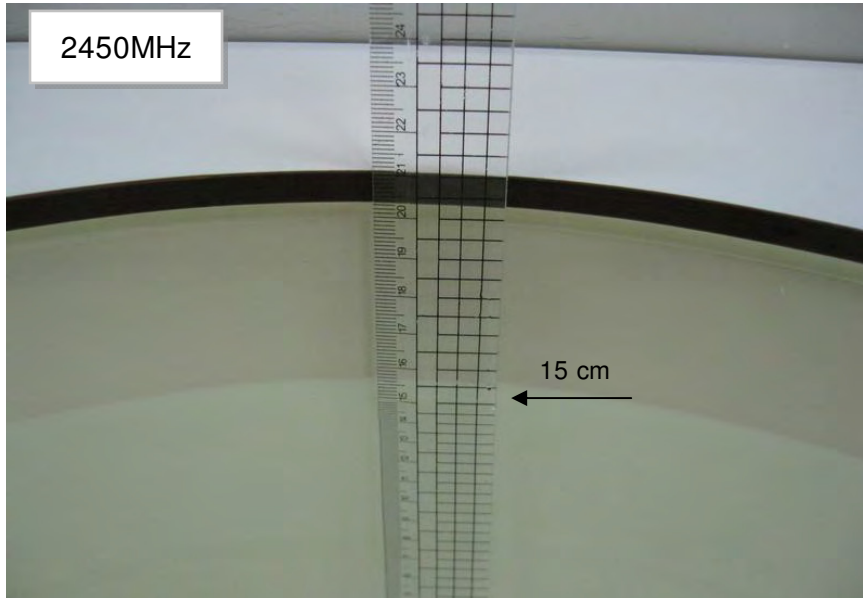


**APPENDIX****10. Photographs of Test Setup**

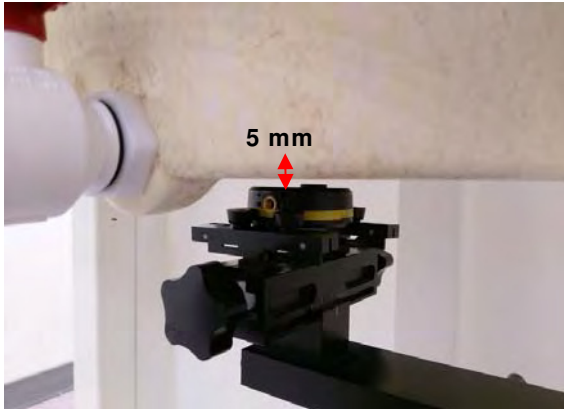
**Fig.1 Photograph of the SAR measurement system**

**Photograph of the tissue simulant fluid liquid depth (Body)**

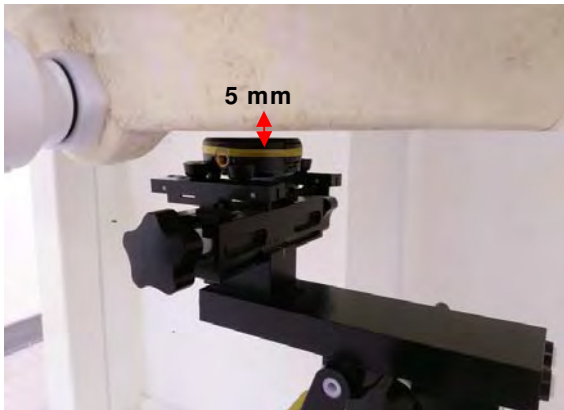


**Fig.2.1**

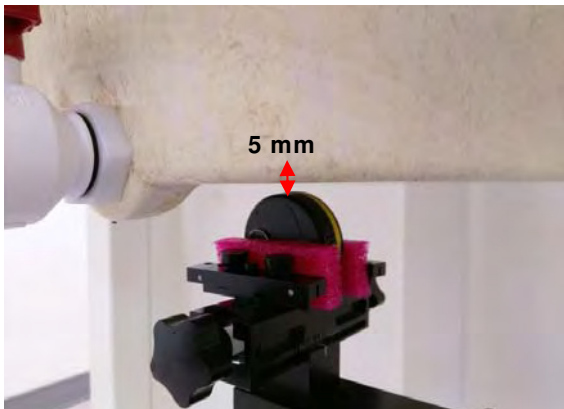
**Body - distance between flat phantom and EUT is 5 mm**



**Fig.3 EUT Front side to flat phantom**

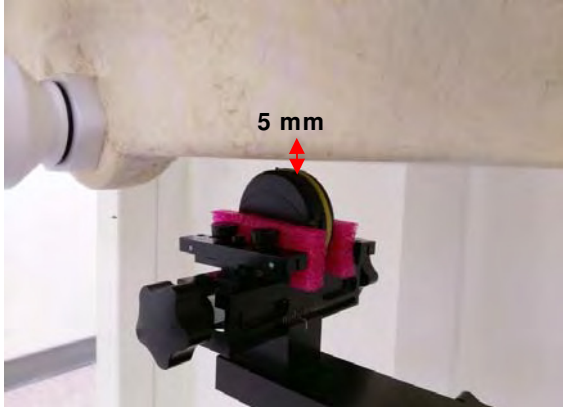


**Fig.4 EUT Back side to flat phantom**

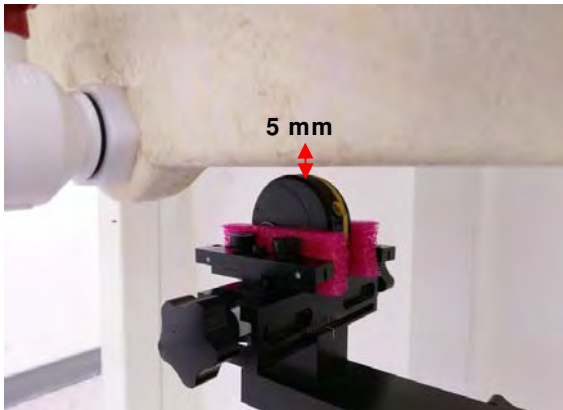


**Fig.5 EUT Right side to flat phantom**

**Body - distance between flat phantom and EUT is 5 mm**

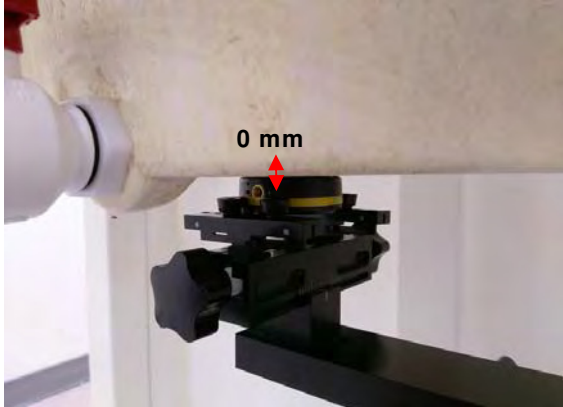


**Fig.6 EUT Bottom side to flat phantom**

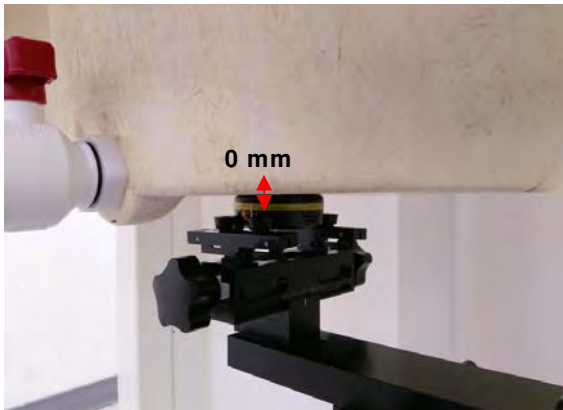


**Fig.7 EUT Right-Bottom side to flat phantom**

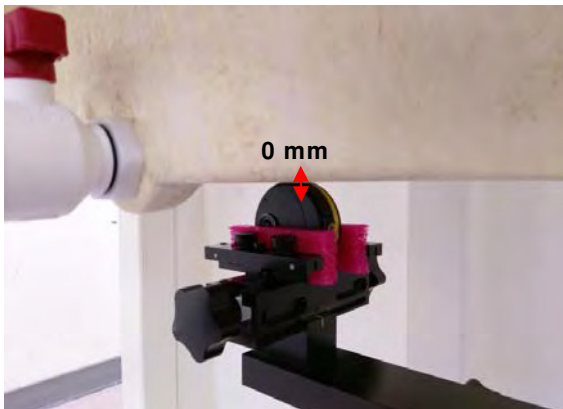
**Extremity - distance between flat phantom and EUT is 0 mm**



**Fig.8 EUT Front side to flat phantom**



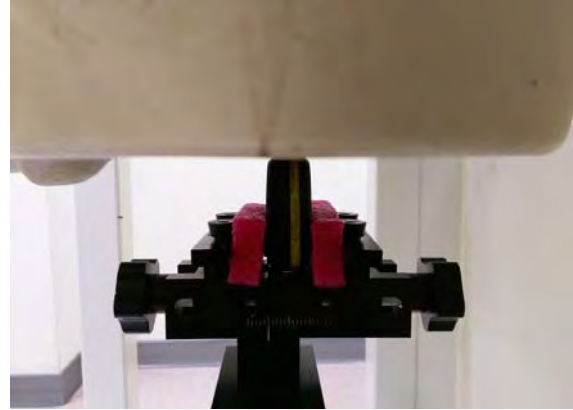
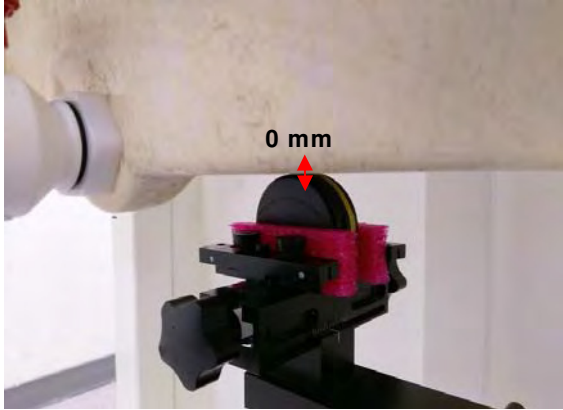
**Fig.9 EUT Back side to flat phantom**



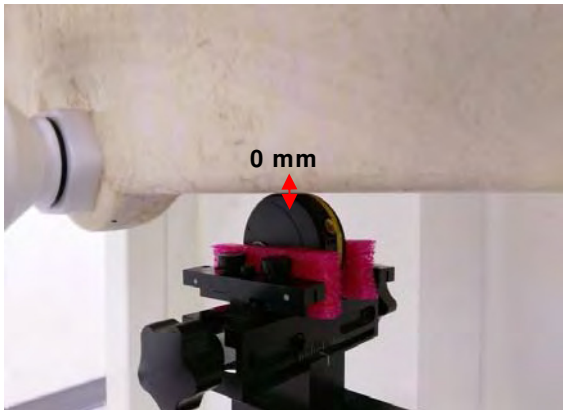
**Fig.10 EUT Right side to flat phantom**



**Extremity - distance between flat phantom and EUT is 0 mm**



**Fig.11 EUT Bottom side to flat phantom**



**Fig.12 EUT Right-Bottom side to flat phantom**

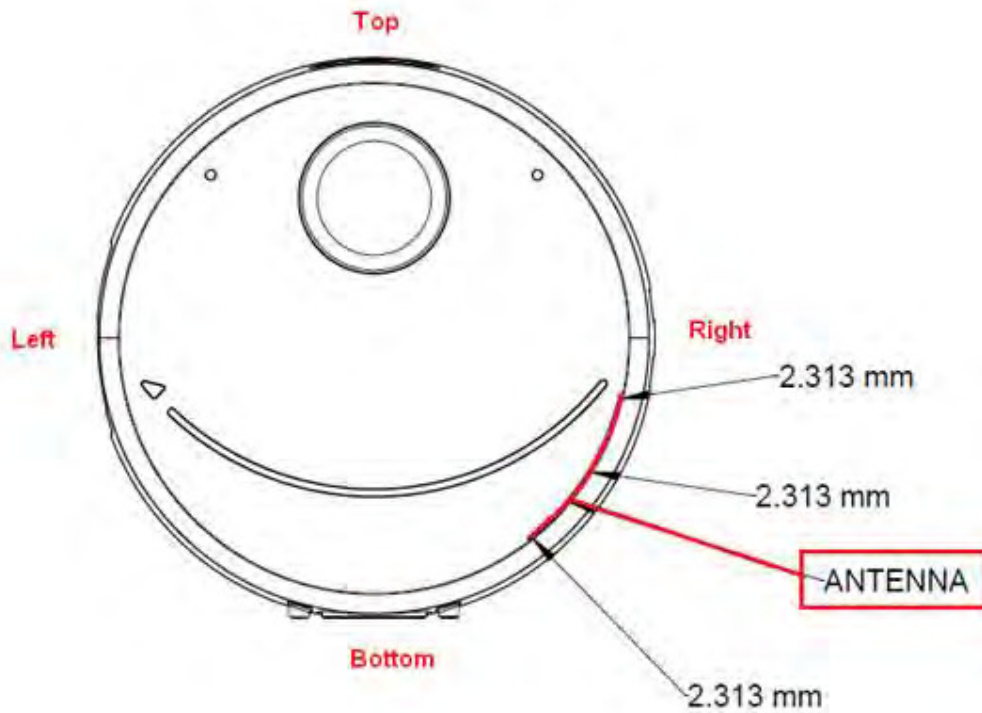
## 11. Photographs of the EUT



**Fig.13 Front view of EUT**



**Fig.14 Back view of EUT**



**Fig.15 Antenna position (Front view)**

**- End of Report -**