

# RADIO TEST REPORT

## FCC 47 CFR PART 15 SUBPART C

<b>Test Standard</b>	<b>FCC Part 15.247</b>
<b>Product name</b>	<b>QOCA Portable ECG Monitoring Device</b>
<b>Brand Name</b>	<b>Quanta</b>
<b>Model No.</b>	<b>ecg701</b>
<b>Test Result</b>	<b>Pass</b>
<b>Statements of Conformity</b>	<b>Determination of compliance is based on the results of the compliance measurement, not taking into account measurement instrumentation uncertainty.</b>

The test Result was tested by Compliance Certification Services Inc. The test data, data evaluation, test procedures, and equipment configurations shown in this report were given in ANSI C63.10: 2013 and compliance standards.

The test results of this report relate only to the tested sample (EUT) identified in this report.

The test Report of full or partial shall not copy. Without written approval of Compliance Certification Services Inc. (Wugu Laboratory)

Approved by:



---

Kevin Tsai  
 Deputy Manager

Unless otherwise stated the results shown in this test report refer only to the sample(s) tested and such sample(s) are retained for 90 days only.  
 除非另有說明，此報告結果僅對測試之樣品負責，同時此樣品僅保留90天。本報告未經本公司書面許可，不可部份複製。

This document is issued by the Company subject to its General Conditions of Service printed overleaf, available on request or accessible at <http://www.sgs.com.tw/Terms-and-Conditions> and, for electronic format documents, subject to Terms and Conditions for Electronic Documents at <http://www.sgs.com.tw/Terms-and-Conditions>. Attention is drawn to the limitation of liability, indemnification and jurisdiction issues defined therein. Any holder of this document is advised that information contained hereon reflects the Company's findings at the time of its intervention only and within the limits of client's instruction, if any. The Company's sole responsibility is to its Client and this document does not exonerate parties to a transaction from exercising all their rights and obligations under the transaction documents. This document cannot be reproduced, except in full, without prior written approval of the Company. Any unauthorized alteration, forgery or falsification of the content or appearance of this document is unlawful and offenders may be prosecuted to the fullest extent of the law.

## Revision History

Rev.	Issue Date	Revisions	Effect Page	Revised By
00	November 10, 2020	Initial Issue	ALL	Allison Chen
01	November 12, 2020	See the following note Rev.(01)	P.4-5, P.12	Allison Chen
02	November 20, 2020	See the following note Rev.(02)	P.4, P.12	Allison Chen

**Rev.(01)**

1. Added zip code in section 1.1.
2. Modify modulation type in section 1.2.
3. Modify power supply mode in section 3.2.

**Rev.(02)**

1. Modify battery model in section 1.1.
2. Modify AC power line conducted emission test mode in section 3.2.

## Table of contents

1.	GENERAL INFORMATION .....	4
1.1	EUT INFORMATION .....	4
1.2	EUT CHANNEL INFORMATION .....	5
1.3	ANTENNA INFORMATION .....	5
1.4	MEASUREMENT UNCERTAINTY.....	6
1.5	FACILITIES AND TEST LOCATION .....	7
1.6	INSTRUMENT CALIBRATION .....	7
1.7	SUPPORT AND EUT ACCESSORIES EQUIPMENT .....	9
1.8	TEST METHODOLOGY AND APPLIED STANDARDS .....	9
2.	TEST SUMMARY .....	10
3.	DESCRIPTION OF TEST MODES.....	11
3.1	THE WORST MODE OF OPERATING CONDITION .....	11
3.2	THE WORST MODE OF MEASUREMENT .....	12
3.3	EUT DUTY CYCLE.....	13
4.	TEST RESULT .....	14
4.1	AC POWER LINE CONDUCTED EMISSION .....	14
4.2	6DB BANDWIDTH AND OCCUPIED BANDWIDTH (99%) .....	17
4.3	OUTPUT POWER MEASUREMENT .....	23
4.4	POWER SPECTRAL DENSITY.....	25
4.5	CONDUCTED BAND EDGE AND SPURIOUS EMISSION .....	29
4.6	RADIATION BANDEDGE AND SPURIOUS EMISSION .....	36
APPENDIX 1 - PHOTOGRAPHS OF EUT		

Report No.: T200820W02-RP

## 1. GENERAL INFORMATION

### 1.1 EUT INFORMATION

<b>Applicant</b>	Quanta Computer Inc. No.188, Wenhua 2nd Rd., Guishan Dist., Taoyuan City 33377, Taiwan
<b>Manufacturer</b>	Quanta Computer Inc. No.188, Wenhua 2nd Rd., Guishan Dist., Taoyuan City 33377, Taiwan
<b>Equipment</b>	QOCA Portable ECG Monitoring Device
<b>Model No.</b>	ecg701
<b>Model Discrepancy</b>	N/A
<b>Trade Name</b>	Quanta
<b>Received Date</b>	August 20, 2020
<b>Date of Test</b>	August 26, 2020 ~ October 26, 2020
<b>Power Supply</b>	1. Power from power supply. Rechargeable Li-ion Battery Pack. AE-Tech / AHA11106009 Rating: 2.014 Wh, 530mAh, 3.8V 2. Power from Adapter.
<b>EUT Serial #</b>	CI6XS204201K

**Remark:**

1. Disclaimer: Antenna information is provided by the applicant, test results of this report are applicable to the sample EUT received.

Report No.: T200820W02-RP

## 1.2 EUT CHANNEL INFORMATION

Frequency Range	2402MHz-2480MHz
Modulation Type	Bluetooth 5.0: GFSK for BLE 1 Mbps & 2 Mbps
Number of channels	40 Channels

**Remark:**

Refer as ANSI C63.10: 2013 clause 5.6.1 Table 4 for test channels

Number of frequencies to be tested		
Frequency range in which device operates	Number of frequencies	Location in frequency range of operation
<input type="checkbox"/> 1 MHz or less	1	Middle
<input type="checkbox"/> 1 MHz to 10 MHz	2	1 near top and 1 near bottom
<input checked="" type="checkbox"/> More than 10 MHz	3	1 near top, 1 near middle, and 1 near bottom

## 1.3 ANTENNA INFORMATION

Antenna Type	<input type="checkbox"/> PIFA <input type="checkbox"/> PCB <input type="checkbox"/> Dipole <input checked="" type="checkbox"/> Chip
Antenna Gain	Gain: -1.45 dBi
Antenna Connector	N/A

## 1.4 MEASUREMENT UNCERTAINTY

PARAMETER	UNCERTAINTY
AC Powerline Conducted Emission	+/- 1.2575
Emission bandwidth, 20dB bandwidth	+/- 0.0014
RF output power, conducted	+/- 1.14
Power density, conducted	+/- 1.40
3M Semi Anechoic Chamber / 30M~200M	+/- 4.12
3M Semi Anechoic Chamber / 200M~1000M	+/- 4.68
3M Semi Anechoic Chamber / 1G~8G	+/- 5.18
3M Semi Anechoic Chamber / 8G~18G	+/- 5.47
3M Semi Anechoic Chamber / 18G~26G	+/- 3.81
3M Semi Anechoic Chamber / 26G~40G	+/- 3.87

**Remark:**

1. This uncertainty represents an expanded uncertainty expressed at approximately the 95% confidence level using a coverage factor of  $k=2$
2. ISO/IEC 17025 requires that an estimate of the measurement uncertainties associated with the emissions test results be included in the report.

Report No.: T200820W02-RP

## 1.5 FACILITIES AND TEST LOCATION

All measurement facilities used to collect the measurement data are located at No.11, Wugong 6th Rd., Wugu Dist., New Taipei City, Taiwan. (R.O.C.)

Test site	Test Engineer	Remark
AC Conduction Room	Rick Lee	-
Radiation	Jerry Chang / Ray Li	-
RF Conducted	Rick Lee	-

**Remark:** The sites are constructed in conformance with the requirements of ANSI C63.7, ANSI C63.4 and CISPR Publication 22.

## 1.6 INSTRUMENT CALIBRATION

RF Conducted Test Site					
Equipment	Manufacturer	Model	Serial Number	Cal Date	Cal Due
Coaxial Cable	Woken	WC12	CC003	06/29/2020	06/28/2021
Signal Analyzer	R&S	FSV 40	101073	09/25/2019	09/24/2020
Power Meter	Anritsu	ML2487A	6K00003260	05/21/2020	05/20/2021
Power Seneor	Anritsu	MA2490A	032910	05/21/2020	05/20/2021
Software	N/A				

Conduction(RF)					
Equipment	Manufacturer	Model	Serial Number	Cal Date	Cal Due
CABLE	EMCI	CFD300-NL	CERF	06/29/2020	06/28/2021
EMI Test Receiver	R&S	ESCI	100064	07/17/2020	07/16/2021
LISN	SCHAFFNER	NNB 41	03/10013	02/13/2020	02/12/2021
Software	EZ-EMC(CCS-3A1-CE-wugu)				

**Note:**

1. The calibration interval of the above test instruments is 12 months and the calibrations are traceable to NML/ROC and NIST/USA.
2. N.C.R. = No Calibration Required.

Report No.: T200820W02-RP

3M 966 Chamber Test Site					
Equipment	Manufacturer	Model	Serial Number	Cal Date	Cal Due
Band Reject Filters	MICRO TRONICS	BRM 50702	120	02/25/2020	02/24/2021
Bilog Antenna	Sunol Sciences	JB3	A030105	07/24/2020	07/23/2021
Coaxial Cable	HUBER SUHNER	SUCOFLEX 104PEA	20995	02/25/2020	02/24/2021
Coaxial Cable	EMCI	EMC105	190914+327109/4	09/19/2020	09/18/2021
Digital Thermo-Hygro Meter	WISEWIND	1206	D07	01/15/2020	01/14/2021
double Ridged Guide Horn Antenna	ETC	MCTD 1209	DRH13M02003	09/30/2020	09/29/2021
Loop Ant	COM-POWER	AL-130	121051	03/27/2020	03/26/2021
Pre-Amplifier	EMEC	EM330	060609	02/25/2020	02/24/2021
Pre-Amplifier	HP	8449B	3008A00965	02/25/2020	02/24/2021
PSA Series Spectrum Analyzer	Agilent	E4446A	MY46180323	07/24/2020	07/23/2021
Antenna Tower	CCS	CC-A-1F	N/A	N.C.R	N.C.R
Controller	CCS	CC-C-1F	N/A	N.C.R	N.C.R
Turn Table	CCS	CC-T-1F	N/A	N.C.R	N.C.R
Software	e3 6.11-20180413				

**Note:**

1. The calibration interval of the above test instruments is 12 months and the calibrations are traceable to NML/ROC and NIST/USA.
2. N.C.R. = No Calibration Required.



## 1.7 SUPPORT AND EUT ACCESSORIES EQUIPMENT

EUT Accessories Equipment					
No.	Equipment	Brand	Model	Series No.	FCC ID
1	NB(J)	TOSHIBA	PT345T-00L002	N/A	PD97260H

Support Equipment					
No.	Equipment	Brand	Model	Series No.	FCC ID
1	DC Power Supplies	GW Instek	SPS-3610	N/A	N/A
2	Adapter	SAMSUNG	ETA-U90JWS	N/A	N/A

## 1.8 TEST METHODOLOGY AND APPLIED STANDARDS

The test methodology, setups and results comply with all requirements in accordance with ANSI C63.10:2013, FCC Part 2, FCC Part 15.247.

Report No.: T200820W02-RP

## 2. TEST SUMMARY

FCC Standard Section	Report Section	Test Item	Result
15.203	1.3	Antenna Requirement	Pass
15.207(a)	4.1	AC Conducted Emission	Pass
15.247(a)(2)	4.2	6 dB Bandwidth	Pass
-	4.2	Occupied Bandwidth (99%)	Pass
15.247(b)(3)	4.3	Output Power Measurement	Pass
15.247(e)	4.4	Power Spectral Density	Pass
15.247(d)	4.5	Conducted Spurious Emission	Pass
15.247(d)	4.5	Conducted Emission	Pass
15.247(d)	4.6	Radiation Band Edge	Pass
15.247(d)	4.6	Radiation Spurious Emission	Pass

### 3. DESCRIPTION OF TEST MODES

#### 3.1 THE WORST MODE OF OPERATING CONDITION

Operation mode	BLE Mode (1Mbps) BLE Mode (2Mbps)
Test Channel Frequencies	1.Lowest Channel : 2402MHz 2.Middle Channel : 2440MHz 3.Highest Channel : 2480MHz

**Remark:**

1. EUT pre-scanned data rate of output power for each mode, the worst data rate were recorded in this report.

Report No.: T200820W02-RP

### 3.2 THE WORST MODE OF MEASUREMENT

Radiated Emission Measurement Above 1G	
Test Condition	Radiated Emission Above 1G
Power supply Mode	Mode 1: EUT power by Li-ion battery pack Mode 2: EUT power by Adapter.
Worst Mode	<input checked="" type="checkbox"/> Mode 1 <input type="checkbox"/> Mode 2 <input type="checkbox"/> Mode 3 <input type="checkbox"/> Mode 4
Worst Position	<input type="checkbox"/> Placed in fixed position. <input checked="" type="checkbox"/> Placed in fixed position at X-Plane (E2-Plane) <input type="checkbox"/> Placed in fixed position at Y-Plane (E1-Plane) <input type="checkbox"/> Placed in fixed position at Z-Plane (H-Plane)

Radiated Emission Measurement Below 1G	
Test Condition	Radiated Emission Below 1G
Power supply Mode	Mode 1: EUT power by Li-ion battery pack Mode 2: EUT power by Adapter.
Worst Mode	<input checked="" type="checkbox"/> Mode 1 <input type="checkbox"/> Mode 2 <input type="checkbox"/> Mode 3 <input type="checkbox"/> Mode 4

AC Power Line Conducted Emission	
Test Condition	AC Power line conducted emission for line and neutral
Power supply Mode	Mode 1: Power from adapter (With ECG701-C1 Charger)
Worst Mode	<input checked="" type="checkbox"/> Mode 1 <input type="checkbox"/> Mode 2 <input type="checkbox"/> Mode 3 <input type="checkbox"/> Mode 4

Remark:

1. The worst mode was record in this test report.
2. EUT pre-scanned in three axis ,X,Y, Z for radiated measurement. The worst case(X-Plane) were recorded in this report
2. AC power line conducted emission and for below 1G radiation emission were performed the EUT transmit at the highest output power channel as worse case.

Report No.: T200820W02-RP

### 3.3 EUT DUTY CYCLE

Temperature: 25°C

Humidity: 50% RH

Tested by: Rick Lee

Test date: August 26, 2020

Duty Cycle				
Configuration	Duty Cycle (%)	Duty Factor (dB)	1/T (kHz)	VBW Setting (kHz)
BLE-1Mbps	72.10%	1.42	2.23	3.00
BLE-2Mbps	42.86%	3.68	3.83	4.00



Report No.: T200820W02-RP

## 4. TEST RESULT

### 4.1 AC POWER LINE CONDUCTED EMISSION

#### 4.1.1 Test Limit

According to §15.207(a),

Frequency Range (MHz)	Limits(dB $\mu$ V)	
	Quasi-peak	Average
0.15 to 0.50	66 to 56*	56 to 46*
0.50 to 5	56	46
5 to 30	60	50

\* Decreases with the logarithm of the frequency.

#### 4.1.2 Test Procedure

Test method Refer as ANSI C63.10: 2013 clause 6.2,

1. The EUT was placed above horizontal ground plane and 0.4m above vertical ground plane
2. EUT connected to the line impedance stabilization network (LISN)
3. Receiver set RBW of 9kHz and Detector Peak, and note as quasi-peak and average.
4. Maximum procedure was performed on the six highest emissions to ensure EUT compliance.
5. Recorded Line for Neutral and Line.

#### 4.1.3 Test Setup

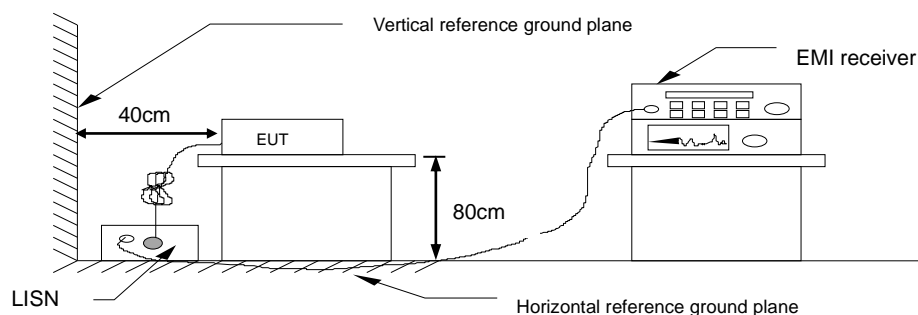

#### 4.1.4 Test Result

**PASS.**

Report No.: T200820W02-RP

### Test Data

Test Mode:	Mode 1	Temp/Hum	24(°C)/ 50%RH
Phase:	Line	Test Date	October 26, 2020
Test Voltage:	120Vac, 60Hz	Test Engineer	Rick Lee

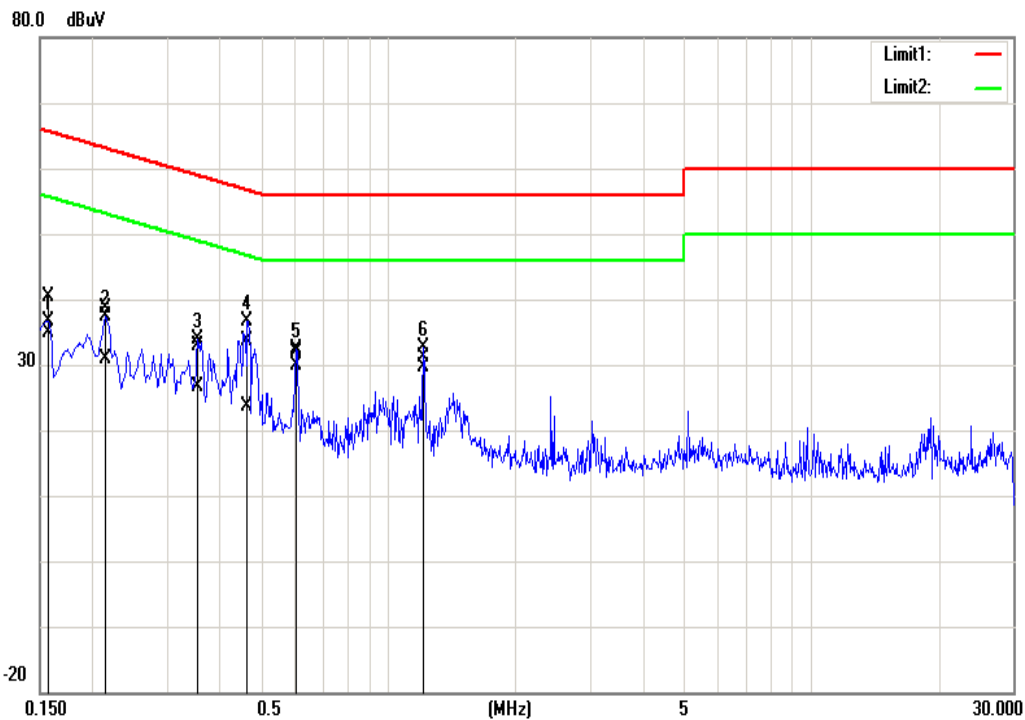

Frequency (MHz)	Quasi Peak reading (dBuV)	Average reading (dBuV)	Correction factor (dB)	Quasi Peak result (dBuV)	Average result (dBuV)	Quasi Peak limit (dBuV)	Average limit (dBuV)	Quasi Peak margin (dB)	Average margin (dB)	Remark
0.1580	30.07	24.62	10.21	40.28	34.83	65.57	55.57	-25.29	-20.74	Pass
0.2140	28.54	20.66	10.21	38.75	30.87	63.05	53.05	-24.30	-22.18	Pass
0.3540	22.56	16.43	10.22	32.78	26.65	58.87	48.87	-26.09	-22.22	Pass
0.4660	23.33	13.29	10.22	33.55	23.51	56.58	46.58	-23.03	-23.07	Pass
0.6060	21.55	19.57	10.22	31.77	29.79	56.00	46.00	-24.23	-16.21	Pass
1.2140	20.88	19.36	10.24	31.12	29.60	56.00	46.00	-24.88	-16.40	Pass

Test Mode:	Mode 1	Temp/Hum	24(°C)/ 50%RH
Phase:	Neutral	Test Date	October 26, 2020
Test Voltage:	120Vac, 60Hz	Test Engineer	Rick Lee

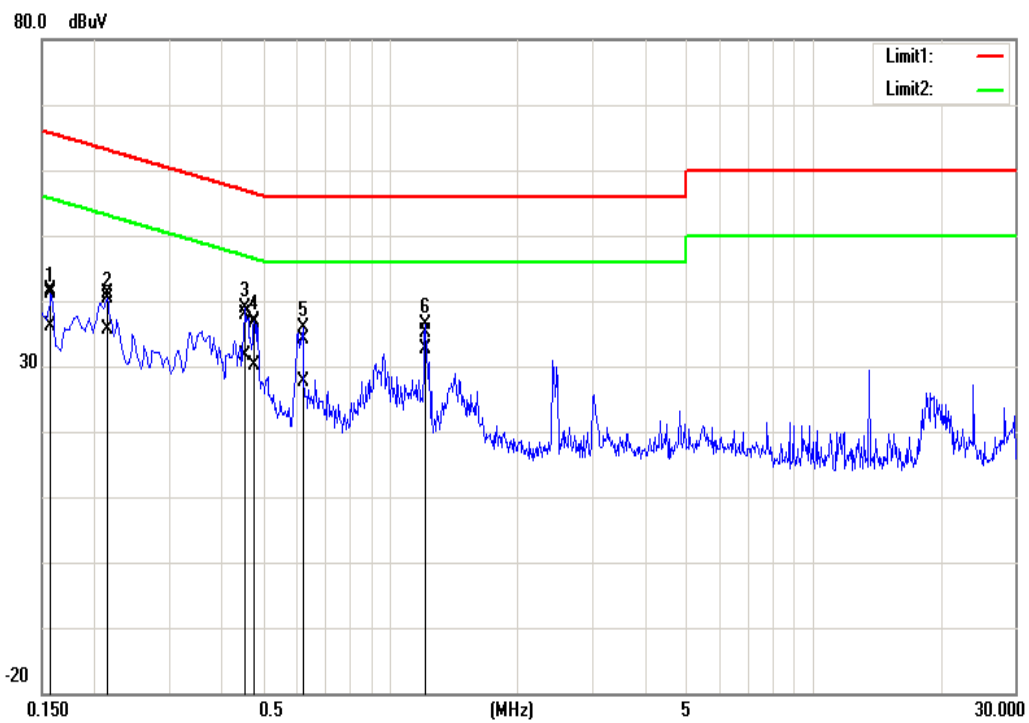

Frequency (MHz)	Quasi Peak reading (dBuV)	Average reading (dBuV)	Correction factor (dB)	Quasi Peak result (dBuV)	Average result (dBuV)	Quasi Peak limit (dBuV)	Average limit (dBuV)	Quasi Peak margin (dB)	Average margin (dB)	Remark
0.1580	31.46	26.04	10.18	41.64	36.22	65.57	55.57	-23.93	-19.35	Pass
0.2140	30.99	25.40	10.19	41.18	35.59	63.05	53.05	-21.87	-17.46	Pass
0.4540	27.78	21.42	10.19	37.97	31.61	56.80	46.80	-18.83	-15.19	Pass
0.4780	26.39	19.85	10.19	36.58	30.04	56.37	46.37	-19.79	-16.33	Pass
0.6220	23.94	17.55	10.19	34.13	27.74	56.00	46.00	-21.87	-18.26	Pass
1.2100	24.88	22.48	10.21	35.09	32.69	56.00	46.00	-20.91	-13.31	Pass



Report No.: T200820W02-RP

## 4.2 6dB BANDWIDTH AND OCCUPIED BANDWIDTH (99%)

### 4.2.1 Test Limit

According to §15.247(a)(2),

**6 dB Bandwidth** :

Limit	Shall be at least 500kHz
-------	--------------------------

**Occupied Bandwidth(99%)** : For reporting purposes only.

### 4.2.2 Test Procedure

Test method Refer as ANSI C63.10: 2013 clause 6.9.2,

1. The EUT RF output connected to the spectrum analyzer by RF cable.
2. Setting maximum power transmit of EUT.
3. SA set RBW =100KHz, VBW = 300KHz and Detector = Peak, to measurement 6dB Bandwidth.
4. SA set RBW = 1% ~ 5% OBW, VBW = three times the RBW and Detector = Peak, to measurement 99% Bandwidth.
5. Measure and record the result of 6 dB Bandwidth and 99% Bandwidth. in the test report.

### 4.2.3 Test Setup

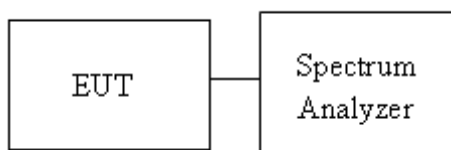

Report No.: T200820W02-RP

#### 4.2.4 Test Result

Temperature: 25°C

Humidity: 50% RH

Tested by: Rick Lee

Test date: August 26, 2020

Test mode: BLE-1Mbps mode / 2402-2480 MHz				
Channel	Frequency (MHz)	OBW (99%) (MHz)	6dB BW (MHz)	6dB limit (kHz)
Low	2402	1.0072	0.6729	>500
Mid	2440	1.0115	0.6686	
High	2480	1.0115	0.6643	
Test mode: BLE-2Mbps mode / 2402-2480 MHz				
Low	2402	2.0188	1.1158	>500
Mid	2440	2.0144	1.1418	
High	2480	2.0014	1.1158	

Report No.: T200820W02-RP

## Test Data

### 6dB BANDWIDTH

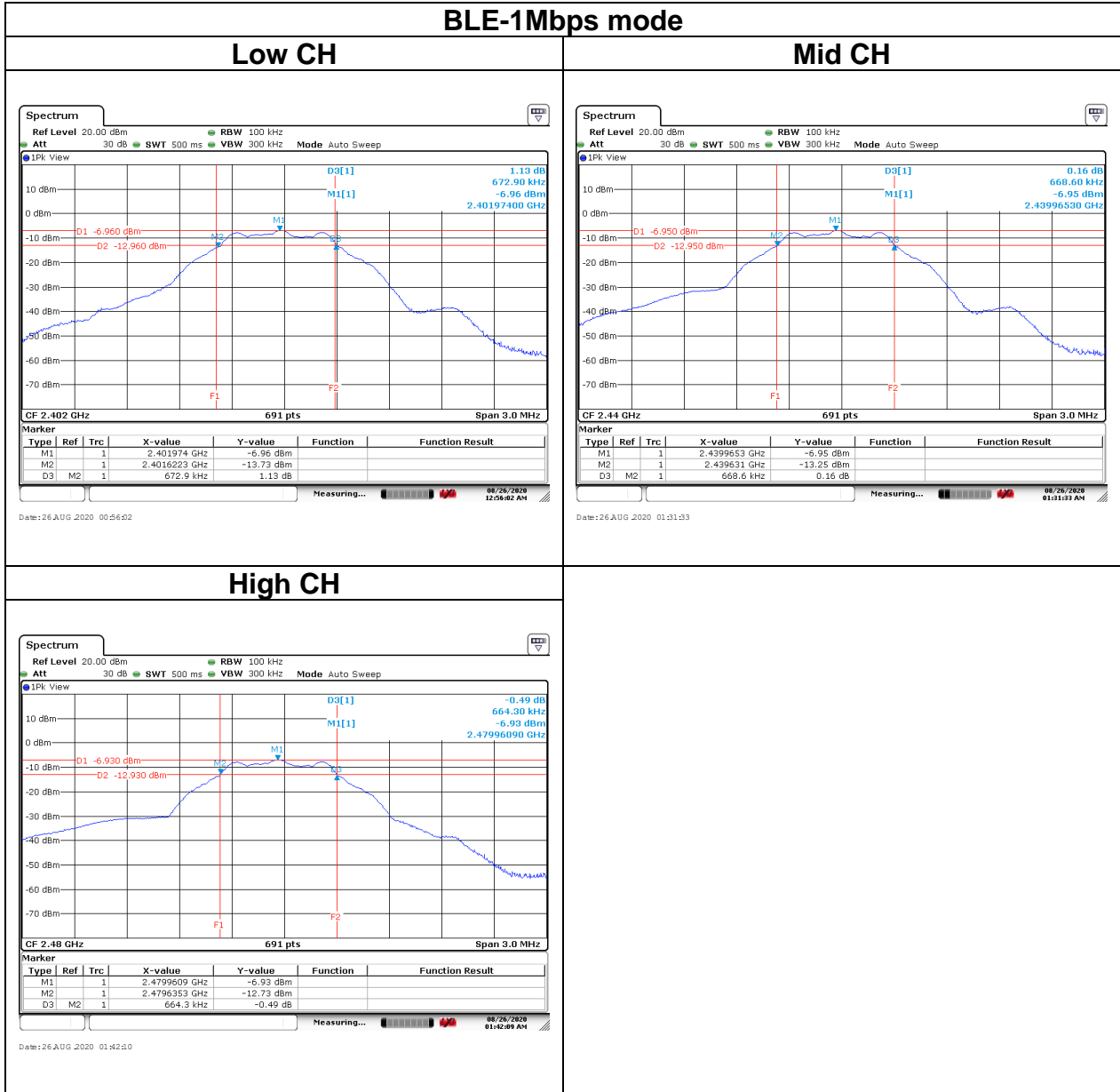

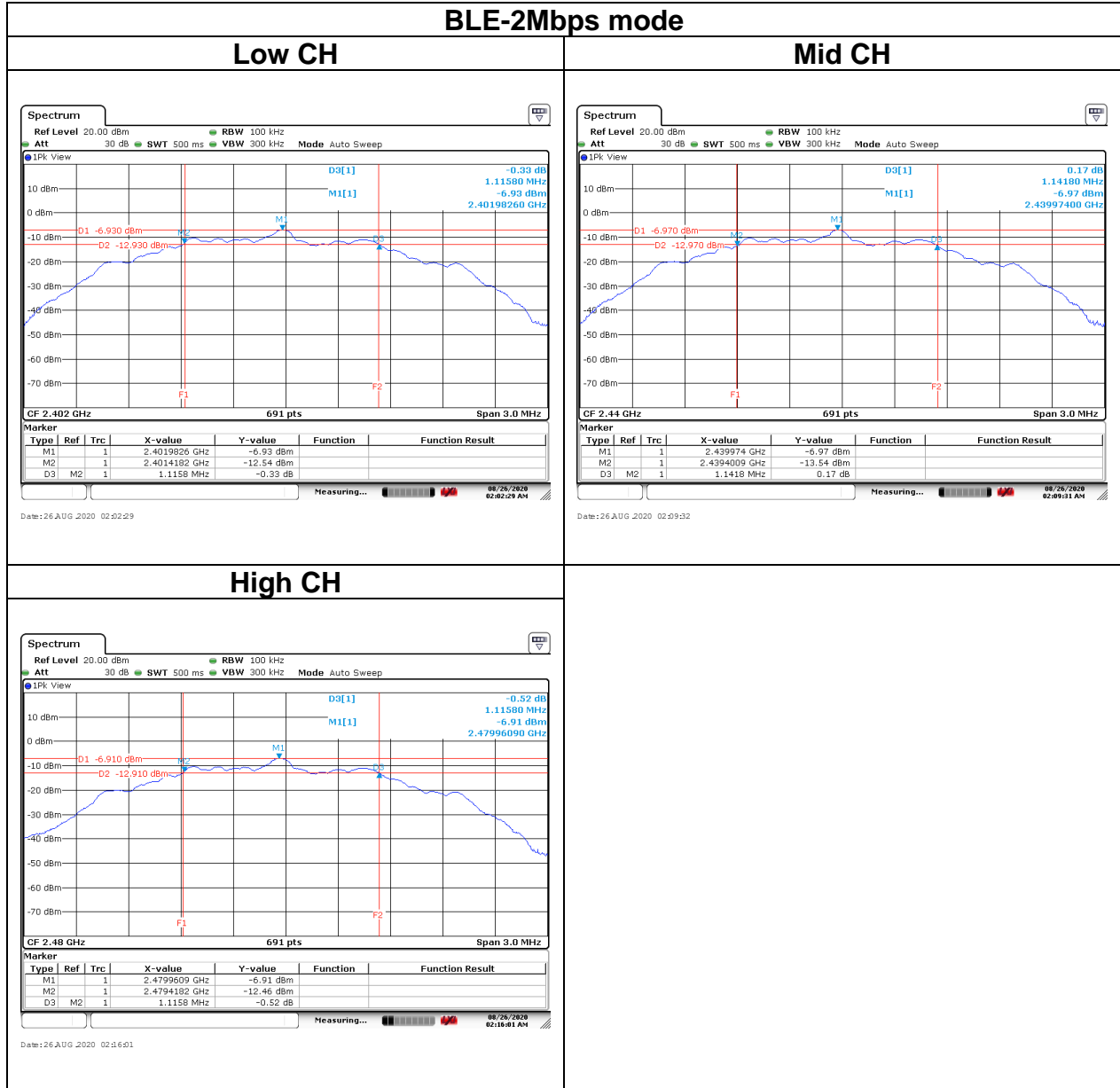

Report No.: T200820W02-RP

## Test Data

### BANDWIDTH (99%)

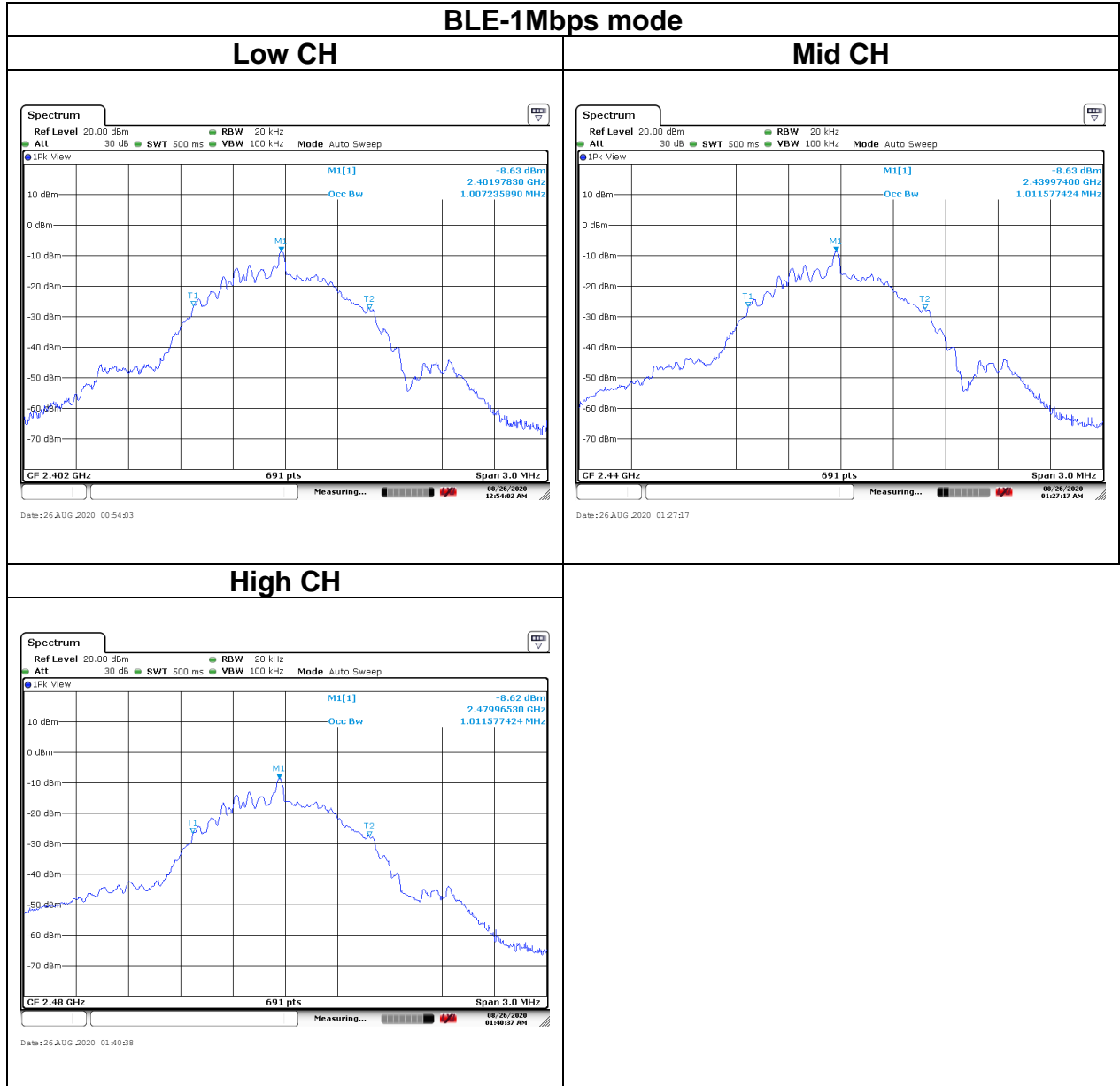

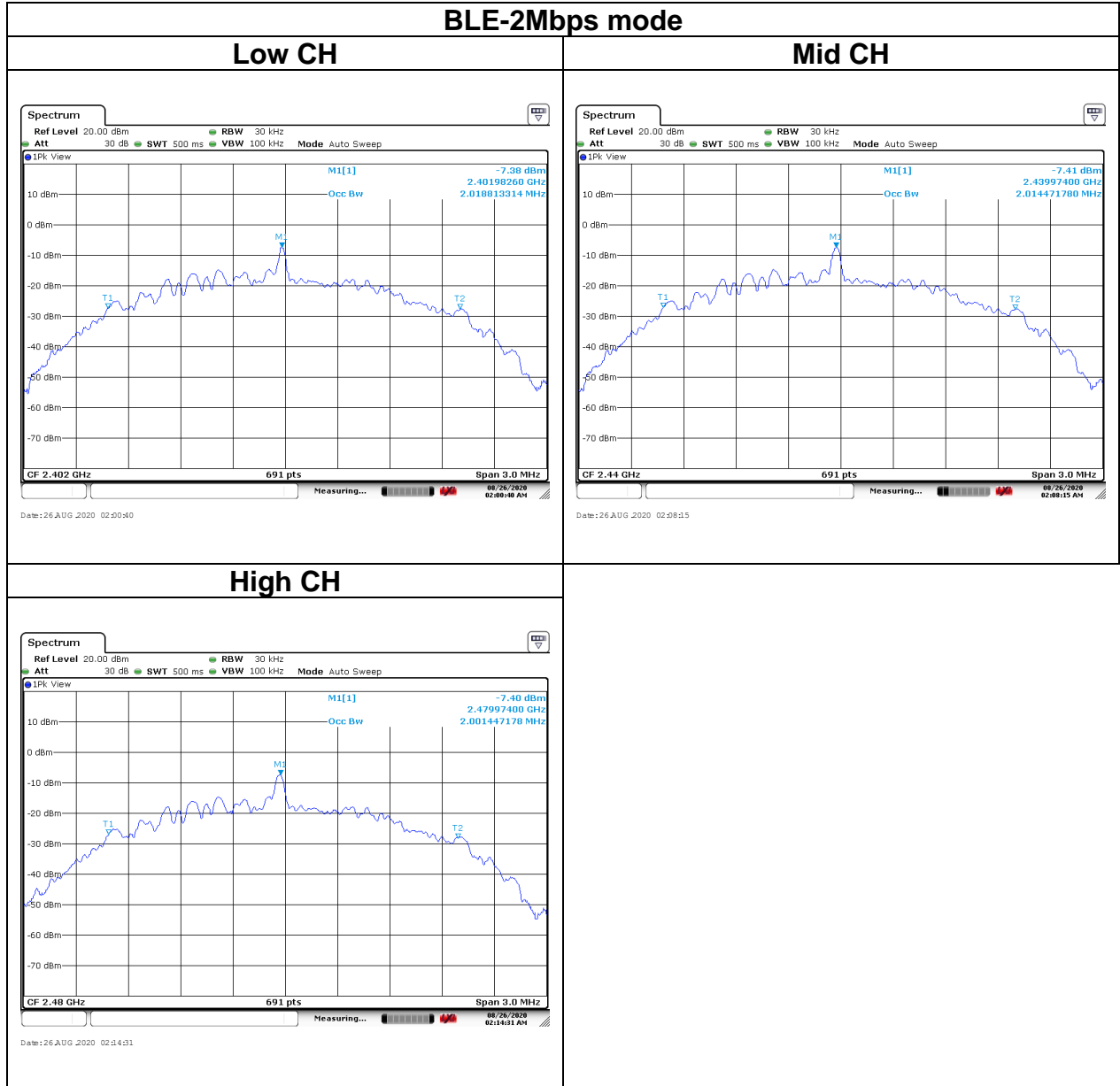

Report No.: T200820W02-RP

## 4.3 OUTPUT POWER MEASUREMENT

### 4.3.1 Test Limit

According to §15.247(b)(3).

#### Peak output power :

For systems using digital modulation in the 2400-2483.5 MHz: 1 Watt(30 dBm), base on the use of antennas with directional gain not exceed 6 dBi If transmitting antennas of directional gain greater than 6dBi are used the peak output power the conducted output power from the intentional radiator shall be reduced by the amount in dB that the directional gain of the antenna exceeds 6 dBi. In case of point-to-point operation, the limit has to be reduced by 1dB for every 3 dB that the directional gain of the antenna exceeds 6 dBi.

Limit	<input checked="" type="checkbox"/> Antenna not exceed 6 dBi : 30dBm <input type="checkbox"/> Antenna with DG greater than 6 dBi [ Limit = 30 – (DG – 6) ] <input type="checkbox"/> Point-to-point operation
-------	---

Average output power : For reporting purposes only.

### 4.3.2 Test Procedure

Test method Refer as ANSI C63.10:2013.

1. The EUT RF output connected to the power meter by RF cable.
2. Setting maximum power transmit of EUT.
3. The path loss was compensated to the results for each measurement.
4. Measure and record the result of Peak output power and Average output power. in the test report.

### 4.3.3 Test Setup

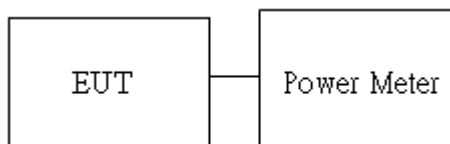





Report No.: T200820W02-RP

## 4.4 POWER SPECTRAL DENSITY

### 4.4.1 Test Limit

According to §15.247(e),

For digitally modulated systems, the power spectral density conducted from the intentional radiator to the antenna shall not be greater than 8 dBm in any 3 kHz band during any time interval of continuous transmission.

Limit	<input checked="" type="checkbox"/> Antenna not exceed 6 dBi : 8dBm <input type="checkbox"/> Antenna with DG greater than 6 dBi [ Limit = 8 – (DG – 6) ] <input type="checkbox"/> Point-to-point operation :
-------	---

### 4.4.2 Test Procedure

Test method Refer as ANSI C63.10:2013.

1. The EUT RF output connected to the spectrum analyzer by RF cable.
2. Setting maximum power transmit of EUT
3. SA set RBW = 3kHz, VBW = 10kHz, Span = 1.5 times DTS Bandwidth (6 dB BW), Detector = Peak, Sweep Time = Auto and Trace = Max hold.
4. The path loss and Duty Factor were compensated to the results for each measurement by SA.
5. Mark the maximum level.
6. Measure and record the result of power spectral density. in the test report.

### 4.4.3 Test Setup

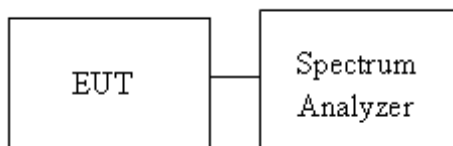

Report No.: T200820W02-RP

#### 4.4.4 Test Result

Temperature: 25°C                      Humidity: 50% RH  
Tested by: Rick Lee                      Test date: August 26, 2020

Test mode: BLE-1Mbps mode / 2402-2480 MHz			
Channel	Frequency (MHz)	PSD (dBm)	FCC limit (dBm)
Low	2402	-10.51	8
Mid	2440	-10.47	
High	2480	-10.16	

Test mode: BLE-2Mbps mode / 2402-2480 MHz			
Channel	Frequency (MHz)	PSD (dBm)	FCC limit (dBm)
Low	2402	-10.72	8
Mid	2440	-10.56	
High	2480	-10.04	

Report No.: T200820W02-RP

## Test Data

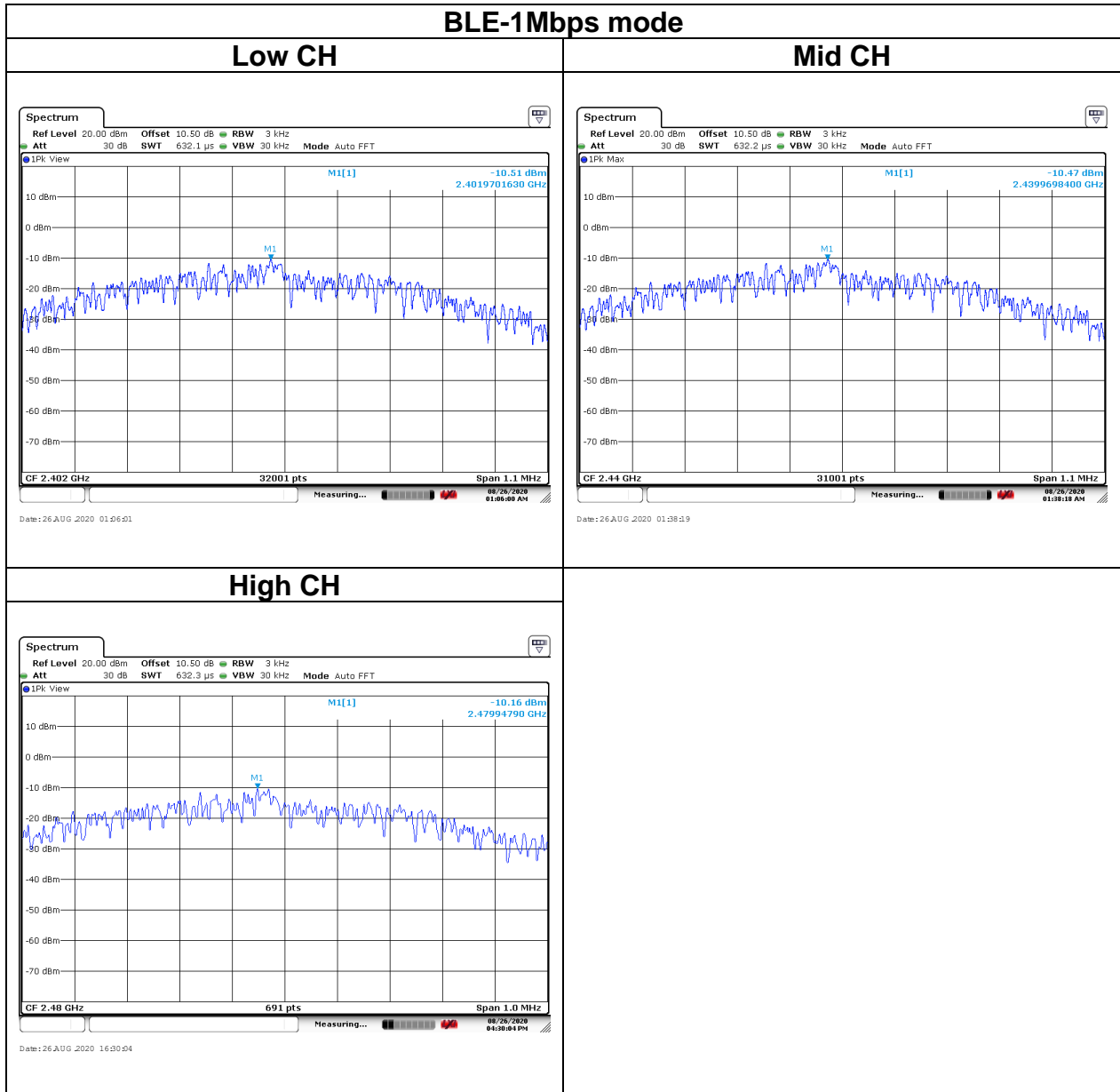

Report No.: T200820W02-RP

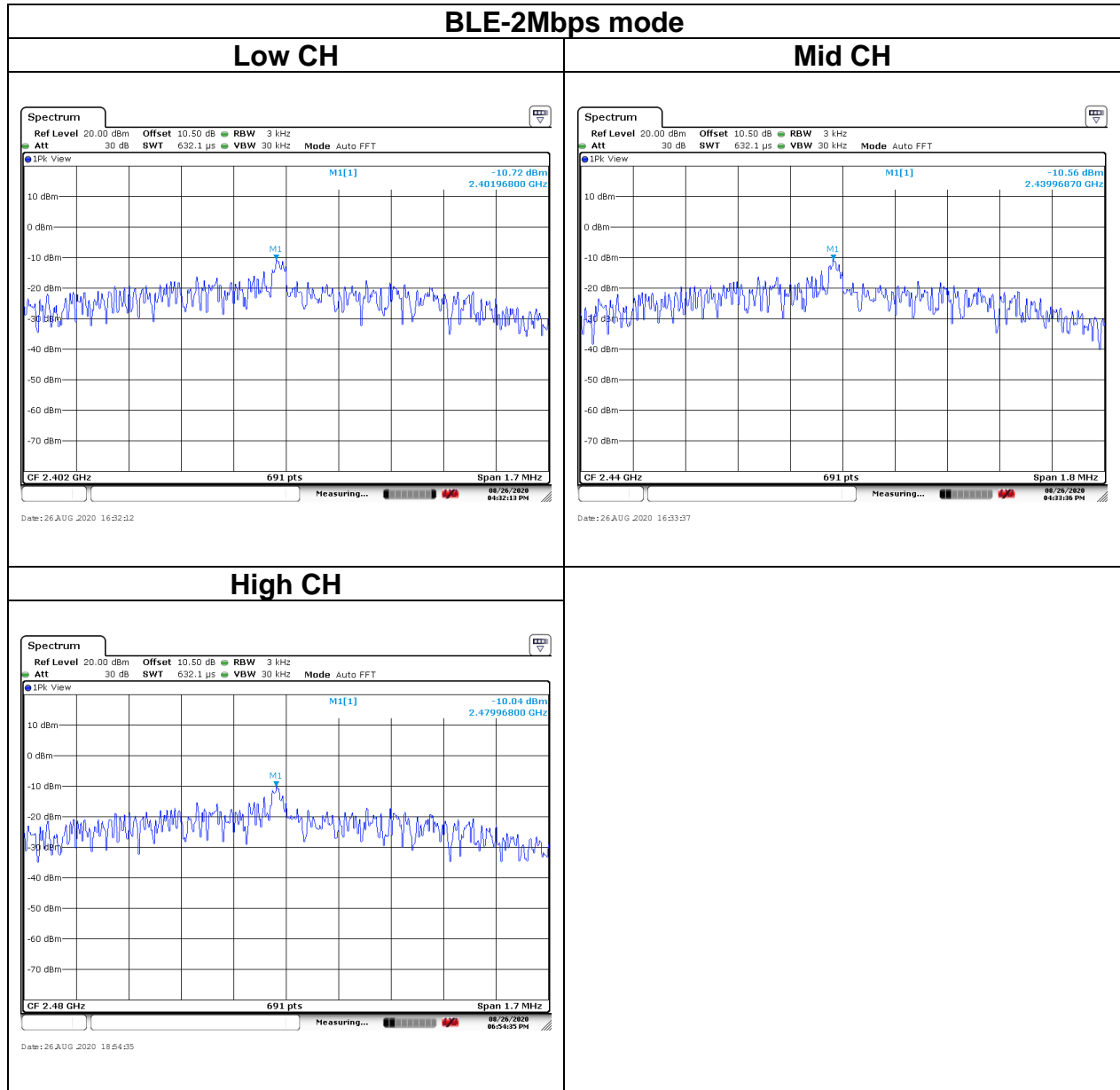

Report No.: T200820W02-RP

## 4.5 CONDUCTED BAND EDGE AND SPURIOUS EMISSION

### 4.5.1 Test Limit

According to §15.247(d),

In any 100 kHz bandwidth outside the authorized frequency band,

Non-restricted bands shall be attenuated at least 20 dB/30 dB relative to the maximum PSD level in 100 kHz by RF conducted or a radiated measurement which fall in the restricted bands, as defined in §15.205(a), must also comply with the radiated emission limits specified in §15.209(a).

### 4.5.2 Test Procedure

Test method Refer as ANSI C63.10:2013.

1. EUT RF output port connected to the SA by RF cable, and the path loss was compensated to result.
2. SA setting, RBW=100kHz, VBW=300kHz, Detector=Peak, Trace mode = max hold, SWT = Auto.
3. In any 100 kHz bandwidth outside the authorized frequency band, shall be attenuated at least 20 dB relative to the maximum in-band peak PSD level in 100 kHz when conducted power procedure is used. If the transmitter complies with the conducted power limits based on the use of RMS averaging over a time interval, the attenuation required under this paragraph shall be 30 dB instead of 20 dB.

### 4.5.3 Test Setup

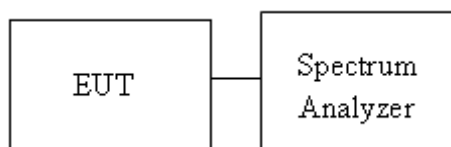

Report No.: T200820W02-RP

## 4.5.4 Test Result

### Test Data

Temperature: 25°C  
Tested by: Rick Lee

Humidity: 50% RH  
Test date: August 26, 2020

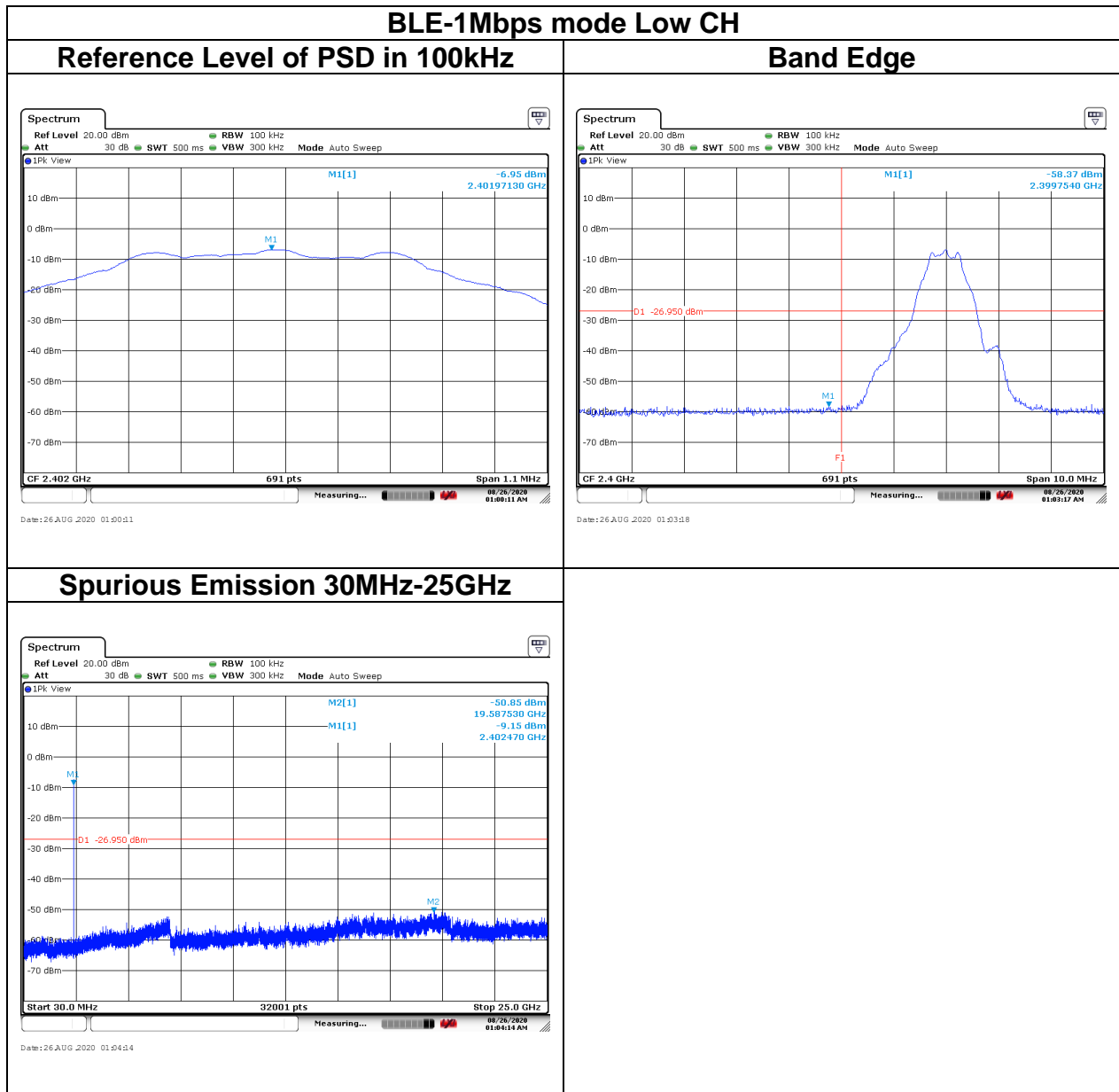

Report No.: T200820W02-RP

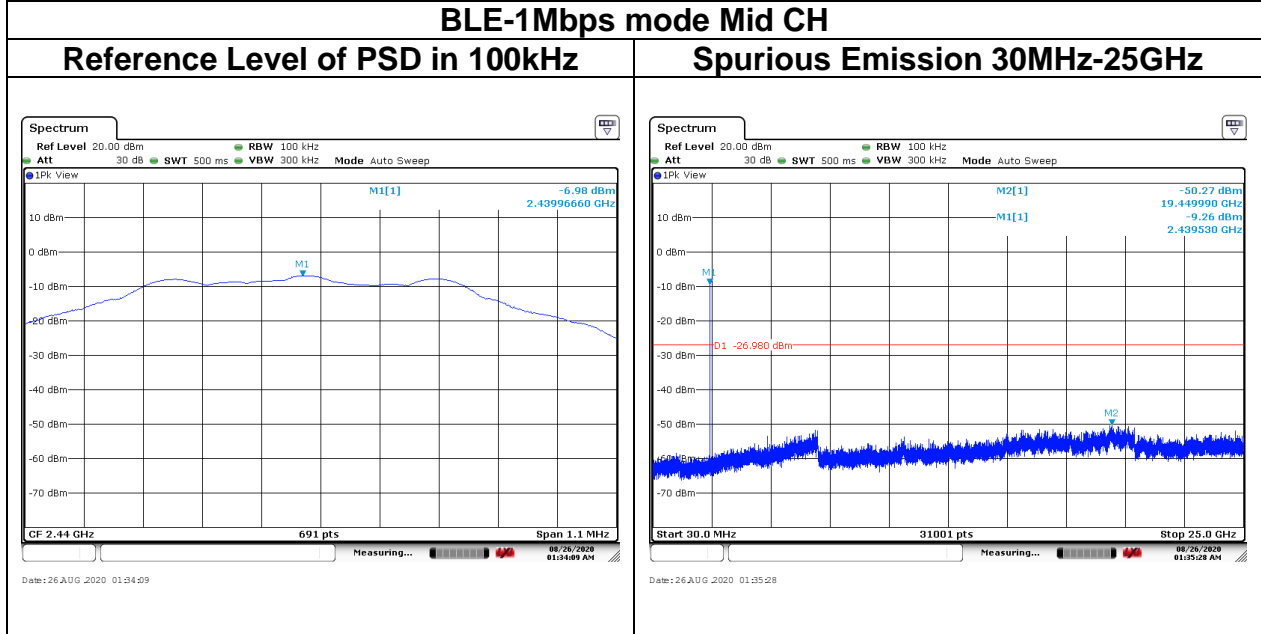

Report No.: T200820W02-RP

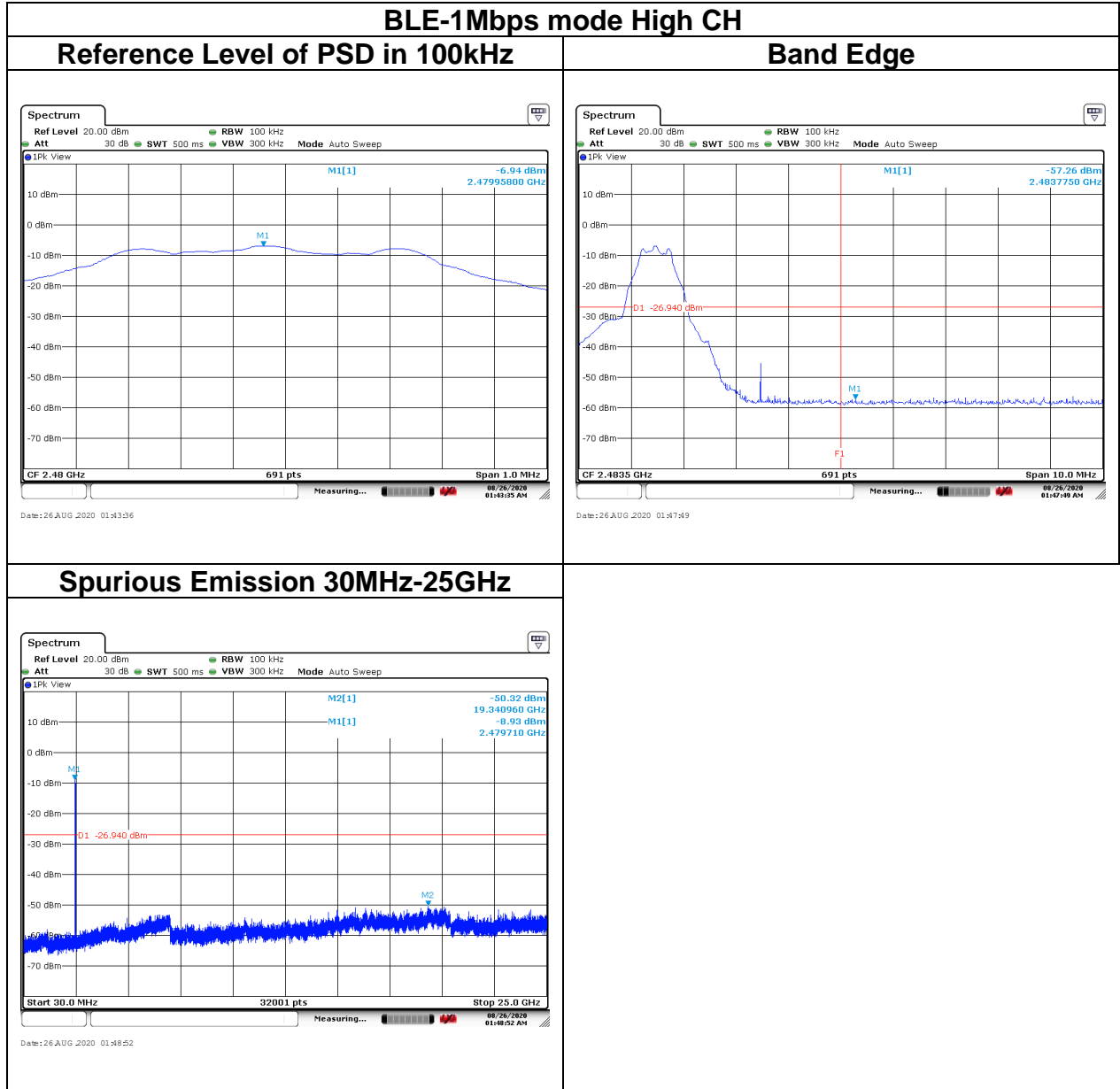



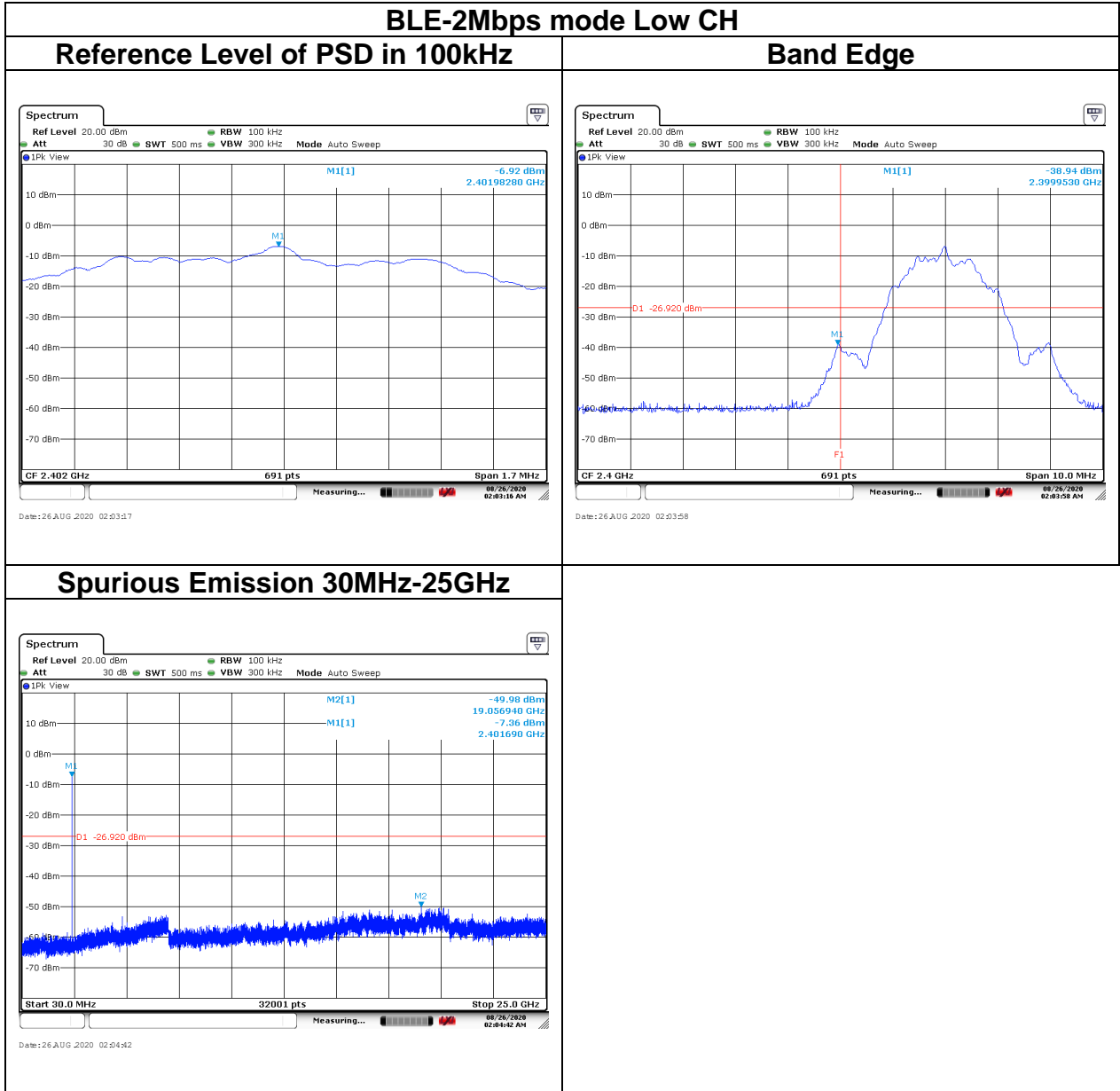

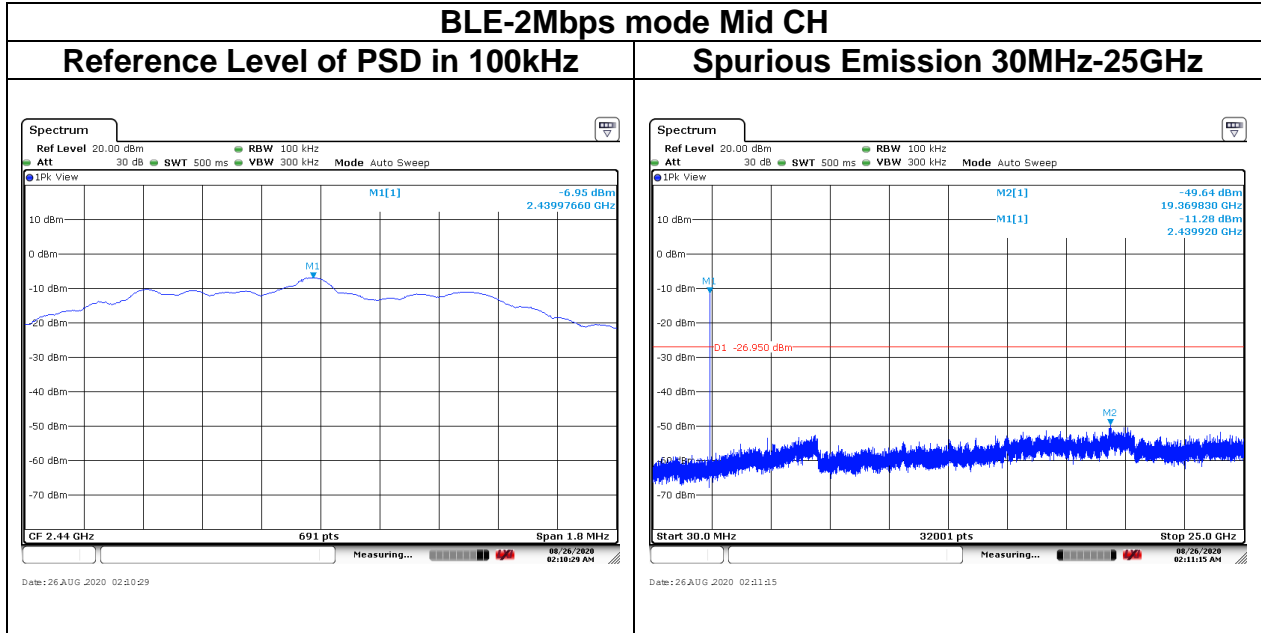

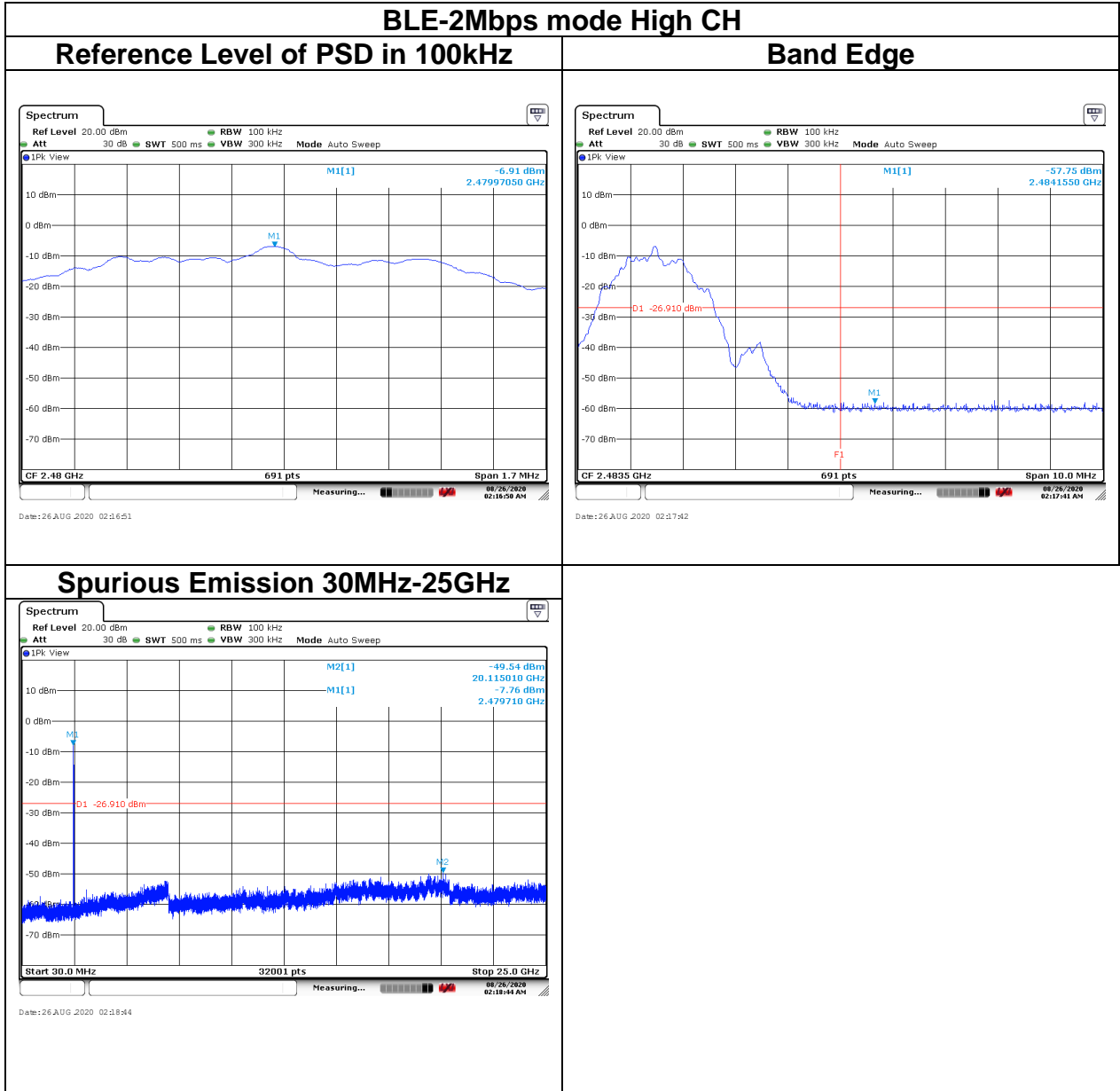

Report No.: T200820W02-RP

## 4.6 RADIATION BANDEDGE AND SPURIOUS EMISSION

### 4.6.1 Test Limit

FCC according to §15.247(d), §15.209 and §15.205,

In any 100 kHz bandwidth outside the authorized frequency band, all harmonic and spurious must be least 20 dB below the highest emission level with the authorized frequency band. Radiation emission which fall in the restricted bands must also follow the FCC section 15.209 as below limit in table.

#### Below 30 MHz

Frequency	Field Strength (microvolts/m)	Magnetic H-Field (microamperes/m)	Measurement Distance (metres)
9-490 kHz	2,400/F (F in kHz)	2,400/F (F in kHz)	300
490-1,705 kHz	24,000/F (F in kHz)	24,000/F (F in kHz)	30
1.705-30 MHz	30	N/A	30

#### Above 30 MHz

Frequency (MHz)	Field Strength microvolts/m at 3 metres (watts, e.i.r.p.)	
	Transmitters	Receivers
30-88	100 (3 nW)	100 (3 nW)
88-216	150 (6.8 nW)	150 (6.8 nW)
216-960	200 (12 nW)	200 (12 nW)
Above 960	500 (75 nW)	500 (75 nW)

Remark:

Although these tests were performed other than open area test site, adequate comparison measurements were confirmed against 30 m open area test site. Therefore sufficient tests were made to demonstrate that the alternative site produces results that correlate with the ones of tests made in an open field based on KDB 414788.

Report No.: T200820W02-RP

## 4.6.2 Test Procedure

Test method Refer as ANSI C63.10:2013.

1. The EUT is placed on a turntable, Above 1 GHz is 1.5m and below 1 GHz is 0.8m above ground plane. The EUT Configured un accordance with ANSI C63.10: 2013, and the EUT set in a continuous mode.
2. The turntable shall be rotated for 360 degrees to determine the position of maximum emission level. And EUT is set 3m away from the receiving antenna, which is scanned from 1m to 4m above the ground plane to find out the highest emissions. Measurement are made polarized in both the vertical and the horizontal positions with antenna.
3. Span shall wide enough to full capture the emission measured. The SA from 9KHz to 26.5GHz set to the low, Mid and High channels with the EUT transmit.

Remark:

1. Although these tests were performed other than open area test site, adequate comparison measurements were confirmed against 30 m open are test site. Therefore sufficient tests were made to demonstrate that the alternative site produces results that correlate with the ones of tests made in an open field based on KDB 414788.
  2. No emission found between lowest internal used/generated frequency to 30MHz (9kHz~30MHz).
4. The SA setting following :
- (1) Below 1G : RBW = 100kHz, VBW  $\geq$  3 RBW, Sweep = Auto, Detector = Peak, Trace = Max hold.
  - (2) Above 1G :
    - (2.1) For Peak measurement : RBW = 1MHz, VBW  $\geq$  3 RBW, Sweep = Auto, Detector = Peak, Trace = Max hold.
    - (2.2) For Average measurement : RBW = 1MHz, VBW
      - 'If Duty Cycle  $\geq$  98%, VBW=10Hz.
      - 'If Duty Cycle < 98%, VBW=1/T.

Report No.: T200820W02-RP

### 4.6.3 Test Setup

#### 9kHz ~ 30MHz

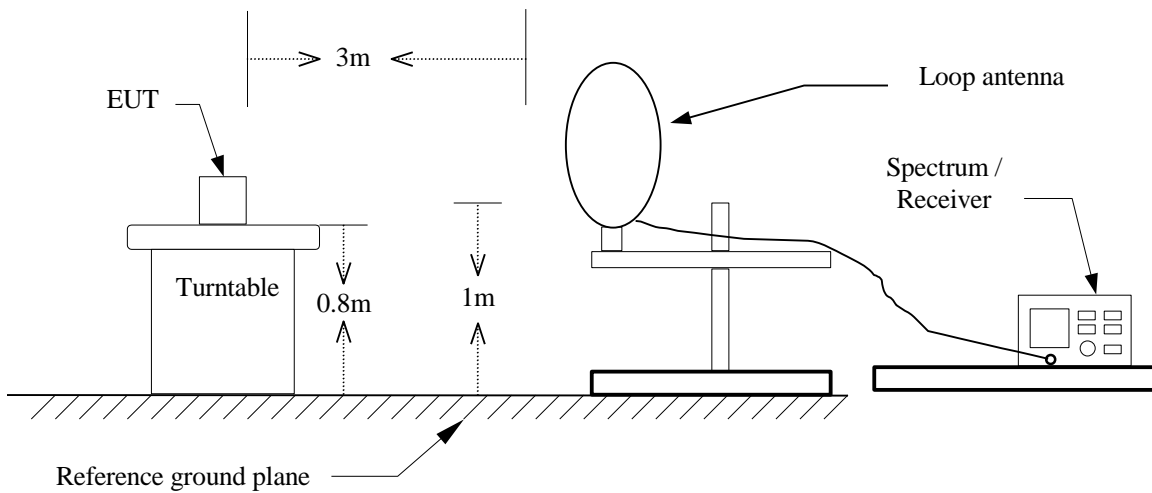

#### 30MHz ~ 1GHz

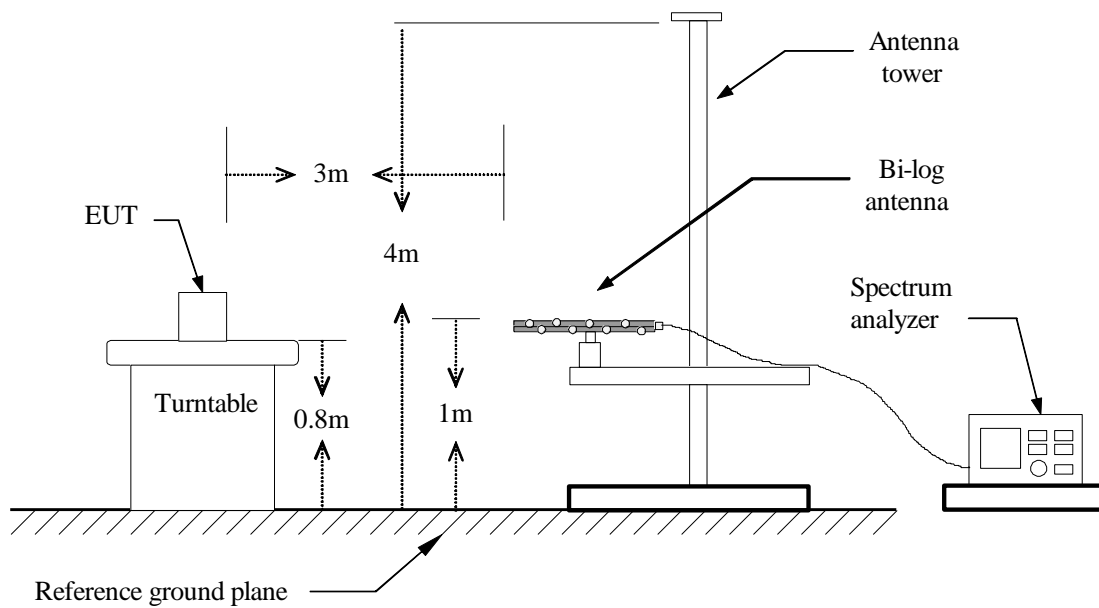

## Above 1 GHz

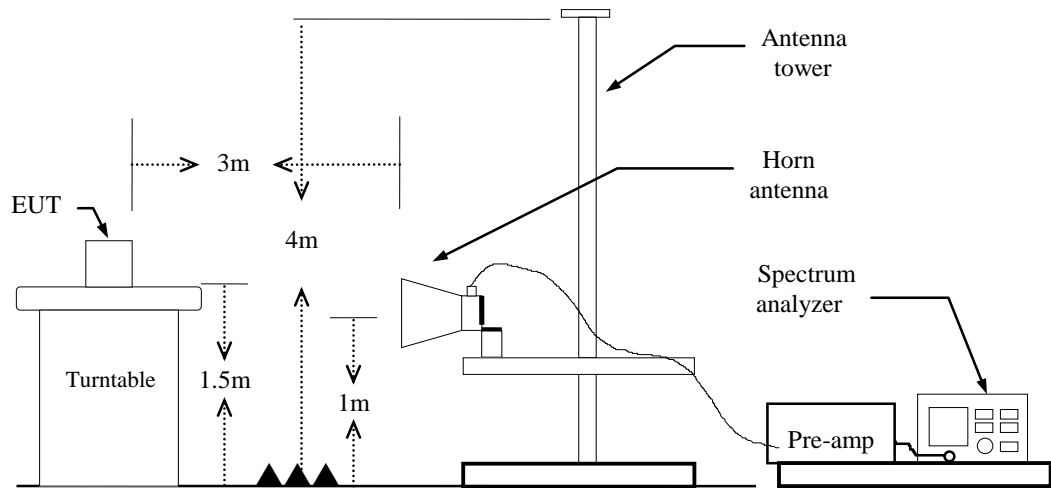

Report No.: T200820W02-RP

### 4.6.4 Test Result

#### Band Edge Test Data

Test Mode:	BLE-1Mbps Low CH	Temp/Hum	22.1(°C)/ 61%RH
Test Item	Band Edge	Test Date	October 19, 2020
Polarize	Vertical	Test Engineer	Jerry Chang
Detector	Peak / Average		

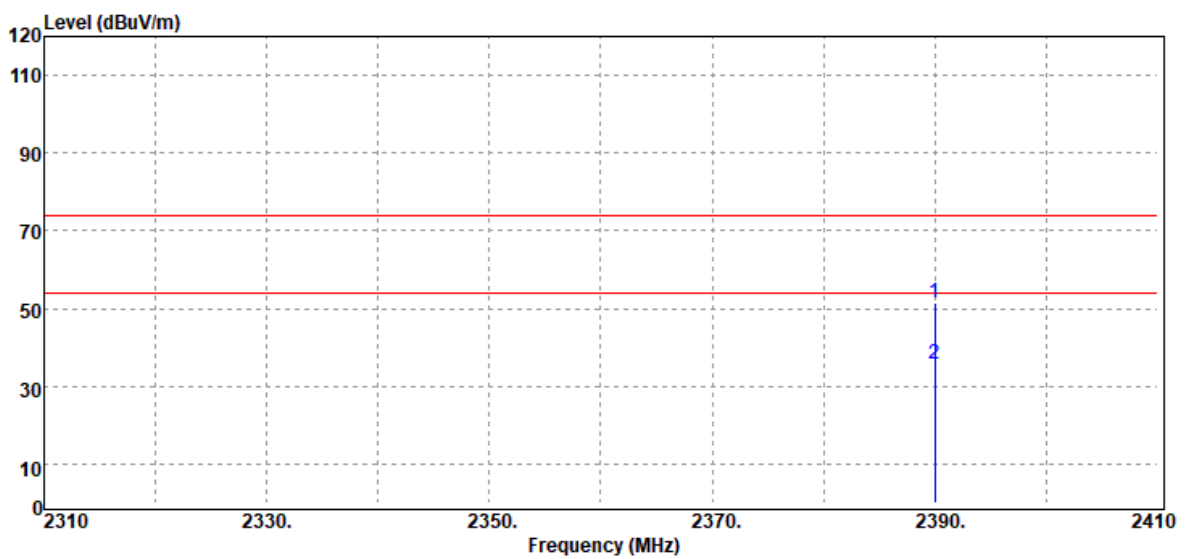

Freq. MHz	Detector Mode PK/QP/AV	Spectrum Reading Level dB $\mu$ V	Factor dB	Actual FS dB $\mu$ V/m	Limit @3m dB $\mu$ V/m	Margin dB
2390.00	Peak	54.60	-3.23	51.37	74.00	-22.63
2390.00	Average	38.95	-3.23	35.72	54.00	-18.28



Report No.: T200820W02-RP

Test Mode:	BLE-1Mbps Low CH	Temp/Hum	22.1(°C)/ 61%RH
Test Item	Band Edge	Test Date	October 19, 2020
Polarize	Horizontal	Test Engineer	Jerry Chang
Detector	Peak / Average		

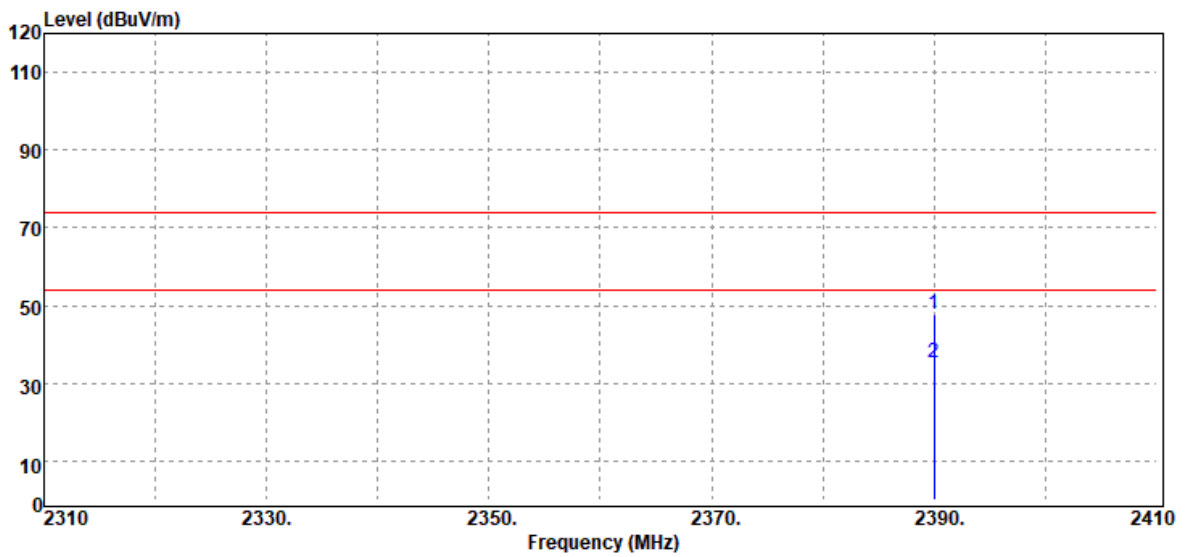

Freq. MHz	Detector Mode PK/QP/AV	Spectrum Reading Level dB $\mu$ V	Factor dB	Actual FS dB $\mu$ V/m	Limit @3m dB $\mu$ V/m	Margin dB
2390.00	Peak	50.94	-3.23	47.71	74.00	-26.29
2390.00	Average	38.67	-3.23	35.44	54.00	-18.56

Report No.: T200820W02-RP

Test Mode:	BLE-1Mbps High CH	Temp/Hum	22.1(°C)/ 61%RH
Test Item	Band Edge	Test Date	October 19, 2020
Polarize	Vertical	Test Engineer	Jerry Chang
Detector	Peak / Average		

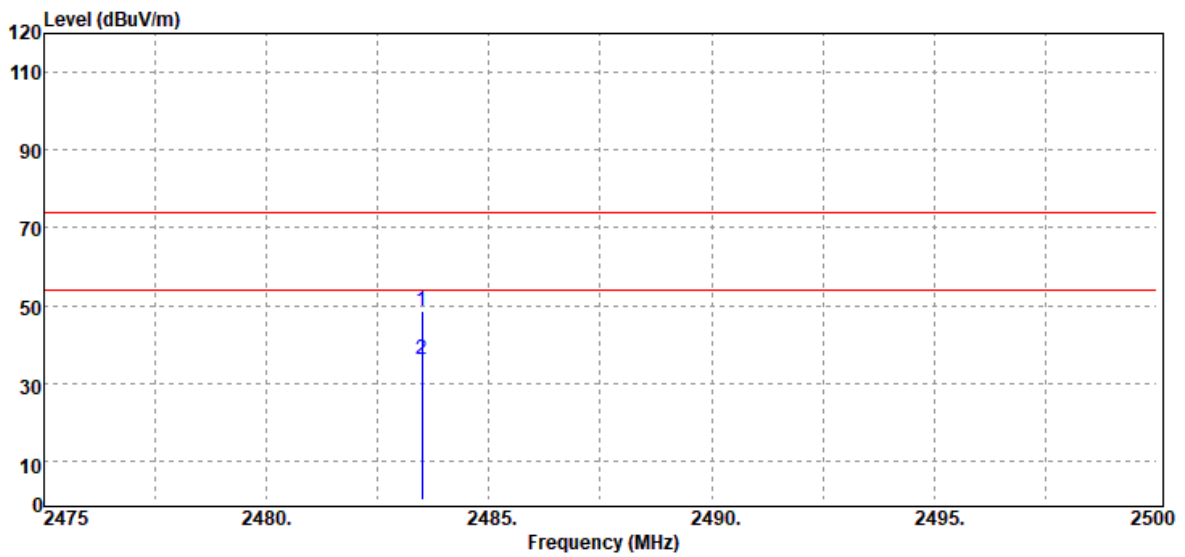

Freq. MHz	Detector Mode PK/QP/AV	Spectrum Reading Level dB $\mu$ V	Factor dB	Actual FS dB $\mu$ V/m	Limit @3m dB $\mu$ V/m	Margin dB
2483.50	Peak	51.29	-2.85	48.44	74.00	-25.56
2483.50	Average	39.14	-2.85	36.29	54.00	-17.71

Report No.: T200820W02-RP

Test Mode:	BLE-1Mbps High CH	Temp/Hum	22.1(°C)/ 61%RH
Test Item	Band Edge	Test Date	October 19, 2020
Polarize	Horizontal	Test Engineer	Jerry Chang
Detector	Peak / Average		

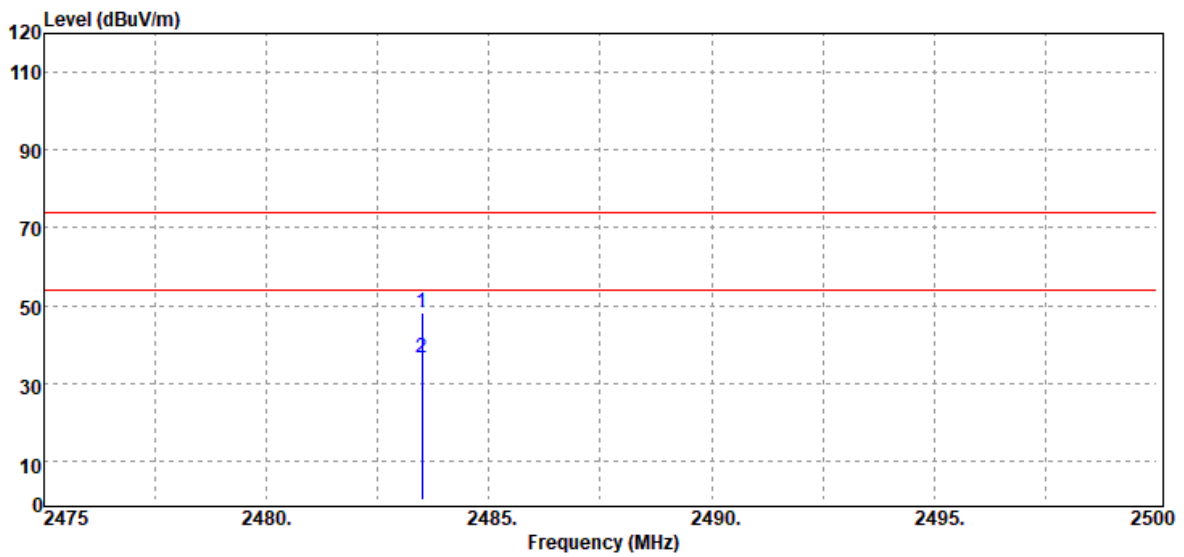

Freq. MHz	Detector Mode PK/QP/AV	Spectrum Reading Level dB $\mu$ V	Factor dB	Actual FS dB $\mu$ V/m	Limit @3m dB $\mu$ V/m	Margin dB
2483.50	Peak	50.98	-2.85	48.13	74.00	-25.87
2483.50	Average	39.28	-2.85	36.43	54.00	-17.57

Report No.: T200820W02-RP

Test Mode:	BLE-2Mbps Low CH	Temp/Hum	22.6(°C)/ 64%RH
Test Item	Band Edge	Test Date	October 19, 2020
Polarize	Vertical	Test Engineer	Jerry Chang
Detector	Peak / Average		

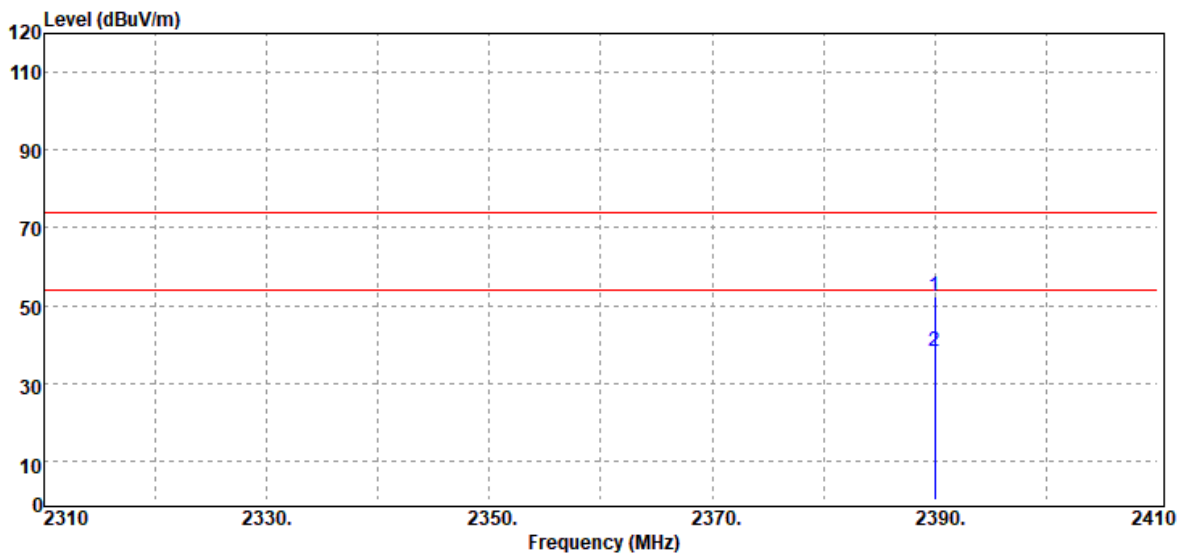

Freq. MHz	Detector Mode PK/QP/AV	Spectrum Reading Level dB $\mu$ V	Factor dB	Actual FS dB $\mu$ V/m	Limit @3m dB $\mu$ V/m	Margin dB
2390.00	Peak	55.77	-3.31	52.46	74.00	-21.54
2390.00	Average	41.67	-3.31	38.36	54.00	-15.64

Report No.: T200820W02-RP

Test Mode:	BLE-2Mbps Low CH	Temp/Hum	22.6(°C)/ 64%RH
Test Item	Band Edge	Test Date	October 19, 2020
Polarize	Horizontal	Test Engineer	Jerry Chang
Detector	Peak / Average		

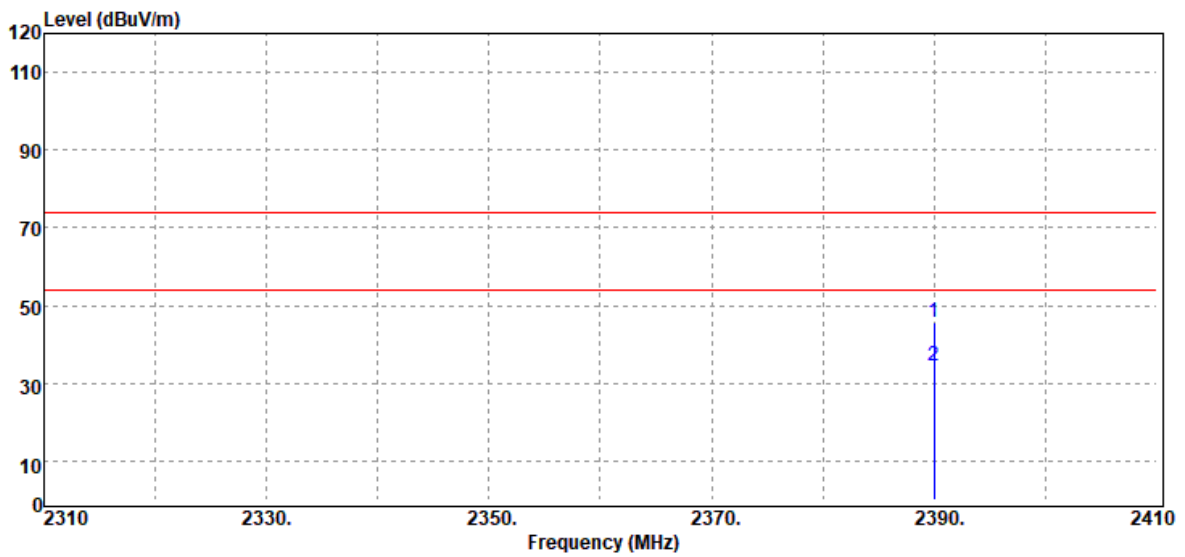

Freq. MHz	Detector Mode PK/QP/AV	Spectrum Reading Level dB $\mu$ V	Factor dB	Actual FS dB $\mu$ V/m	Limit @3m dB $\mu$ V/m	Margin dB
2390.00	Peak	48.84	-3.31	45.53	74.00	-28.47
2390.00	Average	37.85	-3.31	34.54	54.00	-19.46

Report No.: T200820W02-RP

Test Mode:	BLE-2Mbps High CH	Temp/Hum	22.6(°C)/ 64%RH
Test Item	Band Edge	Test Date	October 19, 2020
Polarize	Vertical	Test Engineer	Jerry Chang
Detector	Peak / Average		

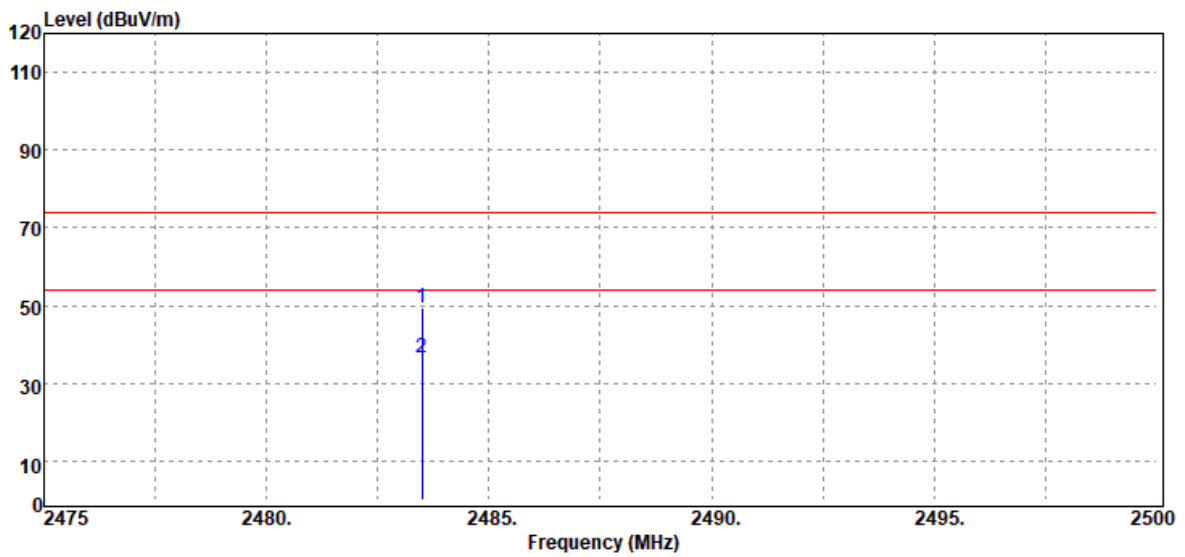

Freq. MHz	Detector Mode PK/QP/AV	Spectrum Reading Level dB $\mu$ V	Factor dB	Actual FS dB $\mu$ V/m	Limit @3m dB $\mu$ V/m	Margin dB
2483.50	Peak	52.47	-2.85	49.62	74.00	-24.38
2483.50	Average	39.54	-2.85	36.69	54.00	-17.31

Report No.: T200820W02-RP

Test Mode:	BLE-2Mbps High CH	Temp/Hum	22.6(°C)/ 64%RH
Test Item	Band Edge	Test Date	October 19, 2020
Polarize	Horizontal	Test Engineer	Jerry Chang
Detector	Peak / Average		

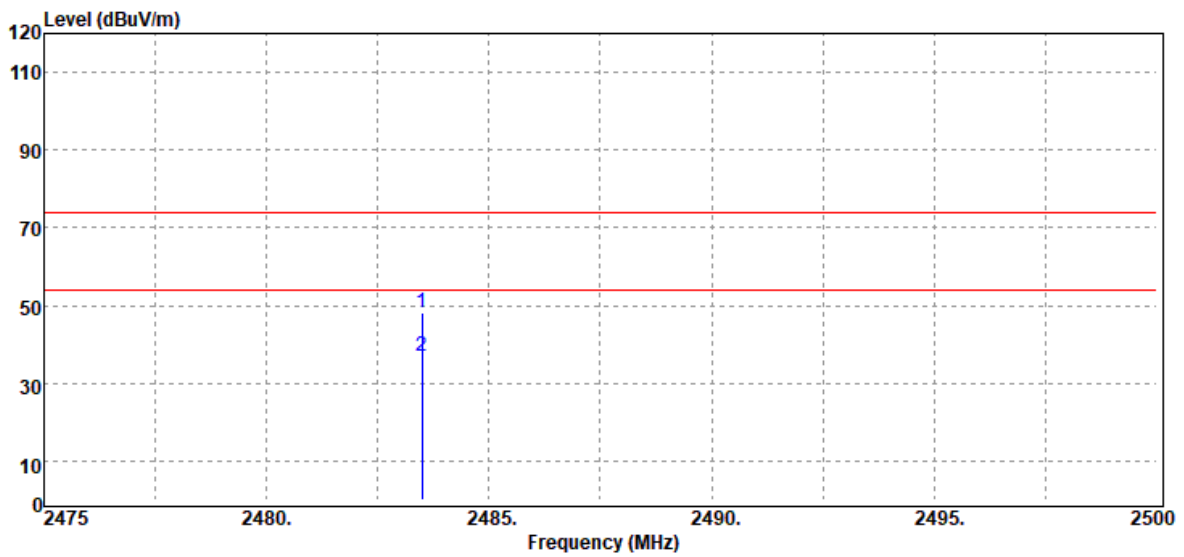

Freq. MHz	Detector Mode PK/QP/AV	Spectrum Reading Level dB $\mu$ V	Factor dB	Actual FS dB $\mu$ V/m	Limit @3m dB $\mu$ V/m	Margin dB
2483.50	Peak	50.98	-2.85	48.13	74.00	-25.87
2483.50	Average	39.82	-2.85	36.97	54.00	-17.03

Report No.: T200820W02-RP

**Below 1G Test Data**

Test Mode:	BLE-1Mbps Mode	Temp/Hum	22.1(°C)/ 61%RH
Test Item	30MHz-1GHz	Test Date	October 19, 2020
Polarize	Vertical	Test Engineer	Ray Li
Detector	Peak		

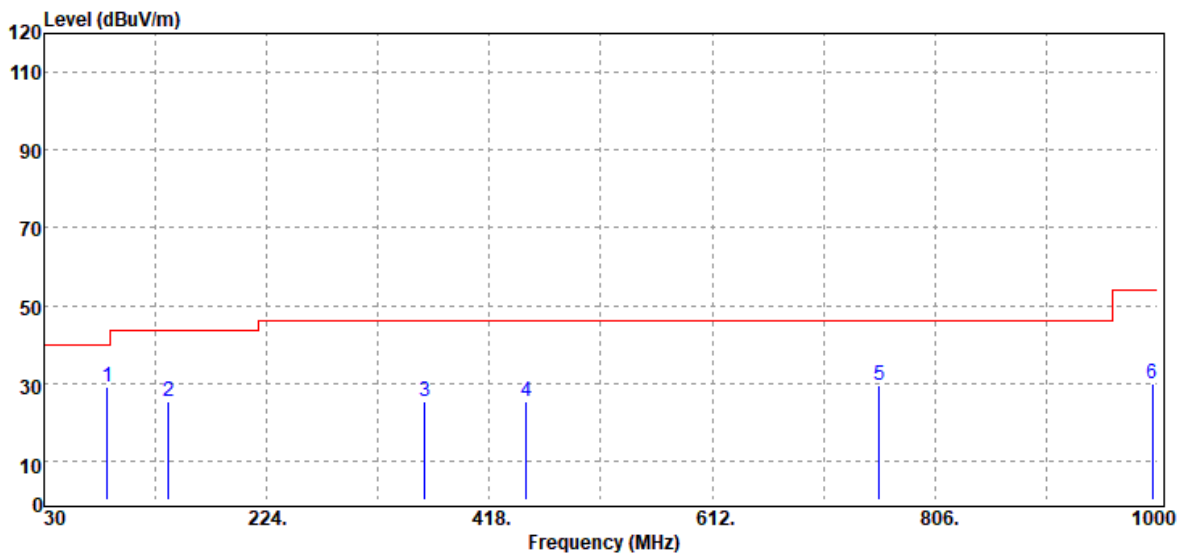

Freq. MHz	Detector Mode PK/QP/AV	Spectrum Reading Level dBμV	Factor dB	Actual FS dBμV/m	Limit @3m dBμV/m	Margin dB
85.29	Peak	44.82	-15.77	29.05	40.00	-10.95
138.64	Peak	35.00	-9.76	25.24	43.50	-18.26
361.74	Peak	31.95	-6.72	25.23	46.00	-20.77
450.01	Peak	29.54	-4.26	25.28	46.00	-20.72
757.50	Peak	28.73	0.95	29.68	46.00	-16.32
995.15	Peak	25.46	4.60	30.06	54.00	-23.94

Note: No emission found between lowest internal used/generated frequency to 30MHz (9kHz~30MHz).



Report No.: T200820W02-RP

Test Mode:	BLE-1Mbps Mode	Temp/Hum	22.1(°C)/ 61%RH
Test Item	30MHz-1GHz	Test Date	October 19, 2020
Polarize	Horizontal	Test Engineer	Ray Li
Detector	Peak		

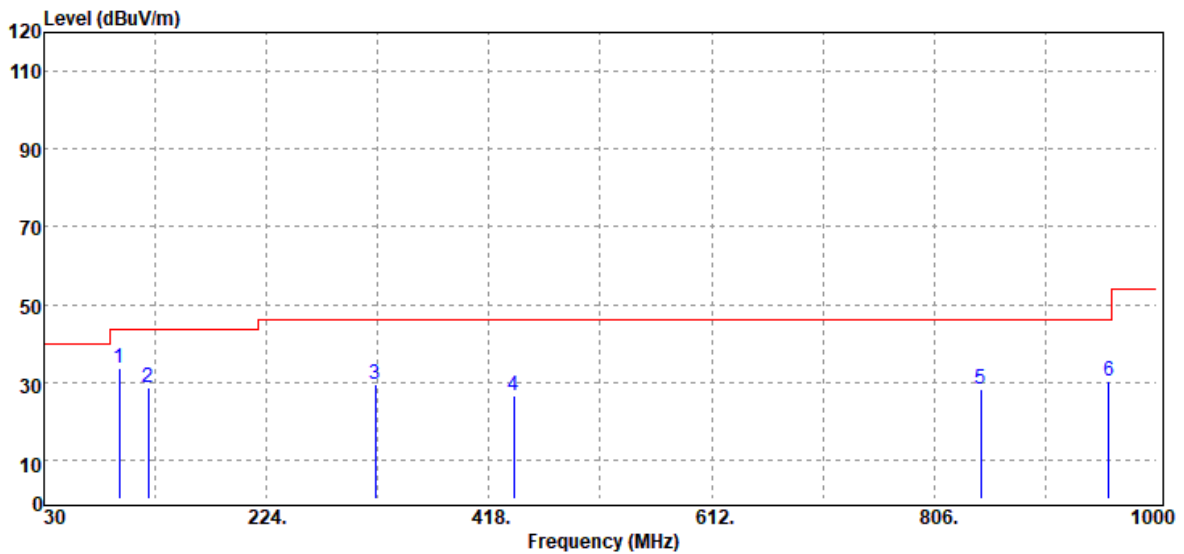

Freq. MHz	Detector Mode PK/QP/AV	Spectrum Reading Level dB $\mu$ V	Factor dB	Actual FS dB $\mu$ V/m	Limit @3m dB $\mu$ V/m	Margin dB
95.96	Peak	47.89	-14.22	33.67	43.50	-9.83
121.18	Peak	38.08	-9.22	28.86	43.50	-14.64
319.06	Peak	37.52	-7.89	29.63	46.00	-16.37
439.34	Peak	30.97	-4.54	26.43	46.00	-19.57
846.74	Peak	25.97	2.47	28.44	46.00	-17.56
958.29	Peak	26.45	3.79	30.24	46.00	-15.76

Note: No emission found between lowest internal used/generated frequency to 30MHz (9kHz~30MHz).

Report No.: T200820W02-RP

Test Mode:	BLE-2Mbps Mode	Temp/Hum	22.6(°C)/ 64%RH
Test Item	30MHz-1GHz	Test Date	October 19, 2020
Polarize	Vertical	Test Engineer	Jerry Chang
Detector	Peak		

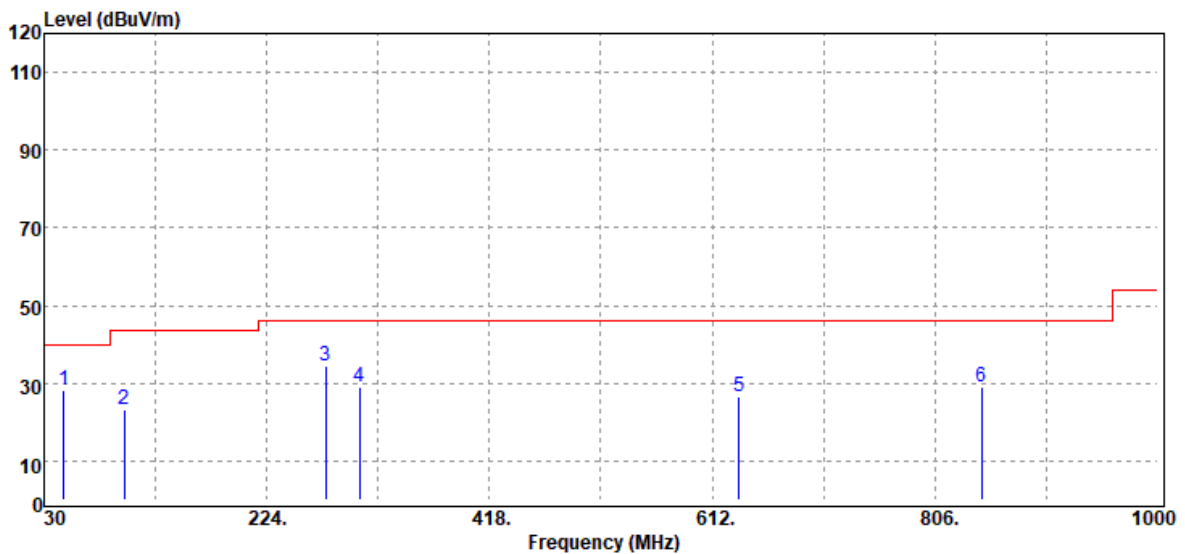

Freq. MHz	Detector Mode PK/QP/AV	Spectrum Reading Level dBuV	Factor dB	Actual FS dBuV/m	Limit @3m dBuV/m	Margin dB
47.46	Peak	42.46	-14.32	28.14	40.00	-11.86
99.84	Peak	36.22	-12.91	23.31	43.50	-20.19
275.41	Peak	43.38	-8.78	34.60	46.00	-11.40
304.51	Peak	37.51	-8.46	29.05	46.00	-16.95
635.28	Peak	26.94	-0.49	26.45	46.00	-19.55
846.74	Peak	26.60	2.47	29.07	46.00	-16.93

Note: No emission found between lowest internal used/generated frequency to 30MHz (9kHz~30MHz).

Report No.: T200820W02-RP

Test Mode:	BLE-2Mbps Mode	Temp/Hum	22.6(°C)/ 64%RH
Test Item	30MHz-1GHz	Test Date	October 19, 2020
Polarize	Horizontal	Test Engineer	Jerry Chang
Detector	Peak		

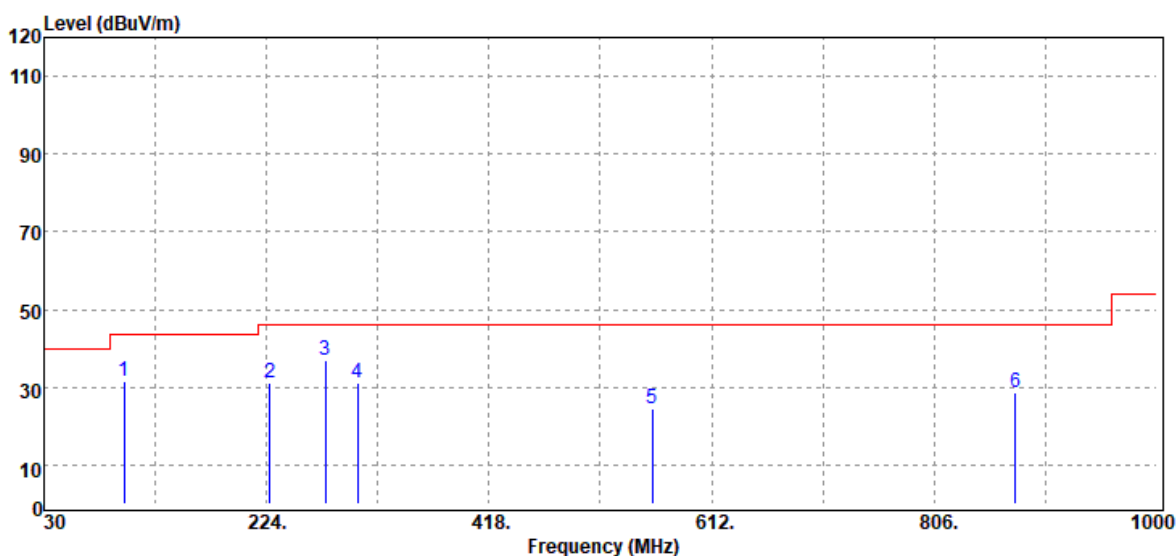

Freq. MHz	Detector Mode PK/QP/AV	Spectrum Reading Level dBμV	Factor dB	Actual FS dBμV/m	Limit @3m dBμV/m	Margin dB
99.84	Peak	44.58	-12.91	31.67	43.50	-11.83
226.91	Peak	42.71	-11.38	31.33	46.00	-14.67
275.41	Peak	45.93	-8.78	37.15	46.00	-8.85
303.54	Peak	39.75	-8.50	31.25	46.00	-14.75
560.59	Peak	26.97	-2.35	24.62	46.00	-21.38
876.81	Peak	25.88	2.67	28.55	46.00	-17.45

Note: No emission found between lowest internal used/generated frequency to 30MHz (9kHz~30MHz).

Report No.: T200820W02-RP

**Above 1G Test Data**

Test Mode:	BLE-1Mbps Low CH	Temp/Hum	22.1(°C)/ 61%RH
Test Item	Harmonic	Test Date	October 16, 2020
Polarize	Vertical	Test Engineer	Jerry Chang
Detector	Peak and Average		

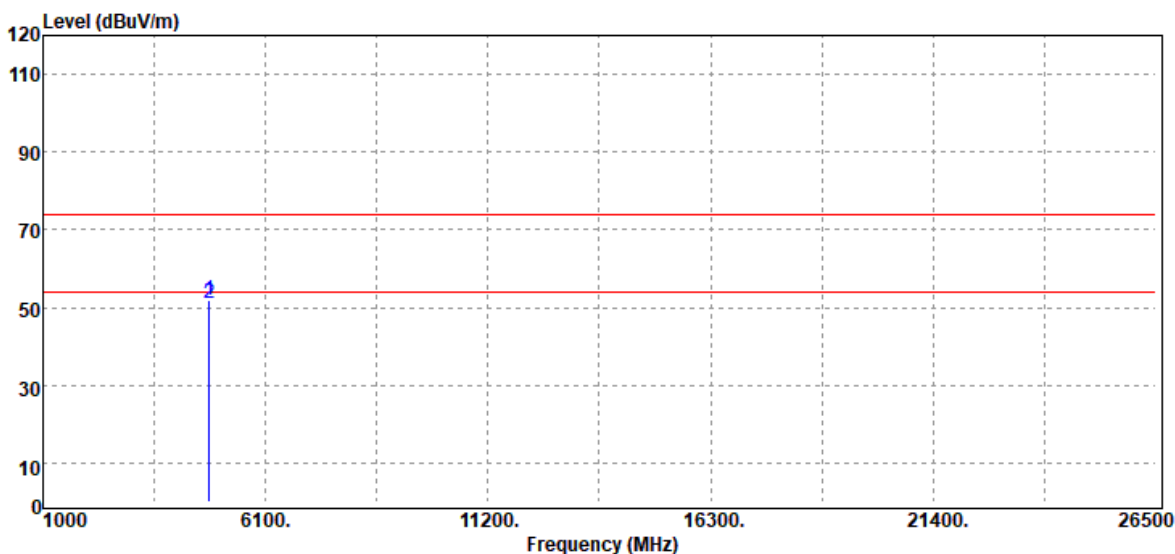

Freq. MHz	Detector Mode PK/QP/AV	Spectrum Reading Level dBμV	Factor dB	Actual FS dBμV/m	Limit @3m dBμV/m	Margin dB
4804.00	Peak	48.53	3.32	51.85	74.00	-22.15
4804.00	Average	47.57	3.32	50.89	54.00	-3.11
N/A						

**Remark:**

1. Measuring frequencies from 1 GHz to the 10th harmonic of highest fundamental frequency.

Report No.: T200820W02-RP

Test Mode:	BLE-1Mbps Low CH	Temp/Hum	22.1(°C)/ 61%RH
Test Item	Harmonic	Test Date	October 16, 2020
Polarize	Horizontal	Test Engineer	Jerry Chang
Detector	Peak and Average		

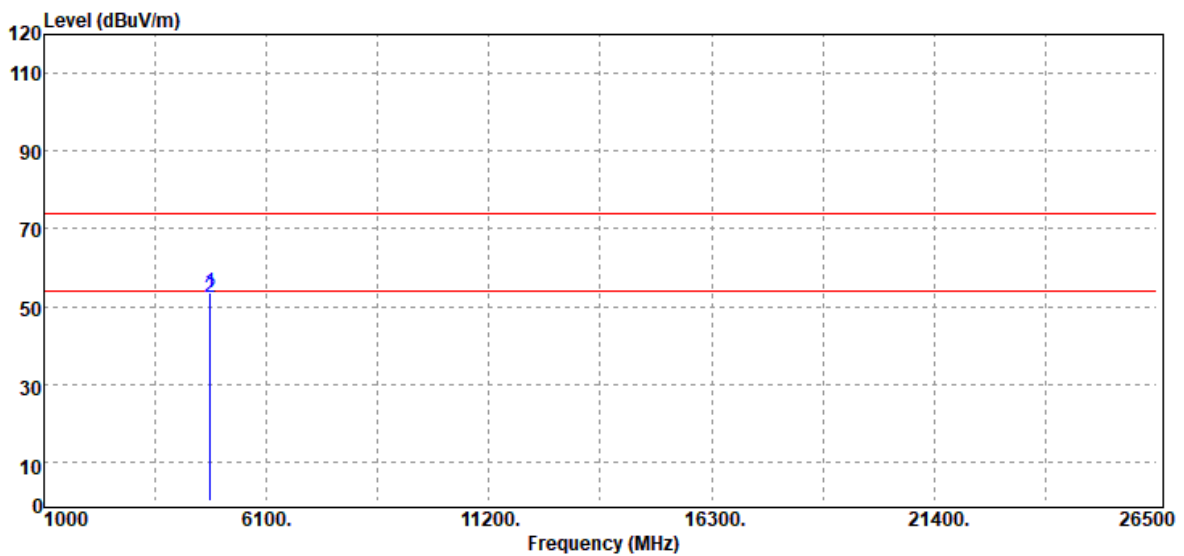

Freq. MHz	Detector Mode PK/QP/AV	Spectrum Reading Level dB $\mu$ V	Factor dB	Actual FS dB $\mu$ V/m	Limit @3m dB $\mu$ V/m	Margin dB
4804.00	Peak	50.10	3.32	53.42	74.00	-20.58
4804.00	Average	49.14	3.32	52.46	54.00	-1.54
N/A						

**Remark:**

1. Measuring frequencies from 1 GHz to the 10th harmonic of highest fundamental frequency.

Report No.: T200820W02-RP

Test Mode:	BLE-1Mbps Mid CH	Temp/Hum	22.1(°C)/ 61%RH
Test Item	Harmonic	Test Date	October 19, 2020
Polarize	Vertical	Test Engineer	Jerry Chang
Detector	Peak		

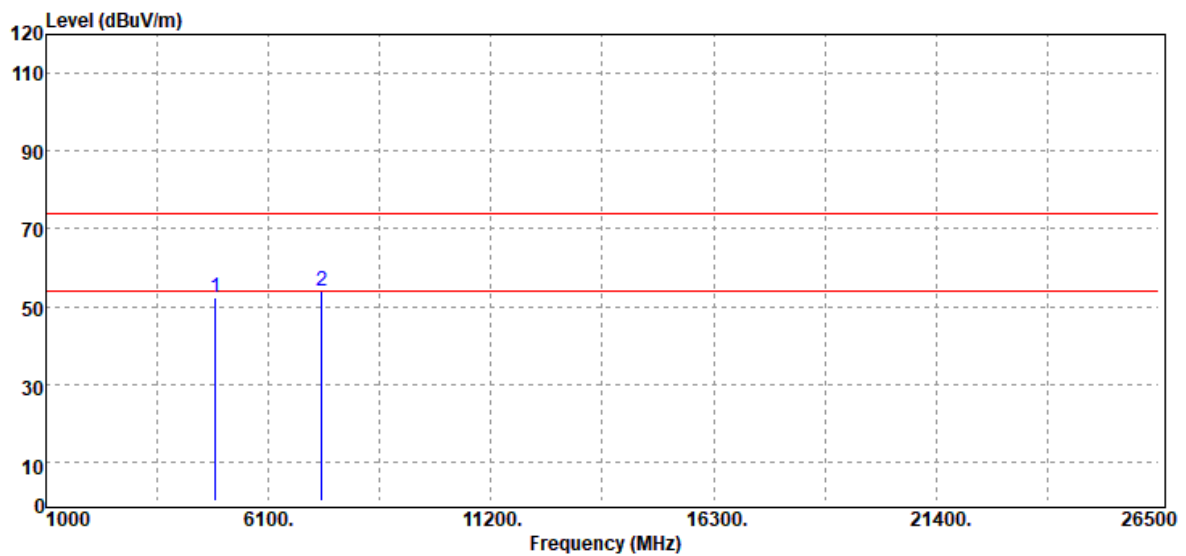

Freq. MHz	Detector Mode PK/QP/AV	Spectrum Reading Level dB $\mu$ V	Factor dB	Actual FS dB $\mu$ V/m	Limit @3m dB $\mu$ V/m	Margin dB
4880.00	Peak	49.04	3.48	52.52	74.00	-21.48
7320.00	Peak	42.84	11.06	53.90	74.00	-20.10
N/A						

**Remark:**

1. Measuring frequencies from 1 GHz to the 10th harmonic of highest fundamental frequency.
2. For above 1GHz, the EUT peak value was under average limit, therefore the Average value compliance with the average limit

Report No.: T200820W02-RP

Test Mode:	BLE-1Mbps Mid CH	Temp/Hum	22.1(°C)/ 61%RH
Test Item	Harmonic	Test Date	October 19, 2020
Polarize	Horizontal	Test Engineer	Jerry Chang
Detector	Peak and Average		

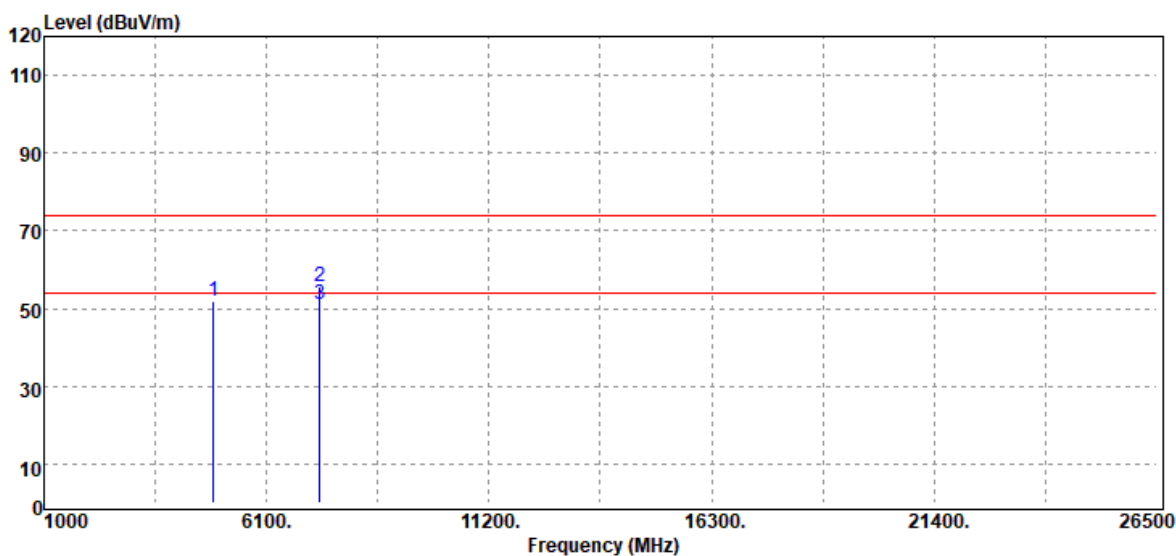

Freq. MHz	Detector Mode PK/QP/AV	Spectrum Reading Level dB $\mu$ V	Factor dB	Actual FS dB $\mu$ V/m	Limit @3m dB $\mu$ V/m	Margin dB
4880.00	Peak	48.39	3.48	51.87	74.00	-22.13
7320.00	Peak	44.60	11.06	55.66	74.00	-18.34
7320.00	Average	40.12	11.06	51.18	54.00	-2.82
N/A						

**Remark:**

1. Measuring frequencies from 1 GHz to the 10th harmonic of highest fundamental frequency.

Report No.: T200820W02-RP

Test Mode:	BLE-1Mbps High CH	Temp/Hum	22.1(°C)/ 61%RH
Test Item	Harmonic	Test Date	October 19, 2020
Polarize	Vertical	Test Engineer	Jerry Chang
Detector	Peak		

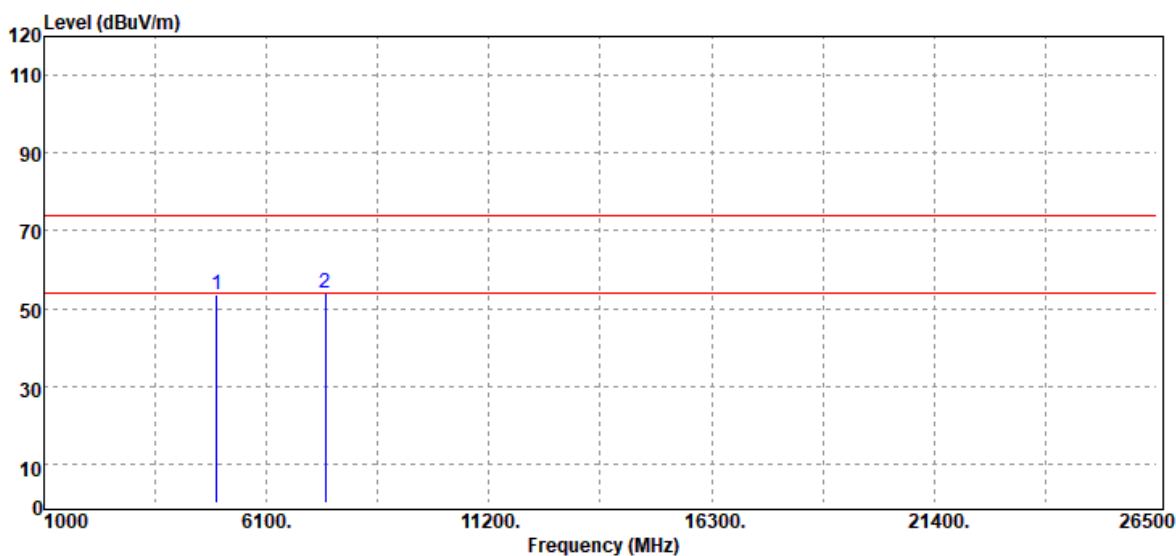

Freq. MHz	Detector Mode PK/QP/AV	Spectrum Reading Level dB $\mu$ V	Factor dB	Actual FS dB $\mu$ V/m	Limit @3m dB $\mu$ V/m	Margin dB
4960.00	Peak	49.26	4.44	53.70	74.00	-20.30
7440.00	Peak	43.02	10.76	53.78	74.00	-20.22
N/A						

**Remark:**

1. Measuring frequencies from 1 GHz to the 10th harmonic of highest fundamental frequency.
2. For above 1GHz, the EUT peak value was under average limit, therefore the Average value compliance with the average limit



Report No.: T200820W02-RP

Test Mode:	BLE-1Mbps High CH	Temp/Hum	22.1(°C)/ 61%RH
Test Item	Harmonic	Test Date	October 19, 2020
Polarize	Horizontal	Test Engineer	Jerry Chang
Detector	Peak and Average		

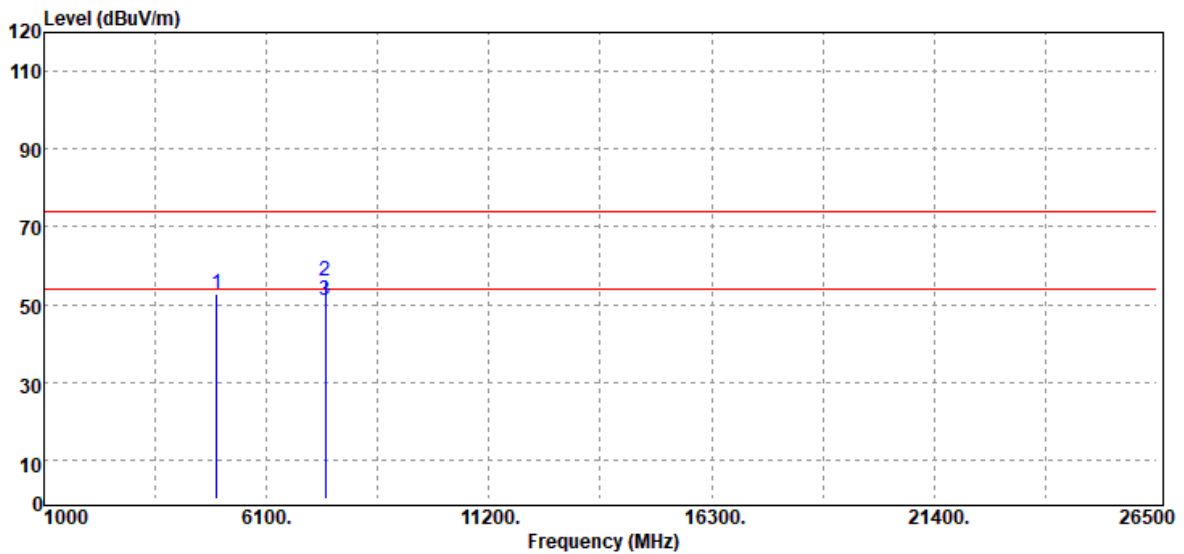

Freq. MHz	Detector Mode PK/QP/AV	Spectrum Reading Level dB $\mu$ V	Factor dB	Actual FS dB $\mu$ V/m	Limit @3m dB $\mu$ V/m	Margin dB
4960.00	Peak	48.16	4.44	52.60	74.00	-21.40
7440.00	Peak	45.22	10.76	55.98	74.00	-18.02
7440.00	Average	40.46	10.76	51.22	54.00	-2.78
N/A						

**Remark:**

1. Measuring frequencies from 1 GHz to the 10th harmonic of highest fundamental frequency.

Report No.: T200820W02-RP

Test Mode:	BLE-2Mbps Low CH	Temp/Hum	22.6(°C)/ 64%RH
Test Item	Harmonic	Test Date	October 19, 2020
Polarize	Vertical	Test Engineer	Jerry Chang
Detector	Peak		

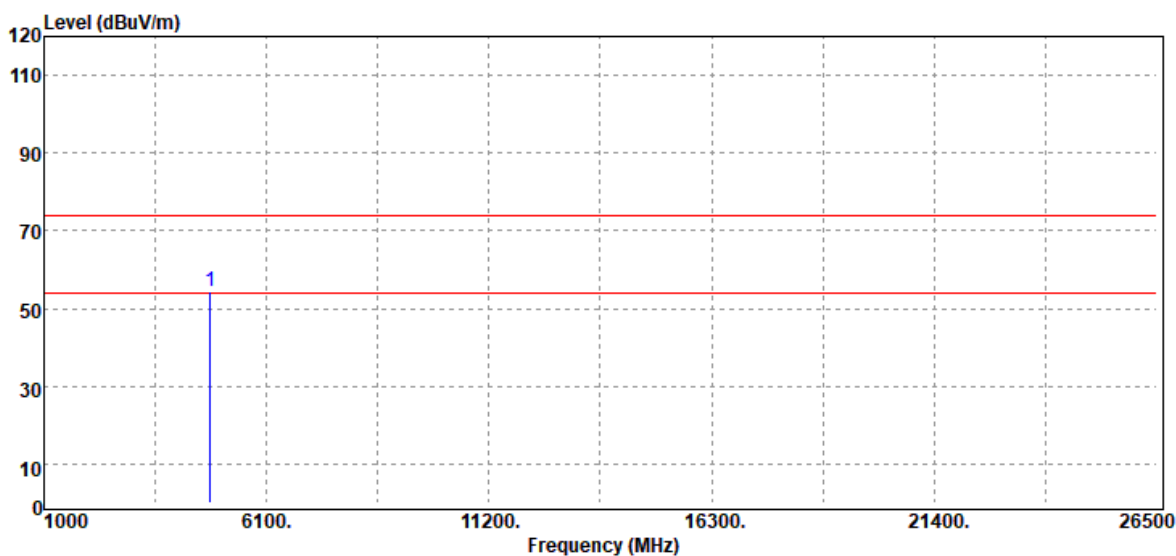

Freq. MHz	Detector Mode PK/QP/AV	Spectrum Reading Level dB $\mu$ V	Factor dB	Actual FS dB $\mu$ V/m	Limit @3m dB $\mu$ V/m	Margin dB
4804.00	Peak	51.24	3.32	54.56	74.00	-19.44
N/A						

**Remark:**

1. Measuring frequencies from 1 GHz to the 10th harmonic of highest fundamental frequency.
2. For above 1GHz, the EUT peak value was under average limit, therefore the Average value compliance with the average limit

Report No.: T200820W02-RP

Test Mode:	BLE-2Mbps Low CH	Temp/Hum	22.6(°C)/ 64%RH
Test Item	Harmonic	Test Date	October 19, 2020
Polarize	Horizontal	Test Engineer	Jerry Chang
Detector	Peak and Average		

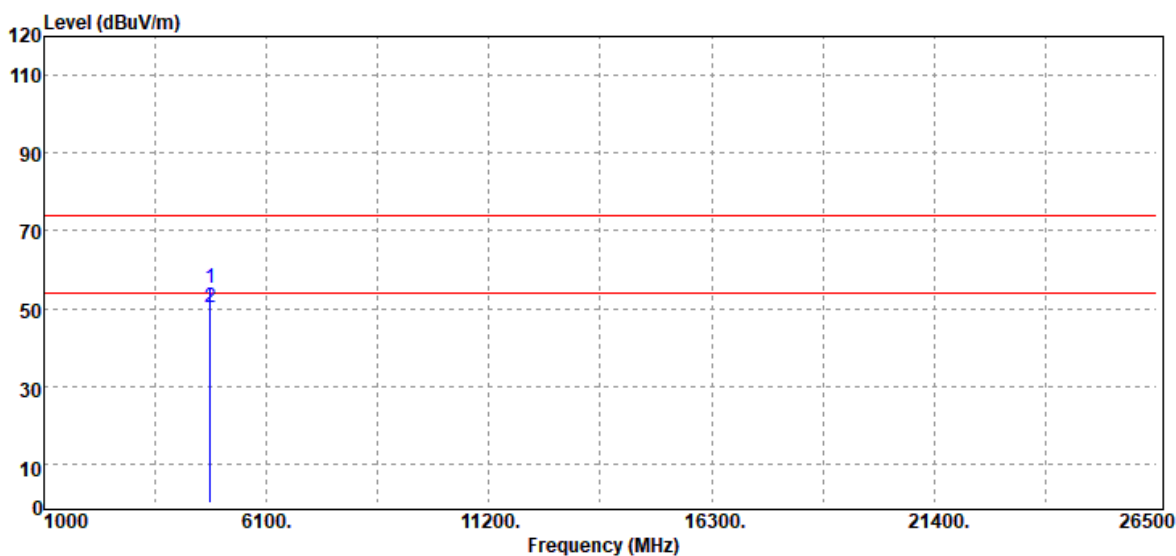

Freq. MHz	Detector Mode PK/QP/AV	Spectrum Reading Level dB $\mu$ V	Factor dB	Actual FS dB $\mu$ V/m	Limit @3m dB $\mu$ V/m	Margin dB
4804.00	Peak	51.89	3.32	55.21	74.00	-18.79
4804.00	Average	47.05	3.32	50.37	54.00	-3.63
N/A						

**Remark:**

1. Measuring frequencies from 1 GHz to the 10th harmonic of highest fundamental frequency.

Report No.: T200820W02-RP

Test Mode:	BLE-2Mbps Mid CH	Temp/Hum	22.6(°C)/ 64%RH
Test Item	Harmonic	Test Date	October 19, 2020
Polarize	Vertical	Test Engineer	Jerry Chang
Detector	Peak and Average		

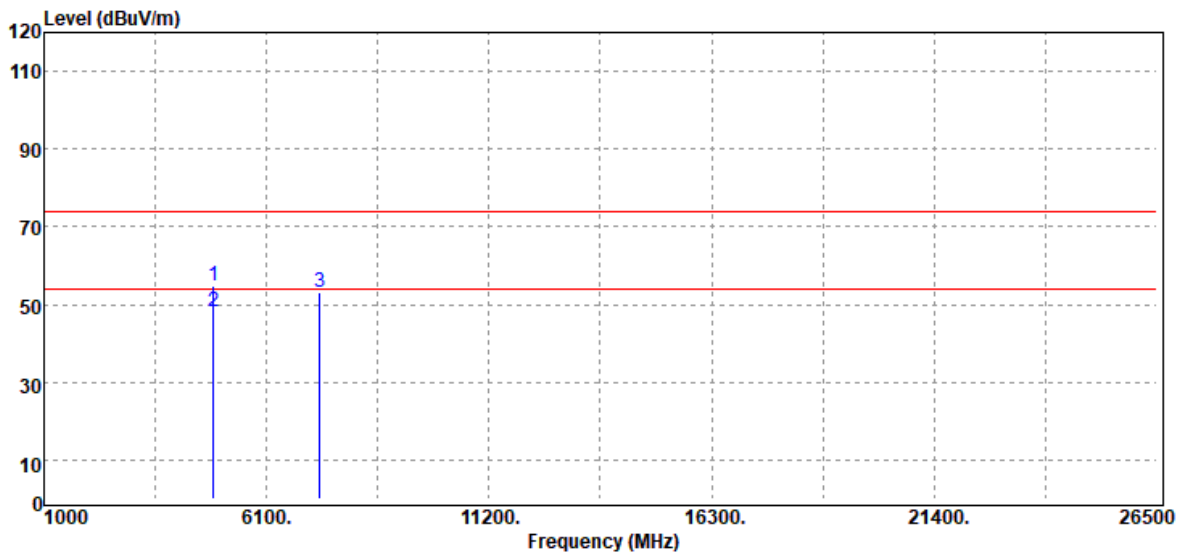

Freq. MHz	Detector Mode PK/QP/AV	Spectrum Reading Level dB $\mu$ V	Factor dB	Actual FS dB $\mu$ V/m	Limit @3m dB $\mu$ V/m	Margin dB
4880.00	Peak	51.30	3.48	54.78	74.00	-19.22
4880.00	Average	44.75	3.48	48.23	54.00	-5.77
7320.00	Peak	42.20	11.06	53.26	74.00	-20.74
N/A						

**Remark:**

1. Measuring frequencies from 1 GHz to the 10th harmonic of highest fundamental frequency.

Report No.: T200820W02-RP

Test Mode:	BLE-2Mbps Mid CH	Temp/Hum	22.6(°C)/ 64%RH
Test Item	Harmonic	Test Date	October 19, 2020
Polarize	Horizontal	Test Engineer	Jerry Chang
Detector	Peak and Average		

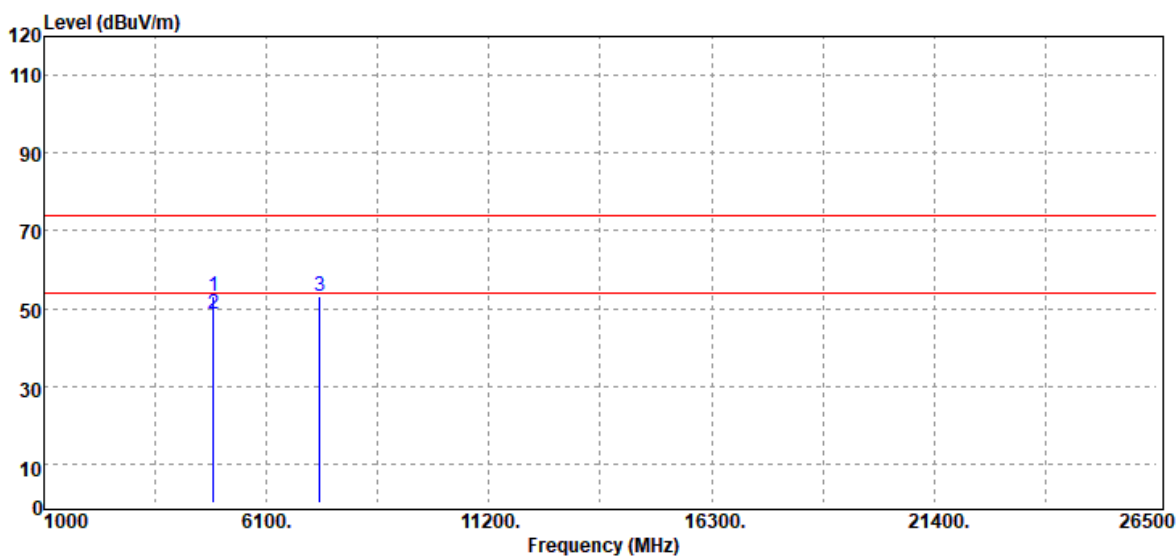

Freq. MHz	Detector Mode PK/QP/AV	Spectrum Reading Level dB $\mu$ V	Factor dB	Actual FS dB $\mu$ V/m	Limit @3m dB $\mu$ V/m	Margin dB
4880.00	Peak	49.51	3.48	52.99	74.00	-21.01
4880.00	Average	44.91	3.48	48.39	54.00	-5.61
7320.00	Peak	41.93	11.06	52.99	74.00	-21.01
N/A						

**Remark:**

1. Measuring frequencies from 1 GHz to the 10th harmonic of highest fundamental frequency.

Report No.: T200820W02-RP

Test Mode:	BLE-2Mbps High CH	Temp/Hum	22.6(°C)/ 64%RH
Test Item	Harmonic	Test Date	October 19, 2020
Polarize	Vertical	Test Engineer	Jerry Chang
Detector	Peak and Average		

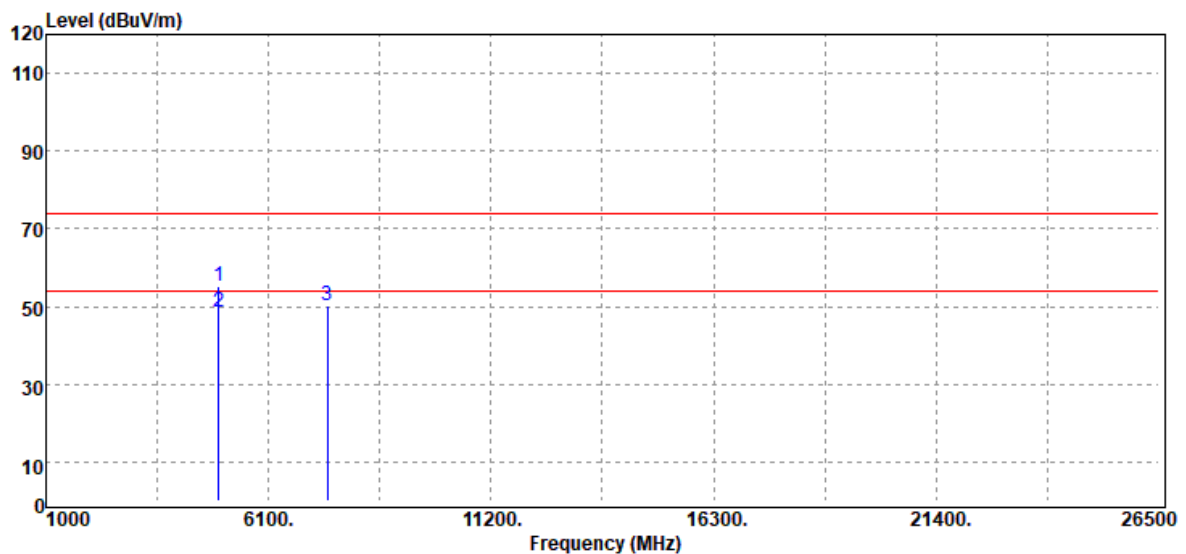

Freq. MHz	Detector Mode PK/QP/AV	Spectrum Reading Level dB $\mu$ V	Factor dB	Actual FS dB $\mu$ V/m	Limit @3m dB $\mu$ V/m	Margin dB
4960.00	Peak	50.69	4.44	55.13	74.00	-18.87
4960.00	Average	44.10	4.44	48.54	54.00	-5.46
7440.00	Peak	39.57	10.76	50.33	74.00	-23.67
N/A						

**Remark:**

1. Measuring frequencies from 1 GHz to the 10th harmonic of highest fundamental frequency.

Report No.: T200820W02-RP

Test Mode:	BLE-2Mbps High CH	Temp/Hum	22.6(°C)/ 64%RH
Test Item	Harmonic	Test Date	October 19, 2020
Polarize	Horizontal	Test Engineer	Jerry Chang
Detector	Peak and Average		

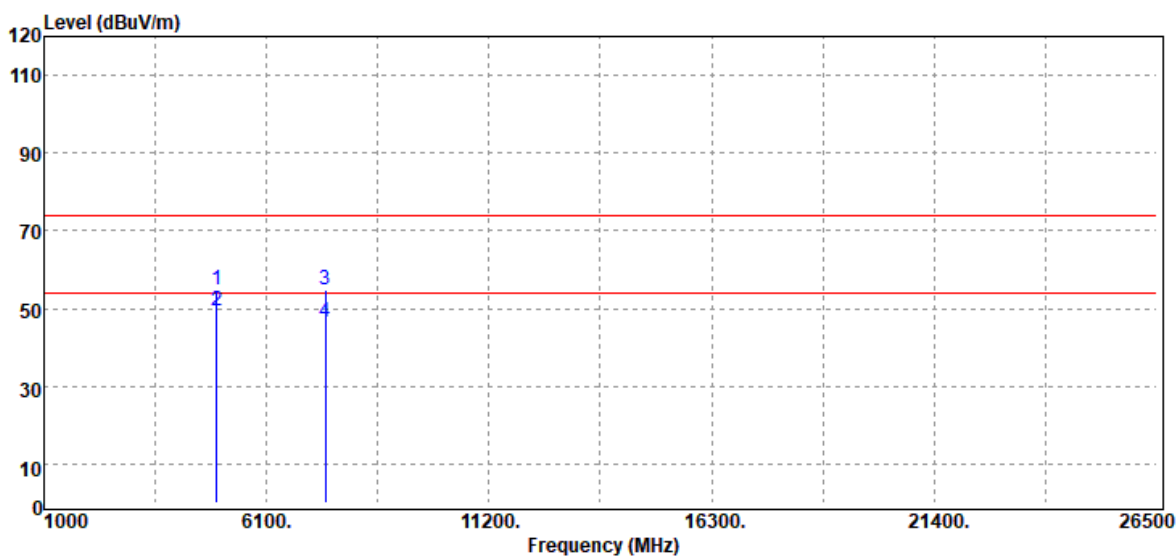

Freq. MHz	Detector Mode PK/QP/AV	Spectrum Reading Level dB $\mu$ V	Factor dB	Actual FS dB $\mu$ V/m	Limit @3m dB $\mu$ V/m	Margin dB
4960.00	Peak	50.53	4.44	54.97	74.00	-19.03
4960.00	Average	45.16	4.44	49.60	54.00	-4.40
7440.00	Peak	43.93	10.76	54.69	74.00	-19.31
7440.00	Average	35.73	10.76	46.49	54.00	-7.51
N/A						

**Remark:**

1. Measuring frequencies from 1 GHz to the 10th harmonic of highest fundamental frequency.

**--End of Test Report--**