



FCC RF Test Report

APPLICANT : Quanta Computer Inc.
EQUIPMENT : Computing Device with external power supply, battery, WiFi and Bluetooth
MODEL NAME : C0A
FCC ID : HFSC0A
STANDARD : FCC Part 15 Subpart C §15.247
CLASSIFICATION : (DSS) Spread Spectrum Transmitter

The testing was completed on Jun. 08, 2017. We, SPORTON INTERNATIONAL INC., would like to declare that the tested sample has been evaluated in accordance with the test procedures and has been in compliance with the applicable technical standards.

The test results in this report apply exclusively to the tested model / sample. Without written approval of SPORTON INTERNATIONAL INC., the test report shall not be reproduced except in full.

Reviewed by: Joseph Lin / Supervisor

Approved by: Jones Tsai / Manager



SPORTON INTERNATIONAL INC.

No. 52, Hwa Ya 1st Rd., Hwa Ya Technology Park, Kwei-Shan District, Tao Yuan City, Taiwan, R.O.C.



TABLE OF CONTENTS

REVISION HISTORY..... 3

SUMMARY OF TEST RESULT 4

1 GENERAL DESCRIPTION..... 5

 1.1 Applicant 5

 1.2 Product Feature of Equipment Under Test..... 5

 1.3 Product Specification of Equipment Under Test..... 5

 1.4 Modification of EUT 5

 1.5 Testing Location 6

 1.6 Applicable Standards..... 6

2 TEST CONFIGURATION OF EQUIPMENT UNDER TEST..... 7

 2.1 Carrier Frequency Channel 7

 2.2 Test Mode..... 8

 2.3 Connection Diagram of Test System..... 9

 2.4 Support Unit used in test configuration and system 10

 2.5 UT Operation Test Setup..... 10

 2.6 Measurement Results Explanation Example..... 10

3 TEST RESULT 11

 3.1 Number of Channel Measurement 11

 3.2 Hopping Channel Separation Measurement 13

 3.3 Dwell Time Measurement..... 19

 3.4 20dB and 99% Bandwidth Measurement 21

 3.5 Peak Output Power Measurement 32

 3.6 Conducted Band Edges Measurement..... 33

 3.7 Conducted Spurious Emission Measurement 40

 3.8 Radiated Band Edges and Spurious Emission Measurement 50

 3.9 AC Conducted Emission Measurement..... 54

 3.10 Antenna Requirements..... 56

4 LIST OF MEASURING EQUIPMENT..... 57

5 UNCERTAINTY OF EVALUATION..... 58

APPENDIX A. CONDUCTED TEST RESULTS

APPENDIX B. AC CONDUCTED EMISSION TEST RESULT

APPENDIX C. RADIATED SPURIOUS EMISSION

APPENDIX D. RADIATED SPURIOUS EMISSION PLOTS

APPENDIX E. DUTY CYCLE PLOTS



REVISION HISTORY

REPORT NO.	VERSION	DESCRIPTION	ISSUED DATE
FR742622A	Rev. 01	Initial issue of report	Aug. 01, 2017



SUMMARY OF TEST RESULT

Report Section	FCC Rule	Description	Limit	Result	Remark
3.1	15.247(a)(1)	Number of Channels	≥ 15Chs	Pass	-
3.2	15.247(a)(1)	Hopping Channel Separation	≥ 2/3 of 20dB BW	Pass	-
3.3	15.247(a)(1)	Dwell Time of Each Channel	≤ 0.4sec in 31.6sec period	Pass	-
3.4	15.247(a)(1)	20dB Bandwidth	NA	Pass	-
3.4	-	99% Bandwidth	-	Pass	-
3.5	15.247(b)(1)	Peak Output Power	≤ 125 mW	Pass	-
3.6	15.247(d)	Conducted Band Edges	≤ 20dBc	Pass	-
3.7	15.247(d)	Conducted Spurious Emission	≤ 20dBc	Pass	-
3.8	15.247(d)	Radiated Band Edges and Radiated Spurious Emission	15.209(a) & 15.247(d)	Pass	Under limit 4.30 dB at 38.640 MHz
3.9	15.207	AC Conducted Emission	15.207(a)	Pass	Under limit 12.80 dB at 2.902 MHz
3.10	15.203 & 15.247(b)	Antenna Requirement	N/A	Pass	-



1 General Description

1.1 Applicant

Quanta Computer Inc.

No. 188, Wenhua 2nd Rd., Guishan Dist., Taoyuan City 33377, Taiwan

1.2 Product Feature of Equipment Under Test

Product Feature	
Equipment	Computing Device with external power supply, battery, WiFi and Bluetooth
Model Name	C0A
FCC ID	HFSC0A
EUT supports Radios application	WLAN 11a/b/g/n HT20/HT40 WLAN 11ac VHT20/VHT40/VHT80 Bluetooth BR/EDR/LE

Remark: The above EUT's information was declared by manufacturer. Please refer to the specifications or user's manual for more detailed description.

1.3 Product Specification of Equipment Under Test

Standards-related Product Specification	
Tx/Rx Frequency Range	2402 MHz ~ 2480 MHz
Number of Channels	79
Carrier Frequency of Each Channel	2402+n*1 MHz; n=0~78
Maximum Output Power to Antenna	Bluetooth BR(1Mbps) : 5.33 dBm (0.0034 W) Bluetooth EDR (2Mbps) : 2.12 dBm (0.0016 W) Bluetooth EDR (3Mbps) : 2.29 dBm (0.0017 W)
99% Occupied Bandwidth	Bluetooth BR(1Mbps) : 0.868MHz Bluetooth EDR (2Mbps) : 1.352MHz Bluetooth EDR (3Mbps) : 1.356MHz
Antenna Type / Gain	Fixed Internal Antenna type with gain 5.40 dBi
Type of Modulation	Bluetooth BR (1Mbps) : GFSK Bluetooth EDR (2Mbps) : $\pi/4$ -DQPSK Bluetooth EDR (3Mbps) : 8-DPSK

1.4 Modification of EUT

No modifications are made to the EUT during all test items.



1.5 Testing Location

Sporton Lab is accredited to ISO 17025 by Taiwan Accreditation Foundation (TAF code : 1190) and the FCC designation No. TW0007 under the FCC 2.948(e) by Mutual Recognition Agreement (MRA) in FCC Test.

Test Site	SPORTON INTERNATIONAL INC.	
Test Site Location	No. 52, Hwa Ya 1 st Rd., Hwa Ya Technology Park, Kwei-Shan District, Tao Yuan City, Taiwan, R.O.C. TEL: +886-3-327-3456 FAX: +886-3-328-4978	
Test Site No.	Sporton Site No.	
	TH05-HY	CO05-HY

Note: The test site complies with ANSI C63.4 2014 requirement.

Test Site	SPORTON INTERNATIONAL INC.	
Test Site Location	No.58, Aly. 75, Ln. 564, Wenhua 3rd Rd. Guishan Dist, Taoyuan City, Taiwan (R.O.C.) TEL: +886-3-327-0868 FAX: +886-3-327-0855	
Test Site No.	Sporton Site No.	
	03CH11-HY	

Note: The test site complies with ANSI C63.4 2014 requirement.

1.6 Applicable Standards

According to the specifications of the manufacturer, the EUT must comply with the requirements of the following standards:

- ♦ FCC Part 15 Subpart C §15.247
- ♦ ANSI C63.10-2013

Remark:

1. All test items were verified and recorded according to the standards and without any deviation during the test.
2. This EUT has also been tested and complied with the requirements of FCC Part 15, Subpart B, recorded in a separate test report.



2 Test Configuration of Equipment Under Test

2.1 Carrier Frequency Channel

Frequency Band	Channel	Freq. (MHz)	Channel	Freq. (MHz)	Channel	Freq. (MHz)
2400-2483.5 MHz	0	2402	27	2429	54	2456
	1	2403	28	2430	55	2457
	2	2404	29	2431	56	2458
	3	2405	30	2432	57	2459
	4	2406	31	2433	58	2460
	5	2407	32	2434	59	2461
	6	2408	33	2435	60	2462
	7	2409	34	2436	61	2463
	8	2410	35	2437	62	2464
	9	2411	36	2438	63	2465
	10	2412	37	2439	64	2466
	11	2413	38	2440	65	2467
	12	2414	39	2441	66	2468
	13	2415	40	2442	67	2469
	14	2416	41	2443	68	2470
	15	2417	42	2444	69	2471
	16	2418	43	2445	70	2472
	17	2419	44	2446	71	2473
	18	2420	45	2447	72	2474
	19	2421	46	2448	73	2475
	20	2422	47	2449	74	2476
	21	2423	48	2450	75	2477
	22	2424	49	2451	76	2478
	23	2425	50	2452	77	2479
	24	2426	51	2453	78	2480
	25	2427	52	2454	-	-
	26	2428	53	2455	-	-



2.2 Test Mode

- a. The EUT has been associated with peripherals and configuration operated in a manner tended to maximize its emission characteristics in a typical application. Frequency range investigated: conduction emission (150 kHz to 30 MHz), radiation emission (9 kHz to the 10th harmonic of the highest fundamental frequency or to 40 GHz, whichever is lower). The following tables for radiated measurement, pre-scanned in three orthogonal panels, X, Y, Z in tablet mode and Notebook mode The worst cases (Notebook Mode) were recorded in this report. , and the worst mode of radiated spurious emissions is Bluetooth 1Mbps mode, and recorded in this report.
- b. AC power line Conducted Emission was tested under maximum output power.

The following summary table is showing all test modes to demonstrate in compliance with the standard.

Summary table of Test Cases			
Test Item	Data Rate / Modulation		
	Bluetooth BR 1Mbps GFSK	Bluetooth EDR 2Mbps $\pi/4$ -DQPSK	Bluetooth EDR 3Mbps 8-DPSK
Conducted Test Cases	Mode 1: CH00_2402 MHz Mode 2: CH39_2441 MHz Mode 3: CH78_2480 MHz	Mode 4: CH00_2402 MHz Mode 5: CH39_2441 MHz Mode 6: CH78_2480 MHz	Mode 7: CH00_2402 MHz Mode 8: CH39_2441 MHz Mode 9: CH78_2480 MHz
Radiated Test Cases	Bluetooth BR 1Mbps GFSK		
	Mode 1: CH00_2402 MHz Mode 2: CH39_2441 MHz Mode 3: CH78_2480 MHz		
Summary table of Test Cases			
AC Conducted Emission	Mode 1 :WLAN (2.4GHz) Link + Bluetooth Link + MPEG 4 + USB port 1_USB Cable (Charging from Adapter) + Laptop mode + Earphone + Resolution (1800*1200) + USB port 2_Type C to DP Cable with TV (voice output from Bluetooth earphone)		
Remark: For radiated test cases, the worst mode data rate 1Mbps was reported only, because this data rate has the highest RF output power at preliminary tests, and the conducted spurious emissions and conducted band edge measurement for each data rate are no worse than 1Mbps, and no other significantly frequencies found in conducted spurious emission.			

2.3 Connection Diagram of Test System

<Bluetooth Tx Mode>

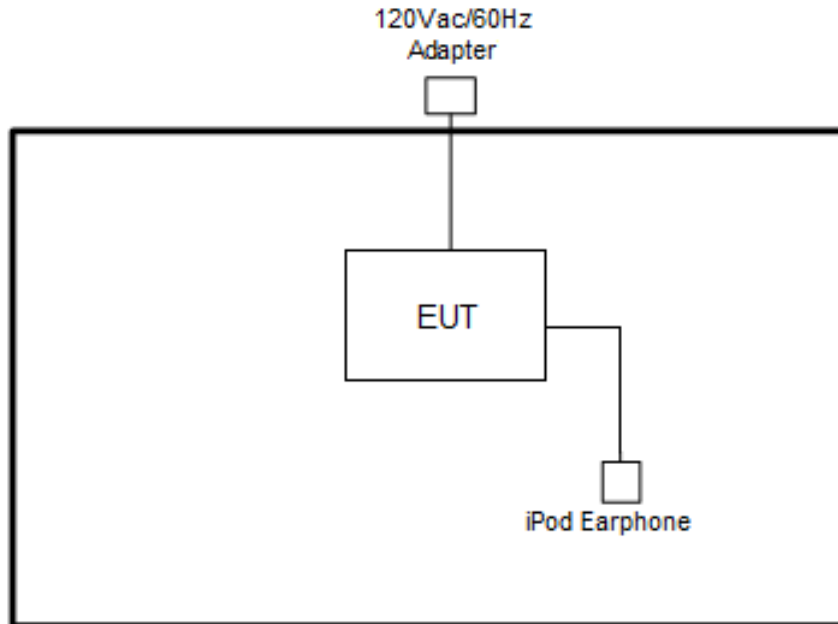

<AC Conducted Emission Mode>

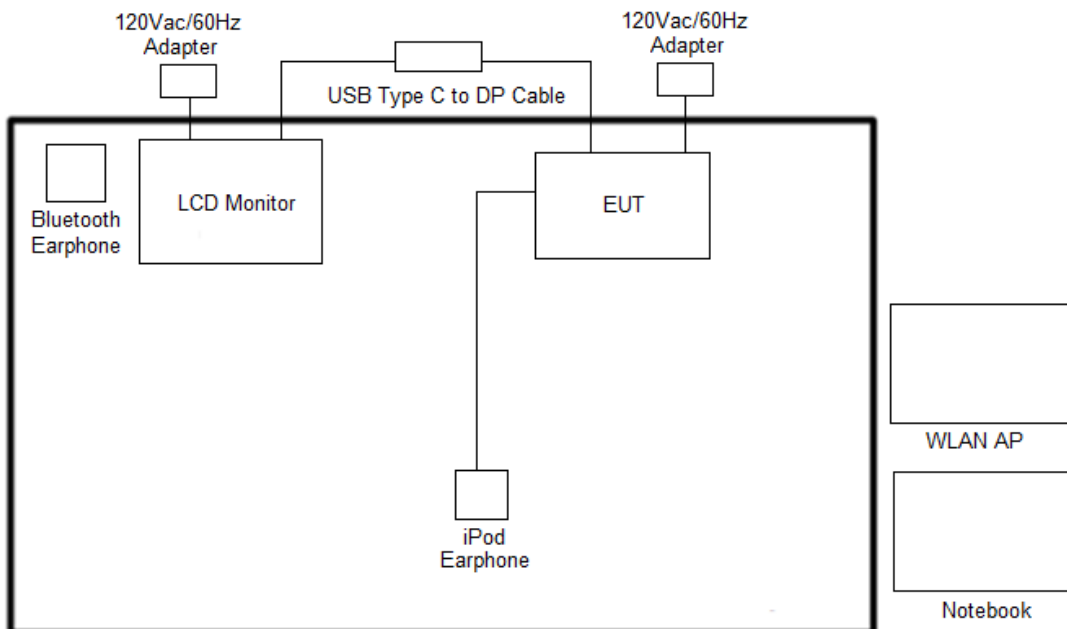



2.4 Support Unit used in test configuration and system

Item	Equipment	Trade Name	Model Name	FCC ID	Data Cable	Power Cord
1.	Bluetooth Earphone	Sony Ericsson	MW600	PY7DDA-2029	N/A	N/A
2.	WLAN AP	ASUS	RT-AC66U	MSQ-RTAC66U	N/A	Unshielded, 1.8 m
3.	Notebook	DELL	Latitude E6320	FCC DoC	N/A	AC I/P: Unshielded, 1.2 m DC O/P: Shielded, 1.8 m
4.	iPod Earphone	Apple	N/A	Verification	Unshielded, 1.0 m	N/A
5.	LCD Monitor	DELL	U2410	FCC DoC	Shielded, 1.6 m	Unshielded, 1.8 m

2.5 UT Operation Test Setup

The RF test items, programmed RF utility, “DRTU” installed in the notebook make the EUT provide functions like channel selection and power level for continuous transmitting and receiving signals.

2.6 Measurement Results Explanation Example

For all conducted test items:

The offset level is set in the spectrum analyzer to compensate the RF cable loss and attenuator factor between EUT conducted output port and spectrum analyzer. With the offset compensation, the spectrum analyzer reading level is exactly the EUT RF output level.

Example:

The spectrum analyzer offset is derived from RF cable loss and attenuator factor.

Offset = RF cable loss + attenuator factor.

Following shows an offset computation example with cable loss 4.2 dB and 10dB attenuator.

$$\begin{aligned}
 \text{Offset(dB)} &= \text{RF cable loss(dB)} + \text{attenuator factor(dB)} \\
 &= 4.2 + 10 = 14.2 \text{ (dB)}
 \end{aligned}$$

3 Test Result

3.1 Number of Channel Measurement

3.1.1 Limits of Number of Hopping Frequency

Frequency hopping systems in the 2400-2483.5 MHz band shall use at least 15 channels.

3.1.2 Measuring Instruments

The measuring equipment is listed in the section 4 of this test report.

3.1.3 Test Procedure

1. The testing follows ANSI C63.10-2013 clause 7.8.3.
2. The RF output of EUT was connected to the spectrum analyzer by RF cable and attenuator. The path loss was compensated to the results for each measurement.
3. Set to the maximum power setting and enable the EUT transmit continuously.
4. Enable the EUT hopping function.
5. Use the following spectrum analyzer settings: Span = the frequency band of operation; RBW = 300kHz; VBW \geq RBW; Sweep = auto; Detector function = peak; Trace = max hold.
6. The number of hopping frequency used is defined as the number of total channel.
7. Record the measurement data derived from spectrum analyzer.

3.1.4 Test Setup

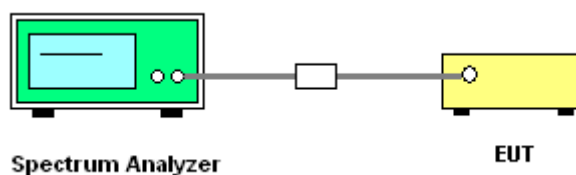



3.1.5 Test Result of Number of Hopping Frequency

Please refer to Appendix A.

Number of Hopping Channel Plot on Channel 00 - 78

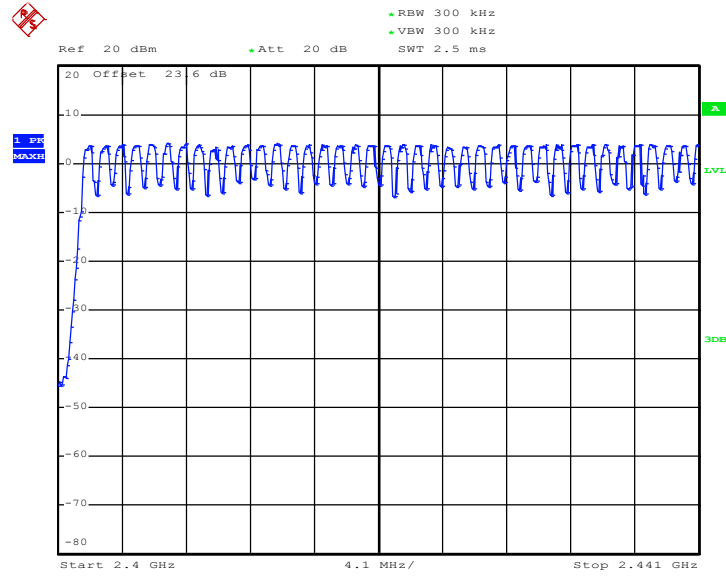

Date: 27.MAY.2017 16:45:49

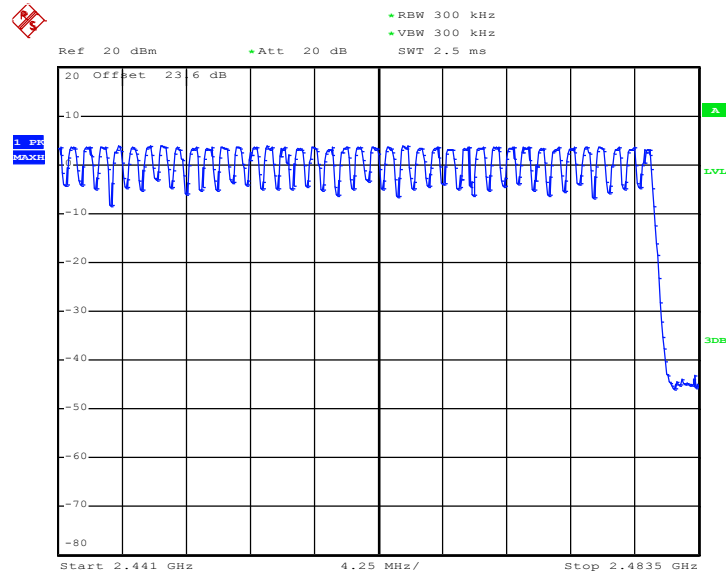

Date: 27.MAY.2017 16:47:05

3.2 Hopping Channel Separation Measurement

3.2.1 Limit of Hopping Channel Separation

Frequency hopping systems operating in the 2400-2483.5 MHz band may have hopping channel carrier frequencies that are separated by 25 kHz or two-thirds of the 20 dB bandwidth of the hopping channel, whichever is greater.

3.2.2 Measuring Instruments

The measuring equipment is listed in the section 4 of this test report.

3.2.3 Test Procedures

1. The testing follows ANSI C63.10-2013 clause 7.8.2.
2. The RF output of EUT was connected to the spectrum analyzer by RF cable and attenuator. The path loss was compensated to the results for each measurement.
3. Set to the maximum power setting and enable the EUT transmit continuously.
4. Enable the EUT hopping function.
5. Use the following spectrum analyzer settings:
Span = wide enough to capture the peaks of two adjacent channels;
RBW = 300kHz; VBW \geq RBW; Sweep = auto; Detector function = peak; Trace = max hold.
6. Measure and record the results in the test report.

3.2.4 Test Setup

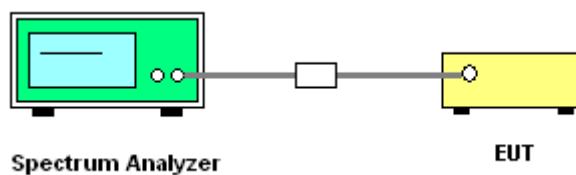

3.2.5 Test Result of Hopping Channel Separation

Please refer to Appendix A.



<1Mbps>

Channel Separation Plot on Channel 00 - 01

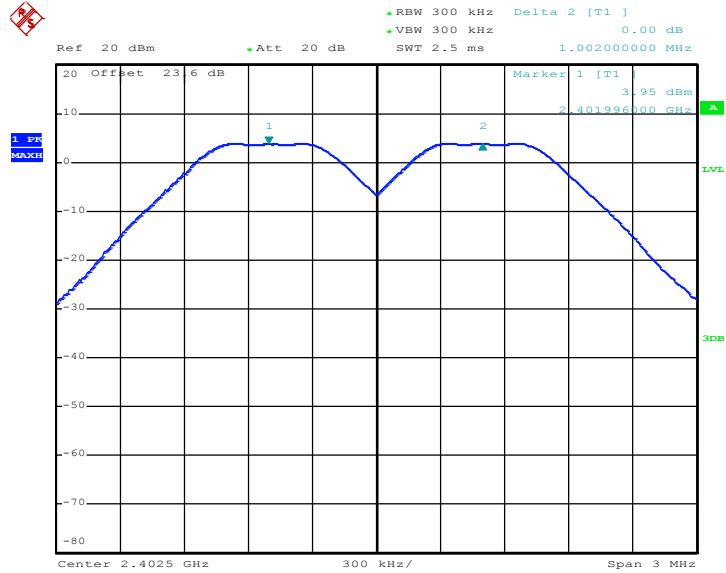

Date: 27.MAY.2017 16:44:19

Channel Separation Plot on Channel 39 - 40

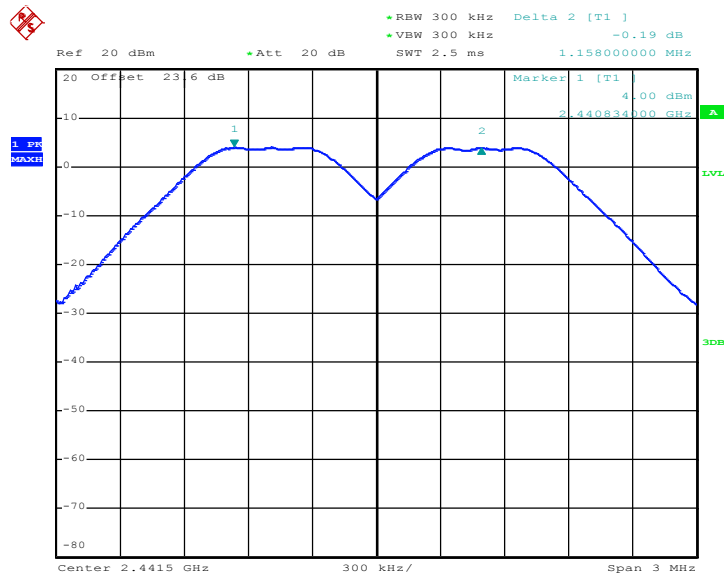

Date: 27.MAY.2017 16:53:30



Channel Separation Plot on Channel 77 - 78

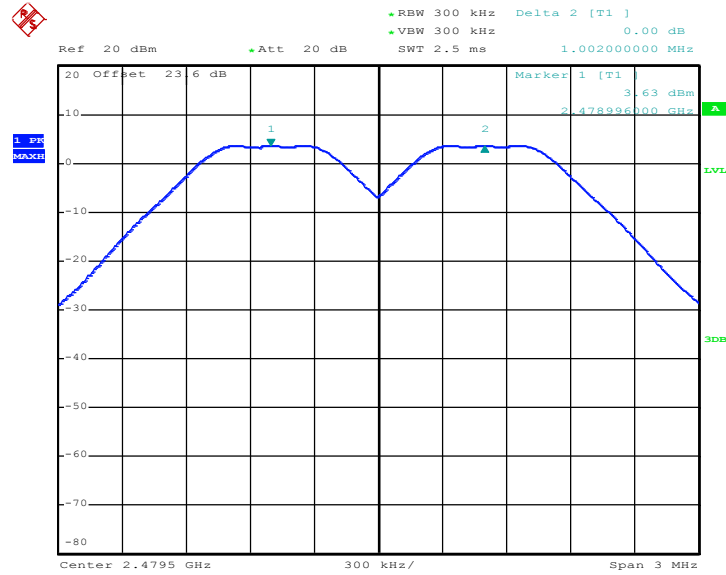

Date: 27.MAY.2017 16:55:06

<2Mbps>

Channel Separation Plot on Channel 00 - 01

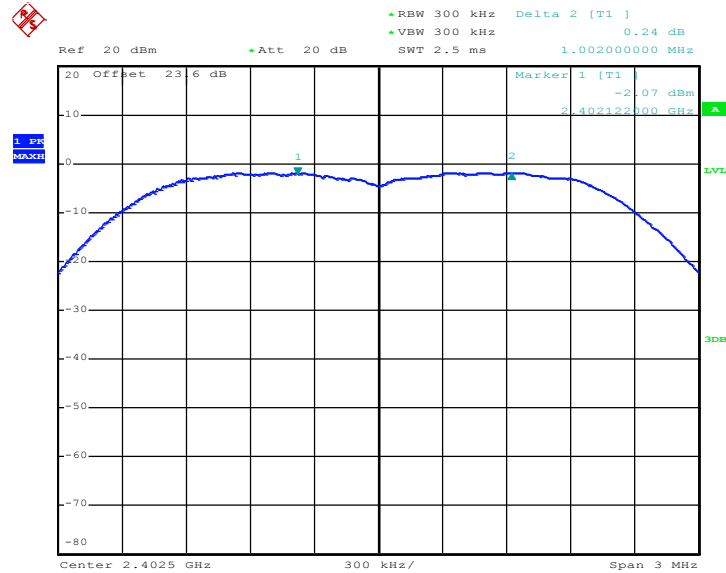

Date: 27.MAY.2017 17:28:43



Channel Separation Plot on Channel 39 - 40

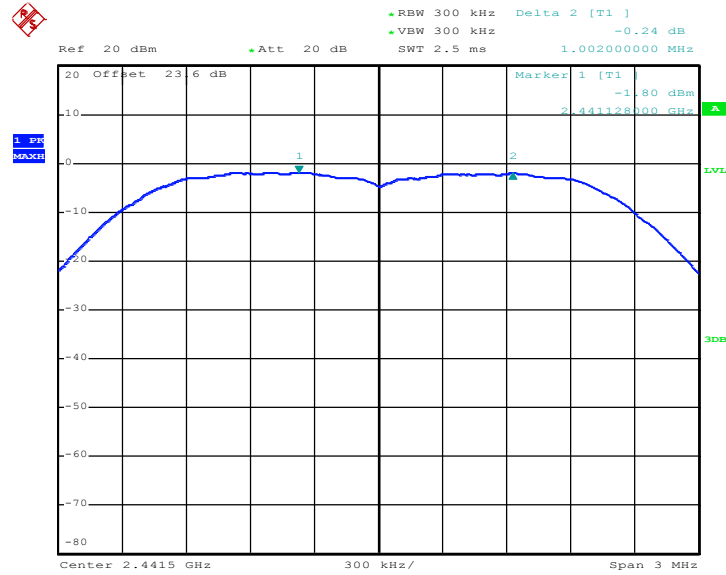

Date: 27.MAY.2017 17:22:41

Channel Separation Plot on Channel 77 - 78

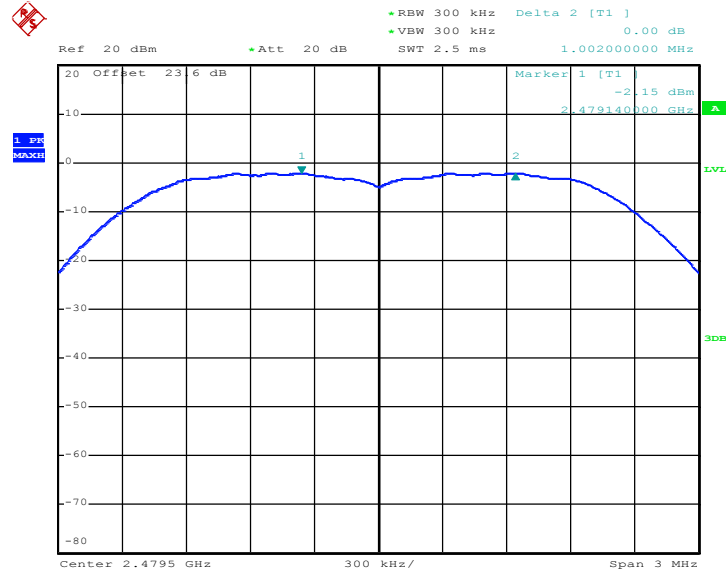

Date: 27.MAY.2017 17:16:31



<3Mbps>

Channel Separation Plot on Channel 00 - 01

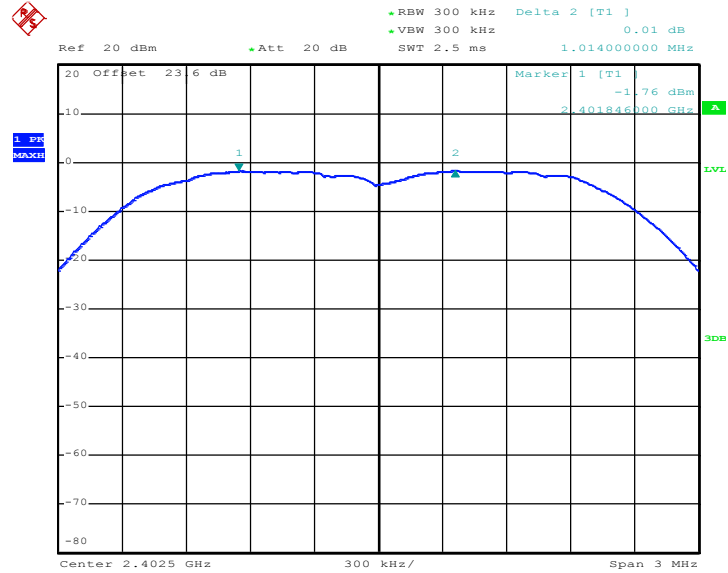

Date: 27.MAY.2017 17:34:09

Channel Separation Plot on Channel 39 - 40

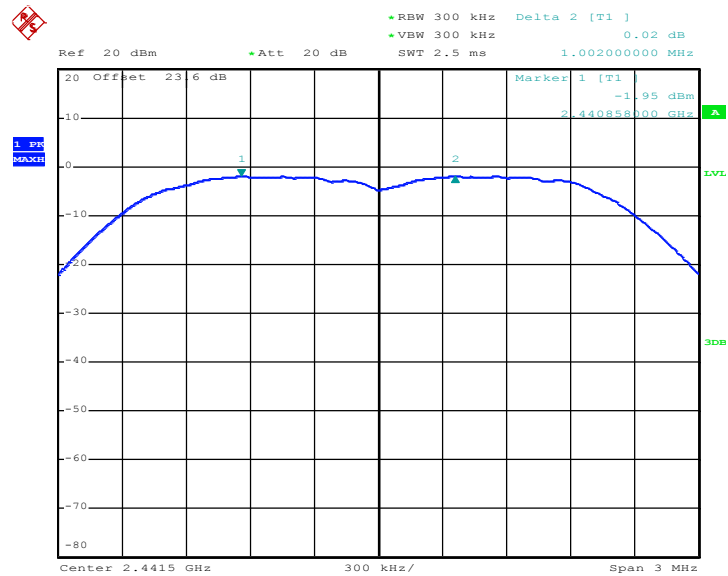

Date: 27.MAY.2017 17:37:55



Channel Separation Plot on Channel 77 - 78

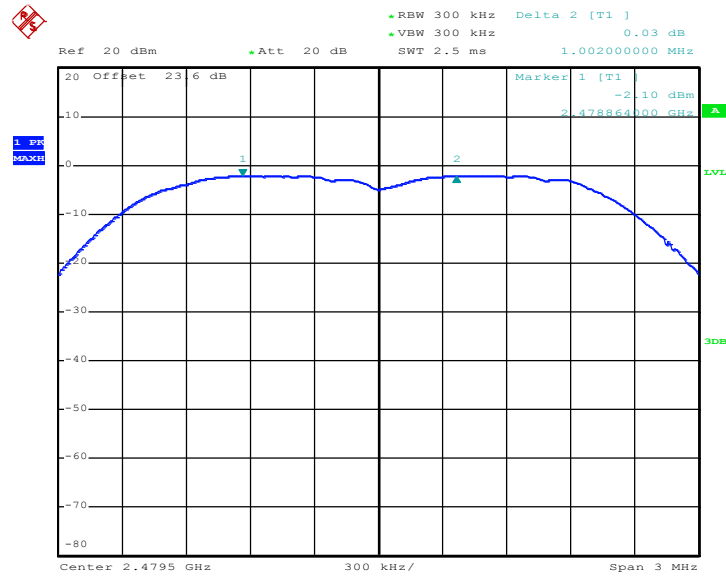

Date: 27.MAY.2017 17:39:25

3.3 Dwell Time Measurement

3.3.1 Limit of Dwell Time

The average time of occupancy on any channel shall not be greater than 0.4 seconds within a period of 0.4 seconds multiplied by the number of hopping channels employed.

3.3.2 Measuring Instruments

The measuring equipment is listed in the section 4 of this test report.

3.3.3 Test Procedures

1. The testing follows ANSI C63.10-2013 clause 7.8.4.
2. The RF output of EUT was connected to the spectrum analyzer by RF cable and attenuator. The path loss was compensated to the results for each measurement.
3. Set to the maximum power setting and enable the EUT transmit continuously.
4. Enable the EUT hopping function.
5. Use the following spectrum analyzer settings: Span = zero span, centered on a hopping channel; RBW = 1 MHz; VBW \geq RBW; Sweep = as necessary to capture the entire dwell time per hopping channel; Detector function = peak; Trace = max hold.
6. Measure and record the results in the test report.

3.3.4 Test Setup

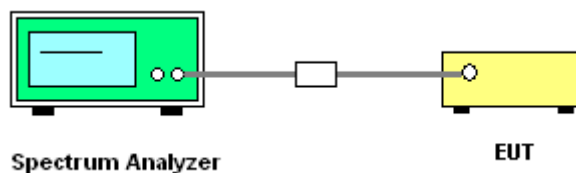

3.3.5 Test Result of Dwell Time

Please refer to Appendix A.



Package Transfer Time Plot

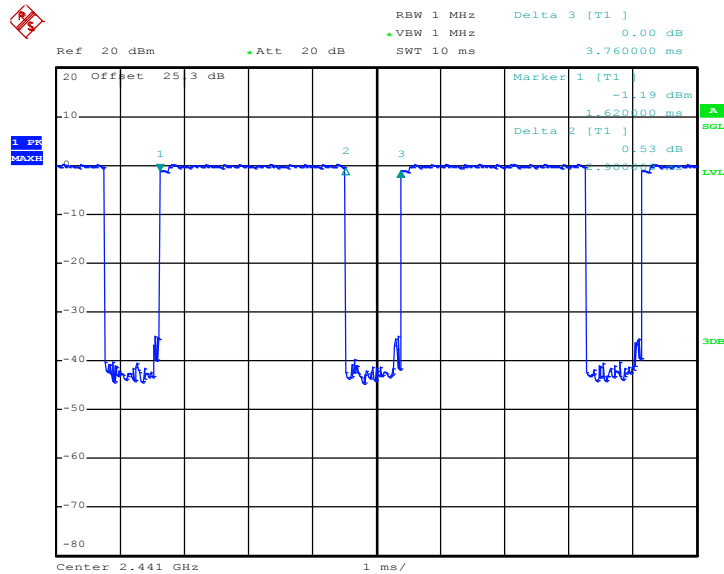

Date: 3.MAY.2017 22:22:19

Remark:

1. In normal mode, hopping rate is 1600 hops/s with 6 slots in 79 hopping channels. With channel hopping rate (1600 / 6 / 79) in Occupancy Time Limit (0.4 x 79) (s), Hops Over Occupancy Time comes to (1600 / 6 / 79) x (0.4 x 79) = 106.67 hops.
2. In AFH mode, hopping rate is 800 hops/s with 6 slots in 20 hopping channels. With channel hopping rate (800 / 6 / 20) in Occupancy Time Limit (0.4 x 20) (s), Hops Over Occupancy Time comes to (800 / 6 / 20) x (0.4 x 20) = 53.33 hops.
3. Dwell Time(s) = Hops Over Occupancy Time (hops) x Package Transfer Time

3.4 20dB and 99% Bandwidth Measurement

3.4.1 Limit of 20dB and 99% Bandwidth

Reporting only

3.4.2 Measuring Instruments

The measuring equipment is listed in the section 4 of this test report.

3.4.3 Test Procedures

1. The testing follows ANSI C63.10-2013 clause 6.9.2 and 6.9.3.
2. The RF output of EUT was connected to the spectrum analyzer by RF cable and attenuator. The path loss was compensated to the results for each measurement.
3. Set to the maximum power setting and enable the EUT transmit continuously.
4. Use the following spectrum analyzer settings for 20dB Bandwidth measurement.
Span = approximately 2 to 5 times the 20 dB bandwidth, centered on a hopping channel;
RBW \geq 1% of the 20 dB bandwidth; VBW \geq RBW; Sweep = auto; Detector function = peak;
Trace = max hold.
5. Use the following spectrum analyzer settings for 99 % Bandwidth measurement.
Span = approximately 1.5 to 5 times the 99% bandwidth, centered on a hopping channel;
RBW \geq 1% of the 99% bandwidth; VBW \geq RBW; Sweep = auto; Detector function = peak;
Trace = max hold.
6. Measure and record the results in the test report.

3.4.4 Test Setup

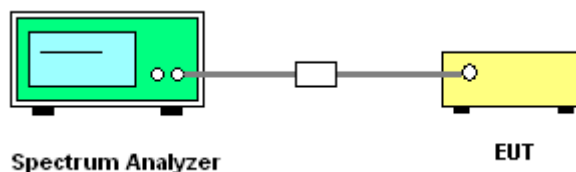

3.4.5 Test Result of 20dB Bandwidth

Please refer to Appendix A.



<1Mbps>

20 dB Bandwidth Plot on Channel 00

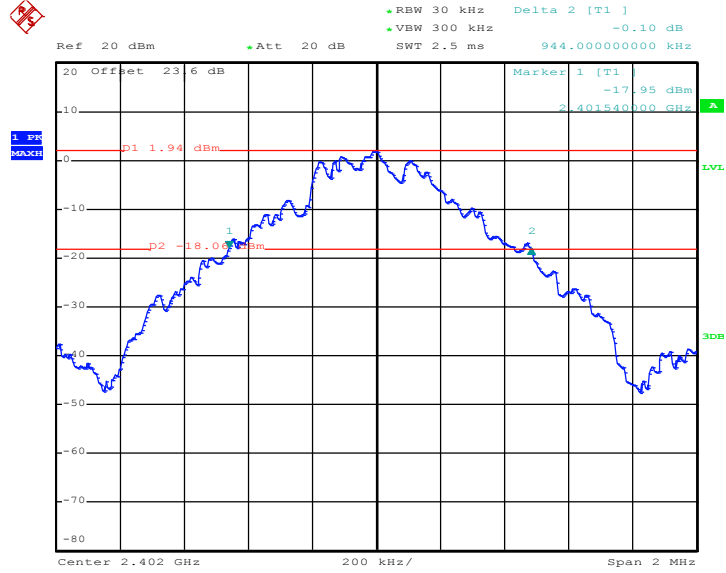

Date: 27.MAY.2017 17:51:00

20 dB Bandwidth Plot on Channel 39

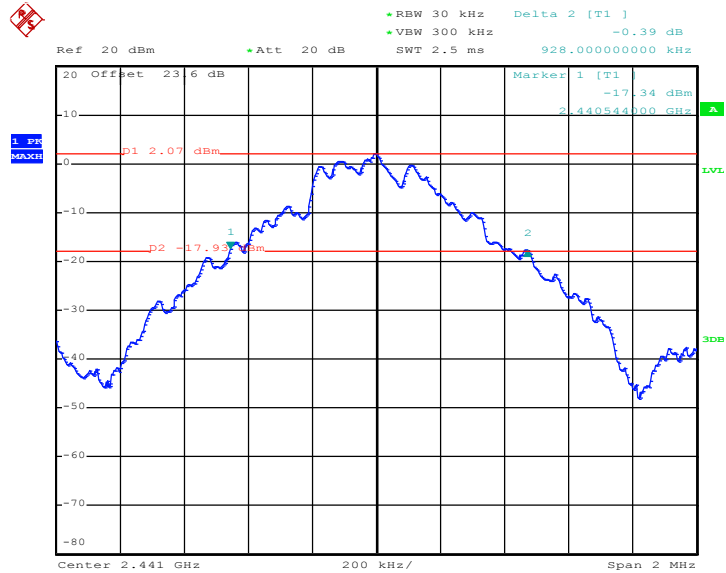

Date: 27.MAY.2017 18:00:01



20 dB Bandwidth Plot on Channel 78

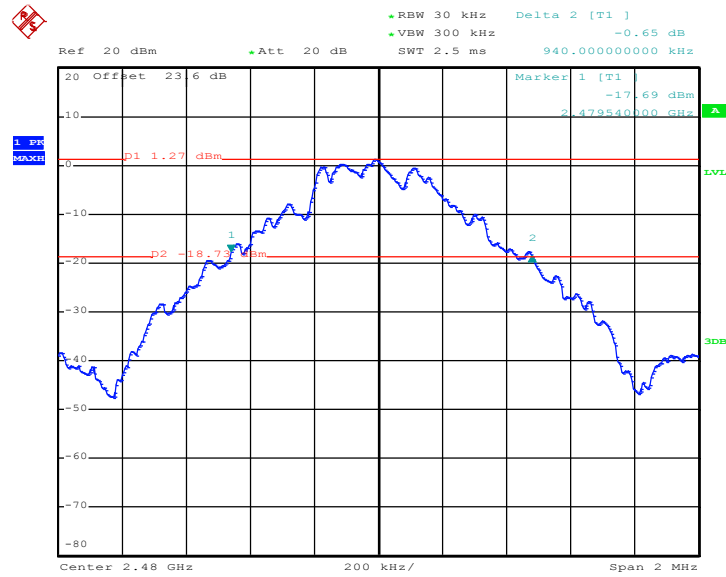

Date: 27.MAY.2017 18:07:25

<2Mbps>

20 dB Bandwidth Plot on Channel 00

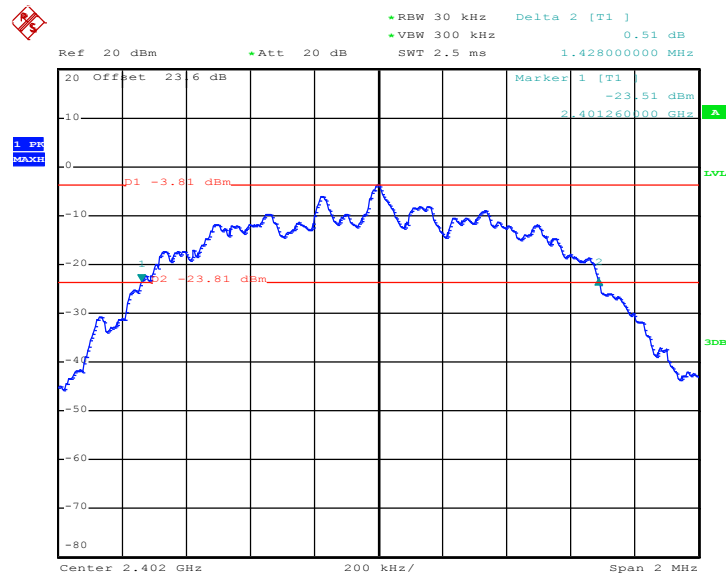

Date: 27.MAY.2017 17:52:21



20 dB Bandwidth Plot on Channel 39

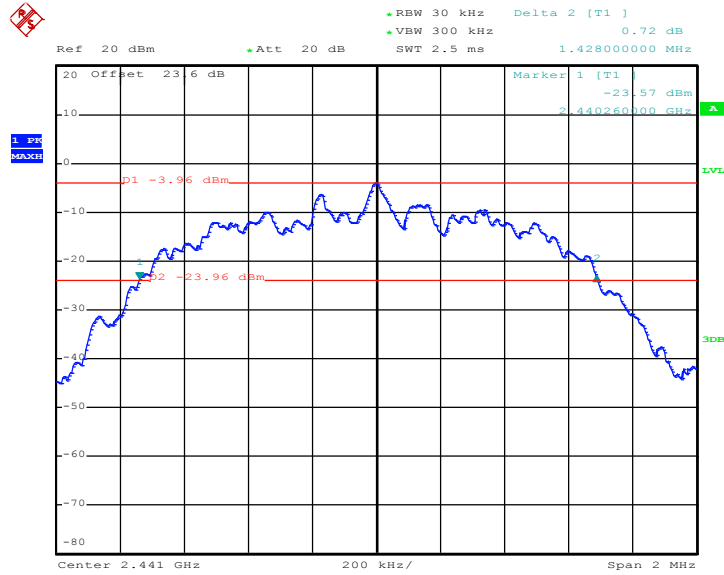

Date: 27.MAY.2017 17:57:44

20 dB Bandwidth Plot on Channel 78

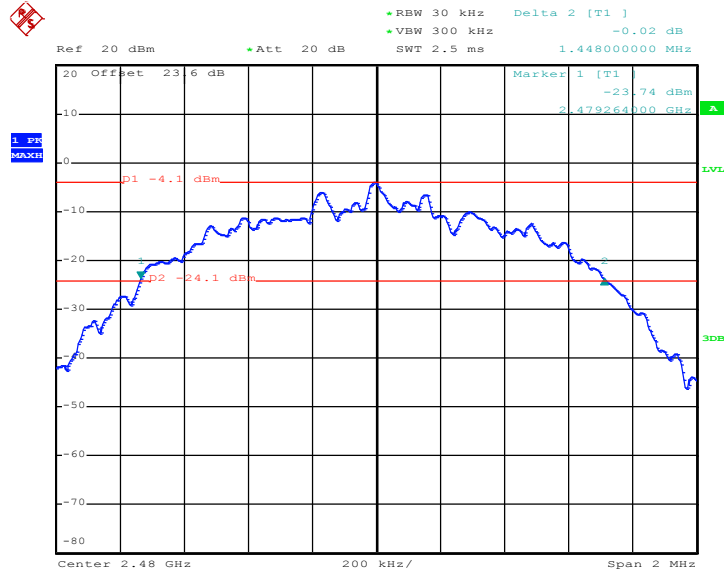

Date: 27.MAY.2017 18:03:29



<3Mbps>

20 dB Bandwidth Plot on Channel 00

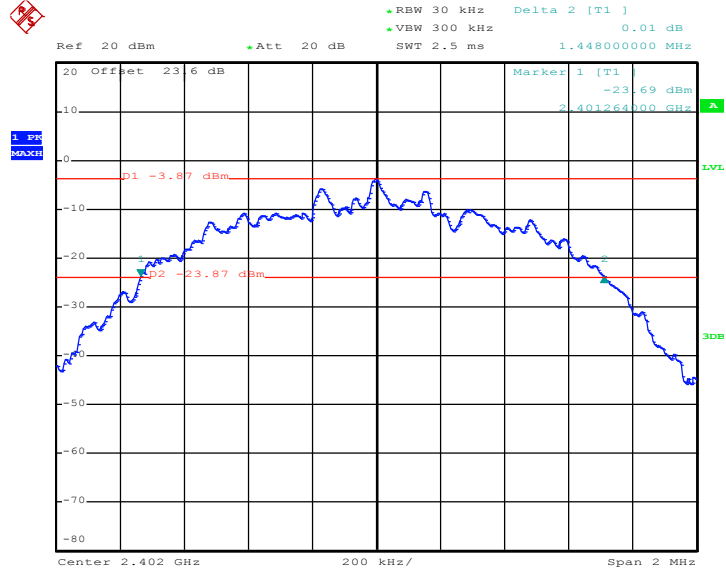

Date: 27.MAY.2017 17:53:07

20 dB Bandwidth Plot on Channel 39

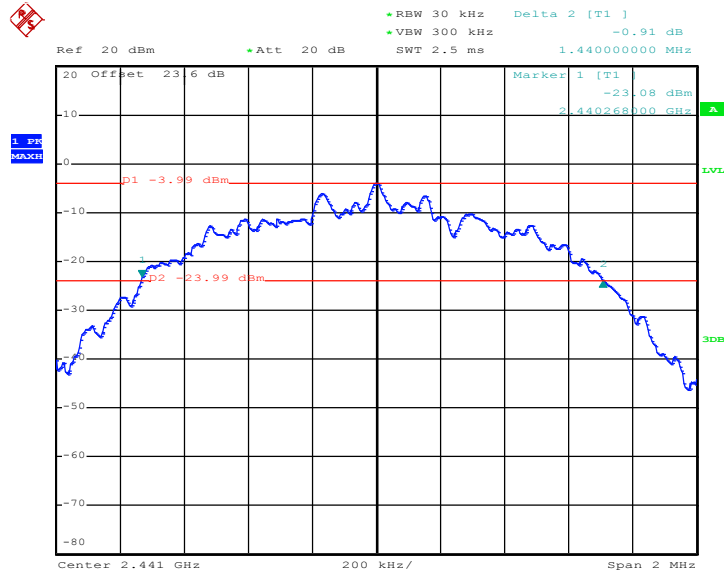

Date: 27.MAY.2017 17:54:04



20 dB Bandwidth Plot on Channel 78

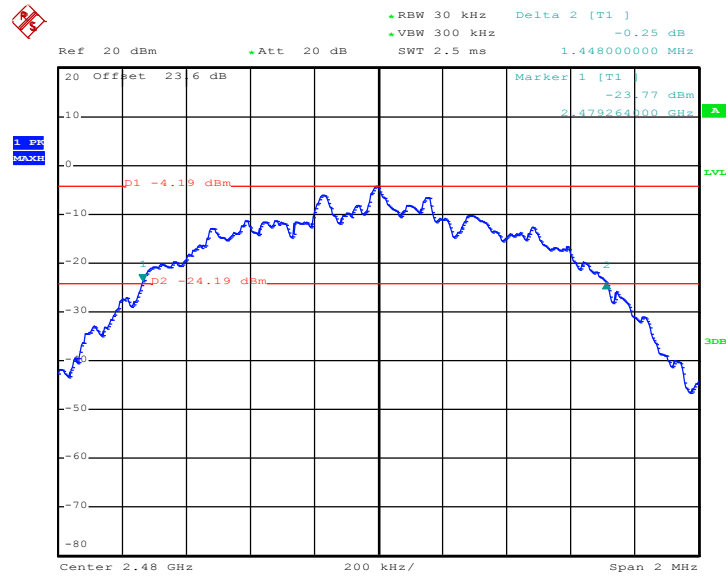

Date: 27.MAY.2017 18:06:28



3.4.6 Test Result of 99% Occupied Bandwidth

Please refer to Appendix A.

<1Mbps>

99% Occupied Bandwidth Plot on Channel 00

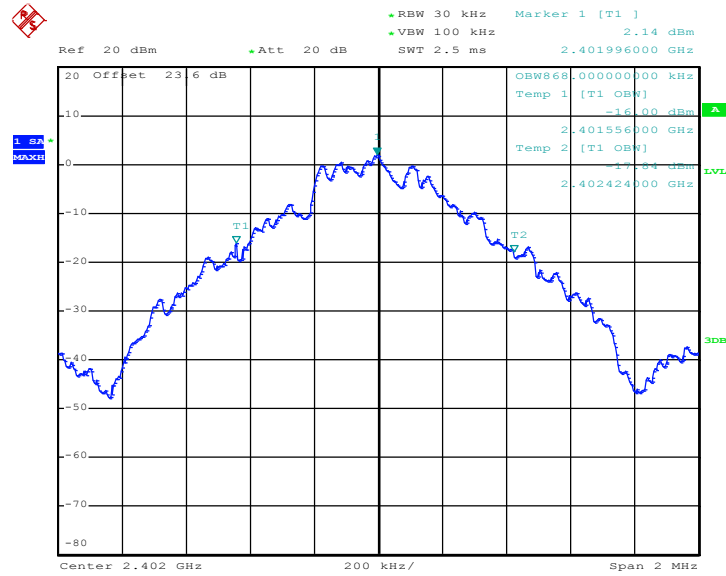

Date: 27.MAY.2017 16:42:39



99% Occupied Bandwidth Plot on Channel 39

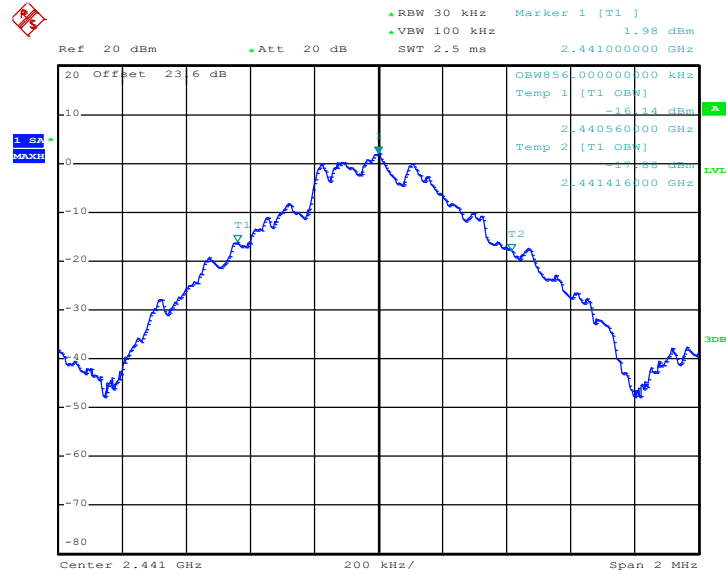

Date: 27.MAY.2017 16:49:53

99% Occupied Bandwidth Plot on Channel 78

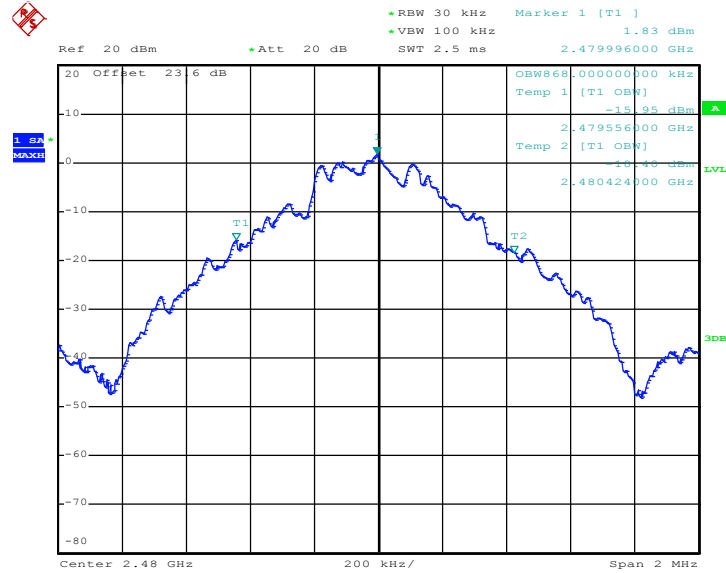

Date: 27.MAY.2017 16:57:18



<2Mbps>

99% Occupied Bandwidth Plot on Channel 00

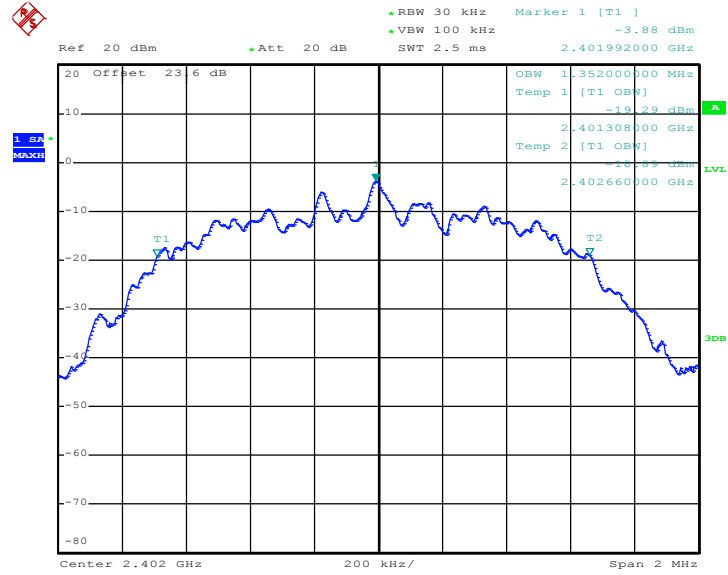

Date: 27.MAY.2017 17:24:20

99% Occupied Bandwidth Plot on Channel 39

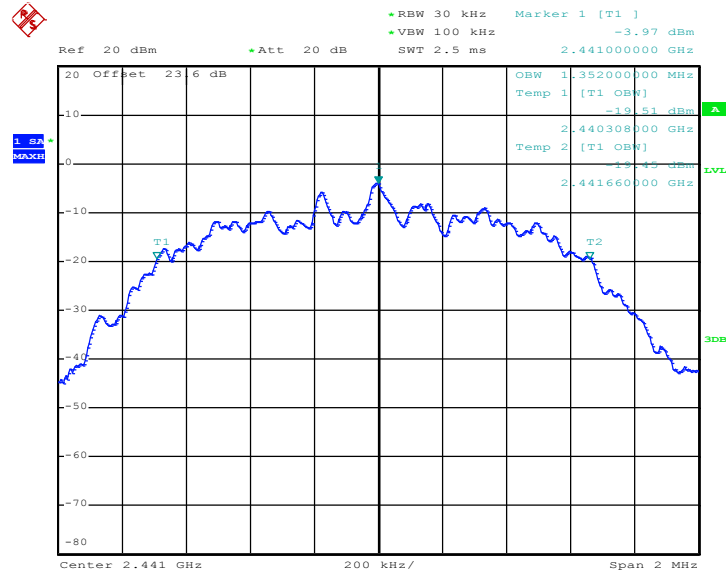

Date: 27.MAY.2017 17:20:36



99% Occupied Bandwidth Plot on Channel 78

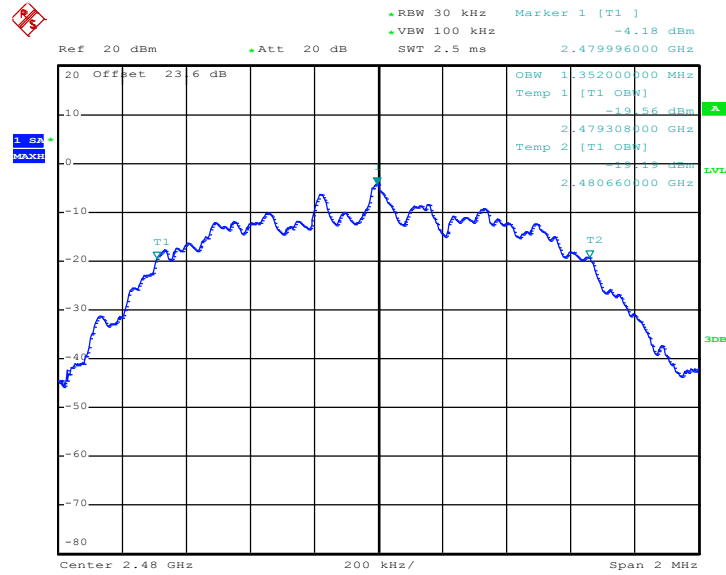

Date: 27.MAY.2017 17:07:10

<3Mbps>

99% Occupied Bandwidth Plot on Channel 00

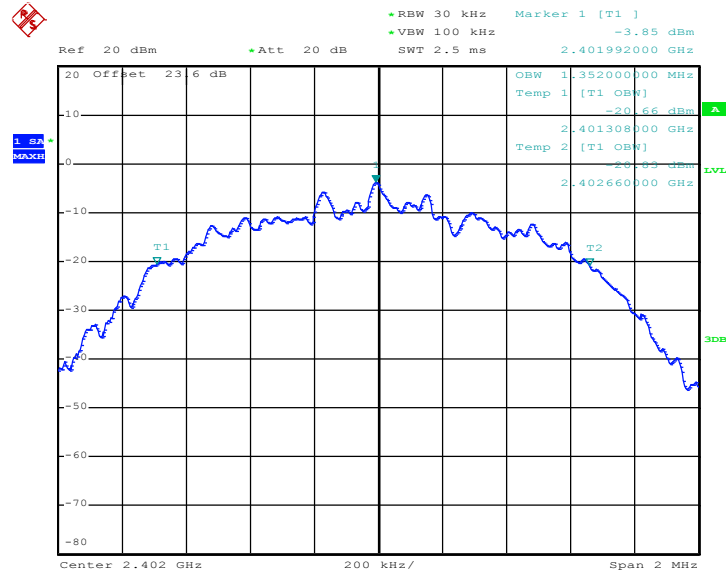

Date: 27.MAY.2017 17:30:37



99% Occupied Bandwidth Plot on Channel 39

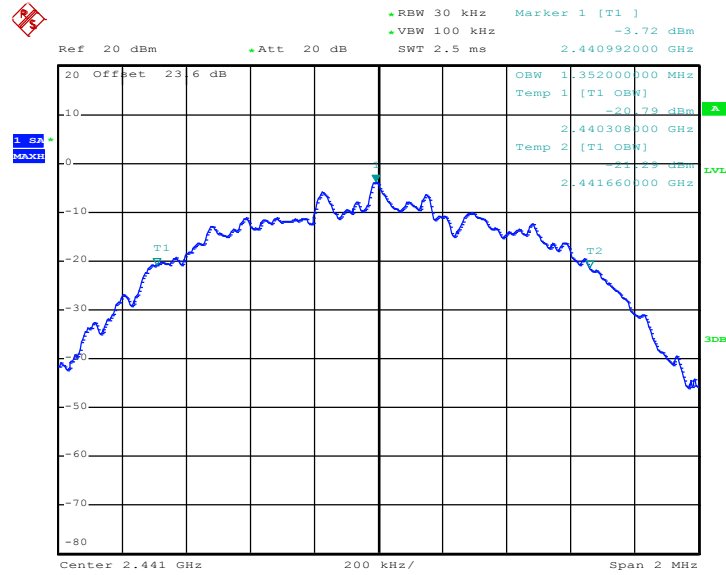

Date: 27.MAY.2017 17:36:18

99% Occupied Bandwidth Plot on Channel 78

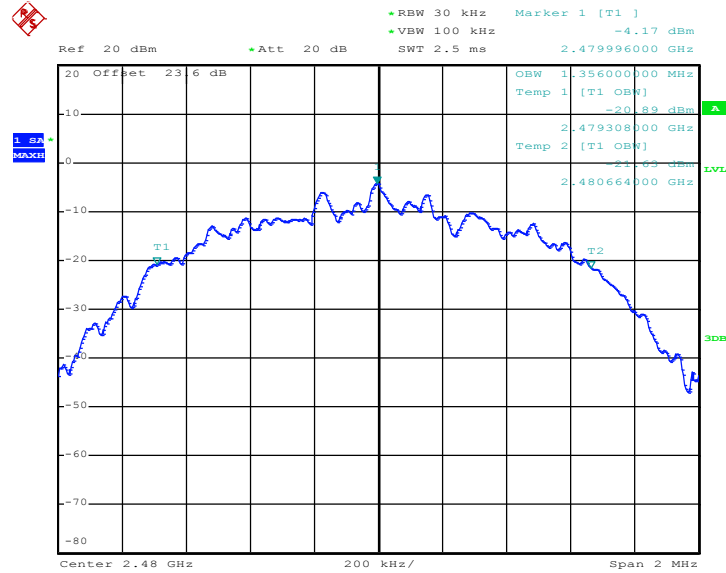

Date: 27.MAY.2017 17:41:03

Note : The occupied channel bandwidth is maintained within the band of operation for all of the modulations.

3.5 Peak Output Power Measurement

3.5.1 Limit of Peak Output Power

Section 15.247 (b) The maximum peak conducted output power of the intentional radiator shall not exceed the following: (1) For frequency hopping systems operating in the 2400-2483.5 MHz band employing at least 75 non-overlapping hopping channels, and all frequency hopping systems in the 5725-5850 MHz band: 1 watt. For all other frequency hopping systems in the 2400-2483.5 MHz band 0.125 watts. The power limit for 1Mbps, 2Mbps, 3Mbps and AFH modes are 0.125 watts.

3.5.2 Measuring Instruments

The measuring equipment is listed in the section 4 of this test report.

3.5.3 Test Procedures

1. The testing follows ANSI C63.10-2013 clause 7.8.5.
2. The RF output of EUT was connected to the power meter by RF cable and attenuator. The path loss was compensated to the results for each measurement.
3. Set to the maximum power setting and enable the EUT transmit continuously.
4. Measure the conducted output power with cable loss and record the results in the test report.
5. Measure and record the results in the test report.

3.5.4 Test Setup

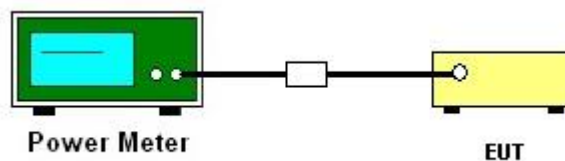

3.5.5 Test Result of Peak Output Power

Please refer to Appendix A.

3.6 Conducted Band Edges Measurement

3.6.1 Limit of Band Edges

In any 100 kHz bandwidth outside the intentional radiation frequency band, the radio frequency power shall be at least 20 dB below the highest level of the radiated power. In addition, radiated emissions which fall in the restricted bands must also comply with the radiated emission limits.

3.6.2 Measuring Instruments

The measuring equipment is listed in the section 4 of this test report.

3.6.3 Test Procedures

1. The testing follows ANSI C63.10-2013 clause 7.8.6.
2. Set to the maximum power setting and enable the EUT transmit continuously.
3. Set RBW = 100kHz, VBW = 300kHz. Band edge emissions must be at least 20 dB down from the highest emission level within the authorized band as measured with a 100kHz RBW. The attenuation shall be 30 dB instead of 20 dB when RMS conducted output power procedure is used.
4. Enable hopping function of the EUT and then repeat step 2. and 3.
5. Measure and record the results in the test report.

3.6.4 Test Setup

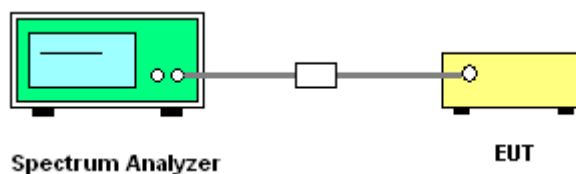

3.6.5 Test Result of Conducted Band Edges

Please refer to Appendix A.



<1Mbps>

Low Band Edge Plot on Channel 00

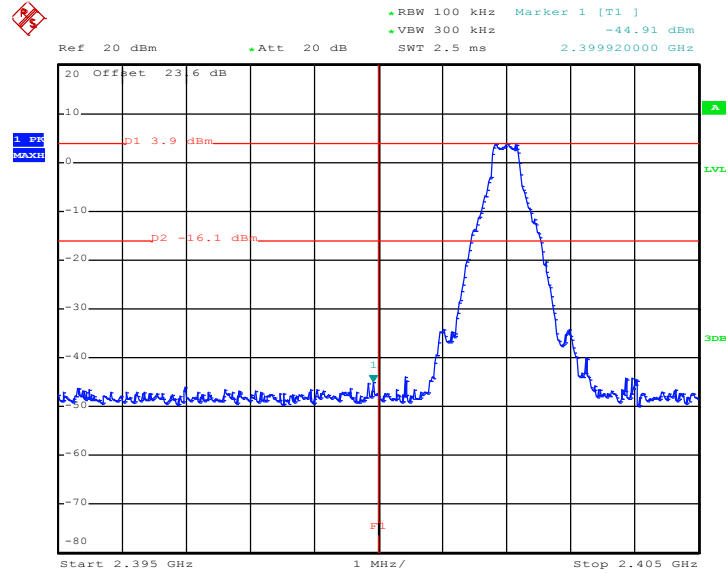

Date: 27.MAY.2017 16:40:05

High Band Edge Plot on Channel 78

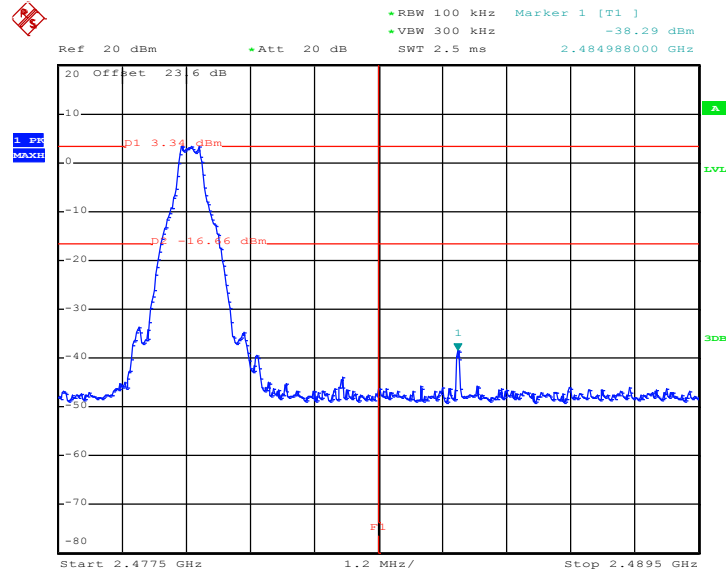

Date: 27.MAY.2017 16:56:22



<2Mbps>

Low Band Edge Plot on Channel 00

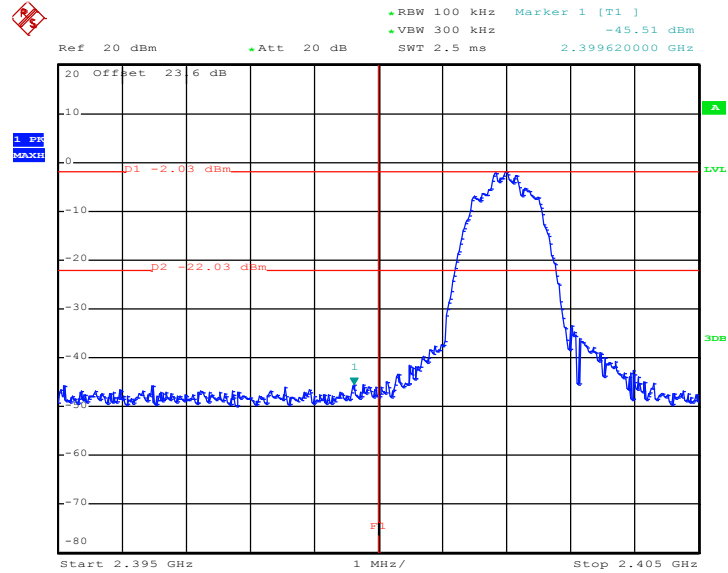

Date: 27.MAY.2017 17:24:51

High Band Edge Plot on Channel 78

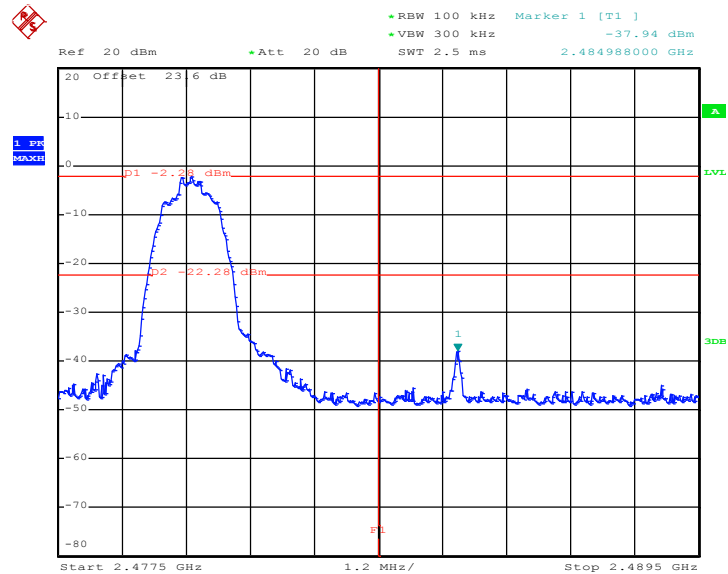

Date: 27.MAY.2017 17:12:54



<3Mbps>

Low Band Edge Plot on Channel 00

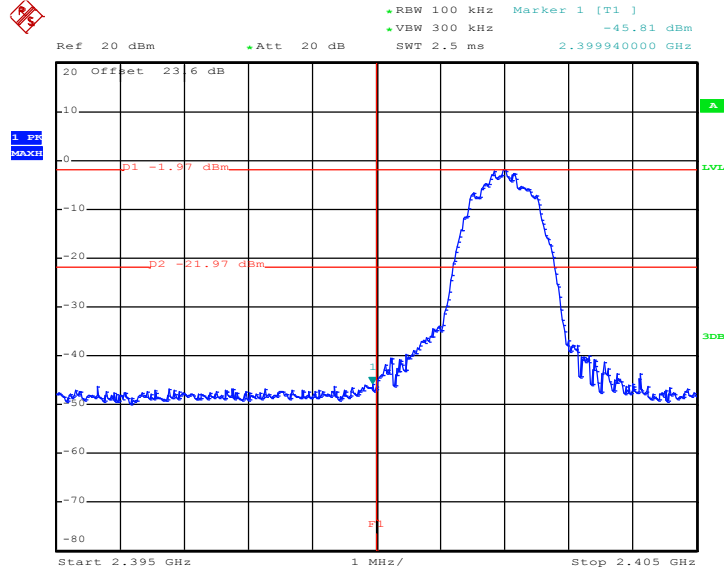

Date: 27.MAY.2017 17:32:39

High Band Edge Plot on Channel 78

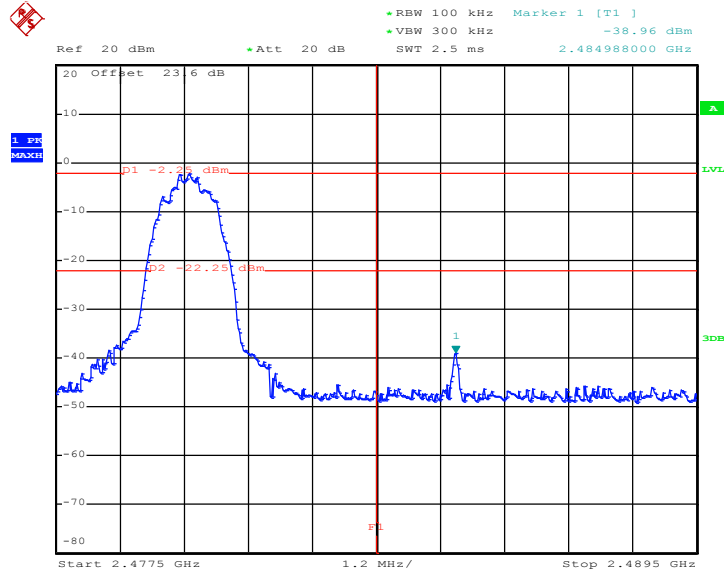

Date: 27.MAY.2017 17:41:26



3.6.6 Test Result of Conducted Hopping Mode Band Edges

Please refer to Appendix A.

<1Mbps>

Hopping Mode Low Band Edge Plot

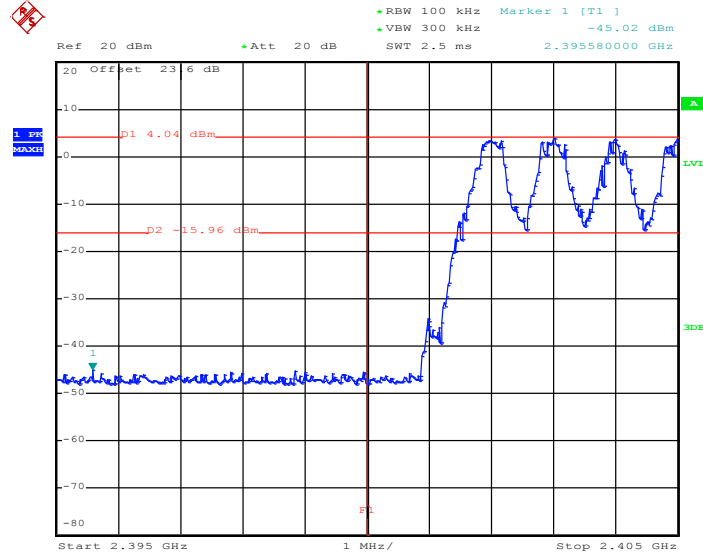

Date: 27.MAY.2017 18:14:19

Hopping Mode High Band Edge Plot

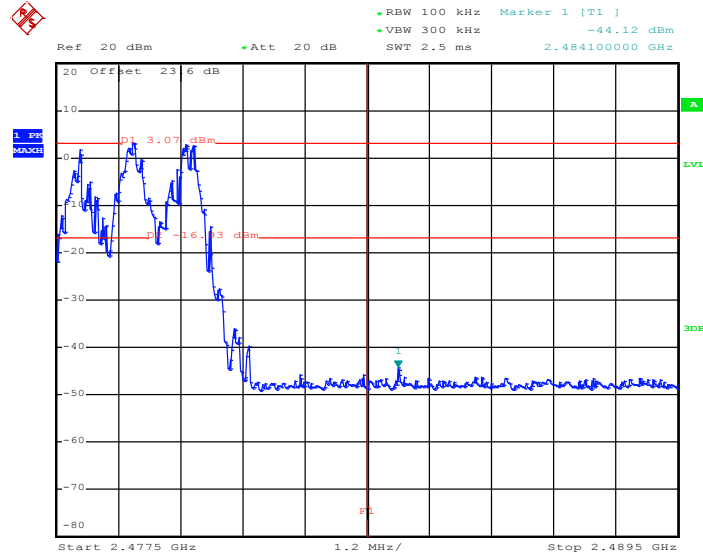

Date: 27.MAY.2017 18:14:40



<2Mbps>

Hopping Mode Low Band Edge Plot

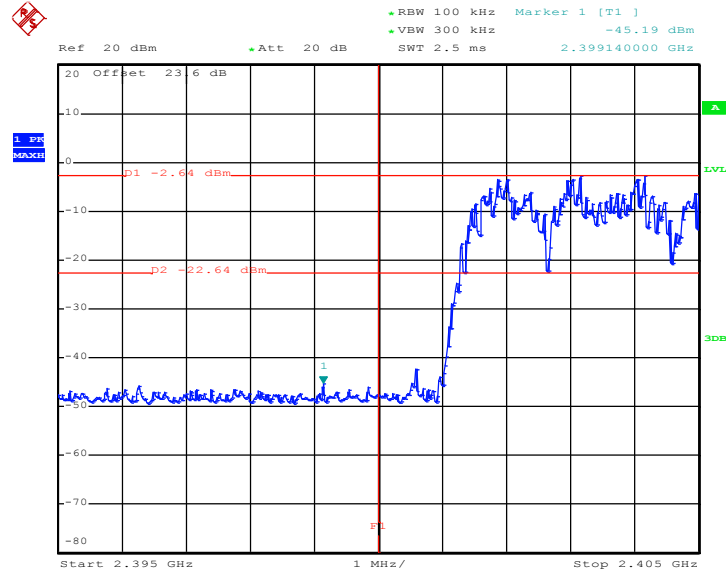

Date: 27.MAY.2017 18:15:38

Hopping Mode High Band Edge Plot

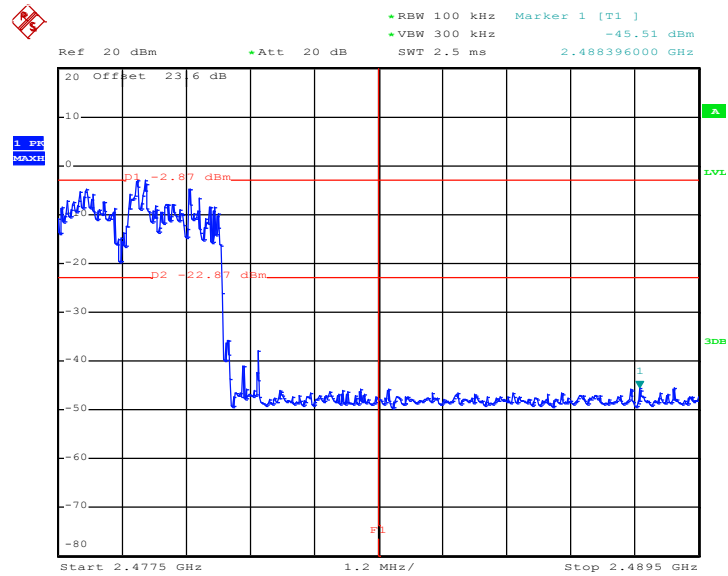

Date: 27.MAY.2017 18:15:15



<3Mbps>

Hopping Mode Low Band Edge Plot

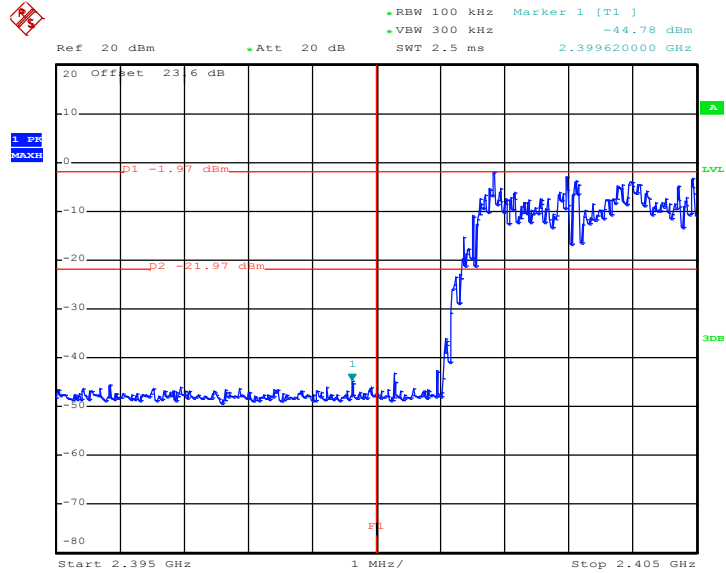

Date: 27.MAY.2017 18:16:21

Hopping Mode High Band Edge Plot

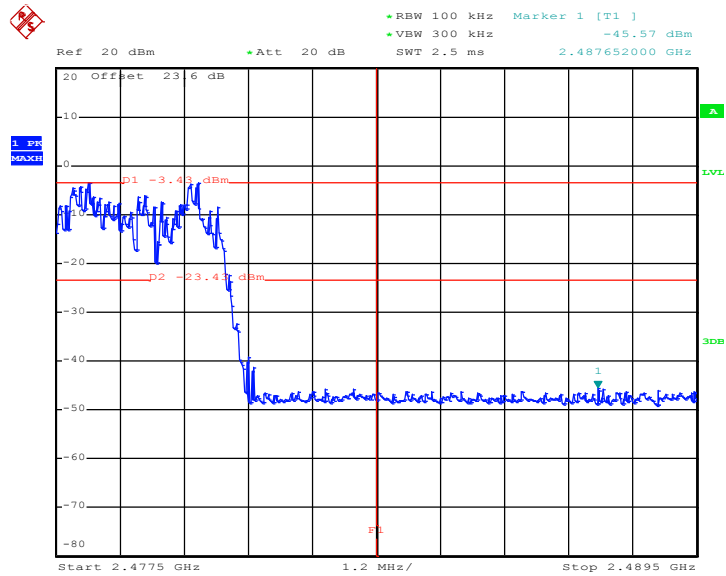

Date: 27.MAY.2017 18:16:47

3.7 Conducted Spurious Emission Measurement

3.7.1 Limit of Spurious Emission Measurement

In any 100 kHz bandwidth outside the intentional radiation frequency band, the radio frequency power shall be at least 20 dB below the highest level of the radiated power. In addition, radiated emissions which fall in the restricted bands must also comply with the radiated emission limits.

3.7.2 Measuring Instruments

The measuring equipment is listed in the section 4 of this test report.

3.7.3 Test Procedure

1. The testing follows ANSI C63.10-2013 clause 7.8.8.
2. The RF output of EUT was connected to the spectrum analyzer by RF cable and attenuator. The path loss was compensated to the results for each measurement.
3. Set to the maximum power setting and enable the EUT transmit continuously.
4. Set RBW = 100 kHz, VBW = 300kHz, scan up through 10th harmonic. All harmonics / spurs must be at least 20 dB down from the highest emission level within the authorized band as measured with a 100 kHz RBW.
5. Measure and record the results in the test report.
6. The RF fundamental frequency should be excluded against the limit line in the operating frequency band.

3.7.4 Test Setup

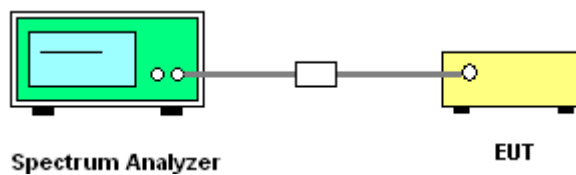



3.7.5 Test Result of Conducted Spurious Emission

Please refer to Appendix A.

<1Mbps>

CSE Plot on Ch 00 between 30MHz ~ 3 GHz

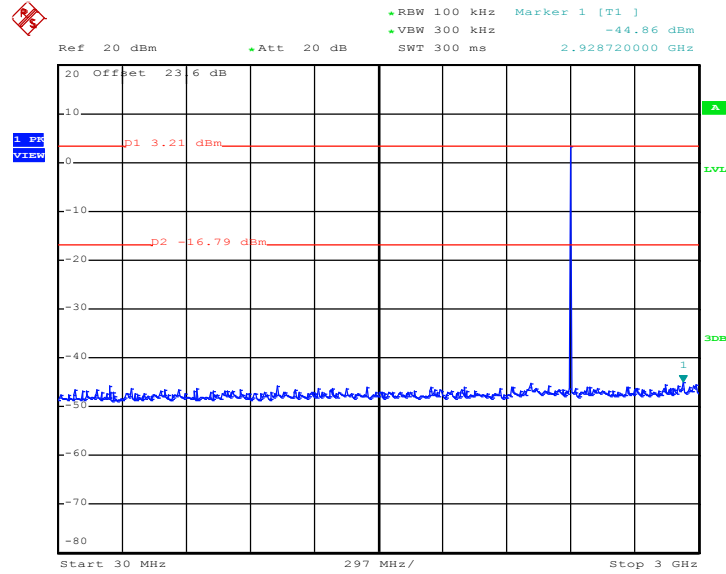

Date: 27.MAY.2017 17:49:00

1Mbps CSE Plot on Ch 00 between 2 GHz ~ 25 GHz

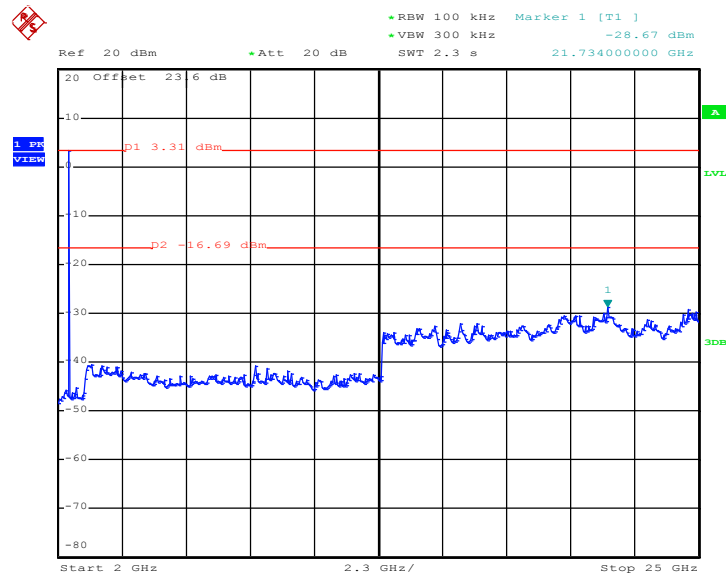

Date: 27.MAY.2017 17:49:21



CSE Plot on Ch 39 between 30MHz ~ 3 GHz

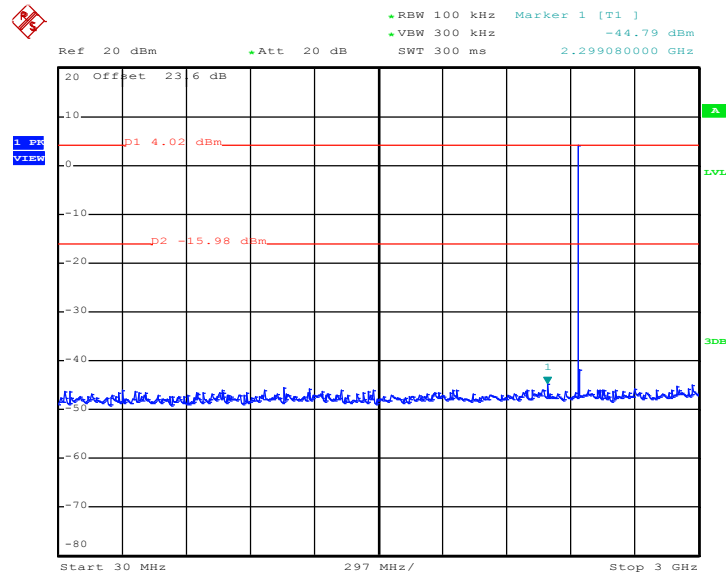

Date: 27.MAY.2017 17:47:49

CSE Plot on Ch 39 between 2 GHz ~ 25 GHz

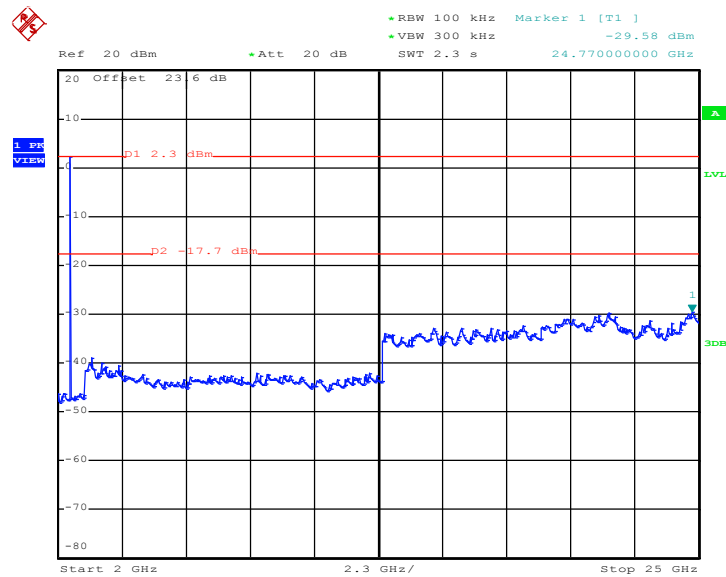

Date: 27.MAY.2017 17:48:10



CSE Plot on Ch 78 between 30MHz ~ 3 GHz

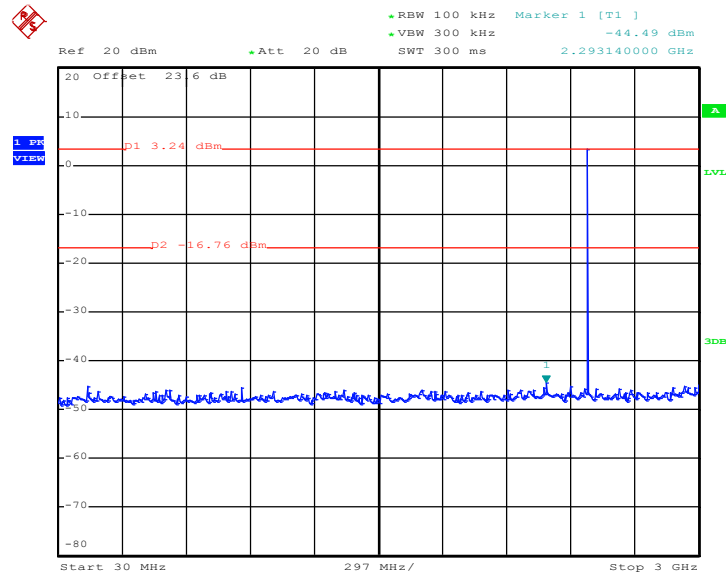

Date: 27.MAY.2017 17:46:35

CSE Plot on Ch 78 between 2 GHz ~ 25 GHz

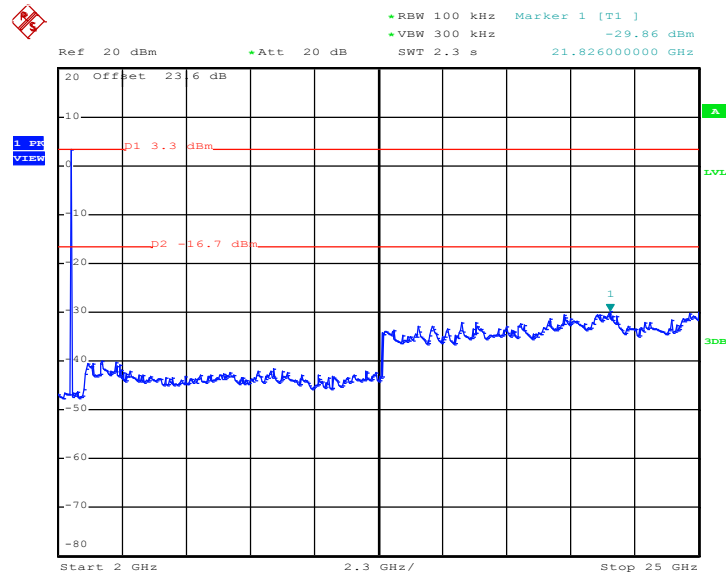

Date: 27.MAY.2017 17:46:57



<2Mbps>

CSE Plot on Ch 00 between 30MHz ~ 3 GHz

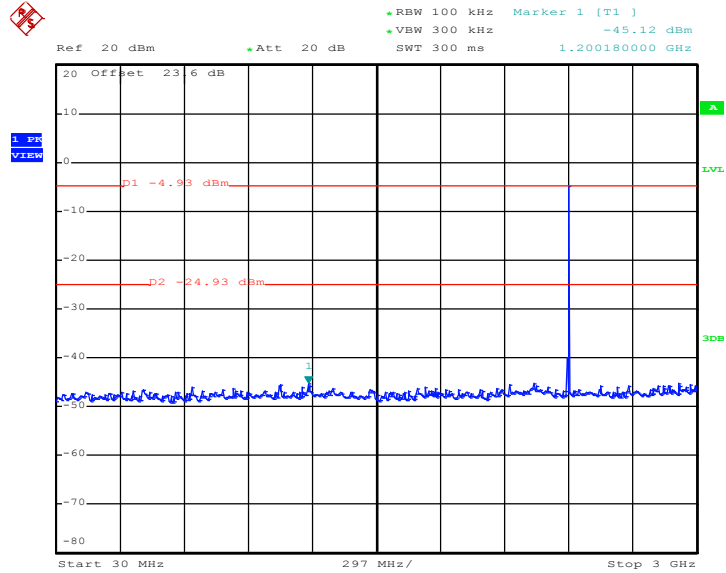

Date: 27.MAY.2017 17:23:24

CSE Plot on Ch 00 between 2 GHz ~ 25 GHz

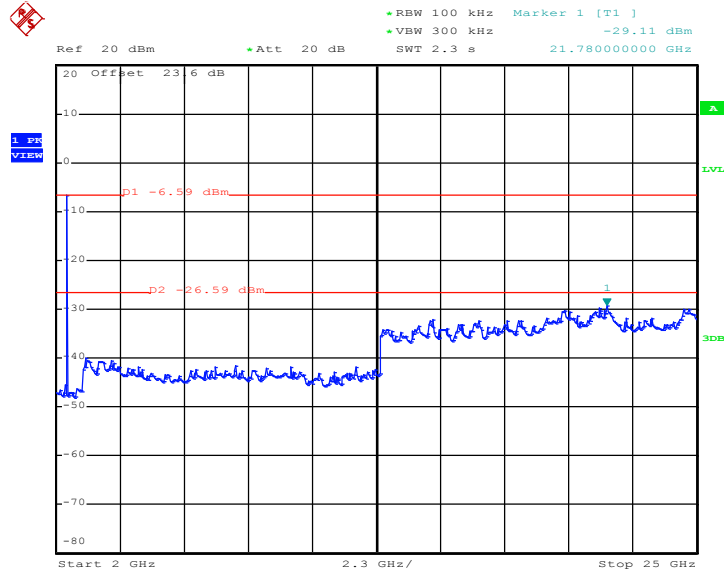

Date: 27.MAY.2017 17:23:45



CSE Plot on Ch 39 between 30MHz ~ 3 GHz

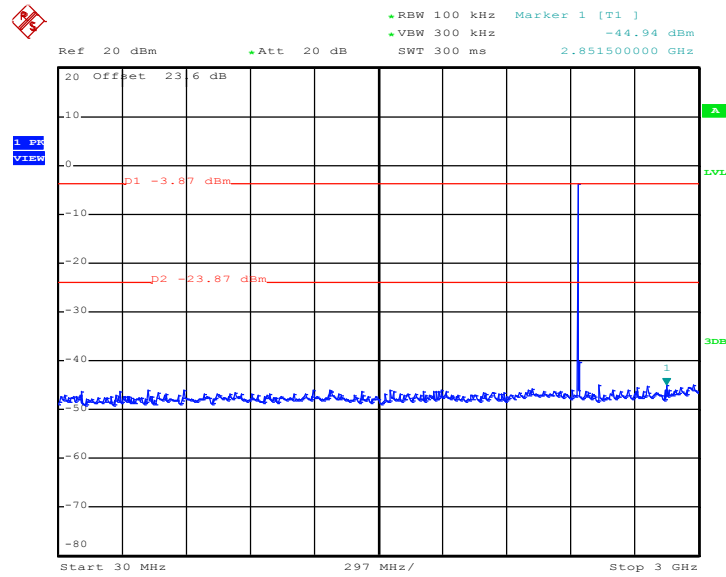

Date: 27.MAY.2017 17:18:33

CSE Plot on Ch 39 between 2 GHz ~ 25 GHz

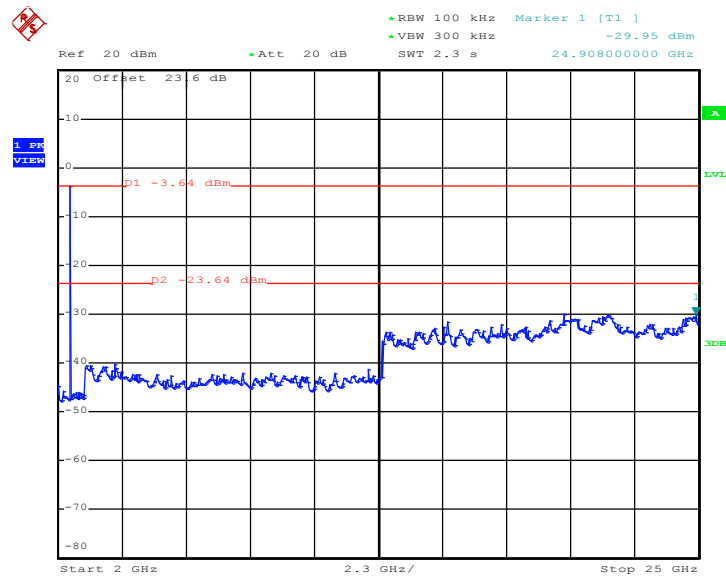

Date: 27.MAY.2017 17:18:55



CSE Plot on Ch 78 between 30MHz ~ 3 GHz

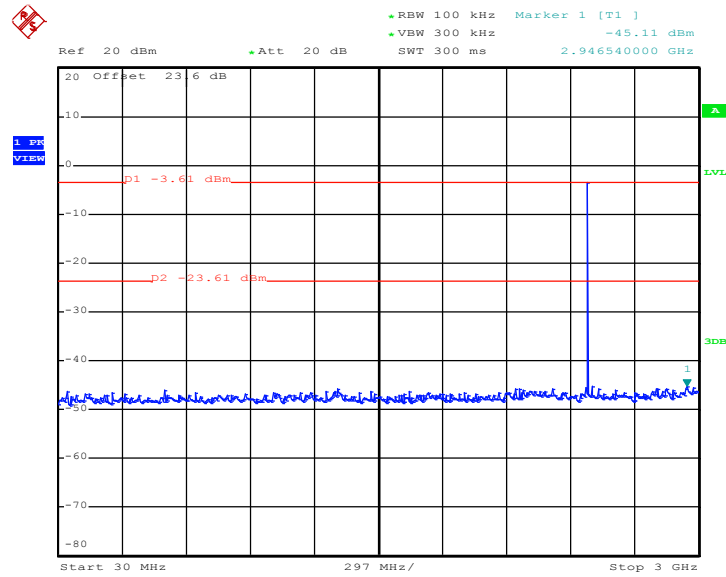

Date: 27.MAY.2017 17:07:54

CSE Plot on Ch 78 between 2 GHz ~ 25 GHz

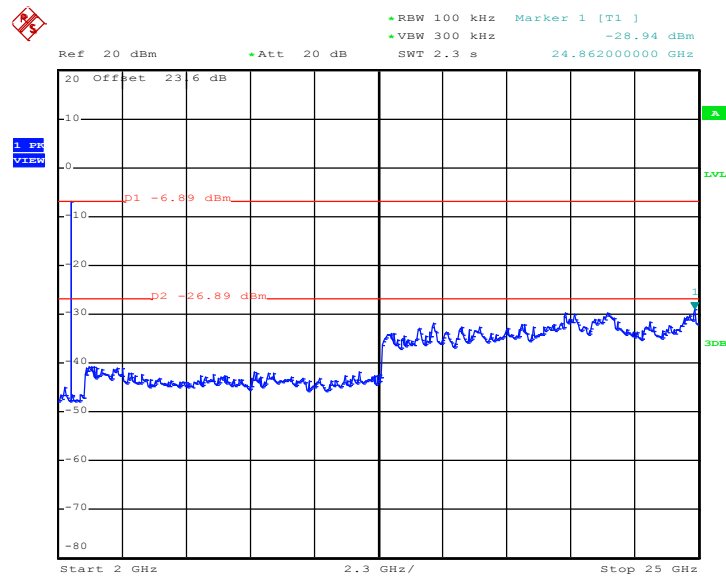

Date: 27.MAY.2017 17:08:16



<3Mbps>

CSE Plot on Ch 00 between 30MHz ~ 3 GHz

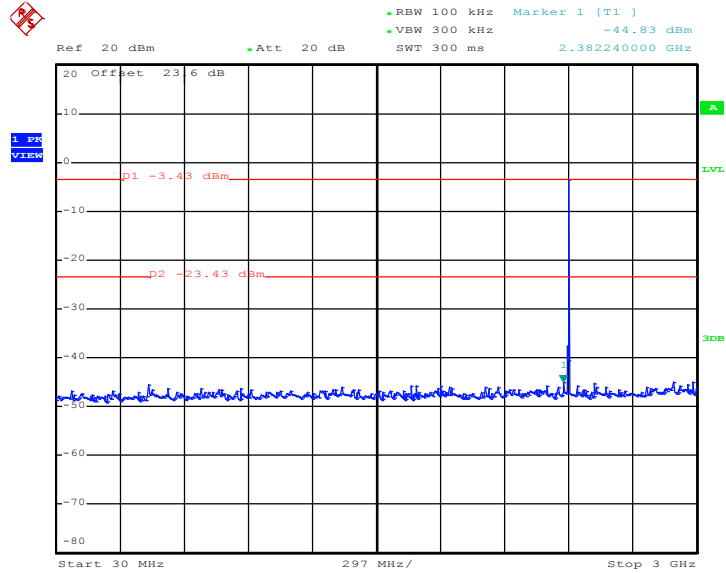

Date: 2.JUN.2017 09:11:25

CSE Plot on Ch 00 between 2 GHz ~ 25 GHz

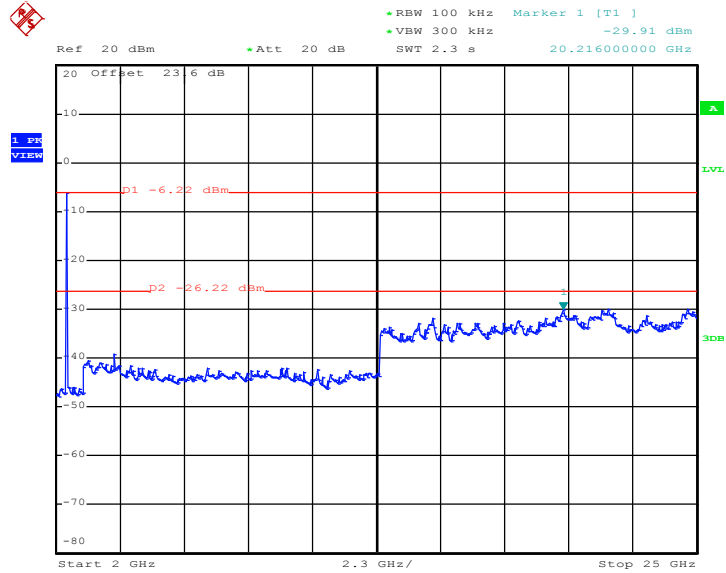

Date: 27.MAY.2017 17:29:50



CSE Plot on Ch 39 between 30MHz ~ 3 GHz

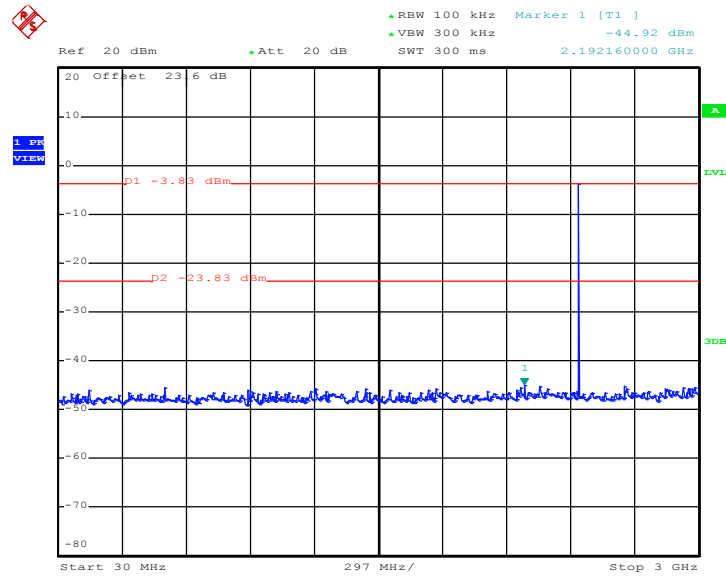

Date: 27.MAY.2017 17:35:01

CSE Plot on Ch 39 between 2 GHz ~ 25 GHz

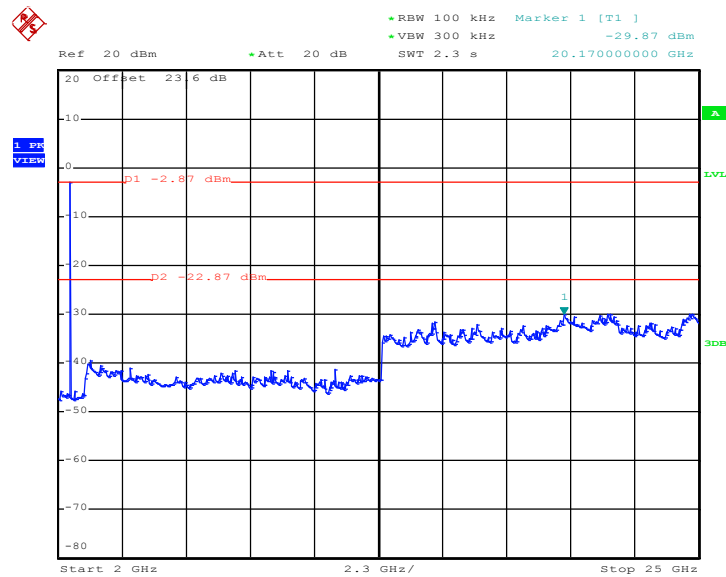

Date: 27.MAY.2017 17:35:23



CSE Plot on Ch 78 between 30MHz ~ 3 GHz

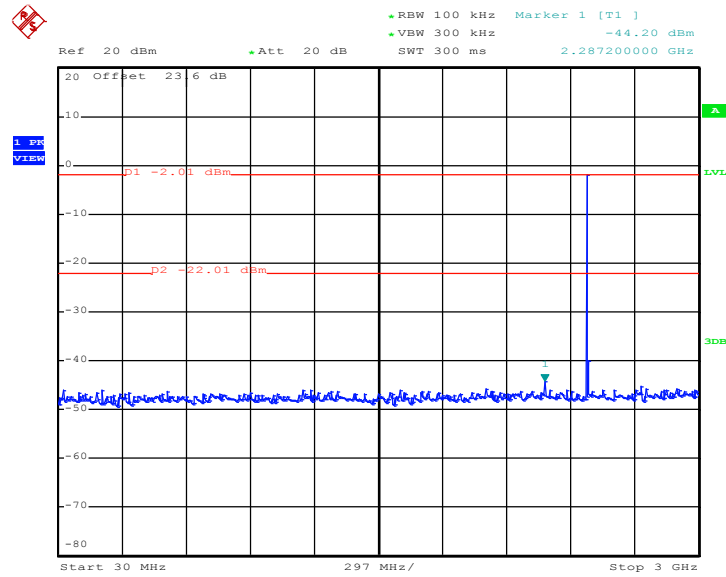

Date: 27.MAY.2017 17:43:04

CSE Plot on Ch 78 between 2 GHz ~ 25 GHz

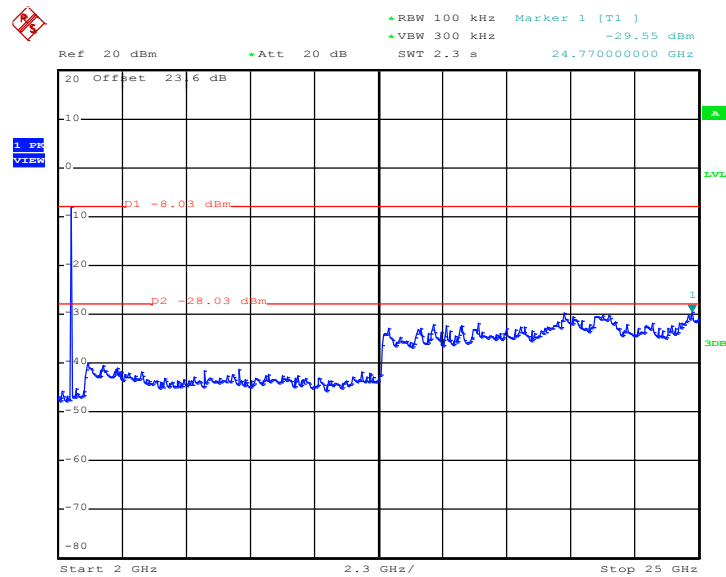

Date: 27.MAY.2017 17:43:26



3.8 Radiated Band Edges and Spurious Emission Measurement

3.8.1 Limit of Radiated Band Edges and Spurious Emission

In any 100 kHz bandwidth outside the intentional radiator frequency band, all harmonics/spurious must be at least 20 dB below the highest emission level within the authorized band. In addition, radiated emissions which fall in the restricted bands must also comply with the limits as below.

Frequency (MHz)	Field Strength (microvolts/meter)	Measurement Distance (meters)
0.009 – 0.490	2400/F(kHz)	300
0.490 – 1.705	24000/F(kHz)	30
1.705 – 30.0	30	30
30 – 88	100	3
88 – 216	150	3
216 - 960	200	3
Above 960	500	3

3.8.2 Measuring Instruments

The measuring equipment is listed in the section 4 of this test report.



3.8.3 Test Procedures

1. The EUT was placed on a turntable with 0.8 meter for frequency below 1GHz and 1.5 meter for frequency above 1GHz respectively above ground.
2. The EUT was set 3 meters from the interference receiving antenna, which was mounted on the top of a variable height antenna tower.
3. For each suspected emission, the EUT was arranged to its worst case and then tune the Antenna tower (from 1 m to 4 m) and turntable (from 0 degree to 360 degrees) to find the maximum reading. A pre-amp and a high pass filter are used for the test in order to get better signal level to comply with the guidelines.
4. Set to the maximum power setting and enable the EUT transmit continuously.
5. Use the following spectrum analyzer settings:
 - (1) Span shall wide enough to fully capture the emission being measured;
 - (2) Set RBW=100 kHz for $f < 1 \text{ GHz}$, RBW=1MHz for $f > 1\text{GHz}$; VBW \geq RBW; Sweep = auto; Detector function = peak; Trace = max hold for peak
 - (3) For average measurement: use duty cycle correction factor method per 15.35(c).
Duty cycle = On time/100 milliseconds
On time = $N_1 * L_1 + N_2 * L_2 + \dots + N_{n-1} * L_{n-1} + N_n * L_n$
Where N_1 is number of type 1 pulses, L_1 is length of type 1 pulses, etc.
Average Emission Level = Peak Emission Level + $20 * \log(\text{Duty cycle})$
6. Corrected Reading: Antenna Factor + Cable Loss + Read Level - Preamp Factor = Level

Note: The average levels were calculated from the peak level corrected with duty cycle correction factor (-24.79dB) derived from $20 \log(\text{dwell time}/100\text{ms})$. This correction is only for signals that hop with the fundamental signal, such as band-edge and harmonic. Other spurious signals that are independent of the hopping signal would not use this correction.

3.8.4 Test Setup

For radiated emissions below 30MHz

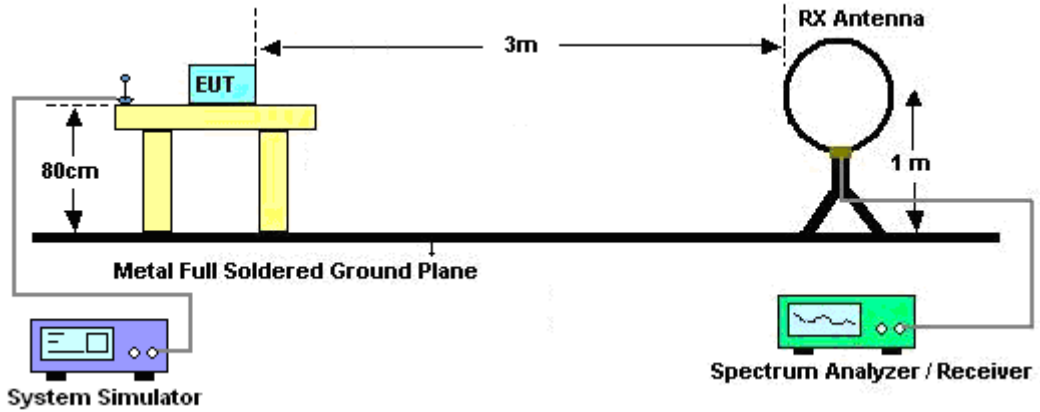

For radiated emissions from 30MHz to 1GHz

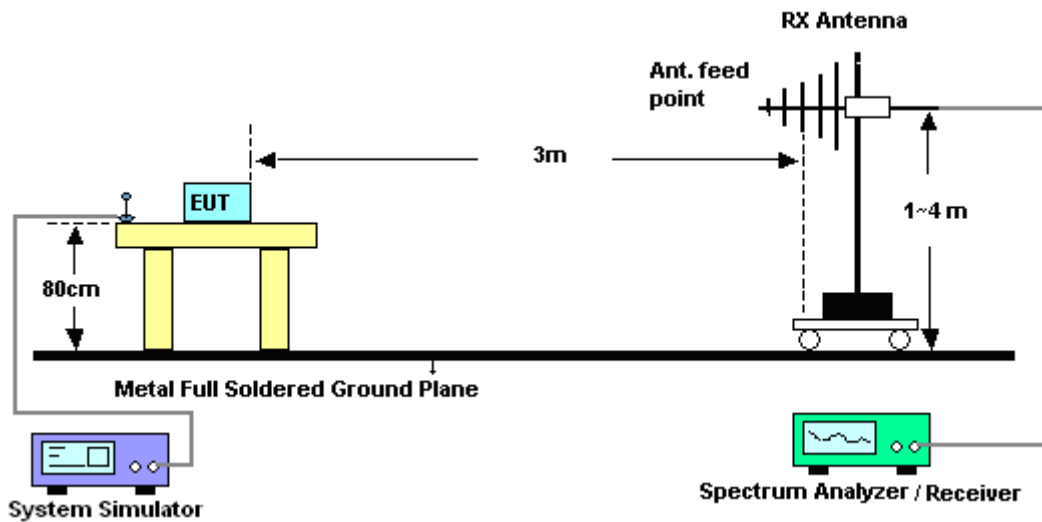

For radiated emissions above 1GHz

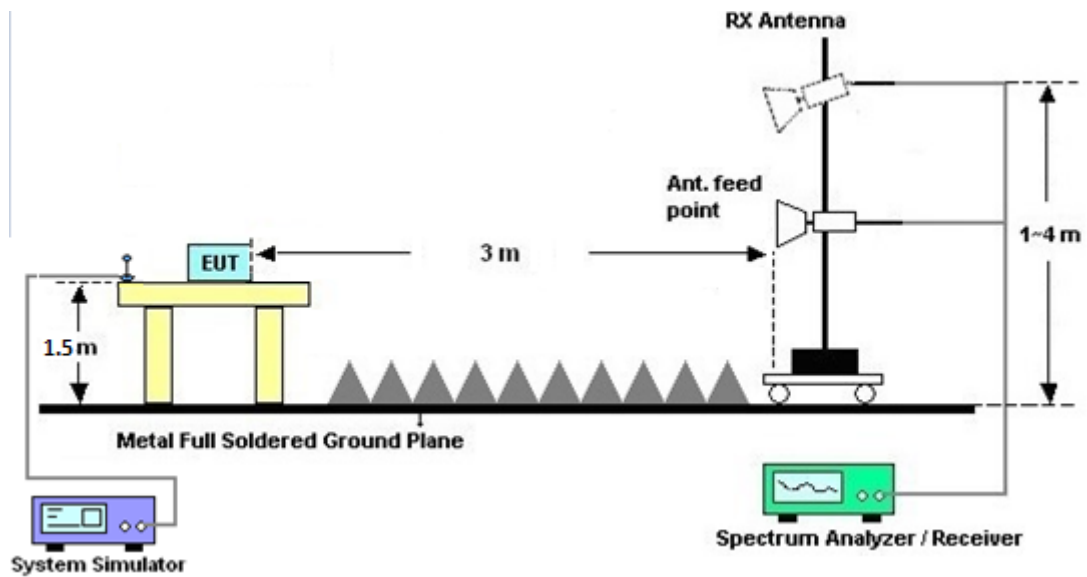

3.8.5 Test Results of Radiated Spurious Emissions (9 kHz ~ 30 MHz)

The low frequency, which started from 9 kHz to 30MHz, was pre-scanned and the result which was 20dB lower than the limit line per 15.31(o) was not reported.

There is a comparison data of both open-field test site and semi-Anechoic chamber, and the result came out very similar.

3.8.6 Test Result of Radiated Spurious at Band Edges

Please refer to Appendix C and D.

3.8.7 Duty Cycle

Please refer to Appendix E.

3.8.8 Test Result of Radiated Spurious Emission (30MHz ~ 10th Harmonic)

Please refer to Appendix C and D.



3.9 AC Conducted Emission Measurement

3.9.1 Limit of AC Conducted Emission

For equipment that is designed to be connected to the public utility (AC) power line, the radio frequency voltage that is conducted back onto the AC power line on any frequency or frequencies within the band 150 kHz to 30 MHz shall not exceed the limits in the following table.

Frequency of emission (MHz)	Conducted limit (dBµV)	
	Quasi-peak	Average
0.15-0.5	66 to 56*	56 to 46*
0.5-5	56	46
5-30	60	50

*Decreases with the logarithm of the frequency.

3.9.2 Measuring Instruments

The measuring equipment is listed in the section 4 of this test report.

3.9.3 Test Procedures

1. The EUT was placed 0.4 meter from the conducting wall of the shielding room was kept at least 80 centimeters from any other grounded conducting surface.
2. Connect EUT to the power mains through a line impedance stabilization network (LISN).
3. All the support units are connecting to the other LISN.
4. The LISN provides 50 ohm coupling impedance for the measuring instrument.
5. The FCC states that a 50 ohm, 50 microhenry LISN should be used.
6. Both sides of AC line were checked for maximum conducted interference.
7. The frequency range from 150 kHz to 30 MHz was searched.
8. Set the test-receiver system to Peak Detect Function and specified bandwidth (IF Bandwidth = 9kHz) with Maximum Hold Mode. Then measurement is also conducted by Average Detector and Quasi-Peak Detector Function respectively.

3.9.4 Test Setup

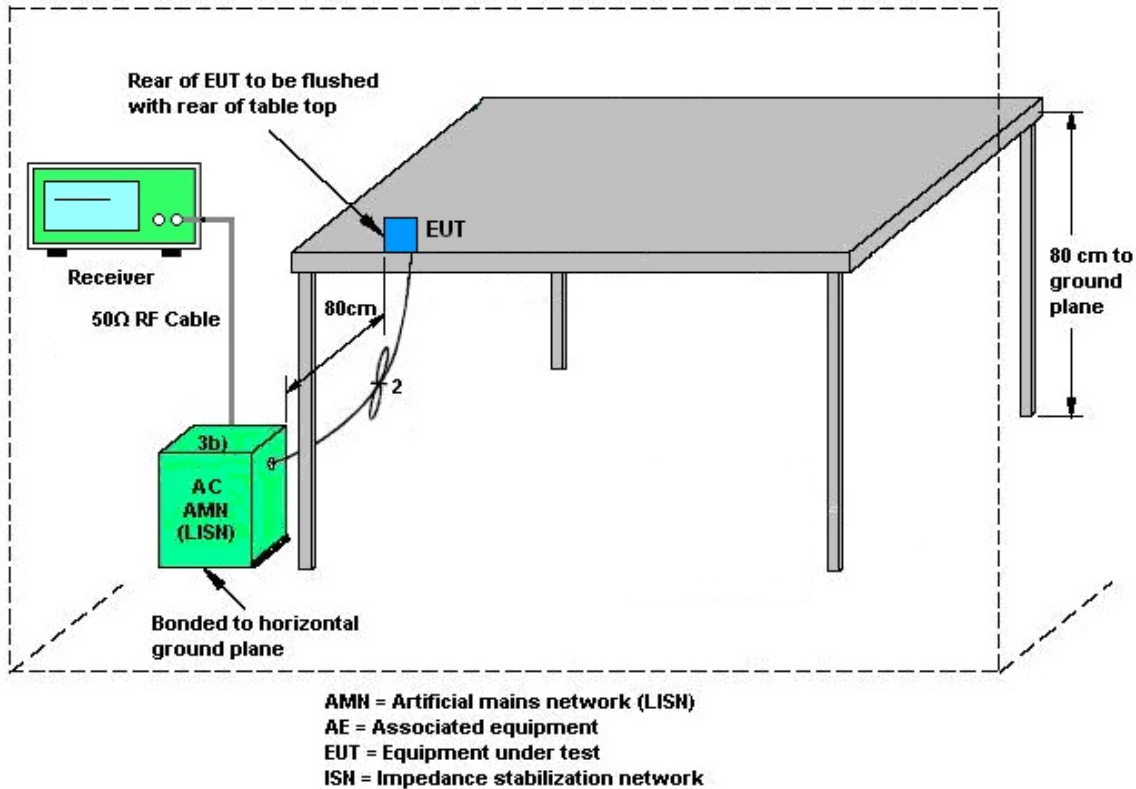

3.9.5 Test Result of AC Conducted Emission

Please refer to Appendix B.



3.10 Antenna Requirements

3.10.1 Standard Applicable

If directional gain of transmitting antennas is greater than 6dBi, the power shall be reduced by the same level in dB comparing to gain minus 6dBi. The use of a permanently attached antenna or of an antenna that uses a unique coupling to the intentional radiator shall be considered sufficient to comply with the rule.

3.10.2 Antenna Anti-Replacement Construction

An embedded-in antenna design is used.

3.10.3 Antenna Gain

The antenna peak gain of EUT is less than 6 dBi. Therefore, it is not necessary to reduce maximum peak output power limit.



4 List of Measuring Equipment

Instrument	Manufacturer	Model No.	Serial No.	Characteristics	Calibration Date	Test Date	Due Date	Remark
Power Meter	Agilent	E4416A	GB412923 44	300MHz~40GHz	Dec. 26, 2016	May 03, 2017 ~ Jun. 02, 2017	Dec. 25, 2017	Conducted (TH05-HY)
Power Sensor	Agilent	E9327A	US404415 48	300MHz~40GHz	Dec. 26, 2016	May 03, 2017 ~ Jun. 02, 2017	Dec. 25, 2017	Conducted (TH05-HY)
Spectrum Analyzer	Rohde & Schwarz	FSP40	100055	9kHz-40GHz	Jul. 17, 2016	May 03, 2017 ~ Jun. 02, 2017	Jul. 16, 2017	Conducted (TH05-HY)
BT Base Station(Measure)	Rohde & Schwarz	CBT	101136	BT 3.0	Sep. 21, 2016	May 03, 2017 ~ Jun. 02, 2017	Sep. 20, 2017	Conducted (TH05-HY)
Spectrum Analyzer	Keysight	N9010A	MY542004 86	10Hz ~ 44GHz	Oct. 12, 2016	May 12, 2017 ~ Jun. 08, 2017	Oct. 11, 2017	Radiation (03CH11-HY)
EMI Test Receiver	Agilent	N9038A(MXE)	MY532900 53	20Hz to 26.5GHz	Jan. 12, 2017	May 12, 2017 ~ Jun. 08, 2017	Jan. 11, 2018	Radiation (03CH11-HY)
Loop Antenna	Rohde & Schwarz	HFH2-Z2	100488	9 kHz~30 MHz	Oct. 20, 2016	May 12, 2017 ~ Jun. 08, 2017	Oct. 19, 2018	Radiation (03CH11-HY)
Bilog Antenna	TESEQ	CBL 6111D&N-6-06	35414&AT- N0602	30MHz~1GHz	Oct. 15, 2016	May 12, 2017 ~ Jun. 08, 2017	Oct. 14, 2017	Radiation (03CH11-HY)
Horn Antenna	SCHWARZBE CK	BBHA 9120 D	9120D-132 6	1GHz ~ 18GHz	Oct. 07, 2016	May 12, 2017 ~ Jun. 08, 2017	Oct. 06, 2017	Radiation (03CH11-HY)
SHF-EHF Horn Antenna	SCHWARZBE CK	BBHA 9170	BBHA9170 584	18GHz- 40GHz	Nov. 08, 2016	May 12, 2017 ~ Jun. 08, 2017	Nov. 07, 2017	Radiation (03CH11-HY)
Amplifier	SONOMA	310N	187312	9kHz~1GHz	Nov. 10, 2016	May 12, 2017 ~ Jun. 08, 2017	Nov. 09, 2017	Radiation (03CH11-HY)
Preamplifier	Keysight	83017A	MY532700 80	1GHz~26.5GHz	Nov. 10, 2016	May 12, 2017 ~ Jun. 08, 2017	Nov. 09, 2017	Radiation (03CH11-HY)
Preamplifier	MITEQ	AMF-7D-00101 800	2025787	1GHz~18GHz	Feb. 13, 2017	May 12, 2017 ~ Jun. 08, 2017	Feb. 12, 2018	Radiation (03CH11-HY)
Preamplifier	MITEQ	JS44-1800400 0-33-8P	1840917	18GHz ~ 40GHz	Jun. 14, 2016	May 12, 2017 ~ Jun. 08, 2017	Jun. 13, 2017	Radiation (03CH11-HY)
Antenna Mast	EMEC	AM-BS-4500-B	N/A	1~4m	N/A	May 12, 2017 ~ Jun. 08, 2017	N/A	Radiation (03CH11-HY)
Turn Table	EMEC	TT 2000	N/A	0~360 Degree	N/A	May 12, 2017 ~ Jun. 08, 2017	N/A	Radiation (03CH11-HY)
AC Power Source	ChainTek	APC-1000W	N/A	N/A	N/A	May 20, 2017	N/A	Conduction (CO05-HY)
EMI Test Receiver	Rohde & Schwarz	ESCI 7	100724	9kHz~7GHz	Aug. 30, 2016	May 20, 2017	Aug. 29, 2017	Conduction (CO05-HY)
LISN	Rohde & Schwarz	ENV216	100080	9kHz~30MHz	Nov. 29, 2016	May 20, 2017	Nov. 28, 2017	Conduction (CO05-HY)
LISN	Rohde & Schwarz	ENV216	100081	9kHz~30MHz	Dec. 06, 2016	May 20, 2017	Dec. 05, 2017	Conduction (CO05-HY)



5 Uncertainty of Evaluation

Uncertainty of Conducted Emission Measurement (150 kHz ~ 30 MHz)

Measuring Uncertainty for a Level of Confidence of 95% ($U = 2Uc(y)$)	2.70
-------------------------------------------------------------------------	------

Uncertainty of Radiated Emission Measurement (30 MHz ~ 1000 MHz)

Measuring Uncertainty for a Level of Confidence of 95% ($U = 2Uc(y)$)	5.2
-------------------------------------------------------------------------	-----

Uncertainty of Radiated Emission Measurement (1000 MHz ~ 18000 MHz)

Measuring Uncertainty for a Level of Confidence of 95% ($U = 2Uc(y)$)	5.5
-------------------------------------------------------------------------	-----

Uncertainty of Radiated Emission Measurement (18000 MHz ~ 40000 MHz)

Measuring Uncertainty for a Level of Confidence of 95% ($U = 2Uc(y)$)	5.2
-------------------------------------------------------------------------	-----

Appendix A. Test Result of Conducted Test Items

Test Engineer:	Jeremy Lin	Temperature:	21~25	°C
Test Date:	2017/05/03~2017/06/02	Relative Humidity:	51~54	%

TEST RESULTS DATA**20dB and 99% Occupied Bandwidth and Hopping Channel Separation**

Mod.	Data Rate	NTX	CH.	Freq. (MHz)	20db BW (MHz)	99% Bandwidth (MHz)	Hopping Channel Separation Measurement (MHz)	Hopping Channel Separation Limit (MHz)	Pass/Fail
DH	1Mbps	1	0	2402	0.944	0.868	1.002	0.6293	Pass
DH	1Mbps	1	39	2441	0.928	0.856	1.158	0.6187	Pass
DH	1Mbps	1	78	2480	0.940	0.868	1.002	0.6267	Pass
2DH	2Mbps	1	0	2402	1.428	1.352	1.002	0.9520	Pass
2DH	2Mbps	1	39	2441	1.428	1.352	1.002	0.9520	Pass
2DH	2Mbps	1	78	2480	1.448	1.352	1.002	0.9653	Pass
3DH	3Mbps	1	0	2402	1.448	1.352	1.014	0.9653	Pass
3DH	3Mbps	1	39	2441	1.440	1.352	1.002	0.9600	Pass
3DH	3Mbps	1	78	2480	1.448	1.356	1.002	0.9653	Pass

TEST RESULTS DATA**Dwell Time**

Mod.	Hopping Channel Number Rate	Hops Over Occupancy Time(hops)	Package Transfer Time (msec) (MHz)	Dwell Time (sec)	Limits (sec)	Pass/Fail
Normal	79	106.67	2.90	0.31	0.4	Pass
AFH	20	53.33	2.90	0.15	0.4	Pass

TEST RESULTS DATA**Peak Power Table**

DH	CH.	NTX	Peak Power (dBm)	Power Limit (dBm)	Test Result
DH1	0	1	5.33	20.97	Pass
	39	1	5.19	20.97	Pass
	78	1	4.88	20.97	Pass
2DH	CH.	NTX	Peak Power (dBm)	Power Limit (dBm)	Test Result
2DH1	0	1	2.12	20.97	Pass
	39	1	1.98	20.97	Pass
	78	1	1.64	20.97	Pass
3DH	CH.	NTX	Peak Power (dBm)	Power Limit (dBm)	Test Result
3DH1	0	1	2.29	20.97	Pass
	39	1	2.15	20.97	Pass
	78	1	1.80	20.97	Pass

TEST RESULTS DATA**Number of Hopping Frequency**

Number of Hopping (Channel)	Adaptive Frequency Hopping (Channel)	Limits (Channel)	Pass/Fail
79	20	> 15	Pass



Appendix B. AC Conducted Emission Test Results

Test Engineer :	Eric Jeng	Temperature :	22~25°C
		Relative Humidity :	51~54%

EUT Information

Report NO : 742622
 Test Mode : Mode 1
 Test Voltage : 120Vac/60Hz
 Phase : Line

ENV216 Auto Test FCC Power Bar - L

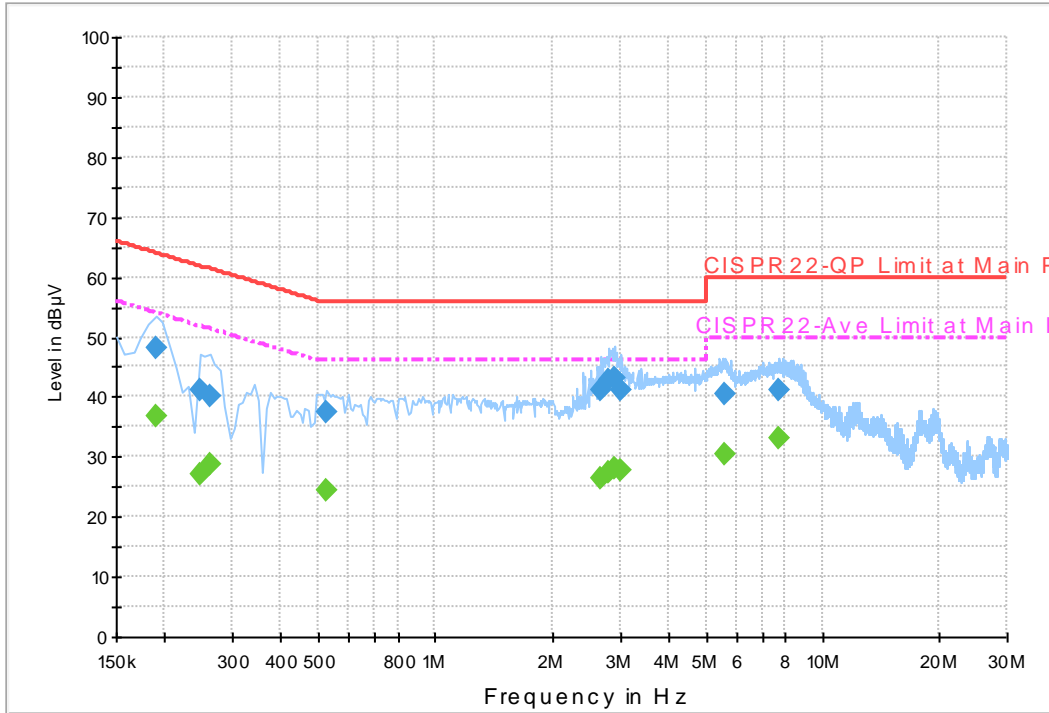

Final Result 1

Frequency (MHz)	QuasiPeak (dBµV)	Filter	Line	Corr. (dB)	Margin (dB)	Limit (dBµV)
0.190000	48.3	Off	L1	19.6	15.7	64.0
0.246000	41.1	Off	L1	19.6	20.8	61.9
0.262000	40.2	Off	L1	19.6	21.2	61.4
0.526000	37.3	Off	L1	19.6	18.7	56.0
2.686000	41.0	Off	L1	19.4	15.0	56.0
2.814000	42.9	Off	L1	19.5	13.1	56.0
2.902000	43.2	Off	L1	19.5	12.8	56.0
3.030000	41.0	Off	L1	19.6	15.0	56.0
5.630000	40.5	Off	L1	19.8	19.5	60.0
7.694000	41.0	Off	L1	19.9	19.0	60.0

Final Result 2

Frequency (MHz)	Average (dBµV)	Filter	Line	Corr. (dB)	Margin (dB)	Limit (dBµV)
0.190000	36.7	Off	L1	19.6	17.3	54.0
0.246000	27.1	Off	L1	19.6	24.8	51.9
0.262000	28.9	Off	L1	19.6	22.5	51.4
0.526000	24.5	Off	L1	19.6	21.5	46.0
2.686000	26.3	Off	L1	19.4	19.7	46.0
2.814000	27.3	Off	L1	19.5	18.7	46.0
2.902000	28.1	Off	L1	19.5	17.9	46.0
3.030000	27.7	Off	L1	19.6	18.3	46.0
5.630000	30.6	Off	L1	19.8	19.4	50.0

7.694000	33.2	Off	L1	19.9	16.8	50.0
----------	------	-----	----	------	------	------

EUT Information

Report NO : 742622
 Test Mode : Mode 1
 Test Voltage : 120Vac/60Hz
 Phase : Neutral

ENV216 Auto Test FCC Power Bar - N

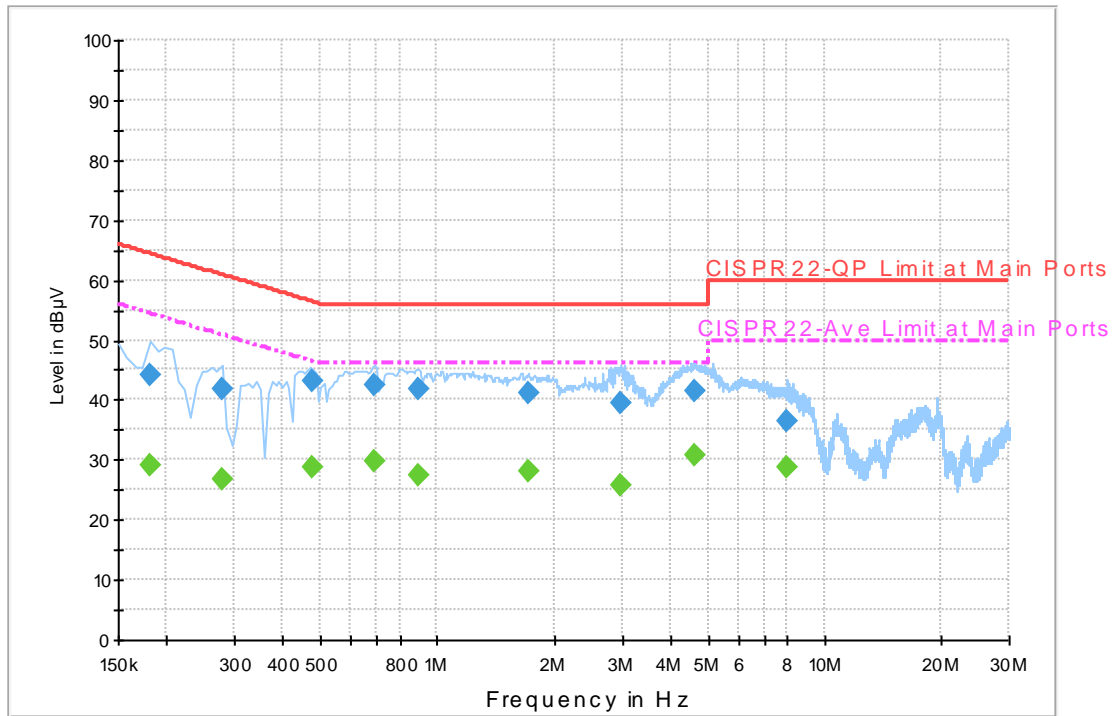

Final Result 1

Frequency (MHz)	QuasiPeak (dBµV)	Filter	Line	Corr. (dB)	Margin (dB)	Limit (dBµV)
0.182000	44.3	Off	N	19.5	20.1	64.4
0.278000	41.8	Off	N	19.5	19.1	60.9
0.478000	43.0	Off	N	19.5	13.4	56.4
0.686000	42.5	Off	N	19.5	13.5	56.0
0.894000	41.7	Off	N	19.5	14.3	56.0
1.718000	41.1	Off	N	19.6	14.9	56.0
2.990000	39.5	Off	N	19.5	16.5	56.0
4.654000	41.5	Off	N	19.7	14.5	56.0
8.046000	36.5	Off	N	19.9	23.5	60.0

Final Result 2

Frequency (MHz)	Average (dBµV)	Filter	Line	Corr. (dB)	Margin (dB)	Limit (dBµV)
0.182000	29.2	Off	N	19.5	25.2	54.4
0.278000	26.7	Off	N	19.5	24.2	50.9
0.478000	28.8	Off	N	19.5	17.6	46.4
0.686000	29.8	Off	N	19.5	16.2	46.0
0.894000	27.5	Off	N	19.5	18.5	46.0
1.718000	27.9	Off	N	19.6	18.1	46.0
2.990000	25.6	Off	N	19.5	20.4	46.0
4.654000	30.9	Off	N	19.7	15.1	46.0
8.046000	28.6	Off	N	19.9	21.4	50.0



Appendix C. Radiated Spurious Emission

Test Engineer :	J.C. Liang, Jacky Hung and Ken Wu	Temperature :	20~23°C
		Relative Humidity :	58~63%

2.4GHz 2400~2483.5MHz

BT (Band Edge @ 3m)

BT	Note	Frequency	Level	Over	Limit	Read	Antenna	Cable	Preamp	Ant	Table	Peak	Pol.
		(MHz)	(dBμV/m)	(dB)	Limit	Level	Factor	Loss	Factor	Pos	Pos	Avg.	
					Line	(dBμV)	(dB/m)	(dB)	(dB)	(cm)	(deg)	(P/A)	(H/V)
BT CH00 2402MHz		2341.815	44.57	-29.43	74	45.24	26.7	6.23	33.6	213	239	P	H
		2341.815	19.78	-34.22	54	-	-	-	-	-	-	A	H
	*	2402	103.45	-	-	103.81	26.87	6.36	33.59	213	239	P	H
	*	2402	78.66	-	-	-	-	-	-	-	-	A	H
		2382.135	42.88	-31.12	74	43.35	26.81	6.32	33.6	329	265	P	V
		2382.135	18.09	-35.91	54	-	-	-	-	-	-	A	V
	*	2402	98.87	-	-	99.23	26.87	6.36	33.59	329	265	P	V
	*	2402	74.08	-	-	-	-	-	-	-	-	A	V
BT CH 39 2441MHz		2361.1	45.62	-28.38	74	46.19	26.76	6.27	33.6	211	241	P	H
		2361.1	20.83	-33.17	54	-	-	-	-	-	-	A	H
	*	2441	104.12	-	-	104.3	27.03	6.37	33.58	211	241	P	H
	*	2441	79.33	-	-	-	-	-	-	-	-	A	H
		2485.86	42.52	-31.48	74	42.57	27.14	6.39	33.58	211	241	P	H
		2485.86	17.73	-36.27	54	-	-	-	-	-	-	A	H
		2340.94	43.39	-30.61	74	44.06	26.7	6.23	33.6	325	264	P	V
		2340.94	18.6	-35.4	54	-	-	-	-	-	-	A	V
	*	2441	99.43	-	-	99.61	27.03	6.37	33.58	325	264	P	V
	*	2441	74.64	-	-	-	-	-	-	-	-	A	V
		2488.45	42.95	-31.05	74	42.94	27.2	6.39	33.58	325	264	P	V
		2488.45	18.16	-35.84	54	-	-	-	-	-	-	A	V



BT CH 78 2480MHz	*	2480	105.15	-	-	105.21	27.14	6.38	33.58	210	241	P	H
	*	2480	80.36	-	-	-	-	-	-	-	-	A	H
		2485	62.41	-11.59	74	62.46	27.14	6.39	33.58	210	241	P	H
		2485	37.62	-16.38	54	-	-	-	-	-	-	A	H
	*	2480	99.19	-	-	99.25	27.14	6.38	33.58	309	263	P	V
	*	2480	74.4	-	-	-	-	-	-	-	-	A	V
		2484.88	57.68	-16.32	74	57.73	27.14	6.39	33.58	309	263	P	V
		2484.88	32.89	-21.11	54	-	-	-	-	-	-	A	V
Remark	1. No other spurious found. 2. All results are PASS against Peak and Average limit line.												



2.4GHz 2400~2483.5MHz
BT (Harmonic @ 3m)

Table with 14 columns: BT, Note, Frequency (MHz), Level (dBµV/m), Over Limit (dB), Limit Line (dBµV/m), Read Level (dBµV), Antenna Factor (dB/m), Cable Loss (dB), Preamp Factor (dB), Ant Pos (cm), Table Pos (deg), Peak Avg. (P/A), Pol. (H/V). Rows include BT CH 00 2402MHz, BT CH 39 2441MHz, and BT CH 78 2480MHz.



Emission below 1GHz

2.4GHz BT (LF)

BT	Note	Frequency	Level	Over	Limit	Read	Antenna	Cable	Preamp	Ant	Table	Peak	Pol.
				Limit	Line	Level	Factor	Loss	Factor	Pos	Pos	Avg.	
		(MHz)	(dBμV/m)	(dB)	(dBμV/m)	(dBμV)	(dB/m)	(dB)	(dB)	(cm)	(deg)	(P/A)	(H/V)
2.4GHz BT LF		38.64	30.29	-9.71	40	42.24	19.85	0.68	32.49	100	0	P	H
		139.35	25.71	-17.79	43.5	39.12	17.46	1.51	32.44			P	H
		238.98	34.68	-11.32	46	47.96	17.08	1.95	32.38			P	H
		785.8	30.07	-15.93	46	30.32	28.32	3.5	32.22			P	H
		905.5	32.46	-13.54	46	30.84	29.27	3.8	31.61			P	H
		938.4	33.42	-12.58	46	30.45	30.29	3.82	31.31			P	H
		38.64	35.7	-4.3	40	47.65	19.85	0.68	32.49	100	0	P	V
		75.63	31.09	-8.91	40	49.72	12.61	1.22	32.48			P	V
		214.41	27.13	-16.37	43.5	42.53	15.13	1.8	32.39			P	V
		786.5	30.56	-15.44	46	30.81	28.32	3.5	32.22			P	V
		881.7	32	-14	46	30.65	29.21	3.73	31.75			P	V
		944.7	32.71	-13.29	46	29.4	30.57	3.82	31.25			P	V
Remark	1. No other spurious found. 2. All results are PASS against limit line.												



Note symbol

*	Fundamental Frequency which can be ignored. However, the level of any unwanted emissions shall not exceed the level of the fundamental frequency.
!	Test result is over limit line.
P/A	Peak or Average
H/V	Horizontal or Vertical



A calculation example for radiated spurious emission is shown as below:

WIFI	Note	Frequency	Level	Over	Limit	Read	Antenna	Cable	Preamp	Ant	Table	Peak	Pol.
Ant.				Limit	Line	Level	Factor	Loss	Factor	Pos	Pos	Avg.	
1+2		(MHz)	(dBμV/m)	(dB)	(dBμV/m)	(dBμV)	(dB/m)	(dB)	(dB)	(cm)	(deg)	(P/A)	(H/V)
802.11b		2390	55.45	-18.55	74	54.51	32.22	4.58	35.86	103	308	P	H
CH 01													
2412MHz		2390	43.54	-10.46	54	42.6	32.22	4.58	35.86	103	308	A	H

- Level(dBμV/m) =
Antenna Factor(dB/m) + Cable Loss(dB) + Read Level(dBμV) - Preamp Factor(dB)
- Over Limit(dB) = Level(dBμV/m) – Limit Line(dBμV/m)

For Peak Limit @ 2390MHz:

- Level(dBμV/m)
= Antenna Factor(dB/m) + Cable Loss(dB) + Read Level(dBμV) - Preamp Factor(dB)
= 32.22(dB/m) + 4.58(dB) + 54.51(dBμV) – 35.86 (dB)
= 55.45 (dBμV/m)
- Over Limit(dB)
= Level(dBμV/m) – Limit Line(dBμV/m)
= 55.45(dBμV/m) – 74(dBμV/m)
= -18.55(dB)

For Average Limit @ 2390MHz:

- Level(dBμV/m)
= Antenna Factor(dB/m) + Cable Loss(dB) + Read Level(dBμV) - Preamp Factor(dB)
= 32.22(dB/m) + 4.58(dB) + 42.6(dBμV) – 35.86 (dB)
= 43.54 (dBμV/m)
- Over Limit(dB)
= Level(dBμV/m) – Limit Line(dBμV/m)
= 43.54(dBμV/m) – 54(dBμV/m)
= -10.46(dB)

Both peak and average measured complies with the limit line, so test result is “PASS”.



Appendix D. Radiated Spurious Emission Plots

Test Engineer :	J.C. Liang, Jacky Hung and Ken Wu	Temperature :	20~23°C
		Relative Humidity :	58~63%

**2.4GHz 2400~2483.5MHz
BT (Band Edge @ 3m)**

BT	2.4GHz 2400~2483.5MHz Band Edge @ 3m	
ANT	BT CH00 2402MHz	
1	Horizontal	Fundamental
Peak	<p> Site : 03CH11-HY Condition : PEAK_BE_74 3m HORN 9120D-HF HORIZONTAL RBW:1000.000KHz VBW:3000.000KHz SWT:Auto Detector : Peak Project : 742622 </p>	<p> Site : 03CH11-HY Condition : PEAK_74 3m HORN 9120D-HF HORIZONTAL RBW:1000.000KHz VBW:3000.000KHz SWT:Auto Detector : Peak Project : 742622 </p>



BT	2.4GHz 2400~2483.5MHz Band Edge @ 3m	
ANT	BT CH00 2402MHz	
1	Vertical	Fundamental
Peak	<p>Site : 03CH11-HY Condition : PEAK_BE_74 3m HORN 91200-HF VERTICAL RBW:1000.000KHz VBW:3000.000KHz SWT:Auto Detector : Peak Project : 742622</p>	<p>Site : 03CH11-HY Condition : PEAK_74 3m HORN 91200-HF VERTICAL RBW:1000.000KHz VBW:3000.000KHz SWT:Auto Detector : Peak Project : 742622</p>



BT	2.4GHz 2400~2483.5MHz Band Edge @ 3m	
ANT	BT CH39 2441MHz	
1	Horizontal	Fundamental
Peak	<p>Site : 03CH11-HY Condition : PEAK_BE_74 3m HORN 91200-HF HORIZONTAL RBW:1000.000KHz VBW:3000.000KHz SWT:Auto Detector : Peak Project : 742622</p>	<p>Site : 03CH11-HY Condition : PEAK_74 3m HORN 91200-HF HORIZONTAL RBW:1000.000KHz VBW:3000.000KHz SWT:Auto Detector : Peak Project : 742622</p>
Peak	<p>Site : 03CH11-HY Condition : PEAK_BE_74 3m HORN 91200-HF HORIZONTAL RBW:1000.000KHz VBW:3000.000KHz SWT:Auto Detector : Peak Project : 742622</p>	Left blank

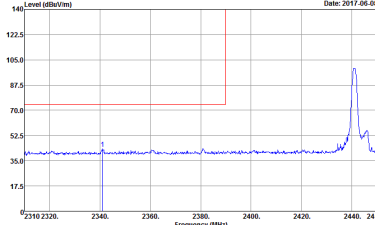
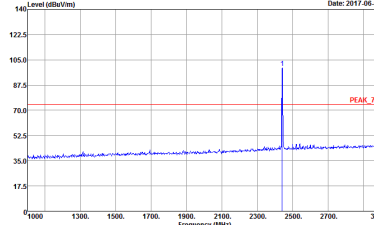
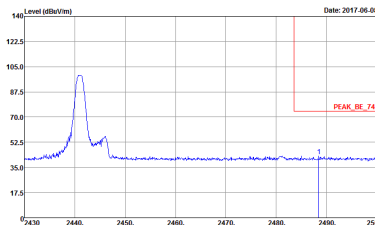

BT	2.4GHz 2400~2483.5MHz Band Edge @ 3m	
ANT	BT CH39 2441MHz	
1	Vertical	Fundamental
Peak	 <p>Site : 03CH11-HY Condition : PEAK_BE_74 3m HORN 91200-HF VERTICAL RBW:1000.000KHz VBW:3000.000KHz SWT:Auto Detector : Peak Project : 742622</p>	 <p>Site : 03CH11-HY Condition : PEAK_74 3m HORN 91200-HF VERTICAL RBW:1000.000KHz VBW:3000.000KHz SWT:Auto Detector : Peak Project : 742622</p>
Peak	 <p>Site : 03CH11-HY Condition : PEAK_BE_74 3m HORN 91200-HF VERTICAL RBW:1000.000KHz VBW:3000.000KHz SWT:Auto Detector : Peak Project : 742622</p>	Left blank

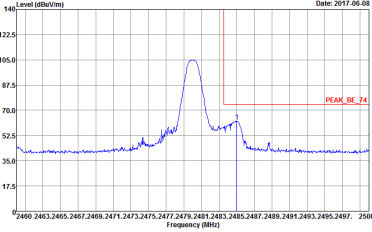
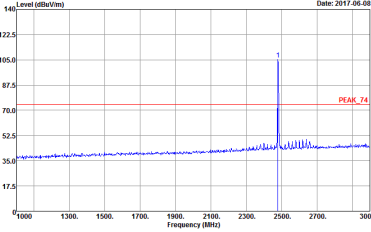

BT	2.4GHz 2400~2483.5MHz Band Edge @ 3m	
ANT	BT CH78 2480MHz	
1	Horizontal	Fundamental
Peak	 <p>Site : 03CH11-HY Condition : PEAK_BE_74 3m HORN 91200-HF HORIZONTAL RBW:1000.000KHz VBW:3000.000KHz SWT:Auto Detector : Peak Project : 742622</p>	 <p>Site : 03CH11-HY Condition : PEAK_74 3m HORN 91200-HF HORIZONTAL RBW:1000.000KHz VBW:3000.000KHz SWT:Auto Detector : Peak Project : 742622</p>

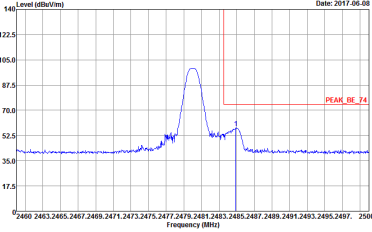
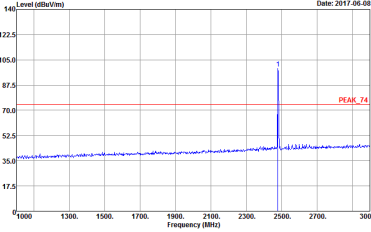

BT	2.4GHz 2400~2483.5MHz Band Edge @ 3m	
ANT	BT CH78 2480MHz	
1	Vertical	Fundamental
<p>Peak</p>	 <p>Site : 03CH11-HY Condition : PEAK_BE_74 3m HORN 91200-HF VERTICAL RBW:1000.000KHz VBW:3000.000KHz SWT:Auto Detector : Peak Project : 742622</p>	 <p>Site : 03CH11-HY Condition : PEAK_74 3m HORN 91200-HF VERTICAL RBW:1000.000KHz VBW:3000.000KHz SWT:Auto Detector : Peak Project : 742622</p>

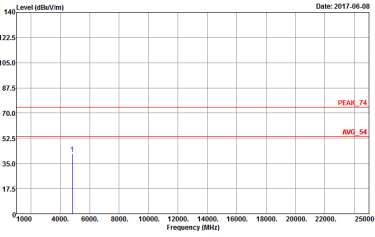
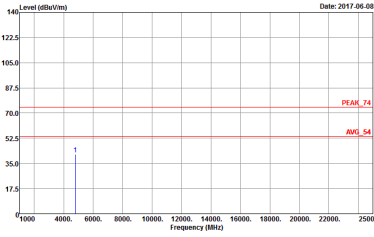

2.4GHz 2400~2483.5MHz
BT (Harmonic @ 3m)

BT	2.4GHz 2400~2483.5MHz Harmonic @ 3m	
ANT	BT CH00 2402MHz	
1	Horizontal	Vertical
<p>Peak Avg.</p>	 <p>Site : 03CH11-1FY Condition : PEAK_74 3m 9170 SHF HORM_150809 HORIZONTAL Detector : Peak Project : 742622</p>	 <p>Site : 03CH11-1FY Condition : PEAK_74 3m 9170 SHF HORM_150809 VERTICAL Detector : Peak Project : 742622</p>

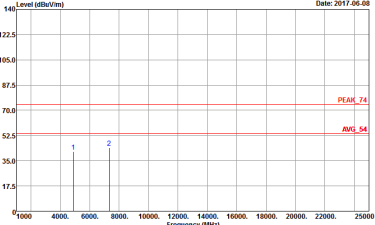
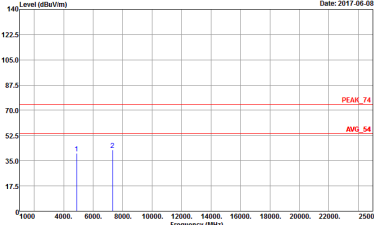

BT	2.4GHz 2400~2483.5MHz Harmonic @ 3m	
ANT	BT CH39 2441MHz	
1	Horizontal	Vertical
<p>Peak</p> <p>Avg.</p>	 <p>Site : 03CH11-HY Condition : PEAK_74 3m 9170 SHF HORM_150809 HORIZONTAL Detector : Peak Project : 742622</p>	 <p>Site : 03CH11-HY Condition : PEAK_74 3m 9170 SHF HORM_150809 VERTICAL Detector : Peak Project : 742622</p>

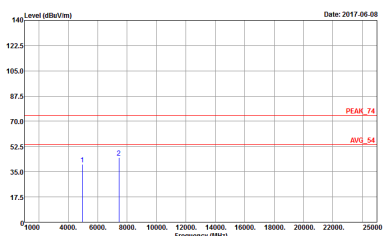
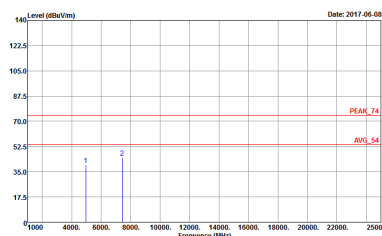

BT	2.4GHz 2400~2483.5MHz Harmonic @ 3m	
ANT	BT CH78 2480MHz	
1	Horizontal	Vertical
<p>Peak</p> <p>Avg.</p>	 <p>Site : 03CH11-HY Condition : PEAK_74 3m 9170 SHF HORM_150809 HORIZONTAL Detector : Peak Project : 742622</p>	 <p>Site : 03CH11-HY Condition : PEAK_74 3m 9170 SHF HORM_150809 VERTICAL Detector : Peak Project : 742622</p>

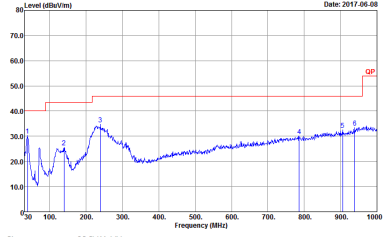
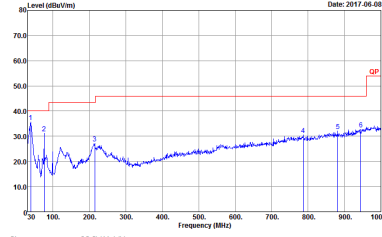

Emission below 1GHz
2.4GHz BT (LF)

BT	2.4GHz 2400~2483.5MHz	
ANT	BT LF	
1	Horizontal	Vertical
<p>QP / Peak</p>	 <p>Site : 03CH11-4FY Condition : QP 3m BT-LOG 6111D-LF_ETC HORIZONTAL Detector : Peak Project : 742622</p>	 <p>Site : 03CH11-4FY Condition : QP 3m BT-LOG 6111D-LF_ETC VERTICAL Detector : Peak Project : 742622</p>

Appendix E. Duty Cycle Plots

DH5 on time (One Pulse) Plot on Channel 39

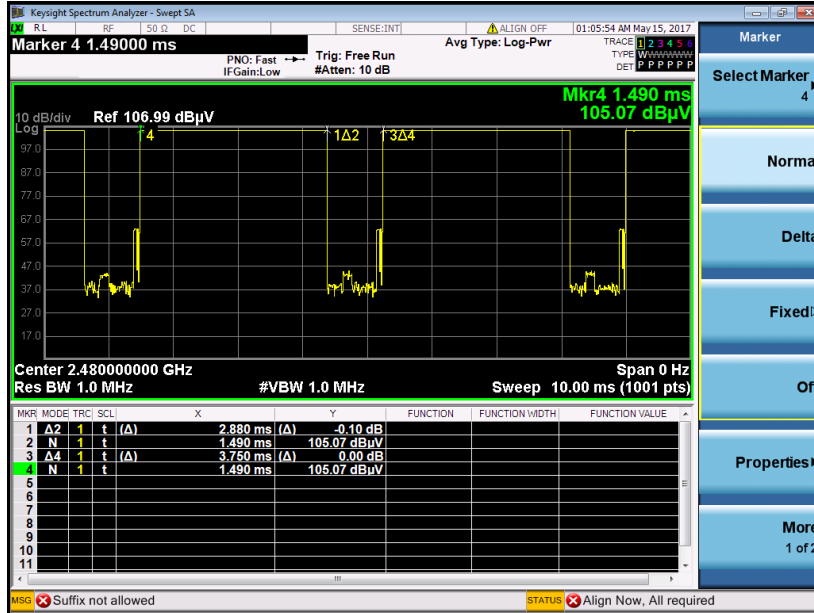

on time (Count Pulses) Plot on Channel 39

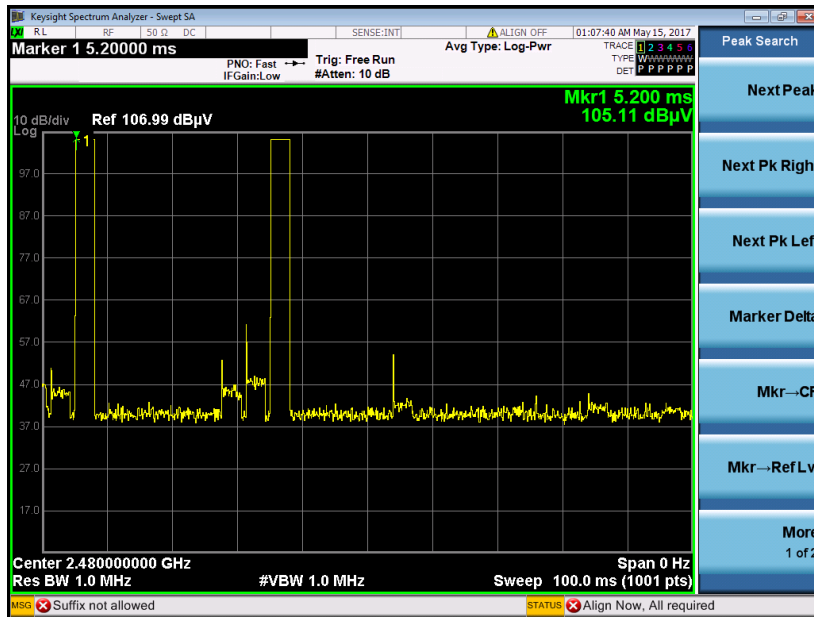

Note:

1. Worst case Duty cycle = on time/100 milliseconds = 2 * 2.88 / 100 = 5.76 %
2. Worst case Duty cycle correction factor = 20*log(Duty cycle) = -24.79 dB
3. DH5 has the highest duty cycle worst case and is reported.



Duty Cycle Correction Factor Consideration for AFH mode:

Bluetooth normal hopping rate is 1600Hz and reduced to 800Hz in AFH mode; due to the reduced number of hopping frequencies, with the same packet configuration the dwell time in each channel frequency within 100msec period is longer in AFH mode than normal mode.

In AFH mode, the minimum hopping frequencies are 20, to get the longest dwell time DH5 packet is observed; the period to have DH5 packet completing one hopping sequence is

$$2.88 \text{ ms} \times 20 \text{ channels} = 57.6 \text{ ms}$$

There cannot be 2 complete hopping sequences within 100ms period, considering the random hopping behavior, maximum 2 hops can be possibly observed within the period. $[100\text{ms} / 57.6\text{ms}] = 2$ hops

Thus, the maximum possible ON time:

$$2.88 \text{ ms} \times 2 = 5.76 \text{ ms}$$

Worst case Duty Cycle Correction factor, which is derived from the maximum possible ON time,

$$20 \times \log(5.76 \text{ ms}/100\text{ms}) = -24.79 \text{ dB}$$