



FCC 47 CFR PART 24 SUBPART E

TEST REPORT

For

Quanta Computer Inc.

GSM900/1800/1900 + GPRS handset

Model: EB-X300 (Panasonic); RA1 (Quanta)

Trade Name: Panasonic / Quanta

Prepared for

Quanta Computer Inc.

**No. 188, Wen Hwa 2nd Rd., Kuei Shan Hsiang,
Taoyuan Hsien, Taiwan, R.O.C.**

Prepared by

Compliance Certification Services Inc.

**No. 81-1, Lane 210, Bade Rd. 2, Luchu Hsiang,
Taoyuan Hsien, (338) Taiwan, R.O.C.**

TEL: 886-3-324-0332

FAX: 886-3-324-5235



Note: This report shall not be reproduced except in full, without the written approval of Compliance Certification Services Inc. This document may be altered or revised by Compliance Certification Services Inc. personnel only, and shall be noted in the revision section of the document.



TABLE OF CONTENTS

- 1. TEST RESULT CERTIFICATION..... 3**
- 2. EUT DESCRIPTION..... 4**
- 3. TEST METHODOLOGY 5**
 - 3.1 EUT CONFIGURATION 5
 - 3.2 EUT EXERCISE..... 5
 - 3.3 GENERAL TEST PROCEDURES 5
 - 3.4 FCC PART 15.205 RESTRICTED BANDS OF OPERATIONS 6
 - 3.5 DESCRIPTION OF TEST MODES 6
- 4. INSTRUMENT CALIBRATION..... 7**
- 5. FACILITIES AND ACCREDITATIONS 8**
 - 5.1 FACILITIES 8
 - 5.2 EQUIPMENT..... 8
 - 5.3 LABORATORY ACCREDITATIONS AND LISTING 8
 - 5.4 TABLE OF ACCREDITATIONS AND LISTINGS 9
- 6. SETUP OF EQUIPMENT UNDER TEST 10**
 - 6.1 SETUP CONFIGURATION OF EUT 10
 - 6.2 SUPPORT EQUIPMENT..... 10
- 7. FCC PART 24 REQUIREMENTS..... 11**
 - 7.1 PEAK POWER..... 11
 - 7.2 ERP & EIRP MEASUREMENT..... 12
 - 7.3 OCCUPIED BANDWIDTH MEASUREMENT 16
 - 7.4 OUT OF BAND EMISSION AT ANTENNA TERMINALS..... 21
 - 7.5 FIELD STRENGTH OF SPURIOUS RADIATION MEASUREMENT 41
 - 7.6 FREQUENCY STABILITY V.S. TEMPERATURE MEASUREMENT 50
 - 7.7 FREQUENCY STABILITY V.S. VOLTAGE MEASUREMENT..... 52
 - 7.8 POWERLINE CONDUCTED EMISSIONS..... 54



1. TEST RESULT CERTIFICATION

Applicant: Quanta Computer Inc.
 No. 188, Wen Hwa 2nd Rd., Kuei Shan Hsiang,
 Taoyuan Hsien, Taiwan, R.O.C.

Equipment Under Test: GSM900/1800/1900 + GPRS handset

Trade Name: Panasonic / Quanta

Model: EB-X300 (Panasonic); RA1 (Quanta)

Date of Test: March 29 ~ April 13, 2004

APPLICABLE STANDARDS	
STANDARD	TEST RESULT
FCC PART 24 SUBPART E	No non-compliance noted

We hereby certify that:

The above equipment was tested by Compliance Certification Services Inc. The test data, data evaluation, test procedures, and equipment configurations shown in this report were made in accordance with the procedures given in TIA/EIA-603-1-1998 and the energy emitted by the sample EUT tested as described in this report is in compliance with conducted and radiated emission limits of FCC Rule FCC PART 24 subpart E.

The test results of this report relate only to the tested sample identified in this report.

Approved by:

Reviewed by:

 Harris W. Lai
 Executive Vice President
 Compliance Certification Services Inc.

 Devin Chang
 Section Manager
 Compliance Certification Services Inc.



2. EUT DESCRIPTION

Product	GSM900/1800/1900 + GPRS handset
Trade Name	Panasonic / Quanta
Model Number	EB-X300 (Panasonic); RA1 (Quanta)
Model Discrepancy	All the above models are identical except the model designation. Model Number: EB-X300 is for Panasonic Model Number: RA1 for Quanta
Power Supply	Battery: Rated 3.7Vdc Adapter: Input: AC100-240V, 50/60Hz, 0.5A Output: 5.5Vdc, 700mA
Frequency Range	TX: 1850 MHz – 1910 MHz RX: 1930 MHz – 1989.8 MHz
Transmit Power	29.07 dBm (Avg.)
Cellular Phone Protocol	GSM (PCS), GPRS
Type of Emission	246KGXW--
Antenna Gain	-0.3 dBi
Antenna Type	Embedded Antenna

Note: This submittal(s) (test report) is intended for FCC ID: HFS-X300 filing to comply with Part 24 of the FCC 47 CFR Rules.



3. TEST METHODOLOGY

Both conducted and radiated testing were performed according to the procedures document on chapter 13 of ANSI C63.4 and FCC CFR 47, 2.1046, 2.1047, 2.1049, 2.1051, 2.1053, 2.1055 and 2.1057.

3.1 EUT CONFIGURATION

The EUT configuration for testing is installed on RF field strength measurement to meet the Commissions requirement and operating in a manner that intends to maximize its emission characteristics in a continuous normal application.

3.2 EUT EXERCISE

The EUT (GSM900/1800/1900 + GPRS handset) was operated in the engineering mode to fix the TX frequency that was for the purpose of the measurements.

3.3 GENERAL TEST PROCEDURES

Conducted Emissions

The EUT is placed on the turntable, which is 0.8 m above ground plane. According to the requirements in Section 13.1.4.1 of ANSI C63.4. Conducted emissions from the EUT measured in the frequency range between 0.15 MHz and 30MHz using CISPR Quasi-peak and average detector modes.

Radiated Emissions

The EUT is placed on a turn table, which is 0.8 m above ground plane. The turntable shall rotate 360 degrees to determine the position of maximum emission level. EUT is set 3m away from the receiving antenna, which varied from 1m to 4m to find out the highest emission. And also, each emission was to be maximized by changing the polarization of receiving antenna both horizontal and vertical. In order to find out the max. emission, the relative positions of this hand-held transmitter (EUT) was rotated through three orthogonal axes according to the requirements in Section 13.1.4.1 of ANSI C63.4.

3.4 FCC PART 15.205 RESTRICTED BANDS OF OPERATIONS

(a) Except as shown in paragraph (d) of this section, only spurious emissions are permitted in any of the frequency bands listed below:

MHz	MHz	MHz	GHz
0.090 - 0.110	16.42 - 16.423	399.9 - 410	4.5 - 5.15
¹ 0.495 - 0.505	16.69475 - 16.69525	608 - 614	5.35 - 5.46
2.1735 - 2.1905	16.80425 - 16.80475	960 - 1240	7.25 - 7.75
4.125 - 4.128	25.5 - 25.67	1300 - 1427	8.025 - 8.5
4.17725 - 4.17775	37.5 - 38.25	1435 - 1626.5	9.0 - 9.2
4.20725 - 4.20775	73 - 74.6	1645.5 - 1646.5	9.3 - 9.5
6.215 - 6.218	74.8 - 75.2	1660 - 1710	10.6 - 12.7
6.26775 - 6.26825	108 - 121.94	1718.8 - 1722.2	13.25 - 13.4
6.31175 - 6.31225	123 - 138	2200 - 2300	14.47 - 14.5
8.291 - 8.294	149.9 - 150.05	2310 - 2390	15.35 - 16.2
8.362 - 8.366	156.52475 -	2483.5 - 2500	17.7 - 21.4
8.37625 - 8.38675	156.52525	2655 - 2900	22.01 - 23.12
8.41425 - 8.41475	156.7 - 156.9	3260 - 3267	23.6 - 24.0
12.29 - 12.293	162.0125 - 167.17	3332 - 3339	31.2 - 31.8
12.51975 - 12.52025	167.72 - 173.2	3345.8 - 3358	36.43 - 36.5
12.57675 - 12.57725	240 - 285	3600 - 4400	(²)
13.36 - 13.41	322 - 335.4		

¹ Until February 1, 1999, this restricted band shall be 0.490-0.510 MHz.

² Above 38.6

(b) Except as provided in paragraphs (d) and (e), the field strength of emissions appearing within these frequency bands shall not exceed the limits shown in Section 15.209. At frequencies equal to or less than 1000 MHz, compliance with the limits in Section 15.209 shall be demonstrated using measurement instrumentation employing a CISPR quasi-peak detector. Above 1000 MHz, compliance with the emission limits in Section 15.209 shall be demonstrated based on the average value of the measured emissions. The provisions in Section 15.35 apply to these measurements.

3.5 DESCRIPTION OF TEST MODES

The EUT has been tested under operating condition.

EUT staying in continuous transmitting mode is programmed. Channel Low, Mid and High for each type and band with rated data rate are chosen for full testing.

(The field strength of spurious radiation emission was measured in the following position: EUT stand-up position (Y mode) and lied down position (X, Z mode))

The final measurement is carried with the worst case emission (stand-up Y-axis position).

After the preliminary test, found the adapter is worse case and recorded as the final test result.

After the preliminary test, found opening chase mode is worse case and recorded as the final test result.



4. INSTRUMENT CALIBRATION

The measuring equipment, which was utilized in performing the tests documented herein, has been calibrated in accordance with the manufacturer's recommendations for utilizing calibration equipment, which is traceable to recognized national standards.



5. FACILITIES AND ACCREDITATIONS

5.1 FACILITIES

All measurement facilities used to collect the measurement data are located at

No. 81-1, Lane 210, Bade Rd. 2, Luchu Hsiang, Taoyuan Hsien, Taiwan, R.O.C.

No. 199, Chunghsen Road, Hsintien City, Taipei Hsien, Taiwan, R.O.C.

The sites are constructed in conformance with the requirements of ANSI C63.7, ANSI C63.4 and CISPR Publication 22.

5.2 EQUIPMENT

Radiated emissions are measured with one or more of the following types of linearly polarized antennas: tuned dipole, biconical, log periodic, bi-log, and/or ridged waveguide, horn. Spectrum analyzers with pre-selectors and quasi-peak detectors are used to perform radiated measurements.

Conducted emissions are measured with Line Impedance Stabilization Networks and EMI Test Receivers.







Calibrated wideband preamplifiers, coaxial cables, and coaxial attenuators are also used for making measurements.

All receiving equipment conforms to CISPR Publication 16-1, "Radio Interference Measuring Apparatus and Measurement Methods."

5.3 LABORATORY ACCREDITATIONS AND LISTING

The test facilities used to perform radiated and conducted emissions tests are accredited by National Voluntary Laboratory Accreditation Program for the specific scope of accreditation under Lab Code: 200600-0 to perform Electromagnetic Interference tests according to FCC PART 15 AND CISPR 22 requirements. No part of this report may be used to claim or imply product endorsement by NVLAP or any agency of the US Government. In addition, the test facilities are listed with Federal Communications Commission (Registration no: 93105 and 90471).

5.4 TABLE OF ACCREDITATIONS AND LISTINGS

Country	Agency	Scope of Accreditation	Logo
USA	NVLAP*	EN 55011, EN 55014-1, AS/NZS 1044, CNS 13783-1, EN 55022, CNS 13438, EN 61000-3-2, EN 61000-3-3, ANSI C63.4, FCC OST/MP-5, AS/NZS CISPR 22, IEC 61000-4-2, IEC 61000-4-3, IEC 61000-4-4, IEC 61000-4-5, IEC 61000-4-6, IEC 61000-4-8, IEC 61000-4-11	 200600-0
USA	FCC	3/10 meter Open Area Test Sites to perform FCC Part 15/18 measurements	 93105, 90471
Japan	VCCI	4 3/10 meter Open Area Test Sites to perform conducted/radiated measurements	 R-393/1066/725/879 C-402/747/912
Norway	NEMKO	EN 50081-1/2, EN 50082-1/2, IEC 61000-6-1/2, EN 50091-2, EN 50130-4, EN 55011, EN 55013, EN 55014-1/2, EN 55015, EN 55022, EN 55024, EN 61000-3-2/3, EN 61326-1, IEC 61000-4-2/3/4/5/6/8/11, EN 60601-1-2, EN 300 328-2, EN 300 422-2, EN 301 419-1, EN 301 489-01/03/07/08/09/17, EN 301 419-2/3, EN 300 454-2, EN 301 357-2	 ELA 124a ELA 124b ELA 124c
Taiwan	CNLA	EN 300 328-1/2, EN 300 220-1/2/3, EN 300 440-1/2, EN 61000-3-2, EN 61000-3-3, 47 CFR FCC Part 15 Subpart C/D/E, EN 55013, CNS 13439, EN 55014-1, CNS 13783-1, EN 55022, CNS 13438, CISPR 22, AS/NZS 3548, EN 61000-4-2/3/4/5/6/8/11, ENV 50204, IEEE Std 1528, FCC OET Bulletin, 65+Supplement C, EN50360, EN50361, EN50371, RSS102	 0363 ILAC MRA
Taiwan	BSMI	CNS 13438, CNS 13783-1, CNS 13439, CNS 14115	 SL2-IS-E-0014 SL2-IN-E-0014 SL2-A1-E-0014 SL2-R1-E-0014 SL2-R2-E-0014 SL2-L1-E-0014
Canada	Industry Canada	RSS212, Issue 1	 IC 3991-3 IC 3991-4

* No part of this report may be used to claim or imply product endorsement by NVLAP or any agency of the US Government.



6. SETUP OF EQUIPMENT UNDER TEST

6.1 SETUP CONFIGURATION OF EUT

See test photographs attached in Appendix 1 for the actual connections between EUT and support equipment.

6.2 SUPPORT EQUIPMENT

No.	Device Type	Brand	Model	FCC ID	Series No.	Data Cable	Power Cord
	N/A	N/A	N/A	N/A	N/A	N/A	N/A

Notes:

- 1. All the equipment/cables were placed in the worst-case configuration to maximize the emission during the test.*
- 2. Grounding was established in accordance with the manufacturer's requirements and conditions for the intended use.*



7. FCC PART 24 REQUIREMENTS

7.1 PEAK POWER

LIMIT

According to FCC §2.1046.

MEASUREMENT EQUIPMENT USED

Name of Equipment	Manufacturer	Model	Serial Number	Calibration Due
Power Meter	Agilent	436A	2709A29207	03/15/2005
Power Sensor	Agilent	8481A	2702A61366	03/15/2005
Spectrum Analyzer	Agilent	E4446A	US42510252	04/28/2004

Remark: Each piece of equipment is scheduled for calibration once a year.

Test Configuration

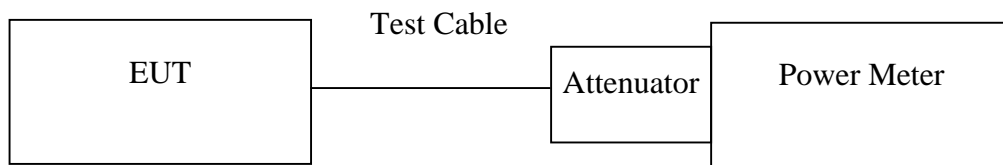

Note: Measurement setup for testing on Antenna connector

TEST PROCEDURE

The transmitter output was connected to a calibrated attenuator, the other end of which was connected to a power meter. Transmitter output was read off the power meter in dBm. The power output at the transmitter antenna port was determined by adding the value of the attenuator to the power meter reading.

TEST RESULTS

No non-compliance noted.

Test Data

Test Mode	CH	Frequency (MHz)	Power Meter Reading (dBm)	Attenuator (dB)	Average Power (dBm)
GSM	512	1850.20	7.72	21.2	28.92
	661	1880.00	7.87		29.07
	810	1910.00	7.75		28.95
GPRS (Class 10)	512	1850.20	7.68		28.88
	661	1880.00	7.78		28.98
	810	1910.00	7.72		28.92

Note: The value of factor includes both the loss of cable and external attenuator

7.2 ERP & EIRP MEASUREMENT

LIMIT

According to FCC §2.1046

FCC 22.913(b): The Effective Radiated Power (ERP) of mobile transmitters must not exceed 7 Watts.

FCC 24.232(b): The equivalent Isotropic Radiated Power (EIRP) must not exceed 2 Watts.

MEASUREMENT EQUIPMENT USED

Name of Equipment	Manufacturer	Model	Serial Number	Calibration Due
Spectrum Analyzer	Agilent	E4446A	US42510252	04/27/2004
Spectrum Analyzer	R&S	FSP30	100112	06/28/2004
Pre-Amplifier	HP	8447D	2944A09173	03/03/2005
Horn antenna	EMCO	3115	00022250	02/26/2005
Pre-Amplifier	HP	8449B	3008B00965	10/02/2004
Turn Table	EMCO	2081-1.21	9709-1885	N.C.R
Antenna Tower	EMCO	2075-2	9707-2060	N.C.R
Controller	EMCO	2090	9709-1256	N.C.R
Site NSA	C&C	N/A	N/A	09/06/2004
S.G.	HP	83630B	3844A01022	01/14/2005
Substituted Horn	EMCO	3115	00022256	02/26/2005

TEST CONFIGURATION

Below 1 GHz

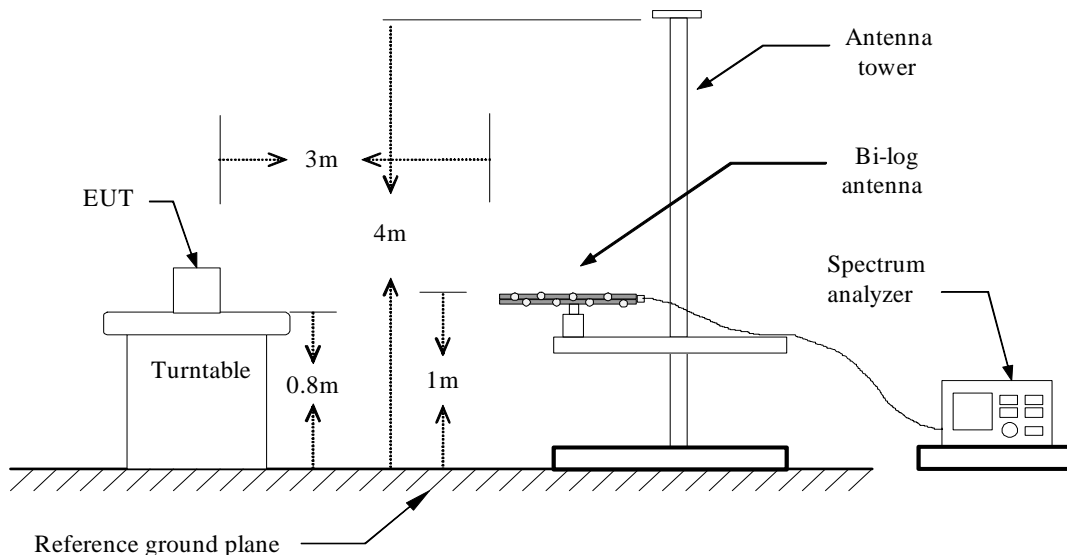

Above 1 GHz

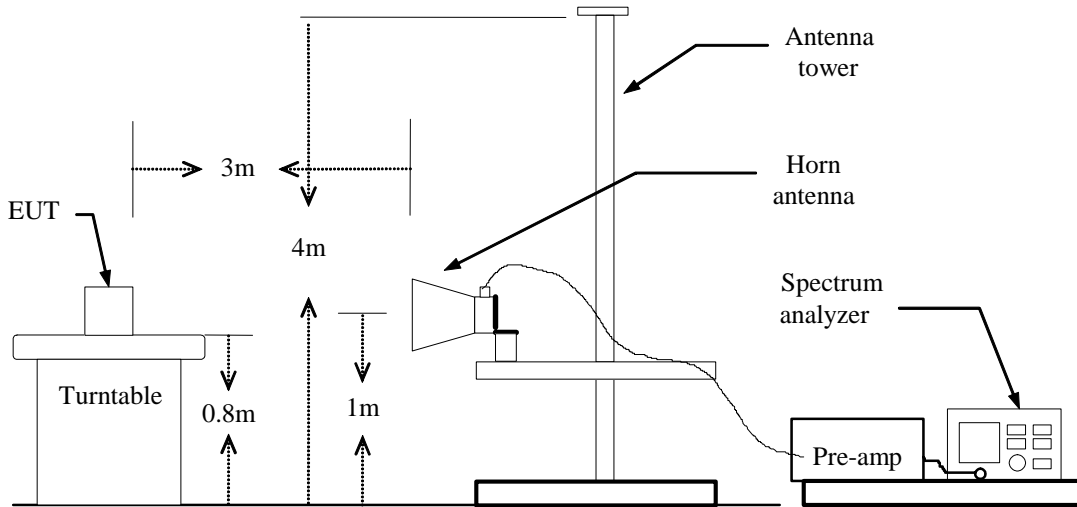

For Substituted Method Test Set-UP

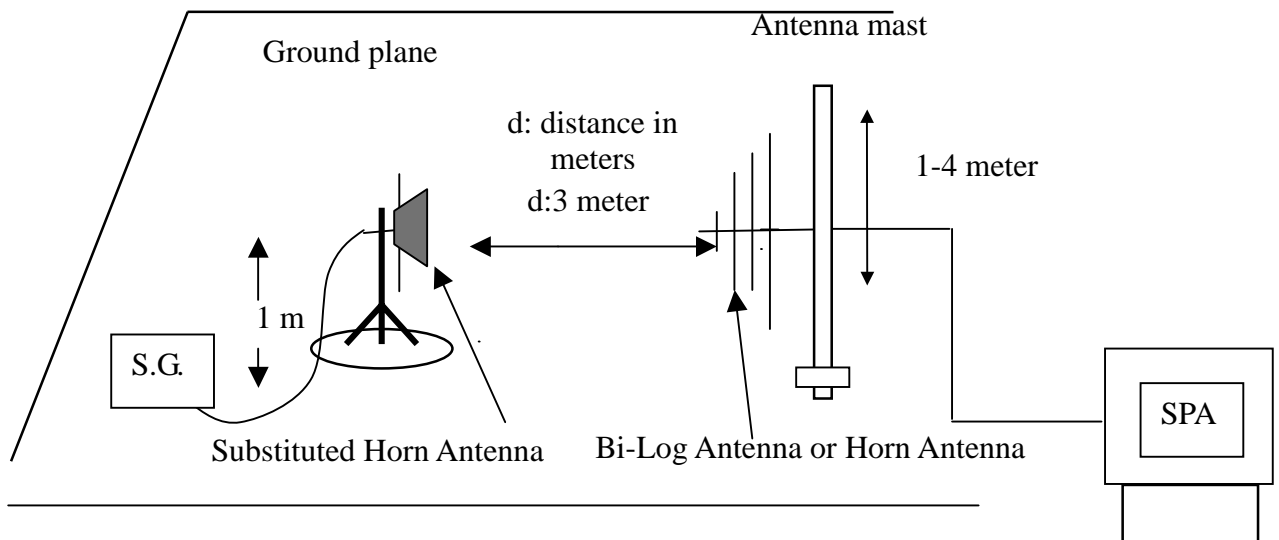

TEST PROCEDURE

The EUT was placed on an non-conductive turntable using a non-conductive support. The radiated emission at the fundamental frequency was measured at 3 m with a test antenna and EMI spectrum analyzer.

During the measurement of the EUT, the resolution bandwidth was set to 3MHz and the average bandwidth was set to 3MHz. The highest emission was recorded with the rotation of the turntable and the lowering of the test antenna. The reading was recorded and the field strength (E in dBuV/m) was calculated.

ERP in frequency band 824-849MHz, and EIRP in frequency band 1851.25 –1910MHz were measured using a substitution method. The EUT was replaced by half-wave dipole (824-849MHz) or horn antenna (1851.25-1910MHz) connected to a signal generator. The spectrum analyzer reading was recorded and ERP/EIRP was calculated as follows:

$$ERP = S.G. \text{ output (dBm)} + \text{Antenna Gain (dBd)} - \text{Cable (dB)}$$

$$EIRP = S.G. \text{ output (dBm)} + \text{Antenna Gain (dBi)} - \text{Cable (dB)}$$

**TEST RESULTS***No non-compliance noted.***GSM Test Data**

EUT Pol.	Channel	Frequency (MHz)	Reading level (dBuV)	Antenna Pol.	S.G. (dBm)	Cable loss (dB)	Ant.Gain (dBi)	Emission level (dBm)	Limit (dBm)	Margin (dB)
X	512	1850.17	122.09	V	18.70	4.49	8.45	22.66	33.00	-10.34
		1850.25	124.89	H	22.00	4.49	8.45	25.96	33.00	-7.04
	661	1880.14	119.93	V	16.71	4.53	8.48	20.66	33.00	-12.34
		1879.88	123.63	H	20.85	4.52	8.47	24.81	33.00	-8.19
	810	1909.68	119.65	V	16.55	4.55	8.50	20.49	33.00	-12.51
		1909.71	124.54	H	21.94	4.55	8.50	25.88	33.00	-7.12
Y	512	1850.08	123.03	V	19.64	4.49	8.45	23.60	33.00	-9.40
		1850.07	127.42	H	24.53	4.49	8.45	28.49	33.00	-4.51
	661	1880.00	123.77	V	20.55	4.53	8.48	24.50	33.00	-8.50
		1880.23	126.70	H	23.98	4.53	8.48	27.93	33.00	-5.07
	810	1909.81	125.00	V	21.90	4.55	8.50	25.84	33.00	-7.16
		1909.70	125.37	H	22.77	4.55	8.50	26.71	33.00	-6.29
Z	512	1850.17	126.09	V	22.70	4.49	8.45	26.66	33.00	-6.34
		1850.12	119.45	H	16.56	4.49	8.45	20.52	33.00	-12.48
	661	1880.20	125.67	V	22.45	4.53	8.48	26.40	33.00	-6.60
		1880.05	121.71	H	18.99	4.53	8.48	22.94	33.00	-10.06
	810	1909.82	124.91	V	21.81	4.55	8.50	25.75	33.00	-7.25
		1909.74	121.93	H	19.33	4.55	8.50	23.27	33.00	-9.73



GPRS Test Data

EUT Pol.	Channel	Frequency (MHz)	Reading level (dBuV)	Antenna Pol.	S.G. (dBm)	Cable loss (dB)	Ant.Gain (dBi)	Emission level (dBm)	Limit (dBm)	Margin (dB)
X	512	1850.17	123.69	V	20.30	4.49	8.45	24.26	33.00	-8.74
		1850.19	124.93	H	22.04	4.49	8.45	26.00	33.00	-7.00
	661	1880.04	120.02	V	16.80	4.53	8.48	20.75	33.00	-12.25
		1879.90	123.61	H	20.83	4.52	8.47	24.79	33.00	-8.21
	810	1909.76	119.70	V	16.60	4.55	8.50	20.54	33.00	-12.46
		1909.79	124.56	H	21.96	4.55	8.50	25.90	33.00	-7.10
Y	512	1850.35	120.08	V	16.69	4.49	8.45	20.65	33.00	-12.35
		1850.24	127.42	H	24.53	4.49	8.45	28.49	33.00	-4.51
	661	1880.05	120.07	V	16.85	4.53	8.48	20.80	33.00	-12.20
		1879.96	126.20	H	23.42	4.52	8.47	27.38	33.00	-5.62
	810	1909.76	120.89	V	17.79	4.55	8.50	21.73	33.00	-11.27
		1909.92	125.04	H	22.44	4.55	8.50	26.38	33.00	-6.62
Z	512	1850.28	126.41	V	23.02	4.49	8.45	26.98	33.00	-6.02
		1850.24	122.31	H	19.42	4.49	8.45	23.38	33.00	-9.62
	661	1880.03	125.53	V	22.31	4.53	8.48	26.26	33.00	-6.74
		1880.07	123.40	H	20.68	4.53	8.48	24.63	33.00	-8.37
	810	1909.71	125.15	V	22.05	4.55	8.50	25.99	33.00	-7.01
		1909.72	123.23	H	20.63	4.55	8.50	24.57	33.00	-8.43



7.3 OCCUPIED BANDWIDTH MEASUREMENT

LIMIT

According to §FCC 2.1049.

MEASUREMENT EQUIPMENT USED

Name of Equipment	Manufacturer	Model	Serial Number	Calibration Due
Spectrum Analyzer	Agilent	E4446A	US42510252	04/28/2004
Spectrum Analyzer	R&S	FSP30	100112	06/28/2004

Remark: Each piece of equipment is scheduled for calibration once a year.

Test Configuration

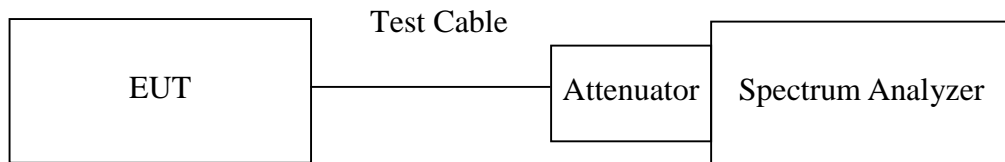

Note: Measurement setup for testing on Antenna connector

TEST PROCEDURE

The EUT's output RF connector was connected with a short cable to the spectrum analyzer, RBW was set to about 1% of emission BW, VBW is set to 3 times the RBW, -26dBc display line was placed on the screen (or 99% bandwidth), the occupied bandwidth is the delta frequency between the two points where the display line intersects the signal trace.

TEST RESULTS

No non-compliance noted

Test Data

Test Mode	CH	Frequency (MHz)	Bandwidth (kHz)
GSM	512	1850.200	243.996
	661	1880.000	246.280
	810	1909.800	242.283
GPRS (Class 8)	512	1850.200	240.895
	661	1880.000	241.456
	810	1909.800	241.308



Test Plot

GSM (Ch Low)

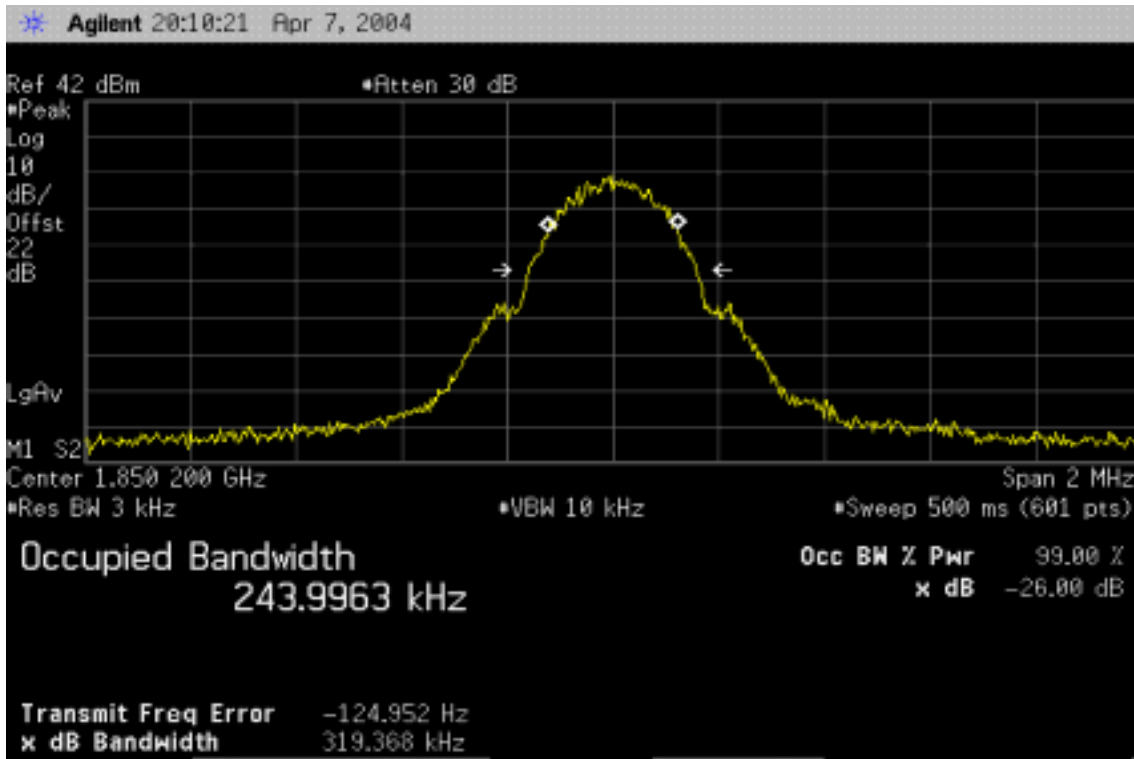

GSM (Ch Mid)

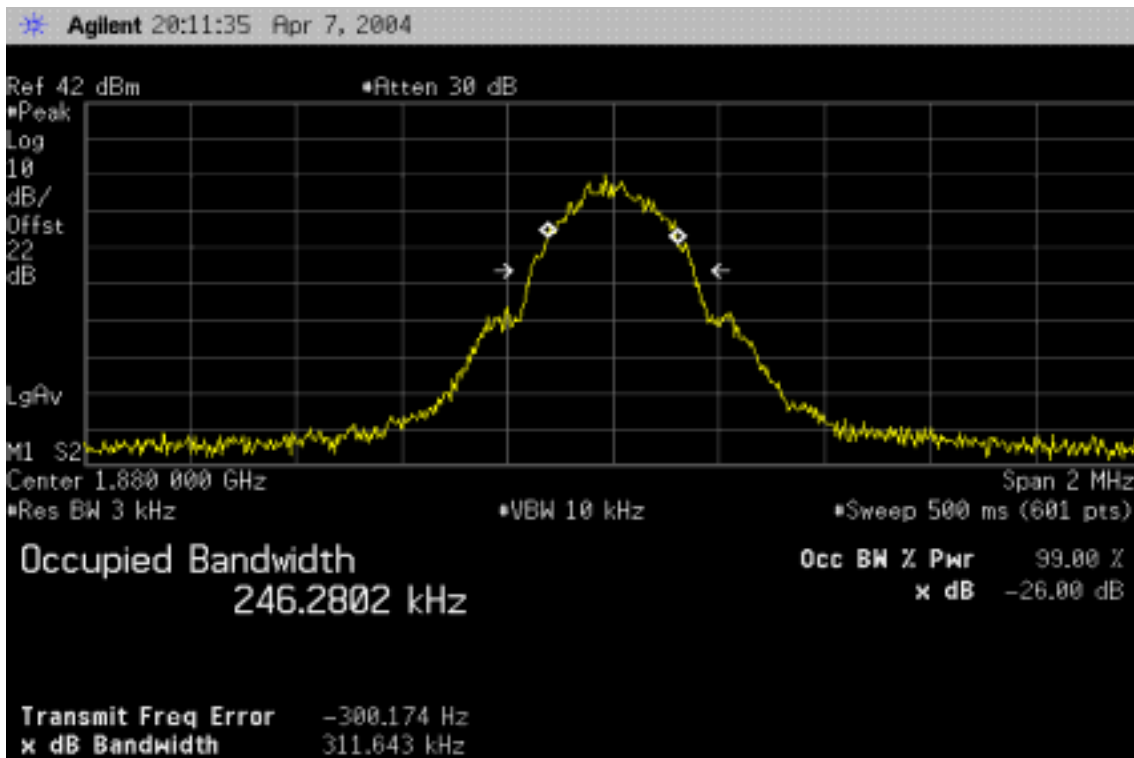



GSM (Ch High)

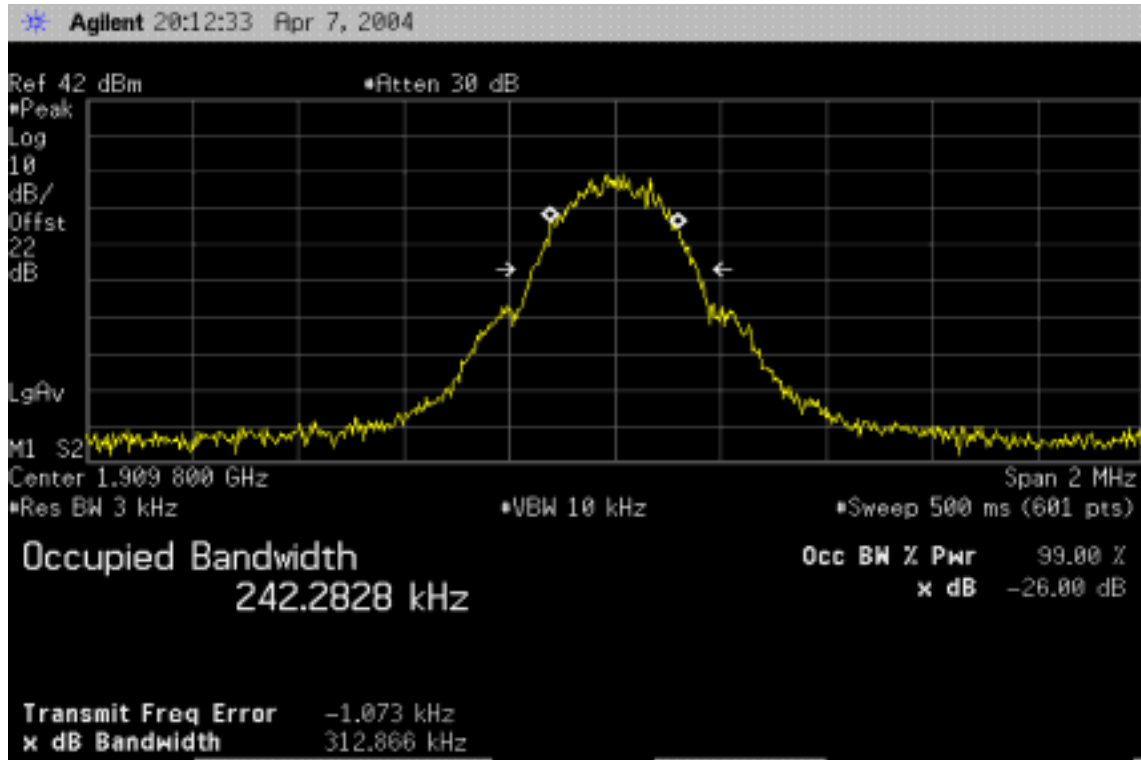



GPRS (Ch Low)

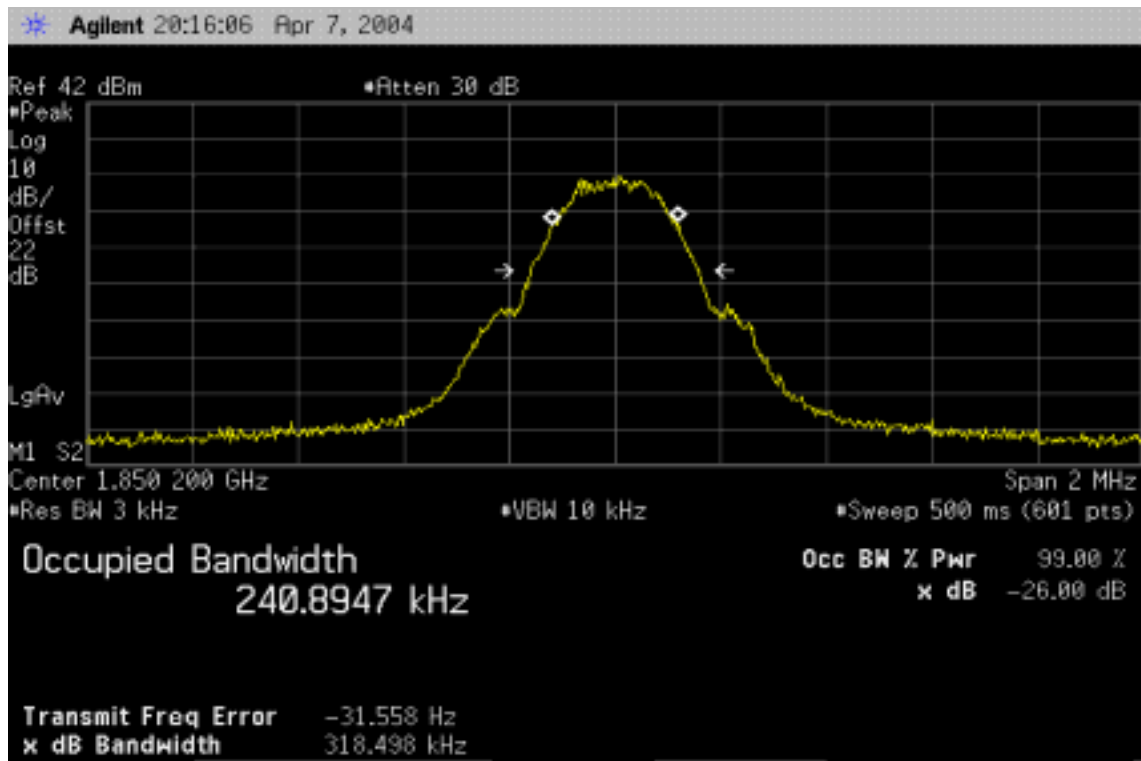

GPRS (Ch Mid)

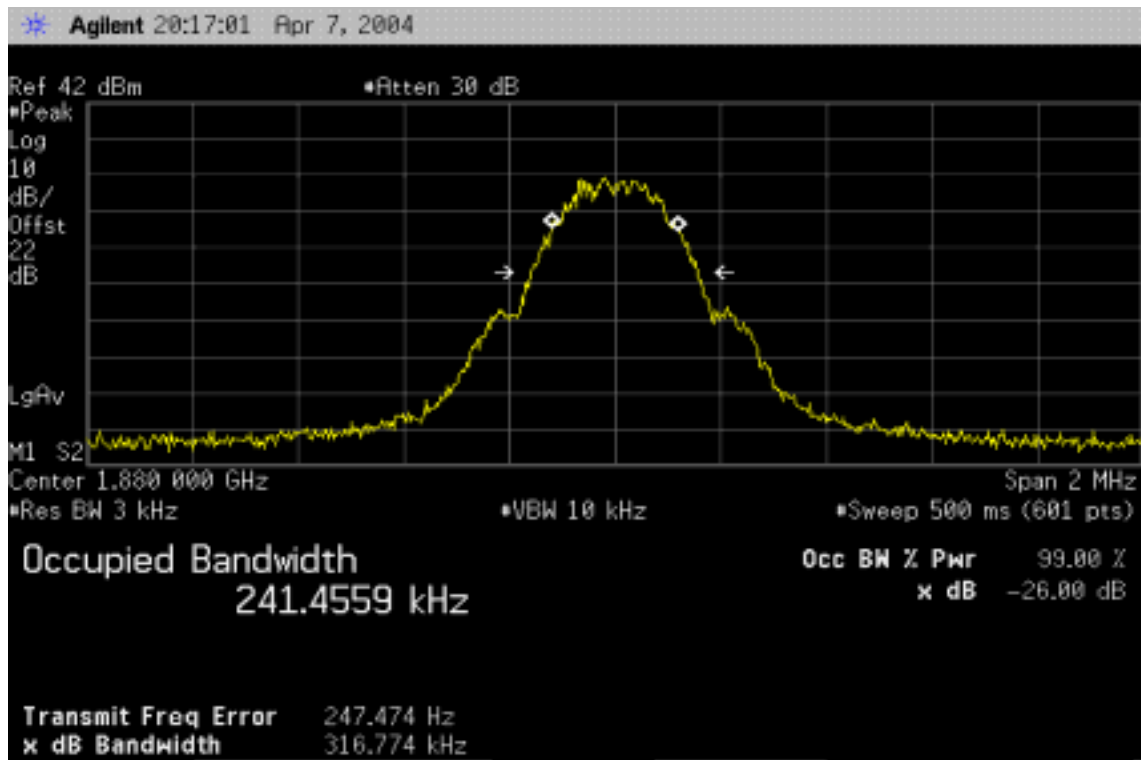



GPRS (CH High)

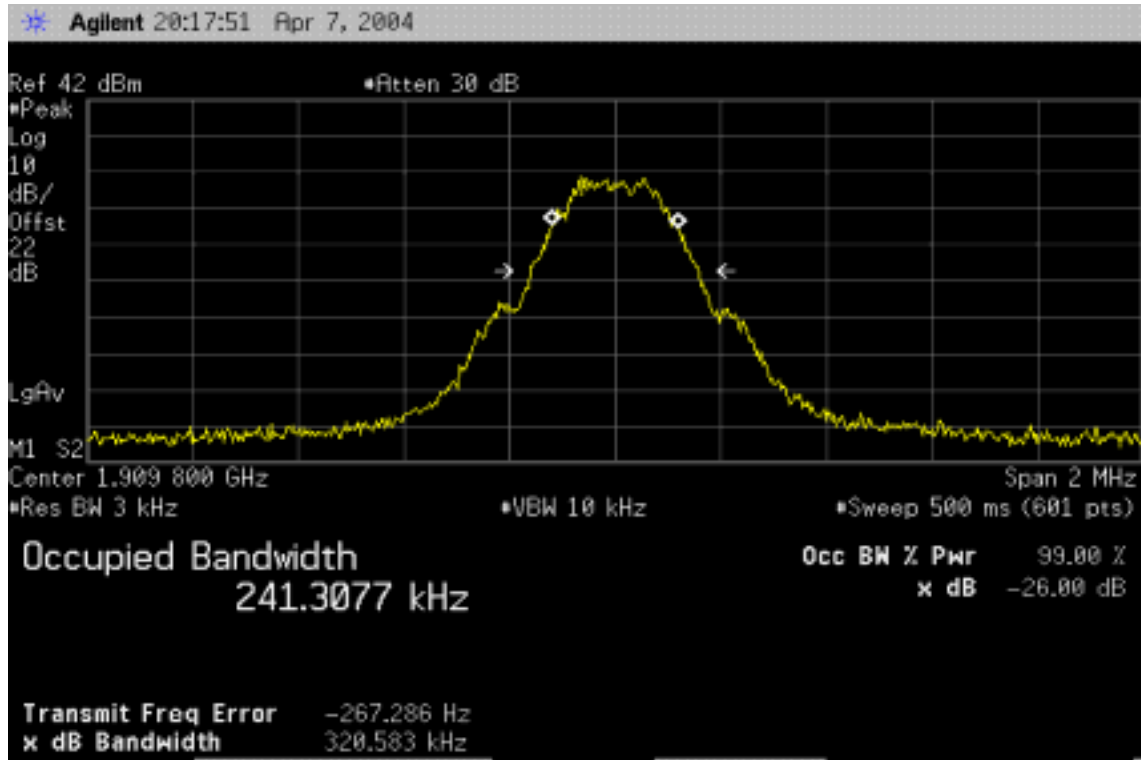



7.4 OUT OF BAND EMISSION AT ANTENNA TERMINALS

LIMIT

According to FCC §2.1051, FCC §2.2917(f), FCC §24.238(a),

Out of Band Emissions: The mean power of emission must be attenuated below the mean power of the non-modulated carrier (P) on any frequency twice or more than twice the fundamental frequency by at least $43 + 10 \log P$ dB.

Mobile Emissions in Base Frequency Range: The mean power of any emissions appearing in the base station frequency range from cellular mobile transmitters operated must be attenuated to a level not exceed -80 dBm at the transmit antenna connector.

Band Edge Requirements: In the 1MHz bands immediately outside and adjacent to the frequency block, a resolution bandwidth of at least 1% of the emission bandwidth of the fundamental emission of the transmitter may be employed to measure the Out of band Emission

MEASUREMENT EQUIPMENT USED

Name of Equipment	Manufacturer	Model	Serial Number	Calibration Due
Spectrum Analyzer	Agilent	E4446A	US42510252	04/27/2004

TEST CONFIGURATION

Out of band emission at antenna terminals:

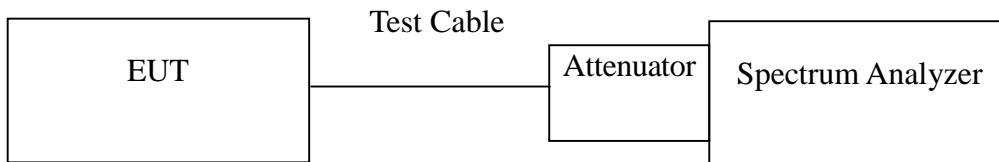

TEST PROCEDURE

The RF output of the transceiver was connected to a spectrum analyzer through appropriate attenuation. The resolution bandwidth of the spectrum analyzer was set at 1MHz, sufficient scans were taken to show the out of band Emissions if any up to 10th harmonic.

For the out of band: Set the RBW, VBW = 1MHz, Start=30MHz, Stop= 10 th harmonic. Limit = -13 dBm

Band Edge Requirements (1850MHz and 1910MHz): In the 1 MHz bands immediately outside and adjacent to the frequency block, a resolution bandwidth of at least 1 percent of the emission bandwidth of the fundamental emission of the transmitter may be employed to measure the out of band Emissions. Limit, -13 dBm.



TEST RESULTS

No non-compliance noted.

Test Data

Table 7-1: Out of Band emissions

Mode	CH	Location	Description
GSM	512	Figure 7-1	Conducted spurious emissions, 30MHz - 2.5GHz
		Figure 7-2	Conducted spurious emissions, 2.5GHz - 20GHz
	661	Figure 7-3	Conducted spurious emissions, 30MHz - 2.5GHz
		Figure 7-4	Conducted spurious emissions, 2.5GHz - 20GHz
	810	Figure 7-5	Conducted spurious emissions, 30MHz - 2.5GHz
		Figure 7-6	Conducted spurious emissions, 2.5GHz - 20GHz
GPRS (Class 8)	512	Figure 7-7	Conducted spurious emissions, 30MHz - 2.5GHz
		Figure 7-8	Conducted spurious emissions, 2.5GHz - 20GHz
	661	Figure 7-9	Conducted spurious emissions, 30MHz - 2.5GHz
		Figure 7-10	Conducted spurious emissions, 2.5GHz - 20GHz
	810	Figure 7-11	Conducted spurious emissions, 30MHz - 2.5GHz
		Figure 7-12	Conducted spurious emissions, 2.5GHz - 20GHz

Table 7-2: Block Edge emissions

Mode	CH	Location	Description
GSM	512	Figure 7-13	Block Edge Emission
	585	Figure 7-14	
	587	Figure 7-15	
	610	Figure 7-16	
	612	Figure 7-17	
	685	Figure 7-18	
	687	Figure 7-19	
	710	Figure 7-20	
	712	Figure 7-21	
	735	Figure 7-22	
	737	Figure 7-23	
	810	Figure 7-24	
GPRS (Class 8)	512	Figure 7-25	
	585	Figure 7-26	
	587	Figure 7-27	
	610	Figure 7-28	
	612	Figure 7-29	
	685	Figure 7-30	
	687	Figure 7-31	
	710	Figure 7-32	
	712	Figure 7-33	
	735	Figure 7-34	
	737	Figure 7-35	
	810	Figure 7-36	

Test Plot

GSM

Figure 7-1: Out of Band emission at antenna terminals– GSM CH Low

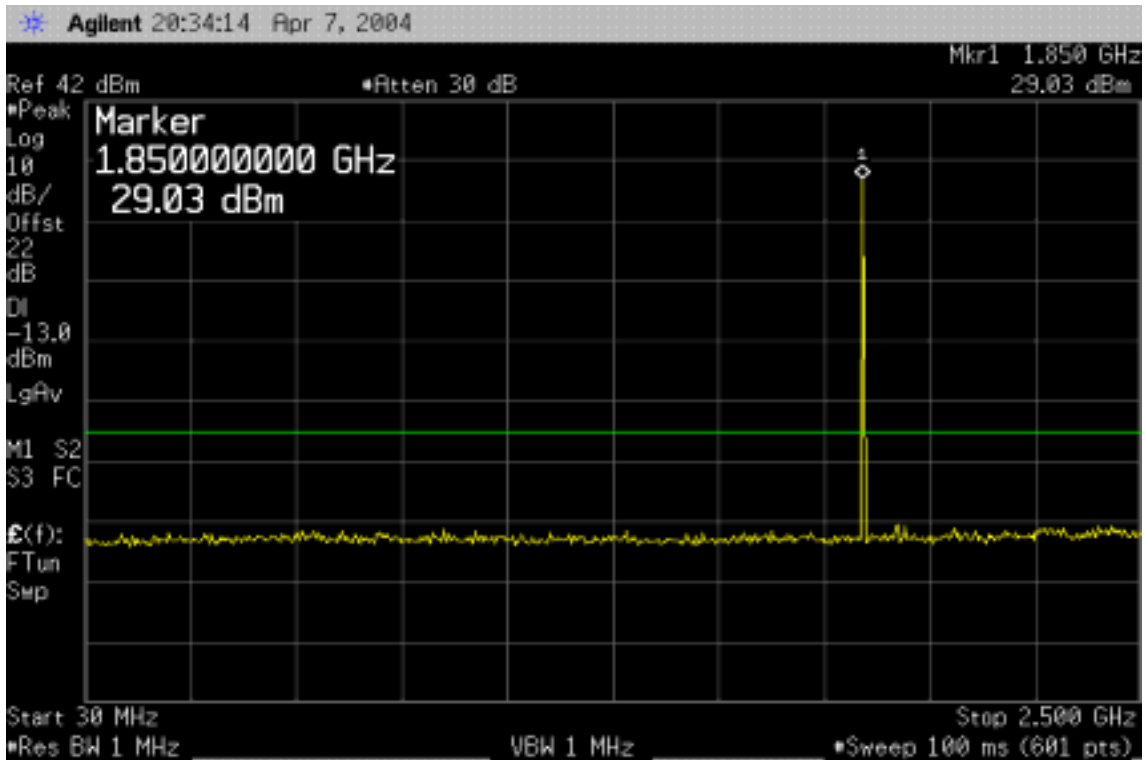

Figure 7-2: Out of Band emission at antenna terminals–GSM CH Low

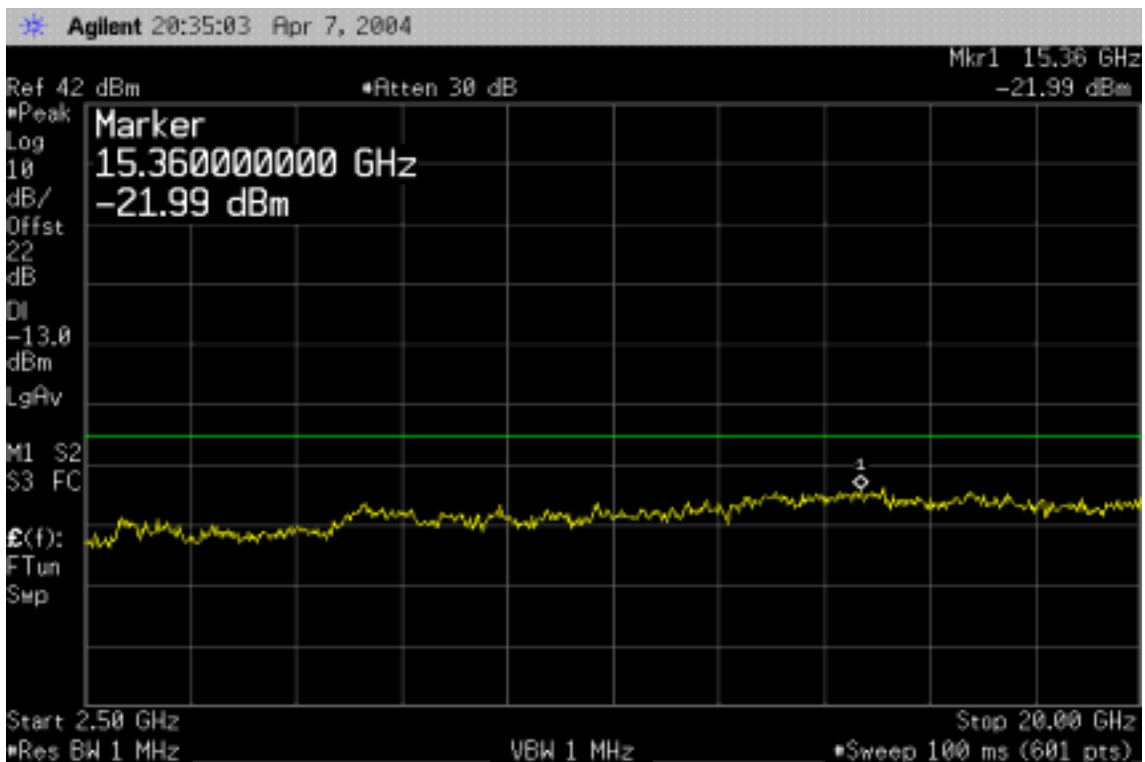

Figure 7-3: Out of Band emission at antenna terminals –GSM CH Mid

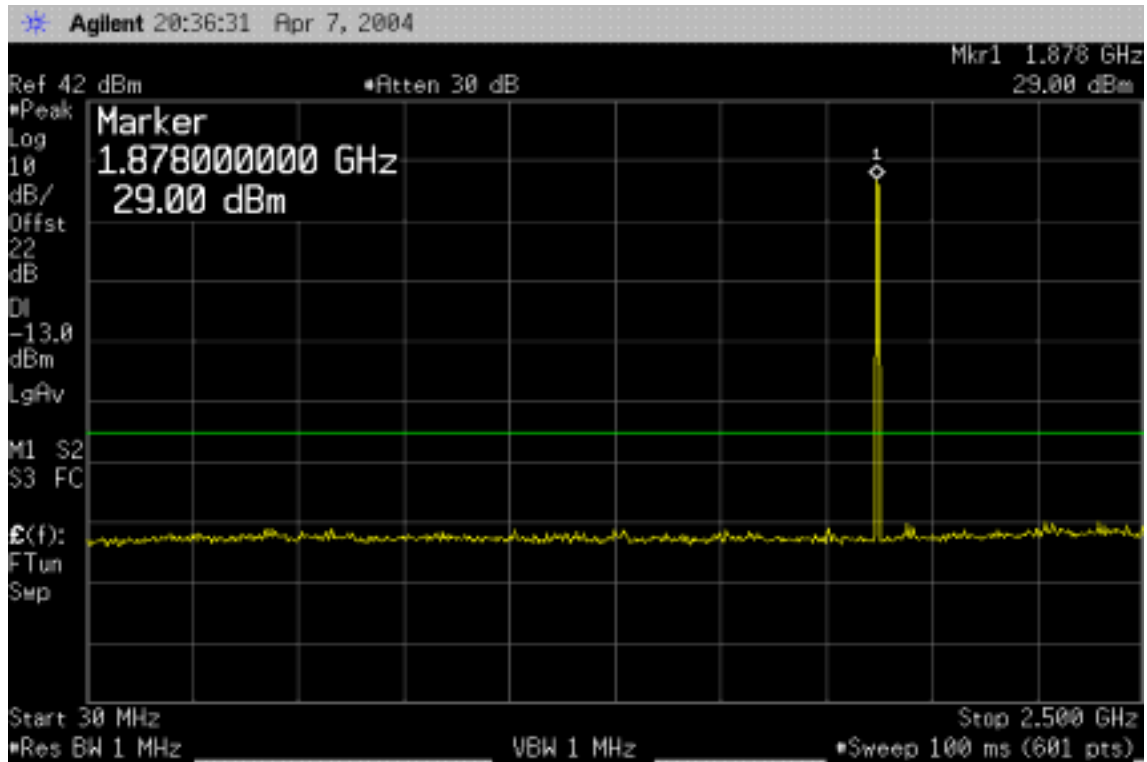

Figure 7-4: Out of Band emission at antenna terminals –GSM CH Mid

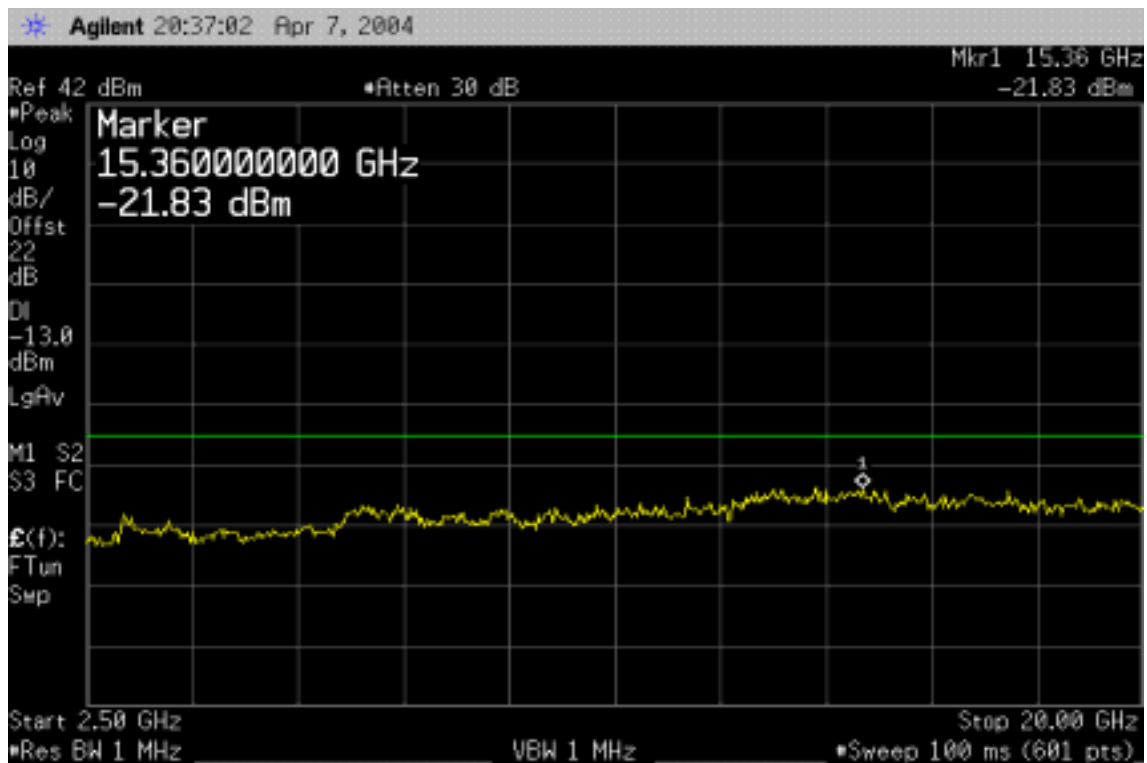

Figure 7-5: Out of Band emission at antenna terminals–GSM CH High

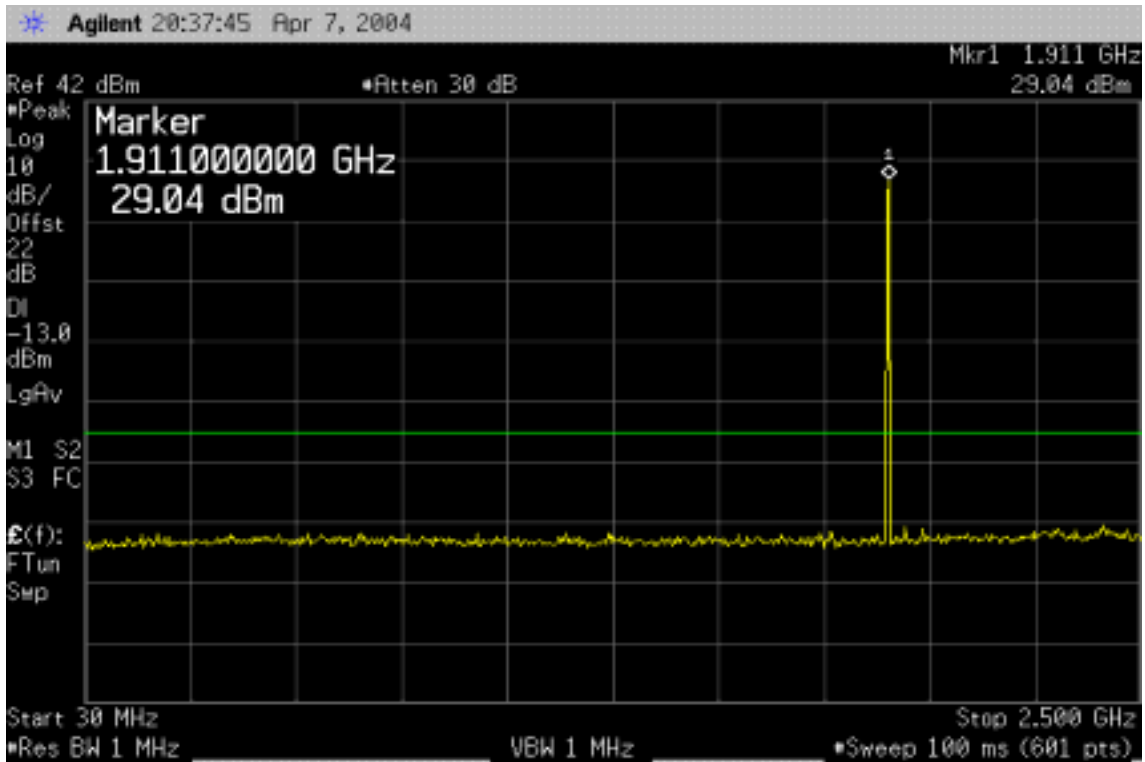
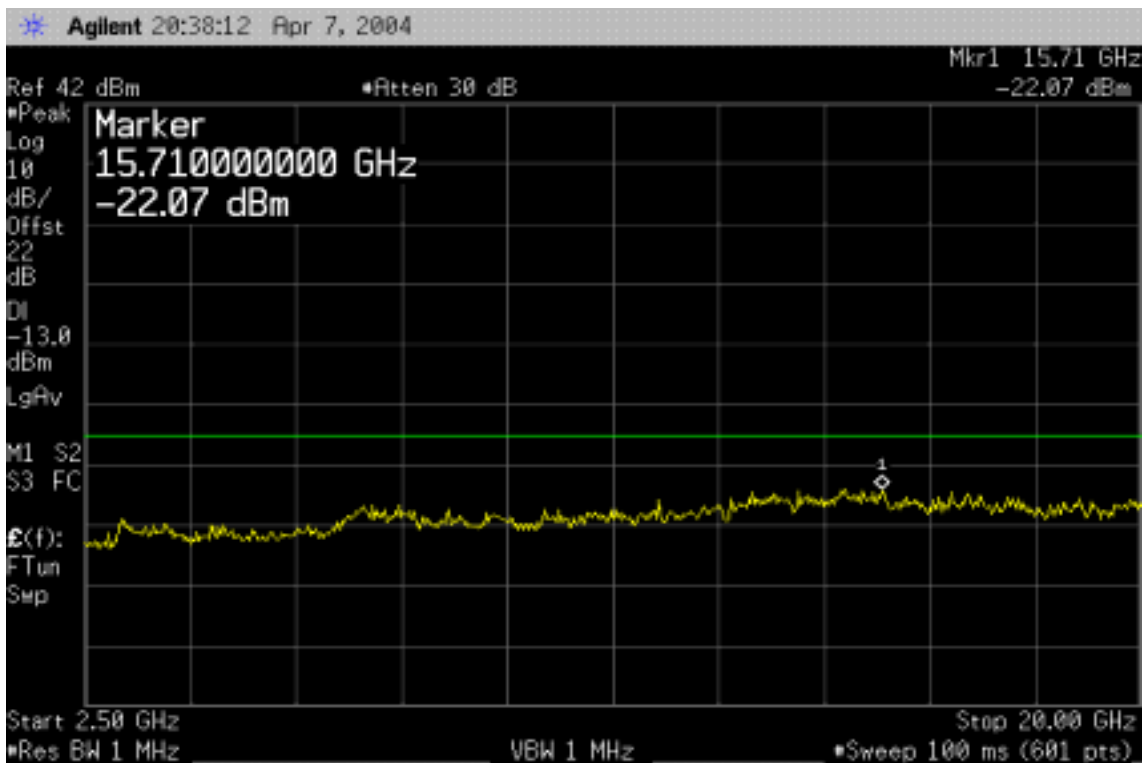

Figure 7-6: Out of Band emission at antenna terminals–GSM CH High



GPRS

Figure 7-7: Out of Band emission at antenna terminals–GPRS CH Low

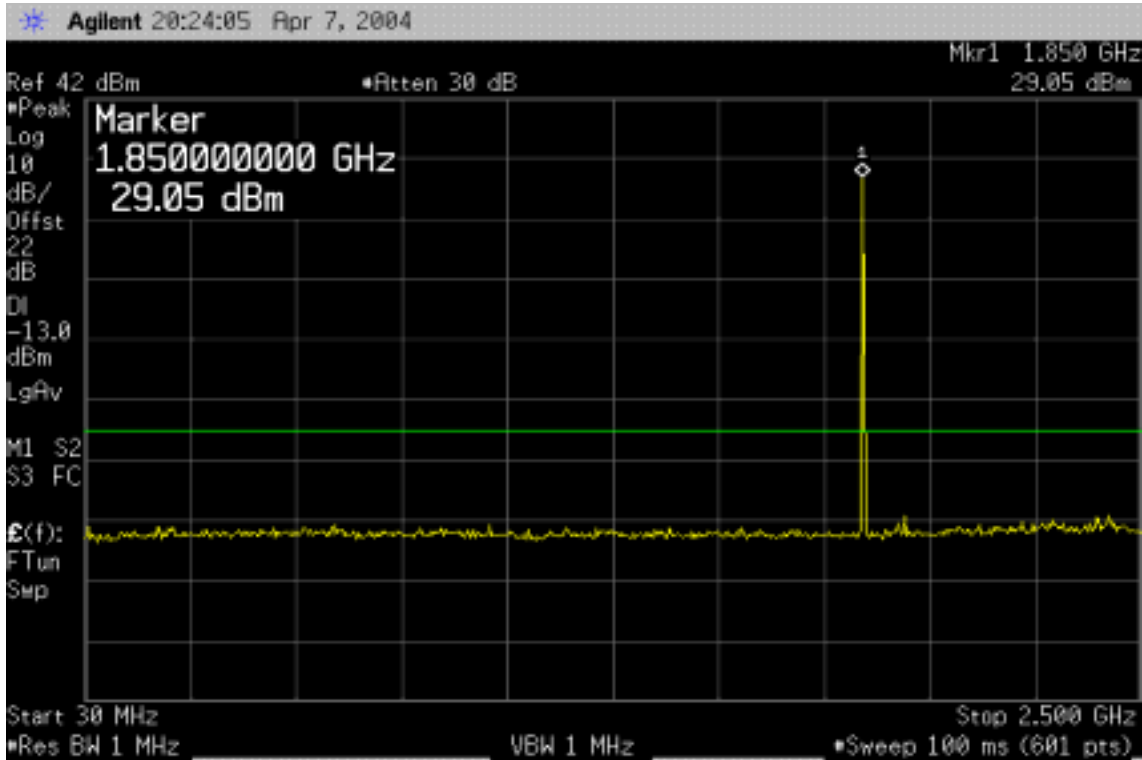

Figure 7-8: Out of Band emission at antenna terminals–GPRS CH Low



Figure 7-9: Out of Band emission at antenna terminals –GPRS CH Mid

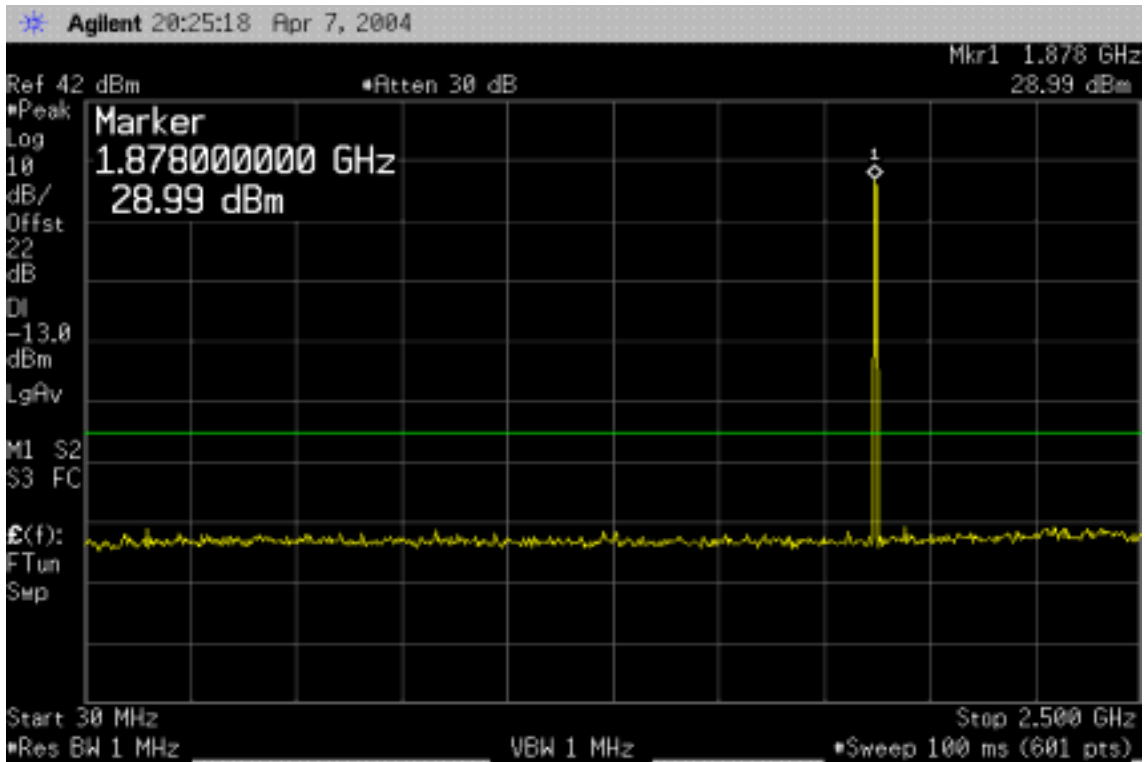

Figure 7-10: Out of Band emission at antenna terminals –GPRS CH Mid

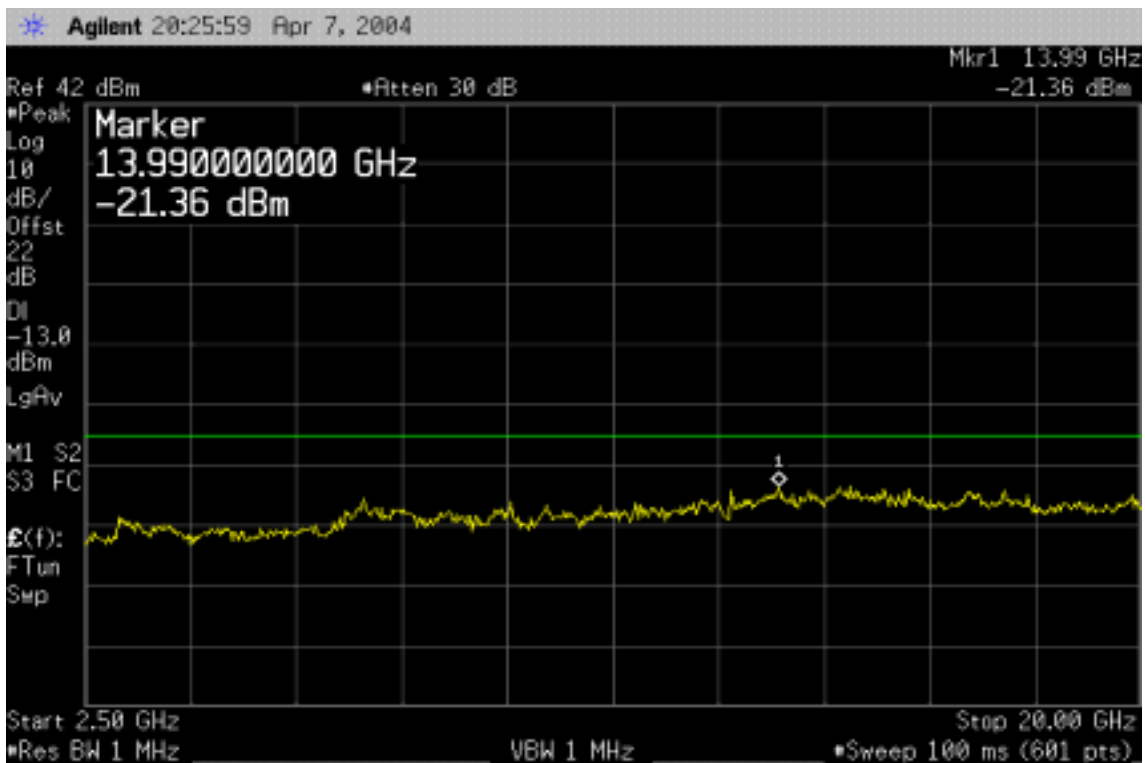

Figure 7-11: Out of Band emission at antenna terminals–GPRS CH High

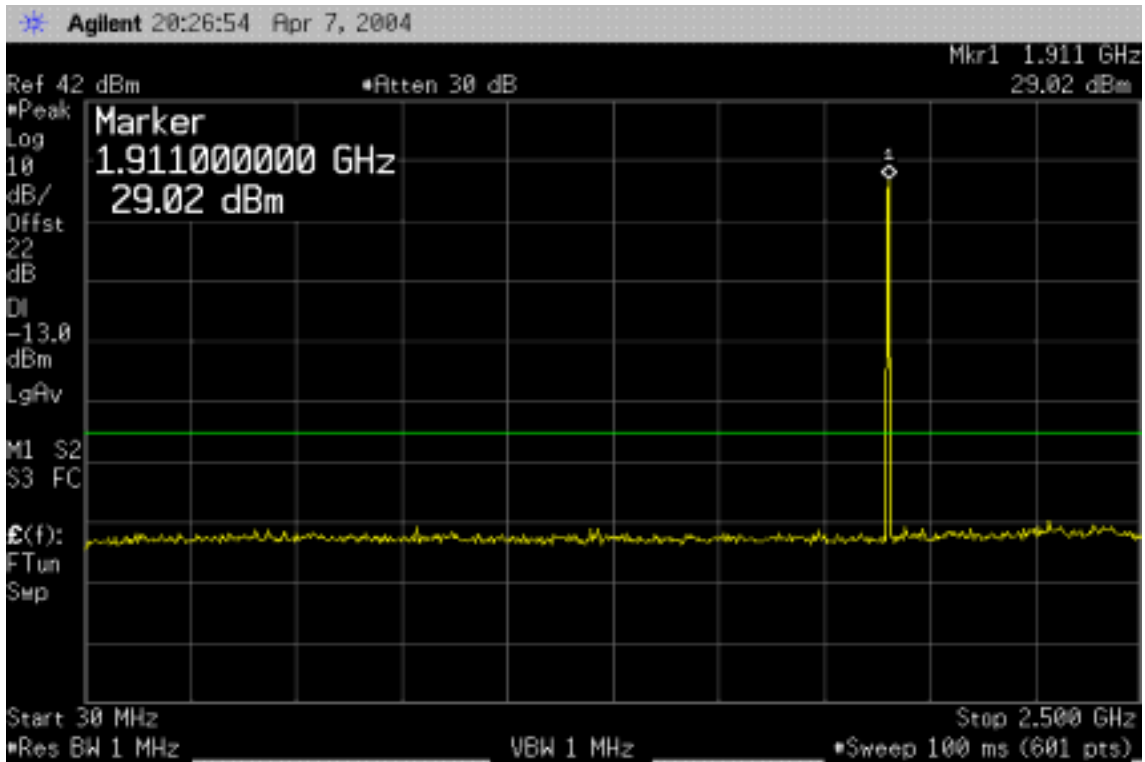
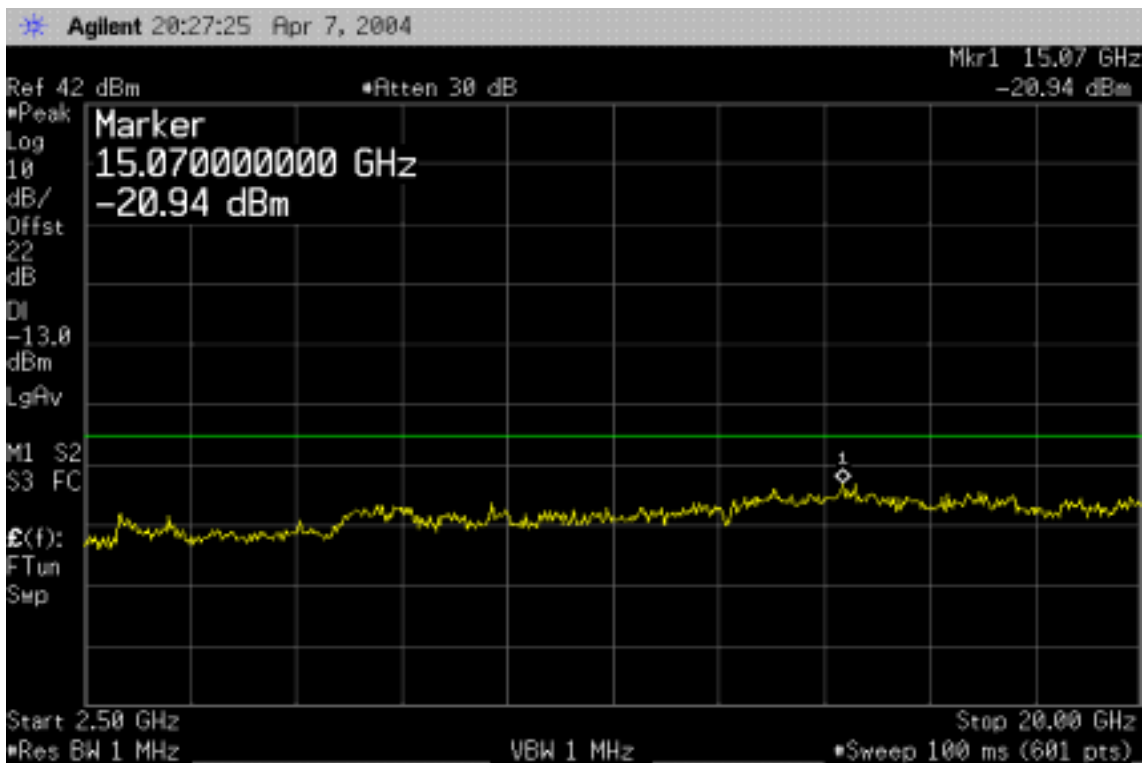

Figure 7-12: Out of Band emission at antenna terminals–GPRS CH High



GSM

Figure 7-13 Block edge emission at antenna terminals –GSM Block A

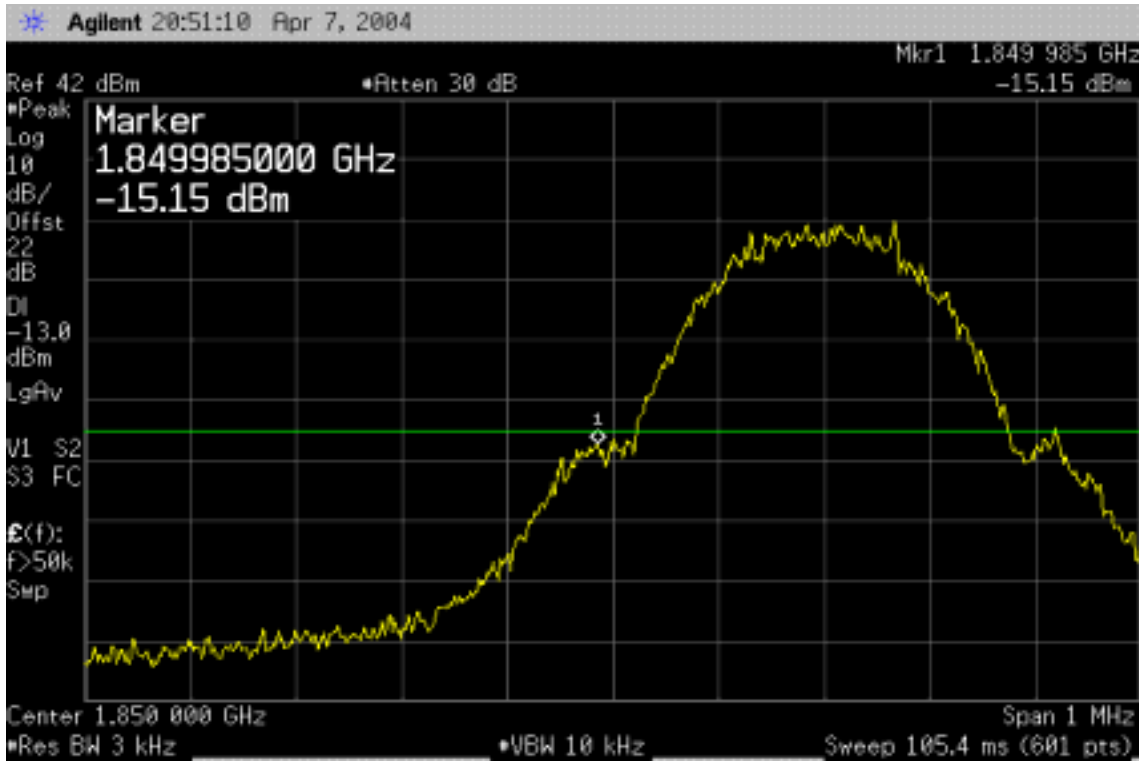

Figure 7-14: Block edge emission at antenna terminals –GSM Block A

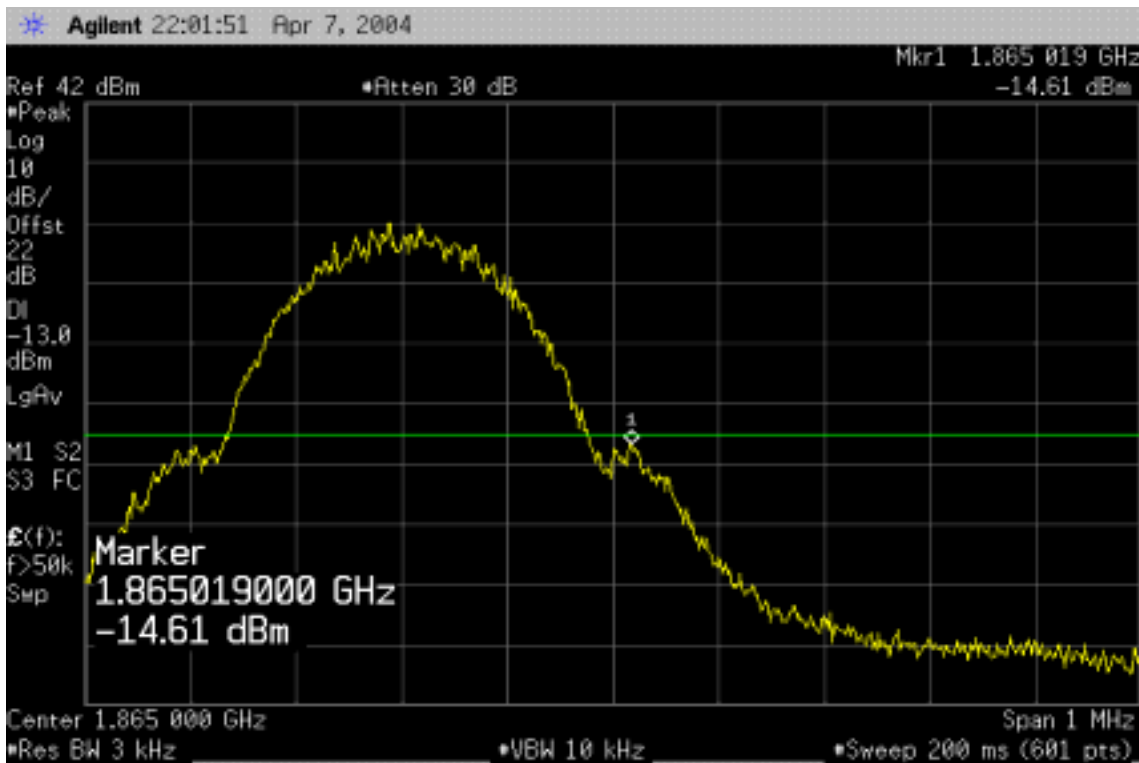

Figure 7-15 Block edge emission at antenna terminals –GSM Block D

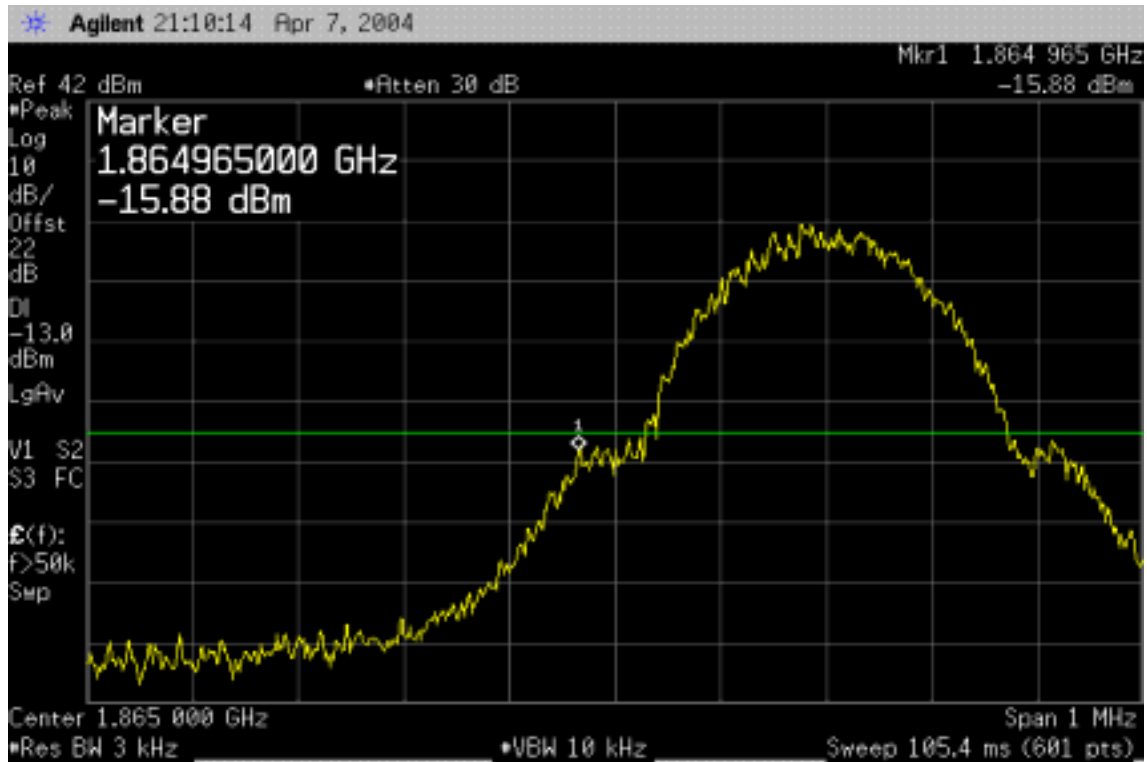

Figure 7-16 Block edge emission at antenna terminals –GSM Block D

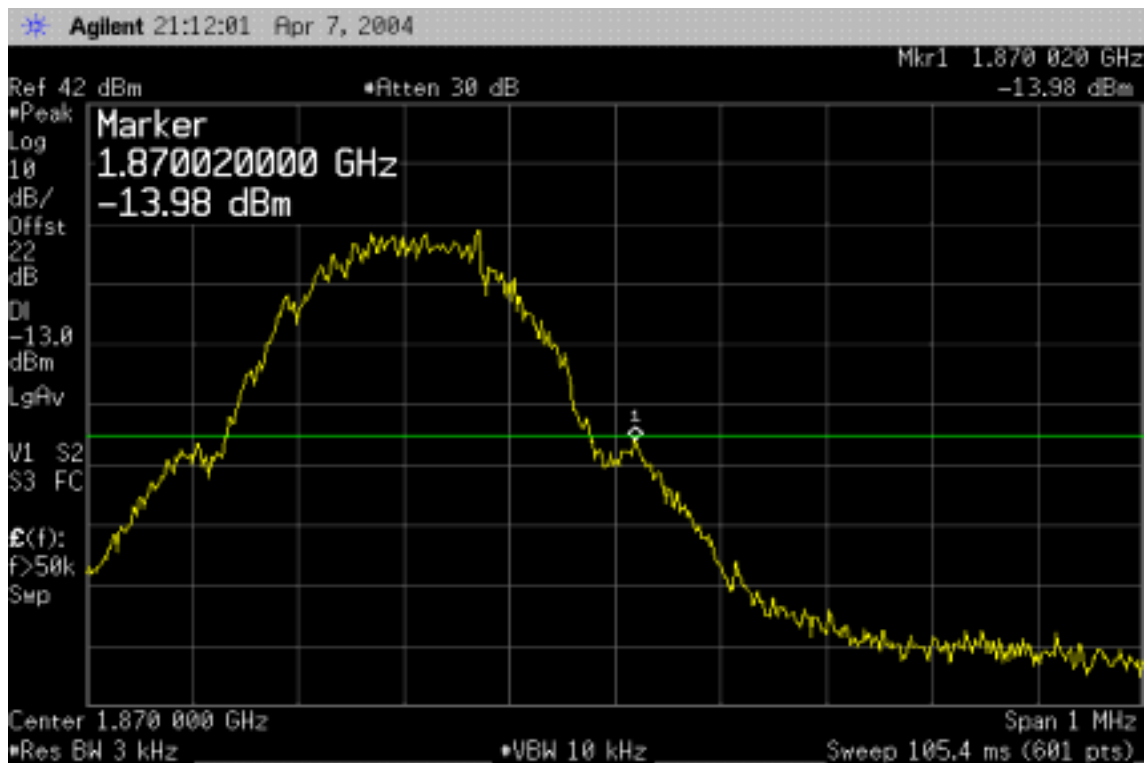

Figure 7-17 Block edge emission at antenna terminals –GSM Block B

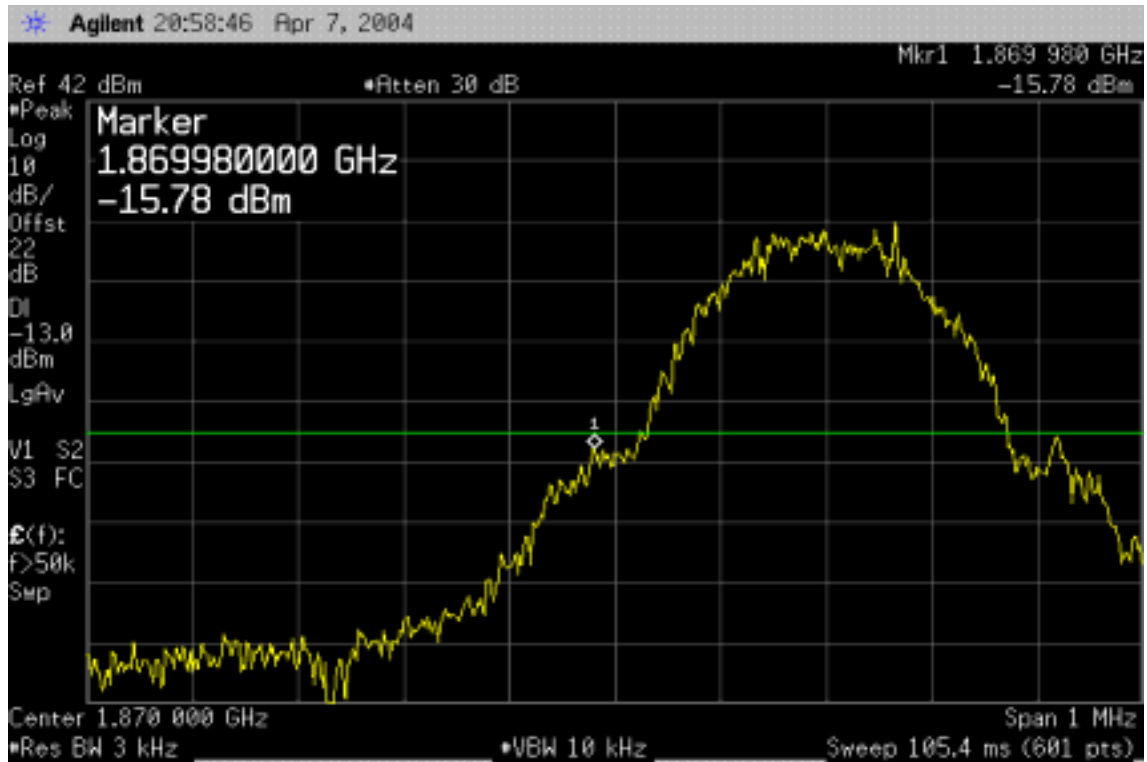

Figure 7-18 Block edge emission at antenna terminals –GSM Block B

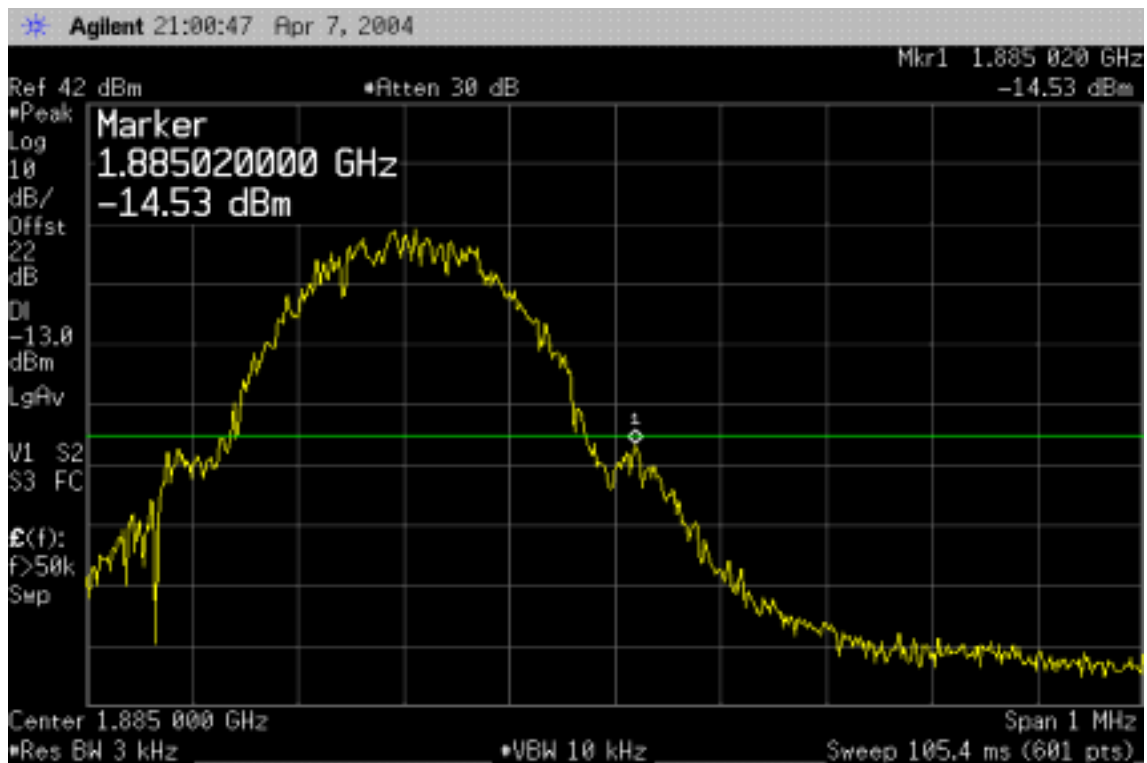

Figure 7-19 Block edge emission at antenna terminals –GSM Block E

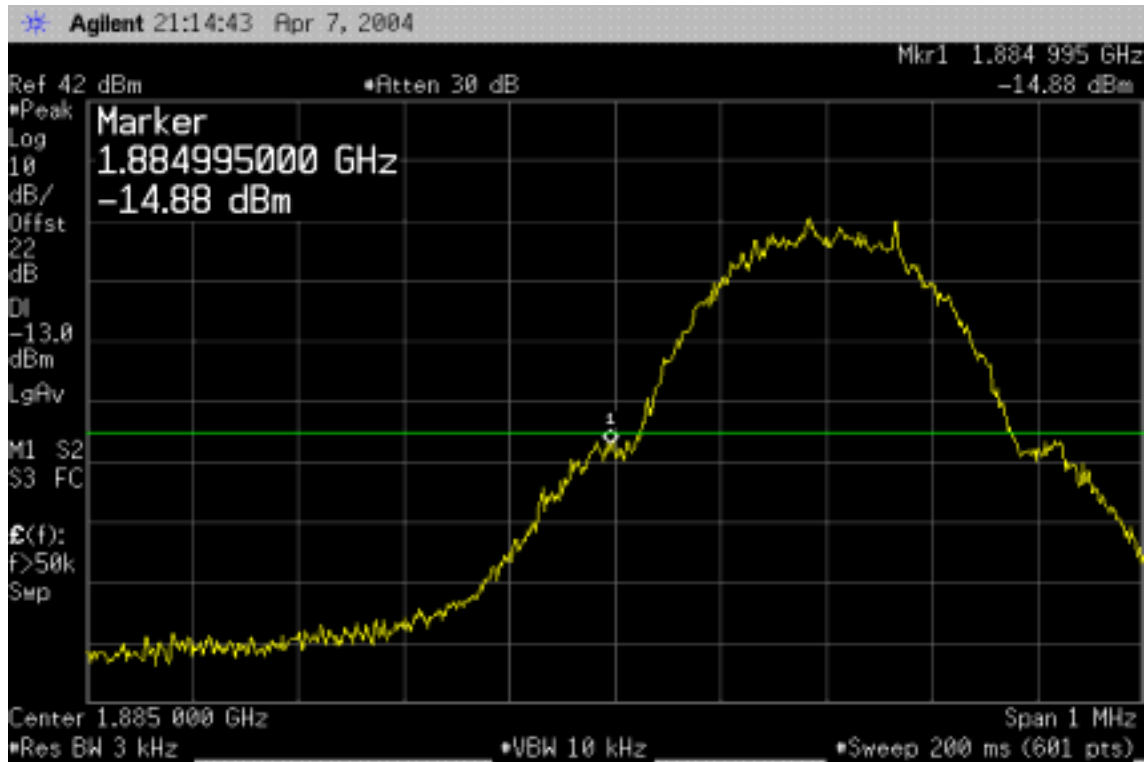

Figure 7-20 Block edge emission at antenna terminals –GSM Block E

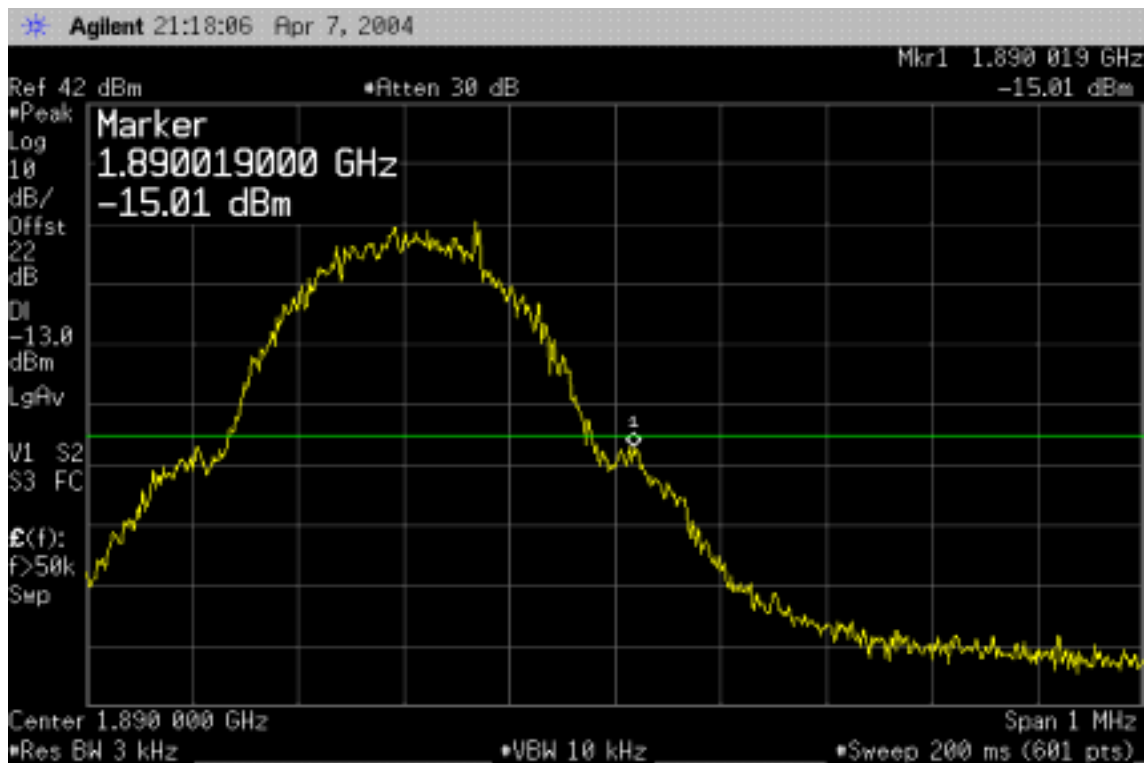

Figure 7-21 Block edge emission at antenna terminals –GSM Block F

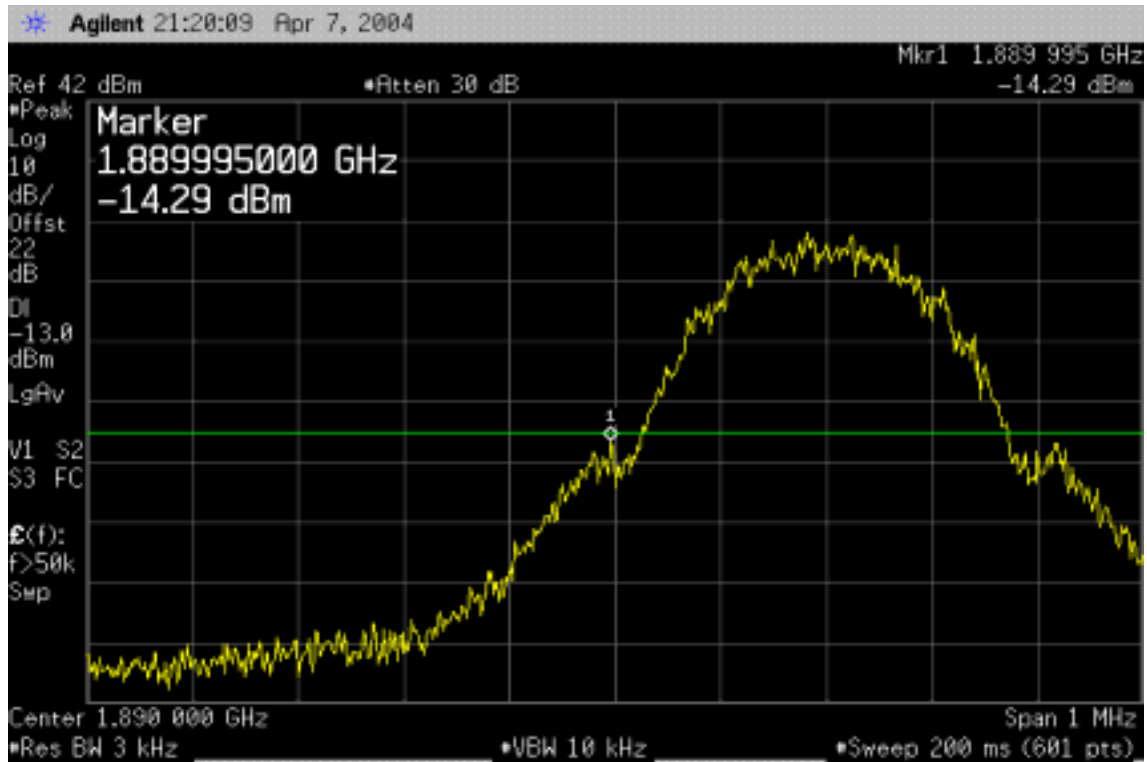

Figure 7-22 Block edge emission at antenna terminals –GSM Block F



Figure 7-23 Block edge emission at antenna terminals –GSM Block C

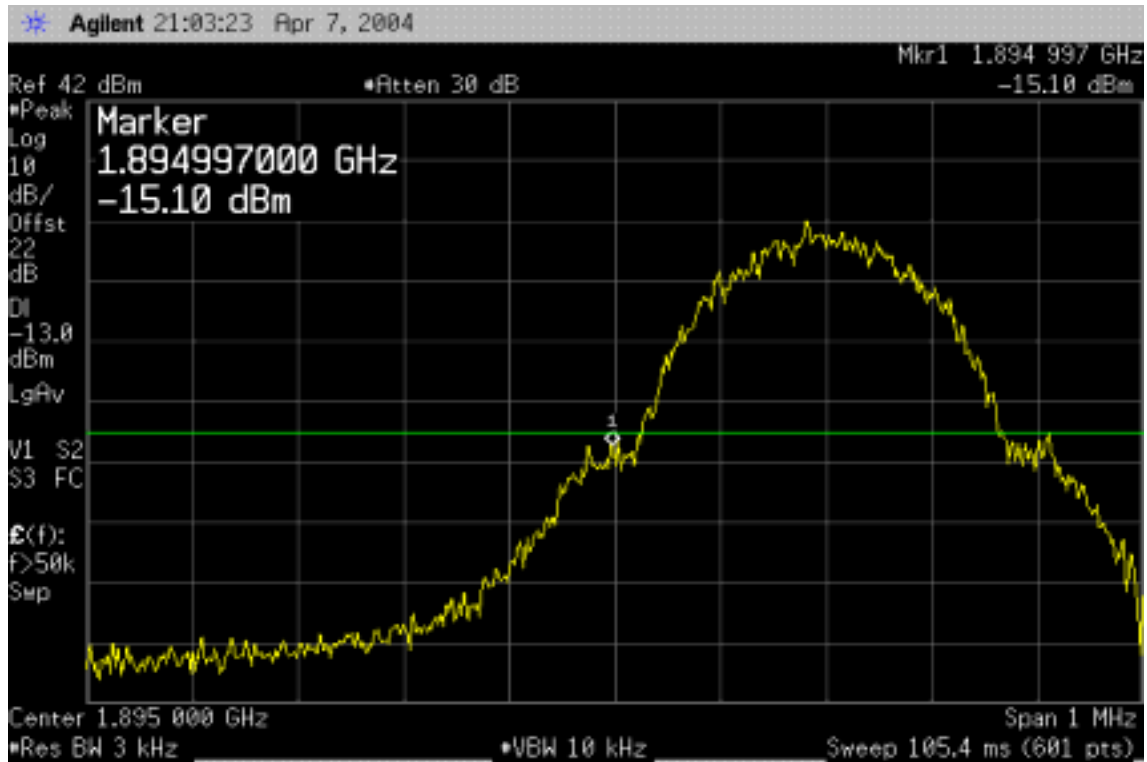
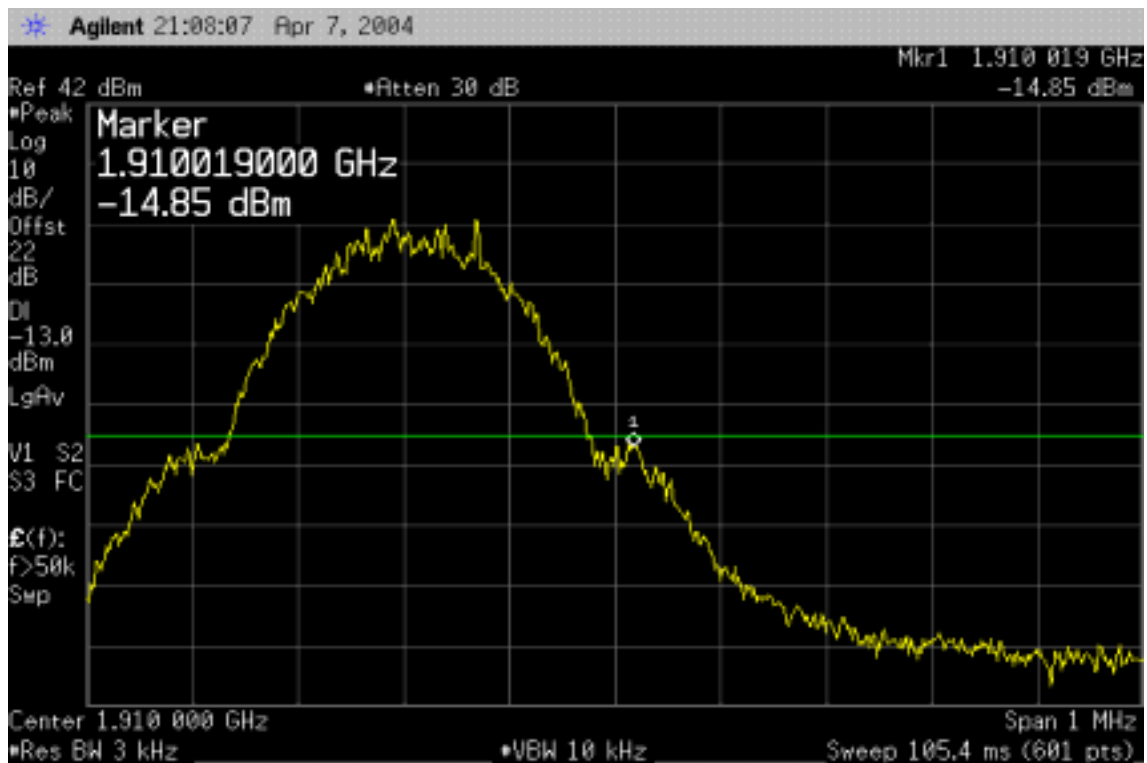

Figure 7-24 Block edge emission at antenna terminals –GSM Block C



GPRS

Figure 7-25 Block edge emission at antenna terminals –GPRS Block A

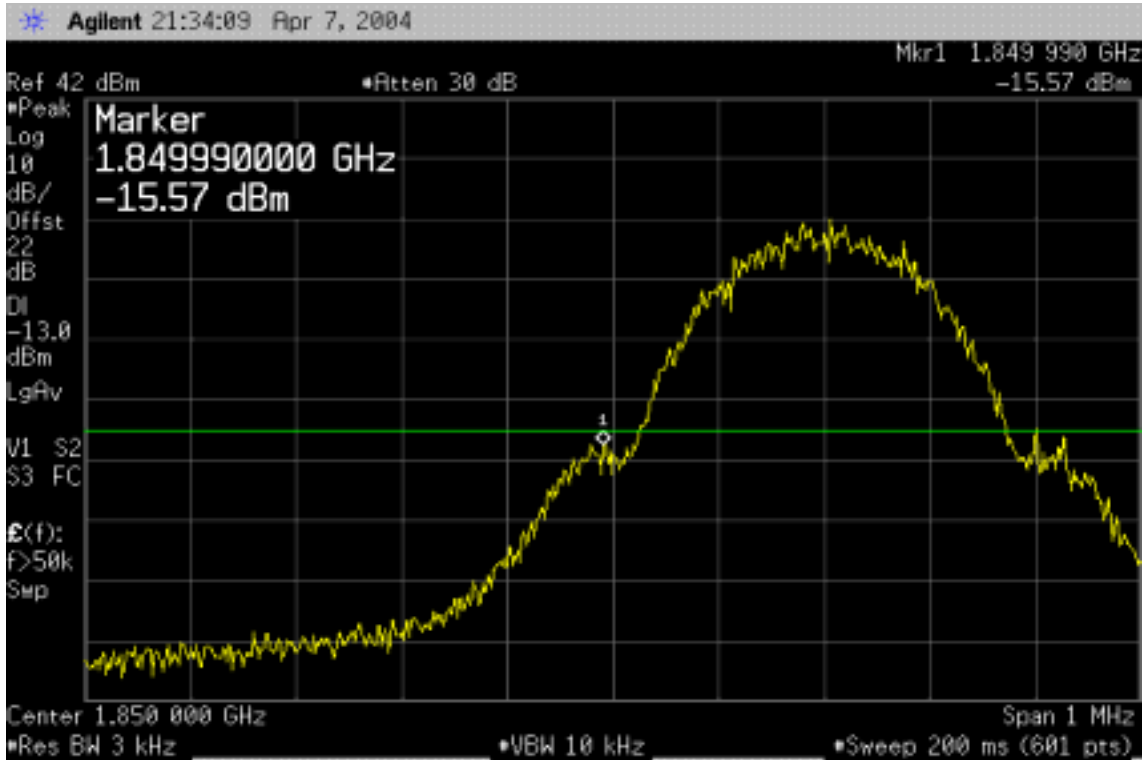

Figure 7-26 Block edge emission at antenna terminals –GPRS Block A

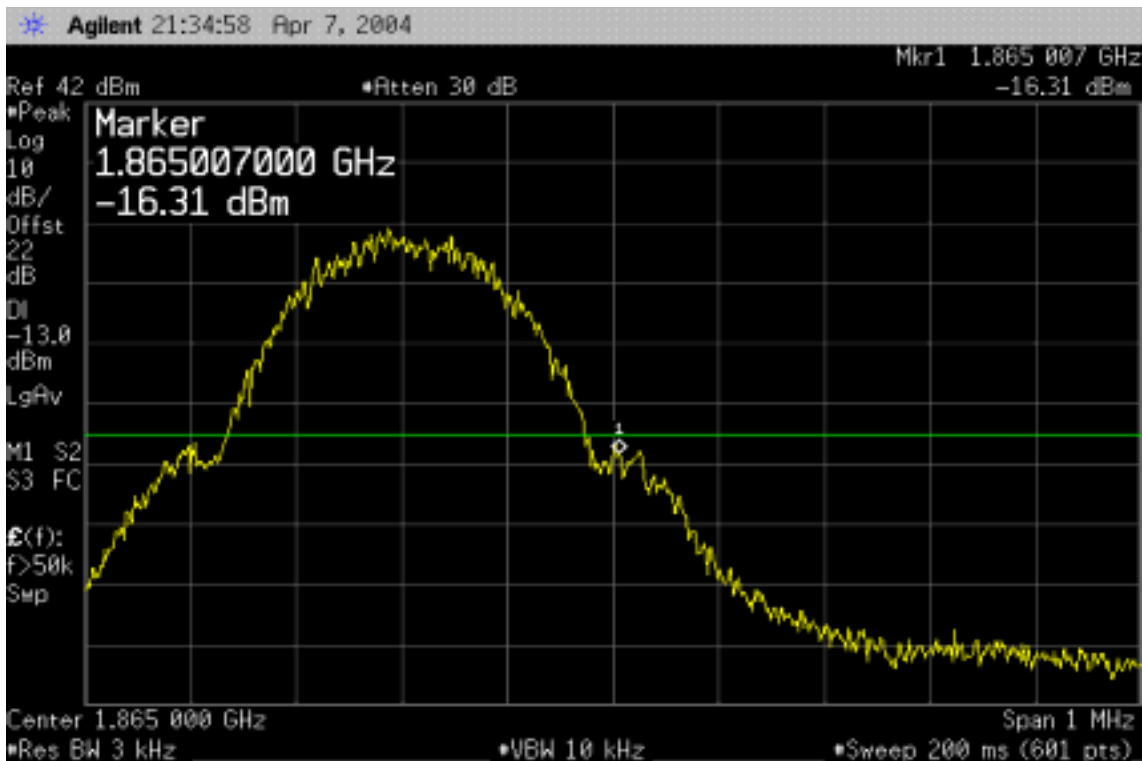

Figure 7-27 Block edge emission at antenna terminals –GPRS Block D

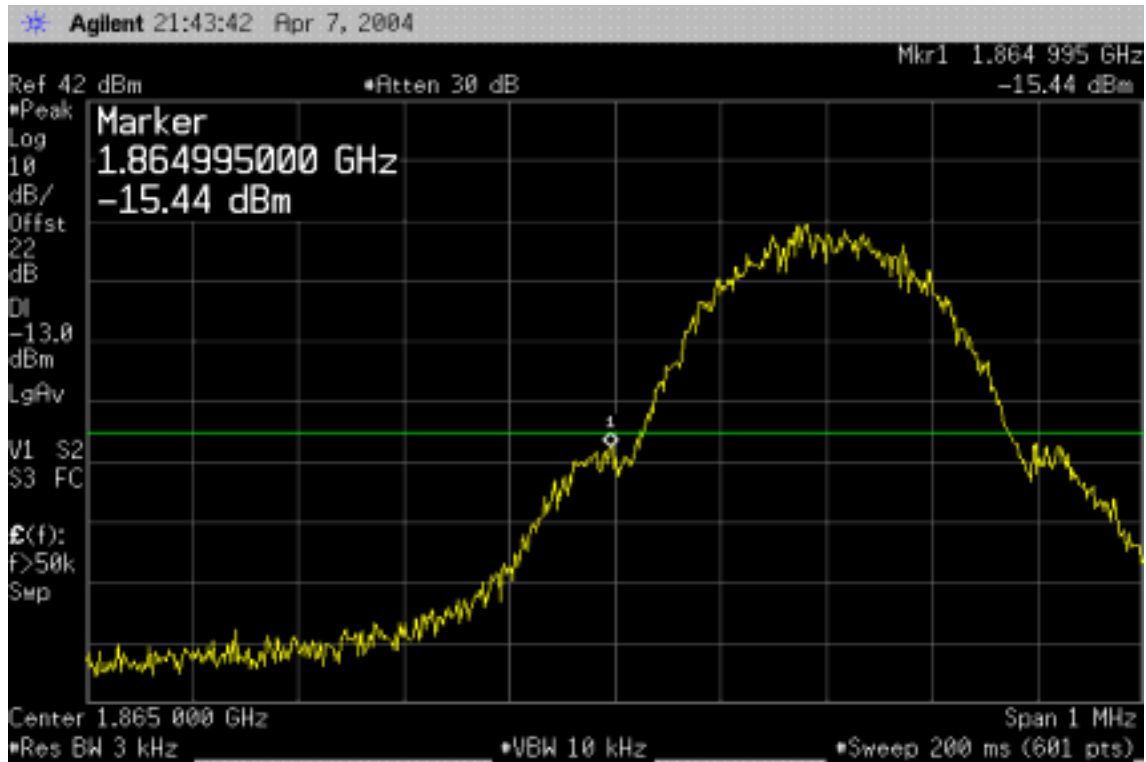

Figure 7-28 Block edge emission at antenna terminals –GPRS Block D

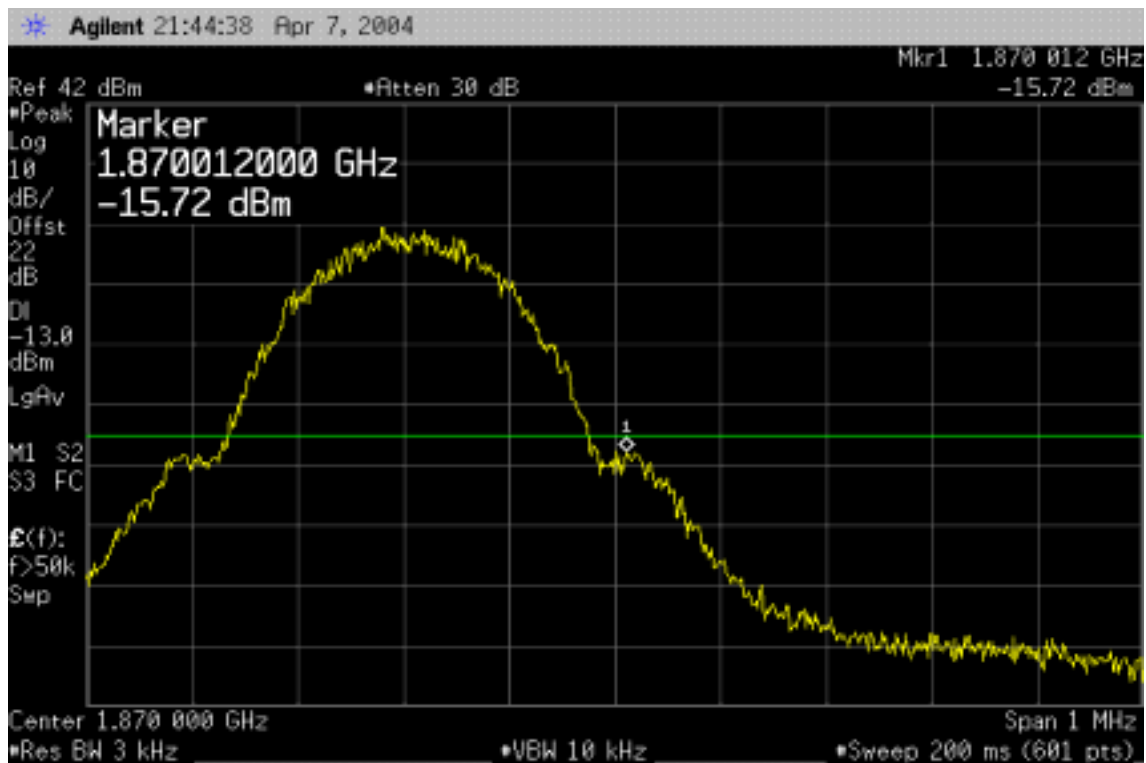

Figure 7-29 Block edge emission at antenna terminals –GPRS Block B

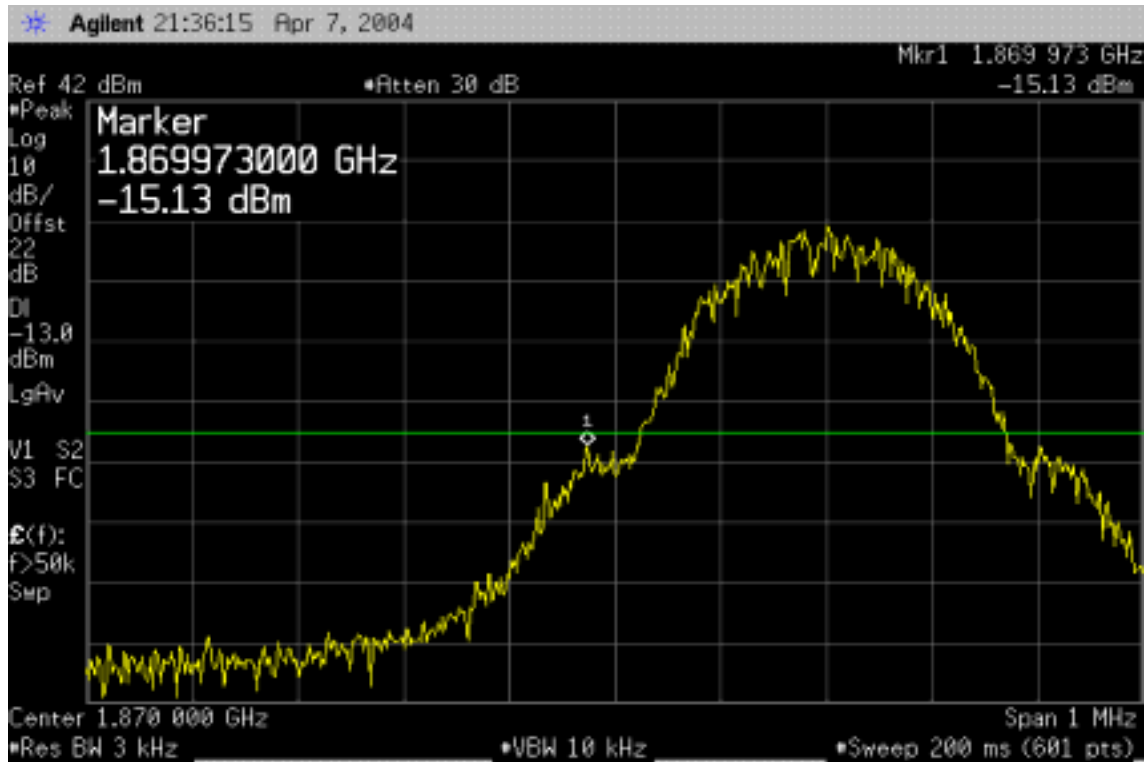

Figure 7-30 Block edge emission at antenna terminals –GPRS Block B

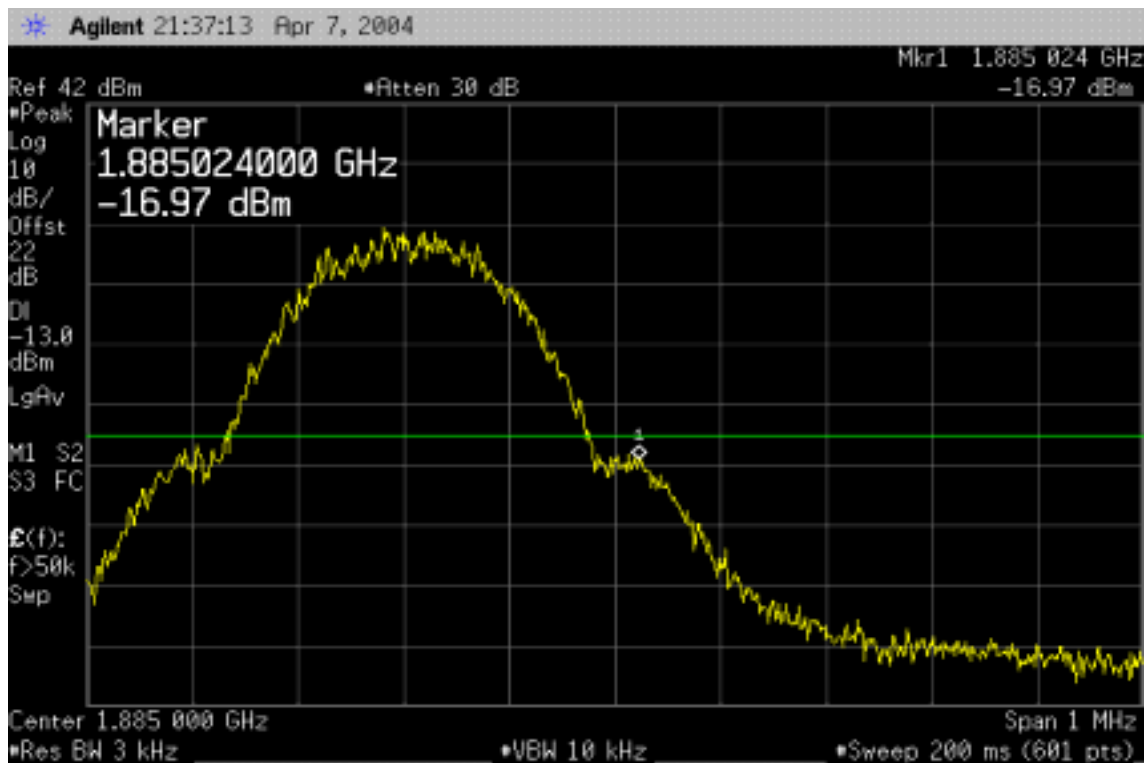

Figure 7-31 Block edge emission at antenna terminals –GPRS Block E

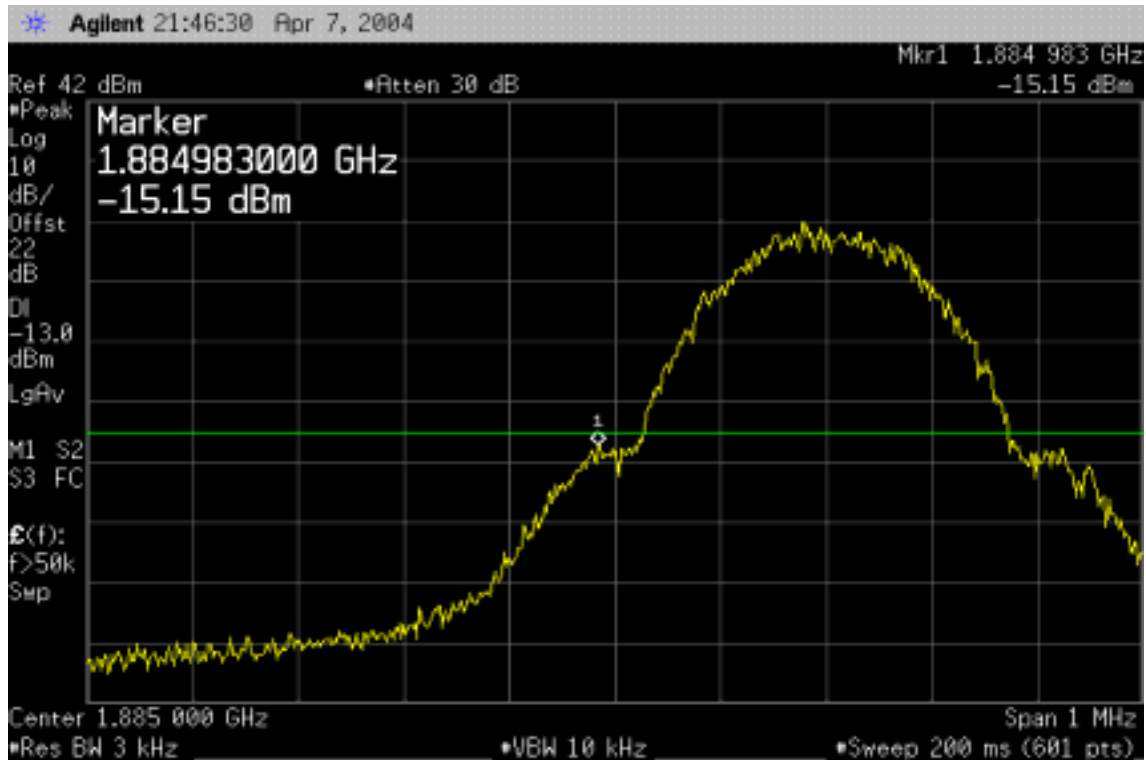

Figure 7-32 Block edge emission at antenna terminals –GPRS Block E

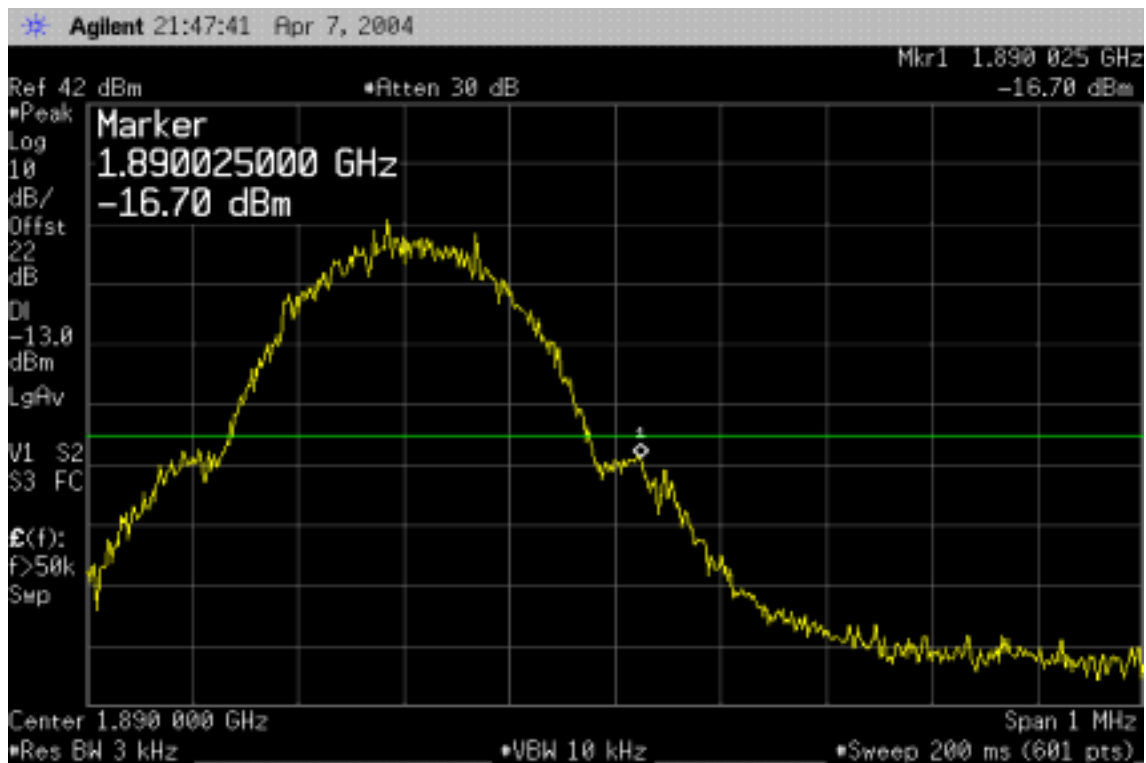

Figure 7-33 Block edge emission at antenna terminals –GPRS Block F

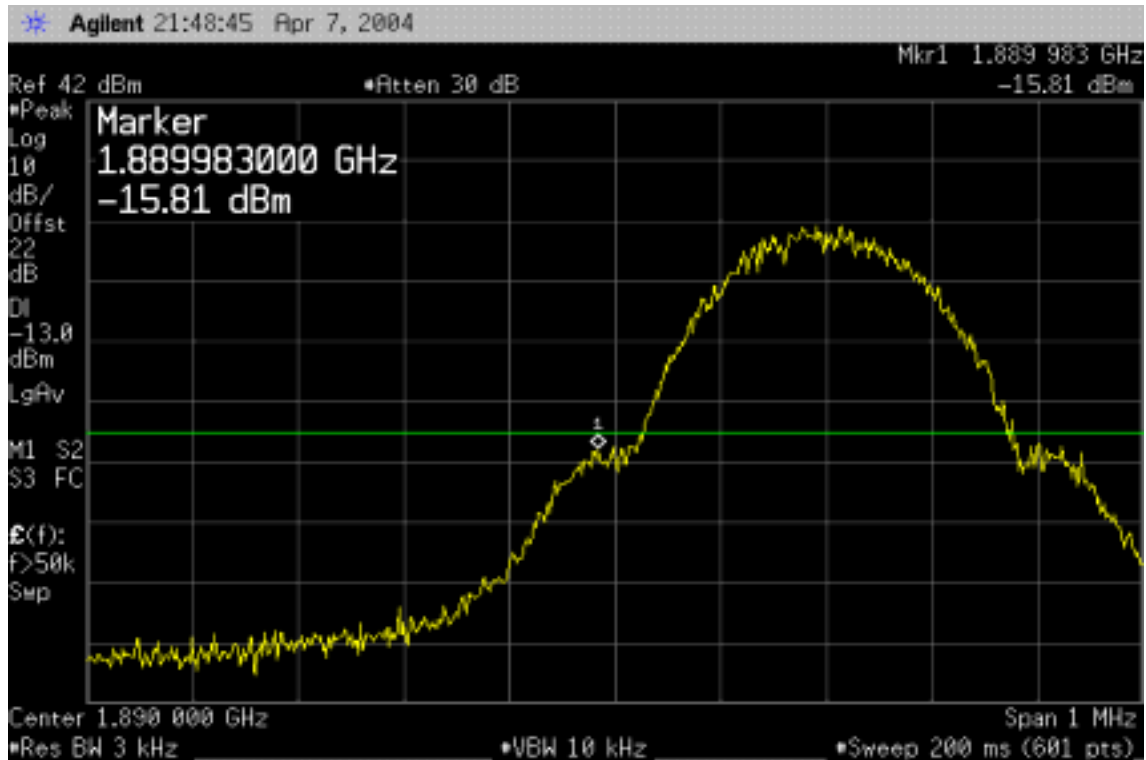

Figure 7-34 Block edge emission at antenna terminals –GPRS Block F

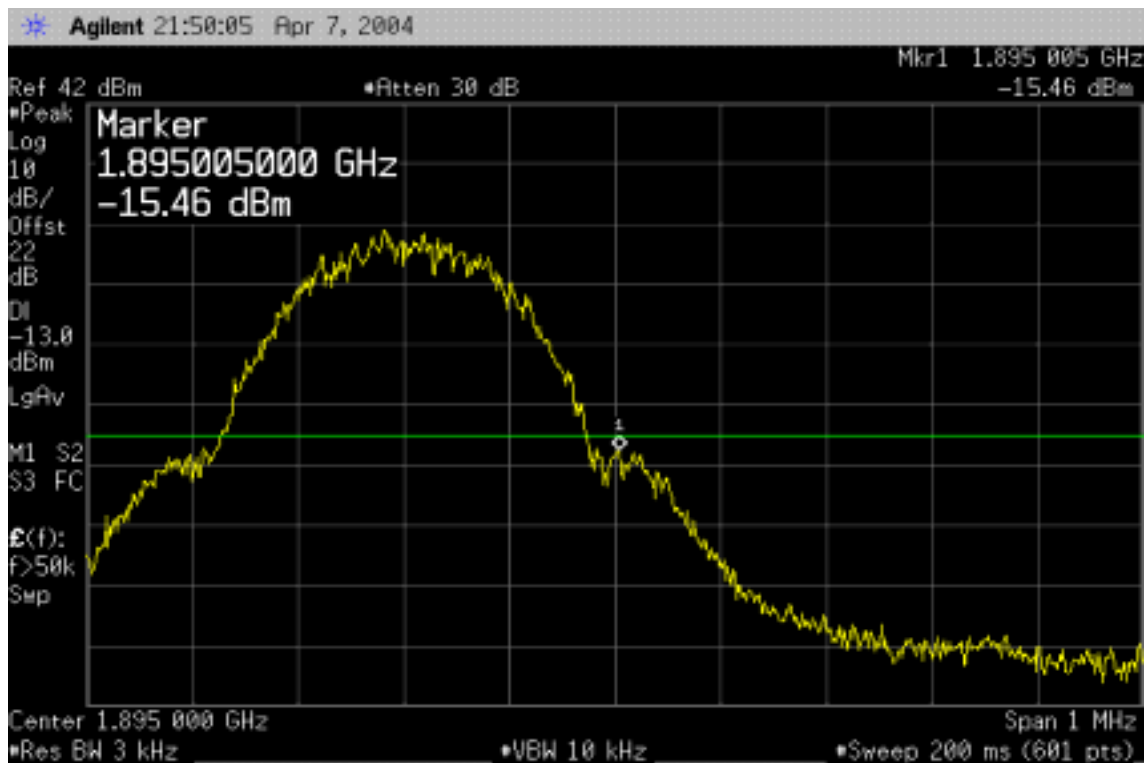

Figure 7-35 Block edge emission at antenna terminals –GPRS Block C

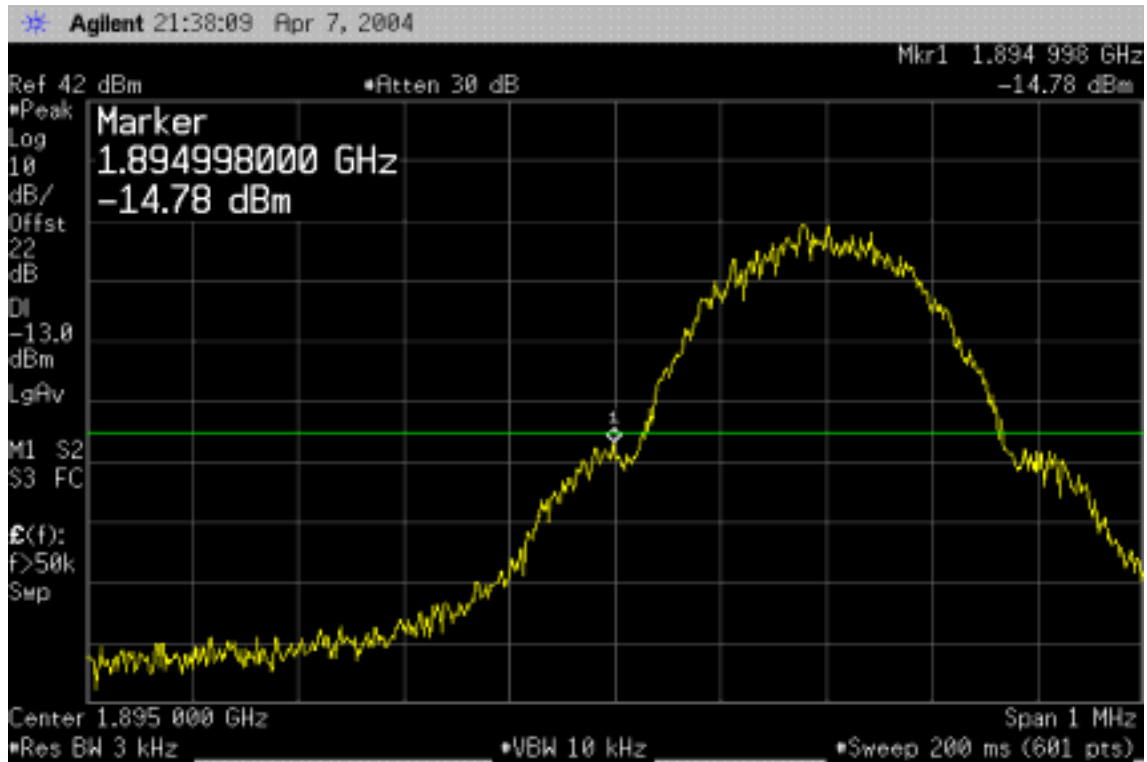
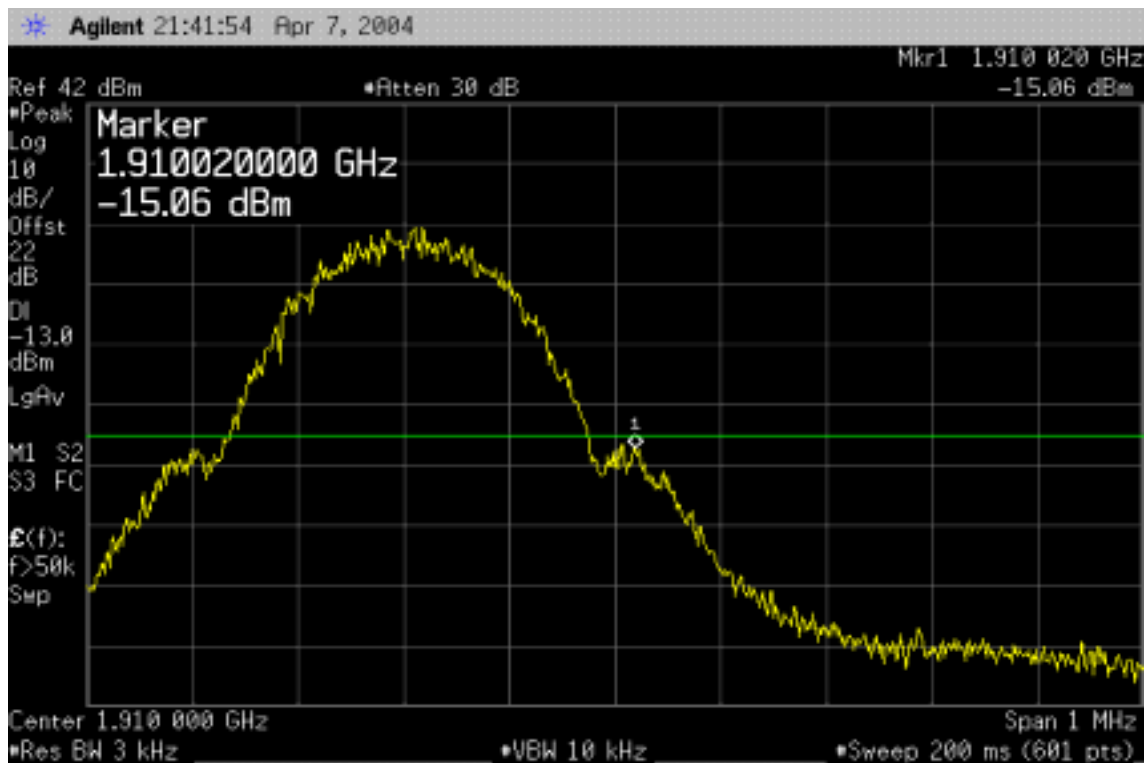

Figure 7-36 Block edge emission at antenna terminals –GPRS Block C





7.5 FIELD STRENGTH OF SPURIOUS RADIATION MEASUREMENT

LIMIT

According to FCC §2.1053

MEASUREMENT EQUIPMENT USED

Open Area Test Site # 3				
Name of Equipment	Manufacturer	Model	Serial Number	Calibration Due
Spectrum Analyzer	Agilent	E4446A	US42510252	04/27/2004
Spectrum Analyzer	R&S	FSP30	100112	06/28/2004
Pre-Amplifier	HP	8447D	2944A09173	03/03/2005
Bi-log Antenna	SCHWAZBECK	VULB9163	145	07/05/2004
Horn antenna	EMCO	3115	00022250	02/26/2005
Pre-Amplifier	HP	8449B	3008B00965	10/02/2004
Reject Filter	Micro-Tronics	HPM13194	003	04/27/2004
Turn Table	EMCO	2081-1.21	9709-1885	N.C.R
Antenna Tower	EMCO	2075-2	9707-2060	N.C.R
Controller	EMCO	2090	9709-1256	N.C.R
Site NSA	C&C	N/A	N/A	09/06/2004
S.G.	HP	83630B	3844A01022	01/14/2005
Substituted Dipole	SCHWAZBECK	VHAP/UHAP	998 +999/ 981+982	06/12/2004
Substituted Horn	EMCO	3115	00022256	02/26/2005

Remark: Each piece of equipment is scheduled for calibration once a year.

Test Configuration

Below 1 GHz

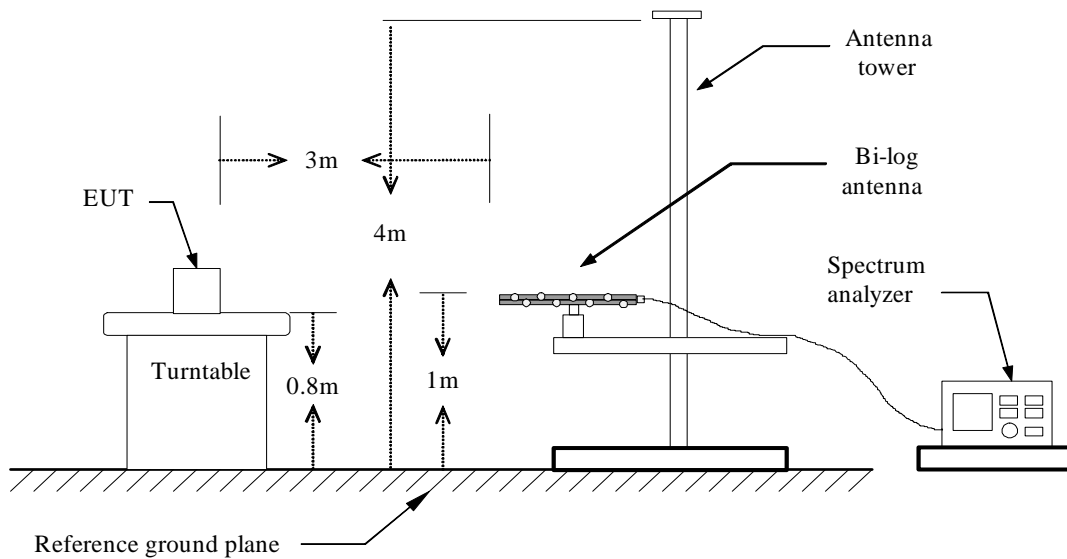

Above 1 GHz

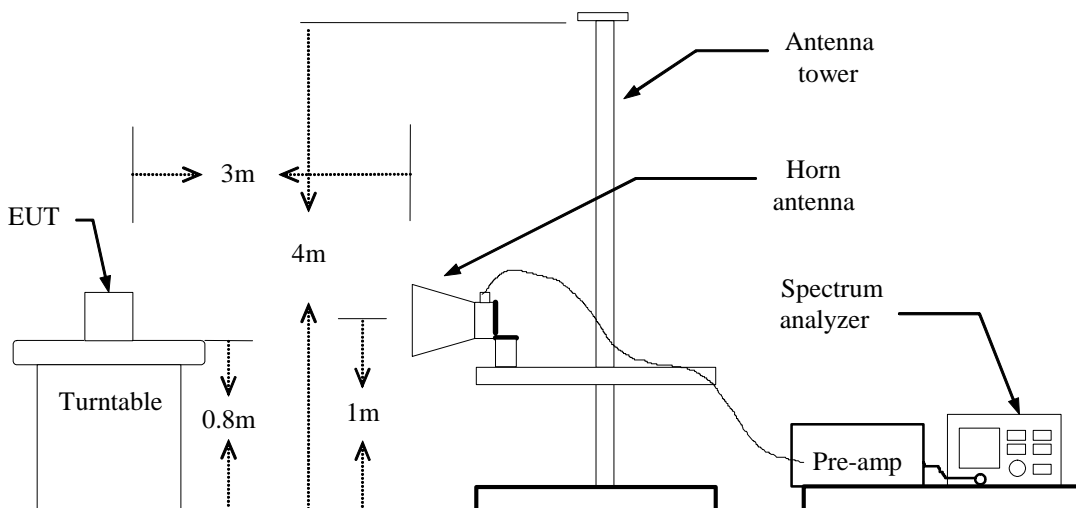

Substituted Method Test Set-up

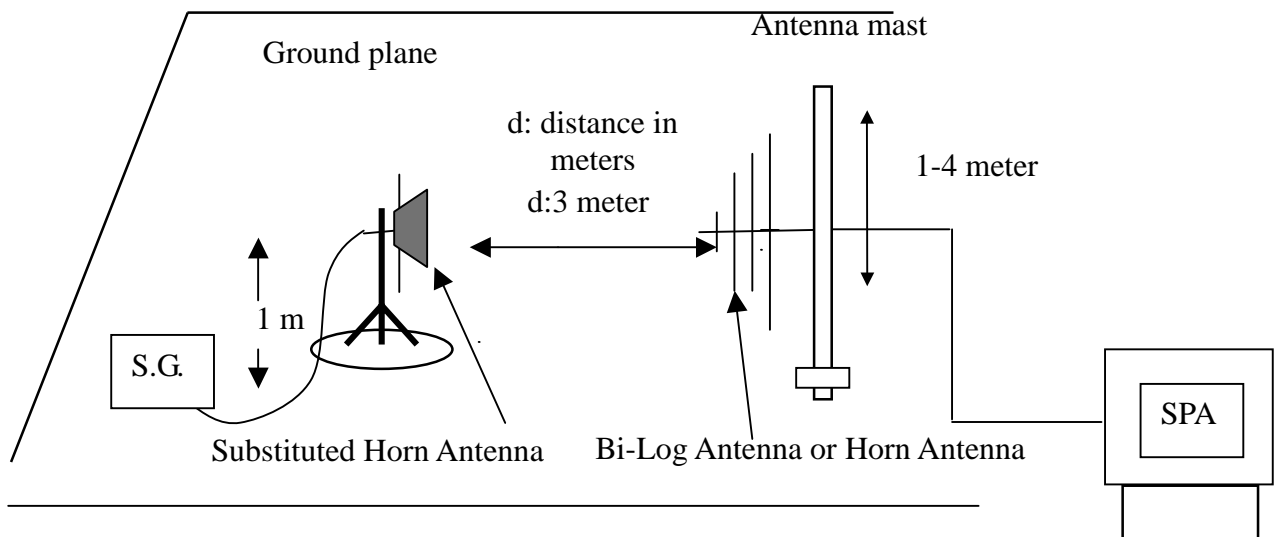



TEST PROCEDURE

The EUT was placed on a non-conductive, the measurement antenna was placed at a distance of 3 meters from the EUT. During the tests, the antenna height and the EUT azimuth were varied in order to identify the maximum level of emissions from the EUT. This maximization process was repeated with the EUT positioned in each of its three orthogonal orientations.

The frequency range up to tenth harmonic was investigated for each of three fundamental frequency (low, middle and high channels). Once spurious emission were identified, the power of the emission was determined using the substitution method.

The spurious emissions attenuation was calculated as the difference between radiated power at the fundamental frequency and the spurious emissions frequency.

$$\text{ERP} = \text{S.G. output (dBm)} + \text{Antenna Gain (dBd)} - \text{Cable (dB)}$$

$$\text{EIRP} = \text{S.G. output (dBm)} + \text{Antenna Gain (dBi)} - \text{Cable (dB)}$$

TEST RESULTS

Refer to the attached tabular data sheets.

**Radiated Spurious Emission Measurement Result****Below 1GHz**

No emissions to be recorded.

(Since no specific emission noted beyond the background noise floor)

Above 1GHz

Operation Mode: TX / CH512 / Y Mode / GSM / Adapter / Open **Test Date:** March 29, 2004

Temperature: 25°C

Tested by: Chris Hsieh

Humidity: 55 % RH

Polarity: Ver. / Hor.

Frequency (MHz)	Reading level (dBuV)	Antenna Polarization	S.G. (dBm)	Cable loss (dB)	Ant.Gain (dBi)	Emission level (dBm)	Limit (dBm)	Margin (dB)
3700.62	53.00	V	-43.00	6.21	9.36	-39.85	-13.00	-26.85
5550.96	54.33	V	-36.17	8.11	10.35	-33.93	-13.00	-20.93
7401.80	52.34	V	-34.07	9.46	10.48	-33.05	-13.00	-20.05
9250.86	57.60	V	-25.25	10.42	11.40	-24.27	-13.00	-11.27
11100.12	49.77	V	-29.65	11.36	12.24	-28.78	-13.00	-15.78

3699.97	54.02	H	-41.20	6.19	9.36	-38.03	-13.00	-25.03
5550.14	51.02	H	-39.31	8.11	10.35	-37.07	-13.00	-24.07
7401.04	51.35	H	-34.55	9.46	10.48	-33.53	-13.00	-20.53
9250.71	54.27	H	-28.58	10.42	11.40	-27.60	-13.00	-14.60
11100.10	50.02	H	-29.40	11.36	12.24	-28.53	-13.00	-15.53

Notes:

1. Measuring frequencies from 30 MHz to the 10th harmonic of highest fundamental frequency.
2. Data of measurement within this frequency range shown " - " in the table above means the reading of emissions are attenuated more than 20dB below the permissible limits or the field strength is too small to be measured.
3. Spectrum Setting:
30MHz- 1GHz, RBW= 100KHz, VBW= 100kHz, Sweep time= 200 ms.
1GHz- 26GHz, RBW= 1MHz, VBW= 1MHz, Sweep time= 200 ms.
4. X Mode means the EUT in stand-up position; Y, Z Mode means the EUT in lied-on position.



Operation Mode: TX / CH661 / Y Mode / GSM / Adapter / Open Test Date: March 29, 2004

Temperature: 25°C

Tested by: Chris Hsieh

Humidity: 55 % RH

Polarity: Ver. / Hor.

Frequency (MHz)	Reading level (dBuV)	Antenna Polarization	S.G. (dBm)	Cable loss (dB)	Ant.Gain (dBi)	Emission level (dBm)	Limit (dBm)	Margin (dB)
3759.67	51.93	V	-43.82	6.30	9.35	-40.77	-13.00	-27.77
5639.52	53.77	V	-36.61	8.17	10.43	-34.35	-13.00	-21.35
7519.76	51.10	V	-34.38	9.62	10.41	-33.59	-13.00	-20.59
9400.18	55.35	V	-27.31	10.45	11.52	-26.24	-13.00	-13.24
11280.10	49.43	V	-29.44	11.70	12.13	-29.01	-13.00	-16.01

3759.70	51.52	H	-43.40	6.30	9.35	-40.35	-13.00	-27.35
5639.38	50.85	H	-39.36	8.17	10.43	-37.10	-13.00	-24.10
7520.01	50.68	H	-34.78	9.63	10.42	-33.99	-13.00	-20.99
9399.97	52.77	H	-29.90	10.45	11.51	-28.84	-13.00	-15.84
11280.01	49.35	H	-29.52	11.70	12.13	-29.09	-13.00	-16.09

Notes:

1. Measuring frequencies from 30 MHz to the 10th harmonic of highest fundamental frequency.
2. Data of measurement within this frequency range shown “ - ” in the table above means the reading of emissions are attenuated more than 20dB below the permissible limits or the field strength is too small to be measured.
3. Spectrum Setting:
30MHz- 1GHz, RBW= 100KHz, VBW= 100kHz, Sweep time= 200 ms.
1GHz- 26GHz, RBW= 1MHz, VBW= 1MHz, Sweep time= 200 ms.
4. X Mode means the EUT in stand-up position; Y, Z Mode means the EUT in lied-on position.



Operation Mode: TX / CH810 / Y Mode / GSM / Adapter / Open Test Date: March 29, 2004

Temperature: 25°C

Tested by: Chris Hsieh

Humidity: 55 % RH

Polarity: Ver. / Hor.

Frequency (MHz)	Reading level (dBuV)	Antenna Polarization	S.G. (dBm)	Cable loss (dB)	Ant.Gain (dBi)	Emission level (dBm)	Limit (dBm)	Margin (dB)
3819.42	51.02	V	-44.43	6.41	9.34	-41.50	-13.00	-28.50
5729.93	51.18	V	-39.07	8.23	10.52	-36.77	-13.00	-23.77
7639.33	50.60	V	-34.66	9.66	10.53	-33.78	-13.00	-20.78
9548.64	53.43	V	-29.23	10.52	11.62	-28.14	-13.00	-15.14

3819.57	50.18	H	-44.44	6.41	9.34	-41.51	-13.00	-28.51
5729.35	53.43	H	-36.65	8.23	10.52	-34.35	-13.00	-21.35
7639.44	50.60	H	-34.66	9.66	10.53	-33.78	-13.00	-20.78
9548.68	51.27	H	-31.22	10.52	11.62	-30.13	-13.00	-17.13

Notes:

1. Measuring frequencies from 30 MHz to the 10th harmonic of highest fundamental frequency.
2. Data of measurement within this frequency range shown “ - ” in the table above means the reading of emissions are attenuated more than 20dB below the permissible limits or the field strength is too small to be measured.
3. Spectrum Setting:
30MHz- 1GHz, RBW= 100KHz, VBW= 100kHz, Sweep time= 200 ms.
1GHz- 26GHz, RBW= 1MHz, VBW= 1MHz, Sweep time= 200 ms.
4. X Mode means the EUT in stand-up position; Y, Z Mode means the EUT in lied-on position.



Operation Mode: TX / CH512 / Y Mode / GPRS / Adapter / Open Test Date: March 29, 2004

Temperature: 25°C

Tested by: Chris Hsieh

Humidity: 55 % RH

Polarity: Ver. / Hor.

Frequency (MHz)	Reading level (dBuV)	Antenna Polarization	S.G. (dBm)	Cable loss (dB)	Ant.Gain (dBi)	Emission level (dBm)	Limit (dBm)	Margin (dB)
3699.95	52.27	V	-43.78	6.19	9.36	-40.61	-13.00	-27.61
5549.98	51.18	V	-39.33	8.11	10.34	-37.10	-13.00	-24.10
7399.86	52.43	V	-34.01	9.44	10.49	-32.97	-13.00	-19.97
9250.65	57.18	V	-25.67	10.42	11.40	-24.69	-13.00	-11.69
11090.94	49.85	V	-29.60	11.35	12.25	-28.70	-13.00	-15.70

3700.92	50.27	H	-44.90	6.21	9.36	-41.75	-13.00	-28.75
5550.21	50.52	H	-39.81	8.11	10.35	-37.57	-13.00	-24.57
7400.08	51.02	H	-34.88	9.46	10.48	-33.86	-13.00	-20.86
9250.65	54.35	H	-28.50	10.42	11.40	-27.52	-13.00	-14.52
11090.93	49.85	H	-29.60	11.35	12.25	-28.70	-13.00	-15.70

Notes:

1. Measuring frequencies from 30 MHz to the 10th harmonic of highest fundamental frequency.
2. Data of measurement within this frequency range shown “ - ” in the table above means the reading of emissions are attenuated more than 20dB below the permissible limits or the field strength is too small to be measured.
3. Spectrum Setting:
30MHz- 1GHz, RBW= 100KHz, VBW= 100kHz, Sweep time= 200 ms.
1GHz- 26GHz, RBW= 1MHz, VBW= 1MHz, Sweep time= 200 ms.
4. X Mode means the EUT in stand-up position; Y, Z Mode means the EUT in lied-on position.



Operation Mode: TX / CH661 / Y Mode / GPRS / Adapter / Open Test Date: March 29, 2004

Temperature: 25°C

Tested by: Chris Hsieh

Humidity: 55 % RH

Polarity: Ver. / Hor.

Frequency (MHz)	Reading level (dBuV)	Antenna Polarization	S.G. (dBm)	Cable loss (dB)	Ant.Gain (dBi)	Emission level (dBm)	Limit (dBm)	Margin (dB)
3759.80	50.93	V	-44.82	6.30	9.35	-41.77	-13.00	-28.77
5639.34	52.10	V	-38.28	8.17	10.43	-36.02	-13.00	-23.02
7520.37	51.35	V	-34.11	9.63	10.42	-33.32	-13.00	-20.32
9400.20	55.60	V	-27.06	10.45	11.52	-25.99	-13.00	-12.99
11270.99	50.02	V	-28.88	11.68	12.14	-28.42	-13.00	-15.42

3759.26	50.93	H	-43.99	6.30	9.35	-40.94	-13.00	-27.94
5639.78	51.18	H	-39.03	8.17	10.43	-36.77	-13.00	-23.77
7519.31	50.27	H	-35.21	9.62	10.41	-34.42	-13.00	-21.42
9399.79	53.77	H	-28.90	10.45	11.51	-27.84	-13.00	-14.84
11270.86	49.68	H	-29.22	11.68	12.14	-28.76	-13.00	-15.76

Notes:

1. Measuring frequencies from 30 MHz to the 10th harmonic of highest fundamental frequency.
2. Data of measurement within this frequency range shown “ - ” in the table above means the reading of emissions are attenuated more than 20dB below the permissible limits or the field strength is too small to be measured.
3. Spectrum Setting:
30MHz- 1GHz, RBW= 100KHz, VBW= 100kHz, Sweep time= 200 ms.
1GHz- 26GHz, RBW= 1MHz, VBW= 1MHz, Sweep time= 200 ms.
4. X Mode means the EUT in stand-up position; Y, Z Mode means the EUT in lied-on position.



Operation Mode: TX / CH810 / Y Mode / GPRS / Adapter / Open Test Date: March 29, 2004

Temperature: 25°C

Tested by: Chris Hsieh

Humidity: 55 % RH

Polarity: Ver. / Hor.

Frequency (MHz)	Reading level (dBuV)	Antenna Polarization	S.G. (dBm)	Cable loss (dB)	Ant.Gain (dBi)	Emission level (dBm)	Limit (dBm)	Margin (dB)
3819.68	51.93	V	-43.52	6.41	9.34	-40.59	-13.00	-27.59
5729.71	49.93	V	-40.32	8.23	10.52	-38.02	-13.00	-25.02
7639.17	50.52	V	-34.74	9.66	10.53	-33.86	-13.00	-20.86
9549.22	52.93	V	-29.73	10.52	11.62	-28.64	-13.00	-15.64
11450.26	50.35	V	-28.00	12.01	12.03	-27.98	-13.00	-14.98

3817.50	49.39	H	-45.23	6.41	9.34	-42.30	-13.00	-29.30
5275.36	49.10	H	-41.96	7.92	10.30	-39.58	-13.00	-26.58
7634.54	49.77	H	-35.49	9.66	10.53	-34.61	-13.00	-21.61
9545.13	50.43	H	-32.06	10.52	11.62	-30.97	-13.00	-17.97
11450.40	50.35	H	-28.00	12.01	12.03	-27.98	-13.00	-14.98

Notes:

1. Measuring frequencies from 30 MHz to the 10th harmonic of highest fundamental frequency.
2. Data of measurement within this frequency range shown " --- " in the table above means the reading of emissions are attenuated more than 20dB below the permissible limits or the field strength is too small to be measured.
3. Spectrum Setting:
30MHz- 1GHz, RBW= 100KHz, VBW= 100kHz, Sweep time= 200 ms.
1GHz- 26GHz, RBW= 1MHz, VBW= 1MHz, Sweep time= 200 ms.
4. X Mode means the EUT in stand-up position; Y, Z Mode means the EUT in lied-on position.

7.6 FREQUENCY STABILITY V.S. TEMPERATURE MEASUREMENT

LIMIT

According to FCC §2.1055, FCC §24.235.

Frequency Tolerance: 2.5 ppm

MEASUREMENT EQUIPMENT USED

Name of Equipment	Manufacturer	Model	Serial Number	Calibration Due
DC Power Source	Agilent	E3640A	MY40001774	01/12/2005
Temperature Chamber	K.son	THS-M1	242	03/20/2005
Spectrum Analyzer	Agilent	E4446A	US42510252	04/27/2004

Remark: Each piece of equipment is scheduled for calibration once a year.

Test Configuration

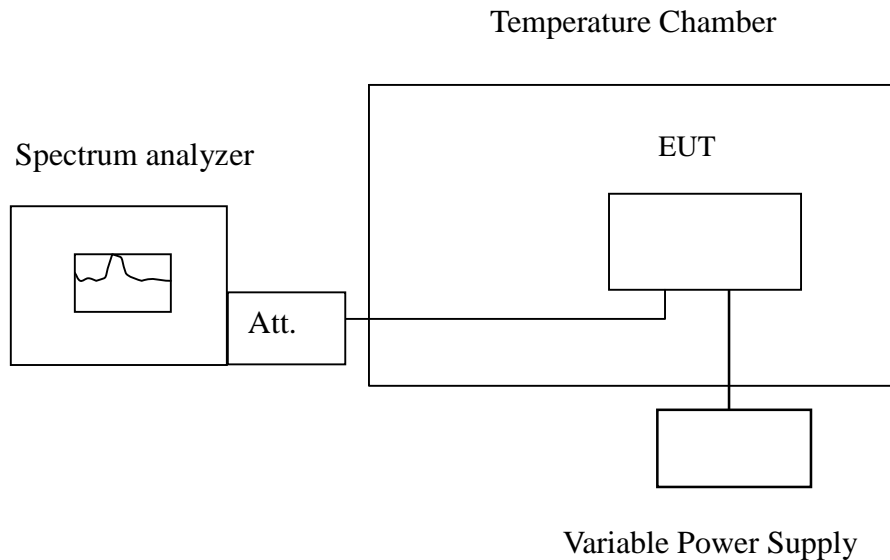

Note: Measurement setup for testing on Antenna connector



TEST PROCEDURE

The equipment under test was connected to an external AC or DC power supply and input rated voltage. RF output was connected to a frequency counter or spectrum analyzer via feed through attenuators. The EUT was placed inside the temperature chamber. Set the spectrum analyzer RBW low enough to obtain the desired frequency resolution and measure EUT 20°C operating frequency as reference frequency. Turn EUT off and set the chamber temperature to -30°C. After the temperature stabilized for approximately 30 minutes recorded the frequency. Repeat step measure with 10°C increased per stage until the highest temperature of +50°C reached.

TEST RESULTS

No non-compliance noted.

Reference Frequency: GSM Mid Channel 1880 MHz @ 20°C				
Limit: ± 2.5 ppm = 4700 Hz				
Power Supply Vdc	Environment Temperature (°C)	Frequency (MHz)	Delta (Hz)	Limit (Hz)
3.7	50	1880000014	23.00	4700
	40	1880000040	49.00	
	30	1880000031	40.00	
	20	1879999991	0.00	
	10	1880000021	30.00	
	0	1879999979	-12.00	
	-10	1879999965	-26.00	
	-20	1880000015	24.00	
	-30	1879999984	-7.00	

7.7 FREQUENCY STABILITY V.S. VOLTAGE MEASUREMENT

LIMIT

According to FCC §2.1055, FCC §24.235,

Frequency Tolerance: 2.5 ppm.

MEASUREMENT EQUIPMENT USED

Name of Equipment	Manufacturer	Model	Serial Number	Calibration Due
DC Power Source	Agilent	E3640A	MY40001774	01/12/2005
Temperature Chamber	K.son	THS-M1	242	05/26/2004
Spectrum Analyzer	Agilent	E4446A	US42510252	04/27/2004

Remark: Each piece of equipment is scheduled for calibration once a year.

Test Configuration

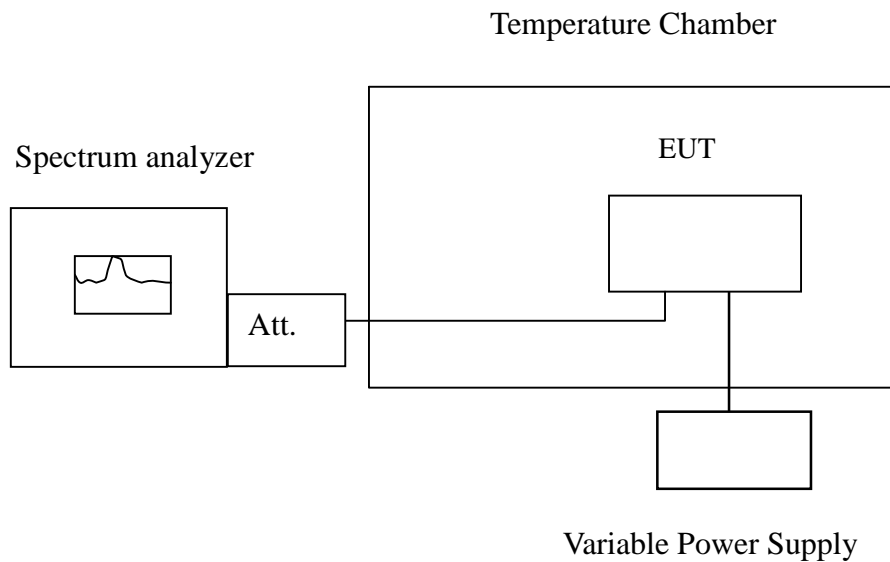

Note: Measurement setup for testing on Antenna connector



TEST PROCEDURE

Set chamber temperature to 20°C. Use a variable AC power supply / DC power source to power the EUT and set the voltage to rated voltage. Set the spectrum analyzer RBW low enough to obtain the desired frequency resolution and recorded the frequency.

Reduce the input voltage to specify extreme voltage variation (± 15%) and endpoint, record the maximum frequency change.

TEST RESULTS

No non-compliance noted.

Reference Frequency: GSM Mid Channel 1880 MHz @ 20°C				
Limit: ± 2.5 ppm = 4700 Hz				
Power Supply Vdc	Environment Temperature (°C)	Frequency (MHz)	Delta (Hz)	Limit (Hz)
4.3	20	1880000017	26	4700
3.7		1879999991	0	
3.14		1880000020	29	
2.8 (End Point)		1879999914	-77	



7.8 POWERLINE CONDUCTED EMISSIONS

LIMIT

For an intentional radiator which is designed to be connected to the public utility (AC) power line, the radio frequency voltage that is conducted back onto the AC power line on any frequency or frequencies within the band 150 kHz to 30 MHz shall not exceed 250 microvolts (The limit decreases linearly with the logarithm of the frequency in the range 0.15 MHz to 0.50 MHz). The limits at specific frequency range is listed as follows:

Frequency Range (MHz)	Limits (dBµV)	
	Quasi-peak	Average
0.15 to 0.50	66 to 56	56 to 46
0.50 to 5	56	46
5 to 30	60	50

Compliance with this provision shall be based on the measurement of the radio frequency voltage between each power line (LINE and NEUTRAL) and ground at the power terminals.

MEASUREMENT EQUIPMENT USED

Name of Equipment	Manufacturer	Model	Serial Number	Calibration Due
EMI Test Receiver	R&S	ESCS30	847793/012	12/20/2005
LISN	R&S	ESH2-Z5	843285/010	12/15/2005
LISN	EMCO	3825/2	9003-1628	07/25/2004

Remark: Each piece of equipment is scheduled for calibration once a year.



Test Configuration

1. The conducted emission tests were performed in the test site, using the setup in accordance with the ANSI C63.4-2001.
2. The EUT was plug-in the host PC via USB port. The host PC system was placed on the center of the back edge on the test table. The peripherals like modem, monitor printer, K/B, and mouse were placed on the side of the host PC system. The rear of the EUT and peripherals were placed flushed with the rear of the tabletop.
3. The keyboard was placed directly in the front of the monitor, flushed with the front tabletop. The mouse was placed next to the Keyboard, flushed with the back of keyboard.
4. The spacing between the peripherals was 10 centimeters.
5. External I/O cables were draped along the edge of the test table and bundle when necessary.
6. The host PC system was connected with 110Vac/60Hz power source.

The EUT is set to transmit in a continuous mode.

Test Procedure

1. The EUT was placed on a table, which is 0.8m above ground plane.
2. Maximum procedure was performed on the six highest emissions to ensure EUT compliance.
3. Repeat above procedures until all frequency measured were complete.

**TEST RESULTS**

The initial step in collecting conducted data is a spectrum analyzer peak scan of the measurement range. Significant peaks are then marked as shown on the following data page, and these signals are then quasi-peaked.

Operation Mode: Normal operating **Test Date:** March 29, 2004
Temperature: 28°C **Tested by:** Chris Hsieh
Humidity: 55 % RH

Frequency MHz	Q.P. Raw dBuV	AVG Raw dBuV	Q.P. Limit dBuV	AVG Limit dBuV	Q.P. Margin dB	AVG Margin dB	NOTE
0.190	48.60	---	63.10	53.10	-14.50	---	L1
0.280	46.60	30.30	56.00	46.00	-9.40	-15.70	L1
0.390	44.30	27.50	56.00	46.00	-11.70	-18.50	L1
0.520	40.30	---	56.00	46.00	-15.70	---	L1
0.925	38.70	---	60.00	50.00	-21.30	---	L1
2.390	34.20	---	60.00	50.00	-25.80	---	L1
0.170	55.00	37.20	63.20	53.20	-8.20	-16.00	L2
0.340	48.70	34.40	56.00	46.00	-7.30	-11.60	L2
0.680	44.00	33.20	56.00	46.00	-12.00	-12.80	L2
0.845	37.00	---	60.00	50.00	-23.00	---	L2
1.350	36.00	---	56.00	46.00	-20.00	---	L2
2.700	34.50	---	60.00	50.00	-25.50	---	L2

Note:

1. Measuring frequencies from 0.15 MHz to 30MHz.
2. The emissions measured in frequency range from 0.15 MHz to 30MHz were made with an instrument using Quasi-peak detector and average detector.
3. “---” denotes the emission level was or more than 2dB below the Average limit.
4. The IF bandwidth of SPA between 0.15MHz to 30MHz was 10kHz; the IF bandwidth of Test Receiver between 0.15MHz to 30MHz was 9kHz;
5. L1 = Line One (Live Line) / L2 = Line Two (Neutral Line)



Test Plots

Conducted emissions (Line 1)

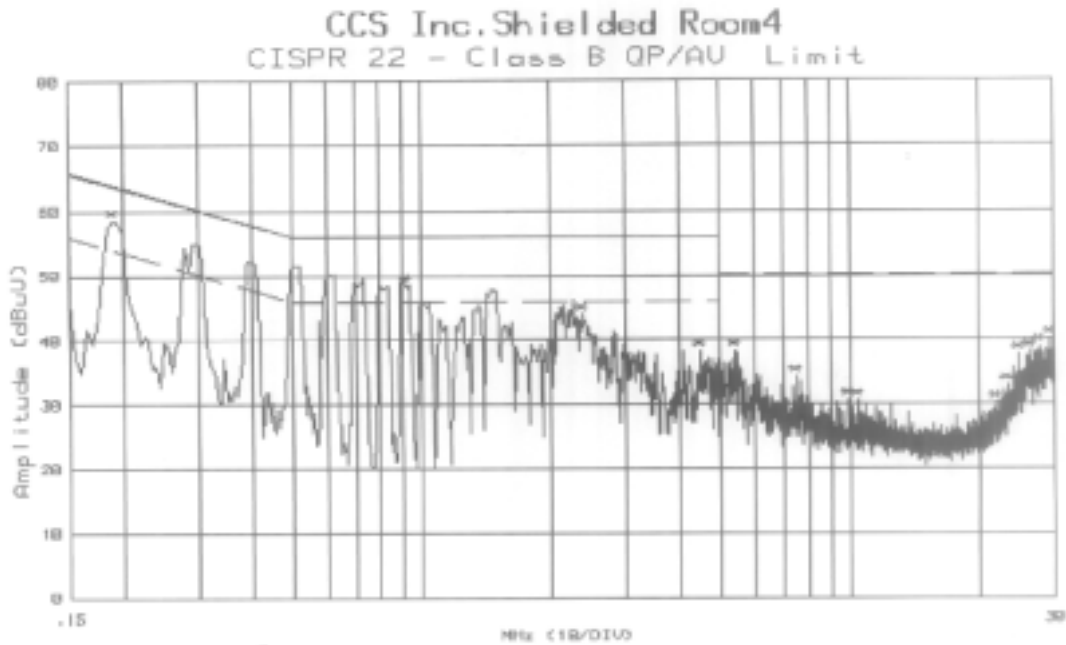

Conducted emissions (Line 2)

