

**FCC 47 CFR PART 15 SUBPART C
INDUSTRY CANADA RSS-216**

TEST REPORT

For

Tablet

Model: C1502W

Trade Name: N/A

Issued to

Quanta Computer Inc.

No.188, Wenhua 2nd Rd., Guishan Dist., Taoyuan City 33377, Taiwan (R.O.C.)

Issued by

Compliance Certification Services Inc.

**No.11, Wugong 6th Rd., Wugu Dist.,
New Taipei City 24891, Taiwan. (R.O.C.)**

<http://www.ccsrf.com>

service@ccsrf.com

Issued Date: August 20, 2015



Note: This report shall not be reproduced except in full, without the written approval of Compliance Certification Services Inc. This document may be altered or revised by Compliance Certification Services Inc. personnel only, and shall be noted in the revision section of the document.

Revision History

Rev.	Issue Date	Revisions	Effect Page	Revised By
00	August 20, 2015	Initial Issue	ALL	Doris Chu
01	September 21, 2015	1. Removed RSS-210 rules. 2. Modify test date and added test plots. 3. Added 99% data.	P.1, P.4, P.14, P.18 P.6. P.13,	Doris Chu
02	September 22, 2015	1. Modify 99% test procedure. 2. Remove band edges limit.	P.13, P.15	Doris Chu

TABLE OF CONTENTS

1. TEST RESULT CERTIFICATION	4
2. EUT DESCRIPTION.....	5
3. TEST METHODOLOGY.....	6
3.1 EUT CONFIGURATION.....	6
3.2 EUT EXERCISE.....	6
3.3 GENERAL TEST PROCEDURES.....	6
3.4 FCC PART 15.205 RESTRICTED BANDS OF OPERATIONS	7
3.5 DESCRIPTION OF TEST MODES.....	7
4. INSTRUMENT CALIBRATION	8
4.1 MEASURING INSTRUMENT CALIBRATION.....	8
4.2 MEASUREMENT EQUIPMENT USED.....	8
4.3 MEASUREMENT UNCERTAINTY.....	9
5. FACILITIES AND ACCREDITATIONS	10
5.1 FACILITIES.....	10
5.2 EQUIPMENT.....	10
5.3 TABLE OF ACCREDITATIONS AND LISTINGS.....	11
6. SETUP OF EQUIPMENT UNDER TEST	12
6.1 SETUP CONFIGURATION OF EUT	12
6.2 SUPPORT EQUIPMENT	12
7. FCC PART 15.209 & RSS-216 REQUIREMENTS	13
7.1 99% BANDWIDTH	13
7.2 RADIATED EMISSIONS.....	15
7.3 POWERLINE CONDUCTED EMISSIONS.....	19
APPENDIX I PHOTOGRAPHS OF TEST SETUP.....	22
APPENDIX 1 - PHOTOGRAPHS OF EUT	

1. TEST RESULT CERTIFICATION

Applicant: Quanta Computer Inc.
No.188, Wenhua 2nd Rd., Guishan Dist., Taoyuan City 33377,
Taiwan (R.O.C.)

Equipment Under Test: Tablet

Trade Name: N/A

Model: C1502W

Date of Test: August 17 ~ September 19, 2015

APPLICABLE STANDARDS	
STANDARD	TEST RESULT
FCC 47 CFR Part 15 Subpart C INDUSTRY CANADA RSS-216	No non-compliance noted

We hereby certify that:

The above equipment was tested by Compliance Certification Services Inc. The test data, data evaluation, test procedures, and equipment configurations shown in this report were made in accordance with the procedures given in ANSI C63.10: 2013 and the energy emitted by the sample tested as described in this report is in compliance with the requirements of FCC Rules Part 15.207, 15.209.

The test results of this report relate only to the tested sample identified in this report.

Approved by:

Reviewed by:



Miller Lee
Manager
Compliance Certification Services Inc.

Angel Cheng
Section Manager
Compliance Certification Services Inc.

2. EUT DESCRIPTION

Product	Tablet		
Trade Name	N/A		
Model Number	C1502W		
Model Difference	N/A		
Received Date	August 5, 2015		
Power Supply	1.VDC from Power Adapter Model: GL0102 I/P: 100-240V, 0.4A, 50-60Hz O/P: 5V / 3A 2. Powered from battery Model: C1552B 3.8Vdc, 34.2Wh, 9050mAh		
Battery	ATL	Model	C1552B
	Lishen	Model	C1552B
Frequency Range	1MHz		
Number of Channels	1 Channel		
Antenna Designation	Electromagnetic coil		

Remark:

1. The sample selected for test was engineering sample that approximated to production product and was provided by manufacturer.
2. This submittal(s) (test report) is intended for **FCC ID: HFS-R & IC: 1787B-R** filing to comply with Section 15.209 of the FCC Part 15, Subpart C Rules.

3. TEST METHODOLOGY

The tests documented in this report were performed in accordance with ANSI C63.10: 2013 and FCC CFR 47 Part 2, 15.207, 15.209.

The tests documented in this report were performed in accordance with IC RSS-216, IC RSS-Gen.

3.1 EUT CONFIGURATION

The EUT configuration for testing is installed on RF field strength measurement to meet the Commissions requirement and operating in a manner that intends to maximize its emission characteristics in a continuous normal application.

3.2 EUT EXERCISE

The EUT was operated in the engineering mode to fix the TX frequency that was for the purpose of the measurements.

3.3 GENERAL TEST PROCEDURES

Conducted Emissions

The EUT is placed on the turntable, which is 0.8 m above ground plane. According to the requirements in ANSI C63.10: 2013, Conducted emissions from the EUT measured in the frequency range between 0.15 MHz and 30MHz using CISPR Quasi-peak and average detector modes.

Radiated Emissions

The EUT is placed on a turn table, which is 0.8 m above ground plane. The turntable shall rotate 360 degrees to determine the position of maximum emission level. EUT is set 3m away from the receiving antenna, which varied from 1m to 4m to find out the highest emission. And also, each emission was to be maximized by changing the polarization of receiving antenna both horizontal and vertical. In order to find out the maximum emissions, exploratory radiated emission measurements were made according to the requirements in ANSI C63.10: 2013.

3.4 FCC PART 15.205 RESTRICTED BANDS OF OPERATIONS

(a) Except as shown in paragraph (d) of this section, only spurious emissions are permitted in any of the frequency bands listed below:

MHz	MHz	MHz	GHz
0.090 - 0.110	16.42 - 16.423	399.9 - 410	4.5 - 5.15
¹ 0.495 - 0.505	16.69475 - 16.69525	608 - 614	5.35 - 5.46
2.1735 - 2.1905	16.80425 - 16.80475	960 - 1240	7.25 - 7.75
4.125 - 4.128	25.5 - 25.67	1300 - 1427	8.025 - 8.5
4.17725 - 4.17775	37.5 - 38.25	1435 - 1626.5	9.0 - 9.2
4.20725 - 4.20775	73 - 74.6	1645.5 - 1646.5	9.3 - 9.5
6.215 - 6.218	74.8 - 75.2	1660 - 1710	10.6 - 12.7
6.26775 - 6.26825	108 - 121.94	1718.8 - 1722.2	13.25 - 13.4
6.31175 - 6.31225	123 - 138	2200 - 2300	14.47 - 14.5
8.291 - 8.294	149.9 - 150.05	2310 - 2390	15.35 - 16.2
8.362 - 8.366	156.52475 -	2483.5 - 2500	17.7 - 21.4
8.37625 - 8.38675	156.52525	2655 - 2900	22.01 - 23.12
8.41425 - 8.41475	156.7 - 156.9	3260 - 3267	23.6 - 24.0
12.29 - 12.293	162.0125 - 167.17	3332 - 3339	31.2 - 31.8
12.51975 - 12.52025	167.72 - 173.2	3345.8 - 3358	36.43 - 36.5
12.57675 - 12.57725	240 - 285	3600 - 4400	(²)
13.36 - 13.41	322 - 335.4		

¹ Until February 1, 1999, this restricted band shall be 0.490-0.510 MHz.

² Above 38.6

(b) Except as provided in paragraphs (d) and (e), the field strength of emissions appearing within these frequency bands shall not exceed the limits shown in Section 15.209. At frequencies equal to or less than 1000 MHz, compliance with the limits in Section 15.209 shall be demonstrated using measurement instrumentation employing a CISPR quasi-peak detector. Above 1000 MHz, compliance with the emission limits in Section 15.209 shall be demonstrated based on the average value of the measured emissions. The provisions in Section 15.35 apply to these measurements.

3.5 DESCRIPTION OF TEST MODES

The EUT (model: C1502W) had been tested under engineering test mode condition and the EUT staying in continuous transmitting mode.

The field strength of spurious emission was measured in the following position: EUT stand-up position (Z axis), lie-down position (X, Y axis). The worst emission was found in stand-up position (Z axis) and the worst case was recorded.

4. INSTRUMENT CALIBRATION

4.1 MEASURING INSTRUMENT CALIBRATION

The measuring equipment, which was utilized in performing the tests documented herein, has been calibrated in accordance with the manufacturer's recommendations for utilizing calibration equipment, which is traceable to recognized national standards.

4.2 MEASUREMENT EQUIPMENT USED

Equipment Used for Emissions Measurement

Remark: Each piece of equipment is scheduled for calibration once a year and Loop Antenna is scheduled for calibration once two years.

3M Semi Anechoic Chamber				
Name of Equipment	Manufacturer	Model	Serial Number	Calibration Due
Spectrum Analyzer	Agilent	E4446A	US42510268	01/25/2016
EMI Test Receiver	R&S	ESCI	100064	06/04/2016
Loop Antenna	COM-POWER	AL-130	121051	01/26/2016
Bilog Antenna	Sunol Sciences	JB3	A030105	08/05/2016
Horn Antenna	EMCO	3117	00055165	01/26/2016
Turn Table	CCS	CC-T-1F	N/A	N.C.R
Antenna Tower	CCS	CC-A-1F	N/A	N.C.R
Controller	CCS	CC-C-1F	N/A	N.C.R
Test S/W	EZ-EMC (CCS-3A1RE)			

Conducted Emission room # B				
Name of Equipment	Manufacturer	Model	Serial Number	Calibration Due
EMI Test Receiver	R&S	ESCI	101073	09/18/2015
LISN	R&S	ENV216	101054	06/06/2016
LISN	SCHWARZBECK	NSLK 8127	8127-541	11/25/2015
Capacitive Voltage Probe	FCC	F-CVP-1	100185	03/12/2016
Test S/W	CCS-3A1-CE			

4.3 MEASUREMENT UNCERTAINTY

PARAMETER	UNCERTAINTY
Powerline Conducted Emission	+/- 1.2159
3M Semi Anechoic Chamber / 30M~200M	+/- 4.0138
3M Semi Anechoic Chamber / 200M~1000M	+/- 3.9483
3M Semi Anechoic Chamber / 1G~8G	+/- 2.5975
3M Semi Anechoic Chamber / 8G~18G	+/- 2.6112
3M Semi Anechoic Chamber / 18G~26G	+/- 2.7389
3M Semi Anechoic Chamber / 26G~40G	+/- 2.9683

Remark: This uncertainty represents an expanded uncertainty expressed at approximately the 95% confidence level using a coverage factor of $k=2$.

5. FACILITIES AND ACCREDITATIONS

5.1 FACILITIES

All measurement facilities used to collect the measurement data are located at

- No.199, Chungsen Road, Hsintien City, Taipei Hsien, Taiwan, R.O.C.
Tel: 886-2-2217-0894 / Fax: 886-2-2217-1029
- No.11, Wugong 6th Rd., Wugu Industrial Park, Taipei Hsien 248, Taiwan
Tel: 886-2-2299-9720 / Fax: 886-2-2298-4045
- No.81-1, Lane 210, Bade 2nd Rd., Luchu Hsiang, Taoyuan Hsien 338, Taiwan
Tel: 886-3-324-0332 / Fax: 886-3-324-5235

The sites are constructed in conformance with the requirements of ANSI C63.7, ANSI C63.10: 2013 and CISPR Publication 22.

5.2 EQUIPMENT



Radiated emissions are measured with one or more of the following types of linearly polarized antennas: tuned dipole, biconical, log periodic, bi-log, ridged waveguide, horn and/or Loop. Spectrum analyzers with pre-selectors and quasi-peak detectors are used to perform radiated measurements.

Conducted emissions are measured with Line Impedance Stabilization Networks and EMI Test Receivers.

Calibrated wideband preamplifiers, coaxial cables, and coaxial attenuators are also used for making measurements.

All receiving equipment conforms to CISPR Publication 16-1, "Radio Interference Measuring Apparatus and Measurement Methods."

5.3 TABLE OF ACCREDITATIONS AND LISTINGS

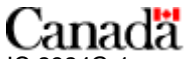
Country	Agency	Scope of Accreditation	Logo
USA	FCC	3M Semi Anechoic Chamber (FCC MRA: TW1039) to perform FCC Part 15 measurements	 FCC MRA: TW1039
Taiwan	TAF	LP0002, RTTE01, FCC Method-47 CFR Part 15 Subpart C, D, E, RSS-210, RSS-310 IDA TS SRD, AS/NZS 4268, AS/NZS 4771, TS 12.1 & 12.2, ETSI EN 300 440-1, ETSI EN 300 440-2, ETSI EN 300 328, ETSI EN 300 220-1, ETSI EN 300 220-2, ETSI EN 301 893, ETSI EN 301 489-1/3/7/17 FCC OET Bulletin 65 + Supplement C, EN 50360, EN 50361, EN 50371, RSS 102, EN 50383, EN 50385, EN 50392, IEC 62209, CNS 14958-1, CNS 14959 FCC Method -47 CFR Part 15 Subpart B IEC / EN 61000-3-2, IEC / EN 61000-3-3, IEC / EN 61000-4-2/3/4/5/6/8/11	
Canada	Industry Canada	3M Semi Anechoic Chamber (IC 2324G-1 / IC 2324G-2) to perform	 IC 2324G-1 IC 2324G-2

** No part of this report may be used to claim or imply product endorsement by A2LA or any agency of the US Government.*

6. SETUP OF EQUIPMENT UNDER TEST

6.1 SETUP CONFIGURATION OF EUT

See test photographs attached in Appendix I for the actual connections between EUT and support equipment.

6.2 SUPPORT EQUIPMENT

No.	Device Type	Brand	Model	Series No.	FCC ID	Data Cable	Power Cord
	N/A						

Remark:

1. *All the equipment/cables were placed in the worst-case configuration to maximize the emission during the test.*
2. *Grounding was established in accordance with the manufacturer's requirements and conditions for the intended use.*

7. FCC PART 15.209 & RSS-216 REQUIREMENTS

7.1 99% BANDWIDTH

TEST CONFIGURATION

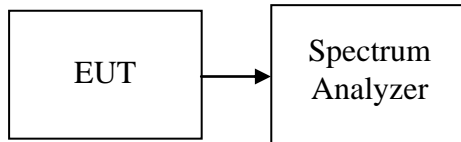

TEST PROCEDURE

1. Place the EUT on the table and set it in the transmitting mode.
2. Remove the antenna from the EUT and then connect a low loss RF cable from the antenna port to the spectrum analyzer.
3. Set the spectrum analyzer as RBW=5.1kHz, VBW = 16kHz, Span = 500kHz, Sweep = auto.
4. Record the max. reading.

TEST RESULTS

No non-compliance noted

Test Plot

Agilent

R T

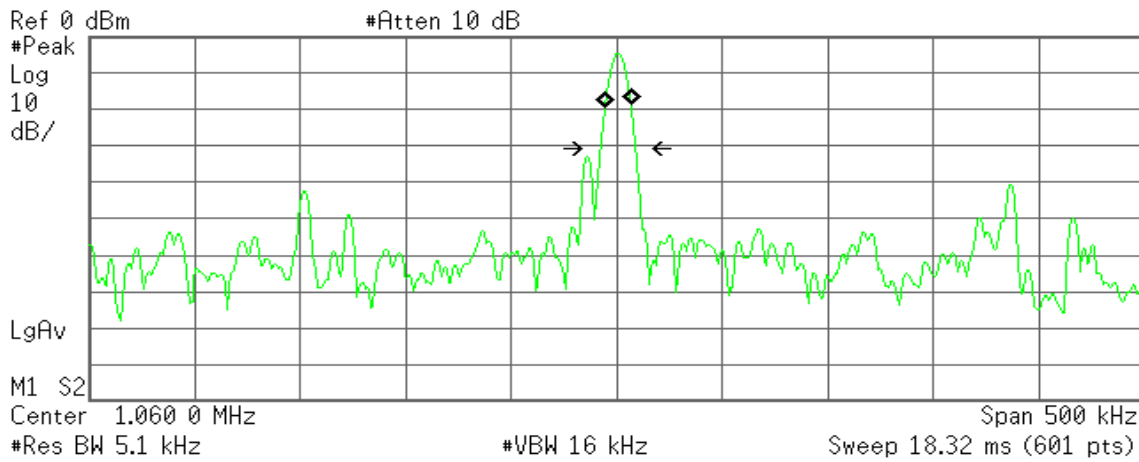

Occupied Bandwidth
13.0879 kHz

Occ BW % Pwr 99.00 %
x dB -26.00 dB

Transmit Freq Error 625.454 Hz
x dB Bandwidth 17.504 kHz

7.2 RADIATED EMISSIONS

LIMIT

1. According to §15.209(a) & RSS-Gen, except as provided elsewhere in this Subpart, the emissions from an intentional radiator shall not exceed the field strength levels specified in the following table:

Frequency (MHz)	Field Strength ($\mu\text{V}/\text{m}$ at meter)	Measurement Distance (meter)
0.009 – 0.490	2400 / F (kHz)	300
0.490 – 1.705	24000 / F (kHz)	30
1.705 – 30.0	30	30
30 - 88	100**	3
88-216	150**	3
216-960	200**	3
Above 960	500	3

Remark: Except as provided in paragraph (g), fundamental emissions from intentional radiators operating under this Section shall not be located in the frequency bands 54-72 MHz, 76-88 MHz, 174-216 MHz or 470-806 MHz. However, operation within these frequency bands is permitted under other sections of this Part, e.g., Sections 15.231 and 15.241.

Test Configuration

9kHz ~ 30MHz

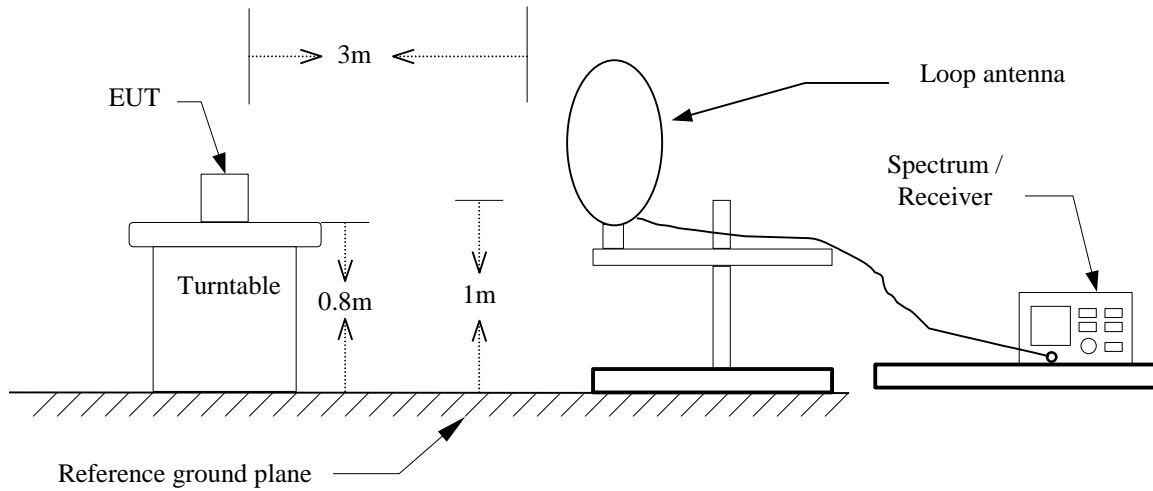

30MHz ~ 1GHz

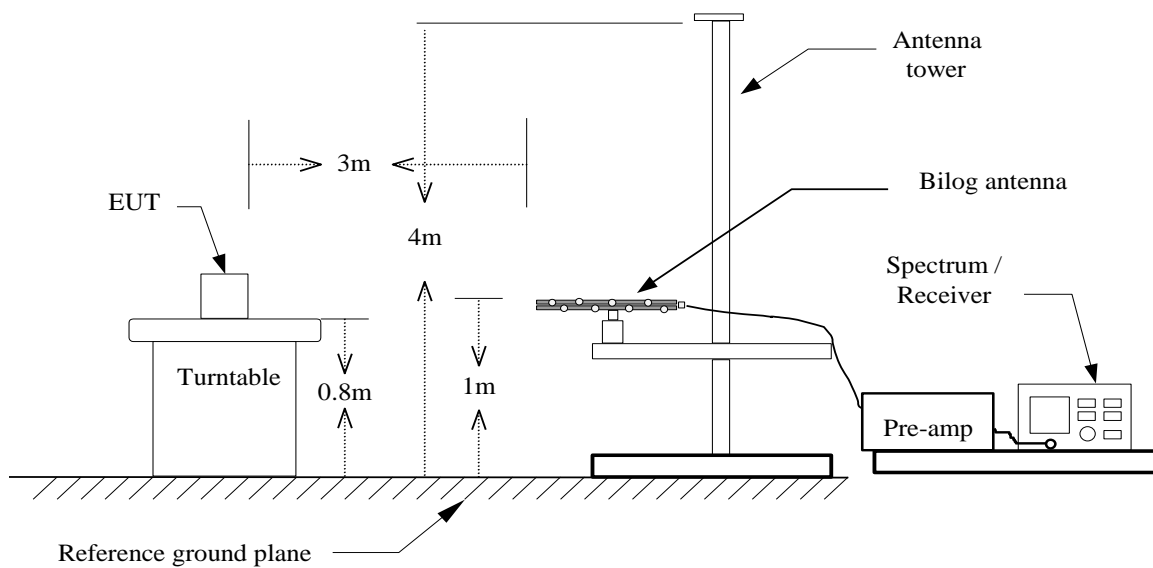

TEST PROCEDURE

1. The EUT is placed on a turntable, which is 0.8m above ground plane.
2. The turntable shall be rotated for 360 degrees to determine the position of maximum emission level.
3. EUT is set 3m away from the receiving antenna, which is varied from 1m to 4m to find out the highest emissions.
4. Maximum procedure was performed on the six highest emissions to ensure EUT compliance.
5. And also, each emission was to be maximized by changing the polarization of receiving antenna both horizontal and vertical.
6. Set the spectrum analyzer in the following setting as:
For Below 30MHz
RBW=9kHz / VBW=300kHz / Sweep=AUTO
7. Repeat above procedures until the measurements for all frequencies are complete.

For Below 30MHz

Operation Mode: TX mode **Test Date:** September 19, 2015
Temperature: 27°C **Tested by:** Jason Lu
Humidity: 53 % RH **Polarity:** Ver. / Hor.

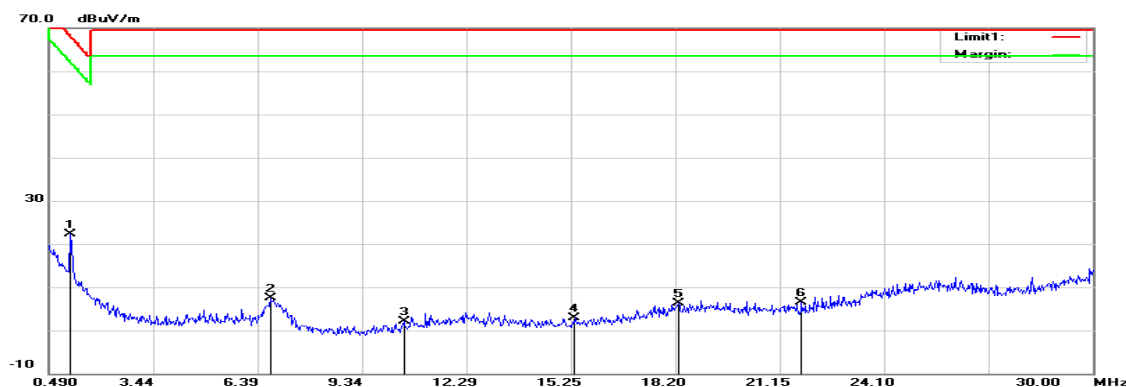
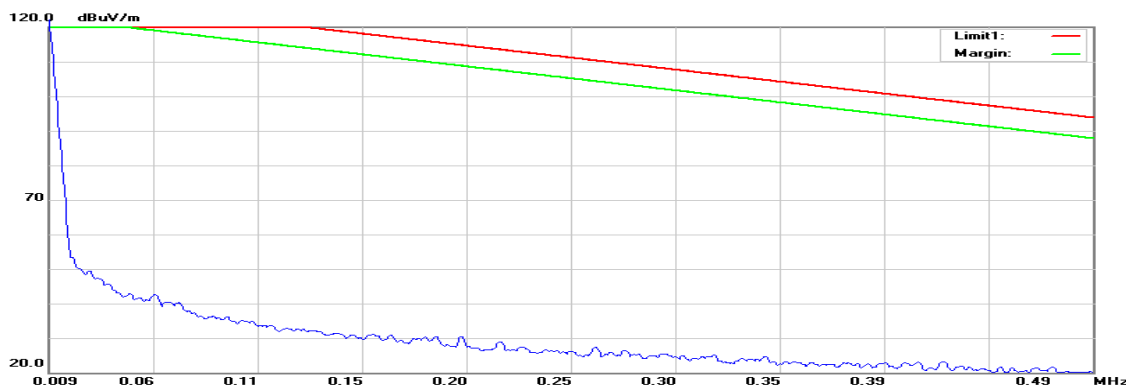

Frequency (MHz)	Reading (dBuV)	Correction Factor (dB/m)	Result (dBuV/m)	Limit 3m (dBuV/m)	Margin (dB)	Detector Mode (PK/QP/AVG)
1.0802	39.37	-17.08	22.29	68.53	-46.24	peak
6.7461	20.69	-13.17	7.52	69.50	-61.98	peak
10.5234	12.52	-10.37	2.15	69.50	-67.35	peak
15.3630	10.12	-7.29	2.83	69.50	-66.67	peak
18.2845	11.70	-5.44	6.26	69.50	-63.24	peak
21.7667	9.75	-3.34	6.41	69.50	-63.09	peak

Remark:

1. Measuring frequencies from 9kHz to the 1GHz.
2. Radiated emissions measured were made with an instrument using peak/quasi-peak/average detector mode.
3. Measurements above show only up to 6 maximum emissions noted, or would be lesser, with " N/A " remark, if no specific emissions from the EUT are recorded (ie: margin>20dB from the applicable limit) and considered that's already beyond the background noise floor.
4. Margin (dB) = Result (dBuV/m) – Limit (dBuV/m).

7.3 POWERLINE CONDUCTED EMISSIONS

LIMIT

According to §15.207(a) & RSS-Gen, except as shown in paragraphs (b) and (c) of this section, for an intentional radiator that is designed to be connected to the public utility (AC) power line, the radio frequency voltage that is conducted back onto the AC power line on any frequency or frequencies within the band 150 kHz to 30 MHz shall not exceed the limits in the following table, as measured using a 50 μ H/50 ohms line impedance stabilization network (LISN). Compliance with the provisions of this paragraph shall be based on the measurement of the radio frequency voltage between each power line and ground at the power terminal. The lower limit applies at the boundary between the frequency ranges.

Frequency Range (MHz)	Limits (dB μ V)	
	Quasi-peak	Average
0.15 to 0.50	66 to 56*	56 to 46*
0.50 to 5	56	46
5 to 30	60	50

* Decreases with the logarithm of the frequency.

TEST PROCEDURE

1. The EUT was placed on a table, which is 0.8m above ground plane.
2. Maximum procedure was performed on the six highest emissions to ensure EUT compliance.
3. Repeat above procedures until all frequency measured were complete.

TEST RESULTS

The initial step in collecting conducted data is a spectrum analyzer peak scan of the measurement range. Significant peaks are then marked as shown on the following data page, and these signals are then quasi-peaked.

Test Data

Operation Mode: Normal Link **Test Date:** August 18, 2015
Temperature: 26°C **Tested by:** Jason Lu
Humidity: 60% RH

Frequency (MHz)	QP Reading (dBuV)	AV Reading (dBuV)	Corr. factor (dB)	QP Result (dBuV)	AV Result (dBuV)	QP Limit (dBuV)	AV Limit (dBuV)	QP Margin (dB)	AV Margin (dB)	Note
0.1620	36.93	25.60	0.19	37.12	25.79	65.36	55.36	-28.24	-29.57	L1
0.1820	38.94	31.94	0.19	39.13	32.13	64.39	54.39	-25.26	-22.26	L1
0.2140	29.82	19.49	0.19	30.01	19.68	63.05	53.05	-33.04	-33.37	L1
0.3340	28.23	18.99	0.20	28.43	19.19	59.35	49.35	-30.92	-30.16	L1
0.5300	38.07	32.98	0.20	38.27	33.18	56.00	46.00	-17.73	-12.82	L1
2.3500	24.50	18.21	0.15	24.65	18.36	56.00	46.00	-31.35	-27.64	L1
0.1700	36.05	25.63	0.19	36.24	25.82	64.96	54.96	-28.72	-29.14	L2
0.1900	32.62	22.38	0.19	32.81	22.57	64.04	54.04	-31.23	-31.47	L2
0.5220	42.85	33.43	0.19	43.04	33.62	56.00	46.00	-12.96	-12.38	L2
1.1260	29.44	20.51	0.19	29.63	20.70	56.00	46.00	-26.37	-25.30	L2
2.7700	24.23	14.69	0.14	24.37	14.83	56.00	46.00	-31.63	-31.17	L2
6.3300	21.67	11.30	0.26	21.93	11.56	60.00	50.00	-38.07	-38.44	L2

Remark:

1. Measuring frequencies from 0.15 MHz to 30MHz.
2. The emissions measured in frequency range from 0.15 MHz to 30MHz were made with an instrument using Quasi-peak detector and average detector.
3. The IF bandwidth of SPA between 0.15MHz to 30MHz was 10kHz; the IF bandwidth of Test Receiver between 0.15MHz to 30MHz was 9kHz;
4. L1 = Line One (Live Line) / L2 = Line Two (Neutral Line)
5. "-" means Quasi-peak reading value also meets average limit and measurement with the average detector is unnecessary.

Test Plots

Conducted emissions (Line 1)

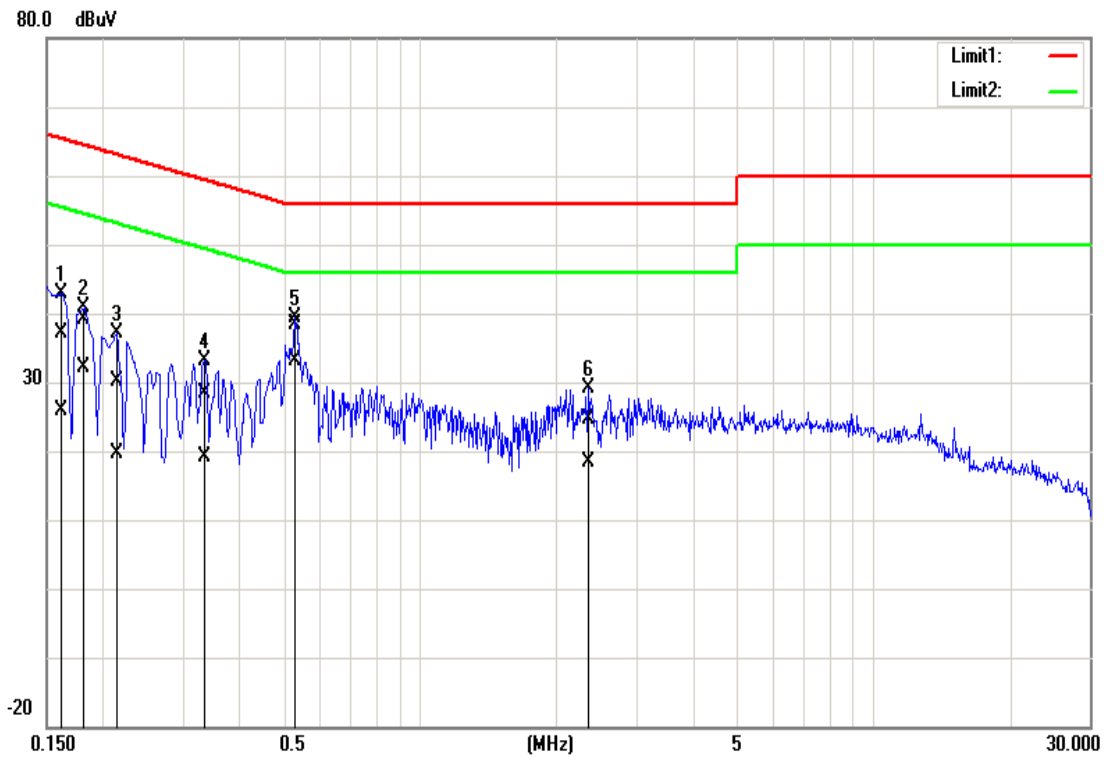

Conducted emissions (Line 2)

