

SAR TEST REPORT

Equipment Under Test	Tablet PC
Model Number of Host	QV3** (The "*" can be 0-9,A-Z or blank for the marketing purpose)
Mode of Operation	WLAN 802.11 b/g/n band
FCC ID	HFS-QV3
Company Name	Quanta Computer Inc
Company Address	188, Wen Hwa 2nd Rd., Kuei Shan Hsiang, Tao Yuan Hsien, 333 Taiwan
Date of Receipt	2010.12.16
Date of Test(s)	2011.01.20
Date of Issue	2011.02.11

Standards:

**FCC OET 65 supplement C,
IEEE /ANSI C95.1, C95.3, IEEE 1528**

In the configuration tested, the EUT complied with the standards specified above.

Remarks:

This report details the results of the testing carried out on one sample, the results contained in this test report do not relate to other samples of the same product. The manufacturer should ensure that all products in series production are in conformity with the product sample detailed in this report.

This report may only be reproduced and distributed in full. If the product in this report is used in any configuration other than that detailed in the report, the manufacturer must ensure the new system complies with all relevant standards. Any mention of SGS Taiwan Electronic & Communication Laboratory or testing done by SGS Taiwan Electronic & Communication Laboratory in connection with distribution or use of the product described in this report must be approved by SGS Taiwan Electronic & Communication Laboratory in writing.

Tested by : Antony Wu
Engineer

Antony Wu

Date : 2011.02.11

Approved by : Kelly Tsai
Supervisor

Kelly Tsai

Date : 2011.02.11

Unless otherwise stated the results shown in this test report refer only to the sample(s) tested and such sample(s) are retained for 90 days only.
除非另有說明，此報告結果僅對測試之樣品負責，同時此樣品僅保留90天。本報告未經本公司書面許可，不可部份複製。

This document is issued by the Company subject to its General Conditions of Service printed overleaf, available on request or accessible at www.sgs.com/terms_and_conditions.htm and, for electronic format documents, subject to Terms and Conditions for Electronic Documents at www.sgs.com/terms_e-document.htm. Attention is drawn to the limitation of liability, indemnification and jurisdiction issues defined therein. Any holder of this document is advised that information contained hereon reflects the Company's findings at the time of its intervention only and within the limits of Client's instructions, if any. The Company's sole responsibility is to its Client and this document does not exonerate parties to a transaction from exercising all their rights and obligations under the transaction documents. This document cannot be reproduced except in full, without prior written approval of the Company. Any unauthorized alteration, forgery or falsification of the content or appearance of this document is unlawful and offenders may be prosecuted to the fullest extent of the law.

Version

Version No.	Date	Description
1.0	Jan. 26, 2011	Initial issue of report
1.1	Feb. 11, 2011	Modify 1 st report

Unless otherwise stated the results shown in this test report refer only to the sample(s) tested and such sample(s) are retained for 90 days only.

除非另有說明，此報告結果僅對測試之樣品負責，同時此樣品僅保留90天。本報告未經本公司書面許可，不可部份複製。

This document is issued by the Company subject to its General Conditions of Service printed overleaf, available on request or accessible at www.sgs.com/terms_and_conditions.htm and, for electronic format documents, subject to Terms and Conditions for Electronic Documents at www.sgs.com/terms_e-document.htm. Attention is drawn to the limitation of liability, indemnification and jurisdiction issues defined therein. Any holder of this document is advised that information contained hereon reflects the Company's findings at the time of its intervention only and within the limits of Client's instructions, if any. The Company's sole responsibility is to its Client and this document does not exonerate parties to a transaction from exercising all their rights and obligations under the transaction documents. This document cannot be reproduced except in full, without prior written approval of the Company. Any unauthorized alteration, forgery or falsification of the content or appearance of this document is unlawful and offenders may be prosecuted to the fullest extent of the law.

Contents

1. General Information	4
1.1 Testing Laboratory	4
1.2 Details of Applicant	4
1.3 Description of EUT	4
1.4 Test Environment	6
1.5 Operation description	7
1.6 The SAR Measurement System	7
1.7 System Components	9
1.8 SAR System Verification	11
1.9 Tissue Simulant Fluid for the Frequency Band	12
1.10 Evaluation Procedures	13
1.11 Test Standards and Limits	14
2. Summary of Results	17
3. Instruments List	20
4. Measurements	21
5. SAR System Performance Verification	40
6. DAE & Probe Calibration certificate	41
7. Uncertainty Budget	53
8. Phantom Description	54
9. System Validation from Original equipment supplier	55

Unless otherwise stated the results shown in this test report refer only to the sample(s) tested and such sample(s) are retained for 90 days only.
 除非另有說明，此報告結果僅對測試之樣品負責，同時此樣品僅保留90天。本報告未經本公司書面許可，不可部份複製。

This document is issued by the Company subject to its General Conditions of Service printed overleaf, available on request or accessible at www.sgs.com/terms_and_conditions.htm and, for electronic format documents, subject to Terms and Conditions for Electronic Documents at www.sgs.com/terms_e-document.htm. Attention is drawn to the limitation of liability, indemnification and jurisdiction issues defined therein. Any holder of this document is advised that information contained hereon reflects the Company's findings at the time of its intervention only and within the limits of Client's instructions, if any. The Company's sole responsibility is to its Client and this document does not exonerate parties to a transaction from exercising all their rights and obligations under the transaction documents. This document cannot be reproduced except in full, without prior written approval of the Company. Any unauthorized alteration, forgery or falsification of the content or appearance of this document is unlawful and offenders may be prosecuted to the fullest extent of the law.

1. General Information

1.1 Testing Laboratory

SGS Taiwan Ltd. Electronics & Communication Laboratory	
134, Wu Kung Road, Wuku industrial zone	
Taipei county, Taiwan, R.O.C.	
Telephone	+886-2-2299-3279
Fax	+886-2-2298-0488
Internet	http://www.tw.sgs.com

Testing Location	1F, No.8, Alley 15, Lane 120, Sec .1, NeiHu Road NeiHu District Taipei City 114, Taiwan
------------------	---

1.2 Details of Applicant

Name	Quanta Computer Inc
Address	188, Wen Hwa 2nd Rd., Kuei Shan Hsiang, Tao Yuan Hsien, 333 Taiwan
Contact Person	Any Zhu
Tel	86-21-37748168
Fax	86-21-67747135
Email address	Any.Zhu@quantacn.com

1.3 Description of EUT

EUT Name	Tablet PC
Model Number of Host	QV3** (The "*" can be 0-9, A-Z or blank for the marketing purpose)

Unless otherwise stated the results shown in this test report refer only to the sample(s) tested and such sample(s) are retained for 90 days only.
 除非另有說明，此報告結果僅對測試之樣品負責，同時此樣品僅保留90天。本報告未經本公司書面許可，不可部份複製。

This document is issued by the Company subject to its General Conditions of Service printed overleaf, available on request or accessible at www.sgs.com/terms_and_conditions.htm and, for electronic format documents, subject to Terms and Conditions for Electronic Documents at www.sgs.com/terms_e-document.htm. Attention is drawn to the limitation of liability, indemnification and jurisdiction issues defined therein. Any holder of this document is advised that information contained hereon reflects the Company's findings at the time of its intervention only and within the limits of Client's instructions, if any. The Company's sole responsibility is to its Client and this document does not exonerate parties to a transaction from exercising all their rights and obligations under the transaction documents. This document cannot be reproduced except in full, without prior written approval of the Company. Any unauthorized alteration, forgery or falsification of the content or appearance of this document is unlawful and offenders may be prosecuted to the fullest extent of the law.

FCC ID	HFS-QV3
Definition	Production unit
Mode of Operation	WLAN 802.11 b/g/n band
Duty Cycle	WLAN 802.11 b/g/n
	1
TX Frequency range (MHz)	WLAN802.11 b/g/n(20M)
	2412-2472
Channel Number (ARFCN)	WLAN802.11 b/g/n(20M)
	1-13
Max. SAR Measured (1g)	WLAN802.11b
	1.11W/kg (WLAN802.11b_ CH6_ Configuration 1)
	WLAN802.11g
	1.08W/kg (WLAN802.11g_ CH6_ Configuration 1)
	WLAN802.11n (20M)
	0.986W/kg (WLAN802.11n(20M)_ CH6_ Configuration 1)

Note:

- The 1-g SAR for the highest output channel is less than 0.8 W/kg, where the transmission band corresponding to all channels is ≤ 100 MHz, testing for the other channels is not required.

Unless otherwise stated the results shown in this test report refer only to the sample(s) tested and such sample(s) are retained for 90 days only.
 除非另有說明，此報告結果僅對測試之樣品負責，同時此樣品僅保留90天。本報告未經本公司書面許可，不可部份複製。

This document is issued by the Company subject to its General Conditions of Service printed overleaf, available on request or accessible at www.sgs.com/terms_and_conditions.htm and, for electronic format documents, subject to Terms and Conditions for Electronic Documents at www.sgs.com/terms_e-document.htm. Attention is drawn to the limitation of liability, indemnification and jurisdiction issues defined therein. Any holder of this document is advised that information contained hereon reflects the Company's findings at the time of its intervention only and within the limits of Client's instructions, if any. The Company's sole responsibility is to its Client and this document does not exonerate parties to a transaction from exercising all their rights and obligations under the transaction documents. This document cannot be reproduced except in full, without prior written approval of the Company. Any unauthorized alteration, forgery or falsification of the content or appearance of this document is unlawful and offenders may be prosecuted to the fullest extent of the law.

Conducted Power

EUT Mode	Frequency (MHz)	CH	AVG. Power (dBm)
WLAN802.11b	2412	1	17.31
	2437	6	16.77
	2462	11	16.38

EUT Mode	Frequency (MHz)	CH	AVG. Power (dBm)
WLAN802.11g	2412	1	17.08
	2437	6	16.68
	2462	11	16.32

EUT Mode	Frequency (MHz)	CH	AVG. Power (dBm)
WLAN802.11n 20M	2412	1	17.05
	2437	6	16.59
	2462	11	16.15

1.4 Test Environment

Ambient Temperature : $22 \pm 2^\circ \text{C}$

Tissue Simulating Liquid: $22 \pm 2^\circ \text{C}$

Unless otherwise stated the results shown in this test report refer only to the sample(s) tested and such sample(s) are retained for 90 days only.
除非另有說明，此報告結果僅對測試之樣品負責，同時此樣品僅保留90天。本報告未經本公司書面許可，不可部份複製。

This document is issued by the Company subject to its General Conditions of Service printed overleaf, available on request or accessible at www.sgs.com/terms_and_conditions.htm and, for electronic format documents, subject to Terms and Conditions for Electronic Documents at www.sgs.com/terms_e-document.htm. Attention is drawn to the limitation of liability, indemnification and jurisdiction issues defined therein. Any holder of this document is advised that information contained hereon reflects the Company's findings at the time of its intervention only and within the limits of Client's instructions, if any. The Company's sole responsibility is to its Client and this document does not exonerate parties to a transaction from exercising all their rights and obligations under the transaction documents. This document cannot be reproduced except in full, without prior written approval of the Company. Any unauthorized alteration, forgery or falsification of the content or appearance of this document is unlawful and offenders may be prosecuted to the fullest extent of the law.

1.5 Operation description

Use chipset specific software to control the EUT, and makes it transmit in maximum power. Measurements are performed respectively on the lowest, middle and highest channels of the operating band(s).

The EUT is set to maximum power level during all tests, and at the beginning of each test the battery is fully charged.

We will test it with 4 configurations:

Configuration 1: Lap-held mode. (WLAN/Main-to-user separation distance is 2mm) (Appendix-Fig.3)

Configuration 2: Secondary landscape mode.(WLAN/main-to-edge of screen distance is 6mm) (Appendix-Fig.4)

Configuration 3: Primary Landscape mode.(WLAN/main-to-edge of screen distance is 161 mm) (Appendix-Fig.5)

Configuration 4: Secondary portrait mode. (WLAN/Main-to-user separation distance is 191 mm) (Appendix-Fig.6)

Configuration 5: Primary portrait mode. (WLAN/main-to-edge of screen distance is 45mm)(Appendix-Fig.7)

1.6 The SAR Measurement System

A photograph of the SAR measurement System is given in Fig. a. This SAR Measurement System uses a Computer-controlled 3-D stepper motor system (SPEAG DASY 5 professional system). A Model EX3DV4 field probe is used to determine the internal electric fields. The SAR can be obtained from the equation $SAR = \sigma (|E_i|^2) / \rho$ where σ and ρ are the conductivity and mass density of the tissue-simulant.

Unless otherwise stated the results shown in this test report refer only to the sample(s) tested and such sample(s) are retained for 90 days only.
除非另有說明，此報告結果僅對測試之樣品負責，同時此樣品僅保留90天。本報告未經本公司書面許可，不可部份複製。

This document is issued by the Company subject to its General Conditions of Service printed overleaf, available on request or accessible at www.sgs.com/terms_and_conditions.htm and, for electronic format documents, subject to Terms and Conditions for Electronic Documents at www.sgs.com/terms_e-document.htm. Attention is drawn to the limitation of liability, indemnification and jurisdiction issues defined therein. Any holder of this document is advised that information contained hereon reflects the Company's findings at the time of its intervention only and within the limits of Client's instructions, if any. The Company's sole responsibility is to its Client and this document does not exonerate parties to a transaction from exercising all their rights and obligations under the transaction documents. This document cannot be reproduced except in full, without prior written approval of the Company. Any unauthorized alteration, forgery or falsification of the content or appearance of this document is unlawful and offenders may be prosecuted to the fullest extent of the law.

The DASY5 system for performing compliance tests consists of the following items:

- A standard high precision 6-axis robot (Staubli RX family) with controller, teach pendant and software. An arm extension is for accommodating the data acquisition electronics (DAE).
- A dosimetric probe, i.e., an isotropic E-field probe optimized and calibrated for usage in tissue simulating liquid. The probe is equipped with an optical surface detector system.
- A data acquisition electronics (DAE) which performs the signal amplification, signal multiplexing, AD-conversion, offset measurements, mechanical surface detection, collision detection, etc.

The unit is battery powered with standard or rechargeable batteries. The signal is optically transmitted to the EOC.

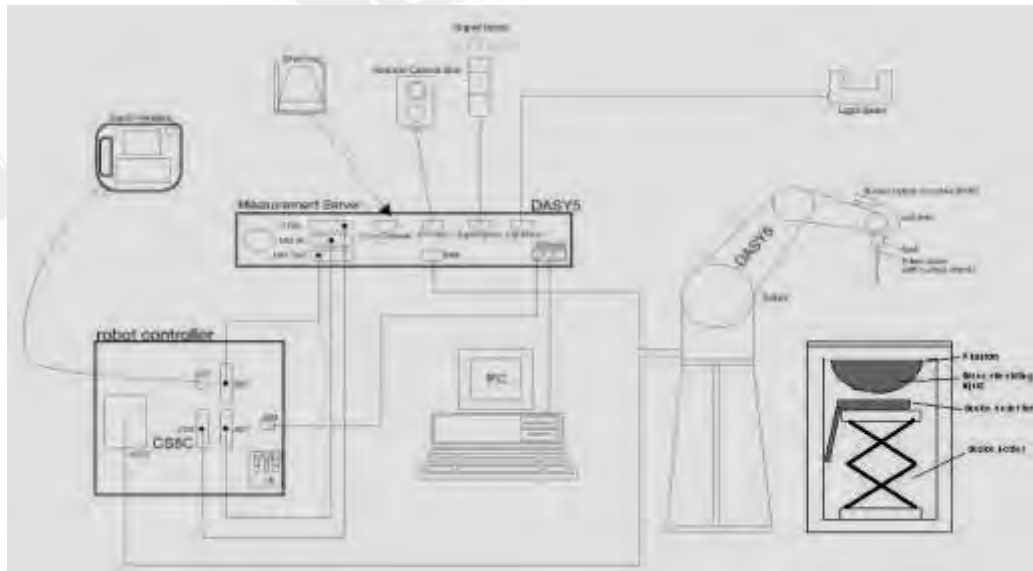

Fig.a The block diagram of SAR system

- The Electro-optical converter (EOC) performs the conversion between optical and electrical of the signals for the digital communication to the DAE and for the analog signal from the optical surface detection. The EOC is connected to the measurement server.
- The function of the measurement server is to perform the time critical tasks such as signal filtering, control of the robot operation and fast movement interrupts.

Unless otherwise stated the results shown in this test report refer only to the sample(s) tested and such sample(s) are retained for 90 days only.
 除非另有說明，此報告結果僅對測試之樣品負責，同時此樣品僅保留90天。本報告未經本公司書面許可，不可部份複製。

This document is issued by the Company subject to its General Conditions of Service printed overleaf, available on request or accessible at www.sgs.com/terms_and_conditions.htm and, for electronic format documents, subject to Terms and Conditions for Electronic Documents at www.sgs.com/terms_e-document.htm. Attention is drawn to the limitation of liability, indemnification and jurisdiction issues defined therein. Any holder of this document is advised that information contained hereon reflects the Company's findings at the time of its intervention only and within the limits of Client's instructions, if any. The Company's sole responsibility is to its Client and this document does not exonerate parties to a transaction from exercising all their rights and obligations under the transaction documents. This document cannot be reproduced except in full, without prior written approval of the Company. Any unauthorized alteration, forgery or falsification of the content or appearance of this document is unlawful and offenders may be prosecuted to the fullest extent of the law.

- A probe alignment unit which improves the (absolute) accuracy of the probe positioning.
- A computer operating Windows 2000 or Windows XP.
- DASY5 software.
- Remote control with teach pendant and additional circuitry for robot safety such as warning lamps, etc.
- The SAM twin phantom enabling testing left-hand and right-hand usage.
- The device holder for handheld mobile phones.
- Tissue simulating liquid mixed according to the given recipes.
- Validation dipole kits allowing to validate the proper functioning of the system.

1.7 System Components

EX3DV4 E-Field Probe

Construction	Symmetrical design with triangular core Built-in shielding against static charges PEEK enclosure material (resistant to organic solvents, e.g., DGBE)	
Calibration	Basic Broad Band Calibration in air Conversion Factors (CF) for MSL 2450 MHZ Additional CF for other liquids and frequencies upon request	
Frequency	10 MHz to > 6 GHz, Linearity: ± 0.2 dB (30 MHz to 6 GHz)	
Directivity	± 0.3 dB in HSL (rotation around probe axis) ± 0.5 dB in tissue material (rotation normal to probe axis)	
Dynamic Range	10 μ W/g to > 100 mW/g Linearity: ± 0.2 dB (noise: typically < 1 μ W/g)	
Dimensions	Overall length: 337 mm (Tip: 9 mm) Tip diameter: 2.5 mm (Body: 10 mm) Typical distance from probe tip to dipole centers: 1 mm	

Unless otherwise stated the results shown in this test report refer only to the sample(s) tested and such sample(s) are retained for 90 days only.
除非另有說明，此報告結果僅對測試之樣品負責，同時此樣品僅保留90天。本報告未經本公司書面許可，不可部份複製。

This document is issued by the Company subject to its General Conditions of Service printed overleaf, available on request or accessible at www.sgs.com/terms_and_conditions.htm and, for electronic format documents, subject to Terms and Conditions for Electronic Documents at www.sgs.com/terms_e-document.htm. Attention is drawn to the limitation of liability, indemnification and jurisdiction issues defined therein. Any holder of this document is advised that information contained hereon reflects the Company's findings at the time of its intervention only and within the limits of Client's instructions, if any. The Company's sole responsibility is to its Client and this document does not exonerate parties to a transaction from exercising all their rights and obligations under the transaction documents. This document cannot be reproduced except in full, without prior written approval of the Company. Any unauthorized alteration, forgery or falsification of the content or appearance of this document is unlawful and offenders may be prosecuted to the fullest extent of the law.

Application	High precision dosimetric measurements in any exposure scenario (e.g., very strong gradient fields). Only probe which enables compliance testing for frequencies up to 6 GHz with precision of better 30%.
-------------	--

SAM PHANTOM V4.0C

Construction	<p>The shell corresponds to the specifications of the Specific Anthropomorphic Mannequin (SAM) phantom defined in IEEE 1528-200X, CENELEC 50361 and IEC 62209.</p> <p>It enables the dosimetric evaluation of left and right hand phone usage as well as body mounted usage at the flat phantom region. A cover prevents evaporation of the liquid. Reference markings on the phantom allow the complete setup of all predefined phantom positions and measurement grids by manually teaching three points with the robot.</p>	
Shell Thickness	2 ± 0.2 mm	
Filling Volume	Approx. 25 liters	
Dimensions	Height: 850 mm; Length: 1000 mm; Width: 500 mm	

Unless otherwise stated the results shown in this test report refer only to the sample(s) tested and such sample(s) are retained for 90 days only.
 除非另有說明，此報告結果僅對測試之樣品負責，同時此樣品僅保留90天。本報告未經本公司書面許可，不可部份複製。

This document is issued by the Company subject to its General Conditions of Service printed overleaf, available on request or accessible at www.sgs.com/terms_and_conditions.htm and, for electronic format documents, subject to Terms and Conditions for Electronic Documents at www.sgs.com/terms_e-document.htm. Attention is drawn to the limitation of liability, indemnification and jurisdiction issues defined therein. Any holder of this document is advised that information contained hereon reflects the Company's findings at the time of its intervention only and within the limits of Client's instructions, if any. The Company's sole responsibility is to its Client and this document does not exonerate parties to a transaction from exercising all their rights and obligations under the transaction documents. This document cannot be reproduced except in full, without prior written approval of the Company. Any unauthorized alteration, forgery or falsification of the content or appearance of this document is unlawful and offenders may be prosecuted to the fullest extent of the law.

DEVICE HOLDER

Construction	The device holder (Supporter) for Notebook is made by POM (polyoxymethylene resin) , which is non-metal and non-conductive. The height can be adjusted to fit varies kind of notebooks.	 <p style="text-align: center;">Device Holder</p>
--------------	---	---

1.8 SAR System Verification

The microwave circuit arrangement for system verification is sketched in Fig. b. The daily system accuracy verification occurs within the flat section of the SAM phantom. A SAR measurement was performed to see if the measured SAR was within +/- 5% from the target SAR values. These tests were done at 2450 MHz. The tests were conducted on the same days as the measurement of the DUT. The obtained results from the system accuracy verification are displayed in the table 1 (SAR values are normalized to 1W forward power delivered to the dipole). During the tests, the ambient temperature of the laboratory was in the range 22.1°C, the relative humidity was in the range 62% and the liquid depth above the ear reference points was above 15 cm in all the cases. It is seen that the system is operating within its specification, as the results are within acceptable tolerance of the reference values.

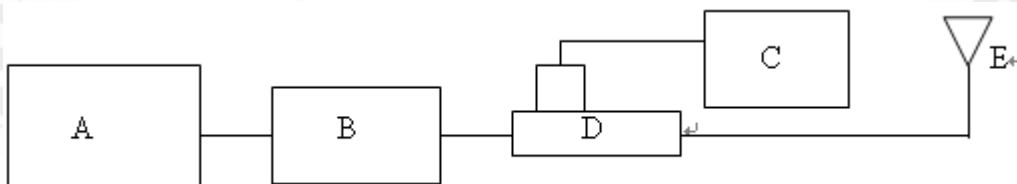
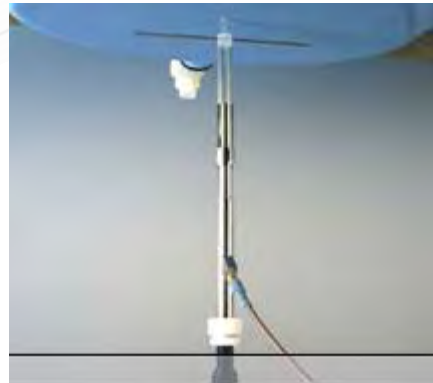

Fig.b The block diagram of system verification

Unless otherwise stated the results shown in this test report refer only to the sample(s) tested and such sample(s) are retained for 90 days only.
除非另有說明，此報告結果僅對測試之樣品負責，同時此樣品僅保留90天。本報告未經本公司書面許可，不可部份複製。

This document is issued by the Company subject to its General Conditions of Service printed overleaf, available on request or accessible at www.sgs.com/terms_and_conditions.htm and, for electronic format documents, subject to Terms and Conditions for Electronic Documents at www.sgs.com/terms_e-document.htm. Attention is drawn to the limitation of liability, indemnification and jurisdiction issues defined therein. Any holder of this document is advised that information contained hereon reflects the Company's findings at the time of its intervention only and within the limits of Client's instructions, if any. The Company's sole responsibility is to its Client and this document does not exonerate parties to a transaction from exercising all their rights and obligations under the transaction documents. This document cannot be reproduced except in full, without prior written approval of the Company. Any unauthorized alteration, forgery or falsification of the content or appearance of this document is unlawful and offenders may be prosecuted to the fullest extent of the law.

- A. Agilent Model 8648D Signal Generator
- B. Mini circuits Model ZHL-42 Amplifier
- C. Agilent Model U2001B Power Sensor
- D. Agilent Model 777D Dual directional coupling
- E. Reference dipole antenna



Photograph of the dipole Antenna

Validation Kit	Frequency Hz	Target SAR (1g) (Pin=250mW)	Measured SAR (1g)	Measured Date
D2450V2 S/N: 727	2450 MHz (Body)	13.4mW/g	13.2mW/g	2011-01-20

Table 1. Results of system validation

1.9 Tissue Simulant Fluid for the Frequency Band

The dielectric properties for this body-simulant fluid were measured by using the Agilent Model 85070D Dielectric Probe (rates frequency band 200 MHz to 20 GHz) in conjunction with HP 8753D Network Analyzer (30 KHz-6000 MHz) by using a procedure detailed in Section V.

All dielectric parameters of tissue simulates were measured within 24 hours of SAR measurements. The depth of the tissue simulant in the ear reference point of the phantom was 15cm±5mm during all tests. (Fig .2)

Frequency (MHz)	Tissue type	Measurement date/ Limits	Dielectric Parameters		
			ρ	σ (S/m)	Simulated Tissue Temperature(° C)
2450	Body	Measured, 2011.01.20	1.97	52.5	21.7
		Recommended Limits	1.91-2.11	51.49-56.91	20-24

Table 2. Dielectric Parameters of Tissue Simulant Fluid

Unless otherwise stated the results shown in this test report refer only to the sample(s) tested and such sample(s) are retained for 90 days only.
除非另有說明，此報告結果僅對測試之樣品負責，同時此樣品僅保留90天。本報告未經本公司書面許可，不可部份複製。

This document is issued by the Company subject to its General Conditions of Service printed overleaf, available on request or accessible at www.sgs.com/terms_and_conditions.htm and, for electronic format documents, subject to Terms and Conditions for Electronic Documents at www.sgs.com/terms_e-document.htm. Attention is drawn to the limitation of liability, indemnification and jurisdiction issues defined therein. Any holder of this document is advised that information contained hereon reflects the Company's findings at the time of its intervention only and within the limits of Client's instructions, if any. The Company's sole responsibility is to its Client and this document does not exonerate parties to a transaction from exercising all their rights and obligations under the transaction documents. This document cannot be reproduced except in full, without prior written approval of the Company. Any unauthorized alteration, forgery or falsification of the content or appearance of this document is unlawful and offenders may be prosecuted to the fullest extent of the law.

1.10 Evaluation Procedures

The entire evaluation of the spatial peak values is performed within the Post-processing engine (SEMCAD). The system always gives the maximum values for the 1 g and 10 g cubes. The algorithm to find the cube with highest averaged SAR is divided into the following stages:

1. The extraction of the measured data (grid and values) from the Zoom Scan.
2. The calculation of the SAR value at every measurement point based on all stored data (A/D values and measurement parameters)
3. The generation of a high-resolution mesh within the measured volume
4. The interpolation of all measured values from the measurement grid to the high-resolution grid
5. The extrapolation of the entire 3-D field distribution to the phantom surface over the distance from sensor to surface
6. The calculation of the averaged SAR within masses of 1g and 10g.

The probe is calibrated at the center of the dipole sensors that is located 1 to 2.7mm away from the probe tip. During measurements, the probe stops shortly above the phantom surface, depending on the probe and the surface detecting system. Both distances are included as parameters in the probe configuration file. The software always knows exactly how far away the measured point is from the surface. As the probe cannot directly measure at the surface, the values between the deepest measured point and the surface must be extrapolated. The angle between the probe axis and the surface normal line is less than 30 degree.

In the Area Scan, the gradient of the interpolation function is evaluated to find all the extreme of the SAR distribution. The uncertainty on the locations of the extreme is less than 1/20 of the grid size. Only local maximum within -2 dB of the global maximum are searched and passed for the Cube Scan measurement. In the Cube Scan, the interpolation function is used to extrapolate the Peak SAR from the lowest measurement points to the inner phantom surface (the extrapolation distance). The uncertainty increases with the extrapolation distance. To keep the uncertainty within 1% for the 1 g and 10 g cubes, the extrapolation distance should not be larger than 5mm.

Unless otherwise stated the results shown in this test report refer only to the sample(s) tested and such sample(s) are retained for 90 days only.
除非另有說明，此報告結果僅對測試之樣品負責，同時此樣品僅保留90天。本報告未經本公司書面許可，不可部份複製。

This document is issued by the Company subject to its General Conditions of Service printed overleaf, available on request or accessible at www.sgs.com/terms_and_conditions.htm and, for electronic format documents, subject to Terms and Conditions for Electronic Documents at www.sgs.com/terms_e-document.htm. Attention is drawn to the limitation of liability, indemnification and jurisdiction issues defined therein. Any holder of this document is advised that information contained hereon reflects the Company's findings at the time of its intervention only and within the limits of Client's instructions, if any. The Company's sole responsibility is to its Client and this document does not exonerate parties to a transaction from exercising all their rights and obligations under the transaction documents. This document cannot be reproduced except in full, without prior written approval of the Company. Any unauthorized alteration, forgery or falsification of the content or appearance of this document is unlawful and offenders may be prosecuted to the fullest extent of the law.

The maximum search is automatically performed after each area scan measurement. It is based on splines in two or three dimensions. The procedure can find the maximum for most SAR distributions even with relatively large grid spacing. After the area scanning measurement, the probe is automatically moved to a position at the interpolated maximum. The following scan can directly use this position for reference, e.g., for a finer resolution grid or the cube evaluations. The 1g and 10g peak evaluations are only available for the predefined cube 7x7x7 scans. The routines are verified and optimized for the grid dimensions used in these cube measurements.

The measured volume of 30x30x30mm contains about 30g of tissue.

The first procedure is an extrapolation (incl. Boundary correction) to get the points between the lowest measured plane and the surface. The next step uses 3D interpolation to get all points within the measured volume. In the last step, a 1g cube is placed numerically into the volume and its averaged SAR is calculated. This cube is moved around until the highest averaged SAR is found. If the highest SAR is found at the edge of the measured volume, the system will issue a warning: higher SAR values might be found outside of the measured volume. In that case the cube measurement can be repeated, using the new interpolated maximum as the center.

1.11 Test Standards and Limits

According to FCC 47CFR §2.1093(d) The limits to be used for evaluation are based generally on criteria published by the American National Standards Institute (ANSI) for localized specific absorption rate ("SAR") in Section 4.2 of "IEEE Standard for Safety Levels with Respect to Human Exposure to Radio Frequency Electromagnetic Fields, 3 kHz to 300 GHz," ANSI/IEEE C95.1-1992, Copyright 1992 by the Institute of Electrical and Electronics Engineers, Inc., New York, New York 10017. These criteria for SAR evaluation are similar to those recommended by the National Council on Radiation Protection and Measurements (NCRP) in "Biological Effects and Exposure Criteria for Radio frequency Electromagnetic Fields," NCRP Report No. 86, Section 17.4.5. Copyright NCRP, 1986, Bethesda, Maryland 20814.

Unless otherwise stated the results shown in this test report refer only to the sample(s) tested and such sample(s) are retained for 90 days only.
除非另有說明，此報告結果僅對測試之樣品負責，同時此樣品僅保留90天。本報告未經本公司書面許可，不可部份複製。

This document is issued by the Company subject to its General Conditions of Service printed overleaf, available on request or accessible at www.sgs.com/terms_and_conditions.htm and, for electronic format documents, subject to Terms and Conditions for Electronic Documents at www.sgs.com/terms_e-document.htm. Attention is drawn to the limitation of liability, indemnification and jurisdiction issues defined therein. Any holder of this document is advised that information contained hereon reflects the Company's findings at the time of its intervention only and within the limits of Client's instructions, if any. The Company's sole responsibility is to its Client and this document does not exonerate parties to a transaction from exercising all their rights and obligations under the transaction documents. This document cannot be reproduced except in full, without prior written approval of the Company. Any unauthorized alteration, forgery or falsification of the content or appearance of this document is unlawful and offenders may be prosecuted to the fullest extent of the law.

SAR is a measure of the rate of energy absorption due to exposure to an RF transmitting source. SAR values have been related to threshold levels for potential biological hazards. The criteria to be used are specified in paragraphs (d)(1) and (d)(2) of this section and shall apply for portable devices transmitting in the frequency range from 100 kHz to 6 GHz. Portable devices that transmit at frequencies above 6 GHz are to be evaluated in terms of the MPE limits specified in § 1.1310 of this chapter. Measurements and calculations to demonstrate compliance with MPE field strength or power density limits for devices operating above 6 GHz should be made at a minimum distance of 5 cm from the radiating source.

- (1) Limits for Occupational/Controlled exposure: 0.4 W/kg as averaged over the whole-body and spatial peak SAR not exceeding 8 W/kg as averaged over any 1 gram of tissue (defined as a tissue volume in the shape of a cube). Exceptions are the hands, wrists, feet and ankles where the spatial peak SAR shall not exceed 20 W/kg, as averaged over an 10 grams of tissue (defined as a tissue volume in the shape of a cube).
- (2) Occupational/Controlled limits apply when persons are exposed as a consequence of their employment provided these persons are fully aware of and exercise control over their exposure. Awareness of exposure can be accomplished by use of warning labels or by specific training or education through appropriate means, such as an RF safety program in a work environment.
- (3) Limits for General Population/Uncontrolled exposure: 0.08 W/kg as averaged over the whole-body and spatial peak SAR not exceeding 1.6 W/kg as averaged over any 1 gram of tissue (defined as a tissue volume in the shape of a cube). Exceptions are the hands, wrists, feet and ankles where the spatial peak SAR shall not exceed 4 W/kg, as averaged over any 10 grams of tissue (defined as a tissue volume in the shape of a cube). General Population/Uncontrolled limits apply when the general public may be exposed, or when persons that are exposed as a consequence of their employment may not be fully aware of the potential for exposure or do not exercise control over their exposure. Warning labels placed on consumer devices such as cellular telephones will not be sufficient reason to allow these devices to be evaluated subject to limits for occupational/controlled exposure in paragraph (d)(1) of this section.(Table .4)

Unless otherwise stated the results shown in this test report refer only to the sample(s) tested and such sample(s) are retained for 90 days only.
除非另有說明，此報告結果僅對測試之樣品負責，同時此樣品僅保留90天。本報告未經本公司書面許可，不可部份複製。

This document is issued by the Company subject to its General Conditions of Service printed overleaf, available on request or accessible at www.sgs.com/terms_and_conditions.htm and, for electronic format documents, subject to Terms and Conditions for Electronic Documents at www.sgs.com/terms_e-document.htm. Attention is drawn to the limitation of liability, indemnification and jurisdiction issues defined therein. Any holder of this document is advised that information contained hereon reflects the Company's findings at the time of its intervention only and within the limits of Client's instructions, if any. The Company's sole responsibility is to its Client and this document does not exonerate parties to a transaction from exercising all their rights and obligations under the transaction documents. This document cannot be reproduced except in full, without prior written approval of the Company. Any unauthorized alteration, forgery or falsification of the content or appearance of this document is unlawful and offenders may be prosecuted to the fullest extent of the law.

Human Exposure	Uncontrolled Environment General Population	Controlled Environment Occupational
Spatial Peak SAR (Brain)	1.60 m W/g	8.00 m W/g
Spatial Average SAR (Whole Body)	0.08 m W/g	0.40 m W/g
Spatial Peak SAR (Hands/Feet/Ankle/Wrist)	4.00 m W/g	20.00 m W/g

Table .3 RF exposure limits

Notes:

1. Uncontrolled environments are defined as locations where there is potential exposure of individuals who have no knowledge or control of their potential exposure.
2. Controlled environments are defined as locations where there is potential exposure of individuals who have knowledge of their potential exposure and can exercise control over their exposure.

Unless otherwise stated the results shown in this test report refer only to the sample(s) tested and such sample(s) are retained for 90 days only.

除非另有說明，此報告結果僅對測試之樣品負責，同時此樣品僅保留90天。本報告未經本公司書面許可，不可部份複製。

This document is issued by the Company subject to its General Conditions of Service printed overleaf, available on request or accessible at www.sgs.com/terms_and_conditions.htm and, for electronic format documents, subject to Terms and Conditions for Electronic Documents at www.sgs.com/terms_e-document.htm. Attention is drawn to the limitation of liability, indemnification and jurisdiction issues defined therein. Any holder of this document is advised that information contained hereon reflects the Company's findings at the time of its intervention only and within the limits of Client's instructions, if any. The Company's sole responsibility is to its Client and this document does not exonerate parties to a transaction from exercising all their rights and obligations under the transaction documents. This document cannot be reproduced except in full, without prior written approval of the Company. Any unauthorized alteration, forgery or falsification of the content or appearance of this document is unlawful and offenders may be prosecuted to the fullest extent of the law.

2. Summary of Results

Configuration 1: Lap-held mode

WLAN 802.11b						
Frequency	Channel	MHz	Conducted Output Power (Average)	Measured(W/kg) 1g	Amb. Temp[°C]	Liquid Temp[°C]
2450MHz	1	2412	17.31dBm	1.07	22.1	21.7
	6	2437	16.77dBm	1.11	22.1	21.7
	11	2462	16.38dBm	0.92	22.1	21.7
WLAN 802.11g						
Frequency	Channel	MHz	Conducted Output Power (Average)	Measured(W/kg) 1g	Amb. Temp[°C]	Liquid Temp[°C]
2450MHz	1	2412	17.08dBm	1.03	22.1	21.7
	6	2437	16.68dBm	1.08	22.1	21.7
	11	2462	16.32dBm	0.86	22.1	21.7
WLAN 802.11n(20M)						
Frequency	Channel	MHz	Conducted Output Power (Average)	Measured(W/kg) 1g	Amb. Temp[°C]	Liquid Temp[°C]
2450MHz	1	2412	17.05dBm	0.961	22.1	21.7
	6	2437	16.59dBm	0.986	22.1	21.7
	11	2462	16.15dBm	0.81	22.1	21.7

Unless otherwise stated the results shown in this test report refer only to the sample(s) tested and such sample(s) are retained for 90 days only.
 除非另有說明，此報告結果僅對測試之樣品負責，同時此樣品僅保留90天。本報告未經本公司書面許可，不可部份複製。

This document is issued by the Company subject to its General Conditions of Service printed overleaf, available on request or accessible at www.sgs.com/terms_and_conditions.htm and, for electronic format documents, subject to Terms and Conditions for Electronic Documents at www.sgs.com/terms_e-document.htm. Attention is drawn to the limitation of liability, indemnification and jurisdiction issues defined therein. Any holder of this document is advised that information contained hereon reflects the Company's findings at the time of its intervention only and within the limits of Client's instructions, if any. The Company's sole responsibility is to its Client and this document does not exonerate parties to a transaction from exercising all their rights and obligations under the transaction documents. This document cannot be reproduced except in full, without prior written approval of the Company. Any unauthorized alteration, forgery or falsification of the content or appearance of this document is unlawful and offenders may be prosecuted to the fullest extent of the law.

Configuration 2: Secondary Landscape mode

WLAN 802.11b						
Frequency	Channel	MHz	Conducted Output Power (Average)	Measured(W/kg) 1g	Amb. Temp[° C]	Liquid Temp[° C]
2450MHz	1	2412	17.31dBm	0.055	22.1	21.7
WLAN 802.11g						
Frequency	Channel	MHz	Conducted Output Power (Average)	Measured(W/kg) 1g	Amb. Temp[° C]	Liquid Temp[° C]
2450MHz	1	2412	17.08dBm	0.060	22.1	21.7
WLAN 802.11n(20M)						
Frequency	Channel	MHz	Conducted Output Power (Average)	Measured(W/kg) 1g	Amb. Temp[° C]	Liquid Temp[° C]
2450MHz	1	2412	17.05dBm	0.056	22.1	21.7

Configuration 3: Primary Landscape mode

WLAN 802.11b						
Frequency	Channel	MHz	Conducted Output Power (Average)	Measured(W/kg) 1g	Amb. Temp[° C]	Liquid Temp[° C]
2450MHz	1	2412	17.31dBm	0.00299	22.1	21.7
WLAN 802.11g						
Frequency	Channel	MHz	Conducted Output Power (Average)	Measured(W/kg) 1g	Amb. Temp[° C]	Liquid Temp[° C]
2450MHz	1	2412	17.08dBm	0.00339	22.1	21.7
WLAN 802.11n(20M)						
Frequency	Channel	MHz	Conducted Output Power (Average)	Measured(W/kg) 1g	Amb. Temp[° C]	Liquid Temp[° C]
2450MHz	1	2412	17.05dBm	0.00288	22.1	21.7

Unless otherwise stated the results shown in this test report refer only to the sample(s) tested and such sample(s) are retained for 90 days only.
 除非另有說明，此報告結果僅對測試之樣品負責，同時此樣品僅保留90天。本報告未經本公司書面許可，不可部份複製。

This document is issued by the Company subject to its General Conditions of Service printed overleaf, available on request or accessible at www.sgs.com/terms_and_conditions.htm and, for electronic format documents, subject to Terms and Conditions for Electronic Documents at www.sgs.com/terms_e-document.htm. Attention is drawn to the limitation of liability, indemnification and jurisdiction issues defined therein. Any holder of this document is advised that information contained hereon reflects the Company's findings at the time of its intervention only and within the limits of Client's instructions, if any. The Company's sole responsibility is to its Client and this document does not exonerate parties to a transaction from exercising all their rights and obligations under the transaction documents. This document cannot be reproduced except in full, without prior written approval of the Company. Any unauthorized alteration, forgery or falsification of the content or appearance of this document is unlawful and offenders may be prosecuted to the fullest extent of the law.

Configuration 4: Secondary portrait mode

WLAN 802.11b						
Frequency	Channel	MHz	Conducted Output Power (Average)	Measured(W/kg) 1g	Amb. Temp[° C]	Liquid Temp[° C]
2450MHz	1	2412	17.31dBm	Not detectable	22.1	21.7
WLAN 802.11g						
Frequency	Channel	MHz	Conducted Output Power (Average)	Measured(W/kg) 1g	Amb. Temp[° C]	Liquid Temp[° C]
2450MHz	1	2412	17.08dBm	Not detectable	22.1	21.7
WLAN 802.11n(20M)						
Frequency	Channel	MHz	Conducted Output Power (Average)	Measured(W/kg) 1g	Amb. Temp[° C]	Liquid Temp[° C]
2450MHz	1	2412	17.05dBm	Not detectable	22.1	21.7

Configuration 5: Primary Portrait mode

WLAN 802.11b						
Frequency	Channel	MHz	Conducted Output Power (Average)	Measured(W/kg) 1g	Amb. Temp[° C]	Liquid Temp[° C]
2450MHz	1	2412	17.31dBm	0.011	22.1	21.7
WLAN 802.11g						
Frequency	Channel	MHz	Conducted Output Power (Average)	Measured(W/kg) 1g	Amb. Temp[° C]	Liquid Temp[° C]
2450MHz	1	2412	17.08dBm	0.012	22.1	21.7
WLAN 802.11n(20M)						
Frequency	Channel	MHz	Conducted Output Power (Average)	Measured(W/kg) 1g	Amb. Temp[° C]	Liquid Temp[° C]
2450MHz	1	2412	17.05dBm	0.011	22.1	21.7

Note:

The SAR measurement results with transmitter at maximum output power.

Unless otherwise stated the results shown in this test report refer only to the sample(s) tested and such sample(s) are retained for 90 days only.
除非另有說明，此報告結果僅對測試之樣品負責，同時此樣品僅保留90天。本報告未經本公司書面許可，不可部份複製。

This document is issued by the Company subject to its General Conditions of Service printed overleaf, available on request or accessible at www.sgs.com/terms_and_conditions.htm and, for electronic format documents, subject to Terms and Conditions for Electronic Documents at www.sgs.com/terms_e-document.htm. Attention is drawn to the limitation of liability, indemnification and jurisdiction issues defined therein. Any holder of this document is advised that information contained hereon reflects the Company's findings at the time of its intervention only and within the limits of Client's instructions, if any. The Company's sole responsibility is to its Client and this document does not exonerate parties to a transaction from exercising all their rights and obligations under the transaction documents. This document cannot be reproduced except in full, without prior written approval of the Company. Any unauthorized alteration, forgery or falsification of the content or appearance of this document is unlawful and offenders may be prosecuted to the fullest extent of the law.

3. Instruments List

Manufacturer	Device	Type	Serial number	Date of last calibration
Schmid & Partner Engineering AG	Dosimetric E-Field Probe	EX3DV3	3139	Feb.19.2010
Schmid & Partner Engineering AG	2450 MHz System Validation Dipole	D2450V2	727	Apr.29.2010
Schmid & Partner Engineering AG	Data acquisition Electronics	DAE4	856	May.20.2010
Schmid & Partner Engineering AG	Software	DASY 5 V5.0 Build125	N/A	Calibration not required
Schmid & Partner Engineering AG	Phantom	SAM	N/A	Calibration not required
Agilent	Network Analyzer	8753D	3410A05662	Mar.30.2010
Agilent	Dielectric Probe Kit	85070D	US01440168	Calibration not required
Agilent	Dual-directional coupler	777D	50114	Aug.25.2010
Agilent	RF Signal Generator	8648D	3847M00432	Jun.04.2010
Agilent	Power Sensor	U2001B	MY48100169	Apr.30.2010

Unless otherwise stated the results shown in this test report refer only to the sample(s) tested and such sample(s) are retained for 90 days only.
 除非另有說明，此報告結果僅對測試之樣品負責，同時此樣品僅保留90天。本報告未經本公司書面許可，不可部份複製。

This document is issued by the Company subject to its General Conditions of Service printed overleaf, available on request or accessible at www.sgs.com/terms_and_conditions.htm and, for electronic format documents, subject to Terms and Conditions for Electronic Documents at www.sgs.com/terms_e-document.htm. Attention is drawn to the limitation of liability, indemnification and jurisdiction issues defined therein. Any holder of this document is advised that information contained hereon reflects the Company's findings at the time of its intervention only and within the limits of Client's instructions, if any. The Company's sole responsibility is to its Client and this document does not exonerate parties to a transaction from exercising all their rights and obligations under the transaction documents. This document cannot be reproduced except in full, without prior written approval of the Company. Any unauthorized alteration, forgery or falsification of the content or appearance of this document is unlawful and offenders may be prosecuted to the fullest extent of the law.

4. Measurements

Date: 2011/1/20

Configuration 1_WLAN802.11b_CH1

DUT: QV3A

Communication System: WLAN802.11 b & g & n; Frequency: 2412 MHz

 Medium parameters used: $f = 2412$ MHz; $\sigma = 1.931$ mho/m; $\epsilon_r = 52.652$; $\rho = 1000$ kg/m³

Phantom section: Flat Section

Measurement Standard: DASY5 (IEEE/IEC/ANSI C63.19-2007)

- Probe: ES3DV3 - SN3139; ConvF(4.15, 4.15, 4.15); Calibrated: 2/19/2010
- Sensor-Surface: 4mm (Mechanical Surface Detection)
- Electronics: DAE4 Sn856; Calibrated: 5/20/2010
- Phantom: SAM2; Type: SAM;
- Measurement SW: DASY52, Version 52.6 (1); SEMCAD X Version 14.4.2 (2595)

Configuration/Body/Area Scan (61x201x1): Measurement grid: dx=15mm, dy=15mm

Maximum value of SAR (interpolated) = 1.067 mW/g

Configuration/Body/Zoom Scan (7x7x7) (5x5x7)/Cube 0: Measurement grid: dx=8mm, dy=8mm, dz=5mm

Reference Value = 1.331 V/m; Power Drift = 0.132 dB

Peak SAR (extrapolated) = 3.072 W/kg

SAR(1 g) = 1.07 mW/g; SAR(10 g) = 0.431 mW/g

Maximum value of SAR (measured) = 1.099 mW/g

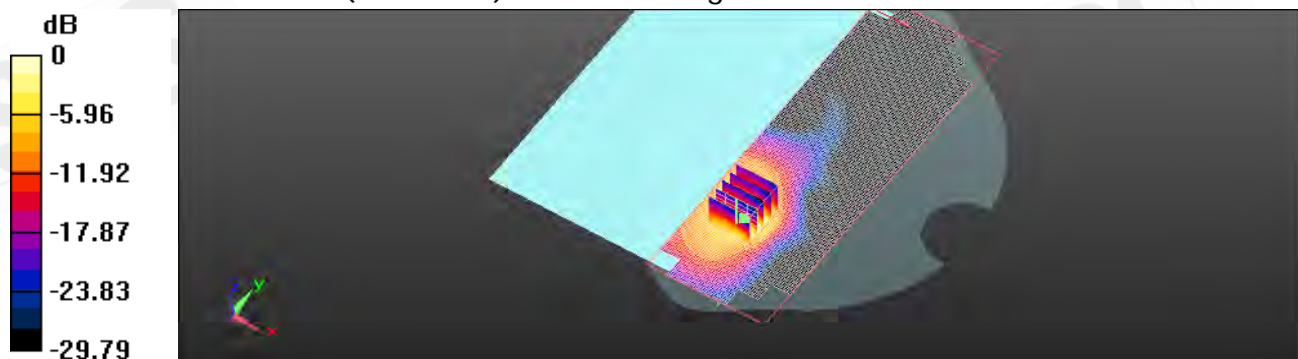

0 dB = 1.100mW/g

Unless otherwise stated the results shown in this test report refer only to the sample(s) tested and such sample(s) are retained for 90 days only.
 除非另有說明，此報告結果僅對測試之樣品負責，同時此樣品僅保留90天。本報告未經本公司書面許可，不可部份複製。

This document is issued by the Company subject to its General Conditions of Service printed overleaf, available on request or accessible at www.sgs.com/terms_and_conditions.htm and, for electronic format documents, subject to Terms and Conditions for Electronic Documents at www.sgs.com/terms_e-document.htm. Attention is drawn to the limitation of liability, indemnification and jurisdiction issues defined therein. Any holder of this document is advised that information contained hereon reflects the Company's findings at the time of its intervention only and within the limits of Client's instructions, if any. The Company's sole responsibility is to its Client and this document does not exonerate parties to a transaction from exercising all their rights and obligations under the transaction documents. This document cannot be reproduced except in full, without prior written approval of the Company. Any unauthorized alteration, forgery or falsification of the content or appearance of this document is unlawful and offenders may be prosecuted to the fullest extent of the law.

Date: 2011/1/20

Configuration 1_ WLAN802.11b_CH6

DUT: QV3A

Communication System: WLAN802.11 b & g & n; Frequency: 2437 MHz;
Medium parameters used: $f = 2437$ MHz; $\sigma = 1.98$ mho/m; $\epsilon_r = 52.7$; $\rho = 1000$ kg/m³
Phantom section: Flat Section
Measurement Standard: DASYS (IEEE/IEC/ANSI C63.19-2007)

- Probe: ES3DV3 - SN3139; ConvF(4.15, 4.15, 4.15); Calibrated: 2/19/2010
- Sensor-Surface: 4mm (Mechanical Surface Detection)
- Electronics: DAE4 Sn856; Calibrated: 5/20/2010
- Phantom: SAM2; Type: SAM;
- Measurement SW: DASYS, V5.2 Build 157; SEMCAD X Version 14.0 Build 57

Configuration/Body/Area Scan (61x201x1): Measurement grid: dx=15mm, dy=15mm

Maximum value of SAR (interpolated) = 1.17 mW/g

Configuration/Body/Zoom Scan (7x7x7)/Cube 0: Measurement grid: dx=8mm, dy=8mm, dz=5mm

Reference Value = 1.62 V/m; Power Drift = -0.143 dB

Peak SAR (extrapolated) = 3.34 W/kg

SAR(1 g) = 1.11 mW/g; SAR(10 g) = 0.444 mW/g

Maximum value of SAR (measured) = 1.21 mW/g

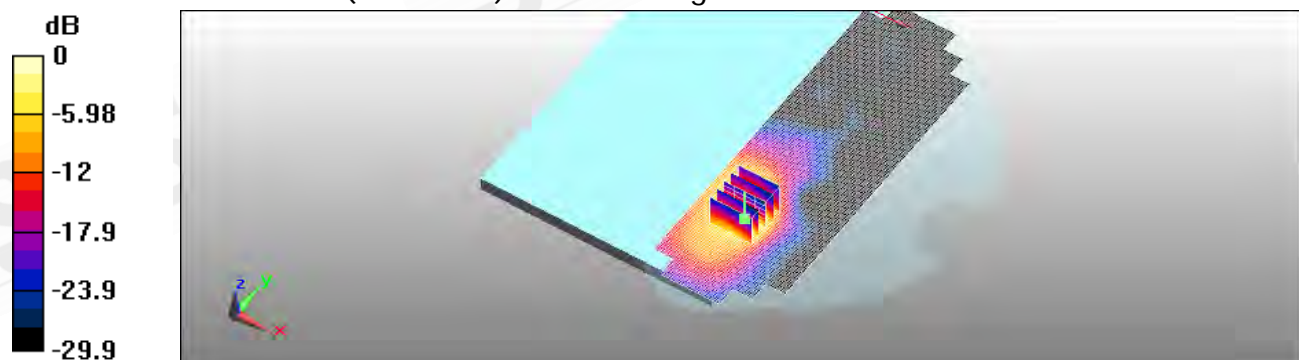

0 dB = 1.21mW/g

Unless otherwise stated the results shown in this test report refer only to the sample(s) tested and such sample(s) are retained for 90 days only.
除非另有說明，此報告結果僅對測試之樣品負責，同時此樣品僅保留90天。本報告未經本公司書面許可，不可部份複製。

This document is issued by the Company subject to its General Conditions of Service printed overleaf, available on request or accessible at www.sgs.com/terms_and_conditions.htm and, for electronic format documents, subject to Terms and Conditions for Electronic Documents at www.sgs.com/terms_e-document.htm. Attention is drawn to the limitation of liability, indemnification and jurisdiction issues defined therein. Any holder of this document is advised that information contained hereon reflects the Company's findings at the time of its intervention only and within the limits of Client's instructions, if any. The Company's sole responsibility is to its Client and this document does not exonerate parties to a transaction from exercising all their rights and obligations under the transaction documents. This document cannot be reproduced except in full, without prior written approval of the Company. Any unauthorized alteration, forgery or falsification of the content or appearance of this document is unlawful and offenders may be prosecuted to the fullest extent of the law.



Unless otherwise stated the results shown in this test report refer only to the sample(s) tested and such sample(s) are retained for 90 days only.
 除非另有說明，此報告結果僅對測試之樣品負責，同時此樣品僅保留90天。本報告未經本公司書面許可，不可部份複製。

This document is issued by the Company subject to its General Conditions of Service printed overleaf, available on request or accessible at www.sgs.com/terms_and_conditions.htm and, for electronic format documents, subject to Terms and Conditions for Electronic Documents at www.sgs.com/terms_e-document.htm. Attention is drawn to the limitation of liability, indemnification and jurisdiction issues defined therein. Any holder of this document is advised that information contained hereon reflects the Company's findings at the time of its intervention only and within the limits of Client's instructions, if any. The Company's sole responsibility is to its Client and this document does not exonerate parties to a transaction from exercising all their rights and obligations under the transaction documents. This document cannot be reproduced except in full, without prior written approval of the Company. Any unauthorized alteration, forgery or falsification of the content or appearance of this document is unlawful and offenders may be prosecuted to the fullest extent of the law.

Date: 2011/1/20

Configuration 1_WLAN802.11b_CH11

DUT: QV3A

Communication System: WLAN802.11 b & g & n; Frequency: 2462 MHz
Medium parameters used: $f = 2462$ MHz; $\sigma = 1.989$ mho/m; $\epsilon_r = 52.236$; $\rho = 1000$ kg/m³
Phantom section: Flat Section
Measurement Standard: DASYS (IEEE/IEC/ANSI C63.19-2007)
DASY5 Configuration:

- Probe: ES3DV3 - SN3139; ConvF(4.15, 4.15, 4.15); Calibrated: 2/19/2010
- Sensor-Surface: 4mm (Mechanical Surface Detection)
- Electronics: DAE4 Sn856; Calibrated: 5/20/2010
- Phantom: SAM2; Type: SAM;
- Measurement SW: DASY52, Version 52.6 (1); SEMCAD X Version 14.4.2 (2595)

Configuration/Body/Area Scan (61x201x1): Measurement grid: dx=15mm, dy=15mm
Maximum value of SAR (interpolated) = 0.910 mW/g

Configuration/Body/Zoom Scan (7x7x7) (5x5x7)/Cube 0: Measurement grid: dx=8mm, dy=8mm, dz=5mm
Reference Value = 1.226 V/m; Power Drift = -0.04 dB
Peak SAR (extrapolated) = 2.711 W/kg

SAR(1 g) = 0.920 mW/g; SAR(10 g) = 0.361 mW/g
Maximum value of SAR (measured) = 1.048 mW/g

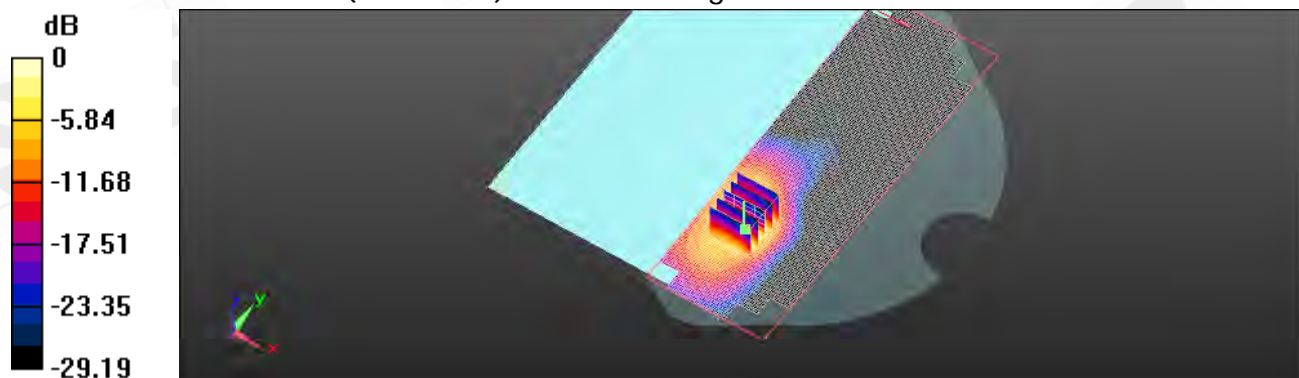

0 dB = 1.050mW/g

Unless otherwise stated the results shown in this test report refer only to the sample(s) tested and such sample(s) are retained for 90 days only.
除非另有說明，此報告結果僅對測試之樣品負責，同時此樣品僅保留90天。本報告未經本公司書面許可，不可部份複製。

This document is issued by the Company subject to its General Conditions of Service printed overleaf, available on request or accessible at www.sgs.com/terms_and_conditions.htm and, for electronic format documents, subject to Terms and Conditions for Electronic Documents at www.sgs.com/terms_e-document.htm. Attention is drawn to the limitation of liability, indemnification and jurisdiction issues defined therein. Any holder of this document is advised that information contained hereon reflects the Company's findings at the time of its intervention only and within the limits of Client's instructions, if any. The Company's sole responsibility is to its Client and this document does not exonerate parties to a transaction from exercising all their rights and obligations under the transaction documents. This document cannot be reproduced except in full, without prior written approval of the Company. Any unauthorized alteration, forgery or falsification of the content or appearance of this document is unlawful and offenders may be prosecuted to the fullest extent of the law.

Date: 2011/1/20

Configuration 1_WLAN802.11g_CH1

DUT: QV3A

Communication System: WLAN802.11 b & g & n; Frequency: 2412 MHz
Medium parameters used: $f = 2412$ MHz; $\sigma = 1.931$ mho/m; $\epsilon_r = 52.652$; $\rho = 1000$ kg/m³
Phantom section: Flat Section
Measurement Standard: DASYS (IEEE/IEC/ANSI C63.19-2007)
DASY5 Configuration:

- Probe: ES3DV3 - SN3139; ConvF(4.15, 4.15, 4.15); Calibrated: 2/19/2010
- Sensor-Surface: 4mm (Mechanical Surface Detection)
- Electronics: DAE4 Sn856; Calibrated: 5/20/2010
- Phantom: SAM2; Type: SAM;
- Measurement SW: DASY52, Version 52.6 (1); SEMCAD X Version 14.4.2 (2595)

Configuration/Body/Area Scan (61x201x1): Measurement grid: dx=15mm, dy=15mm
Maximum value of SAR (interpolated) = 1.180 mW/g

Configuration/Body/Zoom Scan (7x7x7) (5x5x7)/Cube 0: Measurement grid: dx=8mm, dy=8mm, dz=5mm
Reference Value = 1.358 V/m; Power Drift = -0.136 dB
Peak SAR (extrapolated) = 2.893 W/kg

SAR(1 g) = 1.03 mW/g; SAR(10 g) = 0.413 mW/g
Maximum value of SAR (measured) = 1.140 mW/g

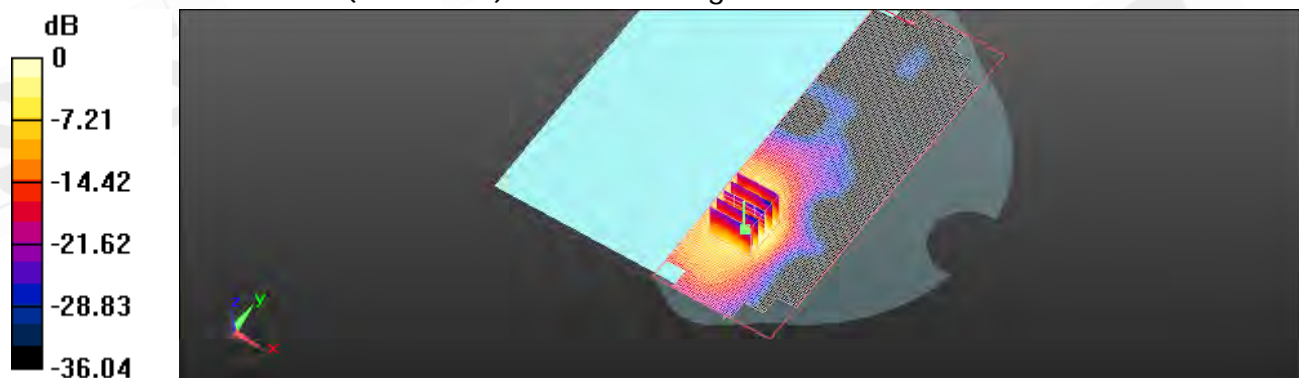

0 dB = 1.140mW/g

Unless otherwise stated the results shown in this test report refer only to the sample(s) tested and such sample(s) are retained for 90 days only.
除非另有說明，此報告結果僅對測試之樣品負責，同時此樣品僅保留90天。本報告未經本公司書面許可，不可部份複製。

This document is issued by the Company subject to its General Conditions of Service printed overleaf, available on request or accessible at www.sgs.com/terms_and_conditions.htm and, for electronic format documents, subject to Terms and Conditions for Electronic Documents at www.sgs.com/terms_e-document.htm. Attention is drawn to the limitation of liability, indemnification and jurisdiction issues defined therein. Any holder of this document is advised that information contained hereon reflects the Company's findings at the time of its intervention only and within the limits of Client's instructions, if any. The Company's sole responsibility is to its Client and this document does not exonerate parties to a transaction from exercising all their rights and obligations under the transaction documents. This document cannot be reproduced except in full, without prior written approval of the Company. Any unauthorized alteration, forgery or falsification of the content or appearance of this document is unlawful and offenders may be prosecuted to the fullest extent of the law.

Date: 2011/1/20

Configuration 1_WLAN802.11g_CH6

DUT: QV3A

Communication System: WLAN802.11 b & g & n; Frequency: 2437 MHz;
Medium parameters used: $f = 2437$ MHz; $\sigma = 1.98$ mho/m; $\epsilon_r = 52.7$; $\rho = 1000$ kg/m³
Phantom section: Flat Section
Measurement Standard: DASY5 (IEEE/IEC/ANSI C63.19-2007)
DASY5 Configuration:

- Probe: ES3DV3 - SN3139; ConvF(4.15, 4.15, 4.15); Calibrated: 2/19/2010
- Sensor-Surface: 4mm (Mechanical Surface Detection)
- Electronics: DAE4 Sn856; Calibrated: 5/20/2010
- Phantom: SAM2; Type: SAM;
- Measurement SW: DASY5, V5.2 Build 157; SEMCAD X Version 14.0 Build 57

Configuration/Body/Area Scan (61x201x1): Measurement grid: dx=15mm, dy=15mm

Maximum value of SAR (interpolated) = 1.12 mW/g

Configuration/Body/Zoom Scan (7x7x7)/Cube 0: Measurement grid: dx=8mm, dy=8mm, dz=5mm

Reference Value = 1.52 V/m; Power Drift = 0.127 dB

Peak SAR (extrapolated) = 3.3 W/kg

SAR(1 g) = 1.08 mW/g; SAR(10 g) = 0.433 mW/g

Maximum value of SAR (measured) = 1.2 mW/g

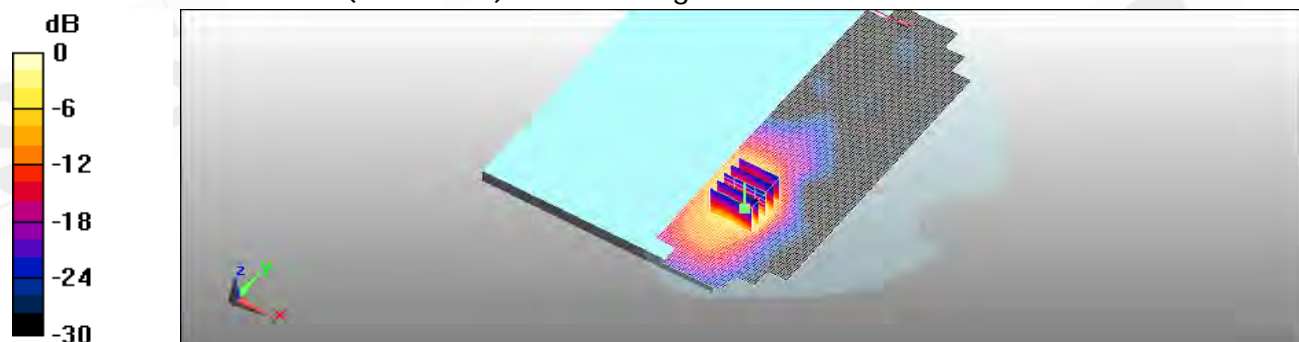

0 dB = 1.2mW/g

Unless otherwise stated the results shown in this test report refer only to the sample(s) tested and such sample(s) are retained for 90 days only.
除非另有說明，此報告結果僅對測試之樣品負責，同時此樣品僅保留90天。本報告未經本公司書面許可，不可部份複製。

This document is issued by the Company subject to its General Conditions of Service printed overleaf, available on request or accessible at www.sgs.com/terms_and_conditions.htm and, for electronic format documents, subject to Terms and Conditions for Electronic Documents at www.sgs.com/terms_e-document.htm. Attention is drawn to the limitation of liability, indemnification and jurisdiction issues defined therein. Any holder of this document is advised that information contained hereon reflects the Company's findings at the time of its intervention only and within the limits of Client's instructions, if any. The Company's sole responsibility is to its Client and this document does not exonerate parties to a transaction from exercising all their rights and obligations under the transaction documents. This document cannot be reproduced except in full, without prior written approval of the Company. Any unauthorized alteration, forgery or falsification of the content or appearance of this document is unlawful and offenders may be prosecuted to the fullest extent of the law.

Date: 2011/1/20

Configuration 1_WLAN802.11g_CH11

DUT: QV3A

Communication System: WLAN802.11 b & g & n; Frequency: 2462 MHz

Medium parameters used: $f = 2462$ MHz; $\sigma = 1.989$ mho/m; $\epsilon_r = 52.236$; $\rho = 1000$ kg/m³

Phantom section: Flat Section

Measurement Standard: DASY5 (IEEE/IEC/ANSI C63.19-2007)

DASY5 Configuration:

- Probe: ES3DV3 - SN3139; ConvF(4.15, 4.15, 4.15); Calibrated: 2/19/2010
- Sensor-Surface: 4mm (Mechanical Surface Detection)
- Electronics: DAE4 Sn856; Calibrated: 5/20/2010
- Phantom: SAM2; Type: SAM;
- Measurement SW: DASY52, Version 52.6 (1); SEMCAD X Version 14.4.2 (2595)

Configuration/Body/Area Scan (61x201x1): Measurement grid: dx=15mm, dy=15mm

Maximum value of SAR (interpolated) = 0.985 mW/g

Configuration/Body/Zoom Scan (7x7x7) (5x5x7)/Cube 0: Measurement grid: dx=8mm, dy=8mm, dz=5mm

Reference Value = 1.139 V/m; Power Drift = -0.04 dB

Peak SAR (extrapolated) = 2.564 W/kg

SAR(1 g) = 0.864 mW/g; SAR(10 g) = 0.339 mW/g

Maximum value of SAR (measured) = 0.990 mW/g

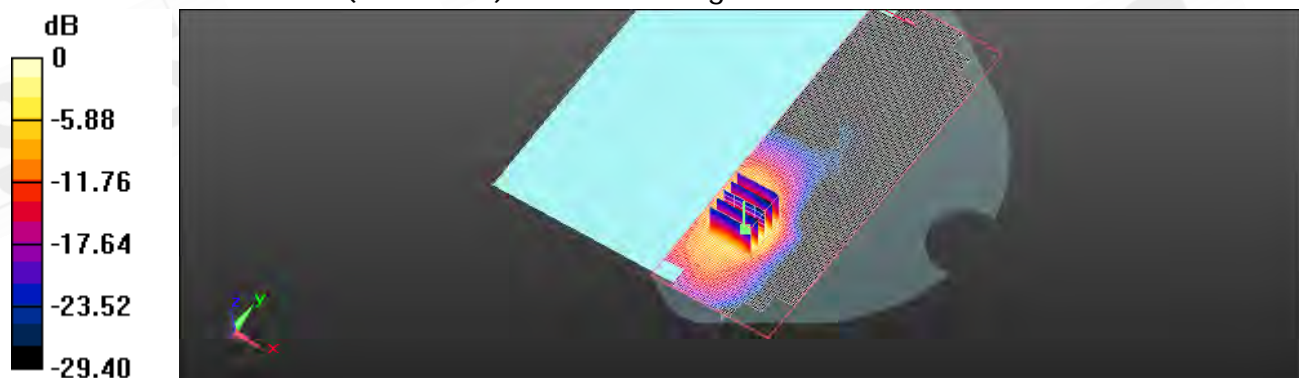

0 dB = 0.990mW/g

Unless otherwise stated the results shown in this test report refer only to the sample(s) tested and such sample(s) are retained for 90 days only.
除非另有說明，此報告結果僅對測試之樣品負責，同時此樣品僅保留90天。本報告未經本公司書面許可，不可部份複製。

This document is issued by the Company subject to its General Conditions of Service printed overleaf, available on request or accessible at www.sgs.com/terms_and_conditions.htm and, for electronic format documents, subject to Terms and Conditions for Electronic Documents at www.sgs.com/terms_e-document.htm. Attention is drawn to the limitation of liability, indemnification and jurisdiction issues defined therein. Any holder of this document is advised that information contained hereon reflects the Company's findings at the time of its intervention only and within the limits of Client's instructions, if any. The Company's sole responsibility is to its Client and this document does not exonerate parties to a transaction from exercising all their rights and obligations under the transaction documents. This document cannot be reproduced except in full, without prior written approval of the Company. Any unauthorized alteration, forgery or falsification of the content or appearance of this document is unlawful and offenders may be prosecuted to the fullest extent of the law.

Date: 2011/1/20

Configuration 1_WLAN802.11n(20M)_CH1

DUT: QV3A

Communication System: WLAN802.11 b & g & n; Frequency: 2412 MHz
Medium parameters used: $f = 2412$ MHz; $\sigma = 1.931$ mho/m; $\epsilon_r = 52.652$; $\rho = 1000$ kg/m³
Phantom section: Flat Section
Measurement Standard: DASY5 (IEEE/IEC/ANSI C63.19-2007)
DASY5 Configuration:

- Probe: ES3DV3 - SN3139; ConvF(4.15, 4.15, 4.15); Calibrated: 2/19/2010
- Sensor-Surface: 4mm (Mechanical Surface Detection)
- Electronics: DAE4 Sn856; Calibrated: 5/20/2010
- Phantom: SAM2; Type: SAM;
- Measurement SW: DASY52, Version 52.6 (1); SEMCAD X Version 14.4.2 (2595)

Configuration/Body/Area Scan (61x201x1): Measurement grid: dx=15mm, dy=15mm
Maximum value of SAR (interpolated) = 1.106 mW/g

Configuration/Body/Zoom Scan (7x7x7) (5x5x7)/Cube 0: Measurement grid: dx=8mm, dy=8mm, dz=5mm
Reference Value = 1.022 V/m; Power Drift = 0.167 dB
Peak SAR (extrapolated) = 2.726 W/kg

SAR(1 g) = 0.961 mW/g; SAR(10 g) = 0.387 mW/g
Maximum value of SAR (measured) = 1.105 mW/g

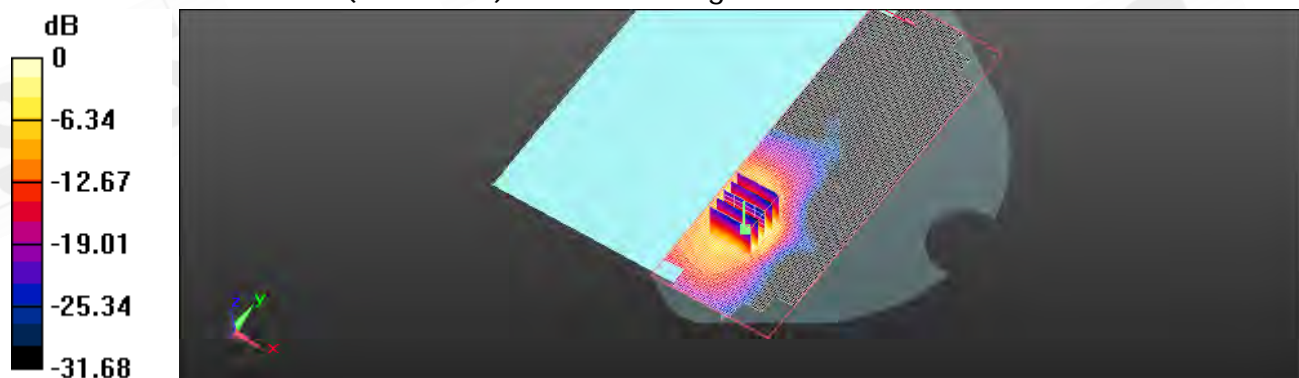

0 dB = 1.100mW/g

Unless otherwise stated the results shown in this test report refer only to the sample(s) tested and such sample(s) are retained for 90 days only.
除非另有說明，此報告結果僅對測試之樣品負責，同時此樣品僅保留90天。本報告未經本公司書面許可，不可部份複製。

This document is issued by the Company subject to its General Conditions of Service printed overleaf, available on request or accessible at www.sgs.com/terms_and_conditions.htm and, for electronic format documents, subject to Terms and Conditions for Electronic Documents at www.sgs.com/terms_e-document.htm. Attention is drawn to the limitation of liability, indemnification and jurisdiction issues defined therein. Any holder of this document is advised that information contained hereon reflects the Company's findings at the time of its intervention only and within the limits of Client's instructions, if any. The Company's sole responsibility is to its Client and this document does not exonerate parties to a transaction from exercising all their rights and obligations under the transaction documents. This document cannot be reproduced except in full, without prior written approval of the Company. Any unauthorized alteration, forgery or falsification of the content or appearance of this document is unlawful and offenders may be prosecuted to the fullest extent of the law.

Date: 2011/1/20

Configuration 1_WLAN802.11n(20M)_CH6

DUT: QV3A

Communication System: WLAN802.11 b & g & n; Frequency: 2437 MHz;
 Medium parameters used: $f = 2437 \text{ MHz}$; $\sigma = 1.98 \text{ mho/m}$; $\epsilon_r = 52.7$; $\rho = 1000 \text{ kg/m}^3$
 Phantom section: Flat Section
 Measurement Standard: DASY5 (IEEE/IEC/ANSI C63.19-2007)
 DASY5 Configuration:

- Probe: ES3DV3 - SN3139; ConvF(4.15, 4.15, 4.15); Calibrated: 2/19/2010
- Sensor-Surface: 4mm (Mechanical Surface Detection)
- Electronics: DAE4 Sn856; Calibrated: 5/20/2010
- Phantom: SAM2; Type: SAM;
- Measurement SW: DASY5, V5.2 Build 157; SEMCAD X Version 14.0 Build 57

Configuration/Body/Area Scan (61x201x1): Measurement grid: $dx=15\text{mm}$,
 $dy=15\text{mm}$

Maximum value of SAR (interpolated) = 0.997 mW/g

Configuration/Body/Zoom Scan (7x7x7)/Cube 0: Measurement grid: $dx=8\text{mm}$,
 $dy=8\text{mm}$, $dz=5\text{mm}$

Reference Value = 1.48 V/m; Power Drift = 0.132 dB

Peak SAR (extrapolated) = 2.98 W/kg

SAR(1 g) = 0.986 mW/g; SAR(10 g) = 0.393 mW/g

Maximum value of SAR (measured) = 1.09 mW/g

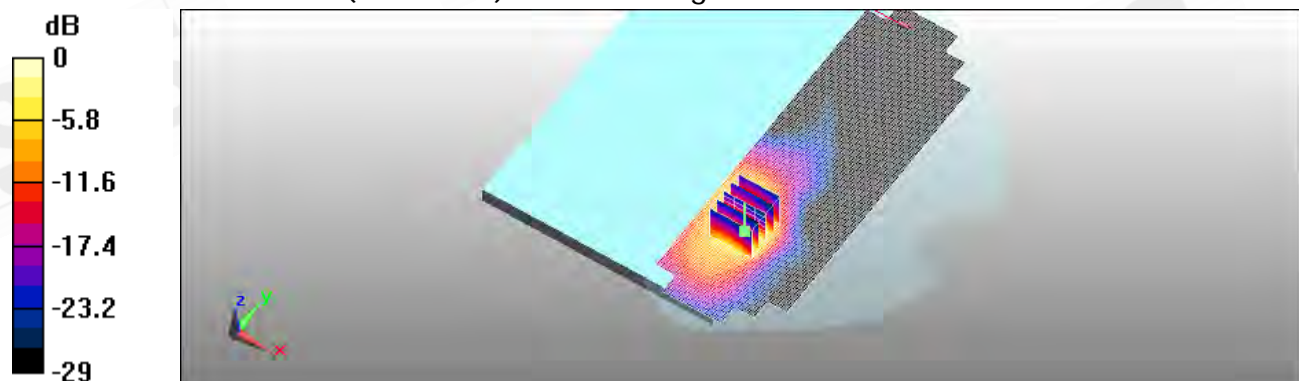

0 dB = 1.09mW/g

Unless otherwise stated the results shown in this test report refer only to the sample(s) tested and such sample(s) are retained for 90 days only.
 除非另有說明，此報告結果僅對測試之樣品負責，同時此樣品僅保留90天。本報告未經本公司書面許可，不可部份複製。

This document is issued by the Company subject to its General Conditions of Service printed overleaf, available on request or accessible at www.sgs.com/terms_and_conditions.htm and, for electronic format documents, subject to Terms and Conditions for Electronic Documents at www.sgs.com/terms_e-document.htm. Attention is drawn to the limitation of liability, indemnification and jurisdiction issues defined therein. Any holder of this document is advised that information contained hereon reflects the Company's findings at the time of its intervention only and within the limits of Client's instructions, if any. The Company's sole responsibility is to its Client and this document does not exonerate parties to a transaction from exercising all their rights and obligations under the transaction documents. This document cannot be reproduced except in full, without prior written approval of the Company. Any unauthorized alteration, forgery or falsification of the content or appearance of this document is unlawful and offenders may be prosecuted to the fullest extent of the law.

Date: 2011/1/20

Configuration 1_WLAN802.11n(20M)_CH11

DUT: QV3A

Communication System: WLAN802.11 b & g & n; Frequency: 2462 MHz
Medium parameters used: $f = 2462$ MHz; $\sigma = 1.989$ mho/m; $\epsilon_r = 52.236$; $\rho = 1000$ kg/m³
Phantom section: Flat Section
Measurement Standard: DASY5 (IEEE/IEC/ANSI C63.19-2007)
DASY5 Configuration:

- Probe: ES3DV3 - SN3139; ConvF(4.15, 4.15, 4.15); Calibrated: 2/19/2010
- Sensor-Surface: 4mm (Mechanical Surface Detection)
- Electronics: DAE4 Sn856; Calibrated: 5/20/2010
- Phantom: SAM2; Type: SAM;
- Measurement SW: DASY52, Version 52.6 (1); SEMCAD X Version 14.4.2 (2595)

Configuration/Body/Area Scan (61x201x1): Measurement grid: dx=15mm, dy=15mm
Maximum value of SAR (interpolated) = 0.931 mW/g

Configuration/Body/Zoom Scan (7x7x7) (5x5x7)/Cube 0: Measurement grid: dx=8mm, dy=8mm, dz=5mm
Reference Value = 0.932 V/m; Power Drift = 0.022 dB
Peak SAR (extrapolated) = 2.377 W/kg

SAR(1 g) = 0.810 mW/g; SAR(10 g) = 0.318 mW/g
Maximum value of SAR (measured) = 0.928 mW/g

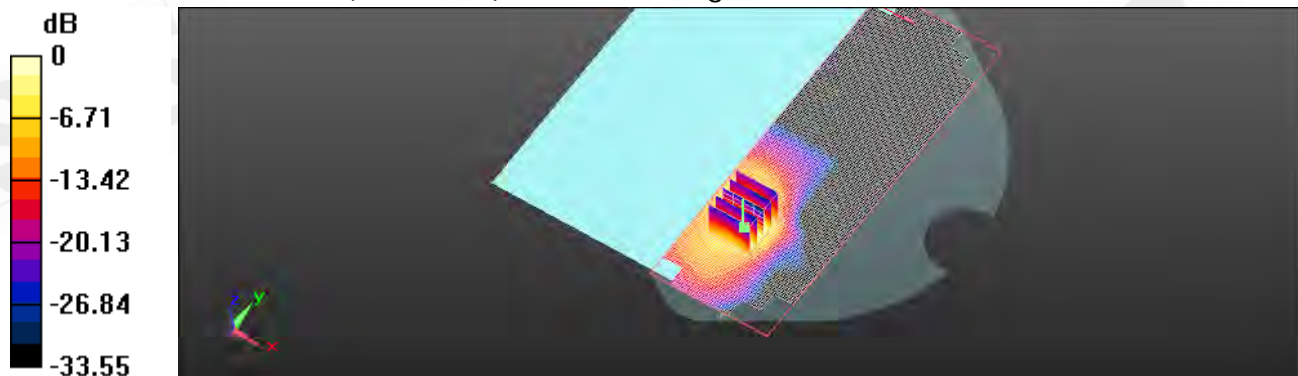

0 dB = 0.930mW/g

Unless otherwise stated the results shown in this test report refer only to the sample(s) tested and such sample(s) are retained for 90 days only.
除非另有說明，此報告結果僅對測試之樣品負責，同時此樣品僅保留90天。本報告未經本公司書面許可，不可部份複製。

This document is issued by the Company subject to its General Conditions of Service printed overleaf, available on request or accessible at www.sgs.com/terms_and_conditions.htm and, for electronic format documents, subject to Terms and Conditions for Electronic Documents at www.sgs.com/terms_e-document.htm. Attention is drawn to the limitation of liability, indemnification and jurisdiction issues defined therein. Any holder of this document is advised that information contained hereon reflects the Company's findings at the time of its intervention only and within the limits of Client's instructions, if any. The Company's sole responsibility is to its Client and this document does not exonerate parties to a transaction from exercising all their rights and obligations under the transaction documents. This document cannot be reproduced except in full, without prior written approval of the Company. Any unauthorized alteration, forgery or falsification of the content or appearance of this document is unlawful and offenders may be prosecuted to the fullest extent of the law.

Date: 2011/1/20

Configuration 2_WLAN802.11b_CH1

DUT: QV3A

Communication System: WLAN802.11 b & g & n; Frequency: 2412 MHz

Medium parameters used: $f = 2412$ MHz; $\sigma = 1.931$ mho/m; $\epsilon_r = 52.652$; $\rho = 1000$ kg/m³

Phantom section: Flat Section

Measurement Standard: DASY5 (IEEE/IEC/ANSI C63.19-2007)

DASY5 Configuration:

- Probe: ES3DV3 - SN3139; ConvF(4.15, 4.15, 4.15); Calibrated: 2/19/2010
- Sensor-Surface: 4mm (Mechanical Surface Detection)
- Electronics: DAE4 Sn856; Calibrated: 5/20/2010
- Phantom: SAM2; Type: SAM;
- Measurement SW: DASY5, V5.2 Build 157; SEMCAD X Version 14.0 Build 57

Configuration/Body/Area Scan (61x201x1): Measurement grid: dx=15mm, dy=15mm

Maximum value of SAR (interpolated) = 0.062 mW/g

Configuration/Body/Zoom Scan (7x7x7)/Cube 0: Measurement grid: dx=8mm, dy=8mm, dz=5mm

Reference Value = 1.36 V/m; Power Drift = 0.185 dB

Peak SAR (extrapolated) = 0.131 W/kg

SAR(1 g) = 0.055 mW/g; SAR(10 g) = 0.024 mW/g

Maximum value of SAR (measured) = 0.060 mW/g

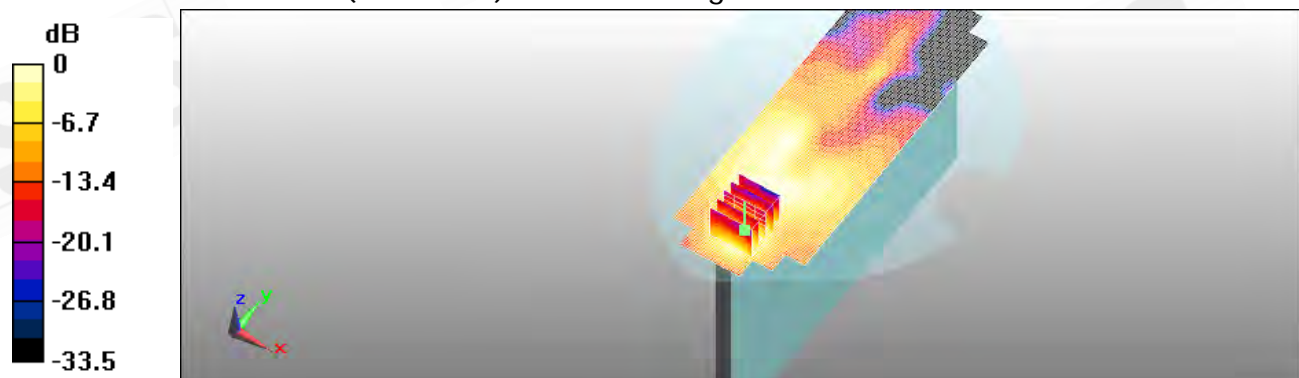

0 dB = 0.060mW/g

Unless otherwise stated the results shown in this test report refer only to the sample(s) tested and such sample(s) are retained for 90 days only.
除非另有說明，此報告結果僅對測試之樣品負責，同時此樣品僅保留90天。本報告未經本公司書面許可，不可部份複製。

This document is issued by the Company subject to its General Conditions of Service printed overleaf, available on request or accessible at www.sgs.com/terms_and_conditions.htm and, for electronic format documents, subject to Terms and Conditions for Electronic Documents at www.sgs.com/terms_e-document.htm. Attention is drawn to the limitation of liability, indemnification and jurisdiction issues defined therein. Any holder of this document is advised that information contained hereon reflects the Company's findings at the time of its intervention only and within the limits of Client's instructions, if any. The Company's sole responsibility is to its Client and this document does not exonerate parties to a transaction from exercising all their rights and obligations under the transaction documents. This document cannot be reproduced except in full, without prior written approval of the Company. Any unauthorized alteration, forgery or falsification of the content or appearance of this document is unlawful and offenders may be prosecuted to the fullest extent of the law.

Date: 2011/1/20

Configuration 2_WLAN802.11g_CH1

DUT: QV3A

Communication System: WLAN802.11 b & g & n; Frequency: 2412 MHz

Medium parameters used: $f = 2412$ MHz; $\sigma = 1.931$ mho/m; $\epsilon_r = 52.652$; $\rho = 1000$ kg/m³

Phantom section: Flat Section

Measurement Standard: DASY5 (IEEE/IEC/ANSI C63.19-2007)

DASY5 Configuration:

- Probe: ES3DV3 - SN3139; ConvF(4.15, 4.15, 4.15); Calibrated: 2/19/2010
- Sensor-Surface: 4mm (Mechanical Surface Detection)
- Electronics: DAE4 Sn856; Calibrated: 5/20/2010
- Phantom: SAM2; Type: SAM;
- Measurement SW: DASY5, V5.2 Build 157; SEMCAD X Version 14.0 Build 57

Configuration/Body/Area Scan (61x201x1): Measurement grid: dx=15mm, dy=15mm

Maximum value of SAR (interpolated) = 0.068 mW/g

Configuration/Body/Zoom Scan (7x7x7)/Cube 0: Measurement grid: dx=8mm, dy=8mm, dz=5mm

Reference Value = 1.42 V/m; Power Drift = 0.199 dB

Peak SAR (extrapolated) = 0.142 W/kg

SAR(1 g) = 0.060 mW/g; SAR(10 g) = 0.027 mW/g

Maximum value of SAR (measured) = 0.066 mW/g

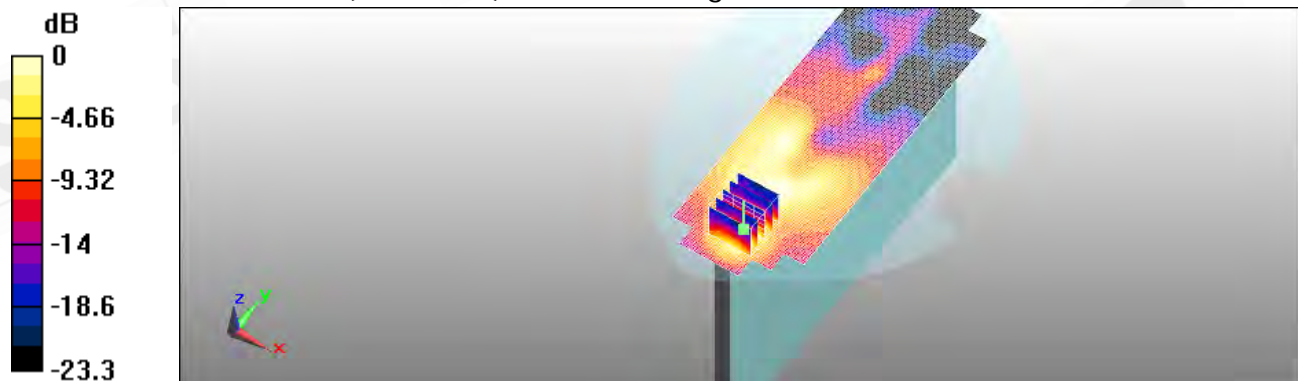

0 dB = 0.066mW/g

Unless otherwise stated the results shown in this test report refer only to the sample(s) tested and such sample(s) are retained for 90 days only.
除非另有說明，此報告結果僅對測試之樣品負責，同時此樣品僅保留90天。本報告未經本公司書面許可，不可部份複製。

This document is issued by the Company subject to its General Conditions of Service printed overleaf, available on request or accessible at www.sgs.com/terms_and_conditions.htm and, for electronic format documents, subject to Terms and Conditions for Electronic Documents at www.sgs.com/terms_e-document.htm. Attention is drawn to the limitation of liability, indemnification and jurisdiction issues defined therein. Any holder of this document is advised that information contained hereon reflects the Company's findings at the time of its intervention only and within the limits of Client's instructions, if any. The Company's sole responsibility is to its Client and this document does not exonerate parties to a transaction from exercising all their rights and obligations under the transaction documents. This document cannot be reproduced except in full, without prior written approval of the Company. Any unauthorized alteration, forgery or falsification of the content or appearance of this document is unlawful and offenders may be prosecuted to the fullest extent of the law.

Date: 2011/1/20

Configuration 2_WLAN802.11n(20M)_CH1

DUT: QV3A

Communication System: WLAN802.11 b & g & n; Frequency: 2412 MHz

Medium parameters used: $f = 2412$ MHz; $\sigma = 1.931$ mho/m; $\epsilon_r = 52.652$; $\rho = 1000$ kg/m³

Phantom section: Flat Section

Measurement Standard: DASYS (IEEE/IEC/ANSI C63.19-2007)

DASY5 Configuration:

- Probe: ES3DV3 - SN3139; ConvF(4.15, 4.15, 4.15); Calibrated: 2/19/2010
- Sensor-Surface: 4mm (Mechanical Surface Detection)
- Electronics: DAE4 Sn856; Calibrated: 5/20/2010
- Phantom: SAM2; Type: SAM;
- Measurement SW: DASYS, V5.2 Build 157; SEMCAD X Version 14.0 Build 57

Configuration/Body/Area Scan (61x201x1): Measurement grid: dx=15mm, dy=15mm

Maximum value of SAR (interpolated) = 0.065 mW/g

Configuration/Body/Zoom Scan (7x7x7)/Cube 0: Measurement grid: dx=8mm, dy=8mm, dz=5mm

Reference Value = 1.45 V/m; Power Drift = 0.010 dB

Peak SAR (extrapolated) = 0.131 W/kg

SAR(1 g) = 0.056 mW/g; SAR(10 g) = 0.025 mW/g

Maximum value of SAR (measured) = 0.061 mW/g

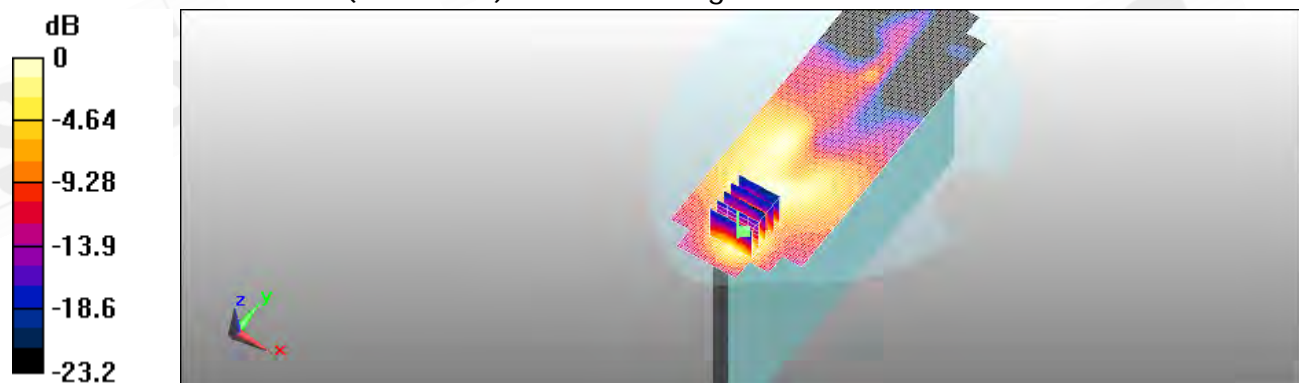

0 dB = 0.061mW/g

Unless otherwise stated the results shown in this test report refer only to the sample(s) tested and such sample(s) are retained for 90 days only.
除非另有說明，此報告結果僅對測試之樣品負責，同時此樣品僅保留90天。本報告未經本公司書面許可，不可部份複製。

This document is issued by the Company subject to its General Conditions of Service printed overleaf, available on request or accessible at www.sgs.com/terms_and_conditions.htm and, for electronic format documents, subject to Terms and Conditions for Electronic Documents at www.sgs.com/terms_e-document.htm. Attention is drawn to the limitation of liability, indemnification and jurisdiction issues defined therein. Any holder of this document is advised that information contained hereon reflects the Company's findings at the time of its intervention only and within the limits of Client's instructions, if any. The Company's sole responsibility is to its Client and this document does not exonerate parties to a transaction from exercising all their rights and obligations under the transaction documents. This document cannot be reproduced except in full, without prior written approval of the Company. Any unauthorized alteration, forgery or falsification of the content or appearance of this document is unlawful and offenders may be prosecuted to the fullest extent of the law.

Date: 2011/1/20

Configuration 3_WLAN802.11b_CH1

DUT: QV3A

Communication System: WLAN802.11 b & g & n; Frequency: 2412 MHz

Medium parameters used: $f = 2412$ MHz; $\sigma = 1.931$ mho/m; $\epsilon_r = 52.652$; $\rho = 1000$ kg/m³

Phantom section: Flat Section

Measurement Standard: DASY5 (IEEE/IEC/ANSI C63.19-2007)

DASY5 Configuration:

- Probe: ES3DV3 - SN3139; ConvF(4.15, 4.15, 4.15); Calibrated: 2/19/2010
- Sensor-Surface: 4mm (Mechanical Surface Detection)
- Electronics: DAE4 Sn856; Calibrated: 5/20/2010
- Phantom: SAM2; Type: SAM;
- Measurement SW: DASY5, V5.2 Build 157; SEMCAD X Version 14.0 Build 57

Configuration/Body/Area Scan (61x201x1): Measurement grid: dx=15mm, dy=15mm

Maximum value of SAR (interpolated) = 0.00445 mW/g

Configuration/Body/Zoom Scan (7x7x7)/Cube 0: Measurement grid: dx=8mm, dy=8mm, dz=5mm

Reference Value = 0.514 V/m; Power Drift = 0.177 dB

Peak SAR (extrapolated) = 0.012 W/kg

SAR(1 g) = 0.00288 mW/g; SAR(10 g) = 0.00133 mW/g

Maximum value of SAR (measured) = 0.00339 mW/g

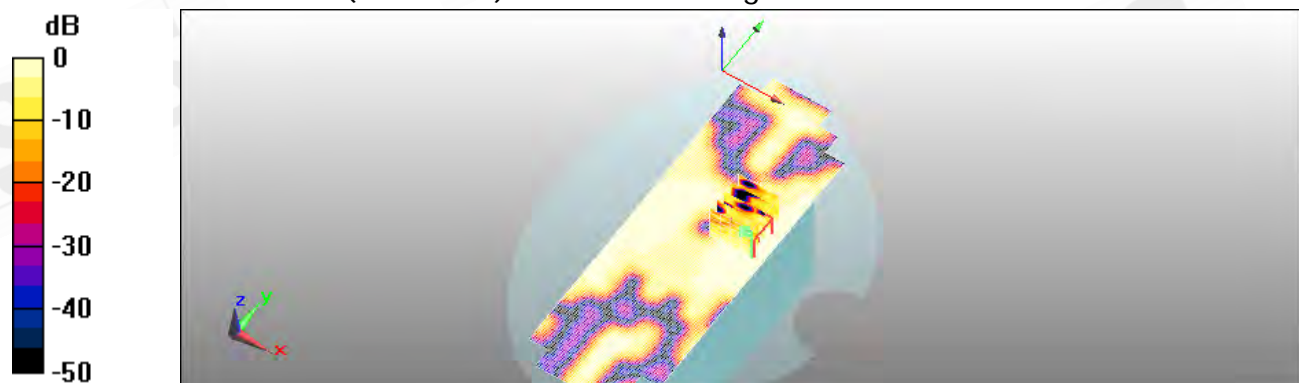

0 dB = 0.00339mW/g

Unless otherwise stated the results shown in this test report refer only to the sample(s) tested and such sample(s) are retained for 90 days only.
除非另有說明，此報告結果僅對測試之樣品負責，同時此樣品僅保留90天。本報告未經本公司書面許可，不可部份複製。

This document is issued by the Company subject to its General Conditions of Service printed overleaf, available on request or accessible at www.sgs.com/terms_and_conditions.htm and, for electronic format documents, subject to Terms and Conditions for Electronic Documents at www.sgs.com/terms_e-document.htm. Attention is drawn to the limitation of liability, indemnification and jurisdiction issues defined therein. Any holder of this document is advised that information contained hereon reflects the Company's findings at the time of its intervention only and within the limits of Client's instructions, if any. The Company's sole responsibility is to its Client and this document does not exonerate parties to a transaction from exercising all their rights and obligations under the transaction documents. This document cannot be reproduced except in full, without prior written approval of the Company. Any unauthorized alteration, forgery or falsification of the content or appearance of this document is unlawful and offenders may be prosecuted to the fullest extent of the law.

Date: 2011/1/20

Configuration 3_WLAN802.11g_CH1

DUT: QV3A

Communication System: WLAN802.11 b & g & n; Frequency: 2412 MHz
Medium parameters used: $f = 2412$ MHz; $\sigma = 1.931$ mho/m; $\epsilon_r = 52.652$; $\rho = 1000$ kg/m³
Phantom section: Flat Section
Measurement Standard: DASY5 (IEEE/IEC/ANSI C63.19-2007)
DASY5 Configuration:

- Probe: ES3DV3 - SN3139; ConvF(4.15, 4.15, 4.15); Calibrated: 2/19/2010
- Sensor-Surface: 4mm (Mechanical Surface Detection)
- Electronics: DAE4 Sn856; Calibrated: 5/20/2010
- Phantom: SAM2; Type: SAM;
- Measurement SW: DASY5, V5.2 Build 157; SEMCAD X Version 14.0 Build 57

Configuration/Body/Area Scan (61x201x1): Measurement grid: dx=15mm, dy=15mm

Maximum value of SAR (interpolated) = 0.00509 mW/g

Configuration/Body/Zoom Scan (7x7x7)/Cube 0: Measurement grid: dx=8mm, dy=8mm, dz=5mm

Reference Value = 0.785 V/m; Power Drift = 0.154 dB

Peak SAR (extrapolated) = 0.012 W/kg

SAR(1 g) = 0.00339 mW/g; SAR(10 g) = 0.00159 mW/g

Maximum value of SAR (measured) = 0.00402 mW/g

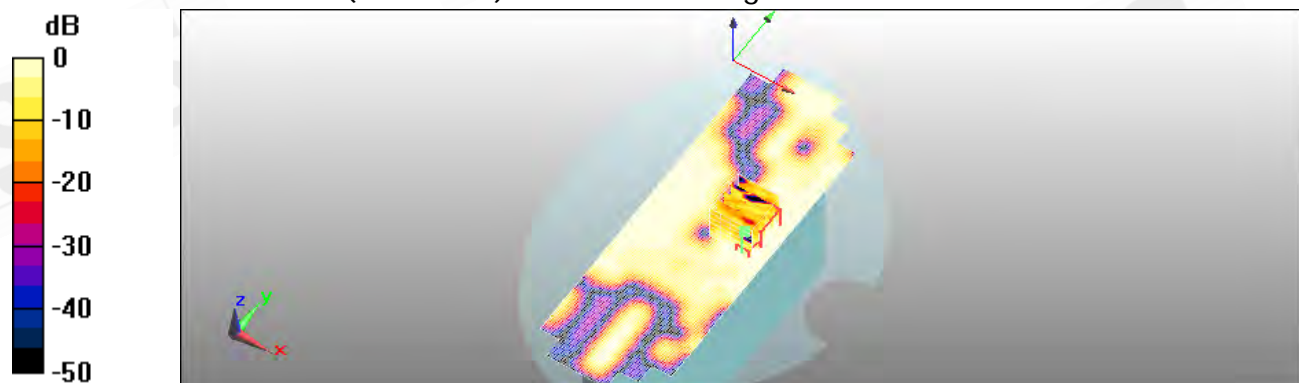

0 dB = 0.00402mW/g

Unless otherwise stated the results shown in this test report refer only to the sample(s) tested and such sample(s) are retained for 90 days only.
除非另有說明，此報告結果僅對測試之樣品負責，同時此樣品僅保留90天。本報告未經本公司書面許可，不可部份複製。

This document is issued by the Company subject to its General Conditions of Service printed overleaf, available on request or accessible at www.sgs.com/terms_and_conditions.htm and, for electronic format documents, subject to Terms and Conditions for Electronic Documents at www.sgs.com/terms_e-document.htm. Attention is drawn to the limitation of liability, indemnification and jurisdiction issues defined therein. Any holder of this document is advised that information contained hereon reflects the Company's findings at the time of its intervention only and within the limits of Client's instructions, if any. The Company's sole responsibility is to its Client and this document does not exonerate parties to a transaction from exercising all their rights and obligations under the transaction documents. This document cannot be reproduced except in full, without prior written approval of the Company. Any unauthorized alteration, forgery or falsification of the content or appearance of this document is unlawful and offenders may be prosecuted to the fullest extent of the law.

Date: 2011/1/20

Configuration 3_WLAN802.11n(20M)_CH1

DUT: QV3A

Communication System: WLAN802.11 b & g & n; Frequency: 2412 MHz
Medium parameters used: $f = 2412$ MHz; $\sigma = 1.931$ mho/m; $\epsilon_r = 52.652$; $\rho = 1000$ kg/m³
Phantom section: Flat Section
Measurement Standard: DASYS (IEEE/IEC/ANSI C63.19-2007)
DASY5 Configuration:

- Probe: ES3DV3 - SN3139; ConvF(4.15, 4.15, 4.15); Calibrated: 2/19/2010
- Sensor-Surface: 4mm (Mechanical Surface Detection)
- Electronics: DAE4 Sn856; Calibrated: 5/20/2010
- Phantom: SAM2; Type: SAM;
- Measurement SW: DASYS, V5.2 Build 157; SEMCAD X Version 14.0 Build 57

Configuration/Body/Area Scan (61x201x1): Measurement grid: dx=15mm, dy=15mm

Maximum value of SAR (interpolated) = 0.00546 mW/g

Configuration/Body/Zoom Scan (7x7x7)/Cube 0: Measurement grid: dx=8mm, dy=8mm, dz=5mm

Reference Value = 0.836 V/m; Power Drift = -0.184 dB

Peak SAR (extrapolated) = 0.00919 W/kg

SAR(1 g) = 0.00288 mW/g; SAR(10 g) = 0.00112 mW/g

Maximum value of SAR (measured) = 0.00302 mW/g



0 dB = 0.00302mW/g

Unless otherwise stated the results shown in this test report refer only to the sample(s) tested and such sample(s) are retained for 90 days only.
除非另有說明，此報告結果僅對測試之樣品負責，同時此樣品僅保留90天。本報告未經本公司書面許可，不可部份複製。

This document is issued by the Company subject to its General Conditions of Service printed overleaf, available on request or accessible at www.sgs.com/terms_and_conditions.htm and, for electronic format documents, subject to Terms and Conditions for Electronic Documents at www.sgs.com/terms_e-document.htm. Attention is drawn to the limitation of liability, indemnification and jurisdiction issues defined therein. Any holder of this document is advised that information contained hereon reflects the Company's findings at the time of its intervention only and within the limits of Client's instructions, if any. The Company's sole responsibility is to its Client and this document does not exonerate parties to a transaction from exercising all their rights and obligations under the transaction documents. This document cannot be reproduced except in full, without prior written approval of the Company. Any unauthorized alteration, forgery or falsification of the content or appearance of this document is unlawful and offenders may be prosecuted to the fullest extent of the law.

Date: 2011/1/20

Configuration 5_WLAN802.11b_CH1

DUT: QV3A

Communication System: WLAN802.11 b & g & n; Frequency: 2412 MHz

Medium parameters used: $f = 2412$ MHz; $\sigma = 1.931$ mho/m; $\epsilon_r = 52.652$; $\rho = 1000$ kg/m³

Phantom section: Flat Section

Measurement Standard: DASYS (IEEE/IEC/ANSI C63.19-2007)

DASY5 Configuration:

- Probe: ES3DV3 - SN3139; ConvF(4.15, 4.15, 4.15); Calibrated: 2/19/2010
- Sensor-Surface: 4mm (Mechanical Surface Detection)
- Electronics: DAE4 Sn856; Calibrated: 5/20/2010
- Phantom: SAM2; Type: SAM;
- Measurement SW: DASY5, V5.2 Build 157; SEMCAD X Version 14.0 Build 57

Configuration/Body/Area Scan (61x151x1): Measurement grid: dx=15mm, dy=15mm

Maximum value of SAR (interpolated) = 0.013 mW/g

Configuration/Body/Zoom Scan (7x7x7)/Cube 0: Measurement grid: dx=8mm, dy=8mm, dz=5mm

Reference Value = 1.12 V/m; Power Drift = 0.07 dB

Peak SAR (extrapolated) = 0.026 W/kg

SAR(1 g) = 0.011 mW/g; SAR(10 g) = 0.00531 mW/g

Maximum value of SAR (measured) = 0.014 mW/g

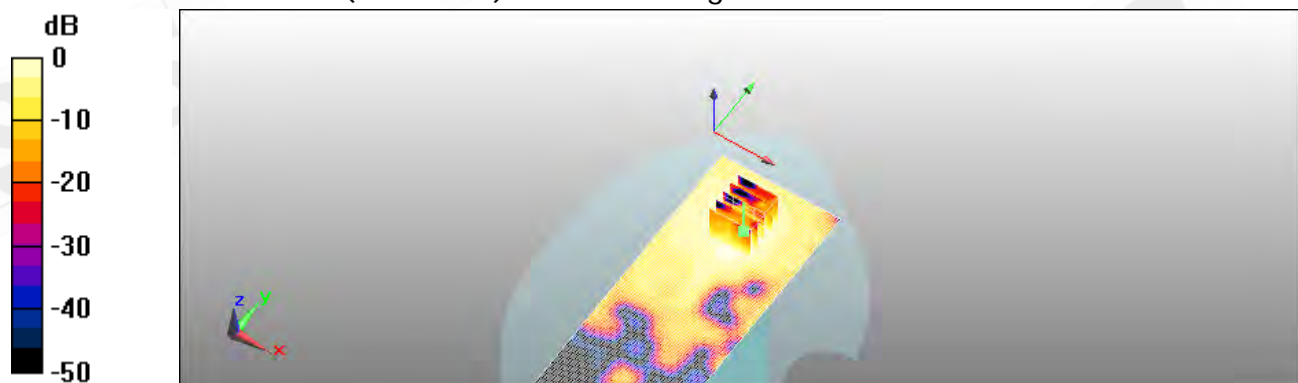

0 dB = 0.014mW/g

Unless otherwise stated the results shown in this test report refer only to the sample(s) tested and such sample(s) are retained for 90 days only.
除非另有說明，此報告結果僅對測試之樣品負責，同時此樣品僅保留90天。本報告未經本公司書面許可，不可部份複製。

This document is issued by the Company subject to its General Conditions of Service printed overleaf, available on request or accessible at www.sgs.com/terms_and_conditions.htm and, for electronic format documents, subject to Terms and Conditions for Electronic Documents at www.sgs.com/terms_e-document.htm. Attention is drawn to the limitation of liability, indemnification and jurisdiction issues defined therein. Any holder of this document is advised that information contained hereon reflects the Company's findings at the time of its intervention only and within the limits of Client's instructions, if any. The Company's sole responsibility is to its Client and this document does not exonerate parties to a transaction from exercising all their rights and obligations under the transaction documents. This document cannot be reproduced except in full, without prior written approval of the Company. Any unauthorized alteration, forgery or falsification of the content or appearance of this document is unlawful and offenders may be prosecuted to the fullest extent of the law.

Date: 2011/1/20

Configuration 5_WLAN802.11g_CH1

DUT: QV3A

Communication System: WLAN802.11 b & g & n; Frequency: 2412 MHz

Medium parameters used: $f = 2412$ MHz; $\sigma = 1.931$ mho/m; $\epsilon_r = 52.652$; $\rho = 1000$ kg/m³

Phantom section: Flat Section

Measurement Standard: DASYS (IEEE/IEC/ANSI C63.19-2007)

DASY5 Configuration:

- Probe: ES3DV3 - SN3139; ConvF(4.15, 4.15, 4.15); Calibrated: 2/19/2010
- Sensor-Surface: 4mm (Mechanical Surface Detection)
- Electronics: DAE4 Sn856; Calibrated: 5/20/2010
- Phantom: SAM2; Type: SAM;
- Measurement SW: DASY5, V5.2 Build 157; SEMCAD X Version 14.0 Build 57

Configuration/Body/Area Scan (61x151x1): Measurement grid: dx=15mm, dy=15mm

Maximum value of SAR (interpolated) = 0.013 mW/g

Configuration/Body/Zoom Scan (7x7x7)/Cube 0: Measurement grid: dx=8mm, dy=8mm, dz=5mm

Reference Value = 1.19 V/m; Power Drift = 0.190 dB

Peak SAR (extrapolated) = 0.028 W/kg

SAR(1 g) = 0.012 mW/g; SAR(10 g) = 0.00579 mW/g

Maximum value of SAR (measured) = 0.014 mW/g

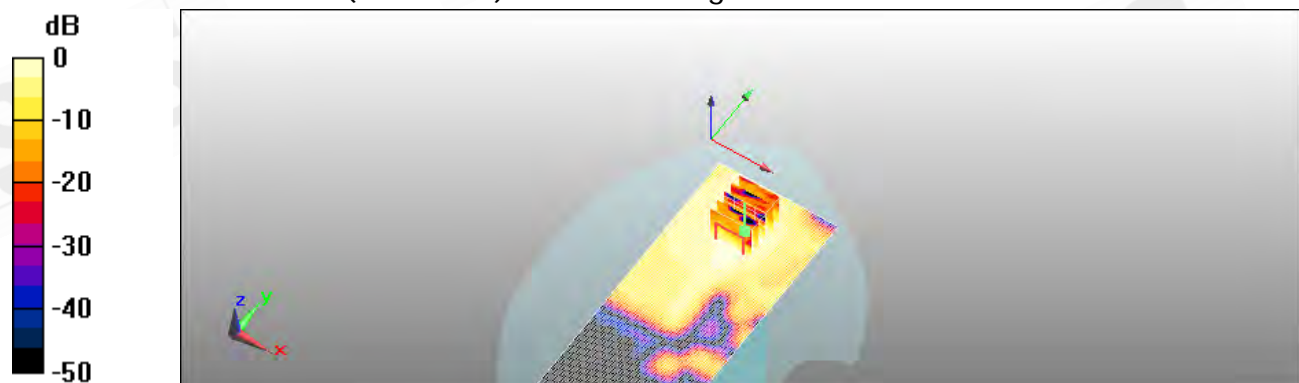

0 dB = 0.014mW/g

Unless otherwise stated the results shown in this test report refer only to the sample(s) tested and such sample(s) are retained for 90 days only.
除非另有說明，此報告結果僅對測試之樣品負責，同時此樣品僅保留90天。本報告未經本公司書面許可，不可部份複製。

This document is issued by the Company subject to its General Conditions of Service printed overleaf, available on request or accessible at www.sgs.com/terms_and_conditions.htm and, for electronic format documents, subject to Terms and Conditions for Electronic Documents at www.sgs.com/terms_e-document.htm. Attention is drawn to the limitation of liability, indemnification and jurisdiction issues defined therein. Any holder of this document is advised that information contained hereon reflects the Company's findings at the time of its intervention only and within the limits of Client's instructions, if any. The Company's sole responsibility is to its Client and this document does not exonerate parties to a transaction from exercising all their rights and obligations under the transaction documents. This document cannot be reproduced except in full, without prior written approval of the Company. Any unauthorized alteration, forgery or falsification of the content or appearance of this document is unlawful and offenders may be prosecuted to the fullest extent of the law.

Date: 2011/1/20

Configuration 5_WLAN802.11n(20M)_CH1

DUT: QV3A

Communication System: WLAN802.11 b & g & n; Frequency: 2412 MHz
Medium parameters used: $f = 2412$ MHz; $\sigma = 1.931$ mho/m; $\epsilon_r = 52.652$; $\rho = 1000$ kg/m³
Phantom section: Flat Section
Measurement Standard: DASY5 (IEEE/IEC/ANSI C63.19-2007)
DASY5 Configuration:

- Probe: ES3DV3 - SN3139; ConvF(4.15, 4.15, 4.15); Calibrated: 2/19/2010
- Sensor-Surface: 4mm (Mechanical Surface Detection)
- Electronics: DAE4 Sn856; Calibrated: 5/20/2010
- Phantom: SAM2; Type: SAM;
- Measurement SW: DASY5, V5.2 Build 157; SEMCAD X Version 14.0 Build 57

Configuration/Body/Area Scan (61x151x1): Measurement grid: dx=15mm, dy=15mm

Maximum value of SAR (interpolated) = 0.012 mW/g

Configuration/Body/Zoom Scan (7x7x7)/Cube 0: Measurement grid: dx=8mm, dy=8mm, dz=5mm

Reference Value = 0.994 V/m; Power Drift = 0.183 dB

Peak SAR (extrapolated) = 0.023 W/kg

SAR(1 g) = 0.011 mW/g; SAR(10 g) = 0.00524 mW/g

Maximum value of SAR (measured) = 0.014 mW/g

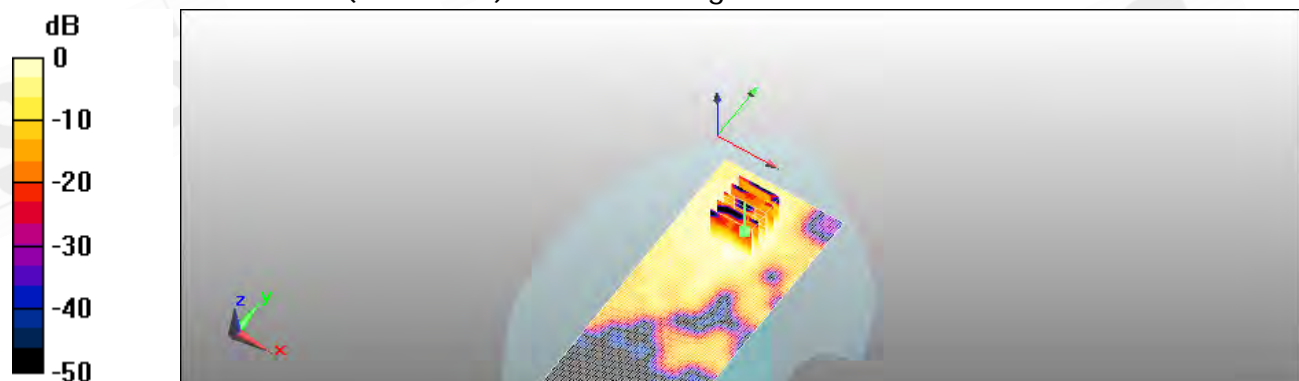

0 dB = 0.014mW/g

Unless otherwise stated the results shown in this test report refer only to the sample(s) tested and such sample(s) are retained for 90 days only.
除非另有說明，此報告結果僅對測試之樣品負責，同時此樣品僅保留90天。本報告未經本公司書面許可，不可部份複製。

This document is issued by the Company subject to its General Conditions of Service printed overleaf, available on request or accessible at www.sgs.com/terms_and_conditions.htm and, for electronic format documents, subject to Terms and Conditions for Electronic Documents at www.sgs.com/terms_e-document.htm. Attention is drawn to the limitation of liability, indemnification and jurisdiction issues defined therein. Any holder of this document is advised that information contained hereon reflects the Company's findings at the time of its intervention only and within the limits of Client's instructions, if any. The Company's sole responsibility is to its Client and this document does not exonerate parties to a transaction from exercising all their rights and obligations under the transaction documents. This document cannot be reproduced except in full, without prior written approval of the Company. Any unauthorized alteration, forgery or falsification of the content or appearance of this document is unlawful and offenders may be prosecuted to the fullest extent of the law.

5. SAR System Performance Verification

Date: 2011/1/20

DUT: Dipole 2450 MHz;

Communication System: CW; Frequency: 2450 MHz; Duty Cycle: 1:1

 Medium parameters used: $f = 2450$ MHz; $\sigma = 1.97$ mho/m; $\epsilon_r = 52.5$; $\rho = 1000$ kg/m³

Phantom section: Flat Section

Measurement Standard: DASYS (IEEE/IEC/ANSI C63.19-2007)

DASYS Configuration:

- Probe: ES3DV3 - SN3139; ConvF(4.15, 4.15, 4.15); Calibrated: 2/19/2010
- Sensor-Surface: 4mm (Mechanical Surface Detection)
- Electronics: DAE4 Sn856; Calibrated: 5/20/2010
- Phantom: SAM2; Type: SAM;
- Measurement SW: DASYS, V5.2 Build 157; SEMCAD X Version 14.0 Build 57

d=10mm, Pin=250mW, dist=4mm : Measurement grid: dx=15mm, dy=15mm
 Maximum value of SAR (interpolated) = 17.3 mW/g

d=10mm, Pin=250mW, dist=4mm : Measurement grid: dx=5mm, dy=5mm,
 dz=5mm

Reference Value = 94 V/m; Power Drift = -0.025 dB

Peak SAR (extrapolated) = 28.1 W/kg

SAR(1 g) = 13.2 mW/g; SAR(10 g) = 6.17 mW/g

Maximum value of SAR (measured) = 16.8 mW/g

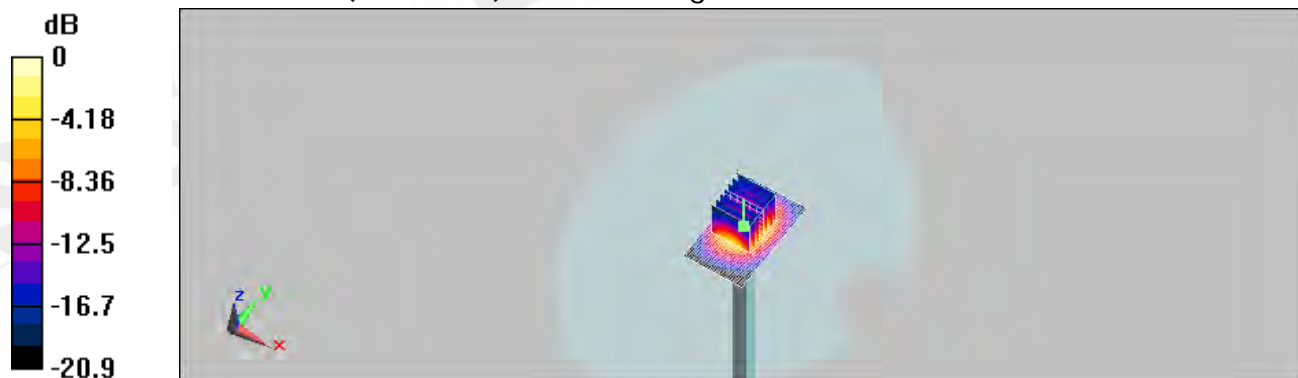

0 dB = 16.8mW/g

Unless otherwise stated the results shown in this test report refer only to the sample(s) tested and such sample(s) are retained for 90 days only.
 除非另有說明，此報告結果僅對測試之樣品負責，同時此樣品僅保留90天。本報告未經本公司書面許可，不可部份複製。

This document is issued by the Company subject to its General Conditions of Service printed overleaf, available on request or accessible at www.sgs.com/terms_and_conditions.htm and, for electronic format documents, subject to Terms and Conditions for Electronic Documents at www.sgs.com/terms_e-document.htm. Attention is drawn to the limitation of liability, indemnification and jurisdiction issues defined therein. Any holder of this document is advised that information contained hereon reflects the Company's findings at the time of its intervention only and within the limits of Client's instructions, if any. The Company's sole responsibility is to its Client and this document does not exonerate parties to a transaction from exercising all their rights and obligations under the transaction documents. This document cannot be reproduced except in full, without prior written approval of the Company. Any unauthorized alteration, forgery or falsification of the content or appearance of this document is unlawful and offenders may be prosecuted to the fullest extent of the law.

6. DAE & Probe Calibration certificate

**Calibration Laboratory of
Schmid & Partner
Engineering AG**
Zueghausstrasse 43, 8004 Zurich, Switzerland



S Schweizerischer Kalibrierdienst
C Service suisse d'étalonnage
S Servizio svizzero di taratura
S Swiss Calibration Service

Accredited by the Swiss Accreditation Service (SAS)
The Swiss Accreditation Service is one of the signatories to the EA
Multilateral Agreement for the recognition of calibration certificates

Accreditation No.: **SCS 108**

Client **SGS-TW (Auden)**

Certificate No: **DAE4-856_May10**

CALIBRATION CERTIFICATE

Object: **DAE4 - SD 000 D04 BJ - SN: 856**

Calibration procedure(s): **QA CAL-06,v21
Calibration procedure for the data acquisition electronics (DAE)**

Calibration date: **May 20, 2010**

This calibration certificate documents the traceability to national standards, which realize the physical units of measurements (SI).
The measurements and the uncertainties with confidence probability are given on the following pages and are part of the certificate.

All calibrations have been conducted in the closed laboratory facility: environment temperature (22 ± 3)°C and humidity < 70%.

Calibration Equipment used (M&TE critical for calibration)

Primary Standards	ID #	Cal Date (Certificate No.)	Scheduled Calibration
Keithley Multimeter Type 2001	SN: 0810278	1-Oct-09 (No: 9055)	Oct-10
Secondary Standards	ID #	Check Date (in house)	Scheduled Check
Calibrator Box V1.1	SE UMS 006 AB 1004	05-Jun-09 (in house check)	In house check: Jun-10

Calibrated by:	Name	Function	Signature
	Dominique Steffen	Technician	
Approved by:	Name	Function	Signature
	Fin Bornholt	R&D Director	

Issued: May 20, 2010

This calibration certificate shall not be reproduced except in full without written approval of the laboratory.

Unless otherwise stated the results shown in this test report refer only to the sample(s) tested and such sample(s) are retained for 90 days only.
除非另有說明，此報告結果僅對測試之樣品負責，同時此樣品僅保留90天。本報告未經本公司書面許可，不可部份複製。

This document is issued by the Company subject to its General Conditions of Service printed overleaf, available on request or accessible at www.sgs.com/terms_and_conditions.htm and, for electronic format documents, subject to Terms and Conditions for Electronic Documents at www.sgs.com/terms_e-document.htm. Attention is drawn to the limitation of liability, indemnification and jurisdiction issues defined therein. Any holder of this document is advised that information contained hereon reflects the Company's findings at the time of its intervention only and within the limits of Client's instructions, if any. The Company's sole responsibility is to its Client and this document does not exonerate parties to a transaction from exercising all their rights and obligations under the transaction documents. This document cannot be reproduced except in full, without prior written approval of the Company. Any unauthorized alteration, forgery or falsification of the content or appearance of this document is unlawful and offenders may be prosecuted to the fullest extent of the law.

**Calibration Laboratory of
Schmid & Partner
Engineering AG**
Zeughausstrasse 43, 8004 Zurich, Switzerland



S Schweizerischer Kalibrierdienst
S Service suisse d'étalonnage
C Servizio svizzero di taratura
S Swiss Calibration Service

Accredited by the Swiss Accreditation Service (SAS)
The Swiss Accreditation Service is one of the signatories to the EA
Multilateral Agreement for the recognition of calibration certificates

Accreditation No.: **SCS 108**

Client **Sunway (Auden)**

Certificate No: **ES3-3139_Feb10**

CALIBRATION CERTIFICATE																																																			
Object	ES3DV3 - SN:3139																																																		
Calibration procedure(s)	QA CAL-01.v6, QA CAL-23.v3 and QA CAL-25.v2 Calibration procedure for dosimetric E-field probes																																																		
Calibration date:	February 19, 2010																																																		
<p>This calibration certificate documents the traceability to national standards, which realize the physical units of measurements (SI). The measurements and the uncertainties with confidence probability are given on the following pages and are part of the certificate.</p> <p>All calibrations have been conducted in the closed laboratory facility: environment temperature (22 ± 3)°C and humidity < 70%.</p> <p>Calibration Equipment used (M&TE critical for calibration)</p> <table border="1"> <thead> <tr> <th>Primary Standards</th> <th>ID #</th> <th>Cal Date (Certificate No.)</th> <th>Scheduled Calibration</th> </tr> </thead> <tbody> <tr> <td>Power meter E4419B</td> <td>GB41293874</td> <td>1-Apr-09 (No. 217-01030)</td> <td>Apr-10</td> </tr> <tr> <td>Power sensor E4412A</td> <td>MY41495277</td> <td>1-Apr-09 (No. 217-01030)</td> <td>Apr-10</td> </tr> <tr> <td>Power sensor E4412A</td> <td>MY41498087</td> <td>1-Apr-09 (No. 217-01030)</td> <td>Apr-10</td> </tr> <tr> <td>Reference 3 dB Attenuator</td> <td>SN: S5054 (3c)</td> <td>31-Mar-09 (No. 217-01026)</td> <td>Mar-10</td> </tr> <tr> <td>Reference 20 dB Attenuator</td> <td>SN: S5086 (20b)</td> <td>31-Mar-09 (No. 217-01028)</td> <td>Mar-10</td> </tr> <tr> <td>Reference 30 dB Attenuator</td> <td>SN: S5129 (30b)</td> <td>31-Mar-09 (No. 217-01027)</td> <td>Mar-10</td> </tr> <tr> <td>Reference Probe ES3DV2</td> <td>SN: 3013</td> <td>30-Dec-09 (No. ES3-3013_Dec09)</td> <td>Dec-10</td> </tr> <tr> <td>DAE4</td> <td>SN: 660</td> <td>29-Sep-09 (No. DAE4-660_Sep09)</td> <td>Sep-10</td> </tr> </tbody> </table> <table border="1"> <thead> <tr> <th>Secondary Standards</th> <th>ID #</th> <th>Check Date (in house)</th> <th>Scheduled Check</th> </tr> </thead> <tbody> <tr> <td>RF generator HP 8648C</td> <td>US3642U01700</td> <td>4-Aug-99 (in house check Oct-09)</td> <td>In house check: Oct-11</td> </tr> <tr> <td>Network Analyzer HP 8753E</td> <td>US37390585</td> <td>18-Oct-01 (in house check Oct-09)</td> <td>In house check: Oct-10</td> </tr> </tbody> </table>				Primary Standards	ID #	Cal Date (Certificate No.)	Scheduled Calibration	Power meter E4419B	GB41293874	1-Apr-09 (No. 217-01030)	Apr-10	Power sensor E4412A	MY41495277	1-Apr-09 (No. 217-01030)	Apr-10	Power sensor E4412A	MY41498087	1-Apr-09 (No. 217-01030)	Apr-10	Reference 3 dB Attenuator	SN: S5054 (3c)	31-Mar-09 (No. 217-01026)	Mar-10	Reference 20 dB Attenuator	SN: S5086 (20b)	31-Mar-09 (No. 217-01028)	Mar-10	Reference 30 dB Attenuator	SN: S5129 (30b)	31-Mar-09 (No. 217-01027)	Mar-10	Reference Probe ES3DV2	SN: 3013	30-Dec-09 (No. ES3-3013_Dec09)	Dec-10	DAE4	SN: 660	29-Sep-09 (No. DAE4-660_Sep09)	Sep-10	Secondary Standards	ID #	Check Date (in house)	Scheduled Check	RF generator HP 8648C	US3642U01700	4-Aug-99 (in house check Oct-09)	In house check: Oct-11	Network Analyzer HP 8753E	US37390585	18-Oct-01 (in house check Oct-09)	In house check: Oct-10
Primary Standards	ID #	Cal Date (Certificate No.)	Scheduled Calibration																																																
Power meter E4419B	GB41293874	1-Apr-09 (No. 217-01030)	Apr-10																																																
Power sensor E4412A	MY41495277	1-Apr-09 (No. 217-01030)	Apr-10																																																
Power sensor E4412A	MY41498087	1-Apr-09 (No. 217-01030)	Apr-10																																																
Reference 3 dB Attenuator	SN: S5054 (3c)	31-Mar-09 (No. 217-01026)	Mar-10																																																
Reference 20 dB Attenuator	SN: S5086 (20b)	31-Mar-09 (No. 217-01028)	Mar-10																																																
Reference 30 dB Attenuator	SN: S5129 (30b)	31-Mar-09 (No. 217-01027)	Mar-10																																																
Reference Probe ES3DV2	SN: 3013	30-Dec-09 (No. ES3-3013_Dec09)	Dec-10																																																
DAE4	SN: 660	29-Sep-09 (No. DAE4-660_Sep09)	Sep-10																																																
Secondary Standards	ID #	Check Date (in house)	Scheduled Check																																																
RF generator HP 8648C	US3642U01700	4-Aug-99 (in house check Oct-09)	In house check: Oct-11																																																
Network Analyzer HP 8753E	US37390585	18-Oct-01 (in house check Oct-09)	In house check: Oct-10																																																
Calibrated by:	Name Katja Pokovic	Function Technical Manager	Signature 																																																
Approved by:	Name Niels Kuster	Function Quality Manager																																																	
This calibration certificate shall not be reproduced except in full without written approval of the laboratory.			Issued: February 22, 2010																																																

Certificate No: ES3-3139_Feb10

Page 1 of 11

Unless otherwise stated the results shown in this test report refer only to the sample(s) tested and such sample(s) are retained for 90 days only.
除非另有說明，此報告結果僅對測試之樣品負責，同時此樣品僅保留90天。本報告未經本公司書面許可，不可部份複製。

This document is issued by the Company subject to its General Conditions of Service printed overleaf, available on request or accessible at www.sgs.com/terms_and_conditions.htm and, for electronic format documents, subject to Terms and Conditions for Electronic Documents at www.sgs.com/terms_e-document.htm. Attention is drawn to the limitation of liability, indemnification and jurisdiction issues defined therein. Any holder of this document is advised that information contained hereon reflects the Company's findings at the time of its intervention only and within the limits of Client's instructions, if any. The Company's sole responsibility is to its Client and this document does not exonerate parties to a transaction from exercising all their rights and obligations under the transaction documents. This document cannot be reproduced except in full, without prior written approval of the Company. Any unauthorized alteration, forgery or falsification of the content or appearance of this document is unlawful and offenders may be prosecuted to the fullest extent of the law.

**Calibration Laboratory of
Schmid & Partner
Engineering AG**
Zeughausstrasse 43, 8004 Zurich, Switzerland



S Schweizerischer Kalibrierdienst
S Service suisse d'étalonnage
C Servizio svizzero di taratura
S Swiss Calibration Service

Accredited by the Swiss Accreditation Service (SAS)
The Swiss Accreditation Service is one of the signatories to the EA
Multilateral Agreement for the recognition of calibration certificates

Accreditation No.: **SCS 108**

Glossary:

TSL	tissue simulating liquid
NORM _{x,y,z}	sensitivity in free space
ConvF	sensitivity in TSL / NORM _{x,y,z}
DCP	diode compression point
CF	crest factor (1/duty_cycle) of the RF signal
A, B, C	modulation dependent linearization parameters
Polarization φ	φ rotation around probe axis
Polarization θ	θ rotation around an axis that is in the plane normal to probe axis (at measurement center), i.e., θ = 0 is normal to probe axis

Calibration is Performed According to the Following Standards:

- a) IEEE Std 1528-2003, "IEEE Recommended Practice for Determining the Peak Spatial-Averaged Specific Absorption Rate (SAR) in the Human Head from Wireless Communications Devices: Measurement Techniques", December 2003
- b) IEC 62209-1, "Procedure to measure the Specific Absorption Rate (SAR) for hand-held devices used in close proximity to the ear (frequency range of 300 MHz to 3 GHz)", February 2005

Methods Applied and Interpretation of Parameters:

- **NORM_{x,y,z}**: Assessed for E-field polarization θ = 0 (f ≤ 900 MHz in TEM-cell; f > 1800 MHz: R22 waveguide). NORM_{x,y,z} are only intermediate values, i.e., the uncertainties of NORM_{x,y,z} does not effect the E²-field uncertainty inside TSL (see below ConvF).
- **NORM(f)_{x,y,z}** = NORM_{x,y,z} * frequency_response (see Frequency Response Chart). This linearization is implemented in DASY4 software versions later than 4.2. The uncertainty of the frequency response is included in the stated uncertainty of ConvF.
- **DCP_{x,y,z}**: DCP are numerical linearization parameters assessed based on the data of power sweep with CW signal (no uncertainty required). DCP does not depend on frequency nor media.
- **A_{x,y,z}; B_{x,y,z}; C_{x,y,z}; VR_{x,y,z}**: A, B, C are numerical linearization parameters assessed based on the data of power sweep for specific modulation signal. The parameters do not depend on frequency nor media. VR is the maximum calibration range expressed in RMS voltage across the diode.
- **ConvF and Boundary Effect Parameters**: Assessed in flat phantom using E-field (or Temperature Transfer Standard for f ≤ 800 MHz) and inside waveguide using analytical field distributions based on power measurements for f > 800 MHz. The same setups are used for assessment of the parameters applied for boundary compensation (alpha, depth) of which typical uncertainty values are given. These parameters are used in DASY4 software to improve probe accuracy close to the boundary. The sensitivity in TSL corresponds to NORM_{x,y,z} * ConvF whereby the uncertainty corresponds to that given for ConvF. A frequency dependent ConvF is used in DASY version 4.4 and higher which allows extending the validity from ± 50 MHz to ± 100 MHz.
- **Spherical isotropy (3D deviation from isotropy)**: in a field of low gradients realized using a flat phantom exposed by a patch antenna.
- **Sensor Offset**: The sensor offset corresponds to the offset of virtual measurement center from the probe tip (on probe axis). No tolerance required.

Unless otherwise stated the results shown in this test report refer only to the sample(s) tested and such sample(s) are retained for 90 days only.
除非另有說明，此報告結果僅對測試之樣品負責，同時此樣品僅保留90天。本報告未經本公司書面許可，不可部份複製。

This document is issued by the Company subject to its General Conditions of Service printed overleaf, available on request or accessible at www.sgs.com/terms_and_conditions.htm and, for electronic format documents, subject to Terms and Conditions for Electronic Documents at www.sgs.com/terms_e-document.htm. Attention is drawn to the limitation of liability, indemnification and jurisdiction issues defined therein. Any holder of this document is advised that information contained hereon reflects the Company's findings at the time of its intervention only and within the limits of Client's instructions, if any. The Company's sole responsibility is to its Client and this document does not exonerate parties to a transaction from exercising all their rights and obligations under the transaction documents. This document cannot be reproduced except in full, without prior written approval of the Company. Any unauthorized alteration, forgery or falsification of the content or appearance of this document is unlawful and offenders may be prosecuted to the fullest extent of the law.

ES3DV3 SN:3139

February 19, 2010

Probe ES3DV3

SN:3139

Manufactured: February 12, 2007
Calibrated: February 19, 2010

Calibrated for DASY Systems

(Note: non-compatible with DASY2 system!)

Unless otherwise stated the results shown in this test report refer only to the sample(s) tested and such sample(s) are retained for 90 days only.
除非另有說明，此報告結果僅對測試之樣品負責，同時此樣品僅保留90天。本報告未經本公司書面許可，不可部份複製。

This document is issued by the Company subject to its General Conditions of Service printed overleaf, available on request or accessible at www.sgs.com/terms_and_conditions.htm and, for electronic format documents, subject to Terms and Conditions for Electronic Documents at www.sgs.com/terms_e-document.htm. Attention is drawn to the limitation of liability, indemnification and jurisdiction issues defined therein. Any holder of this document is advised that information contained hereon reflects the Company's findings at the time of its intervention only and within the limits of Client's instructions, if any. The Company's sole responsibility is to its Client and this document does not exonerate parties to a transaction from exercising all their rights and obligations under the transaction documents. This document cannot be reproduced except in full, without prior written approval of the Company. Any unauthorized alteration, forgery or falsification of the content or appearance of this document is unlawful and offenders may be prosecuted to the fullest extent of the law.

ES3DV3 SN:3139

February 19, 2010

DASY - Parameters of Probe: ES3DV3 SN:3139
Basic Calibration Parameters

	Sensor X	Sensor Y	Sensor Z	Unc (k=2)
Norm ($\mu\text{V}/(\text{V}/\text{m})^2$) ^A	1.33	1.36	1.36	$\pm 10.1\%$
DCP (mV) ^B	95.2	93.8	92.3	

Modulation Calibration Parameters

UID	Communication System Name	PAR		A dB	B dBuV	C	VR mV	Unc (k=2)
10000	CW	0.00	X	0.00	0.00	1.00	300	$\pm 1.5\%$
			Y	0.00	0.00	1.00	300	
			Z	0.00	0.00	1.00	300	

The reported uncertainty of measurement is stated as the standard uncertainty of measurement multiplied by the coverage factor k=2, which for a normal distribution corresponds to a coverage probability of approximately 95%.

^A The uncertainties of NormX,Y,Z do not affect the E²-field uncertainty inside TSL (see Pages 5 and 6).

^B Numerical linearization parameter: uncertainty not required.

Unless otherwise stated the results shown in this test report refer only to the sample(s) tested and such sample(s) are retained for 90 days only.
 除非另有說明，此報告結果僅對測試之樣品負責，同時此樣品僅保留90天。本報告未經本公司書面許可，不可部份複製。

This document is issued by the Company subject to its General Conditions of Service printed overleaf, available on request or accessible at www.sgs.com/terms_and_conditions.htm and, for electronic format documents, subject to Terms and Conditions for Electronic Documents at www.sgs.com/terms_e-document.htm. Attention is drawn to the limitation of liability, indemnification and jurisdiction issues defined therein. Any holder of this document is advised that information contained hereon reflects the Company's findings at the time of its intervention only and within the limits of Client's instructions, if any. The Company's sole responsibility is to its Client and this document does not exonerate parties to a transaction from exercising all their rights and obligations under the transaction documents. This document cannot be reproduced except in full, without prior written approval of the Company. Any unauthorized alteration, forgery or falsification of the content or appearance of this document is unlawful and offenders may be prosecuted to the fullest extent of the law.

ES3DV3 SN:3139

February 19, 2010

DASY - Parameters of Probe: ES3DV3 SN:3139

Calibration Parameter Determined in Head Tissue Simulating Media

f [MHz]	Validity [MHz] ^c	Permittivity	Conductivity	ConvF X	ConvF Y	ConvF Z	Alpha	Depth Unc (k=2)
900	± 50 / ± 100	41.5 ± 5%	0.97 ± 5%	5.60	5.60	5.60	0.28	2.31 ± 11.0%
1750	± 50 / ± 100	40.1 ± 5%	1.37 ± 5%	5.11	5.11	5.11	0.62	1.50 ± 11.0%
1950	± 50 / ± 100	40.0 ± 5%	1.40 ± 5%	4.76	4.76	4.76	0.28	2.70 ± 11.0%
2450	± 50 / ± 100	39.2 ± 5%	1.80 ± 5%	4.39	4.39	4.39	0.41	2.15 ± 11.0%

^c The validity of ± 100 MHz only applies for DASY v4.4 and higher (see Page 2). The uncertainty is the RSS of the ConvF uncertainty at calibration frequency and the uncertainty for the indicated frequency band.

Unless otherwise stated the results shown in this test report refer only to the sample(s) tested and such sample(s) are retained for 90 days only.
除非另有說明，此報告結果僅對測試之樣品負責，同時此樣品僅保留90天。本報告未經本公司書面許可，不可部份複製。

This document is issued by the Company subject to its General Conditions of Service printed overleaf, available on request or accessible at www.sgs.com/terms_and_conditions.htm and, for electronic format documents, subject to Terms and Conditions for Electronic Documents at www.sgs.com/terms_e-document.htm. Attention is drawn to the limitation of liability, indemnification and jurisdiction issues defined therein. Any holder of this document is advised that information contained hereon reflects the Company's findings at the time of its intervention only and within the limits of Client's instructions, if any. The Company's sole responsibility is to its Client and this document does not exonerate parties to a transaction from exercising all their rights and obligations under the transaction documents. This document cannot be reproduced except in full, without prior written approval of the Company. Any unauthorized alteration, forgery or falsification of the content or appearance of this document is unlawful and offenders may be prosecuted to the fullest extent of the law.

ES3DV3 SN:3139

February 19, 2010

DASY - Parameters of Probe: ES3DV3 SN:3139

Calibration Parameter Determined in Body Tissue Simulating Media

f [MHz]	Validity [MHz] ^c	Permittivity	Conductivity	ConvF X	ConvF Y	ConvF Z	Alpha	Depth Unc (k=2)
900	± 50 / ± 100	55.0 ± 5%	1.05 ± 5%	5.54	5.54	5.54	0.99	1.11 ± 11.0%
1750	± 50 / ± 100	53.4 ± 5%	1.49 ± 5%	4.76	4.76	4.76	0.44	1.78 ± 11.0%
1950	± 50 / ± 100	53.3 ± 5%	1.52 ± 5%	4.64	4.64	4.64	0.39	2.13 ± 11.0%
2450	± 50 / ± 100	52.7 ± 5%	1.95 ± 5%	4.15	4.15	4.15	0.99	1.15 ± 11.0%

^c The validity of ± 100 MHz only applies for DASY v4.4 and higher (see Page 2). The uncertainty is the RSS of the ConvF uncertainty at calibration frequency and the uncertainty for the indicated frequency band.

Unless otherwise stated the results shown in this test report refer only to the sample(s) tested and such sample(s) are retained for 90 days only.
除非另有說明，此報告結果僅對測試之樣品負責，同時此樣品僅保留90天。本報告未經本公司書面許可，不可部份複製。

This document is issued by the Company subject to its General Conditions of Service printed overleaf, available on request or accessible at www.sgs.com/terms_and_conditions.htm and, for electronic format documents, subject to Terms and Conditions for Electronic Documents at www.sgs.com/terms_e-document.htm. Attention is drawn to the limitation of liability, indemnification and jurisdiction issues defined therein. Any holder of this document is advised that information contained hereon reflects the Company's findings at the time of its intervention only and within the limits of Client's instructions, if any. The Company's sole responsibility is to its Client and this document does not exonerate parties to a transaction from exercising all their rights and obligations under the transaction documents. This document cannot be reproduced except in full, without prior written approval of the Company. Any unauthorized alteration, forgery or falsification of the content or appearance of this document is unlawful and offenders may be prosecuted to the fullest extent of the law.

ES3DV3 SN:3139

February 19, 2010

Frequency Response of E-Field (TEM-Cell:ifi110 EXX, Waveguide: R22)

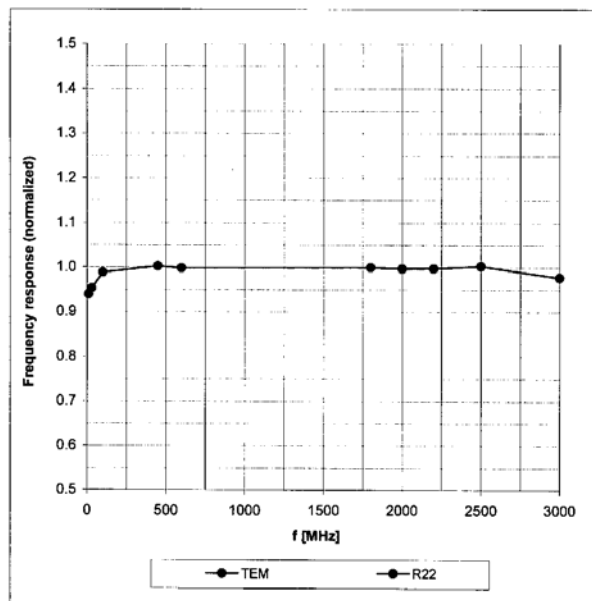

Uncertainty of Frequency Response of E-field: $\pm 6.3\%$ (k=2)

Certificate No: ES3-3139_Feb10

Page 7 of 11

Unless otherwise stated the results shown in this test report refer only to the sample(s) tested and such sample(s) are retained for 90 days only.
除非另有說明，此報告結果僅對測試之樣品負責，同時此樣品僅保留90天。本報告未經本公司書面許可，不可部份複製。

This document is issued by the Company subject to its General Conditions of Service printed overleaf, available on request or accessible at www.sgs.com/terms_and_conditions.htm and, for electronic format documents, subject to Terms and Conditions for Electronic Documents at www.sgs.com/terms_e-document.htm. Attention is drawn to the limitation of liability, indemnification and jurisdiction issues defined therein. Any holder of this document is advised that information contained hereon reflects the Company's findings at the time of its intervention only and within the limits of Client's instructions, if any. The Company's sole responsibility is to its Client and this document does not exonerate parties to a transaction from exercising all their rights and obligations under the transaction documents. This document cannot be reproduced except in full, without prior written approval of the Company. Any unauthorized alteration, forgery or falsification of the content or appearance of this document is unlawful and offenders may be prosecuted to the fullest extent of the law.

ES3DV3 SN:3139

February 19, 2010

Receiving Pattern (ϕ), $\theta = 0^\circ$

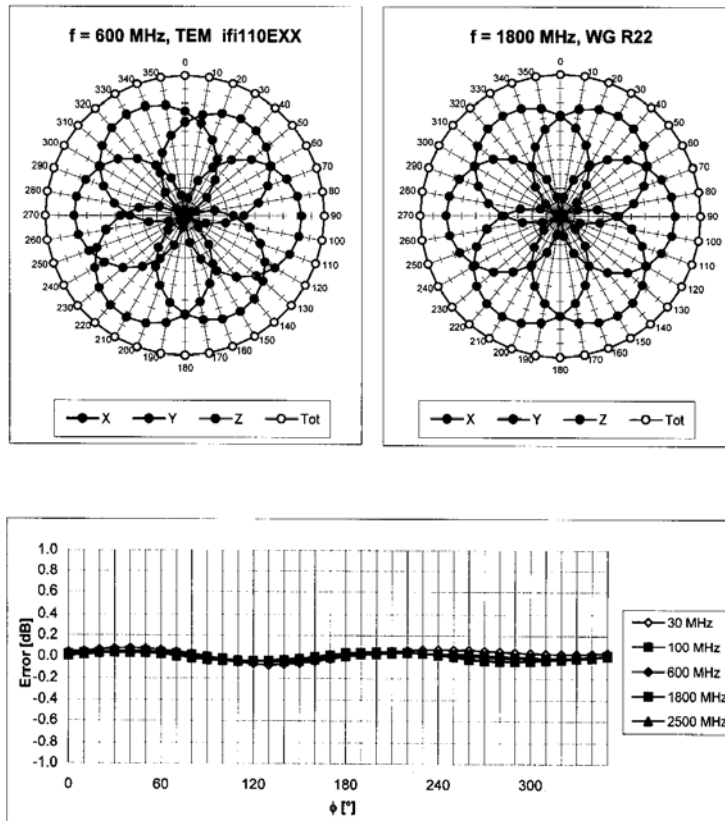

Uncertainty of Axial Isotropy Assessment: $\pm 0.5\%$ ($k=2$)

Certificate No: ES3-3139_Feb10

Page 8 of 11

Unless otherwise stated the results shown in this test report refer only to the sample(s) tested and such sample(s) are retained for 90 days only.
除非另有說明，此報告結果僅對測試之樣品負責，同時此樣品僅保留90天。本報告未經本公司書面許可，不可部份複製。

This document is issued by the Company subject to its General Conditions of Service printed overleaf, available on request or accessible at www.sgs.com/terms_and_conditions.htm and, for electronic format documents, subject to Terms and Conditions for Electronic Documents at www.sgs.com/terms_e-document.htm. Attention is drawn to the limitation of liability, indemnification and jurisdiction issues defined therein. Any holder of this document is advised that information contained hereon reflects the Company's findings at the time of its intervention only and within the limits of Client's instructions, if any. The Company's sole responsibility is to its Client and this document does not exonerate parties to a transaction from exercising all their rights and obligations under the transaction documents. This document cannot be reproduced except in full, without prior written approval of the Company. Any unauthorized alteration, forgery or falsification of the content or appearance of this document is unlawful and offenders may be prosecuted to the fullest extent of the law.

ES3DV3 SN:3139

February 19, 2010

Dynamic Range $f(SAR_{head})$ (Waveguide R22, $f = 1800$ MHz)

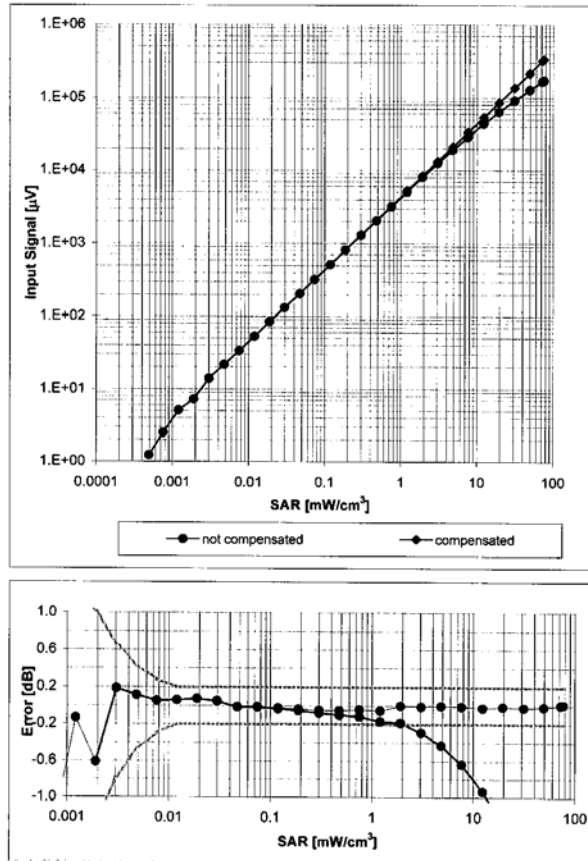

Uncertainty of Linearity Assessment: $\pm 0.6\%$ ($k=2$)

Certificate No: ES3-3139_Feb10

Page 9 of 11

Unless otherwise stated the results shown in this test report refer only to the sample(s) tested and such sample(s) are retained for 90 days only.
除非另有說明，此報告結果僅對測試之樣品負責，同時此樣品僅保留90天。本報告未經本公司書面許可，不可部份複製。

This document is issued by the Company subject to its General Conditions of Service printed overleaf, available on request or accessible at www.sgs.com/terms_and_conditions.htm and, for electronic format documents, subject to Terms and Conditions for Electronic Documents at www.sgs.com/terms_e-document.htm. Attention is drawn to the limitation of liability, indemnification and jurisdiction issues defined therein. Any holder of this document is advised that information contained hereon reflects the Company's findings at the time of its intervention only and within the limits of Client's instructions, if any. The Company's sole responsibility is to its Client and this document does not exonerate parties to a transaction from exercising all their rights and obligations under the transaction documents. This document cannot be reproduced except in full, without prior written approval of the Company. Any unauthorized alteration, forgery or falsification of the content or appearance of this document is unlawful and offenders may be prosecuted to the fullest extent of the law.

ES3DV3 SN:3139

February 19, 2010

Conversion Factor Assessment

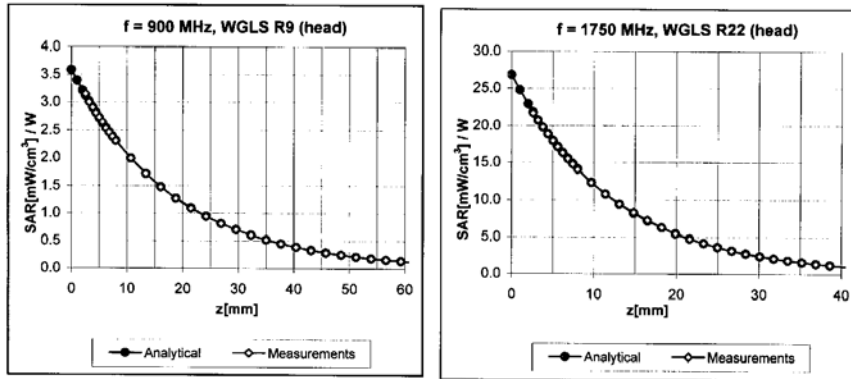

Deviation from Isotropy in HSL

Error (ϕ, θ), f = 900 MHz

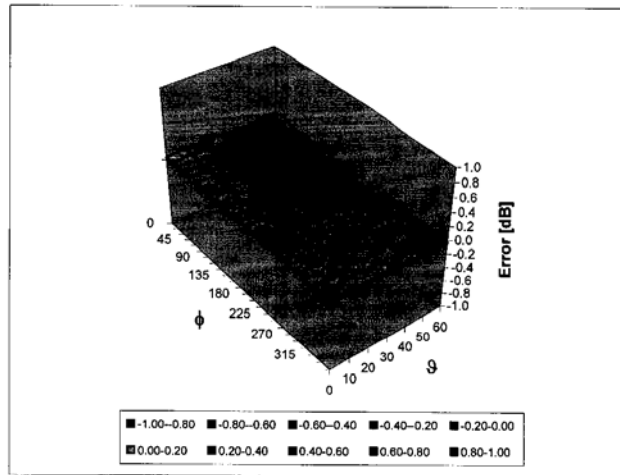

Uncertainty of Spherical Isotropy Assessment: $\pm 2.6\%$ (k=2)

Unless otherwise stated the results shown in this test report refer only to the sample(s) tested and such sample(s) are retained for 90 days only. 除非另有說明，此報告結果僅對測試之樣品負責，同時此樣品僅保留90天。本報告未經本公司書面許可，不可部份複製。

This document is issued by the Company subject to its General Conditions of Service printed overleaf, available on request or accessible at www.sgs.com/terms_and_conditions.htm and, for electronic format documents, subject to Terms and Conditions for Electronic Documents at www.sgs.com/terms_e-document.htm. Attention is drawn to the limitation of liability, indemnification and jurisdiction issues defined therein. Any holder of this document is advised that information contained hereon reflects the Company's findings at the time of its intervention only and within the limits of Client's instructions, if any. The Company's sole responsibility is to its Client and this document does not exonerate parties to a transaction from exercising all their rights and obligations under the transaction documents. This document cannot be reproduced except in full, without prior written approval of the Company. Any unauthorized alteration, forgery or falsification of the content or appearance of this document is unlawful and offenders may be prosecuted to the fullest extent of the law.

ES3DV3 SN:3139

February 19, 2010

Other Probe Parameters

Sensor Arrangement	Triangular
Connector Angle (°)	Not applicable
Mechanical Surface Detection Mode	enabled
Optical Surface Detection Mode	disabled
Probe Overall Length	337 mm
Probe Body Diameter	10 mm
Tip Length	10 mm
Tip Diameter	4.0 mm
Probe Tip to Sensor X Calibration Point	2 mm
Probe Tip to Sensor Y Calibration Point	2 mm
Probe Tip to Sensor Z Calibration Point	2 mm
Recommended Measurement Distance from Surface	3 mm

Unless otherwise stated the results shown in this test report refer only to the sample(s) tested and such sample(s) are retained for 90 days only.

除非另有說明，此報告結果僅對測試之樣品負責，同時此樣品僅保留90天。本報告未經本公司書面許可，不可部份複製。

This document is issued by the Company subject to its General Conditions of Service printed overleaf, available on request or accessible at www.sgs.com/terms_and_conditions.htm and, for electronic format documents, subject to Terms and Conditions for Electronic Documents at www.sgs.com/terms_e-document.htm. Attention is drawn to the limitation of liability, indemnification and jurisdiction issues defined therein. Any holder of this document is advised that information contained hereon reflects the Company's findings at the time of its intervention only and within the limits of Client's instructions, if any. The Company's sole responsibility is to its Client and this document does not exonerate parties to a transaction from exercising all their rights and obligations under the transaction documents. This document cannot be reproduced except in full, without prior written approval of the Company. Any unauthorized alteration, forgery or falsification of the content or appearance of this document is unlawful and offenders may be prosecuted to the fullest extent of the law.

7. Uncertainty Budget

DASY4 Uncertainty Budget
According to IEEE P1528 [1]

Error Description	Uncertainty value	Prob. Dist.	Div.	(c_i) 1g	(c_i) 10g	Std. Unc. (1g)	Std. Unc. (10g)	(v_i) (v_{eff})
Measurement System								
Probe Calibration	±4.8%	N	1	1	1	±4.8%	±4.8%	∞
Axial Isotropy	±4.7%	R	√3	0.7	0.7	±1.9%	±1.9%	∞
Hemispherical Isotropy	±9.6%	R	√3	0.7	0.7	±3.9%	±3.9%	∞
Boundary Effects	±1.0%	R	√3	1	1	±0.6%	±0.6%	∞
Linearity	±4.7%	R	√3	1	1	±2.7%	±2.7%	∞
System Detection Limits	±1.0%	R	√3	1	1	±0.6%	±0.6%	∞
Readout Electronics	±1.0%	N	1	1	1	±1.0%	±1.0%	∞
Response Time	±0.8%	R	√3	1	1	±0.5%	±0.5%	∞
Integration Time	±2.6%	R	√3	1	1	±1.5%	±1.5%	∞
RF Ambient Conditions	±3.0%	R	√3	1	1	±1.7%	±1.7%	∞
Probe Positioner	±0.4%	R	√3	1	1	±0.2%	±0.2%	∞
Probe Positioning	±2.9%	R	√3	1	1	±1.7%	±1.7%	∞
Max. SAR Eval.	±1.0%	R	√3	1	1	±0.6%	±0.6%	∞
Test Sample Related								
Device Positioning	±2.9%	N	1	1	1	±2.9%	±2.9%	875
Device Holder	±3.6%	N	1	1	1	±3.6%	±3.6%	5
Power Drift	±5.0%	R	√3	1	1	±2.9%	±2.9%	∞
Phantom and Setup								
Phantom Uncertainty	±4.0%	R	√3	1	1	±2.3%	±2.3%	∞
Liquid Conductivity (target)	±5.0%	R	√3	0.64	0.43	±1.8%	±1.2%	∞
Liquid Conductivity (meas.)	±2.5%	N	1	0.64	0.43	±1.6%	±1.1%	∞
Liquid Permittivity (target)	±5.0%	R	√3	0.6	0.49	±1.7%	±1.4%	∞
Liquid Permittivity (meas.)	±2.5%	N	1	0.6	0.49	±1.5%	±1.2%	∞
Combined Std. Uncertainty						±10.3%	±10.0%	331
Expanded STD Uncertainty						±20.6%	±20.1%	

Unless otherwise stated the results shown in this test report refer only to the sample(s) tested and such sample(s) are retained for 90 days only.
除非另有說明，此報告結果僅對測試之樣品負責，同時此樣品僅保留90天。本報告未經本公司書面許可，不可部份複製。

This document is issued by the Company subject to its General Conditions of Service printed overleaf, available on request or accessible at www.sgs.com/terms_and_conditions.htm and, for electronic format documents, subject to Terms and Conditions for Electronic Documents at www.sgs.com/terms_e-document.htm. Attention is drawn to the limitation of liability, indemnification and jurisdiction issues defined therein. Any holder of this document is advised that information contained herein reflects the Company's findings at the time of its intervention only and within the limits of Client's instructions, if any. The Company's sole responsibility is to its Client and this document does not exonerate parties to a transaction from exercising all their rights and obligations under the transaction documents. This document cannot be reproduced except in full, without prior written approval of the Company. Any unauthorized alteration, forgery or falsification of the content or appearance of this document is unlawful and offenders may be prosecuted to the fullest extent of the law.

8. Phantom Description

Schmid & Partner Engineering AG **s p e a g**
 Zeughausstrasse 43, 8004 Zurich, Switzerland
 Phone +41 1 245 9700, Fax +41 1 245 9779
 info@speag.com, http://www.speag.com

Certificate of Conformity / First Article Inspection

Item	SAM Twin Phantom V4.0
Type No	QD 000 P40 C
Series No	TP-1150 and higher
Manufacturer	SPEAG Zeughausstrasse 43 CH-8004 Zurich Switzerland

Tests

The series production process used allows the limitation to test of first articles. Complete tests were made on the pre-series Type No. QD 000 P40 AA, Serial No. TP-1001 and on the series first article Type No. QD 000 P40 BA, Serial No. TP-1006. Certain parameters have been retested using further series items (called samples) or are tested at each item.

Test	Requirement	Details	Units tested
Dimensions	Compliant with the geometry according to the CAD model	IT'IS CAD File (*)	First article, Samples
Material thickness of shell	Compliant with the requirements according to the standards	2mm +/- 0.2mm in flat and specific areas of head section	First article, Samples, TP-1314 ff.
Material thickness at ERP	Compliant with the requirements according to the standards	6mm +/- 0.2mm at ERP	First article, All items
Material parameters	Dielectric parameters for required frequencies	300 MHz – 6 GHz: Relative permittivity < 5, Loss tangent < 0.05	Material samples
Material resistivity	The material has been tested to be compatible with the liquids defined in the standards if handled and cleaned according to the instructions. Observe technical Note for material compatibility	DEGMBE based simulating liquids	Pre-series, First article, Material samples
Sagging	Compliant with the requirements according to the standards. Sagging of the flat section when filled with tissue simulating liquid.	< 1% typical < 0.8% if filled with 155mm of HSL900 and without OUT below	Prototypes, Sample testing

Standards

- [1] CENELEC EN 50351
- [2] IEEE Std 1528-2003
- [3] IEC 62209 Part 1
- [4] FCC DET Bulletin 65, Supplement C, Edition 01-01
- (*) The IT'IS CAD file is derived from [2] and is also within the tolerance requirements of the shapes of the other documents.

Conformity

Based on the sample tests above, we certify that this item is in compliance with the uncertainty requirements of SAR measurements specified in standards [1] to [4].

Date 07.07.2005

Signature / Stamp

s p e a g

Schmid & Partner Engineering AG
 Zeughausstrasse 43, 8004 Zurich, Switzerland
 Phone +41 1 245 9700, Fax +41 1 245 9779
 info@speag.com, http://www.speag.com

Doc No: SE1 - QD.000 P40 C - 3

Page 1 (1)

Unless otherwise stated the results shown in this test report refer only to the sample(s) tested and such sample(s) are retained for 90 days only. 除非另有說明，此報告結果僅對測試之樣品負責，同時此樣品僅保留90天。本報告未經本公司書面許可，不可部份複製。

This document is issued by the Company subject to its General Conditions of Service printed overleaf, available on request or accessible at www.sgs.com/terms_and_conditions.htm and, for electronic format documents, subject to Terms and Conditions for Electronic Documents at www.sgs.com/terms_e-document.htm. Attention is drawn to the limitation of liability, indemnification and jurisdiction issues defined therein. Any holder of this document is advised that information contained hereon reflects the Company's findings at the time of its intervention only and within the limits of Client's instructions, if any. The Company's sole responsibility is to its Client and this document does not exonerate parties to a transaction from exercising all their rights and obligations under the transaction documents. This document cannot be reproduced except in full, without prior written approval of the Company. Any unauthorized alteration, forgery or falsification of the content or appearance of this document is unlawful and offenders may be prosecuted to the fullest extent of the law.

9. System Validation from Original equipment supplier

**Calibration Laboratory of
Schmid & Partner
Engineering AG**
Zeughausstrasse 43, 8004 Zurich, Switzerland



S Schweizerischer Kalibrierdienst
C Service suisse d'étalonnage
S Servizio svizzero di taratura
S Swiss Calibration Service

Accredited by the Swiss Accreditation Service (SAS)
The Swiss Accreditation Service is one of the signatories to the EA
Multilateral Agreement for the recognition of calibration certificates

Accreditation No.: **SCS 108**

Client **SGS-TW (Auden)**

Certificate No: **D2450V2-727_Apr10**

CALIBRATION CERTIFICATE

Object **D2450V2 - SN: 727**

Calibration procedure(s) **QA CAL-05.v7
Calibration procedure for dipole validation kits**

Calibration date: **April 29, 2010**

This calibration certificate documents the traceability to national standards, which realize the physical units of measurements (SI).
The measurements and the uncertainties with confidence probability are given on the following pages and are part of the certificate.

All calibrations have been conducted in the closed laboratory facility: environment temperature (22 ± 3)°C and humidity < 70%.

Calibration Equipment used (M&TE critical for calibration)

Primary Standards	ID #	Cal Date (Certificate No.)	Scheduled Calibration
Power meter EPM-442A	GB37480704	06-Oct-09 (No. 217-01086)	Oct-10
Power sensor HP 8481A	US37292783	06-Oct-09 (No. 217-01086)	Oct-10
Reference 20 dB Attenuator	SN: 5086 (20g)	30-Mar-10 (No. 217-01158)	Mar-11
Type-N mismatch combination	SN: 5047.2 / 06327	30-Mar-10 (No. 217-01162)	Mar-11
Reference Probe ES3DV3	SN: 3205	26-Jun-09 (No. ES3-3205_Jun09)	Jun-10
DAE4	SN: 601	02-Mar-10 (No. DAE4-601_Mar10)	Mar-11
Secondary Standards	ID #	Check Date (in house)	Scheduled Check
Power sensor HP 8481A	MY41092317	18-Oct-02 (in house check Oct-09)	In house check: Oct-11
RF generator R&S SMT-06	100005	4-Aug-99 (in house check Oct-09)	In house check: Oct-11
Network Analyzer HP 8753E	US37390585 S4206	18-Oct-01 (in house check Oct-09)	In house check: Oct-10

Calibrated by: **Jeton Kastrati** (Name) / **Laboratory Technician** (Function) / *[Signature]* (Signature)

Approved by: **Katja Pokovic** (Name) / **Technical Manager** (Function) / *[Signature]* (Signature)

Issued: April 29, 2010

This calibration certificate shall not be reproduced except in full without written approval of the laboratory.

Certificate No: D2450V2-727_Apr10

Page 1 of 9

Unless otherwise stated the results shown in this test report refer only to the sample(s) tested and such sample(s) are retained for 90 days only.
除非另有說明，此報告結果僅對測試之樣品負責，同時此樣品僅保留90天。本報告未經本公司書面許可，不可部份複製。

This document is issued by the Company subject to its General Conditions of Service printed overleaf, available on request or accessible at www.sgs.com/terms_and_conditions.htm and, for electronic format documents, subject to Terms and Conditions for Electronic Documents at www.sgs.com/terms_e-document.htm. Attention is drawn to the limitation of liability, indemnification and jurisdiction issues defined therein. Any holder of this document is advised that information contained hereon reflects the Company's findings at the time of its intervention only and within the limits of Client's instructions, if any. The Company's sole responsibility is to its Client and this document does not exonerate parties to a transaction from exercising all their rights and obligations under the transaction documents. This document cannot be reproduced except in full, without prior written approval of the Company. Any unauthorized alteration, forgery or falsification of the content or appearance of this document is unlawful and offenders may be prosecuted to the fullest extent of the law.

**Calibration Laboratory of
Schmid & Partner
Engineering AG**
Zeughausstrasse 43, 8004 Zurich, Switzerland



S Schweizerischer Kalibrierdienst
S Service suisse d'étalonnage
C Servizio svizzero di taratura
S Swiss Calibration Service

Accredited by the Swiss Accreditation Service (SAS)
The Swiss Accreditation Service is one of the signatories to the EA
Multilateral Agreement for the recognition of calibration certificates

Accreditation No.: **SCS 108**

Glossary:

TSL tissue simulating liquid
ConvF sensitivity in TSL / NORM x,y,z
N/A not applicable or not measured

Calibration is Performed According to the Following Standards:

- a) IEEE Std 1528-2003, "IEEE Recommended Practice for Determining the Peak Spatial-Averaged Specific Absorption Rate (SAR) in the Human Head from Wireless Communications Devices: Measurement Techniques", December 2003
- b) IEC 62209-1, "Procedure to measure the Specific Absorption Rate (SAR) for hand-held devices used in close proximity to the ear (frequency range of 300 MHz to 3 GHz)", February 2005
- c) Federal Communications Commission Office of Engineering & Technology (FCC OET), "Evaluating Compliance with FCC Guidelines for Human Exposure to Radiofrequency Electromagnetic Fields; Additional Information for Evaluating Compliance of Mobile and Portable Devices with FCC Limits for Human Exposure to Radiofrequency Emissions", Supplement C (Edition 01-01) to Bulletin 65

Additional Documentation:

- d) DASy4/5 System Handbook

Methods Applied and Interpretation of Parameters:

- *Measurement Conditions:* Further details are available from the Validation Report at the end of the certificate. All figures stated in the certificate are valid at the frequency indicated.
- *Antenna Parameters with TSL:* The dipole is mounted with the spacer to position its feed point exactly below the center marking of the flat phantom section, with the arms oriented parallel to the body axis.
- *Feed Point Impedance and Return Loss:* These parameters are measured with the dipole positioned under the liquid filled phantom. The impedance stated is transformed from the measurement at the SMA connector to the feed point. The Return Loss ensures low reflected power. No uncertainty required.
- *Electrical Delay:* One-way delay between the SMA connector and the antenna feed point. No uncertainty required.
- *SAR measured:* SAR measured at the stated antenna input power.
- *SAR normalized:* SAR as measured, normalized to an input power of 1 W at the antenna connector.
- *SAR for nominal TSL parameters:* The measured TSL parameters are used to calculate the nominal SAR result.

Unless otherwise stated the results shown in this test report refer only to the sample(s) tested and such sample(s) are retained for 90 days only.
除非另有說明，此報告結果僅對測試之樣品負責，同時此樣品僅保留90天。本報告未經本公司書面許可，不可部份複製。

This document is issued by the Company subject to its General Conditions of Service printed overleaf, available on request or accessible at www.sgs.com/terms_and_conditions.htm and, for electronic format documents, subject to Terms and Conditions for Electronic Documents at www.sgs.com/terms_e-document.htm. Attention is drawn to the limitation of liability, indemnification and jurisdiction issues defined therein. Any holder of this document is advised that information contained hereon reflects the Company's findings at the time of its intervention only and within the limits of Client's instructions, if any. The Company's sole responsibility is to its Client and this document does not exonerate parties to a transaction from exercising all their rights and obligations under the transaction documents. This document cannot be reproduced except in full, without prior written approval of the Company. Any unauthorized alteration, forgery or falsification of the content or appearance of this document is unlawful and offenders may be prosecuted to the fullest extent of the law.

Measurement Conditions

DASY system configuration, as far as not given on page 1.

DASY Version	DASY5	V5.2
Extrapolation	Advanced Extrapolation	
Phantom	Modular Flat Phantom V4.9	
Distance Dipole Center - TSL	10 mm	with Spacer
Zoom Scan Resolution	dx, dy, dz = 5 mm	
Frequency	2450 MHz \pm 1 MHz	

Head TSL parameters

The following parameters and calculations were applied.

	Temperature	Permittivity	Conductivity
Nominal Head TSL parameters	22.0 °C	39.2	1.80 mho/m
Measured Head TSL parameters	(22.0 \pm 0.2) °C	39.8 \pm 6 %	1.78 mho/m \pm 6 %
Head TSL temperature during test	(21.5 \pm 0.2) °C	---	---

SAR result with Head TSL

SAR averaged over 1 cm ³ (1 g) of Head TSL	Condition	
SAR measured	250 mW input power	13.2 mW / g
SAR normalized	normalized to 1W	52.8 mW / g
SAR for nominal Head TSL parameters	normalized to 1W	53.2 mW / g \pm 17.0 % (k=2)

SAR averaged over 10 cm ³ (10 g) of Head TSL	condition	
SAR measured	250 mW input power	6.22 mW / g
SAR normalized	normalized to 1W	24.9 mW / g
SAR for nominal Head TSL parameters	normalized to 1W	25.0 mW / g \pm 16.5 % (k=2)

Unless otherwise stated the results shown in this test report refer only to the sample(s) tested and such sample(s) are retained for 90 days only.

除非另有說明，此報告結果僅對測試之樣品負責，同時此樣品僅保留90天。本報告未經本公司書面許可，不可部份複製。

This document is issued by the Company subject to its General Conditions of Service printed overleaf, available on request or accessible at www.sgs.com/terms_and_conditions.htm and, for electronic format documents, subject to Terms and Conditions for Electronic Documents at www.sgs.com/terms_e-document.htm. Attention is drawn to the limitation of liability, indemnification and jurisdiction issues defined therein. Any holder of this document is advised that information contained hereon reflects the Company's findings at the time of its intervention only and within the limits of Client's instructions, if any. The Company's sole responsibility is to its Client and this document does not exonerate parties to a transaction from exercising all their rights and obligations under the transaction documents. This document cannot be reproduced except in full, without prior written approval of the Company. Any unauthorized alteration, forgery or falsification of the content or appearance of this document is unlawful and offenders may be prosecuted to the fullest extent of the law.

Body TSL parameters

The following parameters and calculations were applied.

	Temperature	Permittivity	Conductivity
Nominal Body TSL parameters	22.0 °C	52.7	1.95 mho/m
Measured Body TSL parameters	(22.0 ± 0.2) °C	54.2 ± 6 %	2.01 mho/m ± 6 %
Body TSL temperature during test	(22.5 ± 0.2) °C	---	---

SAR result with Body TSL

SAR averaged over 1 cm ³ (1 g) of Body TSL	Condition	
SAR measured	250 mW input power	13.4 mW / g
SAR normalized	normalized to 1W	53.6 mW / g
SAR for nominal Body TSL parameters	normalized to 1W	53.2 mW / g ± 17.0 % (k=2)

SAR averaged over 10 cm ³ (10 g) of Body TSL	condition	
SAR measured	250 mW input power	6.23 mW / g
SAR normalized	normalized to 1W	24.9 mW / g
SAR for nominal Body TSL parameters	normalized to 1W	24.9 mW / g ± 16.5 % (k=2)

Unless otherwise stated the results shown in this test report refer only to the sample(s) tested and such sample(s) are retained for 90 days only.

除非另有說明，此報告結果僅對測試之樣品負責，同時此樣品僅保留90天。本報告未經本公司書面許可，不可部份複製。

This document is issued by the Company subject to its General Conditions of Service printed overleaf, available on request or accessible at www.sgs.com/terms_and_conditions.htm and, for electronic format documents, subject to Terms and Conditions for Electronic Documents at www.sgs.com/terms_e-document.htm. Attention is drawn to the limitation of liability, indemnification and jurisdiction issues defined therein. Any holder of this document is advised that information contained hereon reflects the Company's findings at the time of its intervention only and within the limits of Client's instructions, if any. The Company's sole responsibility is to its Client and this document does not exonerate parties to a transaction from exercising all their rights and obligations under the transaction documents. This document cannot be reproduced except in full, without prior written approval of the Company. Any unauthorized alteration, forgery or falsification of the content or appearance of this document is unlawful and offenders may be prosecuted to the fullest extent of the law.

Appendix

Antenna Parameters with Head TSL

Impedance, transformed to feed point	53.3 Ω + 1.7 j Ω
Return Loss	- 28.9 dB

Antenna Parameters with Body TSL

Impedance, transformed to feed point	50.3 Ω + 3.6 j Ω
Return Loss	- 29.0 dB

General Antenna Parameters and Design

Electrical Delay (one direction)	1.150 ns
----------------------------------	----------

After long term use with 100W radiated power, only a slight warming of the dipole near the feedpoint can be measured.

The dipole is made of standard semirigid coaxial cable. The center conductor of the feeding line is directly connected to the second arm of the dipole. The antenna is therefore short-circuited for DC-signals.

No excessive force must be applied to the dipole arms, because they might bend or the soldered connections near the feedpoint may be damaged.

Additional EUT Data

Manufactured by	SPEAG
Manufactured on	January 09, 2003

Unless otherwise stated the results shown in this test report refer only to the sample(s) tested and such sample(s) are retained for 90 days only.

除非另有說明，此報告結果僅對測試之樣品負責，同時此樣品僅保留90天。本報告未經本公司書面許可，不可部份複製。

This document is issued by the Company subject to its General Conditions of Service printed overleaf, available on request or accessible at www.sgs.com/terms_and_conditions.htm and, for electronic format documents, subject to Terms and Conditions for Electronic Documents at www.sgs.com/terms_e-document.htm. Attention is drawn to the limitation of liability, indemnification and jurisdiction issues defined therein. Any holder of this document is advised that information contained hereon reflects the Company's findings at the time of its intervention only and within the limits of Client's instructions, if any. The Company's sole responsibility is to its Client and this document does not exonerate parties to a transaction from exercising all their rights and obligations under the transaction documents. This document cannot be reproduced except in full, without prior written approval of the Company. Any unauthorized alteration, forgery or falsification of the content or appearance of this document is unlawful and offenders may be prosecuted to the fullest extent of the law.

DASY5 Validation Report for Head TSL

Date/Time: 22.04.2010 16:30:51

Test Laboratory: SPEAG, Zurich, Switzerland

DUT: Dipole 2450 MHz; Type: D2450V2; Serial: D2450V2 - SN:727

Communication System: CW; Frequency: 2450 MHz; Duty Cycle: 1:1

Medium: HSL U11 BB

Medium parameters used: $f = 2450$ MHz; $\sigma = 1.78$ mho/m; $\epsilon_r = 39.8$; $\rho = 1000$ kg/m³

Phantom section: Flat Section

Measurement Standard: DASY5 (IEEE/IEC/ANSI C63.19-2007)

DASY5 Configuration:

- Probe: ES3DV3 - SN3205; ConvF(4.53, 4.53, 4.53); Calibrated: 26.06.2009
- Sensor-Surface: 3mm (Mechanical Surface Detection)
- Electronics: DAE4 Sn601; Calibrated: 02.03.2010
- Phantom: Flat Phantom 5.0 (front); Type: QD000P50AA; Serial: 1001
- Measurement SW: DASY5, V5.2 Build 162; SEMCAD X Version 14.0 Build 57

Pin=250 mW /d=10mm, dist=3.0mm (ES-Probe)/Zoom Scan (7x7x7)/Cube 0: Measurement grid: dx=5mm, dy=5mm, dz=5mm

Reference Value = 101.0 V/m; Power Drift = 0.064 dB

Peak SAR (extrapolated) = 26.8 W/kg

SAR(1 g) = 13.2 mW/g; SAR(10 g) = 6.22 mW/g

Maximum value of SAR (measured) = 16.9 mW/g

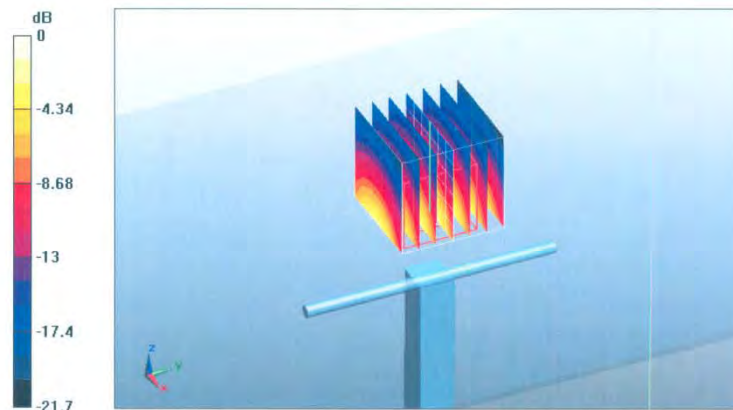

0 dB = 16.9mW/g

Unless otherwise stated the results shown in this test report refer only to the sample(s) tested and such sample(s) are retained for 90 days only.
除非另有說明，此報告結果僅對測試之樣品負責，同時此樣品僅保留90天。本報告未經本公司書面許可，不可部份複製。

This document is issued by the Company subject to its General Conditions of Service printed overleaf, available on request or accessible at www.sgs.com/terms_and_conditions.htm and, for electronic format documents, subject to Terms and Conditions for Electronic Documents at www.sgs.com/terms_e-document.htm. Attention is drawn to the limitation of liability, indemnification and jurisdiction issues defined therein. Any holder of this document is advised that information contained hereon reflects the Company's findings at the time of its intervention only and within the limits of Client's instructions, if any. The Company's sole responsibility is to its Client and this document does not exonerate parties to a transaction from exercising all their rights and obligations under the transaction documents. This document cannot be reproduced except in full, without prior written approval of the Company. Any unauthorized alteration, forgery or falsification of the content or appearance of this document is unlawful and offenders may be prosecuted to the fullest extent of the law.

Impedance Measurement Plot for Head TSL

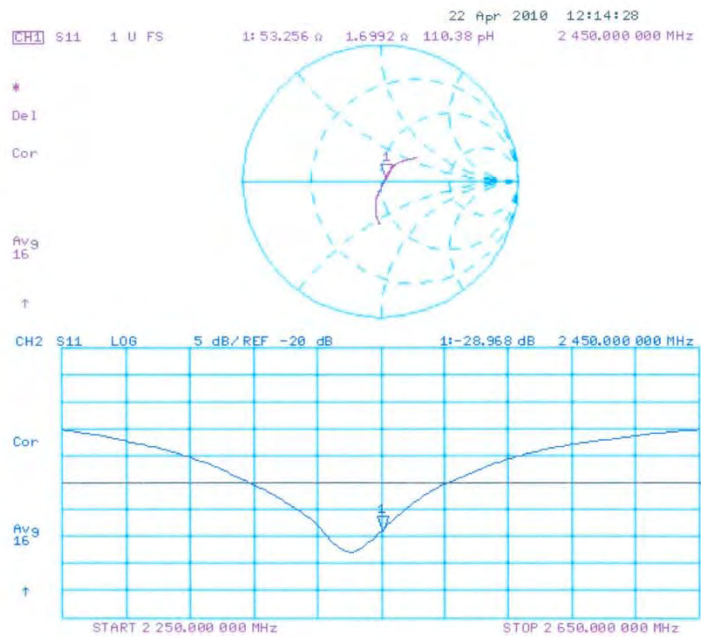

Unless otherwise stated the results shown in this test report refer only to the sample(s) tested and such sample(s) are retained for 90 days only.
除非另有說明，此報告結果僅對測試之樣品負責，同時此樣品僅保留90天。本報告未經本公司書面許可，不可部份複製。

This document is issued by the Company subject to its General Conditions of Service printed overleaf, available on request or accessible at www.sgs.com/terms_and_conditions.htm and, for electronic format documents, subject to Terms and Conditions for Electronic Documents at www.sgs.com/terms_e-document.htm. Attention is drawn to the limitation of liability, indemnification and jurisdiction issues defined therein. Any holder of this document is advised that information contained hereon reflects the Company's findings at the time of its intervention only and within the limits of Client's instructions, if any. The Company's sole responsibility is to its Client and this document does not exonerate parties to a transaction from exercising all their rights and obligations under the transaction documents. This document cannot be reproduced except in full, without prior written approval of the Company. Any unauthorized alteration, forgery or falsification of the content or appearance of this document is unlawful and offenders may be prosecuted to the fullest extent of the law.

DASY5 Validation Report for Body

Date/Time: 29.04.2010 14:57:43

Test Laboratory: SPEAG, Zurich, Switzerland

DUT: Dipole 2450 MHz; Type: D2450V2; Serial: D2450V2 - SN:727

Communication System: CW; Frequency: 2450 MHz; Duty Cycle: 1:1

Medium: MSL U11 BB

Medium parameters used: $f = 2450$ MHz; $\sigma = 2$ mho/m; $\epsilon_r = 54.1$; $\rho = 1000$ kg/m³

Phantom section: Flat Section

Measurement Standard: DASY5 (IEEE/IEC/ANSI C63.19-2007)

DASY5 Configuration:

- Probe: ES3DV3 - SN3205; ConvF(4.31, 4.31, 4.31); Calibrated: 26.06.2009
- Sensor-Surface: 3mm (Mechanical Surface Detection)
- Electronics: DAE4 Sn601; Calibrated: 02.03.2010
- Phantom: Flat Phantom 5.0 (back); Type: QD000P50AA; Serial: 1002
- Measurement SW: DASY5, V5.2 Build 162; SEMCAD X Version 14.0 Build 57

Pin250 mW /d=10mm, dist=3.0mm (ES-Probe)/Zoom Scan (7x7x7)/Cube 0: Measurement

grid: dx=5mm, dy=5mm, dz=5mm

Reference Value = 96.1 V/m; Power Drift = 0.00929 dB

Peak SAR (extrapolated) = 27.7 W/kg

SAR(1 g) = 13.4 mW/g; SAR(10 g) = 6.23 mW/g

Maximum value of SAR (measured) = 17.6 mW/g

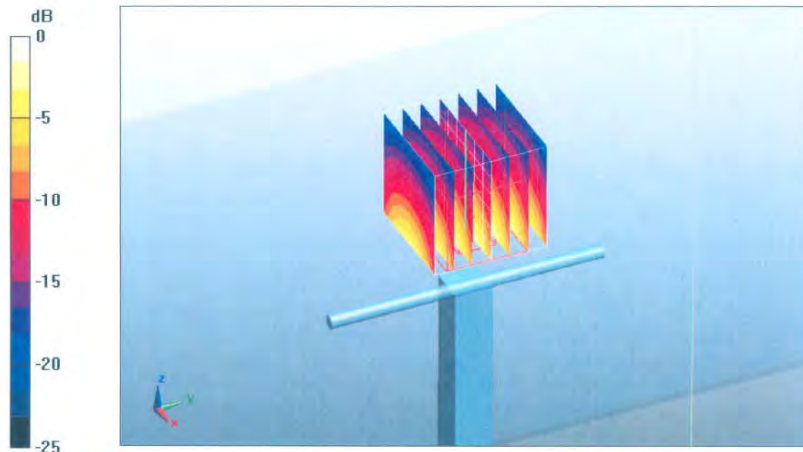

0 dB = 17.6mW/g

Impedance Measurement Plot for Body TSL

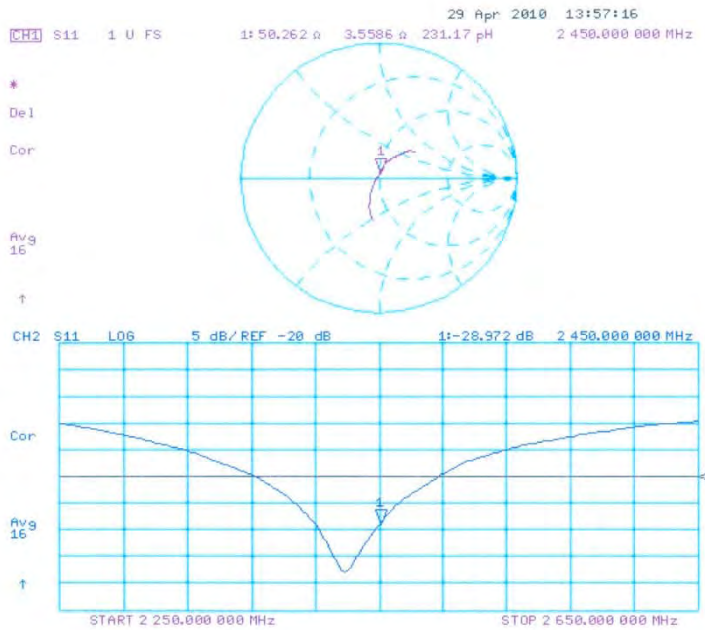

End of 1st part of report

Unless otherwise stated the results shown in this test report refer only to the sample(s) tested and such sample(s) are retained for 90 days only.
除非另有說明，此報告結果僅對測試之樣品負責，同時此樣品僅保留90天。本報告未經本公司書面許可，不可部份複製。

This document is issued by the Company subject to its General Conditions of Service printed overleaf, available on request or accessible at www.sgs.com/terms_and_conditions.htm and, for electronic format documents, subject to Terms and Conditions for Electronic Documents at www.sgs.com/terms_e-document.htm. Attention is drawn to the limitation of liability, indemnification and jurisdiction issues defined therein. Any holder of this document is advised that information contained hereon reflects the Company's findings at the time of its intervention only and within the limits of Client's instructions, if any. The Company's sole responsibility is to its Client and this document does not exonerate parties to a transaction from exercising all their rights and obligations under the transaction documents. This document cannot be reproduced except in full, without prior written approval of the Company. Any unauthorized alteration, forgery or falsification of the content or appearance of this document is unlawful and offenders may be prosecuted to the fullest extent of the law.