



# FCC SAR Test Report

Report No. : SA150720C24  
 Applicant : Quanta Computer Inc.  
 Address : No. 188, Wen Hwa 2nd RD., Kuei Shan Hsiang, Tao Yuan Shien, Taiwan  
 Product : Tablet PC  
 FCC ID : HFS-QTAIR7  
 Brand : Verizon  
 Model No. : QTAIR7  
 Standards : FCC 47 CFR Part 2 (2.1093) / IEEE C95.1:1992 / IEEE Std 1528:2013  
 KDB 865664 D01 v01r04 / KDB 865664 D02 v01r01  
 KDB 248227 D01 v02r01 / KDB 447498 D01 v05r02 / KDB 616217 D04 v01r01  
 Sample Received Date : Jul. 20, 2015  
 Date of Testing : Aug. 14, 2015 ~ Aug. 26, 2015

**CERTIFICATION:** The above equipment have been tested by **Bureau Veritas Consumer Products Services (H.K.) Ltd., Taoyuan Branch – Lin Kou Laboratories**, and found compliance with the requirement of the above standards. The test record, data evaluation & Equipment Under Test (EUT) configurations represented herein are true and accurate accounts of the measurements of the sample’s SAR characteristics under the conditions specified in this report. It should not be reproduced except in full, without the written approval of our laboratory. The client should not use it to claim product certification, approval, or endorsement by TAF or any government agencies.

Prepared By : Ivonne Wu  
 Ivonne Wu / Supervisor

Approved By : Gordon Lin  
 Gordon Lin / Assistant Manager



This report is for your exclusive use. Any copying or replication of this report to or for any other person or entity, or use of our name or trademark, is permitted only with our prior written permission. This report sets forth our findings solely with respect to the test samples identified herein. The results set forth in this report are not indicative or representative of the quality or characteristics of the lot from which a test sample was taken or any similar or identical product unless specifically and expressly noted. Our report includes all of the tests requested by you and the results thereof based upon the information that you provided to us. You have 60 days from date of issuance of this report to notify us of any material error or omission caused by our negligence, provided, however, that such notice shall be in writing and shall specifically address the issue you wish to raise. A failure to raise such issue within the prescribed time shall constitute your unqualified acceptance of the completeness of this report, the tests conducted and the correctness of the report contents. Unless specific mention, the uncertainty of measurement has been explicitly taken into account to declare the compliance or non-compliance to the specification.



## Table of Contents

Release Control Record .....	3
1. Summary of Maximum SAR Value .....	4
2. Description of Equipment Under Test .....	5
3. SAR Measurement System .....	6
3.1 Definition of Specific Absorption Rate (SAR) .....	6
3.2 SPEAG DASY System .....	6
3.2.1 Robot.....	7
3.2.2 Probes.....	8
3.2.3 Data Acquisition Electronics (DAE) .....	8
3.2.4 Phantoms .....	9
3.2.5 Device Holder.....	10
3.2.6 System Validation Dipoles.....	10
3.2.7 Tissue Simulating Liquids.....	11
3.3 SAR System Verification .....	14
3.4 SAR Measurement Procedure .....	15
3.4.1 Area & Zoom Scan Procedure .....	15
3.4.2 Volume Scan Procedure.....	15
3.4.3 Power Drift Monitoring.....	16
3.4.4 Spatial Peak SAR Evaluation .....	16
3.4.5 SAR Averaged Methods .....	16
4. SAR Measurement Evaluation .....	17
4.1 EUT Configuration and Setting.....	17
4.2 EUT Testing Position .....	20
4.2.1 SAR Test Exclusion Evaluations .....	21
4.2.2 Simultaneous Transmission Possibilities.....	22
4.3 Tissue Verification .....	22
4.4 System Validation.....	23
4.5 System Verification.....	23
4.6 Maximum Output Power.....	24
4.6.1 Maximum Conducted Power .....	24
4.6.2 Measured Conducted Power Result.....	25
4.7 SAR Testing Results .....	33
4.7.1 SAR Test Reduction Considerations .....	33
4.7.2 SAR Results for Body Exposure Condition .....	35
4.7.3 SAR Measurement Variability.....	37
4.7.4 Simultaneous Multi-band Transmission Evaluation .....	38
5. Calibration of Test Equipment.....	46
6. Measurement Uncertainty.....	47
7. Information on the Testing Laboratories.....	49

- Appendix A. SAR Plots of System Verification
- Appendix B. SAR Plots of SAR Measurement
- Appendix C. Calibration Certificate for Probe and Dipole
- Appendix D. Photographs of EUT and Setup



**1. Summary of Maximum SAR Value**

Equipment Class	Mode	Highest Reported Body SAR <sub>1g</sub> (W/kg)
PCB	LTE 2	1.21
	LTE 4	1.19
	LTE 13	0.58
DTS	2.4G WLAN	1.18
NII	5.3G WLAN	1.08
	5.8G WLAN	1.07
DSS	Bluetooth	N/A
<b>Highest Simultaneous Transmission SAR</b>		<b>Body (W/kg)</b>
PCB + DTS		2.32 (SPLSR=0.027)
PCB + NII		2.22 SPLSR (SPLSR=0.026)
PCB + DSS		1.58

**Note:**

- The SAR limit (**Head & Body: SAR<sub>1g</sub> 1.6 W/kg, Extremity: SAR<sub>10g</sub> 4.0 W/kg**) for general population / uncontrolled exposure is specified in FCC 47 CFR part 2 (2.1093) and ANSI/IEEE C95.1-1992.



# FCC SAR Test Report

## 2. Description of Equipment Under Test

<b>EUT Type</b>	Tablet PC
<b>FCC ID</b>	HFS-QTAIR7
<b>Brand Name</b>	Verizon
<b>Model Name</b>	QTAIR7
<b>Tx Frequency Bands (Unit: MHz)</b>	LTE Band 2 : 1850.7 ~ 1909.3 (1.4M), 1851.5 ~ 1908.5 (3M), 1852.5 ~ 1907.5 (5M), 1855 ~ 1905 (10M), 1857.5 ~ 1902.5 (15M), 1860 ~ 1900 (20M) LTE Band 4 : 1710.7 ~ 1754.3 (1.4M), 1711.5 ~ 1753.5 (3M), 1712.5 ~ 1752.5 (5M), 1715 ~ 1750 (10M), 1717.5 ~ 1747.5 (15M), 1720 ~ 1745 (20M) LTE Band 13 : 779.5 ~ 784.5 (5M), 782 (10M) WLAN : 2412 ~ 2462, 5180 ~ 5240, 5260 ~ 5320, 5745 ~ 5825 Bluetooth : 2402 ~ 2480
<b>Uplink Modulations</b>	LTE : QPSK, 16QAM 802.11b : DSSS 802.11a/g/n : OFDM Bluetooth : GFSK, $\pi/4$ -DQPSK, 8-DPSK
<b>Maximum Tune-up Conducted Power (Unit: dBm)</b>	Please refer to section 4.6.1 of this report.
<b>Antenna Type</b>	LTE: Fixed Internal Antenna WLAN/BT: PIFA Antenna
<b>EUT Stage</b>	Engineering Sample

**Note:**

1. The above EUT information is declared by manufacturer and for more detailed features description please refers to the manufacturer's specifications or User's Manual.

**List of Accessory:**

<b>Battery</b>	<b>Brand Name</b>	McNair
	<b>Model Name</b>	MLP3276120-2P
	<b>Power Rating</b>	3.85Vdc, 9100mAh
	<b>Type</b>	Li-ion

### **3. SAR Measurement System**

#### **3.1 Definition of Specific Absorption Rate (SAR)**

SAR is related to the rate at which energy is absorbed per unit mass in an object exposed to a radio field. The SAR distribution in a biological body is complicated and is usually carried out by experimental techniques or numerical modeling. The standard recommends limits for two tiers of groups, occupational/controlled and general population/uncontrolled, based on a person's awareness and ability to exercise control over his or her exposure. In general, occupational/controlled exposure limits are higher than the limits for general population/uncontrolled.

The SAR definition is the time derivative (rate) of the incremental energy (dW) absorbed by (dissipated in) an incremental mass (dm) contained in a volume element (dv) of a given density ( $\rho$ ). The equation description is as below:

$$\text{SAR} = \frac{d}{dt} \left( \frac{dW}{dm} \right) = \frac{d}{dt} \left( \frac{dW}{\rho dv} \right)$$

SAR is expressed in units of Watts per kilogram (W/kg)

SAR measurement can be related to the electrical field in the tissue by

$$\text{SAR} = \frac{\sigma |E|^2}{\rho}$$

Where:  $\sigma$  is the conductivity of the tissue,  $\rho$  is the mass density of the tissue and E is the RMS electrical field strength.

#### **3.2 SPEAG DASY System**

DASY system consists of high precision robot, probe alignment sensor, phantom, robot controller, controlled measurement server and near-field probe. The robot includes six axes that can move to the precision position of the DASY4/5 software defined. The DASY software can define the area that is detected by the probe. The robot is connected to controlled box. Controlled measurement server is connected to the controlled robot box. The DAE includes amplifier, signal multiplexing, AD converter, offset measurement and surface detection. It is connected to the Electro-optical coupler (ECO). The ECO performs the conversion from the optical into digital electric signal of the DAE and transfers data to the PC.



Fig-3.1 DASY System Setup

**3.2.1 Robot**

The DASY system uses the high precision robots from Stäubli SA (France). For the 6-axis controller system, the robot controller version (DASY4: CS7MB; DASY5: CS8c) from Stäubli is used. The Stäubli robot series have many features that are important for our application:

- High precision (repeatability  $\pm 0.035$  mm)
- High reliability (industrial design)
- Jerk-free straight movements
- Low ELF interference (the closed metallic construction shields against motor control fields)



Fig-3.2 DASY4





Fig-3.3 DASY5

# FCC SAR Test Report

## 3.2.2 Probes

The SAR measurement is conducted with the dosimetric probe. The probe is specially designed and calibrated for use in liquid with high permittivity. The dosimetric probe has special calibration in liquid at different frequency.

<b>Model</b>	EX3DV4	
<b>Construction</b>	Symmetrical design with triangular core. Built-in shielding against static charges. PEEK enclosure material (resistant to organic solvents, e.g., DGBE).	
<b>Frequency</b>	10 MHz to 6 GHz Linearity: $\pm 0.2$ dB	
<b>Directivity</b>	$\pm 0.3$ dB in HSL (rotation around probe axis) $\pm 0.5$ dB in tissue material (rotation normal to probe axis)	
<b>Dynamic Range</b>	10 $\mu$ W/g to 100 mW/g Linearity: $\pm 0.2$ dB (noise: typically $< 1$ $\mu$ W/g)	
<b>Dimensions</b>	Overall length: 337 mm (Tip: 20 mm) Tip diameter: 2.5 mm (Body: 12 mm) Typical distance from probe tip to dipole centers: 1 mm	

<b>Model</b>	ES3DV3	
<b>Construction</b>	Symmetrical design with triangular core. Interleaved sensors. Built-in shielding against static charges. PEEK enclosure material (resistant to organic solvents, e.g., DGBE).	
<b>Frequency</b>	10 MHz to 4 GHz Linearity: $\pm 0.2$ dB	
<b>Directivity</b>	$\pm 0.2$ dB in HSL (rotation around probe axis) $\pm 0.3$ dB in tissue material (rotation normal to probe axis)	
<b>Dynamic Range</b>	5 $\mu$ W/g to 100 mW/g Linearity: $\pm 0.2$ dB	
<b>Dimensions</b>	Overall length: 337 mm (Tip: 20 mm) Tip diameter: 3.9 mm (Body: 12 mm) Distance from probe tip to dipole centers: 2.0 mm	

## 3.2.3 Data Acquisition Electronics (DAE)

<b>Model</b>	DAE3, DAE4	
<b>Construction</b>	Signal amplifier, multiplexer, A/D converter and control logic. Serial optical link for communication with DASY embedded system (fully remote controlled). Two step probe touch detector for mechanical surface detection and emergency robot stop.	
<b>Measurement Range</b>	-100 to +300 mV (16 bit resolution and two range settings: 4mV, 400mV)	
<b>Input Offset Voltage</b>	$< 5$ $\mu$ V (with auto zero)	
<b>Input Bias Current</b>	$< 50$ fA	
<b>Dimensions</b>	60 x 60 x 68 mm	



# FCC SAR Test Report

## 3.2.4 Phantoms

<b>Model</b>	Twin SAM	
<b>Construction</b>	The shell corresponds to the specifications of the Specific Anthropomorphic Mannequin (SAM) phantom defined in IEEE 1528 and IEC 62209-1. It enables the dosimetric evaluation of left and right hand phone usage as well as body mounted usage at the flat phantom region. A cover prevents evaporation of the liquid. Reference markings on the phantom allow the complete setup of all predefined phantom positions and measurement grids by teaching three points with the robot.	
<b>Material</b>	Vinylester, glass fiber reinforced (VE-GF)	
<b>Shell Thickness</b>	2 ± 0.2 mm (6 ± 0.2 mm at ear point)	
<b>Dimensions</b>	Length: 1000 mm Width: 500 mm Height: adjustable feet	
<b>Filling Volume</b>	approx. 25 liters	

<b>Model</b>	ELI	
<b>Construction</b>	Phantom for compliance testing of handheld and body-mounted wireless devices in the frequency range of 30 MHz to 6 GHz. ELI is fully compatible with the IEC 62209-2 standard and all known tissue simulating liquids. ELI has been optimized regarding its performance and can be integrated into our standard phantom tables. A cover prevents evaporation of the liquid. Reference markings on the phantom allow installation of the complete setup, including all predefined phantom positions and measurement grids, by teaching three points. The phantom is compatible with all SPEAG dosimetric probes and dipoles.	
<b>Material</b>	Vinylester, glass fiber reinforced (VE-GF)	
<b>Shell Thickness</b>	2.0 ± 0.2 mm (bottom plate)	
<b>Dimensions</b>	Major axis: 600 mm Minor axis: 400 mm	
<b>Filling Volume</b>	approx. 30 liters	

# FCC SAR Test Report

## 3.2.5 Device Holder

<b>Model</b>	Mounting Device	
<b>Construction</b>	In combination with the Twin SAM Phantom or ELI4, the Mounting Device enables the rotation of the mounted transmitter device in spherical coordinates. Rotation point is the ear opening point. Transmitter devices can be easily and accurately positioned according to IEC, IEEE, FCC or other specifications. The device holder can be locked for positioning at different phantom sections (left head, right head, flat).	
<b>Material</b>	POM	

<b>Model</b>	Laptop Extensions Kit	
<b>Construction</b>	Simple but effective and easy-to-use extension for Mounting Device that facilitates the testing of larger devices according to IEC 62209-2 (e.g., laptops, cameras, etc.). It is lightweight and fits easily on the upper part of the Mounting Device in place of the phone positioner.	
<b>Material</b>	POM, Acrylic glass, Foam	

## 3.2.6 System Validation Dipoles

<b>Model</b>	D-Serial	
<b>Construction</b>	Symmetrical dipole with 1/4 balun. Enables measurement of feed point impedance with NWA. Matched for use near flat phantoms filled with tissue simulating solutions.	
<b>Frequency</b>	750 MHz to 5800 MHz	
<b>Return Loss</b>	> 20 dB	
<b>Power Capability</b>	> 100 W (f < 1GHz), > 40 W (f > 1GHz)	

# FCC SAR Test Report

## 3.2.7 Tissue Simulating Liquids

For SAR measurement of the field distribution inside the phantom, the phantom must be filled with homogeneous tissue simulating liquid to a depth of at least 15 cm. For head SAR testing, the liquid height from the ear reference point (ERP) of the phantom to the liquid top surface is larger than 15 cm. For body SAR testing, the liquid height from the center of the flat phantom to the liquid top surface is larger than 15 cm. The nominal dielectric values of the tissue simulating liquids in the phantom and the tolerance of 5% are listed in Table-3.1.

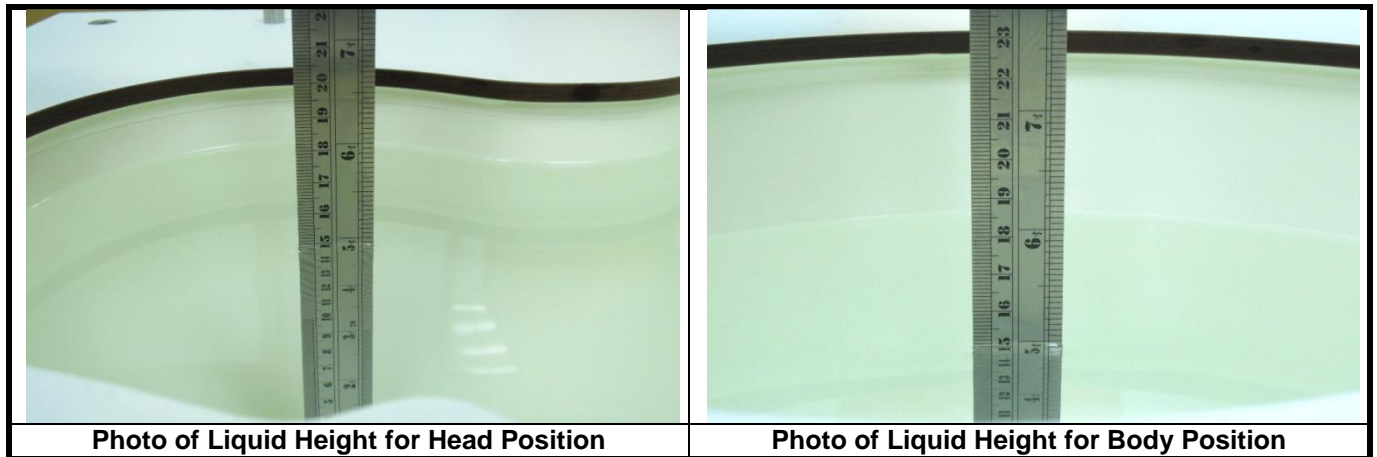

The dielectric properties of the head tissue simulating liquids are defined in IEEE 1528, and KDB 865664 D01 Appendix A. For the body tissue simulating liquids, the dielectric properties are defined in KDB 865664 D01 Appendix A. The dielectric properties of the tissue simulating liquids were verified prior to the SAR evaluation using a dielectric assessment kit and a network analyzer.



# FCC SAR Test Report

**Table-3.1 Targets of Tissue Simulating Liquid**

Frequency (MHz)	Target Permittivity	Range of $\pm 5\%$	Target Conductivity	Range of $\pm 5\%$
<b>For Head</b>				
750	41.9	39.8 ~ 44.0	0.89	0.85 ~ 0.93
835	41.5	39.4 ~ 43.6	0.90	0.86 ~ 0.95
900	41.5	39.4 ~ 43.6	0.97	0.92 ~ 1.02
1450	40.5	38.5 ~ 42.5	1.20	1.14 ~ 1.26
1640	40.3	38.3 ~ 42.3	1.29	1.23 ~ 1.35
1750	40.1	38.1 ~ 42.1	1.37	1.30 ~ 1.44
1800	40.0	38.0 ~ 42.0	1.40	1.33 ~ 1.47
1900	40.0	38.0 ~ 42.0	1.40	1.33 ~ 1.47
2000	40.0	38.0 ~ 42.0	1.40	1.33 ~ 1.47
2300	39.5	37.5 ~ 41.5	1.67	1.59 ~ 1.75
2450	39.2	37.2 ~ 41.2	1.80	1.71 ~ 1.89
2600	39.0	37.1 ~ 41.0	1.96	1.86 ~ 2.06
3500	37.9	36.0 ~ 39.8	2.91	2.76 ~ 3.06
5200	36.0	34.2 ~ 37.8	4.66	4.43 ~ 4.89
5300	35.9	34.1 ~ 37.7	4.76	4.52 ~ 5.00
5500	35.6	33.8 ~ 37.4	4.96	4.71 ~ 5.21
5600	35.5	33.7 ~ 37.3	5.07	4.82 ~ 5.32
5800	35.3	33.5 ~ 37.1	5.27	5.01 ~ 5.53
<b>For Body</b>				
750	55.5	52.7 ~ 58.3	0.96	0.91 ~ 1.01
835	55.2	52.4 ~ 58.0	0.97	0.92 ~ 1.02
900	55.0	52.3 ~ 57.8	1.05	1.00 ~ 1.10
1450	54.0	51.3 ~ 56.7	1.30	1.24 ~ 1.37
1640	53.8	51.1 ~ 56.5	1.40	1.33 ~ 1.47
1750	53.4	50.7 ~ 56.1	1.49	1.42 ~ 1.56
1800	53.3	50.6 ~ 56.0	1.52	1.44 ~ 1.60
1900	53.3	50.6 ~ 56.0	1.52	1.44 ~ 1.60
2000	53.3	50.6 ~ 56.0	1.52	1.44 ~ 1.60
2300	52.9	50.3 ~ 55.5	1.81	1.72 ~ 1.90
2450	52.7	50.1 ~ 55.3	1.95	1.85 ~ 2.05
2600	52.5	49.9 ~ 55.1	2.16	2.05 ~ 2.27
3500	51.3	48.7 ~ 53.9	3.31	3.14 ~ 3.48
5200	49.0	46.6 ~ 51.5	5.30	5.04 ~ 5.57
5300	48.9	46.5 ~ 51.3	5.42	5.15 ~ 5.69
5500	48.6	46.2 ~ 51.0	5.65	5.37 ~ 5.93
5600	48.5	46.1 ~ 50.9	5.77	5.48 ~ 6.06
5800	48.2	45.8 ~ 50.6	6.00	5.70 ~ 6.30

# FCC SAR Test Report

The following table gives the recipes for tissue simulating liquids.

**Table-3.2 Recipes of Tissue Simulating Liquid**

Tissue Type	Bactericide	DGBE	HEC	NaCl	Sucrose	Triton X-100	Water	Diethylene Glycol Mono-hexylether
H750	0.2	-	0.2	1.5	56.0	-	42.1	-
H835	0.2	-	0.2	1.5	57.0	-	41.1	-
H900	0.2	-	0.2	1.4	58.0	-	40.2	-
H1450	-	43.3	-	0.6	-	-	56.1	-
H1640	-	45.8	-	0.5	-	-	53.7	-
H1750	-	47.0	-	0.4	-	-	52.6	-
H1800	-	44.5	-	0.3	-	-	55.2	-
H1900	-	44.5	-	0.2	-	-	55.3	-
H2000	-	44.5	-	0.1	-	-	55.4	-
H2300	-	44.9	-	0.1	-	-	55.0	-
H2450	-	45.0	-	0.1	-	-	54.9	-
H2600	-	45.1	-	0.1	-	-	54.8	-
H3500	-	8.0	-	0.2	-	20.0	71.8	-
H5G	-	-	-	-	-	17.2	65.5	17.3
B750	0.2	-	0.2	0.8	48.8	-	50.0	-
B835	0.2	-	0.2	0.9	48.5	-	50.2	-
B900	0.2	-	0.2	0.9	48.2	-	50.5	-
B1450	-	34.0	-	0.3	-	-	65.7	-
B1640	-	32.5	-	0.3	-	-	67.2	-
B1750	-	31.0	-	0.2	-	-	68.8	-
B1800	-	29.5	-	0.4	-	-	70.1	-
B1900	-	29.5	-	0.3	-	-	70.2	-
B2000	-	30.0	-	0.2	-	-	69.8	-
B2300	-	31.0	-	0.1	-	-	68.9	-
B2450	-	31.4	-	0.1	-	-	68.5	-
B2600	-	31.8	-	0.1	-	-	68.1	-
B3500	-	28.8	-	0.1	-	-	71.1	-
B5G	-	-	-	-	-	10.7	78.6	10.7

### 3.3 SAR System Verification

The system check verifies that the system operates within its specifications. It is performed daily or before every SAR measurement. The system check uses normal SAR measurements in the flat section of the phantom with a matched dipole at a specified distance. The system verification setup is shown as below.

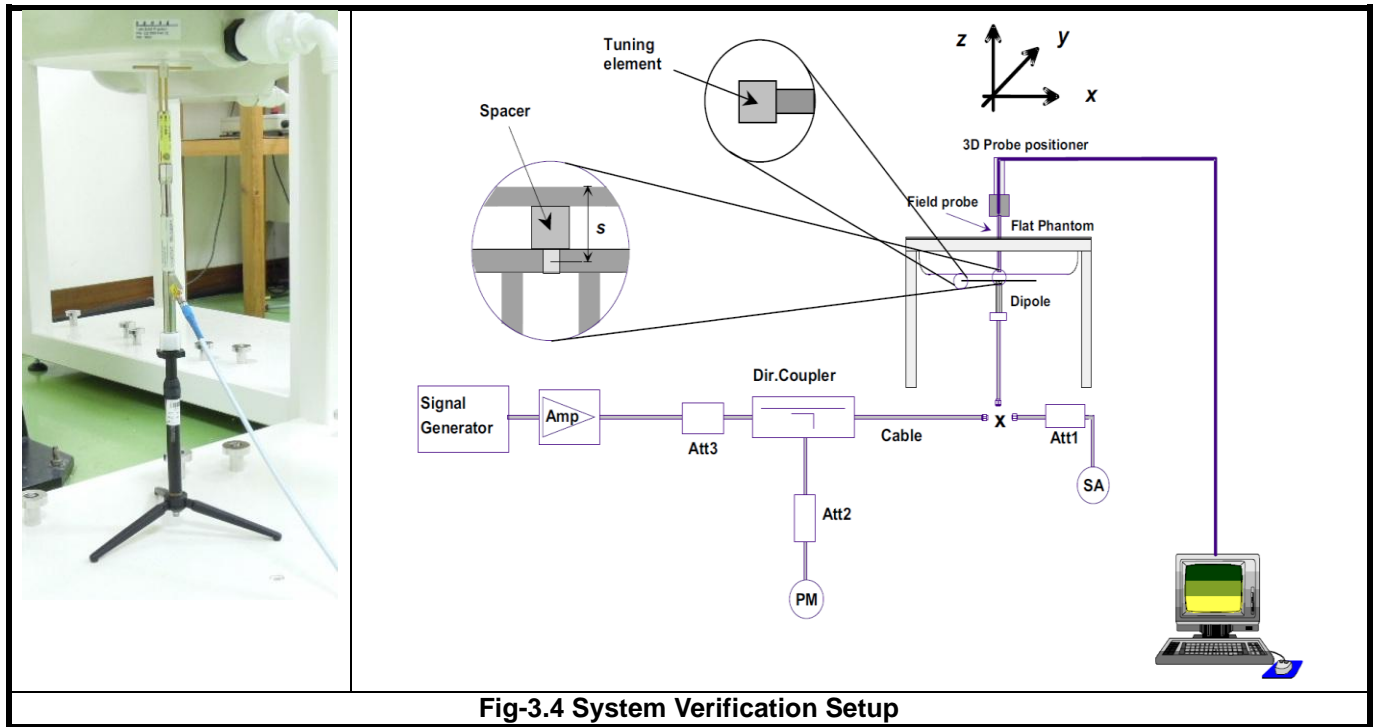

**Fig-3.4 System Verification Setup**

The validation dipole is placed beneath the flat phantom with the specific spacer in place. The distance spacer is touch the phantom surface with a light pressure at the reference marking and be oriented parallel to the long side of the phantom. The spectrum analyzer measures the forward power at the location of the system check dipole connector. The signal generator is adjusted for the desired forward power (250 mW is used for 700 MHz to 3 GHz, 100 mW is used for 3.5 GHz to 6 GHz) at the dipole connector and the power meter is read at that level. After connecting the cable to the dipole, the signal generator is readjusted for the same reading at power meter.

After system check testing, the SAR result will be normalized to 1W forward input power and compared with the reference SAR value derived from validation dipole certificate report. The deviation of system check should be within 10 %.

### 3.4 SAR Measurement Procedure

According to the SAR test standard, the recommended procedure for assessing the peak spatial-average SAR value consists of the following steps:

- (a) Power reference measurement
- (b) Area scan
- (c) Zoom scan
- (d) Power drift measurement

The SAR measurement procedures for each of test conditions are as follows:

- (a) Make EUT to transmit maximum output power
- (b) Measure conducted output power through RF cable
- (c) Place the EUT in the specific position of phantom
- (d) Perform SAR testing steps on the DASY system
- (e) Record the SAR value

#### 3.4.1 Area & Zoom Scan Procedure

First Area Scan is used to locate the approximate location(s) of the local peak SAR value(s). The measurement grid within an Area Scan is defined by the grid extent, grid step size and grid offset. Next, in order to determine the EM field distribution in a three-dimensional spatial extension, Zoom Scan is required. The Zoom Scan is performed around the highest E-field value to determine the averaged SAR-distribution over 10 g. According to KDB 865664 D01, the resolution for Area and Zoom scan is specified in the table below.

Items	<= 2 GHz	2-3 GHz	3-4 GHz	4-5 GHz	5-6 GHz
Area Scan ( $\Delta x, \Delta y$ )	<= 15 mm	<= 12 mm	<= 12 mm	<= 10 mm	<= 10 mm
Zoom Scan ( $\Delta x, \Delta y$ )	<= 8 mm	<= 5 mm	<= 5 mm	<= 4 mm	<= 4 mm
Zoom Scan ( $\Delta z$ )	<= 5 mm	<= 5 mm	<= 4 mm	<= 3 mm	<= 2 mm
Zoom Scan Volume	>= 30 mm	>= 30 mm	>= 28 mm	>= 25 mm	>= 22 mm

**Note:**

When zoom scan is required and report SAR is <= 1.4 W/kg, the zoom scan resolution of  $\Delta x / \Delta y$  (2-3GHz: <= 8 mm, 3-4GHz: <= 7 mm, 4-6GHz: <= 5 mm) may be applied.

#### 3.4.2 Volume Scan Procedure

The volume scan is used for assess overlapping SAR distributions for antennas transmitting in different frequency bands. It is equivalent to an oversized zoom scan used in standalone measurements. The measurement volume will be used to enclose all the simultaneous transmitting antennas. For antennas transmitting simultaneously in different frequency bands, the volume scan is measured separately in each frequency band. In order to sum correctly to compute the 1g aggregate SAR, the EUT remain in the same test position for all measurements and all volume scan use the same spatial resolution and grid spacing. When all volume scan were completed, the software, SEMCAD postprocessor can combine and subsequently superpose these measurement data to calculating the multiband SAR.

## FCC SAR Test Report

---

### 3.4.3 Power Drift Monitoring

All SAR testing is under the EUT install full charged battery and transmit maximum output power. In DASY measurement software, the power reference measurement and power drift measurement procedures are used for monitoring the power drift of EUT during SAR test. Both these procedures measure the field at a specified reference position before and after the SAR testing. The software will calculate the field difference in dB. If the power drift more than 5%, the SAR will be retested.

### 3.4.4 Spatial Peak SAR Evaluation

The procedure for spatial peak SAR evaluation has been implemented according to the test standard. It can be conducted for 1g and 10g, as well as for user-specific masses. The DASY software includes all numerical procedures necessary to evaluate the spatial peak SAR value.

The base for the evaluation is a "cube" measurement. The measured volume must include the 1g and 10g cubes with the highest averaged SAR values. For that purpose, the center of the measured volume is aligned to the interpolated peak SAR value of a previously performed area scan.

The entire evaluation of the spatial peak values is performed within the post-processing engine (SEMCAD). The system always gives the maximum values for the 1g and 10g cubes. The algorithm to find the cube with highest averaged SAR is divided into the following stages:

- (a) Extraction of the measured data (grid and values) from the Zoom Scan
- (b) Calculation of the SAR value at every measurement point based on all stored data (A/D values and measurement parameters)
- (c) Generation of a high-resolution mesh within the measured volume
- (d) Interpolation of all measured values from the measurement grid to the high-resolution grid
- (e) Extrapolation of the entire 3-D field distribution to the phantom surface over the distance from sensor to surface
- (f) Calculation of the averaged SAR within masses of 1g and 10g

### 3.4.5 SAR Averaged Methods

In DASY, the interpolation and extrapolation are both based on the modified Quadratic Shepard's method. The interpolation scheme combines a least-square fitted function method and a weighted average method which are the two basic types of computational interpolation and approximation.

Extrapolation routines are used to obtain SAR values between the lowest measurement points and the inner phantom surface. The extrapolation distance is determined by the surface detection distance and the probe sensor offset. The uncertainty increases with the extrapolation distance. To keep the uncertainty within 1% for the 1 g and 10 g cubes, the extrapolation distance should not be larger than 5 mm.



## **4. SAR Measurement Evaluation**

### **4.1 EUT Configuration and Setting**

#### **<Considerations Related to Proximity Sensor>**

The device supports WWAN capabilities. It is designed with a proximity sensor which can trigger/not trigger power reduction for LTE on Rear Face of EUT for SAR compliance. Others RF capability (WLAN and Bluetooth) have no power reduction. The power levels for all wireless technologies and the power reduction please refer to section 4.6 of this report.

According to the procedures noticed in KDB 616217 D04, the proximity sensor triggering distance is 19 mm for EUT Rear Face. The conservation triggering distances based on the separation distance for the sensor trigger / not triggered as EUT with power reduction at 0 mm, and EUT without power reduction at 18 mm for EUT Rear Face is used to test SAR.

The power reduction is depends on the proximity sensor input. For a steady SAR test, the power reduction was enabled or disabled manually by engineering software during SAR testing.

#### **<Connections between EUT and System Simulator>**

For WWAN SAR testing, the EUT was linked and controlled by base station emulator (Anritsu MT8820C). Communication between the EUT and the emulator was established by air link. The distance between the EUT and the communicating antenna of the emulator is larger than 50 cm and the output power radiated from the emulator antenna is at least 30 dB smaller than the output power of EUT. The EUT was set from the emulator to radiate maximum output power during SAR testing.

# FCC SAR Test Report

## <Considerations Related to LTE for Setup and Testing>

This device contains LTE transmitter which follows 3GPP standards, is category 3, supports both QPSK and 16QAM modulations, and supported LTE band and channel bandwidth is listed in below. The output power was tested per 3GPP TS 36.521-1 maximum transmit procedures for both QPSK and 16QAM modulation. The results please refer to section 4.6 of this report.

EUT Supported LTE Band and Channel Bandwidth						
LTE Band	BW 1.4 MHz	BW 3 MHz	BW 5 MHz	BW 10 MHz	BW 15 MHz	BW 20 MHz
2	V	V	V	V	V	V
4	V	V	V	V	V	V
13			V	V		

The LTE maximum power reduction (MPR) in accordance with 3GPP TS 36.101 is active all times during LTE operation. The allowed MPR for the maximum output power is specified in below.

Modulation	Channel Bandwidth / RB Configurations						LTE MPR Setting (dB)
	BW 1.4 MHz	BW 3 MHz	BW 5 MHz	BW 10 MHz	BW 15 MHz	BW 20 MHz	
QPSK	> 5	> 4	> 8	> 12	> 16	> 18	1
16QAM	<= 5	<= 4	<= 8	<= 12	<= 16	<= 18	1
16QAM	> 5	> 4	> 8	> 12	> 16	> 18	2

**Note:** MPR is according to the standard and implemented in the circuit (mandatory).

In addition, the device is compliant with additional maximum power reduction (A-MPR) requirements defined in 3GPP TS 36.101 section 6.2.4 that was disabled for all FCC compliance testing.

During LTE SAR testing, the related parameters of operating band, channel bandwidth, uplink channel number, modulation type, and RB was set in base station simulator. When the EUT has registered and communicated to base station simulator, the simulator set to make EUT transmitting the maximum radiated power.

## FCC SAR Test Report

---

### <Considerations Related to WLAN for Setup and Testing>

In general, various vendor specific external test software and chipset based internal test modes are typically used for SAR measurement. These chipset based test mode utilities are generally hardware and manufacturer dependent, and often include substantial flexibility to reconfigure or reprogram a device. A Wi-Fi device must be configured to transmit continuously at the required data rate, channel bandwidth and signal modulation, using the highest transmission duty factor supported by the test mode tools for SAR measurement. The test frequencies established using test mode must correspond to the actual channel frequencies. When 802.11 frame gaps are accounted for in the transmission, a maximum transmission duty factor of 92 - 96% is typically achievable in most test mode configurations. A minimum transmission duty factor of 85% is required to avoid certain hardware and device implementation issues related to wide range SAR scaling. In addition, a periodic transmission duty factor is required for current generation SAR systems to measure SAR correctly. The reported SAR must be scaled to 100% transmission duty factor to determine compliance at the maximum tune-up tolerance limit.

According to KDB 248227 D01, this device has installed WLAN engineering testing software which can provide continuous transmitting RF signal. During WLAN SAR testing, this device was operated to transmit continuously at the maximum transmission duty with specified transmission mode, operating frequency, lowest data rate, and maximum output power.

### Initial Test Configuration

An initial test configuration is determined for OFDM transmission modes in 2.4 GHz and 5 GHz bands according to the channel bandwidth, modulation and data rate combination(s) with the highest maximum output power specified for production units in each standalone and aggregated frequency band. When the same maximum power is specified for multiple transmission modes in a frequency band, the largest channel bandwidth, lowest order modulation, lowest data rate and lowest order 802.11a/g/n/ac mode is used for SAR measurement, on the highest measured output power channel in the initial test configuration, for each frequency band.

### Subsequent Test Configuration

SAR measurement requirements for the remaining 802.11 transmission mode configurations that have not been tested in the initial test configuration are determined separately for each standalone and aggregated frequency band, in each exposure condition, according to the maximum output power specified for production units. Additional power measurements may be required to determine if SAR measurements are required for subsequent highest output power channels in a subsequent test configuration. When the highest reported SAR for the initial test configuration according to the initial test position or fixed exposure position requirements, is adjusted by the ratio of the subsequent test configuration to initial test configuration specified maximum output power and the adjusted SAR is  $\leq 1.2$  W/kg, SAR is not required for that subsequent test configuration.

## FCC SAR Test Report

### SAR Test Configuration and Channel Selection

When multiple channel bandwidth configurations in a frequency band have the same specified maximum output power, the initial test configuration is using largest channel bandwidth, lowest order modulation, lowest data rate, and lowest order 802.11 mode (i.e., 802.11a is chosen over 802.11n then 802.11ac or 802.11g is chosen over 802.11n). After an initial test configuration is determined, if multiple test channels have the same measured maximum output power, the channel chosen for SAR measurement is determined according to the following.

- 1) The channel closest to mid-band frequency is selected for SAR measurement.
- 2) For channels with equal separation from mid-band frequency; for example, high and low channels or two mid-band channels, the higher frequency (number) channel is selected for SAR measurement.

### 4.2 EUT Testing Position

For full-size tablet, according to KDB 616217 D04, SAR evaluation is required for back surface and edges of the devices. The back surface and edges of the tablet are tested with the tablet touching the phantom. Exposures from antennas through the front surface of the display section of a tablet are generally limited to the user's hands. Exposures to hands for typical consumer transmitters used in tablets are not expected to exceed the extremity SAR limit; therefore, SAR evaluation for the front surface of tablet display screens are generally not necessary. When voice mode is supported on a tablet and it is limited to speaker mode or headset operations only, additional SAR testing for this type of voice use is not required.

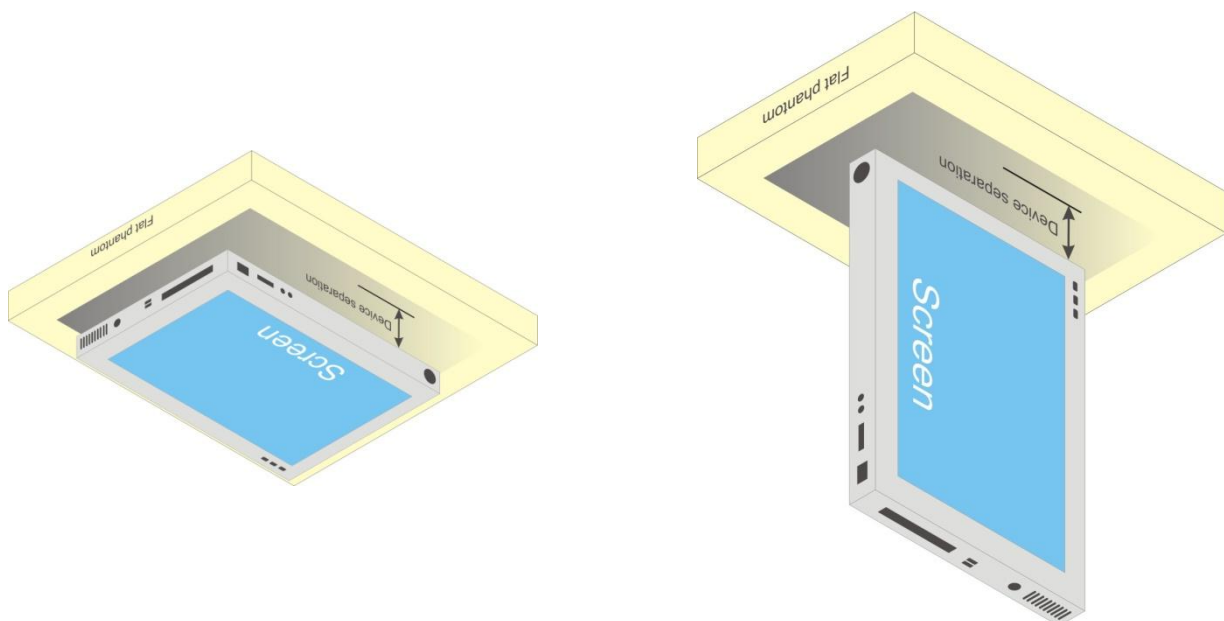

Fig-4.1 Illustration for Tablet Setup

# FCC SAR Test Report

## 4.2.1 SAR Test Exclusion Evaluations

According to KDB 447498 D01, the SAR test exclusion condition is based on source-based time-averaged maximum conducted output power, adjusted for tune-up tolerance, and the minimum test separation distance required for the exposure conditions. The SAR exclusion threshold is determined by the following formula.

- For the test separation distance  $\leq 50$  mm

$$\frac{\text{Max. Tune up Power}_{(mW)}}{\text{Min. Test Separation Distance}_{(mm)}} \times \sqrt{f_{(GHz)}} \leq 3.0 \text{ for SAR-1g, } \leq 7.5 \text{ for SAR-10g}$$

When the minimum test separation distance is  $< 5$  mm, a distance of 5 mm is applied to determine SAR test exclusion.

- For the test separation distance  $> 50$  mm, and the frequency at 100 MHz to 1500 MHz

$$\left[ (\text{Threshold at 50 mm in Step 1}) + (\text{Test Separation Distance} - 50 \text{ mm}) \times \left( \frac{f_{(MHz)}}{150} \right) \right]_{(mW)}$$

- For the test separation distance  $> 50$  mm, and the frequency at  $> 1500$  MHz to 6 GHz

$$[(\text{Threshold at 50 mm in Step 1}) + (\text{Test Separation Distance} - 50 \text{ mm}) \times 10]_{(mW)}$$

Mode	Max. Tune-up Power (dBm)	Max. Tune-up Power (mW)	Rear Face			Top Side			Bottom Side			Left Side			Right Side		
			Ant. to Surface (mm)	Calculated Result	Require SAR Testing?	Ant. to Surface (mm)	Calculated Result	Require SAR Testing?	Ant. to Surface (mm)	Calculated Result	Require SAR Testing?	Ant. to Surface (mm)	Calculated Result	Require SAR Testing?	Ant. to Surface (mm)	Calculated Result	Require SAR Testing?
LTE 2	24.5	281.84	5	77.9	YES	2.57	77.9	YES	149.52	1104 mW	No	15.93	24.4	YES	155.33	1162 mW	No
LTE 4	24.5	281.84	5	74.6	YES	2.57	74.6	YES	149.52	1108 mW	No	15.93	23.4	YES	155.33	1167 mW	No
LTE 13	24.0	251.19	5	44.5	YES	2.57	44.5	YES	149.52	690 mW	No	15.93	14.0	YES	155.33	721 mW	No
WLAN 2.4G	14.0	25.12	5	7.9	YES	138.2	978 mW	No	11.16	3.5	YES	5.03	7.8	YES	245.48	2050 mW	No
WLAN 5.2G	13.0	19.95	5	9.1	YES	138.2	948 mW	No	11.16	4.1	YES	5.03	9.1	YES	245.48	2020 Mw	No
WLAN 5.3G	13.5	22.39	5	10.3	YES	138.2	947 mW	No	11.16	4.6	YES	5.03	10.3	YES	245.48	2020 mW	No
WLAN 5.8G	11.5	14.13	5	6.8	YES	138.2	944 mW	No	11.16	3.1	YES	5.03	6.8	YES	245.48	2017 mW	No
BT	9.5	8.91	5	2.8	No	138.2	977 mW	No	11.16	1.3	No	5.03	2.8	No	245.48	2050 mW	No

### Note:

- When separation distance  $\leq 50$  mm and the calculated result shown in above table is  $\leq 3.0$  for SAR-1g exposure condition, or  $\leq 7.5$  for SAR-10g exposure condition, the SAR testing exclusion is applied.
- When separation distance  $> 50$  mm and the device output power is less than the calculated result (power threshold, mW) shown in above table, the SAR testing exclusion is applied.

# FCC SAR Test Report

## 4.2.2 Simultaneous Transmission Possibilities

The simultaneous transmission possibilities for this device are listed as below.

Simultaneous TX Combination	Capable Transmit Configurations	Body Exposure Condition
1	LTE 2 (Data) + WLAN (Data)	Yes
2	LTE 4 (Data) + WLAN (Data)	Yes
3	LTE 13 (Data) + WLAN (Data)	Yes
4	LTE 2 (Data) + BT (Data)	Yes
5	LTE 4 (Data) + BT (Data)	Yes
6	LTE 13 (Data) + BT (Data)	Yes

**Note:**

1. The 2.4G WLAN and 5G WLAN cannot transmit simultaneously.
2. The WLAN and Bluetooth cannot transmit simultaneously, so there is no co-location test requirement for WLAN and Bluetooth.
3. This device does not support voice transmission capability.

## 4.3 Tissue Verification

The measuring results for tissue simulating liquid are shown as below.

Test Date	Tissue Type	Frequency (MHz)	Liquid Temp. (°C)	Measured Conductivity ( $\sigma$ )	Measured Permittivity ( $\epsilon_r$ )	Target Conductivity ( $\sigma$ )	Target Permittivity ( $\epsilon_r$ )	Conductivity Deviation (%)	Permittivity Deviation (%)
Aug. 19, 2015	Body	750	22.8	0.960	54.365	0.96	55.5	0.00	-2.05
Aug. 26, 2015	Body	750	23.2	0.931	55.428	0.96	55.5	-3.02	-0.13
Aug. 15, 2015	Body	1750	22.8	1.446	51.758	1.49	53.4	-2.95	-3.07
Aug. 26, 2015	Body	1750	23.0	1.463	51.831	1.49	53.4	-1.81	-2.94
Aug. 26, 2015	Body	1900	23.0	1.579	51.714	1.52	53.3	3.88	-2.98
Aug. 15, 2015	Body	1900	22.8	1.576	51.349	1.52	53.3	3.68	-3.66
Aug. 19, 2015	Body	1900	22.9	1.579	51.327	1.52	53.3	3.88	-3.70
Aug. 25, 2015	Body	2450	23.1	2.017	51.065	1.95	52.7	3.44	-3.10
Aug. 26, 2015	Body	2450	23.1	2.017	51.060	1.95	52.7	3.44	-3.11
Aug. 14, 2015	Body	5300	22.8	5.342	50.805	5.42	48.9	-1.44	3.90
Aug. 26, 2015	Body	5300	23.3	5.316	50.949	5.42	48.9	-1.92	4.19
Aug. 14, 2015	Body	5800	22.8	6.153	49.738	6.00	48.2	2.55	3.19
Aug. 26, 2015	Body	5800	23.1	6.124	49.901	6.00	48.2	2.07	3.53

**Note:**

The dielectric properties of the tissue simulating liquid must be measured within 24 hours before the SAR testing and within  $\pm 5\%$  of the target values. Liquid temperature during the SAR testing must be within  $\pm 2^\circ\text{C}$ .

**4.4 System Validation**

The SAR measurement system was validated according to procedures in KDB 865664 D01. The validation status in tabulated summary is as below.

Test Date	Probe S/N	Calibration Point		Measured Conductivity ( $\sigma$ )	Measured Permittivity ( $\epsilon_r$ )	Validation for CW			Validation for Modulation		
						Sensitivity Range	Probe Linearity	Probe Isotropy	Modulation Type	Duty Factor	PAR
Aug. 19, 2015	3650	Body	750	0.960	54.365	Pass	Pass	Pass	N/A	N/A	N/A
Aug. 26, 2015	3650	Body	750	0.931	55.428	Pass	Pass	Pass	N/A	N/A	N/A
Aug. 15, 2015	3650	Body	1750	1.446	51.758	Pass	Pass	Pass	N/A	N/A	N/A
Aug. 26, 2015	3650	Body	1750	1.463	51.831	Pass	Pass	Pass	N/A	N/A	N/A
Aug. 26, 2015	3650	Body	1900	1.579	51.714	Pass	Pass	Pass	N/A	N/A	N/A
Aug. 15, 2015	3650	Body	1900	1.576	51.349	Pass	Pass	Pass	N/A	N/A	N/A
Aug. 19, 2015	3650	Body	1900	1.579	51.327	Pass	Pass	Pass	N/A	N/A	N/A
Aug. 25, 2015	3650	Body	2450	2.017	51.065	Pass	Pass	Pass	OFDM	N/A	Pass
Aug. 26, 2015	3650	Body	2450	2.017	51.060	Pass	Pass	Pass	OFDM	N/A	Pass
Aug. 14, 2015	3650	Body	5300	5.342	50.805	Pass	Pass	Pass	OFDM	N/A	Pass
Aug. 26, 2015	3650	Body	5300	5.316	50.949	Pass	Pass	Pass	OFDM	N/A	Pass
Aug. 14, 2015	3650	Body	5800	6.153	49.738	Pass	Pass	Pass	OFDM	N/A	Pass
Aug. 26, 2015	3650	Body	5800	6.124	49.901	Pass	Pass	Pass	OFDM	N/A	Pass

**4.5 System Verification**

The measuring result for system verification is tabulated as below.

Test Date	Mode	Frequency (MHz)	1W Target SAR-1g (W/kg)	Measured SAR-1g (W/kg)	Normalized to 1W SAR-1g (W/kg)	Deviation (%)	Dipole S/N	Probe S/N	DAE S/N
Aug. 19, 2015	Body	750	8.46	2.07	8.28	-2.13	1132	3650	1277
Aug. 26, 2015	Body	750	8.46	2.14	8.56	1.18	1132	3650	1277
Aug. 15, 2015	Body	1750	37.60	9.08	36.32	-3.40	1023	3650	1277
Aug. 26, 2015	Body	1750	37.60	9.19	36.76	-2.23	1023	3650	1277
Aug. 26, 2015	Body	1900	40.50	10.50	42.00	3.70	5d036	3650	1277
Aug. 15, 2015	Body	1900	40.50	10.40	41.60	2.72	5d036	3650	1277
Aug. 19, 2015	Body	1900	40.50	9.84	39.36	-2.81	5d036	3650	1277
Aug. 25, 2015	Body	2450	50.30	12.20	48.80	-2.98	835	3650	1277
Aug. 26, 2015	Body	2450	50.30	13.30	53.20	5.77	835	3650	1277
Aug. 14, 2015	Body	5300	75.20	7.48	74.80	-0.53	1040	3650	1277
Aug. 26, 2015	Body	5300	75.20	7.19	71.90	-4.39	1040	3650	1277
Aug. 14, 2015	Body	5800	76.60	7.96	79.60	3.92	1040	3650	1277
Aug. 26, 2015	Body	5800	76.60	7.16	71.60	-6.53	1040	3650	1277

**Note:**

Comparing to the reference SAR value provided by SPEAG, the validation data should be within its specification of 10 %. The result indicates the system check can meet the variation criterion and the plots can be referred to Appendix A of this report.

# FCC SAR Test Report

## 4.6 Maximum Output Power

### 4.6.1 Maximum Conducted Power

The maximum conducted average power (Unit: dBm) including tune-up tolerance is shown as below.

Mode	LTE 2 (without Power Reduction)	LTE 2 (with Power Reduction)	Power Reduction (dB)
QPSK / 16QAM	24.5	14.5	10

Mode	LTE 4 (without Power Reduction)	LTE 4 (with Power Reduction)	Power Reduction (dB)
QPSK / 16QAM	24.5	15.0	9.5

Mode	LTE 13 (without Power Reduction)	LTE 13 (with Power Reduction)	Power Reduction (dB)
QPSK / 16QAM	24.0	18.0	6.0

Mode	2.4G WLAN	5.2G WLAN	5.3G WLAN	5.8G WLAN
802.11b	CH1:12.0 CH6-11:14.0	N/A	N/A	N/A
802.11g	CH1:10.5 CH6-11:13.0	N/A	N/A	N/A
802.11a	N/A	13.0	13.5	11.5
802.11n HT20	CH1:10.5 CH6-11:12.5	13.0	13.0	11.0
802.11n HT40	CH1:9.0 CH6:13.0 CH11:11.0	13.0	13.0	11.0

Mode	2.4G Bluetooth
Bluetooth	9.5



# FCC SAR Test Report

## 4.6.2 Measured Conducted Power Result

The measuring conducted average power (Unit: dBm) is shown as below.

Band / BW	RB Size	RB Offset	QPSK			3GPP MPR (dB)	16QAM			3GPP MPR (dB)
			Low CH 18607	Mid CH 18900	High CH 19193		Low CH 18607	Mid CH 18900	High CH 19193	
			1850.7 MHz	1880.0 MHz	1909.3 MHz		1850.7 MHz	1880.0 MHz	1909.3 MHz	
<b>EUT without Power Reduction (P-Sensor NOT Triggered)</b>										
2 / 1.4M	1	0	22.70	23.03	22.96	0	21.65	21.98	21.91	1
	1	2	23.27	23.60	23.53	0	22.22	22.55	22.48	1
	1	5	22.63	22.96	22.89	0	21.58	21.91	21.84	1
	3	0	22.10	22.43	22.36	0	21.05	21.38	21.31	1
	3	1	22.28	22.61	22.54	0	21.23	21.56	21.49	1
	3	3	22.20	22.53	22.46	0	21.15	21.48	21.41	1
	6	0	22.44	22.77	22.70	1	21.39	21.72	21.65	2
<b>EUT with Power Reduction (P-Sensor Triggered)</b>										
2 / 1.4M	1	0	13.01	13.57	13.39	0	11.91	12.47	12.29	1
	1	2	13.30	13.86	13.68	0	12.20	12.76	12.58	1
	1	5	13.05	13.61	13.43	0	11.95	12.51	12.33	1
	3	0	12.39	12.95	12.77	0	11.29	11.85	11.67	1
	3	1	12.20	12.76	12.58	0	11.10	11.66	11.48	1
	3	3	12.24	12.80	12.62	0	11.14	11.70	11.52	1
	6	0	12.17	12.73	12.55	1	11.07	11.63	11.45	2

Band / BW	RB Size	RB Offset	QPSK			3GPP MPR (dB)	16QAM			3GPP MPR (dB)
			Low CH 18615	Mid CH 18900	High CH 19185		Low CH 18615	Mid CH 18900	High CH 19185	
			1851.5 MHz	1880.0 MHz	1908.5 MHz		1851.5 MHz	1880.0 MHz	1908.5 MHz	
<b>EUT without Power Reduction (P-Sensor NOT Triggered)</b>										
2 / 3M	1	0	22.81	23.14	23.07	0	21.76	22.09	22.02	1
	1	7	23.38	23.71	23.64	0	22.33	22.66	22.59	1
	1	14	22.74	23.07	23.00	0	21.69	22.02	21.95	1
	8	0	22.21	22.54	22.47	1	21.16	21.49	21.42	2
	8	3	22.39	22.72	22.65	1	21.34	21.67	21.60	2
	8	7	22.31	22.64	22.57	1	21.26	21.59	21.52	2
	15	0	22.55	22.88	22.81	1	21.50	21.83	21.76	2
<b>EUT with Power Reduction (P-Sensor Triggered)</b>										
2 / 3M	1	0	13.10	13.66	13.48	0	12.00	12.56	12.38	1
	1	7	13.39	13.95	13.77	0	12.29	12.85	12.67	1
	1	14	13.14	13.70	13.52	0	12.04	12.60	12.42	1
	8	0	12.48	13.04	12.86	1	11.38	11.94	11.76	2
	8	3	12.29	12.85	12.67	1	11.19	11.75	11.57	2
	8	7	12.33	12.89	12.71	1	11.23	11.79	11.61	2
	15	0	12.26	12.82	12.64	1	11.16	11.72	11.54	2

Band / BW	RB Size	RB Offset	QPSK			3GPP MPR (dB)	16QAM			3GPP MPR (dB)
			Low CH 18625	Mid CH 18900	High CH 19175		Low CH 18625	Mid CH 18900	High CH 19175	
			1852.5 MHz	1880.0 MHz	1907.5 MHz		1852.5 MHz	1880.0 MHz	1907.5 MHz	
<b>EUT without Power Reduction (P-Sensor NOT Triggered)</b>										
2 / 5M	1	0	22.88	23.21	23.14	0	21.83	22.16	22.09	1
	1	12	23.45	23.78	23.71	0	22.40	22.73	22.66	1
	1	24	22.81	23.14	23.07	0	21.76	22.09	22.02	1
	12	0	22.28	22.61	22.54	1	21.23	21.56	21.49	2
	12	6	22.46	22.79	22.72	1	21.41	21.74	21.67	2
	12	13	22.38	22.71	22.64	1	21.33	21.66	21.59	2
	25	0	22.62	22.95	22.88	1	21.57	21.90	21.83	2
<b>EUT with Power Reduction (P-Sensor Triggered)</b>										
2 / 5M	1	0	13.18	13.74	13.56	0	12.08	12.64	12.46	1
	1	12	13.47	14.03	13.85	0	12.37	12.93	12.75	1
	1	24	13.22	13.78	13.60	0	12.12	12.68	12.50	1
	12	0	12.56	13.12	12.94	1	11.46	12.02	11.84	2
	12	6	12.37	12.93	12.75	1	11.27	11.83	11.65	2
	12	13	12.41	12.97	12.79	1	11.31	11.87	11.69	2
	25	0	12.34	12.90	12.72	1	11.24	11.80	11.62	2

Band / BW	RB Size	RB Offset	QPSK			3GPP MPR (dB)	16QAM			3GPP MPR (dB)
			Low CH 18650	Mid CH 18900	High CH 19150		Low CH 18650	Mid CH 18900	High CH 19150	
			1855.0 MHz	1880.0 MHz	1905.0 MHz		1855.0 MHz	1880.0 MHz	1905.0 MHz	
<b>EUT without Power Reduction (P-Sensor NOT Triggered)</b>										
2 / 10M	1	0	22.98	23.31	23.24	0	21.93	22.26	22.19	1
	1	24	23.55	23.88	23.81	0	22.50	22.83	22.76	1
	1	49	22.91	23.24	23.17	0	21.86	22.19	22.12	1
	25	0	22.38	22.71	22.64	1	21.33	21.66	21.59	2
	25	12	22.56	22.89	22.82	1	21.51	21.84	21.77	2
	25	25	22.48	22.81	22.74	1	21.43	21.76	21.69	2
	50	0	22.72	23.05	22.98	1	21.67	22.00	21.93	2
<b>EUT with Power Reduction (P-Sensor Triggered)</b>										
2 / 10M	1	0	13.30	13.86	13.68	0	12.20	12.76	12.58	1
	1	24	13.59	14.15	13.97	0	12.49	13.05	12.87	1
	1	49	13.34	13.90	13.72	0	12.24	12.80	12.62	1
	25	0	12.68	13.24	13.06	1	11.58	12.14	11.96	2
	25	12	12.49	13.05	12.87	1	11.39	11.95	11.77	2
	25	25	12.53	13.09	12.91	1	11.43	11.99	11.81	2
	50	0	12.46	13.02	12.84	1	11.36	11.92	11.74	2

Band / BW	RB Size	RB Offset	QPSK			3GPP MPR (dB)	16QAM			3GPP MPR (dB)
			Low CH 18675	Mid CH 18900	High CH 19125		Low CH 18675	Mid CH 18900	High CH 19125	
			1857.5 MHz	1880.0 MHz	1902.5 MHz		1857.5 MHz	1880.0 MHz	1902.5 MHz	
<b>EUT without Power Reduction (P-Sensor NOT Triggered)</b>										
2 / 15M	1	0	23.06	23.39	23.32	0	22.01	22.34	22.27	1
	1	37	23.63	23.96	23.89	0	22.58	22.91	22.84	1
	1	74	22.99	23.32	23.25	0	21.94	22.27	22.20	1
	36	0	22.46	22.79	22.72	1	21.41	21.74	21.67	2
	36	19	22.64	22.97	22.90	1	21.59	21.92	21.85	2
	36	39	22.56	22.89	22.82	1	21.51	21.84	21.77	2
	75	0	22.80	23.13	23.06	1	21.75	22.08	22.01	2
<b>EUT with Power Reduction (P-Sensor Triggered)</b>										
2 / 15M	1	0	13.41	13.97	13.79	0	12.31	12.87	12.69	1
	1	37	13.70	14.26	14.08	0	12.60	13.16	12.98	1
	1	74	13.45	14.01	13.83	0	12.35	12.91	12.73	1
	36	0	12.79	13.35	13.17	1	11.69	12.25	12.07	2
	36	19	12.60	13.16	12.98	1	11.50	12.06	11.88	2
	36	39	12.64	13.20	13.02	1	11.54	12.10	11.92	2
	75	0	12.57	13.13	12.95	1	11.47	12.03	11.85	2

Band / BW	RB Size	RB Offset	QPSK			3GPP MPR (dB)	16QAM			3GPP MPR (dB)
			Low CH 18700	Mid CH 18900	High CH 19100		Low CH 18700	Mid CH 18900	High CH 19100	
			1860.0 MHz	1880.0 MHz	1900.0 MHz		1860.0 MHz	1880.0 MHz	1900.0 MHz	
<b>EUT without Power Reduction (P-Sensor NOT Triggered)</b>										
2 / 20M	1	0	23.18	23.51	23.44	0	22.13	22.46	22.39	1
	1	50	23.75	<b>24.08</b>	24.01	0	22.70	<b>23.03</b>	22.96	1
	1	99	23.11	23.44	23.37	0	22.06	22.39	22.32	1
	50	0	22.58	22.91	22.84	1	21.53	21.86	21.79	2
	50	25	22.76	23.09	23.02	1	21.71	22.04	21.97	2
	50	50	22.68	23.01	22.94	1	21.63	21.96	21.89	2
	100	0	22.92	23.25	23.18	1	21.87	22.20	22.13	2
<b>EUT with Power Reduction (P-Sensor Triggered)</b>										
2 / 20M	1	0	13.52	14.08	13.90	0	12.42	12.98	12.80	1
	1	50	13.81	<b>14.37</b>	14.19	0	12.71	<b>13.27</b>	13.09	1
	1	99	13.56	14.12	13.94	0	12.46	13.02	12.84	1
	50	0	12.90	13.46	13.28	1	11.80	12.36	12.18	2
	50	25	12.71	13.27	13.09	1	11.61	12.17	11.99	2
	50	50	12.75	13.31	13.13	1	11.65	12.21	12.03	2
	100	0	12.68	13.24	13.06	1	11.58	12.14	11.96	2

Band / BW	RB Size	RB Offset	QPSK			3GPP MPR (dB)	16QAM			3GPP MPR (dB)
			Low CH 19957	Mid CH 20175	High CH 20393		Low CH 19957	Mid CH 20175	High CH 20393	
			1710.7 MHz	1732.5 MHz	1754.3 MHz		1710.7 MHz	1732.5 MHz	1754.3 MHz	
<b>EUT without Power Reduction (P-Sensor NOT Triggered)</b>										
4 / 1.4M	1	0	23.14	23.26	23.56	0	22.09	22.21	22.51	1
	1	2	23.17	23.29	23.59	0	22.12	22.24	22.54	1
	1	5	23.15	23.27	23.57	0	22.10	22.22	22.52	1
	3	0	23.06	23.18	23.48	0	22.01	22.13	22.43	1
	3	1	23.09	23.21	23.51	0	22.04	22.16	22.46	1
	3	3	23.07	23.19	23.49	0	22.02	22.14	22.44	1
	6	0	22.30	22.42	22.72	1	21.25	21.37	21.67	2
<b>EUT with Power Reduction (P-Sensor Triggered)</b>										
4 / 1.4M	1	0	13.32	13.18	13.53	0	13.21	13.07	13.42	1
	1	2	13.89	13.75	14.10	0	13.78	13.64	13.99	1
	1	5	13.44	13.30	13.65	0	13.33	13.19	13.54	1
	3	0	12.91	12.77	13.12	0	12.80	12.66	13.01	1
	3	1	13.02	12.88	13.23	0	12.91	12.77	13.12	1
	3	3	12.80	12.66	13.01	0	12.69	12.55	12.90	1
	6	0	12.77	12.63	12.98	1	12.66	12.52	12.87	2

Band / BW	RB Size	RB Offset	QPSK			3GPP MPR (dB)	16QAM			3GPP MPR (dB)
			Low CH 19965	Mid CH 20175	High CH 20385		Low CH 19965	Mid CH 20175	High CH 20385	
			1711.5 MHz	1732.5 MHz	1753.5 MHz		1711.5 MHz	1732.5 MHz	1753.5 MHz	
<b>EUT without Power Reduction (P-Sensor NOT Triggered)</b>										
4 / 3M	1	0	23.27	23.39	23.69	0	22.22	22.34	22.64	1
	1	7	23.30	23.42	23.72	0	22.25	22.37	22.67	1
	1	14	23.28	23.40	23.70	0	22.23	22.35	22.65	1
	8	0	22.44	22.56	22.86	1	21.39	21.51	21.81	2
	8	3	22.47	22.59	22.89	1	21.42	21.54	21.84	2
	8	7	22.45	22.57	22.87	1	21.40	21.52	21.82	2
	15	0	22.43	22.55	22.85	1	21.38	21.50	21.80	2
<b>EUT with Power Reduction (P-Sensor Triggered)</b>										
4 / 3M	1	0	13.43	13.29	13.64	0	13.32	13.18	13.53	1
	1	7	14.00	13.86	14.21	0	13.89	13.75	14.10	1
	1	14	13.55	13.41	13.76	0	13.44	13.30	13.65	1
	8	0	13.02	12.88	13.23	1	12.91	12.77	13.12	2
	8	3	13.13	12.99	13.34	1	13.02	12.88	13.23	2
	8	7	12.91	12.77	13.12	1	12.80	12.66	13.01	2
	15	0	12.88	12.74	13.09	1	12.77	12.63	12.98	2

Band / BW	RB Size	RB Offset	QPSK			3GPP MPR (dB)	16QAM			3GPP MPR (dB)
			Low CH 19975	Mid CH 20175	High CH 20375		Low CH 19975	Mid CH 20175	High CH 20375	
			1712.5 MHz	1732.5 MHz	1752.5 MHz		1712.5 MHz	1732.5 MHz	1752.5 MHz	
<b>EUT without Power Reduction (P-Sensor NOT Triggered)</b>										
4 / 5M	1	0	23.34	23.46	23.76	0	22.29	22.41	22.71	1
	1	12	23.37	23.49	23.79	0	22.32	22.44	22.74	1
	1	24	23.35	23.47	23.77	0	22.30	22.42	22.72	1
	12	0	22.51	22.63	22.93	1	21.46	21.58	21.88	2
	12	6	22.54	22.66	22.96	1	21.49	21.61	21.91	2
	12	13	22.52	22.64	22.94	1	21.47	21.59	21.89	2
	25	0	22.50	22.62	22.92	1	21.45	21.57	21.87	2
<b>EUT with Power Reduction (P-Sensor Triggered)</b>										
4 / 5M	1	0	13.51	13.37	13.72	0	13.40	13.26	13.61	1
	1	12	14.08	13.94	14.29	0	13.97	13.83	14.18	1
	1	24	13.63	13.49	13.84	0	13.52	13.38	13.73	1
	12	0	13.10	12.96	13.31	1	12.99	12.85	13.20	2
	12	6	13.21	13.07	13.42	1	13.10	12.96	13.31	2
	12	13	12.99	12.85	13.20	1	12.88	12.74	13.09	2
	25	0	12.96	12.82	13.17	1	12.85	12.71	13.06	2

Band / BW	RB Size	RB Offset	QPSK			3GPP MPR (dB)	16QAM			3GPP MPR (dB)
			Low CH 20000	Mid CH 20175	High CH 20350		Low CH 20000	Mid CH 20175	High CH 20350	
			1715.0 MHz	1732.5 MHz	1750.0 MHz		1715.0 MHz	1732.5 MHz	1750.0 MHz	
<b>EUT without Power Reduction (P-Sensor NOT Triggered)</b>										
4 / 10M	1	0	23.40	23.52	23.82	0	22.35	22.47	22.77	1
	1	24	23.43	23.55	23.85	0	22.38	22.50	22.80	1
	1	49	23.41	23.53	23.83	0	22.36	22.48	22.78	1
	25	0	22.57	22.69	22.99	1	21.52	21.64	21.94	2
	25	12	22.60	22.72	23.02	1	21.55	21.67	21.97	2
	25	25	22.58	22.70	23.00	1	21.53	21.65	21.95	2
	50	0	22.56	22.68	22.98	1	21.51	21.63	21.93	2
<b>EUT with Power Reduction (P-Sensor Triggered)</b>										
4 / 10M	1	0	13.62	13.48	13.83	0	13.51	13.37	13.72	1
	1	24	14.19	14.05	14.40	0	14.08	13.94	14.29	1
	1	49	13.74	13.60	13.95	0	13.63	13.49	13.84	1
	25	0	13.21	13.07	13.42	1	13.10	12.96	13.31	2
	25	12	13.32	13.18	13.53	1	13.21	13.07	13.42	2
	25	25	13.10	12.96	13.31	1	12.99	12.85	13.20	2
	50	0	13.07	12.93	13.28	1	12.96	12.82	13.17	2

Band / BW	RB Size	RB Offset	QPSK			3GPP MPR (dB)	16QAM			3GPP MPR (dB)
			Low CH 20025	Mid CH 20175	High CH 20325		Low CH 20025	Mid CH 20175	High CH 20325	
			1717.5 MHz	1732.5 MHz	1747.5 MHz		1717.5 MHz	1732.5 MHz	1747.5 MHz	
<b>EUT without Power Reduction (P-Sensor NOT Triggered)</b>										
4 / 15M	1	0	23.51	23.63	23.93	0	22.46	22.58	22.88	1
	1	37	23.54	23.66	23.96	0	22.49	22.61	22.91	1
	1	74	23.52	23.64	23.94	0	22.47	22.59	22.89	1
	36	0	22.68	22.80	23.10	1	21.63	21.75	22.05	2
	36	19	22.71	22.83	23.13	1	21.66	21.78	22.08	2
	36	39	22.69	22.81	23.11	1	21.64	21.76	22.06	2
	75	0	22.67	22.79	23.09	1	21.62	21.74	22.04	2
<b>EUT with Power Reduction (P-Sensor Triggered)</b>										
4 / 15M	1	0	13.72	13.58	13.93	0	13.61	13.47	13.82	1
	1	37	14.29	14.15	14.50	0	14.18	14.04	14.39	1
	1	74	13.84	13.70	14.05	0	13.73	13.59	13.94	1
	36	0	13.31	13.17	13.52	1	13.20	13.06	13.41	2
	36	19	13.42	13.28	13.63	1	13.31	13.17	13.52	2
	36	39	13.20	13.06	13.41	1	13.09	12.95	13.30	2
	75	0	13.17	13.03	13.38	1	13.06	12.92	13.27	2

Band / BW	RB Size	RB Offset	QPSK			3GPP MPR (dB)	16QAM			3GPP MPR (dB)
			Low CH 20050	Mid CH 20175	High CH 20300		Low CH 20050	Mid CH 20175	High CH 20300	
			1720.0 MHz	1732.5 MHz	1745.0 MHz		1720.0 MHz	1732.5 MHz	1745.0 MHz	
<b>EUT without Power Reduction (P-Sensor NOT Triggered)</b>										
4 / 20M	1	0	23.63	23.75	24.05	0	22.58	22.70	23.00	1
	1	50	23.66	23.78	<b>24.08</b>	0	22.61	22.73	<b>23.03</b>	1
	1	99	23.64	23.76	24.06	0	22.59	22.71	23.01	1
	50	0	22.80	22.92	23.22	1	21.75	21.87	22.17	2
	50	25	22.83	22.95	23.25	1	21.78	21.90	22.20	2
	50	50	22.81	22.93	23.23	1	21.76	21.88	22.18	2
	100	0	22.79	22.91	23.21	1	21.74	21.86	22.16	2
<b>EUT with Power Reduction (P-Sensor Triggered)</b>										
4 / 20M	1	0	13.84	13.70	14.05	0	13.73	13.59	13.94	1
	1	50	14.41	14.27	<b>14.62</b>	0	14.30	14.16	<b>14.51</b>	1
	1	99	13.96	13.82	14.17	0	13.85	13.71	14.06	1
	50	0	13.43	13.29	13.64	1	13.32	13.18	13.53	2
	50	25	13.54	13.40	13.75	1	13.43	13.29	13.64	2
	50	50	13.32	13.18	13.53	1	13.21	13.07	13.42	2
	100	0	13.29	13.15	13.50	1	13.18	13.04	13.39	2



FCC SAR Test Report

A D T

Band / BW	RB Size	RB Offset	QPSK			3GPP MPR (dB)	16QAM			3GPP MPR (dB)
			Low CH 23205	Mid CH 23230	High CH 23255		Low CH 23205	Mid CH 23230	High CH 23255	
			779.5 MHz	782.0 MHz	784.5 MHz		779.5 MHz	782.0 MHz	784.5 MHz	
<b>EUT without Power Reduction (P-Sensor NOT Triggered)</b>										
13 / 5M	1	0	23.08	23.28	23.72	0	22.01	22.21	22.65	1
	1	12	22.97	23.17	23.61	0	21.90	22.10	22.54	1
	1	24	22.71	22.91	23.35	0	21.64	21.84	22.28	1
	12	0	22.25	22.45	22.89	1	21.18	21.38	21.82	2
	12	6	22.16	22.36	22.80	1	21.09	21.29	21.73	2
	12	13	21.96	22.16	22.60	1	20.89	21.09	21.53	2
	25	0	22.13	22.33	22.77	1	21.06	21.26	21.70	2
<b>EUT with Power Reduction (P-Sensor Triggered)</b>										
13 / 5M	1	0	17.46	17.20	17.38	0	16.45	16.19	16.37	1
	1	12	17.48	17.22	17.40	0	16.47	16.21	16.39	1
	1	24	17.66	17.40	17.58	0	16.65	16.39	16.57	1
	12	0	16.52	16.26	16.44	1	15.51	15.25	15.43	2
	12	6	16.51	16.25	16.43	1	15.50	15.24	15.42	2
	12	13	16.72	16.46	16.64	1	15.71	15.45	15.63	2
	25	0	16.38	16.12	16.30	1	15.37	15.11	15.29	2

Band / BW	RB Size	RB Offset	QPSK		3GPP MPR (dB)	16QAM		3GPP MPR (dB)
			Mid CH 23230			Mid CH 23230		
			782.0 MHz			782.0 MHz		
<b>EUT without Power Reduction (P-Sensor NOT Triggered)</b>								
13 / 10M	1	0	23.60		0	22.55		1
	1	24	<b>23.81</b>		0	<b>22.76</b>		1
	1	49	23.50		0	22.45		1
	25	0	22.79		1	21.74		2
	25	12	22.77		1	21.72		2
	25	25	22.92		1	21.87		2
	50	0	22.73		1	21.68		2
<b>EUT with Power Reduction (P-Sensor Triggered)</b>								
13 / 10M	1	0	17.27		0	16.25		1
	1	24	<b>17.66</b>		0	<b>16.64</b>		1
	1	49	16.99		0	15.97		1
	25	0	16.44		1	15.42		2
	25	12	16.18		1	15.16		2
	25	25	16.44		1	15.42		2
	50	0	16.03		1	15.01		2



# FCC SAR Test Report

## <WLAN 2.4G>

Mode	802.11b		
Channel / Frequency (MHz)	1 (2412)	6 (2437)	11 (2462)
Average Power	11.81	13.45	13.72
Mode	802.11g		
Channel / Frequency (MHz)	1 (2412)	6 (2437)	11 (2462)
Average Power	10.04	12.96	12.72
Mode	802.11n (HT20)		
Channel / Frequency (MHz)	1 (2412)	6 (2437)	11 (2462)
Average Power	10.12	12.05	11.61
Mode	802.11n (HT40)		
Channel / Frequency (MHz)	3 (2422)	6 (2437)	9 (2452)
Average Power	8.84	12.49	10.69

## <WLAN 5.2G>

Mode	802.11a			
Channel / Frequency (MHz)	36 (5180)	40 (5200)	44 (5220)	48 (5240)
Average Power	12.85	12.81	12.73	12.63
Mode	802.11n (HT20)			
Channel / Frequency (MHz)	36 (5180)	40 (5200)	44 (5220)	48 (5240)
Average Power	12.15	12.14	12.04	11.93
Mode	802.11n (HT40)			
Channel / Frequency (MHz)	38 (5190)		46 (5230)	
Average Power	12.51		12.46	

## <WLAN 5.3G>

Mode	802.11a			
Channel / Frequency (MHz)	52 (5260)	56 (5280)	60 (5300)	64 (5320)
Average Power	12.56	12.54	13.35	13.18
Mode	802.11n (HT20)			
Channel / Frequency (MHz)	52 (5260)	56 (5280)	60 (5300)	64 (5320)
Average Power	11.74	11.76	11.73	12.41
Mode	802.11n (HT40)			
Channel / Frequency (MHz)	54 (5270)		62 (5310)	
Average Power	12.24		11.70	

## <WLAN 5.8G>

Mode	802.11a				
Channel / Frequency (MHz)	149 (5745)	153 (5765)	157 (5785)	161 (5805)	165 (5825)
Average Power	10.16	10.47	10.85	10.97	11.06
Mode	802.11n (HT20)				
Channel / Frequency (MHz)	149 (5745)	153 (5765)	157 (5785)	161 (5805)	165 (5825)
Average Power	9.35	9.66	9.88	9.27	9.33
Mode	802.11n (HT40)				
Channel / Frequency (MHz)	151 (5755)			159 (5795)	
Average Power	9.84			9.36	

## <Bluetooth>

Mode	Bluetooth		
Channel / Frequency (MHz)	0 (2402)	39 (2441)	78 (2480)
Average Power	9.07	9.39	9.40



## **4.7 SAR Testing Results**

### **4.7.1 SAR Test Reduction Considerations**

#### **<KDB 447498 D01, General RF Exposure Guidance>**

Testing of other required channels within the operating mode of a frequency band is not required when the reported SAR for the mid-band or highest output power channel is:

- (1)  $\leq 0.8$  W/kg or 2.0 W/kg, for 1-g or 10-g respectively, when the transmission band is  $\leq 100$  MHz
- (2)  $\leq 0.6$  W/kg or 1.5 W/kg, for 1-g or 10-g respectively, when the transmission band is between 100 MHz and 200 MHz
- (3)  $\leq 0.4$  W/kg or 1.0 W/kg, for 1-g or 10-g respectively, when the transmission band is  $\geq 200$  MHz

#### **<KDB 941225 D05, SAR Evaluation Considerations for LTE Devices>**

##### (1) QPSK with 1 RB and 50% RB allocation

Start with the largest channel bandwidth and measure SAR, using the RB offset and required test channel combination with the highest maximum output power among RB offsets at the upper edge, middle and lower edge of each required test channel. When the reported SAR is  $\leq 0.8$  W/kg, testing of the remaining RB offset configurations and required test channels is not required; otherwise, SAR is required for the remaining required test channels and only for the RB offset configuration with the highest output power for that channel. When the reported SAR of a required test channel is  $> 1.45$  W/kg, SAR is required for all three RB offset configurations for that required test channel.

##### (2) QPSK with 100% RB allocation

SAR is not required when the highest maximum output power for 100% RB allocation is less than the highest maximum output power in 50% and 1 RB allocations and the highest reported SAR for 1 RB and 50% RB allocation are  $\leq 0.8$  W/kg. Otherwise, SAR is measured for the highest output power channel; and if the reported SAR is  $> 1.45$  W/kg, the remaining required test channels must also be tested.

##### (3) Higher order modulations

SAR is required only when the highest maximum output power for the configuration in the higher order modulation is  $> 1/2$  dB higher than the same configuration in QPSK or when the reported SAR for the QPSK configuration is  $> 1.45$  W/kg.

##### (4) Other channel bandwidth

SAR is required when the highest maximum output power of the smaller channel bandwidth is  $> 1/2$  dB higher than the equivalent channel configurations in the largest channel bandwidth configuration or the reported SAR of a configuration for the largest channel bandwidth is  $> 1.45$  W/kg.



## FCC SAR Test Report

---

### <KDB 248227 D01, SAR Guidance for Wi-Fi Transmitters>

- (1) For handsets operating next to ear, hotspot mode or mini-tablet configurations, the initial test position procedures were applied. The test position with the highest extrapolated peak SAR will be used as the initial test position. When the reported SAR of initial test position is  $\leq 0.4$  W/kg, SAR testing for remaining test positions is not required. Otherwise, SAR is evaluated at the subsequent highest peak SAR positions until the reported SAR result is  $\leq 0.8$  W/kg or all test positions are measured.
- (2) For WLAN 2.4 GHz, the highest measured maximum output power channel for DSSS was selected for SAR measurement. When the reported SAR is  $\leq 0.8$  W/kg, no further SAR testing is required. Otherwise, SAR is evaluated at the next highest measured output power channel. When any reported SAR is  $> 1.2$  W/kg, SAR is required for the third channel. For OFDM modes (802.11g/n), SAR is not required when the highest reported SAR for DSSS is adjusted by the ratio of OFDM to DSSS specified maximum output power and it is  $\leq 1.2$  W/kg.
- (3) For WLAN 5 GHz, the initial test configuration was selected according to the transmission mode with the highest maximum output power. When the reported SAR of initial test configuration is  $> 0.8$  W/kg, SAR is required for the subsequent highest measured output power channel until the reported SAR result is  $\leq 1.2$  W/kg or all required channels are measured. For other transmission modes, SAR is not required when the highest reported SAR for initial test configuration is adjusted by the ratio of subsequent test configuration to initial test configuration specified maximum output power and it is  $\leq 1.2$  W/kg.



# FCC SAR Test Report

A D T

## 4.7.2 SAR Results for Body Exposure Condition

Plot No.	Band	Mode	Test Position	Separation Distance (cm)	Ch.	Power Reduction	RB#	RB Offset	Max. Tune-up Power (dBm)	Measured Conducted Power (dBm)	Scaling Factor	Power Drift (dB)	Measured SAR-1g (W/kg)	Scaled SAR-1g (W/kg)
	LTE 2	QPSK20M	Rear Face	0	18900	w/	1	50	14.5	14.37	1.03	0.05	0.814	0.84
	LTE 2	QPSK20M	Rear Face	0	18700	w/	1	50	14.5	13.81	1.17	0.06	0.777	0.91
	LTE 2	QPSK20M	Rear Face	0	19100	w/	1	50	14.5	14.19	1.07	0.03	0.647	0.69
	LTE 2	QPSK20M	Rear Face	0	18900	w/	50	0	13.5	13.46	1.01	-0.02	0.613	0.62
	LTE 2	QPSK20M	Rear Face	0	18900	w/	100	0	13.5	13.24	1.06	0.03	0.572	0.61
	LTE 2	QPSK20M	Rear Face	1.8	18900	w/o	1	50	24.5	24.08	1.10	0.11	0.150	0.17
	LTE 2	QPSK20M	Rear Face	1.8	18900	w/o	50	25	23.5	23.09	1.10	-0.07	0.116	0.13
	LTE 2	QPSK20M	Left Side	0	18900	w/o	1	50	24.5	24.08	1.10	0.07	0.789	0.87
01	LTE 2	QPSK20M	Left Side	0	18700	w/o	1	50	24.5	23.75	1.19	0.02	1.02	1.21
	LTE 2	QPSK20M	Left Side	0	19100	w/o	1	50	24.5	24.01	1.12	0.06	1.06	1.19
	LTE 2	QPSK20M	Left Side	0	19100	w/o	1	50	24.5	24.01	1.12	0.01	1.05	1.18
	LTE 2	QPSK20M	Left Side	0	18900	w/o	50	25	23.5	23.09	1.10	0.08	0.703	0.77
	LTE 2	QPSK20M	Left Side	0	18700	w/o	50	25	23.5	22.76	1.19	-0.14	0.868	1.03
	LTE 2	QPSK20M	Left Side	0	19100	w/o	50	25	23.5	23.02	1.12	-0.08	0.854	0.95
	LTE 2	QPSK20M	Left Side	0	18900	w/o	100	0	23.5	23.25	1.06	0.12	0.695	0.74
	LTE 2	QPSK20M	Top Side	0	18900	w/o	1	50	24.5	24.08	1.10	0	0.466	0.51
	LTE 2	QPSK20M	Top Side	0	18900	w/o	50	25	23.5	23.09	1.10	0.04	0.387	0.43
	LTE 4	QPSK20M	Rear Face	0	20300	w/	1	50	15.0	14.62	1.09	-0.04	0.764	0.83
	LTE 4	QPSK20M	Rear Face	0	20050	w/	1	50	15.0	14.41	1.15	0.09	0.801	0.92
	LTE 4	QPSK20M	Rear Face	0	20175	w/	1	50	15.0	14.27	1.18	0.05	0.962	1.14
	LTE 4	QPSK20M	Rear Face	0	20300	w/	50	25	14.0	13.75	1.06	0.17	0.632	0.67
	LTE 4	QPSK20M	Rear Face	0	20300	w/	100	0	14.0	13.50	1.12	-0.15	0.553	0.62
	LTE 4	QPSK20M	Rear Face	1.8	20300	w/o	1	50	24.5	24.08	1.10	-0.08	0.259	0.29
	LTE 4	QPSK20M	Rear Face	1.8	20300	w/o	50	25	23.5	23.25	1.06	0.09	0.247	0.26
02	LTE 4	QPSK20M	Left Side	0	20300	w/o	1	50	24.5	24.08	1.10	0.06	1.08	1.19
	LTE 4	QPSK20M	Left Side	0	20300	w/o	1	50	24.5	24.08	1.10	0.06	1.05	1.16
	LTE 4	QPSK20M	Left Side	0	20050	w/o	1	50	24.5	23.66	1.21	0.09	0.969	1.18
	LTE 4	QPSK20M	Left Side	0	20175	w/o	1	50	24.5	23.78	1.18	0.01	0.954	1.13
	LTE 4	QPSK20M	Left Side	0	20300	w/o	50	25	23.5	23.25	1.06	0.04	0.946	1.00
	LTE 4	QPSK20M	Left Side	0	20050	w/o	50	25	23.5	22.83	1.17	0.10	0.934	1.09
	LTE 4	QPSK20M	Left Side	0	20175	w/o	50	25	23.5	22.95	1.14	-0.07	0.851	0.97
	LTE 4	QPSK20M	Left Side	0	20300	w/o	100	0	23.5	23.21	1.07	0.01	0.847	0.91
	LTE 4	QPSK20M	Top Side	0	20300	w/o	1	50	24.5	24.08	1.10	-0.08	0.799	0.88
	LTE 4	QPSK20M	Top Side	0	20050	w/o	1	50	24.5	23.66	1.21	0.03	0.743	0.90
	LTE 4	QPSK20M	Top Side	0	20175	w/o	1	50	24.5	23.78	1.18	-0.12	0.720	0.85
	LTE 4	QPSK20M	Top Side	0	20300	w/o	50	25	23.5	23.25	1.06	-0.02	0.621	0.66
	LTE 4	QPSK20M	Top Side	0	20300	w/o	100	0	23.5	23.21	1.07	0.05	0.564	0.60
03	LTE 13	QPSK10M	Rear Face	0	23230	w/	1	24	18.0	17.66	1.08	0.03	0.532	0.58
	LTE 13	QPSK10M	Rear Face	0	23230	w/	25	0	17.0	16.44	1.14	0.12	0.431	0.49
	LTE 13	QPSK10M	Rear Face	1.8	23230	w/o	1	24	24.0	23.81	1.04	-0.03	0.383	0.40
	LTE 13	QPSK10M	Rear Face	1.8	23230	w/o	25	25	23.0	22.92	1.02	0.09	0.317	0.32
	LTE 13	QPSK10M	Left Side	0	23230	w/o	1	24	24.0	23.81	1.04	0	0.324	0.34
	LTE 13	QPSK10M	Left Side	0	23230	w/o	25	25	23.0	22.92	1.02	-0.07	0.258	0.26
	LTE 13	QPSK10M	Top Side	0	23230	w/o	1	24	24.0	23.81	1.04	-0.11	0.424	0.44
	LTE 13	QPSK10M	Top Side	0	23230	w/o	25	25	23.0	22.92	1.02	0.03	0.373	0.38



# FCC SAR Test Report

A D T

Plot No.	Band	Mode	Test Position	Separation Distance (cm)	Ch.	Max. Tune-up Power (dBm)	Measured Conducted Power (dBm)	Scaling Factor	Power Drift (dB)	Measured SAR-1g (W/kg)	Scaled SAR-1g (W/kg)
04	2.4G WLAN	802.11b	Rear Face	0	11	14.0	13.72	1.07	-0.18	0.873	0.93
	2.4G WLAN	802.11b	Rear Face	0	6	14.0	13.45	1.14	-0.10	1.04	1.18
	2.4G WLAN	802.11b	Rear Face	0	6	14.0	13.45	1.14	-0.09	1.02	1.16
	2.4G WLAN	802.11b	Left Side	0	11	14.0	13.72	1.07	0.16	0.304	0.32
	2.4G WLAN	802.11b	Left Side	0	6	14.0	13.45	1.14	0.11	0.348	0.39
2.4G WLAN	802.11b	Bottom Side	0	11	14.0	13.72	1.07	-0.05	0.126	0.13	
05	5.3G WLAN	802.11a	Rear Face	0	60	13.5	13.35	1.04	-0.15	1.04	1.08
	5.3G WLAN	802.11a	Rear Face	0	60	13.5	13.35	1.04	0.09	1.01	1.05
	5.3G WLAN	802.11a	Rear Face	0	64	13.5	13.18	1.08	0.02	0.994	1.07
	5.3G WLAN	802.11a	Left Side	0	60	13.5	13.35	1.04	0.13	0.439	0.45
	5.3G WLAN	802.11a	Left Side	0	64	13.5	13.18	1.08	0.09	0.356	0.38
5.3G WLAN	802.11a	Bottom Side	0	60	13.5	13.35	1.04	-0.13	0.034	0.04	
06	5.8G WLAN	802.11a	Rear Face	0	157	11.5	10.85	1.16	0.11	0.789	0.92
	5.8G WLAN	802.11a	Rear Face	0	165	11.5	11.06	1.11	-0.16	0.971	1.07
	5.8G WLAN	802.11a	Rear Face	0	165	11.5	11.06	1.11	0.05	0.958	1.06
	5.8G WLAN	802.11a	Left Side	0	157	11.5	10.85	1.16	0.02	0.528	0.61
	5.8G WLAN	802.11a	Left Side	0	165	11.5	11.06	1.11	0.16	0.559	0.62
5.8G WLAN	802.11a	Bottom Side	0	157	11.5	10.85	1.16	0.11	0.062	0.07	

# FCC SAR Test Report

## 4.7.3 SAR Measurement Variability

According to KDB 865664 D01, SAR measurement variability was assessed for each frequency band, which is determined by the SAR probe calibration point and tissue-equivalent medium used for the device measurements. When both head and body tissue-equivalent media are required for SAR measurements in a frequency band, the variability measurement procedures should be applied to the tissue medium with the highest measured SAR, using the highest measured SAR configuration for that tissue-equivalent medium. Alternatively, if the highest measured SAR for both head and body tissue-equivalent media are  $\leq 1.45$  W/kg and the ratio of these highest SAR values, i.e., largest divided by smallest value, is  $\leq 1.10$ , the highest SAR configuration for either head or body tissue-equivalent medium may be used to perform the repeated measurement. These additional measurements are repeated after the completion of all measurements requiring the same head or body tissue-equivalent medium in a frequency band. The test device should be returned to ambient conditions (normal room temperature) with the battery fully charged before it is re-mounted on the device holder for the repeated measurement(s) to minimize any unexpected variations in the repeated results.

SAR repeated measurement procedure:

1. When the highest measured SAR is  $< 0.80$  W/kg, repeated measurement is not required.
2. When the highest measured SAR is  $\geq 0.80$  W/kg, repeat that measurement once.
3. If the ratio of largest to smallest SAR for the original and first repeated measurements is  $> 1.20$ , or when the original or repeated measurement is  $\geq 1.45$  W/kg, perform a second repeated measurement.
4. If the ratio of largest to smallest SAR for the original, first and second repeated measurements is  $> 1.20$ , and the original, first or second repeated measurement is  $\geq 1.5$  W/kg, perform a third repeated measurement.

Band	Mode	Test Position	Separation Distance (cm)	Ch.	Original Measured SAR-1g (W/kg)	1st Repeated SAR-1g (W/kg)	L/S Ratio	2nd Repeated SAR-1g (W/kg)	L/S Ratio	3rd Repeated SAR-1g (W/kg)	L/S Ratio
LTE 2	QPSK20M	Left Side	0	19100	1.06	1.05	1.01	N/A	N/A	N/A	N/A
LTE 4	QPSK20M	Left Side	0	20300	1.08	1.05	1.03	N/A	N/A	N/A	N/A
2.4G WLAN	802.11b	Rear Face	0	6	1.04	1.02	1.02	N/A	N/A	N/A	N/A
5.3G WLAN	802.11a	Rear Face	0	60	1.04	1.01	1.03	N/A	N/A	N/A	N/A
5.8G WLAN	802.11a	Rear Face	0	165	0.971	0.958	1.01	N/A	N/A	N/A	N/A

# FCC SAR Test Report

## 4.7.4 Simultaneous Multi-band Transmission Evaluation

### <Estimated SAR Calculation>

According to KDB 447498 D01, when standalone SAR test exclusion applies to an antenna that transmits simultaneously with other antennas, the standalone SAR was estimated according to following formula to result in substantially conservative SAR values of  $\leq 0.4$  W/kg to determine simultaneous transmission SAR test exclusion.

$$\text{Estimated SAR} = \frac{\text{Max. Tune up Power}_{(mW)}}{\text{Min. Test Separation Distance}_{(mm)}} \times \frac{\sqrt{f_{(GHz)}}}{7.5}$$

If the minimum test separation distance is  $< 5$  mm, a distance of 5 mm is used for estimated SAR calculation. When the test separation distance is  $> 50$  mm, the 0.4 W/kg is used for SAR-1g.

Mode / Band	Frequency (GHz)	Max. Tune-up Power (dBm)	Test Position	Separation Distance (mm)	Estimated SAR (W/kg)
LTE 2	1.908	24.5	Body	5	0.40
LTE 4	1.752	24.5	Body	5	0.40
LTE 13	0.714	24.0	Body	5	0.40
WLAN (DTS)	2.462	14.0	Body	5	0.40
WLAN (NII)	5.3	13.5	Body	5	0.40
WLAN (NII)	5.8	11.5	Body	5	0.40
BT (DSS)	2.48	9.5	Body	5	0.37

### Note:

1. The separation distance is determined from the outer housing of the EUT to the user.
2. When standalone SAR testing is not required, an estimated SAR can be applied to determine simultaneous transmission SAR test exclusion.

# FCC SAR Test Report

## <SAR Summation Analysis>

Simultaneous transmission SAR test exclusion is determined for each operating configuration and exposure condition according to the reported standalone SAR of each applicable simultaneous transmitting antenna. When the sum of SAR<sub>1g</sub> of all simultaneously transmitting antennas in an operating mode and exposure condition combination is within the SAR limit (SAR<sub>1g</sub> 1.6 W/kg), the simultaneous transmission SAR is not required. When the sum of SAR<sub>1g</sub> is greater than the SAR limit (SAR<sub>1g</sub> 1.6 W/kg), SAR test exclusion is determined by the SPLSR.

No.	Conditions (SAR1 + SAR2)	Exposure Condition	Test Position	Max. SAR1	Max. SAR2	SAR Summation	SPLSR Analysis
1	LTE 2 + WLAN (DTS)	Body	Rear Face	0.91	1.18	2.09	<b>Analyzed as below</b>
			Top Side	0.51	0.40	0.91	Σ SAR < 1.6, Not required
			Bottom Side	0.40	0.13	0.53	Σ SAR < 1.6, Not required
			Left Side	1.21	0.39	1.60	<b>Analyzed as below</b>
			Right Side	0.40	0.40	0.80	Σ SAR < 1.6, Not required
2	LTE 2 + WLAN (NII)	Body	Rear Face	0.91	1.08	1.99	<b>Analyzed as below</b>
			Top Side	0.51	0.40	0.91	Σ SAR < 1.6, Not required
			Bottom Side	0.40	0.07	0.47	Σ SAR < 1.6, Not required
			Left Side	1.21	0.62	1.83	<b>Analyzed as below</b>
			Right Side	0.40	0.40	0.80	Σ SAR < 1.6, Not required
3	LTE 2 + BT (DSS)	Body	Rear Face	0.91	0.37	1.28	Σ SAR < 1.6, Not required
			Top Side	0.51	0.37	0.88	Σ SAR < 1.6, Not required
			Bottom Side	0.40	0.37	0.77	Σ SAR < 1.6, Not required
			Left Side	1.21	0.37	1.58	Σ SAR < 1.6, Not required
			Right Side	0.40	0.37	0.77	Σ SAR < 1.6, Not required



# FCC SAR Test Report

A D T

No.	Conditions (SAR1 + SAR2)	Exposure Condition	Test Position	Max. SAR1	Max. SAR2	SAR Summation	SPLSR Analysis
4	LTE 4 + WLAN (DTS)	Body	Rear Face	1.14	1.18	2.32	<b>Analyzed as below</b>
			Top Side	0.90	0.40	1.30	$\Sigma$ SAR < 1.6, Not required
			Bottom Side	0.40	0.13	0.53	$\Sigma$ SAR < 1.6, Not required
			Left Side	1.19	0.39	1.58	$\Sigma$ SAR < 1.6, Not required
			Right Side	0.40	0.40	0.80	$\Sigma$ SAR < 1.6, Not required
5	LTE4 + WLAN (NII)	Body	Rear Face	1.14	1.08	2.22	<b>Analyzed as below</b>
			Top Side	0.90	0.40	1.30	$\Sigma$ SAR < 1.6, Not required
			Bottom Side	0.40	0.07	0.47	$\Sigma$ SAR < 1.6, Not required
			Left Side	1.19	0.62	1.81	<b>Analyzed as below</b>
			Right Side	0.40	0.40	0.80	$\Sigma$ SAR < 1.6, Not required
6	LTE4 + BT (DSS)	Body	Rear Face	1.14	0.37	1.51	$\Sigma$ SAR < 1.6, Not required
			Top Side	0.90	0.37	1.27	$\Sigma$ SAR < 1.6, Not required
			Bottom Side	0.40	0.37	0.77	$\Sigma$ SAR < 1.6, Not required
			Left Side	1.19	0.37	1.56	$\Sigma$ SAR < 1.6, Not required
			Right Side	0.40	0.37	0.77	$\Sigma$ SAR < 1.6, Not required

No.	Conditions (SAR1 + SAR2)	Exposure Condition	Test Position	Max. SAR1	Max. SAR2	SAR Summation	SPLSR Analysis
7	LTE 13 + WLAN (DTS)	Body	Rear Face	0.58	1.18	1.76	<b>Analyzed as below</b>
			Top Side	0.44	0.40	0.84	$\Sigma$ SAR < 1.6, Not required
			Bottom Side	0.40	0.13	0.53	$\Sigma$ SAR < 1.6, Not required
			Left Side	0.34	0.39	0.73	$\Sigma$ SAR < 1.6, Not required
			Right Side	0.40	0.40	0.80	$\Sigma$ SAR < 1.6, Not required
8	LTE13 + WLAN (NII)	Body	Rear Face	0.58	1.08	1.66	<b>Analyzed as below</b>
			Top Side	0.44	0.40	0.84	$\Sigma$ SAR < 1.6, Not required
			Bottom Side	0.40	0.07	0.47	$\Sigma$ SAR < 1.6, Not required
			Left Side	0.34	0.62	0.96	$\Sigma$ SAR < 1.6, Not required
			Right Side	0.40	0.40	0.80	$\Sigma$ SAR < 1.6, Not required
9	LTE13 + BT (DSS)	Body	Rear Face	0.58	0.37	0.95	$\Sigma$ SAR < 1.6, Not required
			Top Side	0.44	0.37	0.81	$\Sigma$ SAR < 1.6, Not required
			Bottom Side	0.40	0.37	0.77	$\Sigma$ SAR < 1.6, Not required
			Left Side	0.34	0.37	0.71	$\Sigma$ SAR < 1.6, Not required
			Right Side	0.40	0.37	0.77	$\Sigma$ SAR < 1.6, Not required



# FCC SAR Test Report

## <SAR to Peak Location Separation Ratio Analysis>

The simultaneous transmitting antennas in each operating mode and exposure condition combination are considered one pair at a time to determine the SPLSR. When SAR is measured for both antennas in the pair, the peak location separation distance is computed by the following formula.

$$\text{Peak Location Separation Distance} = \sqrt{(x_1 - x_2)^2 + (y_1 - y_2)^2 + (z_1 - z_2)^2}$$

Where  $(x_1, y_1, z_1)$  and  $(x_2, y_2, z_2)$  are the coordinates of the extrapolated peak SAR locations in the area or zoom scans.

When standalone test exclusion applies, SAR is estimated; the peak location is assumed to be at the feed-point or geometric center of the antenna. Due to curvatures on the SAM phantom, when SAR is estimated for one of the antennas in an antenna pair, the measured peak SAR location will be translated onto the test device to determine the peak location separation for the antenna pair.

The SPLSR is determined by the following formula.

$$\text{SPLSR} = \frac{(SAR_1 + SAR_2)^{1.5}}{R_i}$$

Where  $SAR_1$  and  $SAR_2$  are the highest reported or estimated SAR for each antenna in the pair, and  $R_i$  is the separation distance between the peak SAR locations for the antenna pair in mm.

When the SPLSR is  $\leq 0.04$ , the simultaneous transmission SAR is not required. Otherwise, the enlarged zoom scan and volume scan post-processing procedures will be performed.

Conditions	Exposure Condition	Test Position	SAR Value (W/kg)	Coordinates			Peak Location Separation Distance ( $R_i$ , mm)	SPLSR	Simultaneous Transmission SAR Test
				x	y	z			
LTE 2 Ch18700	Body	Rear Face	0.91	7.16	-9.36	0.28	134.1	0.023	SPLSR < 0.04, Not required
802.11b Ch6			1.18	-6.05	-11.68	0.29			

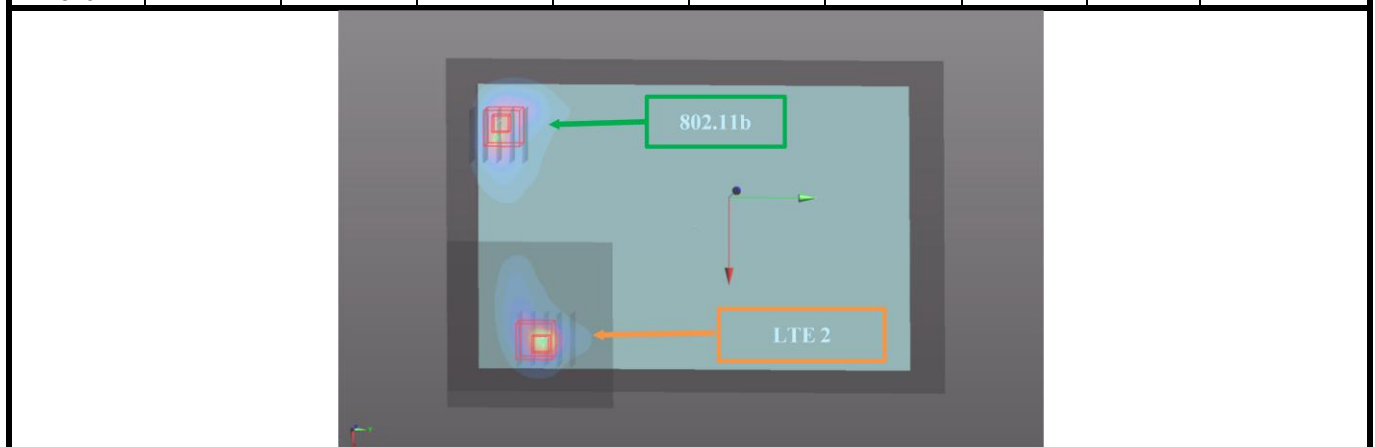

# FCC SAR Test Report

Conditions	Exposure Condition	Test Position	SAR Value (W/kg)	Coordinates			Peak Location Separation Distance (R <sub>i</sub> , mm)	SPLSR	Simultaneous Transmission SAR Test
				x	y	z			
LTE 2 Ch18700	Body	Rear Face	0.91	7.16	-9.36	0.28	131.3	0.021	SPLSR < 0.04, Not required
802.11a Ch60			1.08	-5.57	-11.75	0.27			

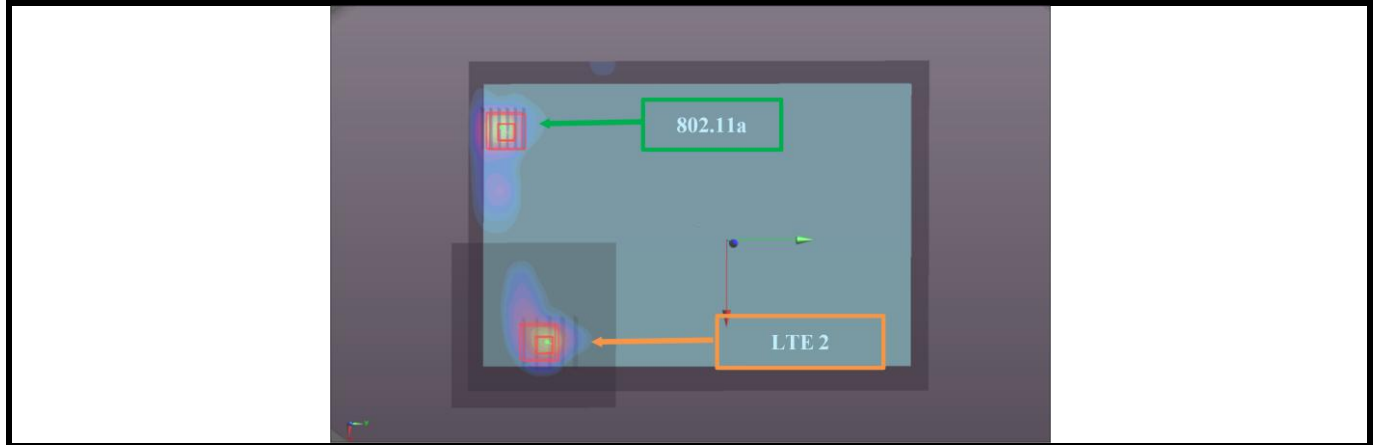

Conditions	Exposure Condition	Test Position	SAR Value (W/kg)	Coordinates			Peak Location Separation Distance (R <sub>i</sub> , mm)	SPLSR	Simultaneous Transmission SAR Test
				x	y	z			
LTE2 Ch18700	Body	Left Side	1.21	0	3.4	0.18	94.5	0.026	SPLSR < 0.04, Not required
802.11a Ch165			0.62	-0.05	-6.05	0.48			

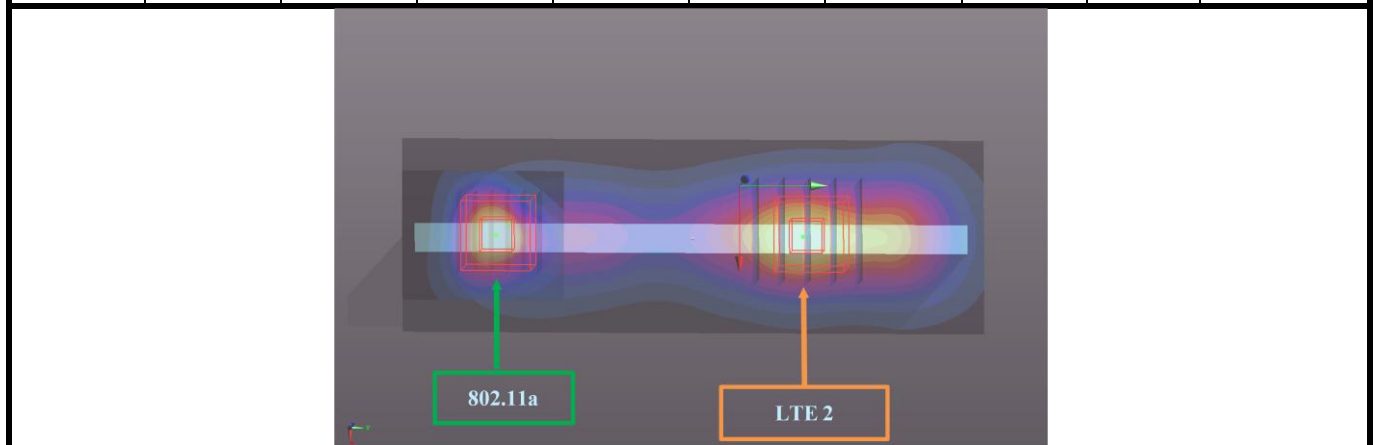

# FCC SAR Test Report

Conditions	Exposure Condition	Test Position	SAR Value (W/kg)	Coordinates			Peak Location Separation Distance (R <sub>i</sub> , mm)	SPLSR	Simultaneous Transmission SAR Test
				x	y	z			
LTE 4 Ch20175	Body	Rear Face	1.14	6.96	-9.36	0.28	132.2	0.027	SPLSR < 0.04, Not required
802.11b Ch6			1.18	-6.05	-11.68	0.29			

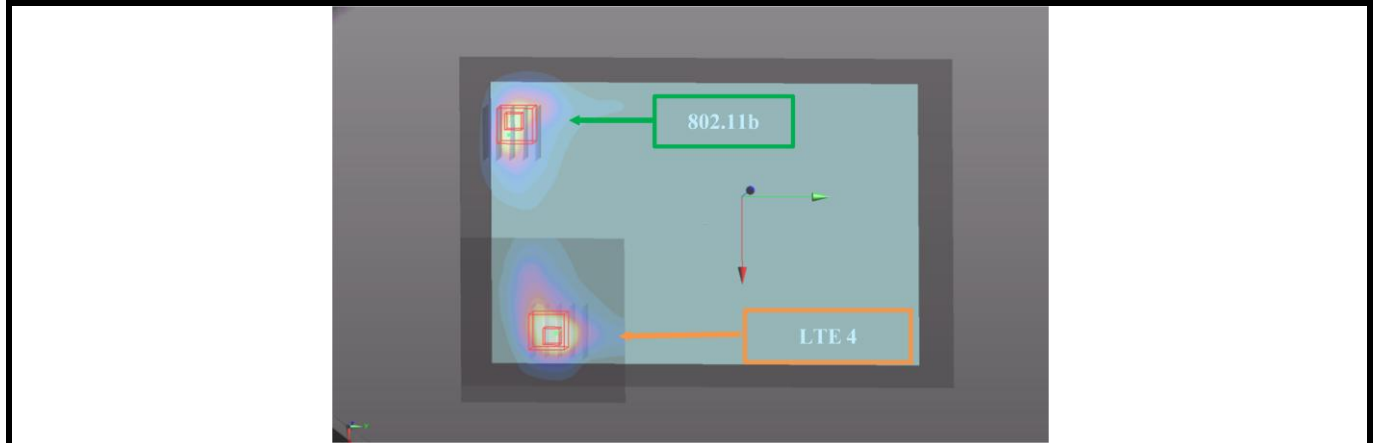

Conditions	Exposure Condition	Test Position	SAR Value (W/kg)	Coordinates			Peak Location Separation Distance (R <sub>i</sub> , mm)	SPLSR	Simultaneous Transmission SAR Test
				x	y	z			
LTE 4 Ch20175	Body	Rear Face	1.14	6.96	-9.36	0.28	129.3	0.026	SPLSR < 0.04, Not required
802.11a Ch60			1.08	-5.75	-11.75	0.27			

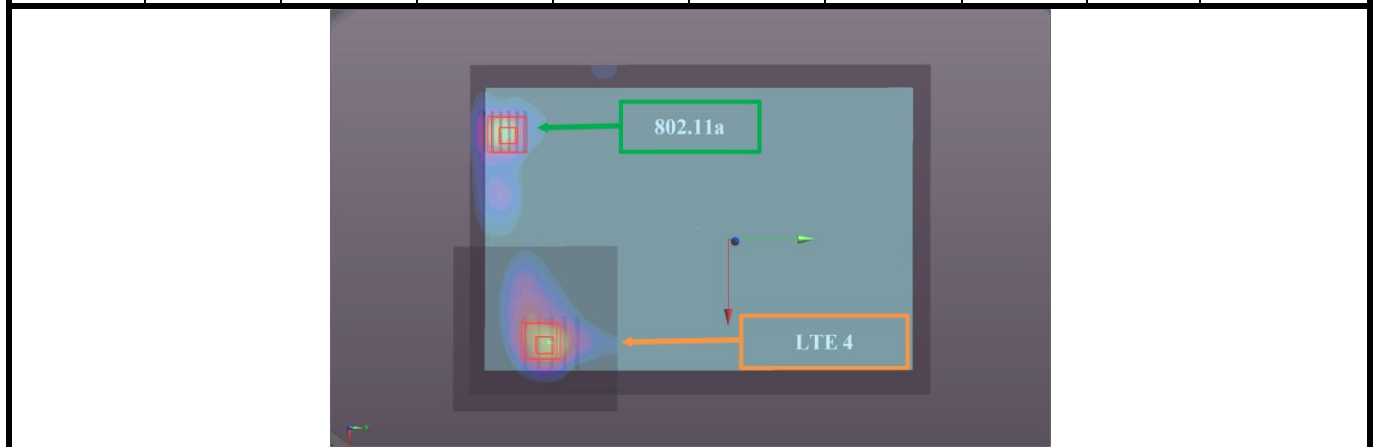

Conditions	Exposure Condition	Test Position	SAR Value (W/kg)	Coordinates			Peak Location Separation Distance (R <sub>i</sub> , mm)	SPLSR	Simultaneous Transmission SAR Test
				x	y	z			
LTE 4 Ch20300	Body	Left Side	1.19	0.04	3.32	0.19	93.7	0.026	SPLSR < 0.04, Not required
802.11a Ch165			0.62	-0.05	-6.05	0.48			

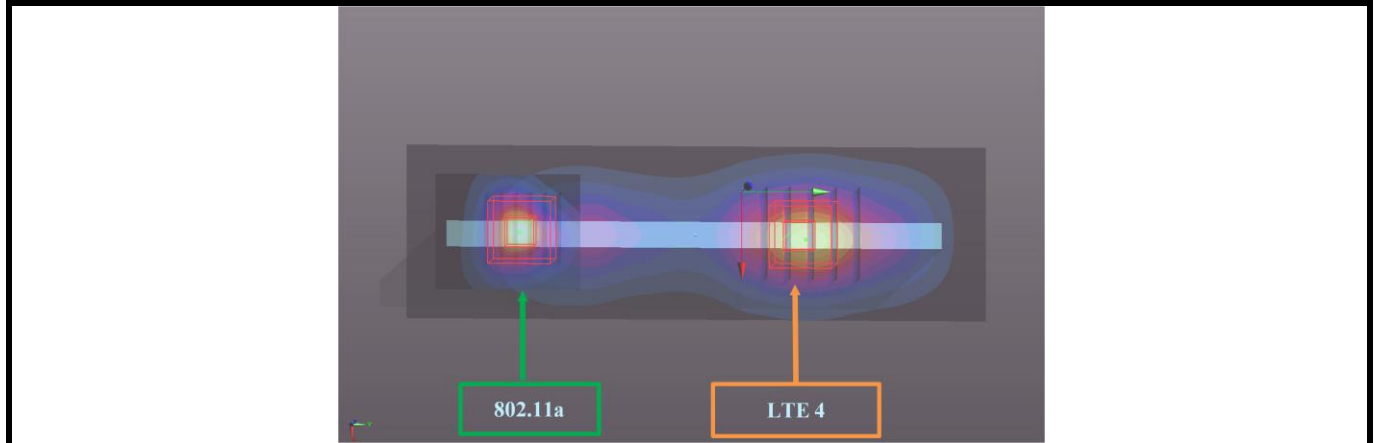

Conditions	Exposure Condition	Test Position	SAR Value (W/kg)	Coordinates			Peak Location Separation Distance (R <sub>i</sub> , mm)	SPLSR	Simultaneous Transmission SAR Test
				x	y	z			
LTE 13 Ch23230	Body	Rear Face	0.58	8	-7.2	0.26	147.5	0.016	SPLSR < 0.04, Not required
802.11b Ch6			1.18	-6.05	-11.68	0.29			

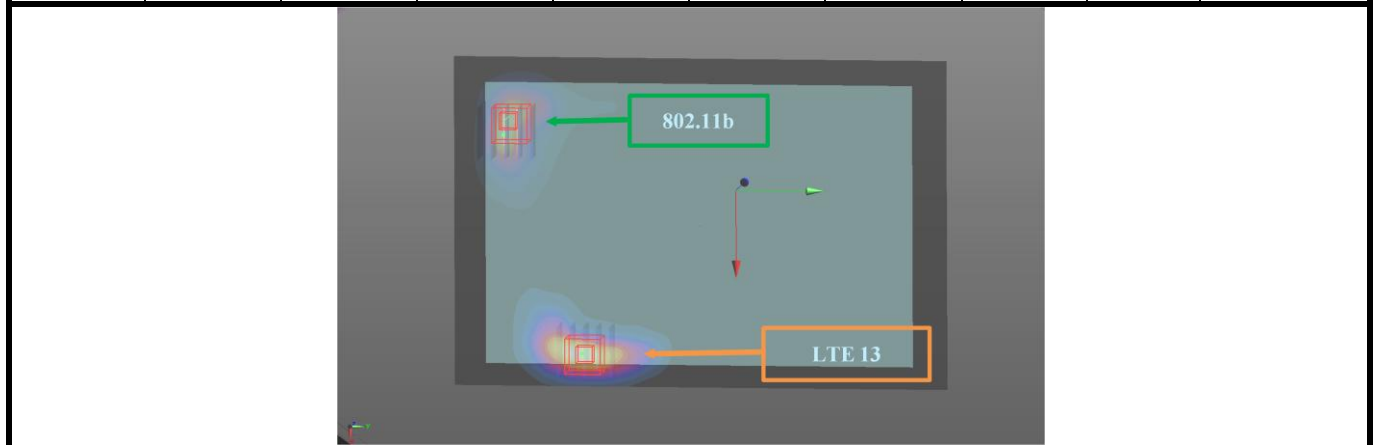

Conditions	Exposure Condition	Test Position	SAR Value (W/kg)	Coordinates			Peak Location Separation Distance (R <sub>i</sub> , mm)	SPLSR	Simultaneous Transmission SAR Test
				x	y	z			
LTE 13 Ch23230	Body	Rear Face	0.58	8	-7.2	0.26	144.8	0.015	SPLSR < 0.04, Not required
802.11a Ch60			1.08	-5.75	-11.75	0.27			



Test Engineer : Mars Chang, and Smith Chen



## 5. Calibration of Test Equipment

Equipment	Manufacturer	Model	SN	Cal. Date	Cal. Interval
System Validation Dipole	SPEAG	D750V3	1132	Jan. 06, 2015	2 Years
System Validation Dipole	SPEAG	D1750V2	1023	Jun. 23, 2015	2 Years
System Validation Dipole	SPEAG	D1900V2	5d036	Jan. 26, 2015	2 Years
System Validation Dipole	SPEAG	D2450V2	835	Mar. 30, 2015	2 Years
System Validation Dipole	SPEAG	D5GHzV2	1040	Jun. 22, 2015	2 Years
Dosimetric E-Field Probe	SPEAG	EX3DV4	3650	Jul. 23, 2015	1 Year
Data Acquisition Electronics	SPEAG	DAE4	1277	Jul. 22, 2015	1 Year
Radio Communication Analyzer	Anritsu	MT8820C	6201381727	May 07, 2015	1 Year
ENA Series Network Analyzer	Agilent	E5071C	MY46214281	Jun. 23, 2015	1 Year
EXA Spectrum Analyzer	Agilent	N9010A	MY53470455	Feb. 26, 2015	1 Year
MXG Analog Signal Generator	Agilent	N5181A	MY50143868	Jul. 06, 2015	1 Year
Power Meter	Anritsu	ML2495A	1218009	Jul. 06, 2015	1 Year
Power Sensor	Anritsu	MA2411B	1207252	Jul. 06, 2015	1 Year
Thermometer	YFE	YF-160A	110600361	Feb. 26, 2015	1 Year

# FCC SAR Test Report

## 6. Measurement Uncertainty

Source of Uncertainty	Tolerance (± %)	Probability Distribution	Divisor	Ci (1g)	Ci (10g)	Standard Uncertainty (± %, 1g)	Standard Uncertainty (± %, 10g)	Vi
<b>Measurement System</b>								
Probe Calibration	6.0	Normal	1	1	1	6.0	6.0	∞
Axial Isotropy	4.7	Rectangular	√3	0.707	0.707	1.9	1.9	∞
Hemispherical Isotropy	9.6	Rectangular	√3	0.707	0.707	3.9	3.9	∞
Boundary Effect	1.0	Rectangular	√3	1	1	0.6	0.6	∞
Linearity	4.7	Rectangular	√3	1	1	2.7	2.7	∞
System Detection Limits	0.25	Rectangular	√3	1	1	0.14	0.14	∞
Readout Electronics	0.3	Normal	1	1	1	0.3	0.3	∞
Response Time	0.0	Rectangular	√3	1	1	0.0	0.0	∞
Integration Time	1.7	Rectangular	√3	1	1	1.0	1.0	∞
RF Ambient Conditions - Noise	3.0	Rectangular	√3	1	1	1.7	1.7	∞
RF Ambient Conditions - Reflections	3.0	Rectangular	√3	1	1	1.7	1.7	∞
Probe Positioner Mechanical Tolerance	0.4	Rectangular	√3	1	1	0.2	0.2	∞
Probe Positioning with Respect to Phantom Shell	2.9	Rectangular	√3	1	1	1.7	1.7	∞
Extrapolation, interpolation, and integration algorithms for max. SAR evaluation	2.0	Rectangular	√3	1	1	1.2	1.2	∞
<b>Test Sample Related</b>								
Test Sample Positioning	1.5 / 0.7	Normal	1	1	1	1.5	0.7	32
Device Holder Uncertainty	4.2 / 1.8	Normal	1	1	1	4.2	1.8	32
Output Power Variation - SAR Drift Measurement	5.0	Rectangular	√3	1	1	2.9	2.9	∞
<b>Phantom and Tissue Parameters</b>								
Phantom Uncertainty (Shape and Thickness Tolerances)	7.2	Rectangular	√3	1	1	4.2	4.2	∞
Liquid Conductivity - Deviation from Target Values	5.0	Rectangular	√3	0.64	0.43	1.8	1.2	∞
Liquid Conductivity - Measurement Uncertainty	1.0	Normal	1	0.64	0.43	0.6	0.4	25
Liquid Permittivity - Deviation from Target Values	5.0	Rectangular	√3	0.60	0.49	1.7	1.4	∞
Liquid Permittivity - Measurement Uncertainty	0.5	Normal	1	0.60	0.49	0.3	0.2	25
<b>Combined Standard Uncertainty</b>						± 11.2 %	± 10.4 %	
<b>Expanded Uncertainty (K=2)</b>						± 22.4 %	± 20.8 %	

**Uncertainty budget for frequency range 300 MHz to 3 GHz**



# FCC SAR Test Report

A D T

Source of Uncertainty	Tolerance (± %)	Probability Distribution	Divisor	Ci (1g)	Ci (10g)	Standard Uncertainty (± %, 1g)	Standard Uncertainty (± %, 10g)	Vi
<b>Measurement System</b>								
Probe Calibration	6.55	Normal	1	1	1	6.55	6.55	∞
Axial Isotropy	4.7	Rectangular	√3	0.707	0.707	1.9	1.9	∞
Hemispherical Isotropy	9.6	Rectangular	√3	0.707	0.707	3.9	3.9	∞
Boundary Effect	2.0	Rectangular	√3	1	1	1.2	1.2	∞
Linearity	4.7	Rectangular	√3	1	1	2.7	2.7	∞
System Detection Limits	0.25	Rectangular	√3	1	1	0.14	0.14	∞
Readout Electronics	0.3	Normal	1	1	1	0.3	0.3	∞
Response Time	0.0	Rectangular	√3	1	1	0.0	0.0	∞
Integration Time	1.7	Rectangular	√3	1	1	1.0	1.0	∞
RF Ambient Conditions - Noise	3.0	Rectangular	√3	1	1	1.7	1.7	∞
RF Ambient Conditions - Reflections	3.0	Rectangular	√3	1	1	1.7	1.7	∞
Probe Positioner Mechanical Tolerance	0.4	Rectangular	√3	1	1	0.2	0.2	∞
Probe Positioning with Respect to Phantom Shell	6.7	Rectangular	√3	1	1	3.9	3.9	∞
Extrapolation, interpolation, and integration algorithms for max. SAR evaluation	4.0	Rectangular	√3	1	1	2.3	2.3	∞
<b>Test Sample Related</b>								
Test Sample Positioning	1.5 / 0.7	Normal	1	1	1	1.5	0.7	32
Device Holder Uncertainty	4.2 / 1.8	Normal	1	1	1	4.2	1.8	32
Output Power Variation - SAR Drift Measurement	5.0	Rectangular	√3	1	1	2.9	2.9	∞
<b>Phantom and Tissue Parameters</b>								
Phantom Uncertainty (Shape and Thickness Tolerances)	7.6	Rectangular	√3	1	1	4.4	4.4	∞
Liquid Conductivity - Deviation from Target Values	5.0	Rectangular	√3	0.64	0.43	1.8	1.2	∞
Liquid Conductivity - Measurement Uncertainty	1.0	Normal	1	0.64	0.43	0.6	0.4	25
Liquid Permittivity - Deviation from Target Values	5.0	Rectangular	√3	0.60	0.49	1.7	1.4	∞
Liquid Permittivity - Measurement Uncertainty	0.5	Normal	1	0.60	0.49	0.3	0.2	25
<b>Combined Standard Uncertainty</b>						± 12.3 %	± 11.5 %	
<b>Expanded Uncertainty (K=2)</b>						± 24.6 %	± 23.0 %	

Uncertainty budget for frequency range 3 GHz to 6 GHz





## FCC SAR Test Report

---

### 7. Information on the Testing Laboratories

We, Bureau Veritas Consumer Products Services (H.K.) Ltd., Taoyuan Branch, were founded in 1988 to provide our best service in EMC, Radio, Telecom and Safety consultation. Our laboratories are accredited and approved according to ISO/IEC 17025.

If you have any comments, please feel free to contact us at the following:

**Taiwan HwaYa EMC/RF/Safety/Telecom Lab:**

Add: No. 19, Hwa Ya 2nd Rd, Wen Hwa Vil., Kwei Shan Hsiang, Taoyuan Hsien 333, Taiwan, R.O.C.

Tel: 886-3-318-3232

Fax: 886-3-327-0892

**Taiwan LinKo EMC/RF Lab:**

Add: No. 47-2, 14th Ling, Chia Pau Vil., Linkou Dist., New Taipei City 244, Taiwan, R.O.C.

Tel: 886-2-2605-2180

Fax: 886-2-2605-1924

**Taiwan HsinChu EMC/RF Lab:**

Add: No. 81-1, Lu Liao Keng, 9<sup>th</sup> Ling, Wu Lung Vil., Chiung Lin Township, Hsinchu County 307, Taiwan, R.O.C.

Tel: 886-3-593-5343

Fax: 886-3-593-5342

**Email:** [service.adt@tw.bureauveritas.com](mailto:service.adt@tw.bureauveritas.com)

**Web Site:** [www.adt.com.tw](http://www.adt.com.tw)

The road map of all our labs can be found in our web site also.

---END---



## **Appendix A. SAR Plots of System Verification**

The plots for system verification with largest deviation for each SAR system combination are shown as follows.

### System Check\_B750\_150819

**DUT: Dipole 750 MHz; Type: D750V3; SN: 1132**

Communication System: CW; Frequency: 750 MHz; Duty Cycle: 1:1

Medium: B06T09N1\_0819 Medium parameters used:  $f = 750 \text{ MHz}$ ;  $\sigma = 0.96 \text{ S/m}$ ;  $\epsilon_r = 54.365$ ;  $\rho = 1000 \text{ kg/m}^3$

Ambient Temperature :  $23.7 \text{ }^\circ\text{C}$ ; Liquid Temperature :  $22.8 \text{ }^\circ\text{C}$

DASY5 Configuration:

- Probe: EX3DV4 - SN3650; ConvF(9.44, 9.44, 9.44); Calibrated: 2015/07/23;
- Sensor-Surface: 1.4mm (Mechanical Surface Detection)
- Electronics: DAE4 Sn1277; Calibrated: 2015/07/22
- Phantom: ELI Phantom\_1204; Type: QDOVA;
- Measurement SW: DASY52, Version 52.8 (8); SEMCAD X Version 14.6.10 (7331)

**Pin=250mW/Area Scan (61x81x1):** Interpolated grid:  $dx=1.500 \text{ mm}$ ,  $dy=1.500 \text{ mm}$   
Maximum value of SAR (interpolated) =  $2.57 \text{ W/kg}$

**Pin=250mW/Zoom Scan (5x5x7)/Cube 0:** Measurement grid:  $dx=8\text{mm}$ ,  $dy=8\text{mm}$ ,  $dz=5\text{mm}$   
Reference Value =  $53.12 \text{ V/m}$ ; Power Drift =  $0.01 \text{ dB}$   
Peak SAR (extrapolated) =  $2.92 \text{ W/kg}$   
**SAR(1 g) =  $2.07 \text{ W/kg}$ ; SAR(10 g) =  $1.4 \text{ W/kg}$**   
Maximum value of SAR (measured) =  $2.56 \text{ W/kg}$

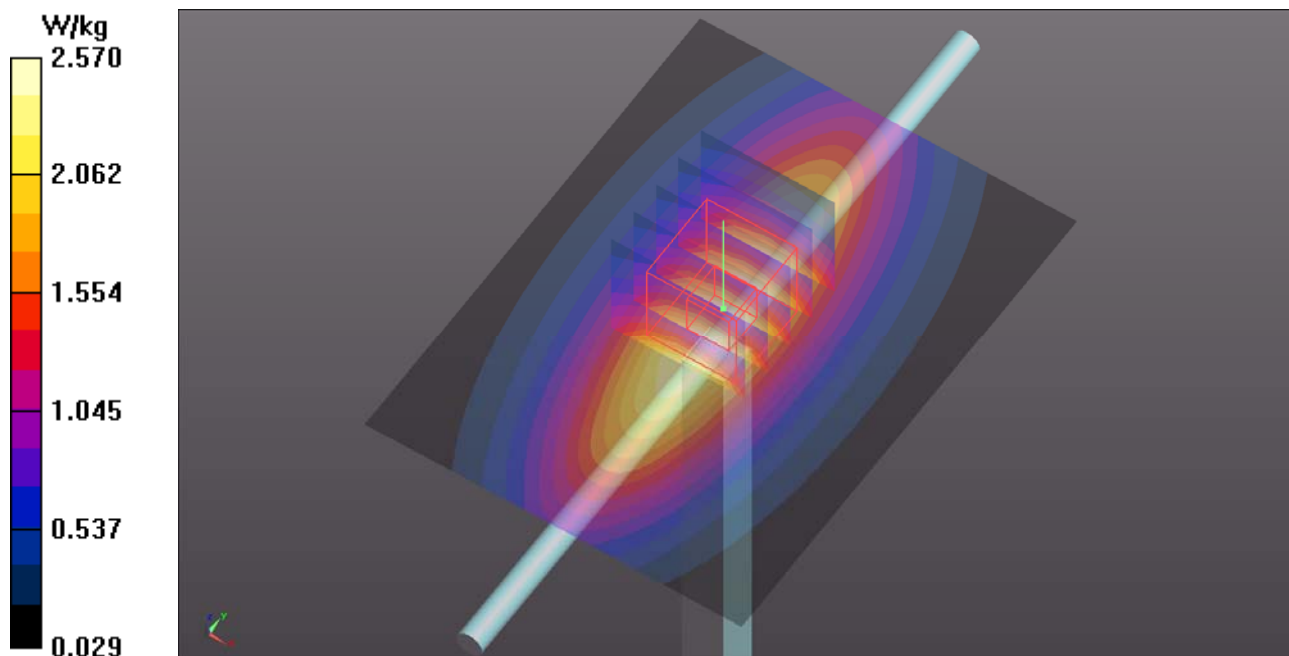

### System Check\_B1750\_150815

**DUT: Dipole 1750 MHz; Type: D1750V2; SN: 1045**

Communication System: CW; Frequency: 1750 MHz; Duty Cycle: 1:1

Medium: B16T20N1\_0815 Medium parameters used:  $f = 1750$  MHz;  $\sigma = 1.446$  S/m;  $\epsilon_r = 51.758$ ;  $\rho = 1000$  kg/m<sup>3</sup>

Ambient Temperature : 23.7 °C ; Liquid Temperature : 22.8 °C

DASY5 Configuration:

- Probe: EX3DV4 - SN3650; ConvF(7.8, 7.8, 7.8); Calibrated: 2015/07/23;
- Sensor-Surface: 1.4mm (Mechanical Surface Detection)
- Electronics: DAE4 Sn1277; Calibrated: 2015/07/22
- Phantom: ELI Phantom\_1204; Type: QDOVA;
- Measurement SW: DASY52, Version 52.8 (8); SEMCAD X Version 14.6.10 (7331)

**Pin=250mW/Area Scan (61x61x1):** Interpolated grid: dx=1.500 mm, dy=1.500 mm  
Maximum value of SAR (interpolated) = 13.4 W/kg

**Pin=250mW/Zoom Scan (5x5x7)/Cube 0:** Measurement grid: dx=8mm, dy=8mm, dz=5mm  
Reference Value = 95.05 V/m; Power Drift = 0.03 dB  
Peak SAR (extrapolated) = 15.9 W/kg  
**SAR(1 g) = 9.08 W/kg; SAR(10 g) = 4.89 W/kg**  
Maximum value of SAR (measured) = 12.6 W/kg

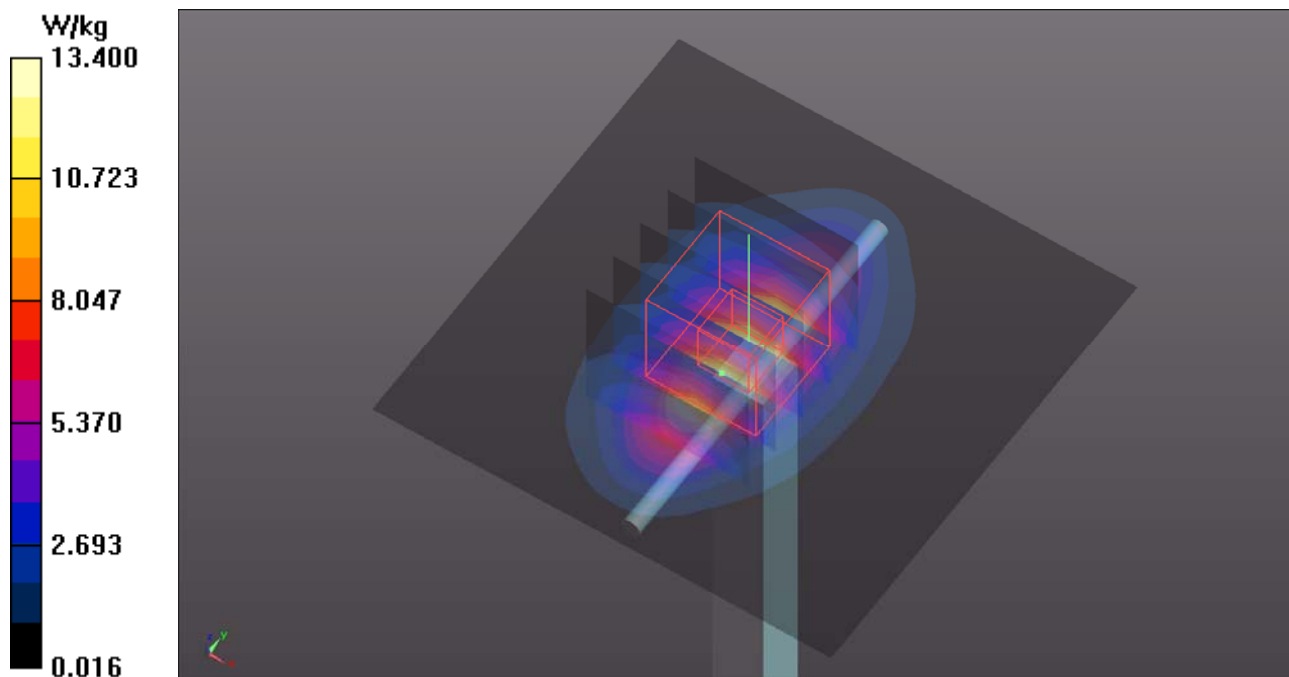

### System Check\_B1900\_150826

**DUT: Dipole 1900 MHz; Type: D1900V2; SN: 5d036**

Communication System: CW; Frequency: 1900 MHz; Duty Cycle: 1:1

Medium: B16T20N2\_0826 Medium parameters used:  $f = 1900$  MHz;  $\sigma = 1.579$  S/m;  $\epsilon_r = 51.714$ ;  $\rho = 1000$  kg/m<sup>3</sup>

Ambient Temperature : 23.5 °C ; Liquid Temperature : 23.0 °C

DASY5 Configuration:

- Probe: EX3DV4 - SN3650; ConvF(7.59, 7.59, 7.59); Calibrated: 2015/07/23;
- Sensor-Surface: 1.4mm (Mechanical Surface Detection)
- Electronics: DAE4 Sn1277; Calibrated: 2015/07/22
- Phantom: ELI Phantom\_1204; Type: QDOVA;
- Measurement SW: DASY52, Version 52.8 (8); SEMCAD X Version 14.6.10 (7331)

**Pin=250mW/Area Scan (61x61x1):** Interpolated grid: dx=1.500 mm, dy=1.500 mm  
Maximum value of SAR (interpolated) = 15.7 W/kg

**Pin=250mW/Zoom Scan (5x5x7)/Cube 0:** Measurement grid: dx=8mm, dy=8mm, dz=5mm  
Reference Value = 99.58 V/m; Power Drift = 0.01 dB  
Peak SAR (extrapolated) = 18.8 W/kg  
**SAR(1 g) = 10.5 W/kg; SAR(10 g) = 5.5 W/kg**  
Maximum value of SAR (measured) = 14.8 W/kg

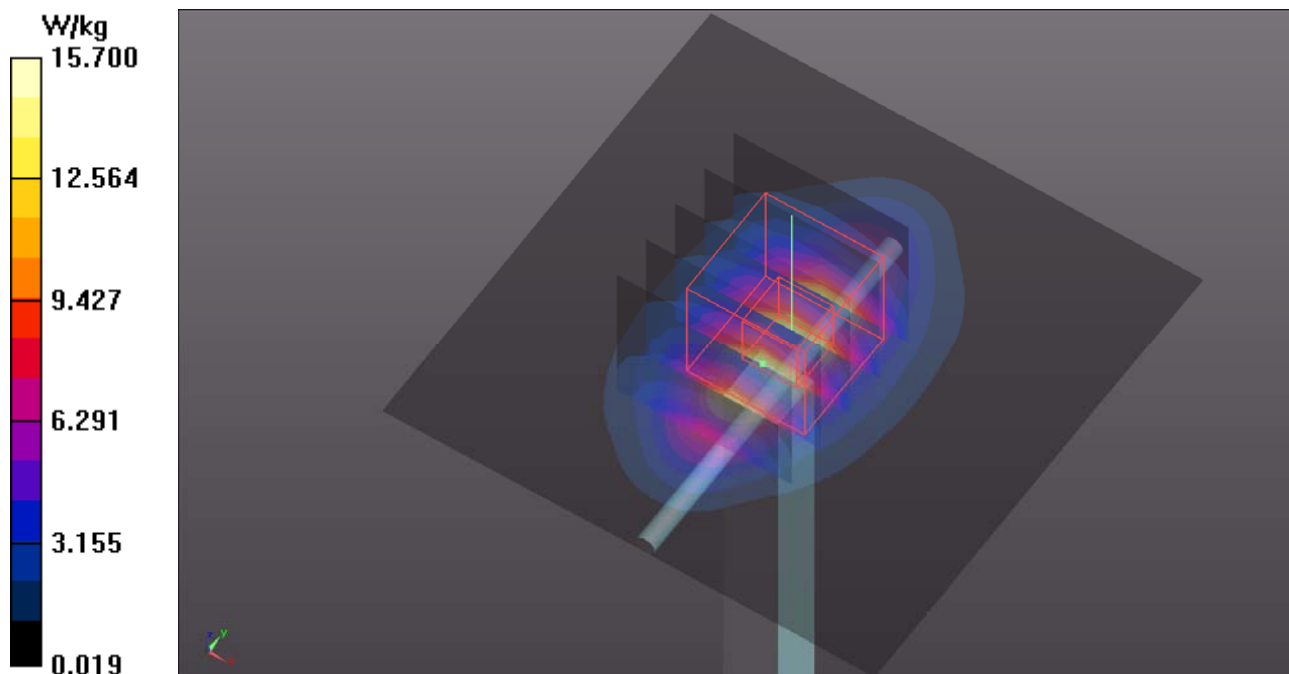

## System Check\_B2450\_150826

**DUT: Dipole 2450 MHz; Type: D2450V2; SN: 835**

Communication System: CW; Frequency: 2450 MHz; Duty Cycle: 1:1

Medium: B19T27N3\_0826 Medium parameters used:  $f = 2450$  MHz;  $\sigma = 2.017$  S/m;  $\epsilon_r = 51.060$ ;  $\rho = 1000$  kg/m<sup>3</sup>

Ambient Temperature : 23.8 °C ; Liquid Temperature : 23.1 °C

DASY5 Configuration:

- Probe: EX3DV4 - SN3650; ConvF(7.03, 7.03, 7.03); Calibrated: 2015/07/23;
- Sensor-Surface: 1.4mm (Mechanical Surface Detection)
- Electronics: DAE4 Sn1277; Calibrated: 2015/07/22
- Phantom: ELI Phantom\_1204; Type: QDOVA;
- Measurement SW: DASY52, Version 52.8 (8); SEMCAD X Version 14.6.10 (7331)

**Pin=250mW/Area Scan (81x81x1):** Interpolated grid: dx=1.200 mm, dy=1.200 mm  
Maximum value of SAR (interpolated) = 20.6 W/kg

**Pin=250mW/Zoom Scan (7x7x7)/Cube 0:** Measurement grid: dx=5mm, dy=5mm, dz=5mm  
Reference Value = 101.2 V/m; Power Drift = -0.12 dB  
Peak SAR (extrapolated) = 28.2 W/kg  
**SAR(1 g) = 13.3 W/kg; SAR(10 g) = 6.12 W/kg**  
Maximum value of SAR (measured) = 20.6 W/kg

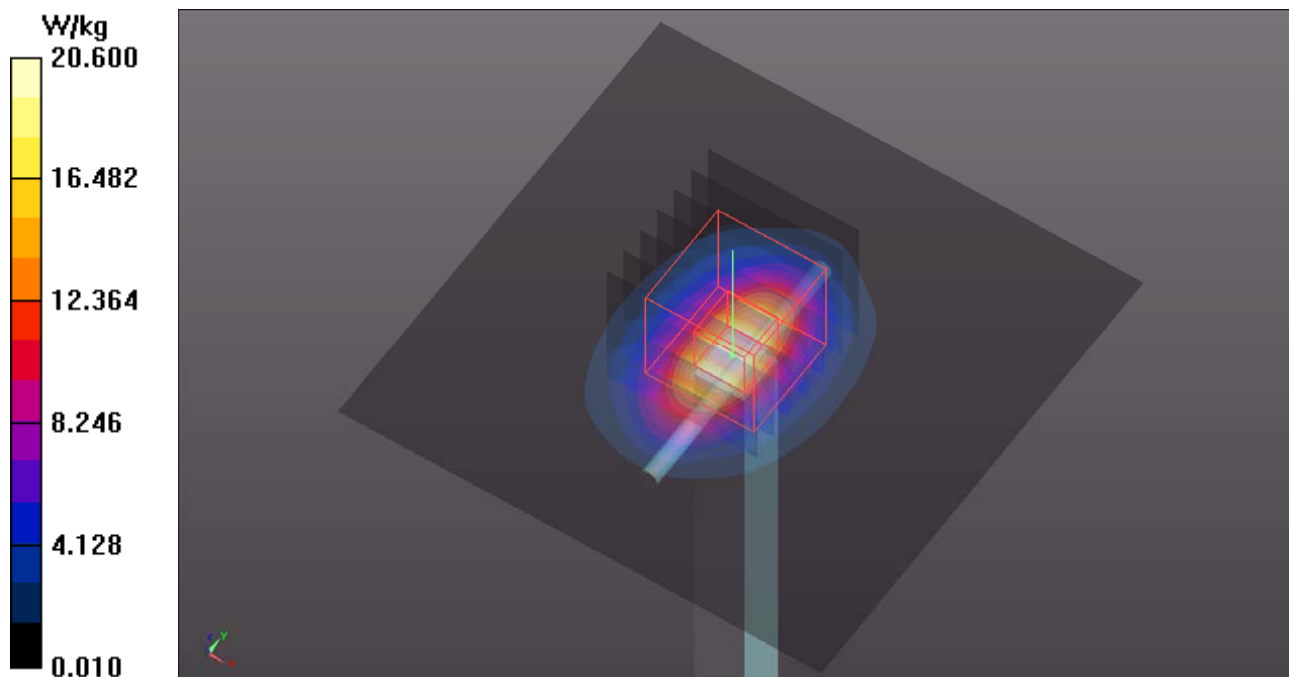

### System Check\_B5300\_150826

**DUT: Dipole 5 GHz; Type: D5GHzV2; SN: 1040**

Communication System: CW; Frequency: 5300 MHz; Duty Cycle: 1:1

Medium: B34T60N1\_0826 Medium parameters used:  $f = 5300$  MHz;  $\sigma = 5.316$  S/m;  $\epsilon_r = 50.949$ ;  $\rho = 1000$  kg/m<sup>3</sup>

Ambient Temperature : 23.7 °C ; Liquid Temperature : 23.3 °C

DASY5 Configuration:

- Probe: EX3DV4 - SN3650; ConvF(4.64, 4.64, 4.64); Calibrated: 2015/07/23;
- Sensor-Surface: 1.4mm (Mechanical Surface Detection)
- Electronics: DAE4 Sn1277; Calibrated: 2015/07/22
- Phantom: ELI Phantom\_1204; Type: QDOVA;
- Measurement SW: DASY52, Version 52.8 (8); SEMCAD X Version 14.6.10 (7331)

**Pin=100mW/Area Scan (91x91x1):** Interpolated grid: dx=1.000 mm, dy=1.000 mm  
Maximum value of SAR (interpolated) = 15.2 W/kg

**Pin=100mW/Zoom Scan (7x7x12)/Cube 0:** Measurement grid: dx=4mm, dy=4mm, dz=2mm  
Reference Value = 58.21 V/m; Power Drift = -0.02 dB  
Peak SAR (extrapolated) = 28.5 W/kg  
**SAR(1 g) = 7.19 W/kg; SAR(10 g) = 2.04 W/kg**  
Maximum value of SAR (measured) = 15.0 W/kg

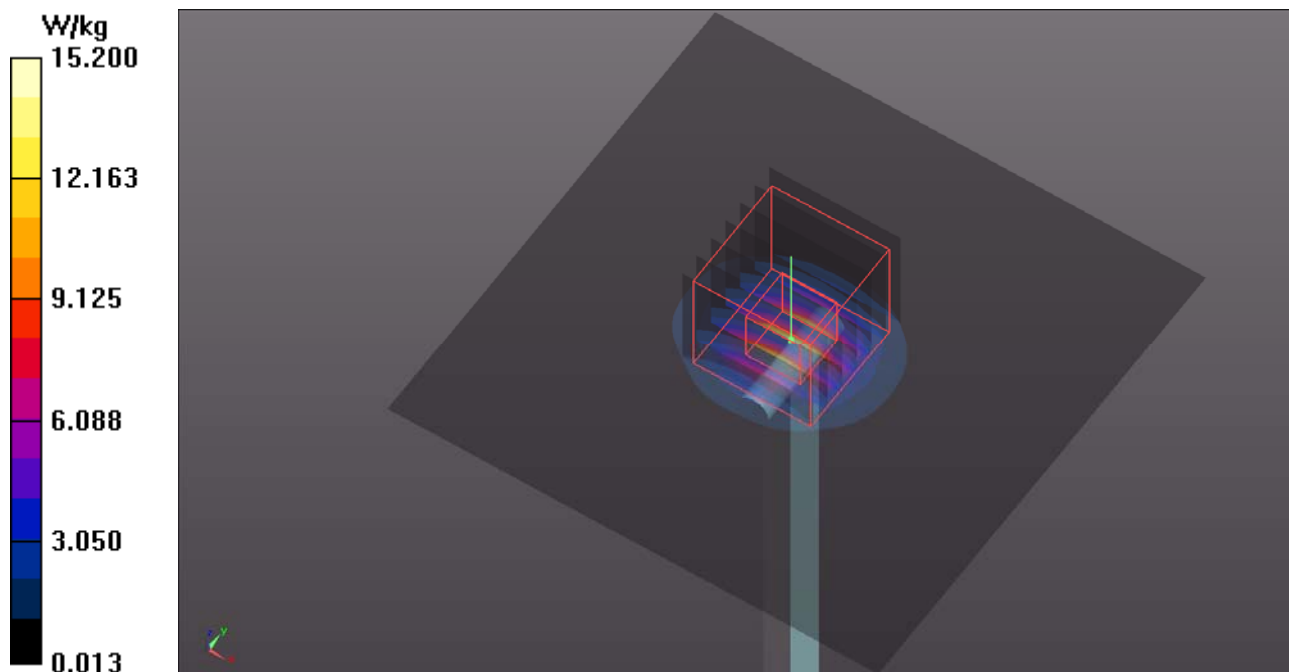

### System Check\_B5800\_150826

**DUT: Dipole 5 GHz; Type: D5GHzV2; SN: 1040**

Communication System: CW; Frequency: 5800 MHz; Duty Cycle: 1:1

Medium: B34T60N1\_0826 Medium parameters used:  $f = 5800$  MHz;  $\sigma = 6.124$  S/m;  $\epsilon_r = 49.901$ ;  $\rho = 1000$  kg/m<sup>3</sup>

Ambient Temperature : 23.9 °C ; Liquid Temperature : 23.1 °C

DASY5 Configuration:

- Probe: EX3DV4 - SN3650; ConvF(4.45, 4.45, 4.45); Calibrated: 2015/07/23;
- Sensor-Surface: 1.4mm (Mechanical Surface Detection)
- Electronics: DAE4 Sn1277; Calibrated: 2015/07/22
- Phantom: ELI Phantom\_1204; Type: QDOVA;
- Measurement SW: DASY52, Version 52.8 (8); SEMCAD X Version 14.6.10 (7331)

**Pin=100mW/Area Scan (91x91x1):** Interpolated grid: dx=1.000 mm, dy=1.000 mm  
Maximum value of SAR (interpolated) = 15.2 W/kg

**Pin=100mW/Zoom Scan (7x7x12)/Cube 0:** Measurement grid: dx=4mm, dy=4mm, dz=2mm  
Reference Value = 55.60 V/m; Power Drift = 0.06 dB  
Peak SAR (extrapolated) = 29.3 W/kg  
**SAR(1 g) = 7.16 W/kg; SAR(10 g) = 2.05 W/kg**  
Maximum value of SAR (measured) = 15.3 W/kg

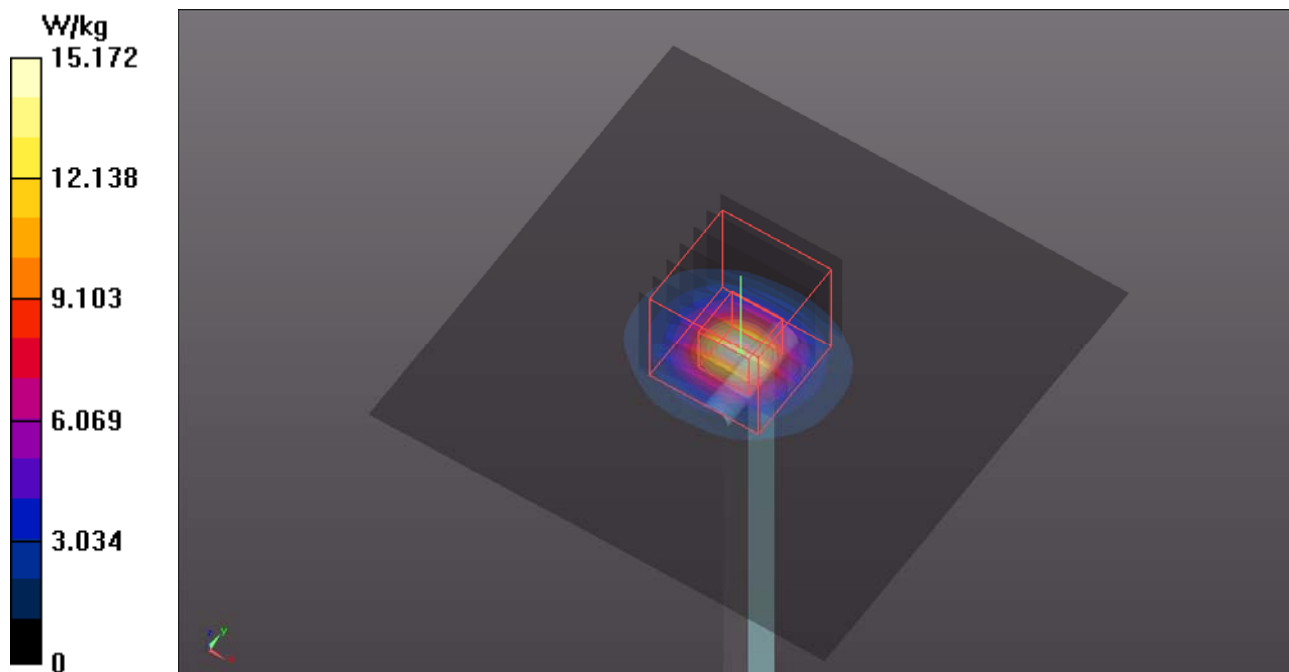





## **Appendix B. SAR Plots of SAR Measurement**

The SAR plots for highest measured SAR in each exposure configuration, wireless mode and frequency band combination, and measured SAR > 1.5 W/kg are shown as follows.

### P01 LTE 2\_QPSK20M\_Left Side\_0cm\_Ch18700\_P-Sensor\_OFF\_1RB\_OS50

**DUT: 150720C24**

Communication System: LTE; Frequency: 1860 MHz; Duty Cycle: 1:1

Medium: B16T20N1\_0815 Medium parameters used:  $f = 1860$  MHz;  $\sigma = 1.545$  S/m;  $\epsilon_r = 51.425$ ;  $\rho = 1000$  kg/m<sup>3</sup>

Ambient Temperature : 23.7 °C ; Liquid Temperature : 22.8 °C

DASY5 Configuration:

- Probe: EX3DV4 - SN3650; ConvF(7.59, 7.59, 7.59); Calibrated: 2015/07/23;
- Sensor-Surface: 1.4mm (Mechanical Surface Detection)
- Electronics: DAE4 Sn1277; Calibrated: 2015/07/22
- Phantom: ELI Phantom\_1204; Type: QDOVA;
- Measurement SW: DASY52, Version 52.8 (8); SEMCAD X Version 14.6.10 (7331)

- **Area Scan (61x151x1):** Interpolated grid: dx=1.500 mm, dy=1.500 mm

Maximum value of SAR (interpolated) = 1.68 W/kg

- **Zoom Scan (5x5x7)/Cube 0:** Measurement grid: dx=8mm, dy=8mm, dz=5mm

Reference Value = 17.76 V/m; Power Drift = 0.02 dB

Peak SAR (extrapolated) = 1.95 W/kg

**SAR(1 g) = 1.02 W/kg; SAR(10 g) = 0.541 W/kg**

Maximum value of SAR (measured) = 1.67 W/kg

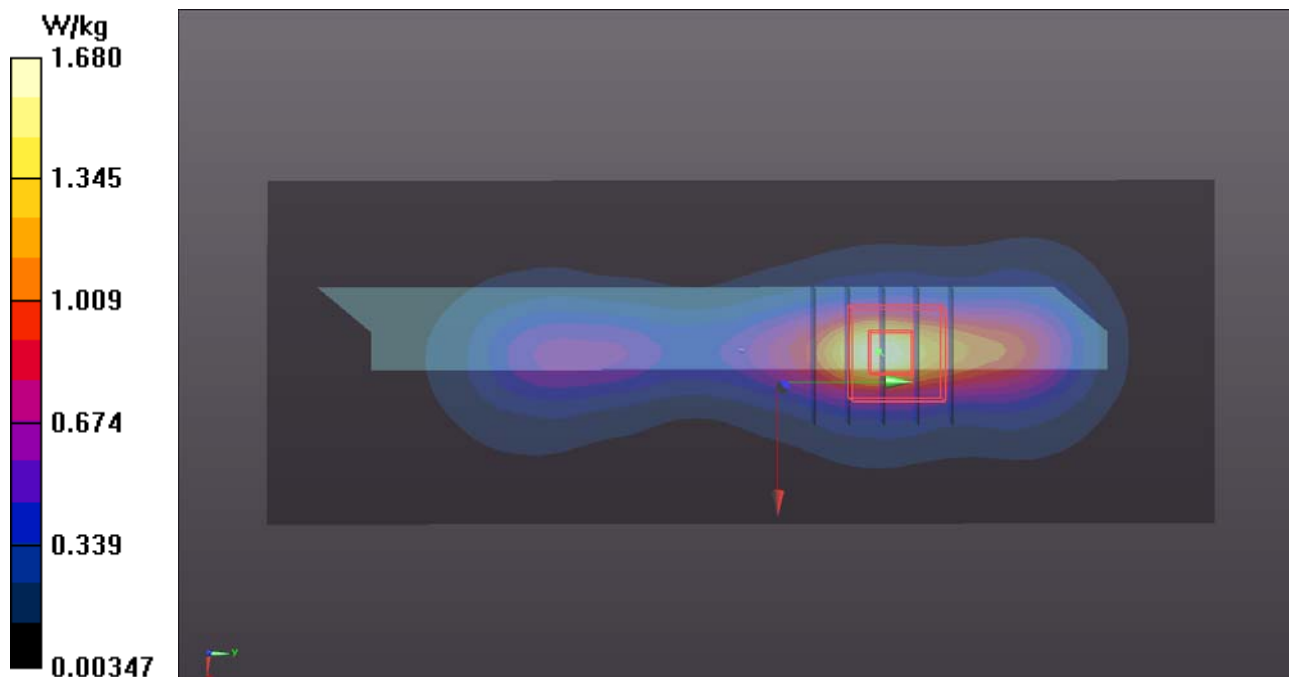

## P02 LTE 4\_QPSK20M\_Left Side\_0cm\_Ch20300\_P-Sensor\_OFF\_1RB\_OS50

**DUT: 150720C24**

Communication System: LTE; Frequency: 1745 MHz; Duty Cycle: 1:1

Medium: B16T20N1\_0815 Medium parameters used:  $f = 1745$  MHz;  $\sigma = 1.441$  S/m;  $\epsilon_r = 51.776$ ;  $\rho = 1000$  kg/m<sup>3</sup>

Ambient Temperature : 23.7 °C ; Liquid Temperature : 22.8 °C

DASY5 Configuration:

- Probe: EX3DV4 - SN3650; ConvF(7.8, 7.8, 7.8); Calibrated: 2015/07/23;
- Sensor-Surface: 1.4mm (Mechanical Surface Detection)
- Electronics: DAE4 Sn1277; Calibrated: 2015/07/22
- Phantom: ELI Phantom\_1204; Type: QDOVA;
- Measurement SW: DASY52, Version 52.8 (8); SEMCAD X Version 14.6.10 (7331)

- **Area Scan (41x141x1):** Interpolated grid: dx=1.500 mm, dy=1.500 mm

Maximum value of SAR (interpolated) = 1.24 W/kg

- **Zoom Scan (5x5x7)/Cube 0:** Measurement grid: dx=8mm, dy=8mm, dz=5mm

Reference Value = 16.68 V/m; Power Drift = 0.06 dB

Peak SAR (extrapolated) = 1.89 W/kg

**SAR(1 g) = 1.08 W/kg; SAR(10 g) = 0.598 W/kg**

Maximum value of SAR (measured) = 1.59 W/kg

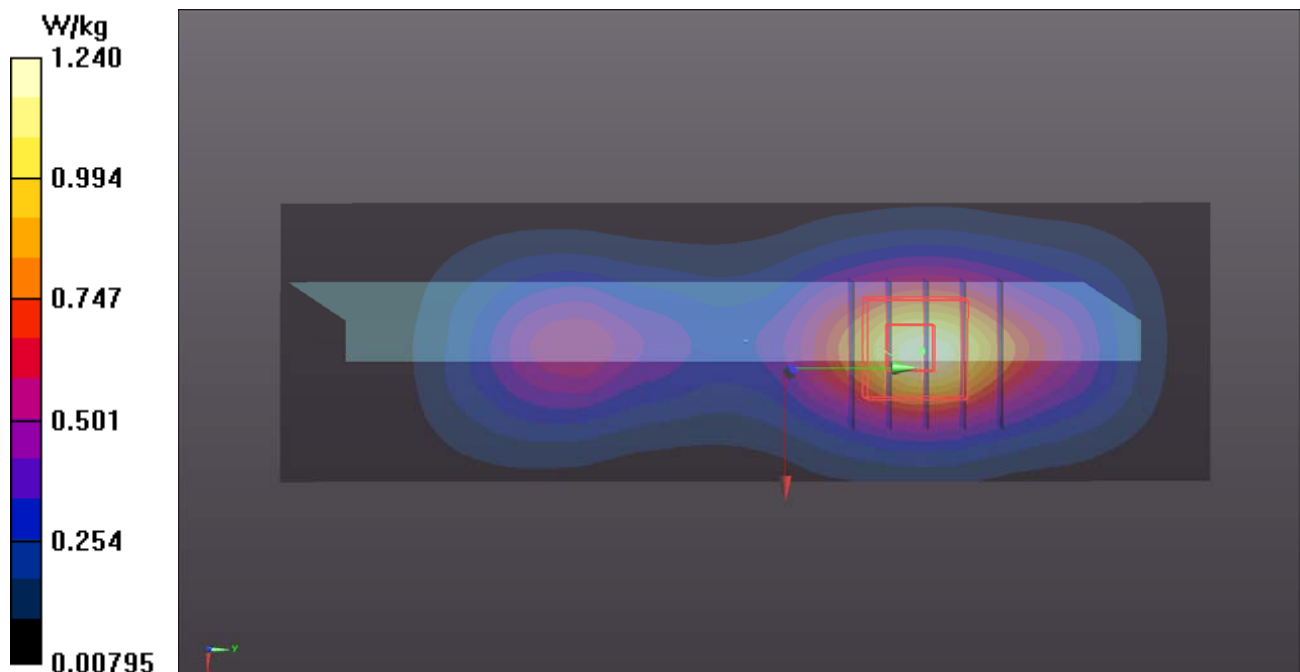

### P03 LTE 13\_QPSK10M\_Rear Face\_0cm\_Ch23230\_P-Sensor ON\_1RB\_OS24

**DUT: 150720C24**

Communication System: LTE; Frequency: 782 MHz; Duty Cycle: 1:1

Medium: B07T10N3\_0826 Medium parameters used:  $f = 782 \text{ MHz}$ ;  $\sigma = 0.961 \text{ S/m}$ ;  $\epsilon_r = 55.141$ ;  $\rho = 1000 \text{ kg/m}^3$

Ambient Temperature : 23.5 °C ; Liquid Temperature : 23.0 °C

DASY5 Configuration:

- Probe: EX3DV4 - SN3650; ConvF(9.44, 9.44, 9.44); Calibrated: 2015/07/23;
- Sensor-Surface: 1.4mm (Mechanical Surface Detection)
- Electronics: DAE4 Sn1277; Calibrated: 2015/07/22
- Phantom: ELI Phantom\_1204; Type: QDOVA;
- Measurement SW: DASY52, Version 52.8 (8); SEMCAD X Version 14.6.10 (7331)

- **Area Scan (141x201x1):** Interpolated grid:  $dx=1.500 \text{ mm}$ ,  $dy=1.500 \text{ mm}$

Maximum value of SAR (interpolated) = 0.942 W/kg

- **Zoom Scan (5x5x7)/Cube 0:** Measurement grid:  $dx=8\text{mm}$ ,  $dy=8\text{mm}$ ,  $dz=5\text{mm}$

Reference Value = 1.144 V/m; Power Drift = 0.03 dB

Peak SAR (extrapolated) = 1.15 W/kg

**SAR(1 g) = 0.532 W/kg; SAR(10 g) = 0.273 W/kg**

Maximum value of SAR (measured) = 0.932 W/kg

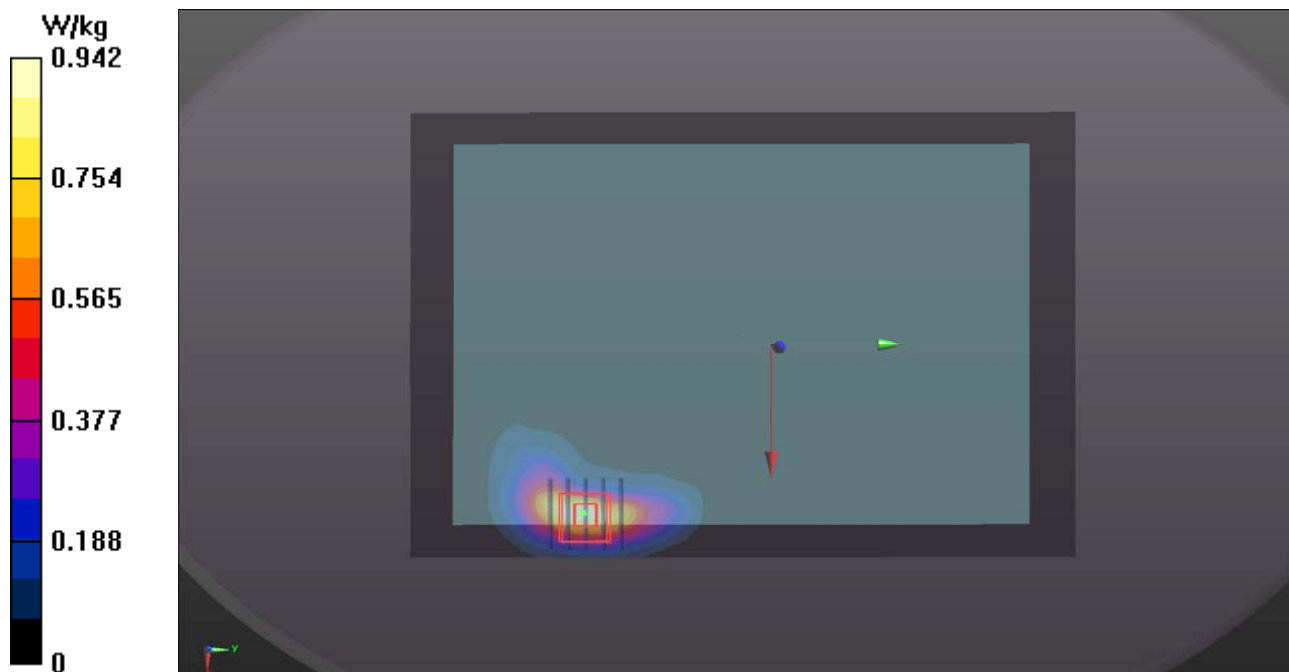

### P04 2.4G WLAN\_802.11b\_Rear Face\_0cm\_Ch6

**DUT: 150720C24**

Communication System: WLAN\_2.4G; Frequency: 2437 MHz; Duty Cycle: 1:1

Medium: B19T27N3\_0825 Medium parameters used:  $f = 2437$  MHz;  $\sigma = 2.004$  S/m;  $\epsilon_r = 51.109$ ;  $\rho =$

$1000$  kg/m<sup>3</sup>

Ambient Temperature : 23.9 °C ; Liquid Temperature : 23.1 °C

DASY5 Configuration:

- Probe: EX3DV4 - SN3650; ConvF(7.03, 7.03, 7.03); Calibrated: 2015/07/23;
- Sensor-Surface: 1.4mm (Mechanical Surface Detection)
- Electronics: DAE4 Sn1277; Calibrated: 2015/07/22
- Phantom: ELI Phantom\_1204; Type: QDOVA;
- Measurement SW: DASY52, Version 52.8 (8); SEMCAD X Version 14.6.10 (7331)

- **Area Scan (171x251x1):** Interpolated grid: dx=1.200 mm, dy=1.200 mm

Maximum value of SAR (interpolated) = 0.925 W/kg

- **Zoom Scan (5x5x7)/Cube 0:** Measurement grid: dx=8mm, dy=8mm, dz=5mm

Reference Value = 0.3860 V/m; Power Drift = -0.10 dB

Peak SAR (extrapolated) = 2.45 W/kg

**SAR(1 g) = 1.04 W/kg; SAR(10 g) = 0.447 W/kg**

Maximum value of SAR (measured) = 1.70 W/kg

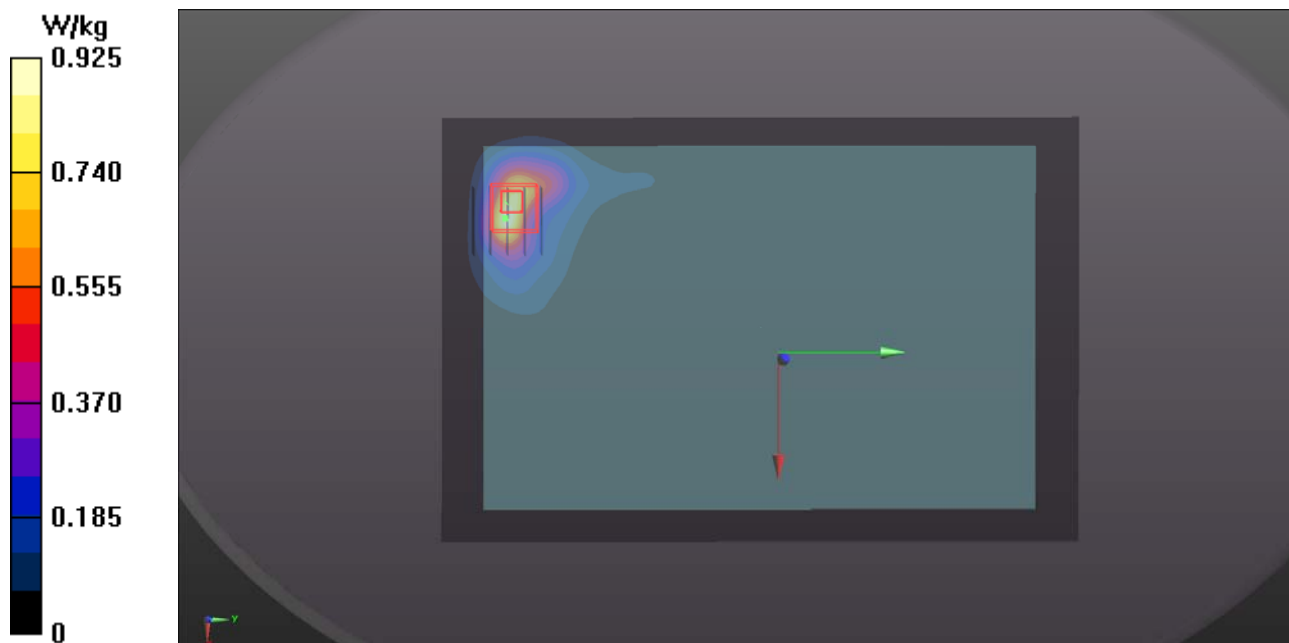

### P05 5.3G WLAN\_802.11a\_Rear Face\_0cm\_Ch60

**DUT: 150720C24**

Communication System: WLAN\_5G; Frequency: 5300 MHz; Duty Cycle: 1:1

Medium: B34T60N1\_0814 Medium parameters used:  $f = 5300$  MHz;  $\sigma = 5.342$  S/m;  $\epsilon_r = 50.805$ ;  $\rho = 1000$  kg/m<sup>3</sup>

Ambient Temperature : 23.8 °C ; Liquid Temperature : 22.9 °C

DASY5 Configuration:

- Probe: EX3DV4 - SN3650; ConvF(4.64, 4.64, 4.64); Calibrated: 2015/07/23;
- Sensor-Surface: 1.4mm (Mechanical Surface Detection)
- Electronics: DAE4 Sn1277; Calibrated: 2015/07/22
- Phantom: ELI Phantom\_1204; Type: QDOVA;
- Measurement SW: DASY52, Version 52.8 (8); SEMCAD X Version 14.6.10 (7331)

- **Area Scan (201x281x1):** Interpolated grid: dx=1.000 mm, dy=1.000 mm

Maximum value of SAR (interpolated) = 2.03 W/kg

- **Zoom Scan (6x6x12)/Cube 0:** Measurement grid: dx=5mm, dy=5mm, dz=2mm

Reference Value = 4.287 V/m; Power Drift = -0.15 dB

Peak SAR (extrapolated) = 4.95 W/kg

**SAR(1 g) = 1.04 W/kg; SAR(10 g) = 0.331 W/kg**

Maximum value of SAR (measured) = 2.72 W/kg

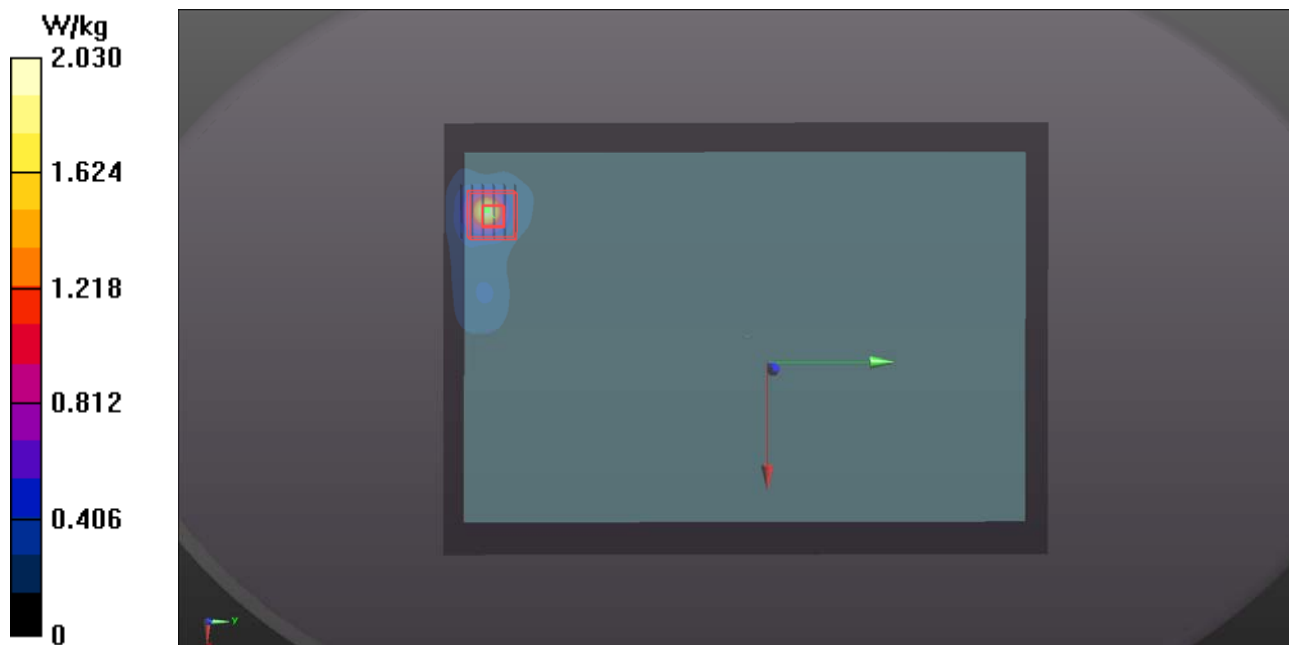

### P06 5.8G WLAN\_802.11a\_Rear Face\_0cm\_Ch165

**DUT: 150720C24**

Communication System: WLAN\_5G; Frequency: 5825 MHz; Duty Cycle: 1:1

Medium: B34T60N1\_0826 Medium parameters used:  $f = 5825$  MHz;  $\sigma = 6.166$  S/m;  $\epsilon_r = 49.863$ ;  $\rho = 1000$  kg/m<sup>3</sup>

Ambient Temperature : 23.9 °C ; Liquid Temperature : 23.1 °C

DASY5 Configuration:

- Probe: EX3DV4 - SN3650; ConvF(4.45, 4.45, 4.45); Calibrated: 2015/07/23;
- Sensor-Surface: 1.4mm (Mechanical Surface Detection)
- Electronics: DAE4 Sn1277; Calibrated: 2015/07/22
- Phantom: ELI Phantom\_1204; Type: QDOVA;
- Measurement SW: DASY52, Version 52.8 (8); SEMCAD X Version 14.6.10 (7331)

- **Area Scan (101x81x1):** Interpolated grid: dx=1.000 mm, dy=1.000 mm

Maximum value of SAR (interpolated) = 0.811 W/kg

- **Zoom Scan (6x6x12)/Cube 0:** Measurement grid: dx=5mm, dy=5mm, dz=2mm

Reference Value = 0.8760 V/m; Power Drift = -0.16 dB

Peak SAR (extrapolated) = 5.36 W/kg

**SAR(1 g) = 0.971 W/kg; SAR(10 g) = 0.187 W/kg**

Maximum value of SAR (measured) = 2.88 W/kg

