

FCC Test Report

Report No.: RF150720C24-2

FCC ID: HFS-QTAIR7

Test Model: QTAIR7

Received Date: Jul. 20, 2015

Test Date: Aug. 04, 2015 ~ Aug. 07, 2015

Issued Date: Sep. 01, 2015

Applicant: Quanta Computer Inc.

Address: No. 188, Wen Hwa 2nd RD., Kuei Shan Hsiang, Tao Yuan Shien, Taiwan

Issued By: Bureau Veritas Consumer Products Services (H.K.) Ltd., Taoyuan Branch

Lab Address: No. 47-2, 14th Ling, Chia Pau Vil., Lin Kou Dist., New Taipei City, Taiwan
(R.O.C)

Test Location: No. 19, Hwa Ya 2nd Rd, Wen Hwa Tsuen, Kwei Shan Hsiang, Taoyuan
Hsien 333, Taiwan, R.O.C.



This report is for your exclusive use. Any copying or replication of this report to or for any other person or entity, or use of our name or trademark, is permitted only with our prior written permission. This report sets forth our findings solely with respect to the test samples identified herein. The results set forth in this report are not indicative or representative of the quality or characteristics of the lot from which a test sample was taken or any similar or identical product unless specifically and expressly noted. Our report includes all of the tests requested by you and the results thereof based upon the information that you provided to us. You have 60 days from date of issuance of this report to notify us of any material error or omission caused by our negligence, provided, however, that such notice shall be in writing and shall specifically address the issue you wish to raise. A failure to raise such issue within the prescribed time shall constitute your unqualified acceptance of the completeness of this report, the tests conducted and the correctness of the report contents. Unless specifically mentioned, the uncertainty of measurement has been explicitly taken into account to declare the compliance or non-compliance to the specification.

Table of Contents

Release Control Record	4
1 Certificate of Conformity	5
2 Summary of Test Results	6
2.1 Measurement Uncertainty	6
2.2 Modification Record	6
3 General Information	7
3.1 General Description of EUT	7
3.2 Description of Test Modes	8
3.2.1 Test Mode Applicability and Tested Channel Detail	9
3.3 Duty Cycle of Test Signal	11
3.4 Description of Support Units	12
3.4.1 Configuration of System under Test	12
3.5 General Description of Applied Standards	12
4 Test Types and Results	13
4.1 Radiated Emission and Bandedge Measurement	13
4.1.1 Limits of Radiated Emission and Bandedge Measurement	13
4.1.2 Test Instruments	14
4.1.3 Test Procedures	15
4.1.4 Deviation from Test Standard	15
4.1.5 Test Set Up	16
4.1.6 EUT Operating Conditions	16
4.1.7 Test Results	17
4.2 Conducted Emission Measurement	30
4.2.1 Limits of Conducted Emission Measurement	30
4.2.2 Test Instruments	30
4.2.3 Test Procedures	31
4.2.4 Deviation from Test Standard	31
4.2.5 Test Setup	31
4.2.6 EUT Operating Conditions	31
4.2.7 Test Results	32
4.3 6dB Bandwidth Measurement	34
4.3.1 Limits of 6dB Bandwidth Measurement	34
4.3.2 Test Setup	34
4.3.3 Test Instruments	34
4.3.4 Test Procedure	34
4.3.5 Deviation from Test Standard	34
4.3.6 EUT Operating Conditions	34
4.3.7 Test Result	35
4.4 Conducted Output Power Measurement	37
4.4.1 Limits of Conducted Output Power Measurement	37
4.4.2 Test Setup	37
4.4.3 Test Instruments	37
4.4.4 Test Procedures	37
4.4.5 Deviation from Test Standard	37
4.4.6 EUT Operating Conditions	37
4.4.7 Test Results	38
4.5 Power Spectral Density Measurement	39
4.5.1 Limits of Power Spectral Density Measurement	39
4.5.2 Test Setup	39
4.5.3 Test Instruments	39
4.5.4 Test Procedure	39
4.5.5 Deviation from Test Standard	39
4.5.6 EUT Operating Condition	39



4.5.7 Test Results	40
4.6 Conducted Out of Band Emission Measurement	42
4.6.1 Limits of Conducted Out of Band Emission Measurement.....	42
4.6.2 Test Setup.....	42
4.6.3 Test Instruments	42
4.6.4 Test Procedure	42
4.6.5 Deviation from Test Standard	42
4.6.6 EUT Operating Condition	42
4.6.7 Test Results	43
5 Pictures of Test Arrangements.....	51
Appendix – Information on the Testing Laboratories	52



A D T

Release Control Record

Issue No.	Description	Date Issued
RF150720C24-2	Original Release	Sep. 01, 2015



1 Certificate of Conformity

Product: Tablet PC
Brand: Verizon
Test Model: QTAIR7
Sample Status: Identical Prototype
Applicant: Quanta Computer Inc.
Test Date: Aug. 04, 2015 ~ Aug. 07, 2015
Standards: 47 CFR FCC Part 15, Subpart C (Section 15.247)
ANSI C63.10:2013

The above equipment has been tested by **Bureau Veritas Consumer Products Services (H.K.) Ltd., Taoyuan Branch**, and found compliance with the requirement of the above standards. The test record, data evaluation & Equipment Under Test (EUT) configurations represented herein are true and accurate accounts of the measurements of the sample's EMC characteristics under the conditions specified in this report.

Prepared by : Ivonne Wu , **Date:** Sep. 01, 2015
Ivonne Wu / Supervisor

Approved by : Kay Wu , **Date:** Sep. 01, 2015
Kay Wu / Supervisor

2 Summary of Test Results

47 CFR FCC Part 15, Subpart C (SECTION 15.247)			
FCC Clause	Test Item	Result	Remarks
15.207	AC Power Conducted Emission	PASS	Meet the requirement of limit. Minimum passing margin is -12.62 dB at 0.15000 MHz.
15.205 / 15.209 / 15.247(d)	Radiated Emissions and Band Edge Measurement	PASS	Meet the requirement of limit. Minimum passing margin is -1.11 dB at 2484.00 MHz.
15.247(d)	Antenna Port Emission	PASS	Meet the requirement of limit.
15.247(a)(2)	6dB bandwidth	PASS	Meet the requirement of limit.
15.247(b)	Conducted power	PASS	Meet the requirement of limit.
15.247(e)	Power Spectral Density	PASS	Meet the requirement of limit.
15.203	Antenna Requirement	PASS	No antenna connector is used.

2.1 Measurement Uncertainty

Where relevant, the following measurement uncertainty levels have been estimated for tests performed on the EUT:

The listed uncertainties are the worst case uncertainty for the entire range of measurement. Please note that the uncertainty values are provided for informational purposes only and are not used in determining the PASS/FAIL results.

Measurement	Frequency	Expanded Uncertainty (k=2) (\pm)
Conducted Emissions at mains ports	150kHz ~ 30MHz	2.44 dB
Radiated Emissions up to 1 GHz	30MHz ~ 200MHz	2.93 dB
	200MHz ~ 1000MHz	2.95 dB
Radiated Emissions above 1 GHz	1GHz ~ 18GHz	2.26 dB
	18GHz ~ 40GHz	1.94 dB

2.2 Modification Record

There were no modifications required for compliance.

3 General Information

3.1 General Description of EUT

Product	Tablet PC
Brand	Verizon
Test Model	QTAIR7
Status of EUT	Identical Prototype
Power Supply Rating	5.0Vdc (adapter) 3.85Vdc (Li-ion battery)
Modulation Type	CCK, DQPSK, DBPSK for DSSS 64QAM, 16QAM, QPSK, BPSK for OFDM
Modulation Technology	DSSS, OFDM
Transfer Rate	802.11b: 11.0 / 5.5 / 2.0 / 1.0 Mbps 802.11g: 54.0 / 48.0 / 36.0 / 24.0 / 18.0 / 12.0 / 9.0 / 6.0 Mbps 802.11n: up to MCS7
Operating Frequency	2412 ~ 2462MHz
Number of Channel	11 for 802.11b, 802.11g, 802.11n (20MHz) 7 for 802.11n (40MHz)
Output Power	200.45mW
Antenna Type	PIFA antenna with 1.3 dBi gain
Accessory Device	Refer to Note as below
Data Cable Supplied	Refer to Note as below

Note:

1. The EUT contains following accessory devices.

Product	Brand	Model	Description
Battery	McNair	MLP3276120-2P	3.85Vdc, 9100mAh
LTE Module	Marvell	88RF858	--
WLAN Chip	Marvell	88W8887	--

2. The above EUT information is declared by manufacturer and for more detailed features description, please refer to the manufacturer's specifications or user's manual.

3.2 Description of Test Modes

11 channels are provided for 802.11b, 802.11g and 802.11n (20MHz):

Channel	Frequency (MHz)	Channel	Frequency (MHz)
1	2412	7	2442
2	2417	8	2447
3	2422	9	2452
4	2427	10	2457
5	2432	11	2462
6	2437		

7 channels are provided for 802.11n (40MHz):

Channel	Frequency	Channel	Frequency
3	2422	7	2442
4	2427	8	2447
5	2432	9	2452
6	2437		

3.2.1 Test Mode Applicability and Tested Channel Detail

EUT Configure Mode	Applicable To				Description
	RE \geq 1G	RE<1G	PLC	APCM	
-	√	√	√	√	-

Where **RE \geq 1G**: Radiated Emission above 1GHz **RE<1G**: Radiated Emission below 1GHz
PLC: Power Line Conducted Emission **APCM**: Antenna Port Conducted Measurement

NOTE: The EUT had been pre-tested on the positioned of each 3 axis. The worst case was found when positioned on **Y-plane**.
NOTE: “-” means no effect.

Radiated Emission Test (Above 1GHz):

- Pre-Scan has been conducted to determine the worst-case mode from all possible combinations between available modulations, data rates and antenna ports (if EUT with antenna diversity architecture).
- Following channel(s) was (were) selected for the final test as listed below.

EUT Configure Mode	Mode	Available Channel	Tested Channel	Modulation Technology	Modulation Type	Data Rate (Mbps)
-	802.11b	1 to 11	1, 6, 11	DSSS	DBPSK	1.0
-	802.11g	1 to 11	1, 6, 11	OFDM	BPSK	6.0
-	802.11n (20MHz)	1 to 11	1, 6, 11	OFDM	BPSK	7.2
-	802.11n (40MHz)	3 to 9	3, 6, 9	OFDM	BPSK	15.0

Radiated Emission Test (Below 1GHz):

- Pre-Scan has been conducted to determine the worst-case mode from all possible combinations between available modulations, data rates and antenna ports (if EUT with antenna diversity architecture).
- Following channel(s) was (were) selected for the final test as listed below.

EUT Configure Mode	Mode	Available Channel	Tested Channel	Modulation Technology	Modulation Type	Data Rate (Mbps)
-	802.11n (40MHz)	3 to 9	9	OFDM	BPSK	15.0

Power Line Conducted Emission Test:

- Pre-Scan has been conducted to determine the worst-case mode from all possible combinations between available modulations, data rates and antenna ports (if EUT with antenna diversity architecture).
- Following channel(s) was (were) selected for the final test as listed below.

EUT Configure Mode	Mode	Available Channel	Tested Channel	Modulation Technology	Modulation Type	Data Rate (Mbps)
-	802.11n (40MHz)	3 to 9	9	OFDM	BPSK	15.0

Bandedge Measurement:

- Pre-Scan has been conducted to determine the worst-case mode from all possible combinations between available modulations, data rates and antenna ports (if EUT with antenna diversity architecture).
- Following channel(s) was (were) selected for the final test as listed below.

EUT Configure Mode	Mode	Available Channel	Tested Channel	Modulation Technology	Modulation Type	Data Rate (Mbps)
-	802.11b	1 to 11	1, 11	DSSS	DBPSK	1.0
-	802.11g	1 to 11	1, 11	OFDM	BPSK	6.0
-	802.11n (20MHz)	1 to 11	1, 11	OFDM	BPSK	7.2
-	802.11n (40MHz)	3 to 9	3, 9	OFDM	BPSK	15.0

Antenna Port Conducted Measurement:

- This item includes all test value of each mode, but only includes spectrum plot of worst value of each mode.
- Pre-Scan has been conducted to determine the worst-case mode from all possible combinations between available modulations, data rates and antenna ports (if EUT with antenna diversity architecture).
- Following channel(s) was (were) selected for the final test as listed below.

EUT Configure Mode	Mode	Available Channel	Tested Channel	Modulation Technology	Modulation Type	Data Rate (Mbps)
-	802.11b	1 to 11	1, 6, 11	DSSS	DBPSK	1.0
-	802.11g	1 to 11	1, 6, 11	OFDM	BPSK	6.0
-	802.11n (20MHz)	1 to 11	1, 6, 11	OFDM	BPSK	7.2
-	802.11n (40MHz)	3 to 9	3, 6, 9	OFDM	BPSK	15.0

Test Condition:

Applicable To	Environmental Conditions	Input Power	Tested by
RE \geq 1G	25deg. C, 65%RH	120Vac, 60Hz	Gavin Wu
RE<1G	25deg. C, 65%RH	120Vac, 60Hz	Gavin Wu
PLC	25deg. C, 68%RH	120Vac, 60Hz	Toby Tian
APCM	25deg. C, 68%RH	3.85Vdc	Howard Kao

3.3 Duty Cycle of Test Signal

Duty cycle of test signal is > 98 %

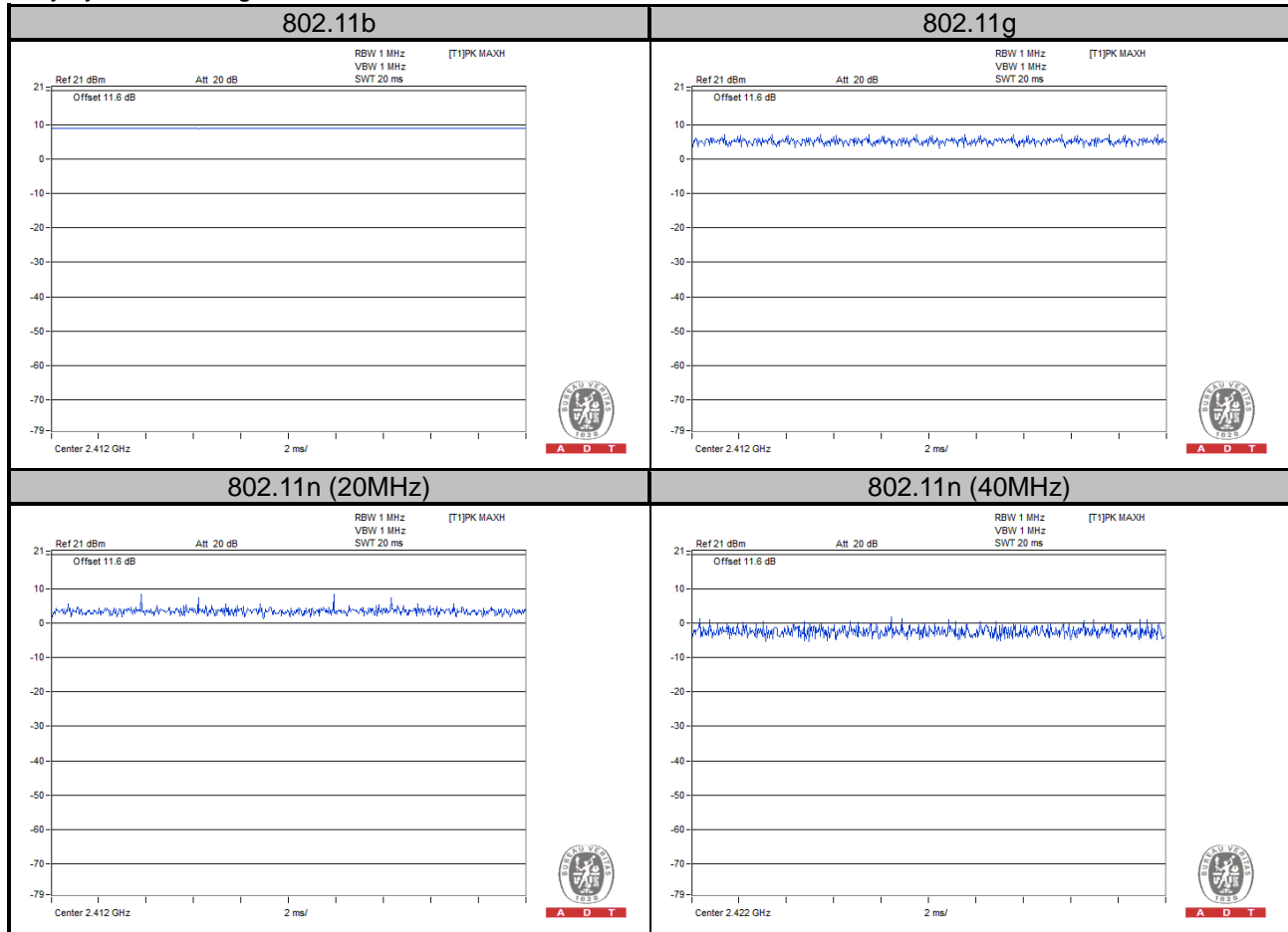

3.4 Description of Support Units

The EUT has been tested as an independent unit together with other necessary accessories or support units. The following support units or accessories were used to form a representative test configuration during the tests.

No.	Product	Brand	Model No.	Serial No.	FCC ID
A.	Earphone	Cotron	Max-301	N/A	N/A
B.	Adapter	N/A	N/A	N/A	N/A

Note:

1. All power cords of the above support units are non-shielded (1.8m).
2. Item A acted as communication partners to transfer data.

No.	Signal Cable Description Of The Above Support Units
1.	N/A
2.	N/A

Note:

1. All power cords of the above support units are non-shielded (1.8m).

3.4.1 Configuration of System under Test

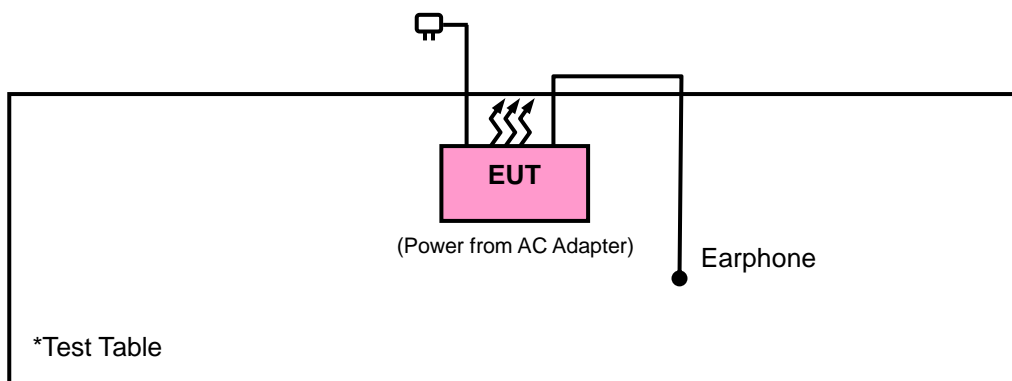

3.5 General Description of Applied Standards

The EUT is a RF Product. According to the specifications of the manufacturer, it must comply with the requirements of the following standards:

- FCC Part 15, Subpart C (15.247)**
- 558074 D01 DTS Meas Guidance v03r03**
- ANSI C63.10-2013

All test items have been performed and recorded as per the above standards.

NOTE: The EUT has been verified to comply with the requirements of FCC Part 15, Subpart B, Class B (DoC). The test report has been issued separately.

4 Test Types and Results

4.1 Radiated Emission and Bandedge Measurement

4.1.1 Limits of Radiated Emission and Bandedge Measurement

Radiated emissions which fall in the restricted bands must comply with the radiated emission limits specified as below table. Other emissions shall be at least 20dB below the highest level of the desired power:

Frequencies (MHz)	Field Strength (microvolts/meter)	Measurement Distance (meters)
0.009 ~ 0.490	2400/F(kHz)	300
0.490 ~ 1.705	24000/F(kHz)	30
1.705 ~ 30.0	30	30
30 ~ 88	100	3
88 ~ 216	150	3
216 ~ 960	200	3
Above 960	500	3

NOTE:

1. The lower limit shall apply at the transition frequencies.
2. Emission level (dBuV/m) = 20 log Emission level (uV/m).
3. For frequencies above 1000MHz, the field strength limits are based on average detector, however, the peak field strength of any emission shall not exceed the maximum permitted average limits, specified above by more than 20dB under any condition of modulation.

4.1.2 Test Instruments

Description & Manufacturer	Model No.	Serial No.	Date of Calibration	Due Date of Calibration
Test Receiver Agilent	N9038A	MY51210203	Jan. 21, 2015	Jan. 21, 2016
Spectrum Analyzer Agilent	N9010A	MY52220314	Sep. 03, 2014	Sep. 02, 2015
Spectrum Analyzer ROHDE & SCHWARZ	FSU43	101261	Dec. 10, 2014	Dec. 09, 2015
BILOG Antenna SCHWARZBECK	VULB9168	9168-472	Feb. 04, 2015	Feb. 04, 2016
HORN Antenna SCHWARZBECK	BBHA 9120 D	9120D-969	Feb. 09, 2015	Feb. 09, 2016
HORN Antenna SCHWARZBECK	BBHA 9170	9170-480	Feb. 04, 2015	Feb. 04, 2016
Loop Antenna	EM-6879	269	Aug. 13, 2014	Aug. 12, 2015
Preamplifier EMCI	EMC 012645	980115	Dec. 12, 2014	Dec. 11, 2015
Preamplifier EMCI	EMC 184045	980116	Jan. 09, 2015	Jan. 08, 2016
Preamplifier EMCI	EMC 330H	980112	Dec. 27, 2014	Dec. 26, 2015
Power Meter Anritsu	ML2495A	1232002	Sep. 17, 2014	Sep. 16, 2015
Power Sensor Anritsu	MA2411B	1207325	Sep. 17, 2014	Sep. 16, 2015
RF signal cable HUBER+SUHNNER	SUCOFLEX 104	309219/4 2950114	Oct. 18, 2014	Oct. 17, 2015
RF signal cable HUBER+SUHNNER	SUCOFLEX 104	250130/4	Oct. 18, 2014	Oct. 17, 2015
RF Coaxial Cable Worken	8D-FB	Cable-Ch10-01	Nov. 07, 2014	Nov. 06, 2015
Software BV ADT	E3 6.120103	NA	NA	NA
Antenna Tower MF	MFA-440H	NA	NA	NA
Turn Table MF	MFT-201SS	NA	NA	NA
Antenna Tower & Turn Table Controller MF	MF-7802	NA	NA	NA

- Note: 1. The calibration interval of the above test instruments is 12 months and the calibrations are traceable to NML/ROC and NIST/USA.
2. The test was performed in HwaYa Chamber 10.
3. The horn antenna and HP preamplifier (model: 8449B) are used only for the measurement of emission frequency above 1GHz if tested.
4. The FCC Site Registration No. is 690701.
5. The IC Site Registration No. is IC7450F-10.

4.1.3 Test Procedures

- a. The EUT was placed on the top of a rotating table 0.8 meters (for below 1GHz) / 1.5 meters (for above 1GHz) above the ground at 3 meter chamber room for test. The table was rotated 360 degrees to determine the position of the highest radiation.
- b. The EUT was set 3 meters away from the interference-receiving antenna, which was mounted on the top of a variable-height antenna tower.
- c. The height of antenna is varied from one meter to four meters above the ground to determine the maximum value of the field strength. Both horizontal and vertical polarizations of the antenna are set to make the measurement.
- d. For each suspected emission, the EUT was arranged to its worst case and then the antenna was tuned to heights from 1 meter to 4 meters and the rotatable table was turned from 0 degrees to 360 degrees to find the maximum reading.
- e. The test-receiver system was set to quasi-peak detect function and specified bandwidth with maximum hold mode when the test frequency is below 1 GHz.
- f. The test-receiver system was set to peak and average detect function and specified bandwidth with maximum hold mode when the test frequency is above 1 GHz. If the peak reading value also meets average limit, measurement with the average detector is unnecessary.

Note:

1. The resolution bandwidth and video bandwidth of test receiver/spectrum analyzer is 120 kHz for Quasi-peak detection (QP) at frequency below 1 GHz.
2. The resolution bandwidth of test receiver/spectrum analyzer is 1 MHz and the video bandwidth is 3 MHz for Peak detection (PK) at frequency above 1 GHz.
3. The resolution bandwidth of test receiver/spectrum analyzer is 1 MHz and the video bandwidth is 3 MHz for RMS Average (Duty cycle < 98%) for Average detection (AV) at frequency above 1GHz, then the measurement results was added to a correction factor ($10 \log(1/\text{duty cycle})$).
4. The resolution bandwidth of test receiver/spectrum analyzer is 1MHz and the video bandwidth is 10 Hz (Duty cycle $\geq 98\%$) for Average detection (AV) at frequency above 1 GHz.
5. All modes of operation were investigated and the worst-case emissions are reported.

4.1.4 Deviation from Test Standard

No deviation.

4.1.5 Test Set Up

<Frequency Range below 1GHz>

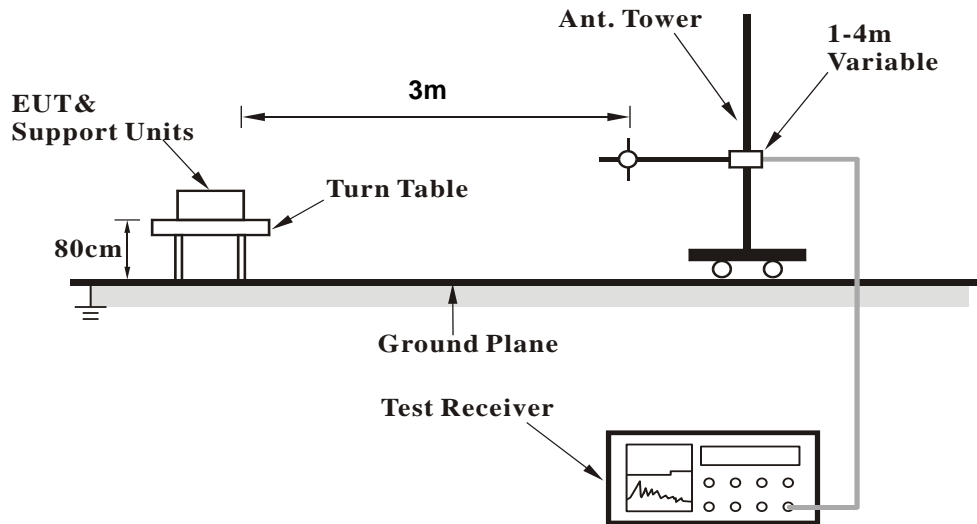

<Frequency Range above 1GHz>

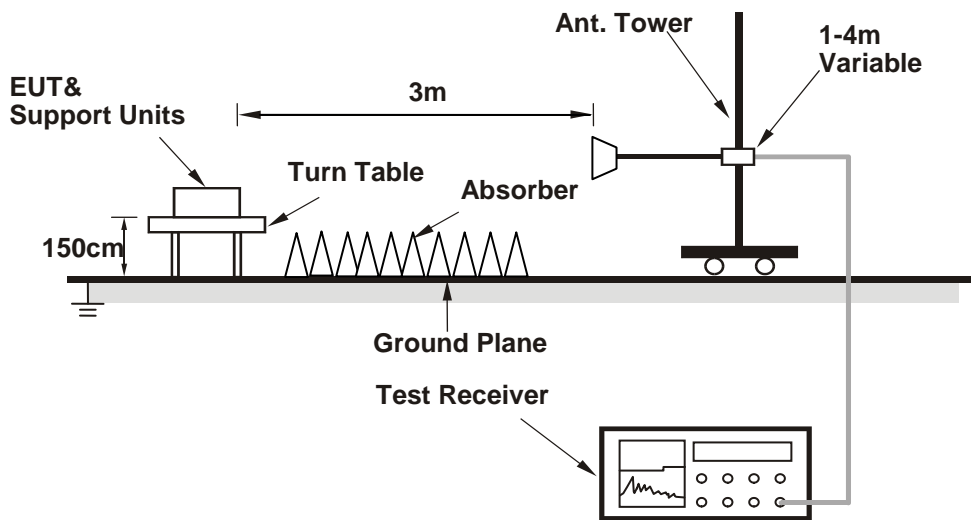

For the actual test configuration, please refer to the attached file (Test Setup Photo).

4.1.6 EUT Operating Conditions

- a. Placed the EUT on a testing table.
- b. Use the software to control the EUT under transmission condition continuously at specific channel frequency.

4.1.7 Test Results
Above 1GHz Data :
802.11b

EUT TEST CONDITION		MEASUREMENT DETAIL	
CHANNEL	Channel 1	FREQUENCY RANGE	1GHz ~ 25GHz
INPUT POWER	120Vac, 60 Hz	DETECTOR FUNCTION	Peak (PK) Average (AV)
ENVIRONMENTAL CONDITIONS	25deg. C, 65%RH	TESTED BY	Gavin Wu

ANTENNA POLARITY & TEST DISTANCE: HORIZONTAL AT 3 M										
FREQ. (MHz)	EMISSION LEVEL (dBuV/m)	READ LEVEL (dBuV)	LIMIT (dBuV/m)	MARGIN (dB)	ANTENNA FACTOR (dB/m)	CABLE LOSS (dB)	PREAMP FACTOR (dB)	ANTENNA HEIGHT (cm)	TABLE ANGLE (Degree)	REMARK
2386	39.08	45.59	54	-14.92	26.91	4.08	37.5	163	116	Average
2386	57.63	64.14	74	-16.37	26.91	4.08	37.5	163	116	Peak
2412	100.95	107.42			26.96	4.09	37.52	163	116	Average
2412	104.97	111.44			26.96	4.09	37.52	163	116	Peak
2484	35.35	41.37	54	-18.65	27.15	4.15	37.32	163	116	Average
2484	57	63.02	74	-17	27.15	4.15	37.32	163	116	Peak
4824	49.39	64.69	54	-4.61	30.99	6.79	53.08	112	348	Average
4824	52.02	67.32	74	-21.98	30.99	6.79	53.08	112	348	Peak
ANTENNA POLARITY & TEST DISTANCE: VERTICAL AT 3 M										
FREQ. (MHz)	EMISSION LEVEL (dBuV/m)	READ LEVEL (dBuV)	LIMIT (dBuV/m)	MARGIN (dB)	ANTENNA FACTOR (dB/m)	CABLE LOSS (dB)	PREAMP FACTOR (dB)	ANTENNA HEIGHT (cm)	TABLE ANGLE (Degree)	REMARK
2370	38.83	45.4	54	-15.17	26.86	4.07	37.5	154	88	Average
2370	57.18	63.75	74	-16.82	26.86	4.07	37.5	154	88	Peak
2412	100.08	106.55			26.96	4.09	37.52	154	88	Average
2412	104.15	110.62			26.96	4.09	37.52	154	88	Peak
2492	34.64	40.53	54	-19.36	27.2	4.16	37.25	154	88	Average
2492	57.93	63.82	74	-16.07	27.2	4.16	37.25	154	88	Peak
4824	51.91	67.21	54	-2.09	30.99	6.79	53.08	125	336	Average
4824	54.15	69.45	74	-19.85	30.99	6.79	53.08	125	336	Peak

REMARKS:

- Emission Level = Read Level + Antenna Factor + Cable Loss - Preamp Factor
Margin value = Emission level – Limit value
- 2412MHz: Fundamental frequency.

EUT TEST CONDITION		MEASUREMENT DETAIL	
CHANNEL	Channel 6	FREQUENCY RANGE	1GHz ~ 25GHz
INPUT POWER	120Vac, 60 Hz	DETECTOR FUNCTION	Peak (PK) Average (AV)
ENVIRONMENTAL CONDITIONS	25deg. C, 65%RH	TESTED BY	Gavin Wu

ANTENNA POLARITY & TEST DISTANCE: HORIZONTAL AT 3 M										
FREQ. (MHz)	EMISSION LEVEL (dBuV/m)	READ LEVEL (dBuV)	LIMIT (dBuV/m)	MARGIN (dB)	ANTENNA FACTOR (dB/m)	CABLE LOSS (dB)	PREAMP FACTOR (dB)	ANTENNA HEIGHT (cm)	TABLE ANGLE (Degree)	REMARK
2390	34.47	41	54	-19.53	26.91	4.08	37.52	177	121	Average
2390	57.07	63.6	74	-16.93	26.91	4.08	37.52	177	121	Peak
2437	102.83	109.11			27.06	4.12	37.46	177	121	Average
2437	106.95	113.23			27.06	4.12	37.46	177	121	Peak
2490	35.41	41.37	54	-18.59	27.2	4.16	37.32	177	121	Average
2490	57.17	63.13	74	-16.83	27.2	4.16	37.32	177	121	Peak
4874	50.14	65.28	54	-3.86	31.06	6.85	53.05	118	347	Average
4874	52.01	67.15	74	-21.99	31.06	6.85	53.05	118	347	Peak

ANTENNA POLARITY & TEST DISTANCE: VERTICAL AT 3 M										
FREQ. (MHz)	EMISSION LEVEL (dBuV/m)	READ LEVEL (dBuV)	LIMIT (dBuV/m)	MARGIN (dB)	ANTENNA FACTOR (dB/m)	CABLE LOSS (dB)	PREAMP FACTOR (dB)	ANTENNA HEIGHT (cm)	TABLE ANGLE (Degree)	REMARK
2380	33.96	40.52	54	-20.04	26.86	4.08	37.5	100	89	Average
2380	57.35	63.91	74	-16.65	26.86	4.08	37.5	100	89	Peak
2437	103.32	109.6			27.06	4.12	37.46	100	89	Average
2437	107.38	113.66			27.06	4.12	37.46	100	89	Peak
2500	35.14	41.03	54	-18.86	27.2	4.16	37.25	100	89	Average
2500	57.24	63.13	74	-16.76	27.2	4.16	37.25	100	89	Peak
4874	52.3	67.44	54	-1.7	31.06	6.85	53.05	147	338	Average
4874	54.04	69.18	74	-19.96	31.06	6.85	53.05	147	338	Peak

REMARKS:

- Emission Level = Read Level + Antenna Factor + Cable Loss - Preamp Factor
Margin value = Emission level – Limit value
- 2437MHz: Fundamental frequency.

EUT TEST CONDITION		MEASUREMENT DETAIL	
CHANNEL	Channel 11	FREQUENCY RANGE	1GHz ~ 25GHz
INPUT POWER	120Vac, 60 Hz	DETECTOR FUNCTION	Peak (PK) Average (AV)
ENVIRONMENTAL CONDITIONS	25deg. C, 65%RH	TESTED BY	Gavin Wu

ANTENNA POLARITY & TEST DISTANCE: HORIZONTAL AT 3 M										
FREQ. (MHz)	EMISSION LEVEL (dBuV/m)	READ LEVEL (dBuV)	LIMIT (dBuV/m)	MARGIN (dB)	ANTENNA FACTOR (dB/m)	CABLE LOSS (dB)	PREAMP FACTOR (dB)	ANTENNA HEIGHT (cm)	TABLE ANGLE (Degree)	REMARK
2336	34.54	41.2	54	-19.46	26.77	4.04	37.47	175	121	Average
2336	56.85	63.51	74	-17.15	26.77	4.04	37.47	175	121	Peak
2462	103.28	109.44			27.1	4.13	37.39	175	121	Average
2462	107.39	113.55			27.1	4.13	37.39	175	121	Peak
2484	45.03	51.05	54	-8.97	27.15	4.15	37.32	175	121	Average
2484	58.5	64.52	74	-15.5	27.15	4.15	37.32	175	121	Peak
4924	47.92	62.95	54	-6.08	31.12	6.88	53.03	147	348	Average
4924	50.86	65.89	74	-23.14	31.12	6.88	53.03	147	348	Peak

ANTENNA POLARITY & TEST DISTANCE: VERTICAL AT 3 M										
FREQ. (MHz)	EMISSION LEVEL (dBuV/m)	READ LEVEL (dBuV)	LIMIT (dBuV/m)	MARGIN (dB)	ANTENNA FACTOR (dB/m)	CABLE LOSS (dB)	PREAMP FACTOR (dB)	ANTENNA HEIGHT (cm)	TABLE ANGLE (Degree)	REMARK
2334	34.03	40.74	54	-19.97	26.72	4.04	37.47	131	88	Average
2334	57.81	64.52	74	-16.19	26.72	4.04	37.47	131	88	Peak
2462	102.04	108.2			27.1	4.13	37.39	131	88	Average
2462	106.17	112.33			27.1	4.13	37.39	131	88	Peak
2484	44.3	50.32	54	-9.7	27.15	4.15	37.32	131	88	Average
2484	58.93	64.95	74	-15.07	27.15	4.15	37.32	131	88	Peak
4924	49.62	64.65	54	-4.38	31.12	6.88	53.03	100	339	Average
4924	52.13	67.16	74	-21.87	31.12	6.88	53.03	100	339	Peak

REMARKS:

- Emission Level = Read Level + Antenna Factor + Cable Loss - Preamp Factor
Margin value = Emission level – Limit value
- 2462MHz: Fundamental frequency.



802.11g

EUT TEST CONDITION		MEASUREMENT DETAIL	
CHANNEL	Channel 1	FREQUENCY RANGE	1GHz ~ 25GHz
INPUT POWER	120Vac, 60 Hz	DETECTOR FUNCTION	Peak (PK) Average (AV)
ENVIRONMENTAL CONDITIONS	25deg. C, 65%RH	TESTED BY	Gavin Wu

ANTENNA POLARITY & TEST DISTANCE: HORIZONTAL AT 3 M

FREQ. (MHz)	EMISSION LEVEL (dBuV/m)	READ LEVEL (dBuV)	LIMIT (dBuV/m)	MARGIN (dB)	ANTENNA FACTOR (dB/m)	CABLE LOSS (dB)	PREAMP FACTOR (dB)	ANTENNA HEIGHT (cm)	TABLE ANGLE (Degree)	REMARK
2390	51.82	58.35	54	-2.18	26.91	4.08	37.52	163	117	Average
2390	71.75	78.28	74	-2.25	26.91	4.08	37.52	163	117	Peak
2412	96.1	102.57			26.96	4.09	37.52	163	117	Average
2412	105.69	112.16			26.96	4.09	37.52	163	117	Peak
2500	37.44	43.33	54	-16.56	27.2	4.16	37.25	163	117	Average
2500	57.09	62.98	74	-16.91	27.2	4.16	37.25	163	117	Peak
4824	35.64	50.94	54	-18.36	30.99	6.79	53.08	202	318	Average
4824	47.96	63.26	74	-26.04	30.99	6.79	53.08	202	318	Peak

ANTENNA POLARITY & TEST DISTANCE: VERTICAL AT 3 M

FREQ. (MHz)	EMISSION LEVEL (dBuV/m)	READ LEVEL (dBuV)	LIMIT (dBuV/m)	MARGIN (dB)	ANTENNA FACTOR (dB/m)	CABLE LOSS (dB)	PREAMP FACTOR (dB)	ANTENNA HEIGHT (cm)	TABLE ANGLE (Degree)	REMARK
2390	51.06	57.59	54	-2.94	26.91	4.08	37.52	103	85	Average
2390	68.79	75.32	74	-5.21	26.91	4.08	37.52	103	85	Peak
2412	95.49	101.96			26.96	4.09	37.52	103	85	Average
2412	105	111.47			26.96	4.09	37.52	103	85	Peak
2500	37.38	43.27	54	-16.62	27.2	4.16	37.25	103	85	Average
2500	57.34	63.23	74	-16.66	27.2	4.16	37.25	103	85	Peak
4824	34.97	50.27	54	-19.03	30.99	6.79	53.08	101	305	Average
4824	47.8	63.1	74	-26.2	30.99	6.79	53.08	101	305	Peak

REMARKS:

- Emission Level = Read Level + Antenna Factor + Cable Loss - Preamp Factor
Margin value = Emission level – Limit value
- 2412MHz: Fundamental frequency.

EUT TEST CONDITION		MEASUREMENT DETAIL	
CHANNEL	Channel 6	FREQUENCY RANGE	1GHz ~ 25GHz
INPUT POWER	120Vac, 60 Hz	DETECTOR FUNCTION	Peak (PK) Average (AV)
ENVIRONMENTAL CONDITIONS	25deg. C, 65%RH	TESTED BY	Gavin Wu

ANTENNA POLARITY & TEST DISTANCE: HORIZONTAL AT 3 M										
FREQ. (MHz)	EMISSION LEVEL (dBuV/m)	READ LEVEL (dBuV)	LIMIT (dBuV/m)	MARGIN (dB)	ANTENNA FACTOR (dB/m)	CABLE LOSS (dB)	PREAMP FACTOR (dB)	ANTENNA HEIGHT (cm)	TABLE ANGLE (Degree)	REMARK
2390	39.37	45.9	54	-14.63	26.91	4.08	37.52	176	125	Average
2390	60.59	67.12	74	-13.41	26.91	4.08	37.52	176	125	Peak
2437	98.7	104.98			27.06	4.12	37.46	176	125	Average
2437	108.21	114.49			27.06	4.12	37.46	176	125	Peak
2486	39.49	45.51	54	-14.51	27.15	4.15	37.32	176	125	Average
2486	61.2	67.22	74	-12.8	27.15	4.15	37.32	176	125	Peak
4874	35.13	50.27	54	-18.87	31.06	6.85	53.05	201	337	Average
4874	47.26	62.4	74	-26.74	31.06	6.85	53.05	201	337	Peak

ANTENNA POLARITY & TEST DISTANCE: VERTICAL AT 3 M										
FREQ. (MHz)	EMISSION LEVEL (dBuV/m)	READ LEVEL (dBuV)	LIMIT (dBuV/m)	MARGIN (dB)	ANTENNA FACTOR (dB/m)	CABLE LOSS (dB)	PREAMP FACTOR (dB)	ANTENNA HEIGHT (cm)	TABLE ANGLE (Degree)	REMARK
2390	39.14	45.67	54	-14.86	26.91	4.08	37.52	117	74	Average
2390	60.26	66.79	74	-13.74	26.91	4.08	37.52	117	74	Peak
2437	97.69	103.97			27.06	4.12	37.46	117	74	Average
2437	107.35	113.63			27.06	4.12	37.46	117	74	Peak
2494	38.58	44.47	54	-15.42	27.2	4.16	37.25	117	74	Average
2494	59.1	64.99	74	-14.9	27.2	4.16	37.25	117	74	Peak
4874	35.03	50.17	54	-18.97	31.06	6.85	53.05	100	344	Average
4874	47.88	63.02	74	-26.12	31.06	6.85	53.05	100	344	Peak

REMARKS:

- Emission Level = Read Level + Antenna Factor + Cable Loss - Preamp Factor
Margin value = Emission level – Limit value
- 2437MHz: Fundamental frequency.

EUT TEST CONDITION		MEASUREMENT DETAIL	
CHANNEL	Channel 11	FREQUENCY RANGE	1GHz ~ 25GHz
INPUT POWER	120Vac, 60 Hz	DETECTOR FUNCTION	Peak (PK) Average (AV)
ENVIRONMENTAL CONDITIONS	25deg. C, 65%RH	TESTED BY	Gavin Wu

ANTENNA POLARITY & TEST DISTANCE: HORIZONTAL AT 3 M										
FREQ. (MHz)	EMISSION LEVEL (dBuV/m)	READ LEVEL (dBuV)	LIMIT (dBuV/m)	MARGIN (dB)	ANTENNA FACTOR (dB/m)	CABLE LOSS (dB)	PREAMP FACTOR (dB)	ANTENNA HEIGHT (cm)	TABLE ANGLE (Degree)	REMARK
2316	35.53	42.3	54	-18.47	26.67	4.03	37.47	175	119	Average
2316	57.88	64.65	74	-16.12	26.67	4.03	37.47	175	119	Peak
2462	98.51	104.67			27.1	4.13	37.39	175	119	Average
2462	108.05	114.21			27.1	4.13	37.39	175	119	Peak
2484	48.28	54.3	54	-5.72	27.15	4.15	37.32	175	119	Average
2484	64.93	70.95	74	-9.07	27.15	4.15	37.32	175	119	Peak
4924	32.17	47.2	54	-21.83	31.12	6.88	53.03	201	357	Average
4924	44.54	59.57	74	-29.46	31.12	6.88	53.03	201	357	Peak

ANTENNA POLARITY & TEST DISTANCE: VERTICAL AT 3 M										
FREQ. (MHz)	EMISSION LEVEL (dBuV/m)	READ LEVEL (dBuV)	LIMIT (dBuV/m)	MARGIN (dB)	ANTENNA FACTOR (dB/m)	CABLE LOSS (dB)	PREAMP FACTOR (dB)	ANTENNA HEIGHT (cm)	TABLE ANGLE (Degree)	REMARK
2386	35.36	41.87	54	-18.64	26.91	4.08	37.5	101	89	Average
2386	57.6	64.11	74	-16.4	26.91	4.08	37.5	101	89	Peak
2462	97.55	103.71			27.1	4.13	37.39	101	89	Average
2462	107.34	113.5			27.1	4.13	37.39	101	89	Peak
2484	46.89	52.91	54	-7.11	27.15	4.15	37.32	101	89	Average
2484	64.84	70.86	74	-9.16	27.15	4.15	37.32	101	89	Peak
4924	31.88	46.91	54	-22.12	31.12	6.88	53.03	100	348	Average
4924	44.29	59.32	74	-29.71	31.12	6.88	53.03	100	348	Peak

REMARKS:

- Emission Level = Read Level + Antenna Factor + Cable Loss - Preamp Factor
Margin value = Emission level – Limit value
- 2462MHz: Fundamental frequency.



A D T

802.11n (20MHz)

EUT TEST CONDITION		MEASUREMENT DETAIL	
CHANNEL	Channel 1	FREQUENCY RANGE	1GHz ~ 25GHz
INPUT POWER	120Vac, 60 Hz	DETECTOR FUNCTION	Peak (PK) Average (AV)
ENVIRONMENTAL CONDITIONS	25deg. C, 65%RH	TESTED BY	Gavin Wu

ANTENNA POLARITY & TEST DISTANCE: HORIZONTAL AT 3 M

FREQ. (MHz)	EMISSION LEVEL (dBuV/m)	READ LEVEL (dBuV)	LIMIT (dBuV/m)	MARGIN (dB)	ANTENNA FACTOR (dB/m)	CABLE LOSS (dB)	PREAMP FACTOR (dB)	ANTENNA HEIGHT (cm)	TABLE ANGLE (Degree)	REMARK
2390	51.34	57.87	54	-2.66	26.91	4.08	37.52	178	118	Average
2390	69.09	75.62	74	-4.91	26.91	4.08	37.52	178	118	Peak
2412	95.73	102.2			26.96	4.09	37.52	178	118	Average
2412	105.35	111.82			26.96	4.09	37.52	178	118	Peak
2498	37.72	43.61	54	-16.28	27.2	4.16	37.25	178	118	Average
2498	56.8	62.69	74	-17.2	27.2	4.16	37.25	178	118	Peak
4824	34.78	50.08	54	-19.22	30.99	6.79	53.08	202	316	Average
4824	46.92	62.22	74	-27.08	30.99	6.79	53.08	202	316	Peak

ANTENNA POLARITY & TEST DISTANCE: VERTICAL AT 3 M

FREQ. (MHz)	EMISSION LEVEL (dBuV/m)	READ LEVEL (dBuV)	LIMIT (dBuV/m)	MARGIN (dB)	ANTENNA FACTOR (dB/m)	CABLE LOSS (dB)	PREAMP FACTOR (dB)	ANTENNA HEIGHT (cm)	TABLE ANGLE (Degree)	REMARK
2390	51.14	57.67	54	-2.86	26.91	4.08	37.52	103	83	Average
2390	68.7	75.23	74	-5.3	26.91	4.08	37.52	103	83	Peak
2412	95.16	101.63			26.96	4.09	37.52	103	83	Average
2412	104.67	111.14			26.96	4.09	37.52	103	83	Peak
2498	37.42	43.31	54	-16.58	27.2	4.16	37.25	103	83	Average
2498	57.67	63.56	74	-16.33	27.2	4.16	37.25	103	83	Peak
4824	34.74	50.04	54	-19.26	30.99	6.79	53.08	108	298	Average
4824	45.56	60.86	74	-28.44	30.99	6.79	53.08	108	298	Peak

REMARKS:

- Emission Level = Read Level + Antenna Factor + Cable Loss - Preamp Factor
Margin value = Emission level – Limit value
- 2412MHz: Fundamental frequency.

EUT TEST CONDITION		MEASUREMENT DETAIL	
CHANNEL	Channel 6	FREQUENCY RANGE	1GHz ~ 25GHz
INPUT POWER	120Vac, 60 Hz	DETECTOR FUNCTION	Peak (PK) Average (AV)
ENVIRONMENTAL CONDITIONS	25deg. C, 65%RH	TESTED BY	Gavin Wu

ANTENNA POLARITY & TEST DISTANCE: HORIZONTAL AT 3 M										
FREQ. (MHz)	EMISSION LEVEL (dBuV/m)	READ LEVEL (dBuV)	LIMIT (dBuV/m)	MARGIN (dB)	ANTENNA FACTOR (dB/m)	CABLE LOSS (dB)	PREAMP FACTOR (dB)	ANTENNA HEIGHT (cm)	TABLE ANGLE (Degree)	REMARK
2390	37.12	43.65	54	-16.88	26.91	4.08	37.52	177	107	Average
2390	61.98	68.51	74	-12.02	26.91	4.08	37.52	177	107	Peak
2437	97.55	103.83			27.06	4.12	37.46	177	107	Average
2437	107.16	113.44			27.06	4.12	37.46	177	107	Peak
2486	37.87	43.89	54	-16.13	27.15	4.15	37.32	177	107	Average
2486	64.48	70.5	74	-9.52	27.15	4.15	37.32	177	107	Peak
4874	34.87	50.01	54	-19.13	31.06	6.85	53.05	202	328	Average
4874	46.98	62.12	74	-27.02	31.06	6.85	53.05	202	328	Peak

ANTENNA POLARITY & TEST DISTANCE: VERTICAL AT 3 M										
FREQ. (MHz)	EMISSION LEVEL (dBuV/m)	READ LEVEL (dBuV)	LIMIT (dBuV/m)	MARGIN (dB)	ANTENNA FACTOR (dB/m)	CABLE LOSS (dB)	PREAMP FACTOR (dB)	ANTENNA HEIGHT (cm)	TABLE ANGLE (Degree)	REMARK
2388	36.77	43.28	54	-17.23	26.91	4.08	37.5	102	81	Average
2388	60.46	66.97	74	-13.54	26.91	4.08	37.5	102	81	Peak
2437	96.72	103			27.06	4.12	37.46	102	81	Average
2437	106.39	112.67			27.06	4.12	37.46	102	81	Peak
2496	37.35	43.24	54	-16.65	27.2	4.16	37.25	102	81	Average
2496	57.96	63.85	74	-16.04	27.2	4.16	37.25	102	81	Peak
4874	34.13	49.27	54	-19.87	31.06	6.85	53.05	102	276	Average
4874	45.07	60.21	74	-28.93	31.06	6.85	53.05	102	276	Peak

REMARKS:

- Emission Level = Read Level + Antenna Factor + Cable Loss - Preamp Factor
Margin value = Emission level – Limit value
- 2437MHz: Fundamental frequency.



EUT TEST CONDITION		MEASUREMENT DETAIL	
CHANNEL	Channel 11	FREQUENCY RANGE	1GHz ~ 25GHz
INPUT POWER	120Vac, 60 Hz	DETECTOR FUNCTION	Peak (PK) Average (AV)
ENVIRONMENTAL CONDITIONS	25deg. C, 65%RH	TESTED BY	Gavin Wu

ANTENNA POLARITY & TEST DISTANCE: HORIZONTAL AT 3 M										
FREQ. (MHz)	EMISSION LEVEL (dBuV/m)	READ LEVEL (dBuV)	LIMIT (dBuV/m)	MARGIN (dB)	ANTENNA FACTOR (dB/m)	CABLE LOSS (dB)	PREAMP FACTOR (dB)	ANTENNA HEIGHT (cm)	TABLE ANGLE (Degree)	REMARK
2376	36.05	42.62	54	-17.95	26.86	4.07	37.5	174	133	Average
2376	57.84	64.41	74	-16.16	26.86	4.07	37.5	174	133	Peak
2462	97.24	103.4			27.1	4.13	37.39	174	133	Average
2462	106.71	112.87			27.1	4.13	37.39	174	133	Peak
2484	49.16	55.18	54	-4.84	27.15	4.15	37.32	174	133	Average
2484	65.34	71.36	74	-8.66	27.15	4.15	37.32	174	133	Peak
4924	31.31	46.34	54	-22.69	31.12	6.88	53.03	205	324	Average
4924	42.26	57.29	74	-31.74	31.12	6.88	53.03	205	324	Peak

ANTENNA POLARITY & TEST DISTANCE: VERTICAL AT 3 M										
FREQ. (MHz)	EMISSION LEVEL (dBuV/m)	READ LEVEL (dBuV)	LIMIT (dBuV/m)	MARGIN (dB)	ANTENNA FACTOR (dB/m)	CABLE LOSS (dB)	PREAMP FACTOR (dB)	ANTENNA HEIGHT (cm)	TABLE ANGLE (Degree)	REMARK
2312	35.34	42.09	54	-18.66	26.67	4.03	37.45	132	92	Average
2312	57.1	63.85	74	-16.9	26.67	4.03	37.45	132	92	Peak
2462	96.23	102.39			27.1	4.13	37.39	132	92	Average
2462	105.99	112.15			27.1	4.13	37.39	132	92	Peak
2498	48.28	54.17	54	-5.72	27.2	4.16	37.25	132	92	Average
2498	64.61	70.5	74	-9.39	27.2	4.16	37.25	132	92	Peak
4924	31.15	46.18	54	-22.85	31.12	6.88	53.03	100	299	Average
4924	42.05	57.08	74	-31.95	31.12	6.88	53.03	100	299	Peak

REMARKS:

- Emission Level = Read Level + Antenna Factor + Cable Loss - Preamp Factor
Margin value = Emission level – Limit value
- 2462MHz: Fundamental frequency.

802.11n (40MHz)

EUT TEST CONDITION		MEASUREMENT DETAIL	
CHANNEL	Channel 3	FREQUENCY RANGE	1GHz ~ 25GHz
INPUT POWER	120Vac, 60 Hz	DETECTOR FUNCTION	Peak (PK) Average (AV)
ENVIRONMENTAL CONDITIONS	25deg. C, 65%RH	TESTED BY	Gavin Wu

ANTENNA POLARITY & TEST DISTANCE: HORIZONTAL AT 3 M

FREQ. (MHz)	EMISSION LEVEL (dBuV/m)	READ LEVEL (dBuV)	LIMIT (dBuV/m)	MARGIN (dB)	ANTENNA FACTOR (dB/m)	CABLE LOSS (dB)	PREAMP FACTOR (dB)	ANTENNA HEIGHT (cm)	TABLE ANGLE (Degree)	REMARK
2388	52.03	58.54	54	-1.97	26.91	4.08	37.5	176	122	Average
2388	68.06	74.57	74	-5.94	26.91	4.08	37.5	176	122	Peak
2422	92.2	98.54			27.01	4.11	37.46	176	122	Average
2422	101.62	107.96			27.01	4.11	37.46	176	122	Peak
2488	44.26	50.22	74	-29.74	27.2	4.16	37.32	176	122	Peak
2488	59.22	65.18	74	-14.78	27.2	4.16	37.32	176	122	Peak
4844	31.51	46.74	54	-22.49	31.01	6.82	53.06	201	309	Average
4844	42.02	57.25	74	-31.98	31.01	6.82	53.06	201	309	Peak

ANTENNA POLARITY & TEST DISTANCE: VERTICAL AT 3 M

FREQ. (MHz)	EMISSION LEVEL (dBuV/m)	READ LEVEL (dBuV)	LIMIT (dBuV/m)	MARGIN (dB)	ANTENNA FACTOR (dB/m)	CABLE LOSS (dB)	PREAMP FACTOR (dB)	ANTENNA HEIGHT (cm)	TABLE ANGLE (Degree)	REMARK
2390	50.94	57.47	54	-3.06	26.91	4.08	37.52	101	89	Average
2390	67.76	74.29	74	-6.24	26.91	4.08	37.52	101	89	Peak
2422	91.54	97.88			27.01	4.11	37.46	101	89	Average
2422	101.38	107.72			27.01	4.11	37.46	101	89	Peak
2488	42.08	48.04	54	-11.92	27.2	4.16	37.32	101	89	Average
2488	61.7	67.66	74	-12.3	27.2	4.16	37.32	101	89	Peak
4844	31.09	46.32	54	-22.91	31.01	6.82	53.06	101	270	Average
4844	41.38	56.61	74	-32.62	31.01	6.82	53.06	101	270	Peak

REMARKS:

- Emission Level = Read Level + Antenna Factor + Cable Loss - Preamp Factor
Margin value = Emission level – Limit value
- 2422MHz: Fundamental frequency.

EUT TEST CONDITION		MEASUREMENT DETAIL	
CHANNEL	Channel 6	FREQUENCY RANGE	1GHz ~ 25GHz
INPUT POWER	120Vac, 60 Hz	DETECTOR FUNCTION	Peak (PK) Average (AV)
ENVIRONMENTAL CONDITIONS	25deg. C, 65%RH	TESTED BY	Gavin Wu

ANTENNA POLARITY & TEST DISTANCE: HORIZONTAL AT 3 M										
FREQ. (MHz)	EMISSION LEVEL (dBuV/m)	READ LEVEL (dBuV)	LIMIT (dBuV/m)	MARGIN (dB)	ANTENNA FACTOR (dB/m)	CABLE LOSS (dB)	PREAMP FACTOR (dB)	ANTENNA HEIGHT (cm)	TABLE ANGLE (Degree)	REMARK
2390	52.03	58.56	54	-1.97	26.91	4.08	37.52	159	119	Average
2390	69.8	76.33	74	-4.2	26.91	4.08	37.52	159	119	Peak
2437	95.93	102.21			27.06	4.12	37.46	159	119	Average
2437	105.3	111.58			27.06	4.12	37.46	159	119	Peak
2484	52.84	58.86	54	-1.16	27.15	4.15	37.32	159	119	Average
2484	69.82	75.84	74	-4.18	27.15	4.15	37.32	159	119	Peak
4874	31.78	46.92	54	-22.22	31.06	6.85	53.05	202	349	Average
4874	43.71	58.85	74	-30.29	31.06	6.85	53.05	202	349	Peak

ANTENNA POLARITY & TEST DISTANCE: VERTICAL AT 3 M										
FREQ. (MHz)	EMISSION LEVEL (dBuV/m)	READ LEVEL (dBuV)	LIMIT (dBuV/m)	MARGIN (dB)	ANTENNA FACTOR (dB/m)	CABLE LOSS (dB)	PREAMP FACTOR (dB)	ANTENNA HEIGHT (cm)	TABLE ANGLE (Degree)	REMARK
2390	51.85	58.38	54	-2.15	26.91	4.08	37.52	101	103	Average
2390	69.51	76.04	74	-4.49	26.91	4.08	37.52	101	103	Peak
2437	94.53	100.81			27.06	4.12	37.46	101	103	Average
2437	104.57	110.85			27.06	4.12	37.46	101	103	Peak
2484	52	58.02	54	-2	27.15	4.15	37.32	101	103	Average
2484	68.59	74.61	74	-5.41	27.15	4.15	37.32	101	103	Peak
4874	31.37	46.51	54	-22.63	31.06	6.85	53.05	100	285	Average
4874	42.64	57.78	74	-31.36	31.06	6.85	53.05	100	285	Peak

REMARKS:

- Emission Level = Read Level + Antenna Factor + Cable Loss - Preamp Factor
Margin value = Emission level – Limit value
- 2437MHz: Fundamental frequency.

EUT TEST CONDITION		MEASUREMENT DETAIL	
CHANNEL	Channel 9	FREQUENCY RANGE	1GHz ~ 25GHz
INPUT POWER	120Vac, 60 Hz	DETECTOR FUNCTION	Peak (PK) Average (AV)
ENVIRONMENTAL CONDITIONS	25deg. C, 65%RH	TESTED BY	Gavin Wu

ANTENNA POLARITY & TEST DISTANCE: HORIZONTAL AT 3 M										
FREQ. (MHz)	EMISSION LEVEL (dBuV/m)	READ LEVEL (dBuV)	LIMIT (dBuV/m)	MARGIN (dB)	ANTENNA FACTOR (dB/m)	CABLE LOSS (dB)	PREAMP FACTOR (dB)	ANTENNA HEIGHT (cm)	TABLE ANGLE (Degree)	REMARK
2390	40.74	47.27	54	-13.26	26.91	4.08	37.52	176	122	Average
2390	57.93	64.46	74	-16.07	26.91	4.08	37.52	176	122	Peak
2452	93.16	99.36			27.06	4.13	37.39	176	122	Average
2452	102.75	108.95			27.06	4.13	37.39	176	122	Peak
2484	52.89	58.91	54	-1.11	27.15	4.15	37.32	176	122	Average
2484	71.88	77.9	74	-2.12	27.15	4.15	37.32	176	122	Peak
4904	28.93	43.98	54	-25.07	31.1	6.88	53.03	204	352	Average
4904	41.57	56.62	74	-32.43	31.1	6.88	53.03	204	352	Peak
ANTENNA POLARITY & TEST DISTANCE: VERTICAL AT 3 M										
FREQ. (MHz)	EMISSION LEVEL (dBuV/m)	READ LEVEL (dBuV)	LIMIT (dBuV/m)	MARGIN (dB)	ANTENNA FACTOR (dB/m)	CABLE LOSS (dB)	PREAMP FACTOR (dB)	ANTENNA HEIGHT (cm)	TABLE ANGLE (Degree)	REMARK
2388	40.81	47.32	54	-13.19	26.91	4.08	37.5	135	85	Average
2388	57.57	64.08	74	-16.43	26.91	4.08	37.5	135	85	Peak
2452	92.15	98.35			27.06	4.13	37.39	135	85	Average
2452	101.73	107.93			27.06	4.13	37.39	135	85	Peak
2490	51.51	57.47	54	-2.49	27.2	4.16	37.32	135	85	Average
2490	69.7	75.66	74	-4.3	27.2	4.16	37.32	135	85	Peak
4904	28.52	43.57	54	-25.48	31.1	6.88	53.03	102	294	Average
4904	41.25	56.3	74	-32.75	31.1	6.88	53.03	102	294	Peak

REMARKS:

- Emission Level = Read Level + Antenna Factor + Cable Loss - Preamp Factor
Margin value = Emission level – Limit value
- 2452MHz: Fundamental frequency.

Below 1GHz Data:
802.11n (40MHz)

EUT TEST CONDITION		MEASUREMENT DETAIL	
CHANNEL	Channel 9	FREQUENCY RANGE	30MHz ~ 1GHz
INPUT POWER	120Vac, 60 Hz	DETECTOR FUNCTION	Peak (PK) Quasi-Peak (QP)
ENVIRONMENTAL CONDITIONS	25deg. C, 65%RH	TESTED BY	Gavin Wu

ANTENNA POLARITY & TEST DISTANCE: HORIZONTAL AT 3 M

FREQ. (MHz)	EMISSION LEVEL (dBuV/m)	READ LEVEL (dBuV)	LIMIT (dBuV/m)	MARGIN (dB)	ANTENNA FACTOR (dB/m)	CABLE LOSS (dB)	PREAMP FACTOR (dB)	ANTENNA HEIGHT (cm)	TABLE ANGLE (Degree)	REMARK
74.62	29.65	50.9	40	-10.35	9.57	0.86	31.68	114	212	Peak
116.33	30.43	50.53	43.5	-13.07	10.65	1.13	31.88	134	108	Peak
165.8	34.02	52.54	43.5	-9.48	12.15	1.12	31.79	123	288	Peak
178.41	30.52	50.23	43.5	-12.98	10.92	1.19	31.82	132	173	Peak
253.1	29.62	48.46	46	-16.38	11.57	1.5	31.91	129	283	Peak
272.5	28.98	47.25	46	-17.02	12.14	1.56	31.97	128	244	Peak

ANTENNA POLARITY & TEST DISTANCE: VERTICAL AT 3 M

FREQ. (MHz)	EMISSION LEVEL (dBuV/m)	READ LEVEL (dBuV)	LIMIT (dBuV/m)	MARGIN (dB)	ANTENNA FACTOR (dB/m)	CABLE LOSS (dB)	PREAMP FACTOR (dB)	ANTENNA HEIGHT (cm)	TABLE ANGLE (Degree)	REMARK
41.64	33.03	49.86	40	-6.97	13.56	0.66	31.05	123	290	Peak
60.07	31.25	49.86	40	-8.75	11.94	0.81	31.36	120	324	Peak
64.92	34.75	54.15	40	-5.25	11.35	0.84	31.59	137	175	Peak
158.04	26.4	44.37	43.5	-17.1	12.73	1.13	31.83	117	186	Peak
253.1	24.83	43.67	46	-21.17	11.57	1.5	31.91	103	230	Peak
655.65	23.08	32.41	46	-22.92	20.28	2.37	31.98	123	247	Peak

REMARKS:

- Emission Level = Read Level + Antenna Factor + Cable Loss - Preamp Factor
Margin value = Emission level – Limit value

4.2 Conducted Emission Measurement

4.2.1 Limits of Conducted Emission Measurement

Frequency (MHz)	Conducted Limit (dBuV)	
	Quasi-peak	Average
0.15 - 0.5	66 - 56	56 - 46
0.50 - 5.0	56	46
5.0 - 30.0	60	50

Note: 1. The lower limit shall apply at the transition frequencies.

2. The limit decreases in line with the logarithm of the frequency in the range of 0.15 to 0.50MHz.

4.2.2 Test Instruments

Description & Manufacturer	Model No.	Serial No.	Date of Calibration	Due Date of Calibration
Test Receiver ROHDE & SCHWARZ	ESCS30	100288	Apr. 27, 2015	Apr. 26, 2016
RF signal cable Woken	5D-FB	Cable-HYCO2-0 1	Dec. 26, 2014	Dec. 25, 2015
LISN ROHDE & SCHWARZ (EUT)	ESH2-Z5	100100	Dec. 30, 2014	Dec. 29, 2015
LISN ROHDE & SCHWARZ (Peripheral)	ESH3-Z5	100312	Jul. 21, 2015	Jul. 20, 2016
Software ADT	BV ADT_Cond_ V7.3.7.3	NA	NA	NA

Note: 1. The calibration interval of the above test instruments is 12 months and the calibrations are traceable to NML/ROC and NIST/USA.

2. The test was performed in HwaYa Shielded Room 2.

3. The VCCI Site Registration No. is C-2047.

4.2.3 Test Procedures

- The EUT was placed 0.4 meters from the conducting wall of the shielded room with EUT being connected to the power mains through a line impedance stabilization network (LISN). Other support units were connected to the power mains through another LISN. The two LISNs provide 50 ohm / 50uH of coupling impedance for the measuring instrument.
- Both lines of the power mains connected to the EUT were checked for maximum conducted interference.
- The frequency range from 150 kHz to 30MHz was searched. Emission levels under (Limit - 20dB) was not recorded.

NOTE: All modes of operation were investigated and the worst-case emissions are reported.

4.2.4 Deviation from Test Standard

No deviation.

4.2.5 Test Setup

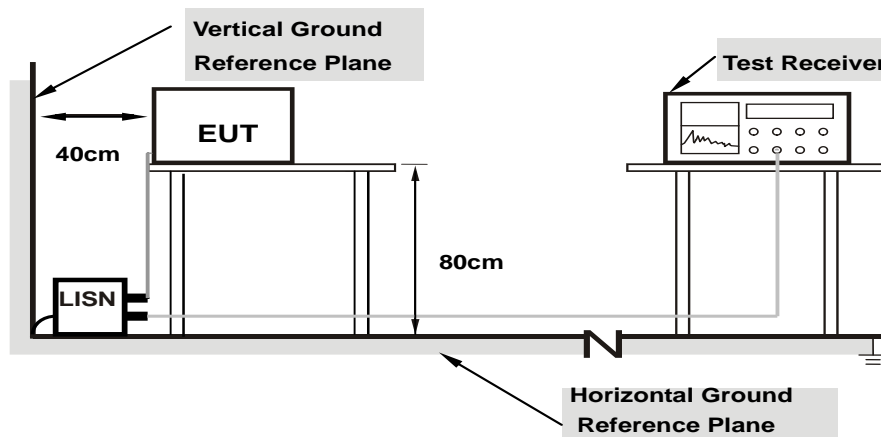

Note: 1.Support units were connected to second LISN.

For the actual test configuration, please refer to the attached file (Test Setup Photo).

4.2.6 EUT Operating Conditions

Same as 4.1.6.

4.2.7 Test Results

Frequency Range	150kHz ~ 30MHz	Detector Function & Resolution Bandwidth	Quasi-Peak (QP) / Average (AV), 9kHz
Input Power	120Vac, 60Hz	Environmental Conditions	25°C, 65%RH
Tested by	Toby Tian	Test Date	2015/8/7

Phase Of Power : Line (L)										
No	Frequency (MHz)	Correction Factor (dB)	Reading Value (dBuV)		Emission Level (dBuV)		Limit (dBuV)		Margin (dB)	
			Q.P.	AV.	Q.P.	AV.	Q.P.	AV.	Q.P.	AV.
1	0.15000	0.16	53.22	42.34	53.38	42.50	66.00	56.00	-12.62	-13.50
2	0.19687	0.17	44.64	33.05	44.81	33.22	63.74	53.74	-18.93	-20.52
3	0.99375	0.23	38.68	29.45	38.91	29.68	56.00	46.00	-17.09	-16.32
4	2.17969	0.28	35.74	27.10	36.02	27.38	56.00	46.00	-19.98	-18.62
5	3.58203	0.33	34.96	26.35	35.29	26.68	56.00	46.00	-20.71	-19.32
6	4.76172	0.36	33.47	25.35	33.83	25.71	56.00	46.00	-22.17	-20.29

Remarks:

1. Q.P. and AV. are abbreviations of quasi-peak and average individually.
2. The emission levels of other frequencies were very low against the limit.
3. Margin value = Emission level – Limit value
4. Correction factor = Insertion loss + Cable loss
5. Emission Level = Correction Factor + Reading Value

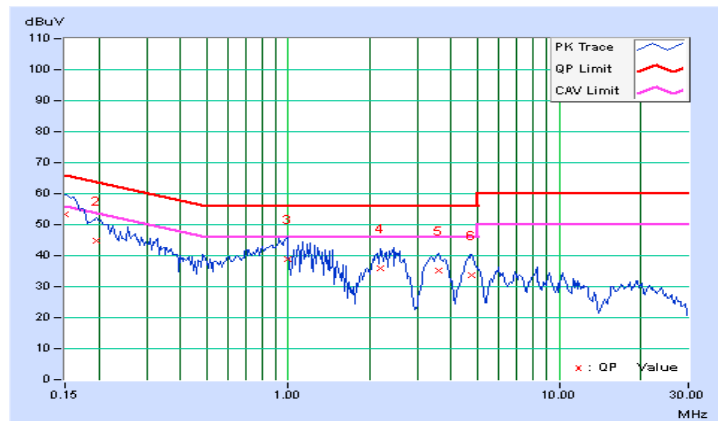

Frequency Range	150kHz ~ 30MHz	Detector Function & Resolution Bandwidth	Quasi-Peak (QP) / Average (AV), 9kHz
Input Power	120Vac, 60Hz	Environmental Conditions	25°C, 65%RH
Tested by	Toby Tian	Test Date	2015/8/7

Phase Of Power : Neutral (N)										
No	Frequency (MHz)	Correction Factor (dB)	Reading Value (dBuV)		Emission Level (dBuV)		Limit (dBuV)		Margin (dB)	
			Q.P.	AV.	Q.P.	AV.	Q.P.	AV.	Q.P.	AV.
1	0.15000	0.17	47.95	36.69	48.12	36.86	66.00	56.00	-17.88	-19.14
2	0.19297	0.18	39.50	27.42	39.68	27.60	63.91	53.91	-24.23	-26.31
3	0.96641	0.24	35.80	26.96	36.04	27.20	56.00	46.00	-19.96	-18.80
4	2.23047	0.30	31.02	24.27	31.32	24.57	56.00	46.00	-24.68	-21.43
5	3.66016	0.36	29.88	22.48	30.24	22.84	56.00	46.00	-25.76	-23.16
6	4.85938	0.40	27.44	20.02	27.84	20.42	56.00	46.00	-28.16	-25.58

Remarks:

1. Q.P. and AV. are abbreviations of quasi-peak and average individually.
2. The emission levels of other frequencies were very low against the limit.
3. Margin value = Emission level – Limit value
4. Correction factor = Insertion loss + Cable loss
5. Emission Level = Correction Factor + Reading Value

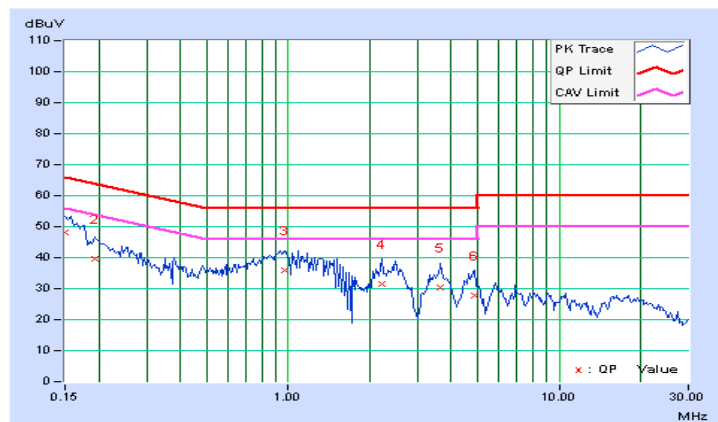

4.3 6dB Bandwidth Measurement

4.3.1 Limits of 6dB Bandwidth Measurement

The minimum of 6dB Bandwidth Measurement is 0.5 MHz.

4.3.2 Test Setup

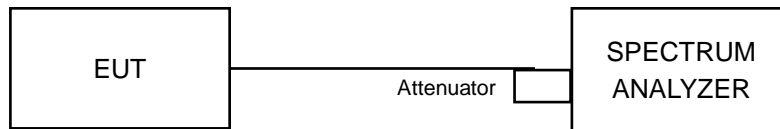

4.3.3 Test Instruments

Refer to section 4.1.2 to get information of above instrument.

4.3.4 Test Procedure

- a. Set resolution bandwidth (RBW) = 100kHz
- b. Set the video bandwidth (VBW) $\geq 3 \times$ RBW, Detector = Peak.
- c. Trace mode = max hold.
- d. Sweep = auto couple.
- e. Measure the maximum width of the emission that is constrained by the frequencies associated with the two amplitude points (upper and lower) that are attenuated by 6 dB relative to the maximum level measured in the fundamental emission

4.3.5 Deviation from Test Standard

No deviation.

4.3.6 EUT Operating Conditions

The software provided by client to enable the EUT under transmission condition continuously at lowest, middle and highest channel frequencies individually.

4.3.7 Test Result

802.11b

Channel	Frequency (MHz)	6db Bandwidth (MHz)	Minimum Limit (MHz)	Pass / Fail
1	2412	10.11	0.5	Pass
6	2437	10.07	0.5	Pass
11	2462	10.10	0.5	Pass

802.11g

Channel	Frequency (MHz)	6db Bandwidth (MHz)	Minimum Limit (MHz)	Pass / Fail
1	2412	16.59	0.5	Pass
6	2437	16.59	0.5	Pass
11	2462	16.59	0.5	Pass

802.11n (20MHz)

Channel	Frequency (MHz)	6db Bandwidth (MHz)	Minimum Limit (MHz)	Pass / Fail
1	2412	17.74	0.5	Pass
6	2437	17.75	0.5	Pass
11	2462	17.72	0.5	Pass

802.11n (40MHz)

Channel	Frequency (MHz)	6db Bandwidth (MHz)	Minimum Limit (MHz)	Pass / Fail
3	2422	36.51	0.5	Pass
6	2437	36.45	0.5	Pass
9	2452	36.48	0.5	Pass

Spectrum Plot of Worst Value

802.11b

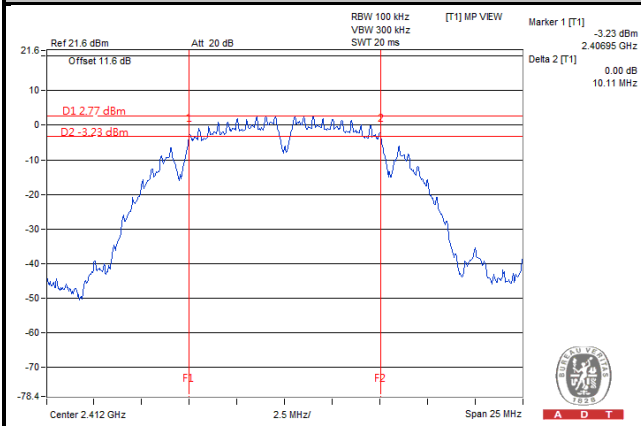

802.11g

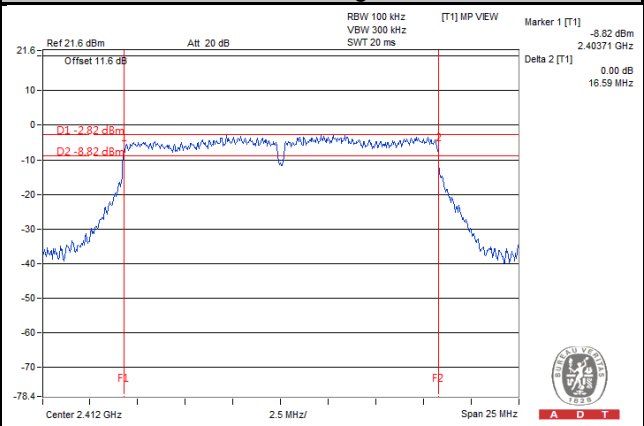

802.11n (20MHz)

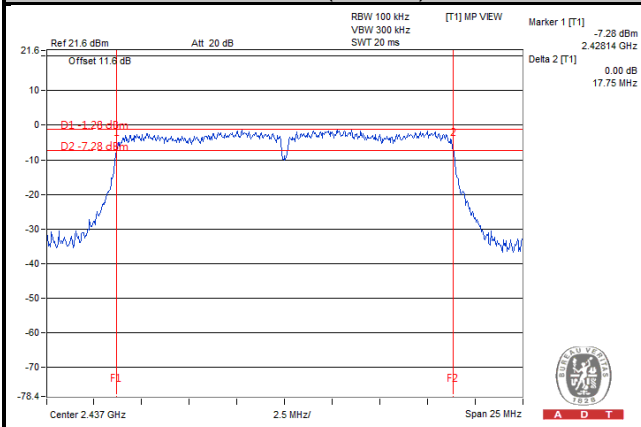

802.11n (40MHz)

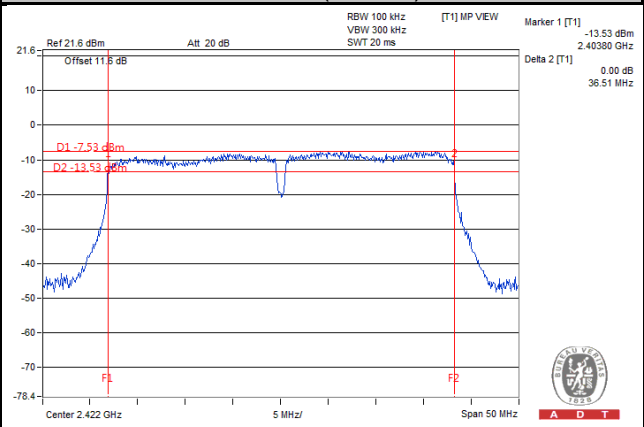

4.4 Conducted Output Power Measurement

4.4.1 Limits of Conducted Output Power Measurement

For systems using digital modulation in the 2400–2483.5 MHz bands: 1 Watt (30dBm)

4.4.2 Test Setup

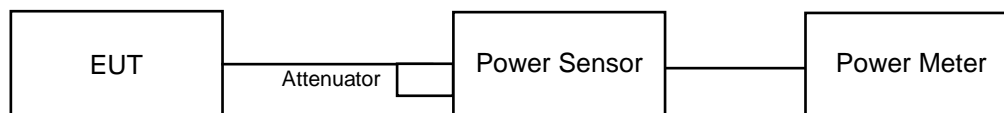

4.4.3 Test Instruments

Refer to section 4.1.2 to get information of above instrument.

4.4.4 Test Procedures

A peak power sensor was used on the output port of the EUT. A power meter was used to read the response of the peak power sensor. Record the power level.

4.4.5 Deviation from Test Standard

No deviation.

4.4.6 EUT Operating Conditions

Same as 4.3.6.

4.4.7 Test Results

802.11b

Channel	Frequency (MHz)	Peak Power (mW)	Peak Power (dBm)	Limit (dBm)	Pass / Fail
1	2412	32.36	15.1	30	Pass
6	2437	48.19	16.83	30	Pass
11	2462	50.00	16.99	30	Pass

802.11g

Channel	Frequency (MHz)	Peak Power (mW)	Peak Power (dBm)	Limit (dBm)	Pass / Fail
1	2412	115.35	20.62	30	Pass
6	2437	200.45	23.02	30	Pass
11	2462	190.55	22.8	30	Pass

802.11n (20MHz)

Channel	Frequency (MHz)	Peak Power (mW)	Peak Power (dBm)	Limit (dBm)	Pass / Fail
1	2412	114.02	20.57	30	Pass
6	2437	174.18	22.41	30	Pass
11	2462	170.22	22.31	30	Pass

802.11n (40MHz)

Channel	Frequency (MHz)	Peak Power (mW)	Peak Power (dBm)	Limit (dBm)	Pass / Fail
3	2422	109.90	20.41	30	Pass
6	2437	183.65	22.64	30	Pass
9	2452	148.25	21.71	30	Pass

4.5 Power Spectral Density Measurement

4.5.1 Limits of Power Spectral Density Measurement

The Maximum of Power Spectral Density Measurement is 8dBm.

4.5.2 Test Setup

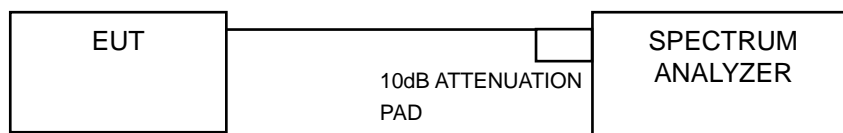

4.5.3 Test Instruments

Refer to section 4.1.2 to get information of above instrument.

4.5.4 Test Procedure

- Set analyzer center frequency to DTS channel center frequency.
- Set the span to 1.5 times the DTS bandwidth.
- Set the RBW to: $3 \text{ kHz} \leq \text{RBW} \leq 100 \text{ kHz}$.
- Set the VBW $\geq 3 \times \text{RBW}$.
- Detector = peak.
- Sweep time = auto couple.
- Trace mode = max hold.
- Allow trace to fully stabilize.
- Use the peak marker function to determine the maximum amplitude level within the RBW.

4.5.5 Deviation from Test Standard

No deviation.

4.5.6 EUT Operating Condition

Same as Item 4.3.6

4.5.7 Test Results

802.11b

Channel	Frequency (MHz)	PSD (dBm)	Limit (dBm)	Pass / Fail
1	2412	-11.17	8	Pass
6	2437	-9.87	8	Pass
11	2462	-9.84	8	Pass

802.11g

Channel	Frequency (MHz)	PSD (dBm)	Limit (dBm)	Pass / Fail
1	2412	-15.68	8	Pass
6	2437	-12.77	8	Pass
11	2462	-13.05	8	Pass

802.11n (20MHz)

Channel	Frequency (MHz)	PSD (dBm)	Limit (dBm)	Pass / Fail
1	2412	-14.56	8	Pass
6	2437	-14.70	8	Pass
11	2462	-13.69	8	Pass

802.11n (40MHz)

Channel	Frequency (MHz)	PSD (dBm)	Limit (dBm)	Pass / Fail
3	2422	-19.52	8	Pass
6	2437	-15.41	8	Pass
9	2452	-17.65	8	Pass

Spectrum Plot of Worst Value

802.11b

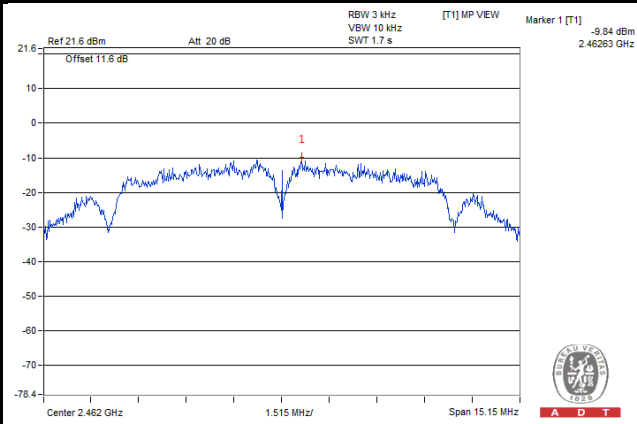

802.11g

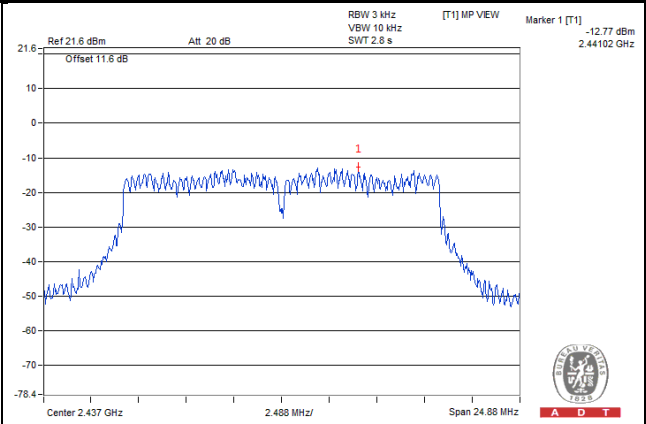

802.11n (20MHz)

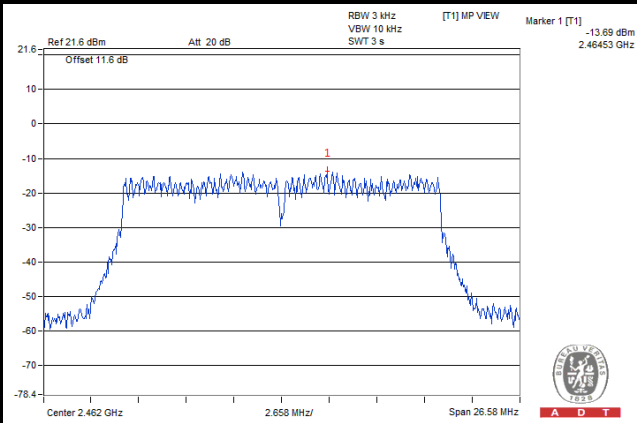

802.11n (40MHz)

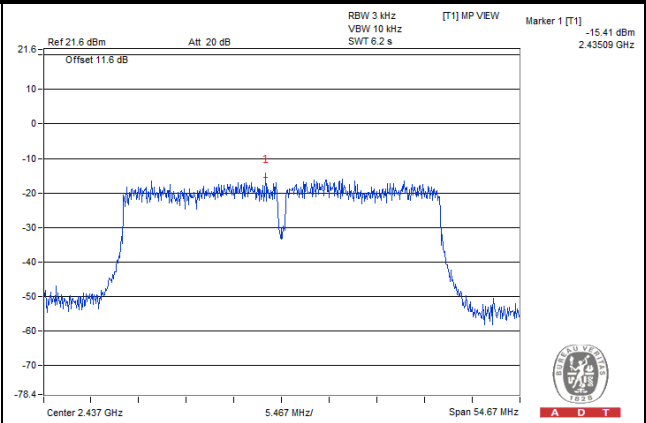

4.6 Conducted Out of Band Emission Measurement

4.6.1 Limits of Conducted Out of Band Emission Measurement

Below 20dB of the highest emission level of operating band (in 100kHz Resolution Bandwidth).

4.6.2 Test Setup

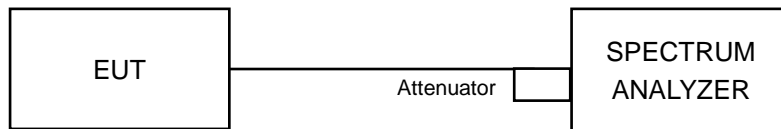

4.6.3 Test Instruments

Refer to section 4.1.2 to get information of above instrument.

4.6.4 Test Procedure

MEASUREMENT PROCEDURE REF

1. Set the RBW = 100 kHz.
2. Set the VBW \geq 300 kHz.
3. Detector = peak.
4. Sweep time = auto couple.
5. Trace mode = max hold.
6. Allow trace to fully stabilize.
7. Use the peak marker function to determine the maximum power level in any 100 kHz band segment within the fundamental EBW.

MEASUREMENT PROCEDURE OOB

1. Set RBW = 100 kHz.
2. Set VBW \geq 300 kHz.
3. Detector = peak.
4. Sweep = auto couple.
5. Trace Mode = max hold.
6. Allow trace to fully stabilize.
7. Use the peak marker function to determine the maximum amplitude level.

4.6.5 Deviation from Test Standard

No deviation.

4.6.6 EUT Operating Condition

Same as Item 4.3.6

4.6.7 Test Results

The spectrum plots are attached on the following images. D1 line indicates the highest level, and D2 line indicates the 20dB offset below D1. It shows compliance with the requirement.

802.11b

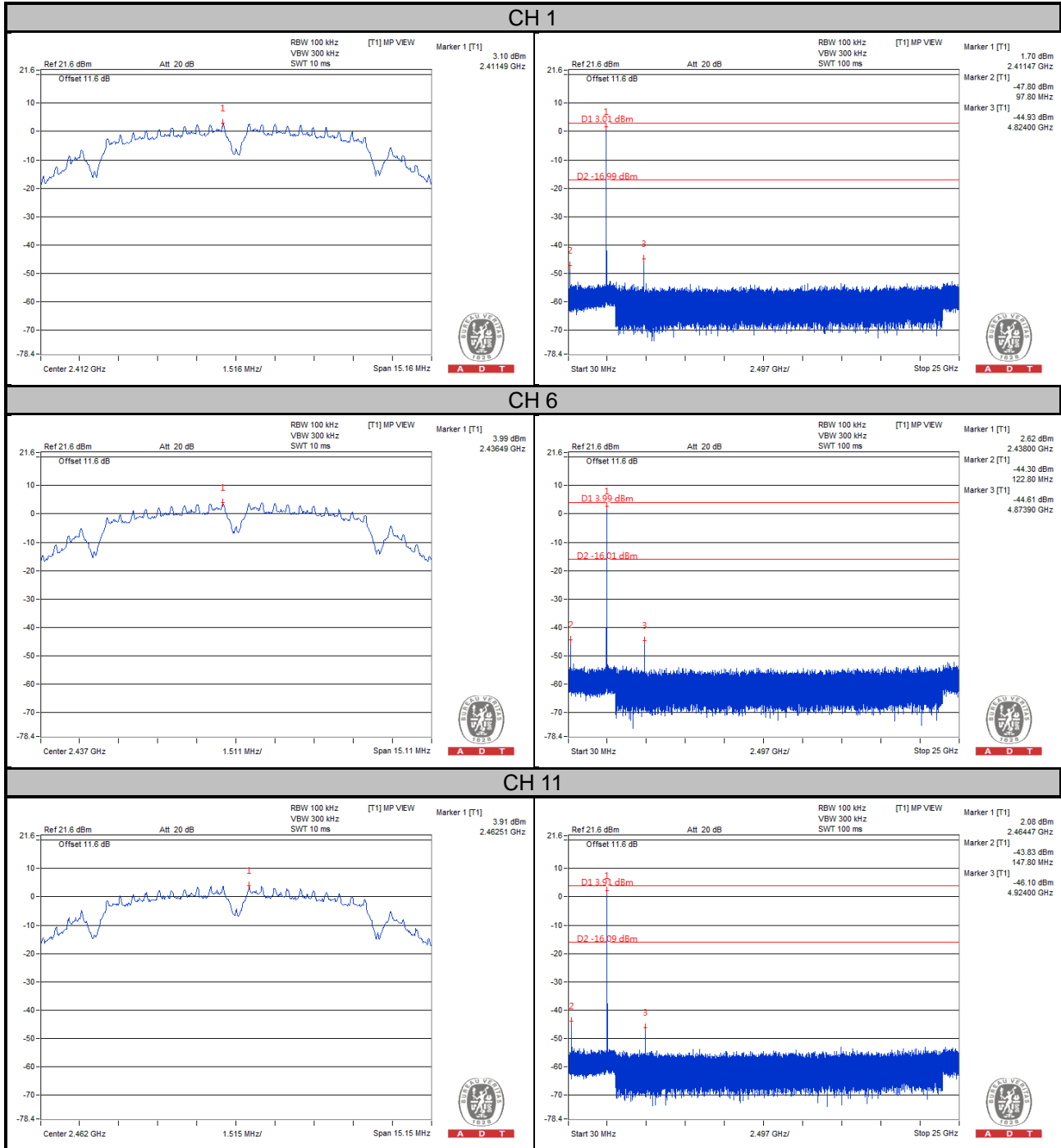

CH 1 Band Edge

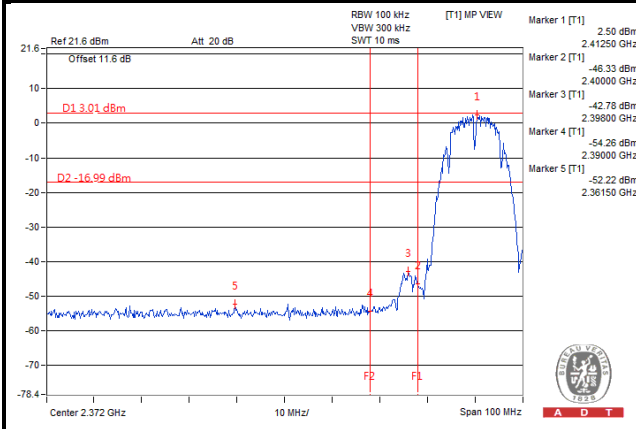

CH 11 Band Edge

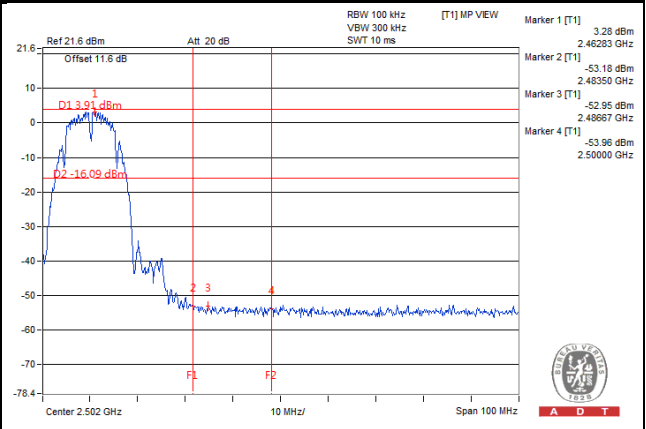

802.11g

CH 1

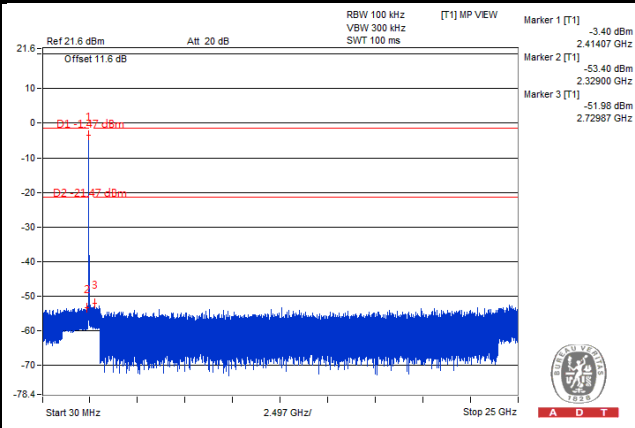
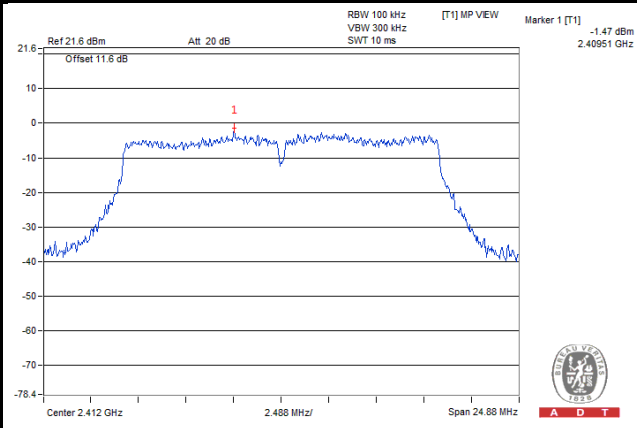

CH 6

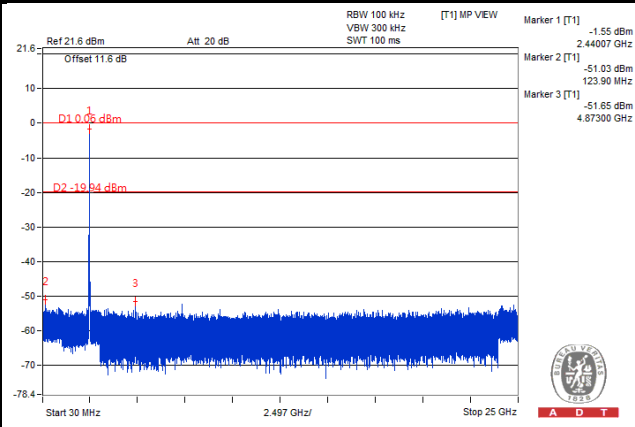
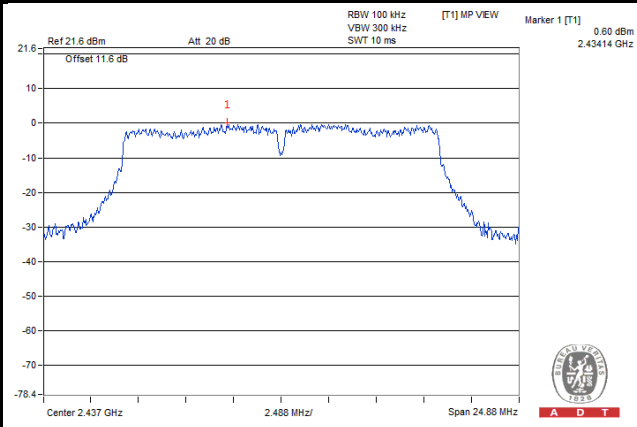

CH 11

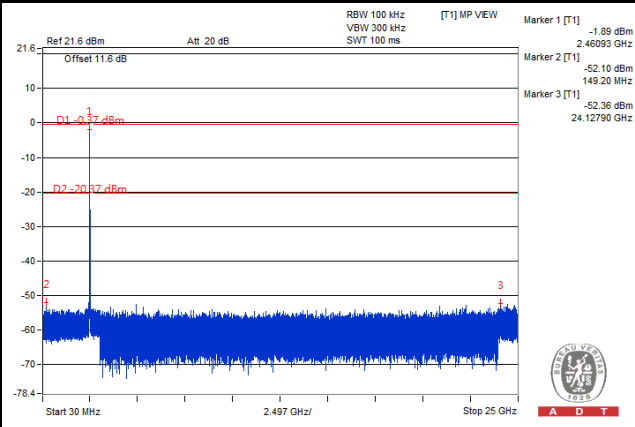
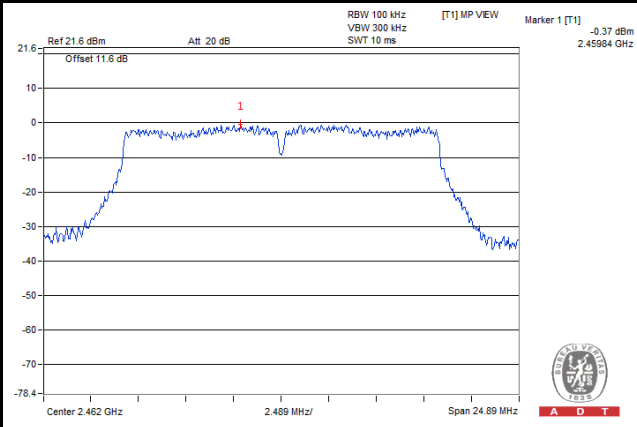

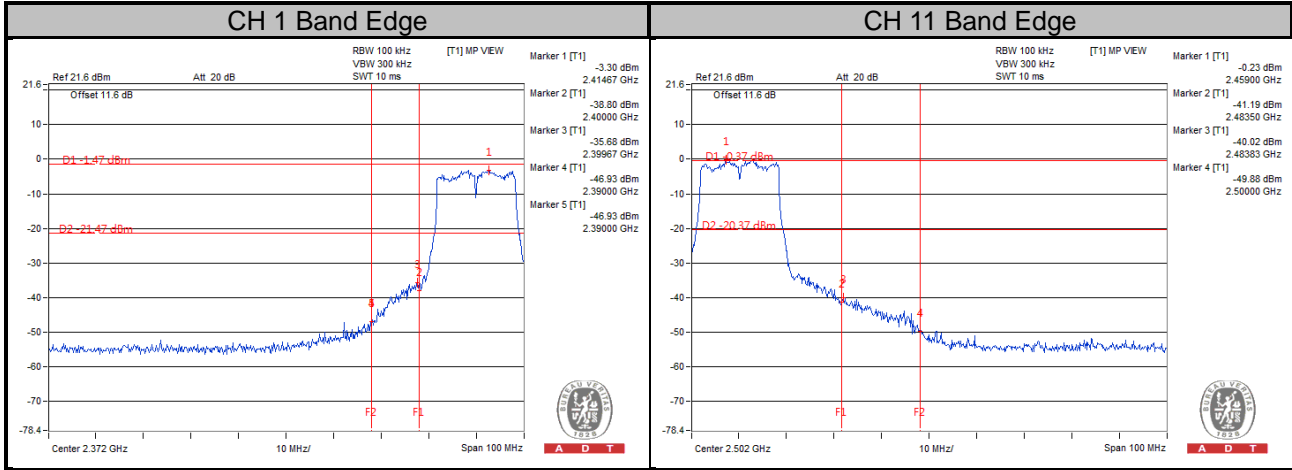

802.11n (20MHz)

CH 1

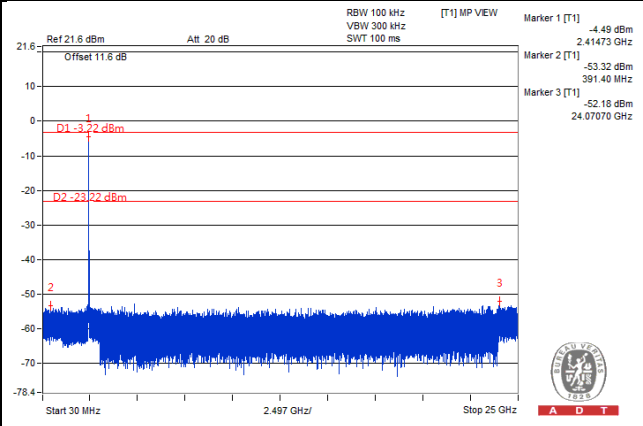
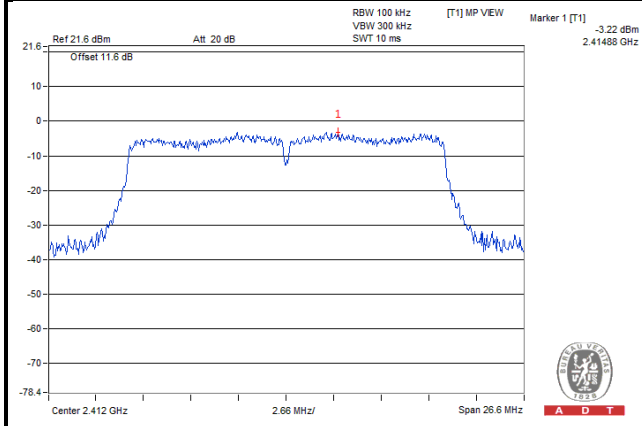

CH 6

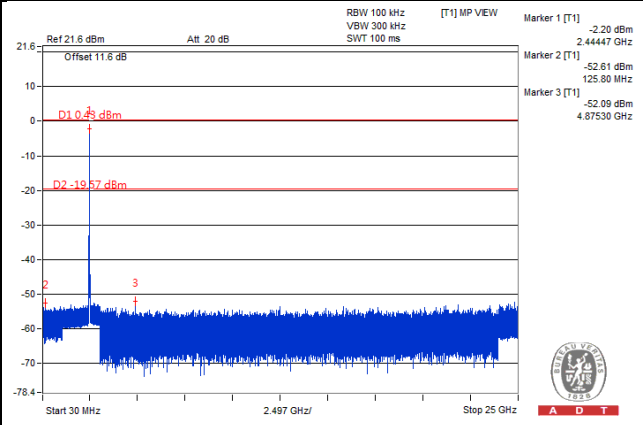
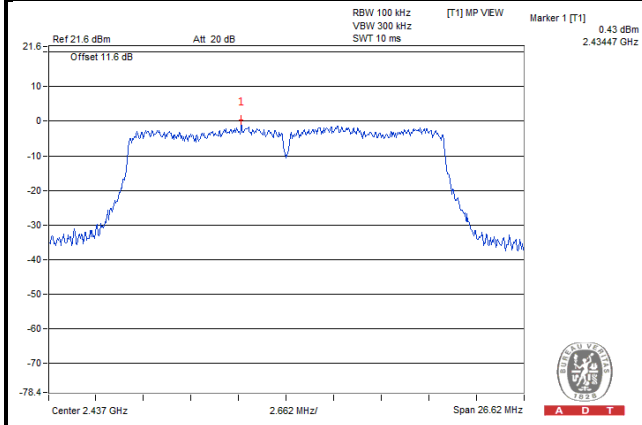

CH 11

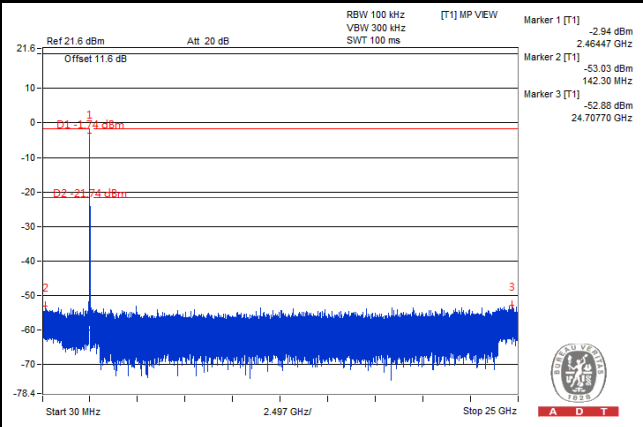
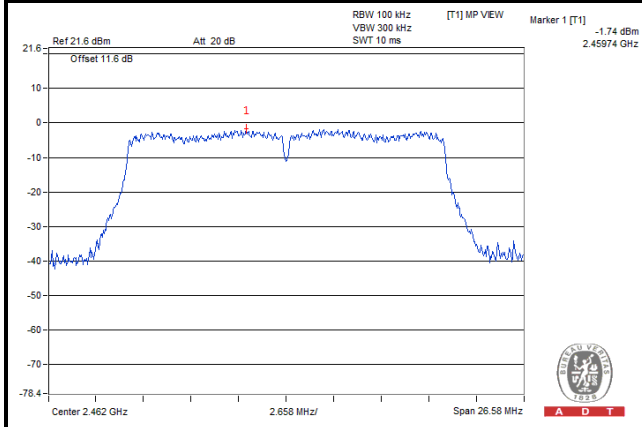

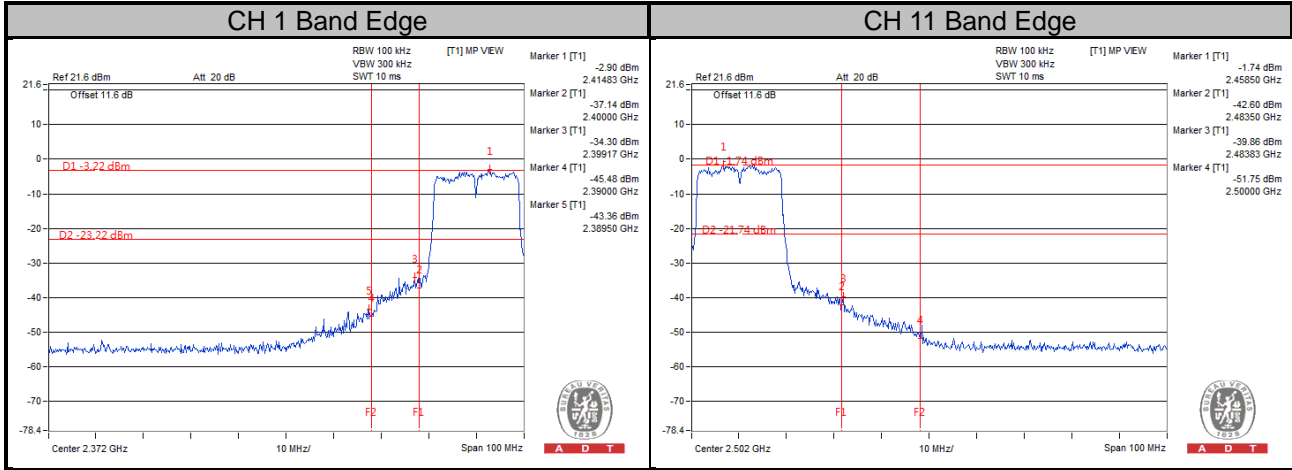

802.11n (40MHz)

CH 3

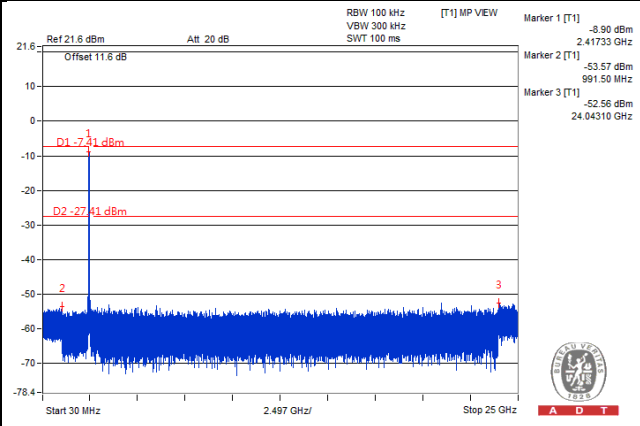
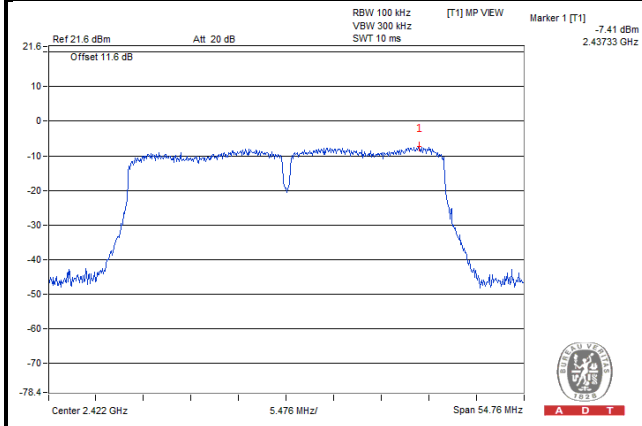

CH 6

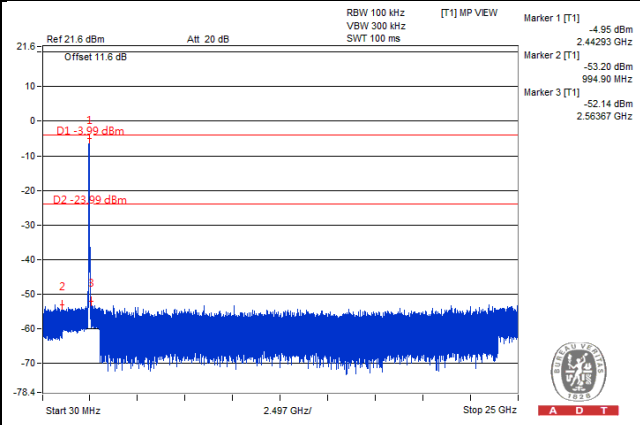
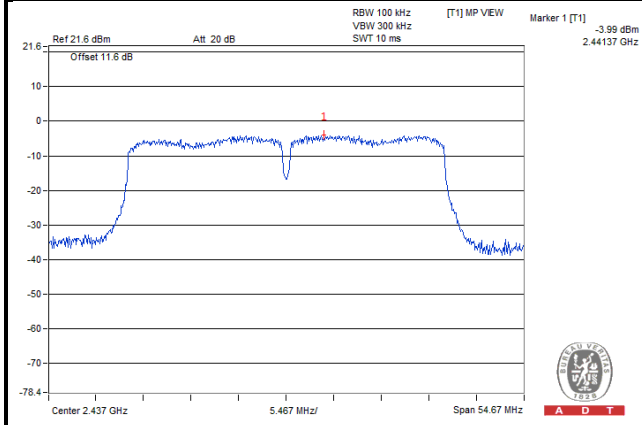

CH 9

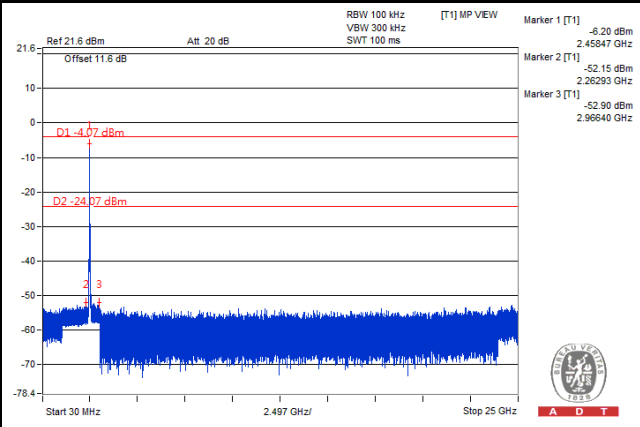
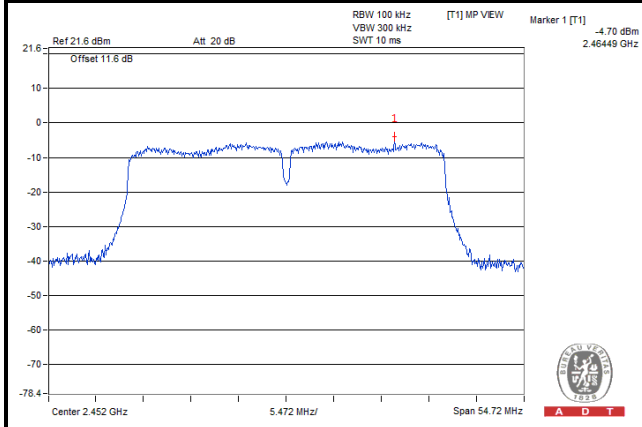

CH 3 Band Edge

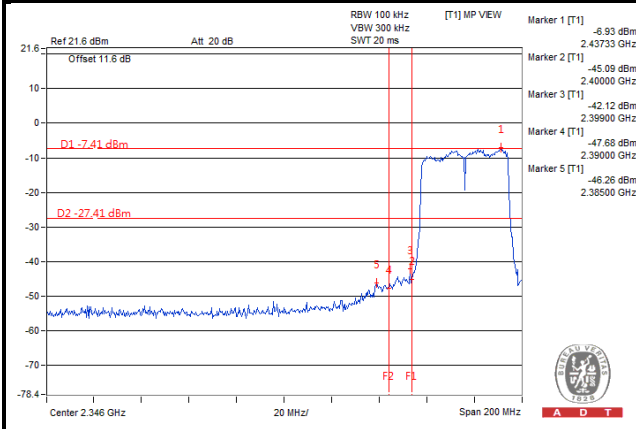

CH 9 Band Edge

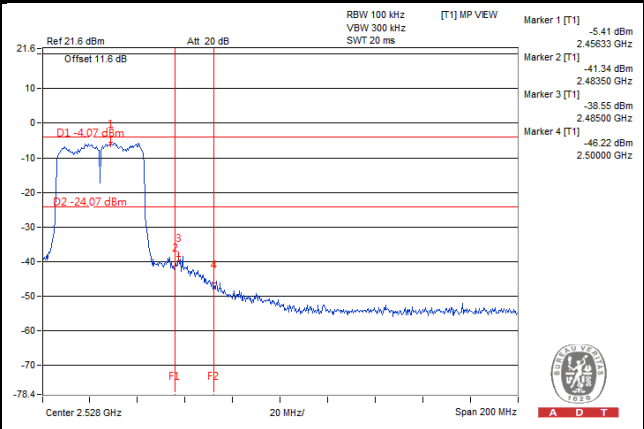



5 Pictures of Test Arrangements

Please refer to the attached file (Test Setup Photo).

Appendix – Information on the Testing Laboratories

We, Bureau Veritas Consumer Products Services (H.K.) Ltd., Taoyuan Branch, were founded in 1988 to provide our best service in EMC, Radio, Telecom and Safety consultation. Our laboratories are accredited and approved according to ISO/IEC 17025.

If you have any comments, please feel free to contact us at the following:

Linko EMC/RF Lab

Tel: 886-2-26052180

Fax: 886-2-26051924

Hsin Chu EMC/RF/Telecom Lab

Tel: 886-3-5935343

Fax: 886-3-5935342

Hwa Ya EMC/RF/Safety Lab

Tel: 886-3-3183232

Fax: 886-3-3270892

Email: service.adt@tw.bureauveritas.com

Web Site: www.bureauveritas-adt.com

The address and road map of all our labs can be found in our web site also.

--- END ---