

FCC Test Report

Report No.: RF170322C20

FCC ID: HFS-QF7

Test Model: FBG-1701

Received Date: Mar. 22, 2017

Test Date: Apr. 10, 2017 ~ Apr. 11, 2017

Issued Date: Apr. 19, 2017

Applicant: Quanta Computer Inc.

Address: No.188, Wenhua 2nd Rd., Guishan Dist., Taoyuan City 33377, Taiwan

Issued By: Bureau Veritas Consumer Products Services (H.K.) Ltd., Taoyuan Branch

Lab Address: No. 47-2, 14th Ling, Chia Pau Vil., Lin Kou Dist., New Taipei City, Taiwan
(R.O.C)

Test Location: No.19, Hwa Ya 2nd Rd., Wen Hwa Vil., Kwei Shan Dist., Taoyuan City
33383, Taiwan, R.O.C.



This report is for your exclusive use. Any copying or replication of this report to or for any other person or entity, or use of our name or trademark, is permitted only with our prior written permission. This report sets forth our findings solely with respect to the test samples identified herein. The results set forth in this report are not indicative or representative of the quality or characteristics of the lot from which a test sample was taken or any similar or identical product unless specifically and expressly noted. Our report includes all of the tests requested by you and the results thereof based upon the information that you provided to us. You have 60 days from date of issuance of this report to notify us of any material error or omission caused by our negligence, provided, however, that such notice shall be in writing and shall specifically address the issue you wish to raise. A failure to raise such issue within the prescribed time shall constitute your unqualified acceptance of the completeness of this report, the tests conducted and the correctness of the report contents. Unless specifically mentioned, the uncertainty of measurement has been explicitly taken into account to declare the compliance or non-compliance to the specification.

Table of Contents

Release Control Record	4
1 Certificate of Conformity	5
2 Summary of Test Results.....	6
2.1 Measurement Uncertainty.....	6
2.2 Modification Record	6
3 General Information	7
3.1 General Description of EUT	7
3.2 Description of Test Modes.....	8
3.2.1 Test Mode Applicability and Tested Channel Detail.....	9
3.3 Description of Support Units	11
3.3.1 Configuration of System under Test	11
3.4 General Description of Applied Standards.....	12
4 Test Types and Results	13
4.1 Radiated Emission and Bandedge Measurement	13
4.1.1 Limits of Radiated Emission and Bandedge Measurement	13
4.1.2 Test Instruments	14
4.1.3 Test Procedures.....	15
4.1.4 Deviation from Test Standard	15
4.1.5 Test Set Up	16
4.1.6 EUT Operating Conditions.....	16
4.1.7 Test Results	17
4.2 Conducted Emission Measurement.....	21
4.2.1 Limits of Conducted Emission Measurement	21
4.2.2 Test Instruments	21
4.2.3 Test Procedures.....	22
4.2.4 Deviation from Test Standard	22
4.2.5 Test Setup.....	22
4.2.6 EUT Operating Condition	22
4.2.7 Test Results	23
4.3 Number of Hopping Frequency Used	25
4.3.1 Limits of Hopping Frequency Used Measurement	25
4.3.2 Test Setup.....	25
4.3.3 Test Instruments	25
4.3.4 Test Procedure	25
4.3.5 Deviation from Test Standard	25
4.3.6 Test Results	25
4.4 Dwell Time on Each Channel.....	27
4.4.1 Limits of Dwell Time on Each Channel Measurement.....	27
4.4.2 Test Setup.....	27
4.4.3 Test Instruments	27
4.4.4 Test Procedures.....	27
4.4.5 Deviation from Test Standard	27
4.4.6 Test Results	28
4.5 Channel Bandwidth.....	31
4.5.1 Limits of Channel Bandwidth Measurement	31
4.5.2 Test Setup.....	31
4.5.3 Test Instruments	31
4.5.4 Test Procedure	31
4.5.5 Deviation from Test Standard	31
4.5.6 EUT Operating Condition	31
4.5.7 Test Results	32
4.6 Occupied Bandwidth Measurement.....	33
4.6.1 Test Setup.....	33

4.6.2	Test Instruments	33
4.6.3	Test Procedure	33
4.6.4	Deviation from Test Standard	33
4.6.5	EUT Operating Conditions	33
4.6.6	Test Results	34
4.7	Hopping Channel Separation.....	35
4.7.1	Limits of Hopping Channel Separation Measurement.....	35
4.7.2	Test Setup.....	35
4.7.3	Test Instruments	35
4.7.4	Test Procedure	35
4.7.5	Deviation from Test Standard	35
4.7.6	Test Results	36
4.8	Maximum Output Power	37
4.8.1	Limits of Maximum Output Power Measurement	37
4.8.2	Test Setup.....	37
4.8.3	Test Instruments	37
4.8.4	Test Procedure	37
4.8.5	Deviation from Test Standard	37
4.8.6	EUT Operating Condition	37
4.8.7	Test Results	38
4.9	Conducted Out of Band Emission Measurement	39
4.9.1	Limits Of Conducted Out Of Band Emission Measurement	39
4.9.2	Test Instruments	39
4.9.3	Test Procedure	39
4.9.4	Deviation from Test Standard	39
4.9.5	EUT Operating Condition	39
4.9.6	Test Results	39
5	Pictures of Test Arrangements.....	43
	Appendix – Information on the Testing Laboratories	44

Release Control Record

Issue No.	Description	Date Issued
RF170322C20	Original Release	Apr. 19, 2017

1 Certificate of Conformity

Product: Touch Panel Controller

Brand: facebook

Test Model: FBG-1701

Sample Status: Identical Prototype

Applicant: Quanta Computer Inc.

Test Date: Apr. 10, 2017 ~ Apr. 11, 2017

Standards: 47 CFR FCC Part 15, Subpart C (Section 15.247)
ANSI C63.10:2013

The above equipment has been tested by **Bureau Veritas Consumer Products Services (H.K.) Ltd., Taoyuan Branch**, and found compliance with the requirement of the above standards. The test record, data evaluation & Equipment Under Test (EUT) configurations represented herein are true and accurate accounts of the measurements of the sample's EMC characteristics under the conditions specified in this report.

Prepared by : Rona Chen , **Date:** Apr. 19, 2017
Rona Chen / Specialist

Approved by : David Huang , **Date:** Apr. 19, 2017
David Huang / Project Engineer

2 Summary of Test Results

47 CFR FCC Part 15, Subpart C (Section 15.247)			
FCC Clause	Test Item	Result	Remarks
15.207	AC Power Conducted Emission	Pass	Meet the requirement of limit. Minimum passing margin is -3.24 dB at 17.40874 MHz.
15.247(a)(1)(iii)	Number of Hopping Frequency Used	Pass	Meet the requirement of limit.
15.247(a)(1)(iii)	Dwell Time on Each Channel	Pass	Meet the requirement of limit.
15.247(a)(1)	1. Hopping Channel Separation 2. Spectrum Bandwidth of a Frequency Hopping Sequence Spread Spectrum System	Pass	Meet the requirement of limit.
15.247(b)	Maximum Peak Output Power	Pass	Meet the requirement of limit.
15.205 & 209	Radiated Emissions	Pass	Meet the requirement of limit. Minimum passing margin is -1.08 dB at 44.55 MHz.
15.247(d)	Band Edge Measurement	Pass	Meet the requirement of limit.
15.247(d)	Antenna Port Emission	Pass	Meet the requirement of limit.
15.203	Antenna Requirement	Pass	No antenna connector is used.

Note: If The Frequency Hopping System operating in 2400-2483.5 MHz band and the output power less than 125 mW. The hopping channel carrier frequencies separated by a minimum of 25 kHz or two-thirds of the 20 dB bandwidth of hopping channel whichever is greater.

2.1 Measurement Uncertainty

Where relevant, the following measurement uncertainty levels have been estimated for tests performed on the EUT:

The listed uncertainties are the worst case uncertainty for the entire range of measurement. Please note that the uncertainty values are provided for informational purposes only and are not used in determining the PASS/FAIL results.

Measurement	Frequency	Expanded Uncertainty (k=2) (±)
Conducted Emissions at mains ports	150 kHz ~ 30 MHz	2.44 dB
Radiated Emissions up to 1 GHz	30 MHz ~ 200 MHz	2.93 dB
	200 MHz ~ 1000 MHz	2.95 dB
Radiated Emissions above 1 GHz	1 GHz ~ 18 GHz	2.26 dB
	18 GHz ~ 40 GHz	1.94 dB

2.2 Modification Record

There were no modifications required for compliance.

3 General Information

3.1 General Description of EUT

Product	Touch Panel Controller
Brand	facebook
Test Model	FBG-1701
Status of EUT	Identical Prototype
Power Supply Rating	57.0 Vdc (POE)
Modulation Type	GFSK, $\pi/4$ -DQPSK, 8DPSK
Transfer Rate	1/2/3 Mbps
Operating Frequency	2402 ~ 2480 MHz
Number of Channel	79
Output Power	6.266 mW
Antenna Type	PIFA antenna with 1.19 dBi gain
Antenna Connector	N/A
Accessory Device	Refer to Note as below
Data Cable Supplied	N/A

Note:

- The EUT contains following accessory devices.

Product	Brand	Model	Description
BT Chip	Qualcomm	CSR8510	--
NFC Chip	NPX	PN7120	--

- The above EUT information is declared by manufacturer and for more detailed features description, please refer to the manufacturer's specifications or User's Manual.

3.2 Description of Test Modes

79 channels are provided to this EUT:

Channel	Freq. (MHz)	Channel	Freq. (MHz)	Channel	Freq. (MHz)	Channel	Freq. (MHz)
0	2402	20	2422	40	2442	60	2462
1	2403	21	2423	41	2443	61	2463
2	2404	22	2424	42	2444	62	2464
3	2405	23	2425	43	2445	63	2465
4	2406	24	2426	44	2446	64	2466
5	2407	25	2427	45	2447	65	2467
6	2408	26	2428	46	2448	66	2468
7	2409	27	2429	47	2449	67	2469
8	2410	28	2430	48	2450	68	2470
9	2411	29	2431	49	2451	69	2471
10	2412	30	2432	50	2452	70	2472
11	2413	31	2433	51	2453	71	2473
12	2414	32	2434	52	2454	72	2474
13	2415	33	2435	53	2455	73	2475
14	2416	34	2436	54	2456	74	2476
15	2417	35	2437	55	2457	75	2477
16	2418	36	2438	56	2458	76	2478
17	2419	37	2439	57	2459	77	2479
18	2420	38	2440	58	2460	78	2480
19	2421	39	2441	59	2461		

3.2.1 Test Mode Applicability and Tested Channel Detail

EUT Configure Mode	Applicable To				Description
	RE \geq 1G	RE<1G	PLC	APCM	
-	√	√	√	√	-

Where **RE \geq 1G**: Radiated Emission above 1 GHz **RE<1G**: Radiated Emission below 1 GHz
PLC: Power Line Conducted Emission **APCM**: Antenna Port Conducted Measurement

Note:

1. For Radiated emission test, pre-tested GFSK, $\pi/4$ -DQPSK, 8DPSK modulation type and found GFSK was the worse, therefore chosen for the final test and presented in the test report.
2. The EUT had been pre-tested on the positioned of each 3 axis. The worst case was found when positioned on **Y-plane**.
3. "-" means no effect.

Radiated Emission Test (Above 1 GHz):

- Pre-Scan has been conducted to determine the worst-case mode from all possible combinations between available modulations, data rates and antenna ports (if EUT with antenna diversity architecture).
- Following channel(s) was (were) selected for the final test as listed below.

EUT Configure Mode	Available Channel	Tested Channel	Modulation Technology	Modulation Type	Packet Type
-	0 to 78	0, 39, 78	FHSS	GFSK	DH5

Radiated Emission Test (Below 1 GHz):

- Pre-Scan has been conducted to determine the worst-case mode from all possible combinations between available modulations, data rates and antenna ports (if EUT with antenna diversity architecture).
- Following channel(s) was (were) selected for the final test as listed below.

EUT Configure Mode	Available Channel	Tested Channel	Modulation Technology	Modulation Type	Packet Type
-	0 to 78	78	FHSS	GFSK	DH5

Power Line Conducted Emission Test:

- Pre-Scan has been conducted to determine the worst-case mode from all possible combinations between available modulations, data rates and antenna ports (if EUT with antenna diversity architecture).
- Following channel(s) was (were) selected for the final test as listed below.

EUT Configure Mode	Available Channel	Tested Channel	Modulation Technology	Modulation Type	Packet Type
-	0 to 78	78	FHSS	GFSK	DH5

Antenna Port Conducted Measurement:

- This item includes all test value of each mode, but only includes spectrum plot of worst value of each mode.
- Pre-Scan has been conducted to determine the worst-case mode from all possible combinations between available modulations, data rates and antenna ports (if EUT with antenna diversity architecture).
- Following channel(s) was (were) selected for the final test as listed below.

EUT Configure Mode	Available Channel	Tested Channel	Modulation Technology	Modulation Type	Packet Type
-	0 to 78	0, 39, 78	FHSS	GFSK	DH5
-	0 to 78	0, 39, 78	FHSS	$\pi/4$ -DQPSK	DH5
-	0 to 78	0, 39, 78	FHSS	8DPSK	DH5

Test Condition:

Applicable To	Environmental Conditions	Input Power	Tested by
RE \geq 1G	25 deg. C, 65 % RH	120 Vac, 60 Hz	Gavin Wu
RE $<$ 1G	25 deg. C, 65 % RH	120 Vac, 60 Hz	Gavin Wu
PLC	25 deg. C, 65 % RH	120 Vac, 60 Hz	Getaz Yang
APCM	25 deg. C, 65 % RH	57.0 Vdc	Anson Lin

3.3 Description of Support Units

The EUT has been tested as an independent unit together with other necessary accessories or support units. The following support units or accessories were used to form a representative test configuration during the tests.

No.	Product	Brand	Model No.	Serial No.	FCC ID
1.	Bluetooth Tester	R&S	CBT	100980	N/A
2.	POE	N/A	N/A	N/A	N/A

No.	Signal Cable Description Of The Above Support Units
1.	N/A
2.	N/A

Note:

1. All power cords of the above support units are non-shielded (1.8m).
2. Item 1 acted as communication partners to transfer data.
3. Item 2 was provided by client.

3.3.1 Configuration of System under Test

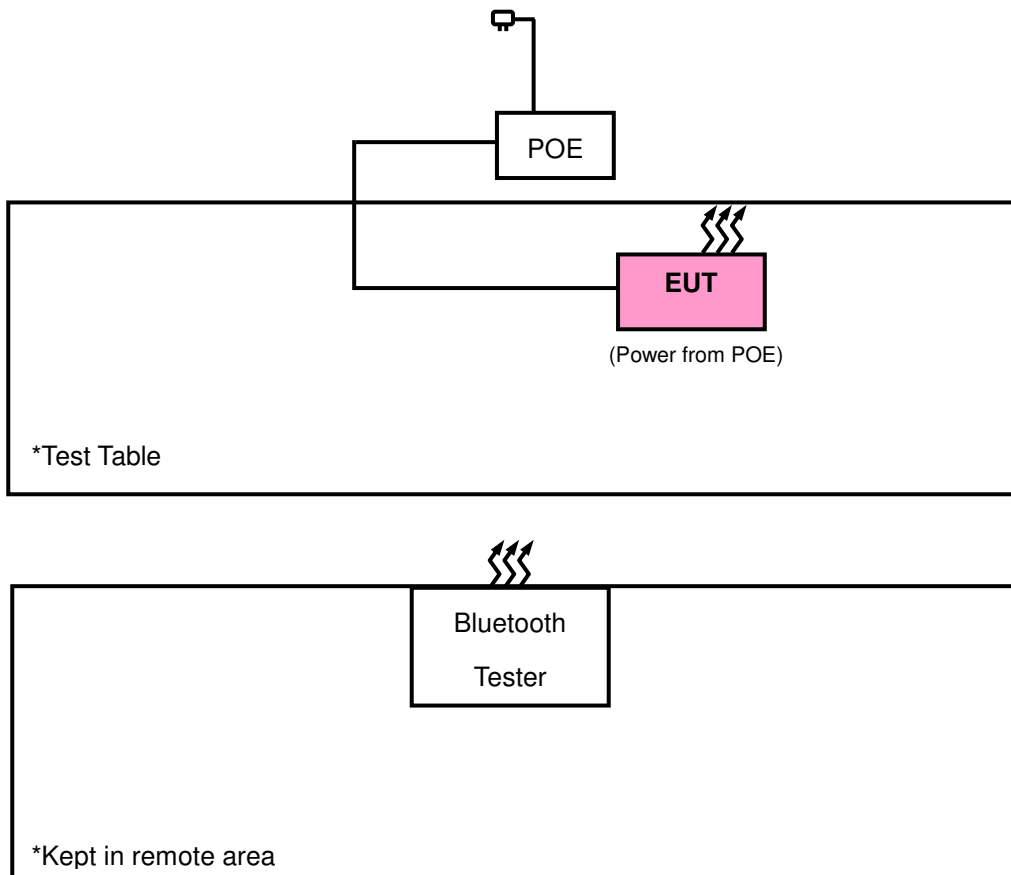

3.4 General Description of Applied Standards

The EUT is a RF Product. According to the specifications of the manufacturer, it must comply with the requirements of the following standards:

FCC Part 15, Subpart C (15.247)

FCC Public Notice DA 00-705

ANSI C63.10-2013

All test items have been performed and recorded as per the above standards.

Note: The EUT has been verified to comply with the requirements of FCC Part 15, Subpart B, Class B (DoC).
The test report has been issued separately.

4 Test Types and Results

4.1 Radiated Emission and Bandedge Measurement

4.1.1 Limits of Radiated Emission and Bandedge Measurement

Radiated emissions which fall in the restricted bands must comply with the radiated emission limits specified as below table. Other emissions shall be at least 20 dB below the highest level of the desired power:

Frequencies (MHz)	Field Strength (microvolts/meter)	Measurement Distance (meters)
0.009 ~ 0.490	2400/F (kHz)	300
0.490 ~ 1.705	24000/F (kHz)	30
1.705 ~ 30.0	30	30
30 ~ 88	100	3
88 ~ 216	150	3
216 ~ 960	200	3
Above 960	500	3

Note:

1. The lower limit shall apply at the transition frequencies.
2. Emission level (dBuV/m) = 20 log Emission level (uV/m).
3. For frequencies above 1000 MHz, the field strength limits are based on average detector, however, the peak field strength of any emission shall not exceed the maximum permitted average limits, specified above by more than 20 dB under any condition of modulation.

4.1.2 Test Instruments

Description & Manufacturer	Model No.	Serial No.	Date of Calibration	Due Date of Calibration
Test Receiver Agilent	N9038A	MY51210203	Feb. 17, 2017	Feb. 16, 2018
Spectrum Analyzer Agilent	N9010A	MY52220314	Dec. 16, 2016	Dec. 15, 2017
Spectrum Analyzer ROHDE & SCHWARZ	FSU43	101261	Dec. 13, 2016	Dec. 12, 2017
BILOG Antenna SCHWARZBECK	VULB9168	9168-472	Dec. 26, 2016	Dec. 27, 2017
HORN Antenna SCHWARZBECK	BBHA 9120 D	9120D-969	Dec. 12, 2016	Dec. 13, 2017
HORN Antenna SCHWARZBECK	BBHA 9170	9170-480	Dec. 14, 2016	Dec. 13, 2017
Fixed Attenuator Mini-Circuits	BW-N10W5+	NA	Jul. 08, 2016	Jul. 07, 2017
Loop Antenna	EM-6879	269	Aug. 11, 2016	Aug. 10, 2017
Bluetooth Tester	CBT	100980	Apr. 27, 2015	Apr. 26, 2017
Preamplifier EMCI	EMC 012645	980115	Oct. 21, 2016	Oct. 20, 2017
Preamplifier EMCI	EMC 184045	980116	Oct. 21, 2016	Oct. 20, 2017
Preamplifier EMCI	EMC 330H	980112	Oct. 21, 2016	Oct. 20, 2017
Power Meter Anritsu	ML2495A	1232002	Sep. 08, 2016	Sep. 07, 2017
Power Sensor Anritsu	MA2411B	1207325	Sep. 08, 2016	Sep. 07, 2017
RF signal cable HUBER+SUHNNER	SUCOFLEX 104	309219/4 2950114	Oct. 21, 2016	Oct. 20, 2017
RF signal cable HUBER+SUHNNER	SUCOFLEX 104	250130/4	Oct. 21, 2016	Oct. 20, 2017
RF Coaxial Cable Worken	8D-FB	Cable-Ch10-01	Oct. 21, 2016	Oct. 20, 2017
Software BV ADT	E3 6.120103	NA	NA	NA
Antenna Tower MF	MFA-440H	NA	NA	NA
Turn Table MF	MFT-201SS	NA	NA	NA
Antenna Tower & Turn Table Controller MF	MF-7802	NA	NA	NA

- Note: 1. The calibration interval of the above test instruments is 12 months and the calibrations are traceable to NML/ROC and NIST/USA.
2. The test was performed in HwaYa Chamber 10.
3. The horn antenna and preamplifier (model: EMC 184045) are used only for the measurement of emission frequency above 1 GHz if tested.
4. The FCC Site Registration No. is 690701.
5. The IC Site Registration No. is IC7450F-10.

4.1.3 Test Procedures

- a. The EUT was placed on the top of a rotating table 0.8 meters (for below 1 GHz) / 1.5 meters (for above 1 GHz) above the ground at 3 meter chamber room for test. The table was rotated 360 degrees to determine the position of the highest radiation.
- b. The EUT was set 3 meters away from the interference-receiving antenna, which was mounted on the top of a variable-height antenna tower.
- c. The height of antenna is varied from one meter to four meters above the ground to determine the maximum value of the field strength. Both horizontal and vertical polarizations of the antenna are set to make the measurement.
- d. For each suspected emission, the EUT was arranged to its worst case and then the antenna was tuned to heights from 1 meter to 4 meters and the rotatable table was turned from 0 degrees to 360 degrees to find the maximum reading.
- e. The test-receiver system was set to quasi-peak detect function and specified bandwidth with maximum hold mode when the test frequency is below 1 GHz.
- f. The test-receiver system was set to peak and average detected function and specified bandwidth with maximum hold mode when the test frequency is above 1 GHz. If the peak reading value also meets average limit, measurement with the average detector is unnecessary.

Note:

1. The resolution bandwidth and video bandwidth of test receiver/spectrum analyzer is 120 kHz & 360 kHz for Quasi-peak detection (QP) at frequency below 1 GHz.
2. The resolution bandwidth of test receiver/spectrum analyzer is 1 MHz and the video bandwidth is 3 MHz for Peak detection (PK) at frequency above 1 GHz.
3. The resolution bandwidth of test receiver/spectrum analyzer is 1 MHz and the video bandwidth is 1/T for RMS Average (Duty cycle < 98 %) for Peak detection at frequency above 1 GHz.
4. The resolution bandwidth of test receiver/spectrum analyzer is 1 MHz and the video bandwidth is 10 Hz (Duty cycle ≥ 98 %) for Average detection (AV) at frequency above 1 GHz.
5. All modes of operation were investigated and the worst-case emissions are reported.

4.1.4 Deviation from Test Standard

No deviation.

4.1.5 Test Set Up

<Frequency Range below 1 GHz>

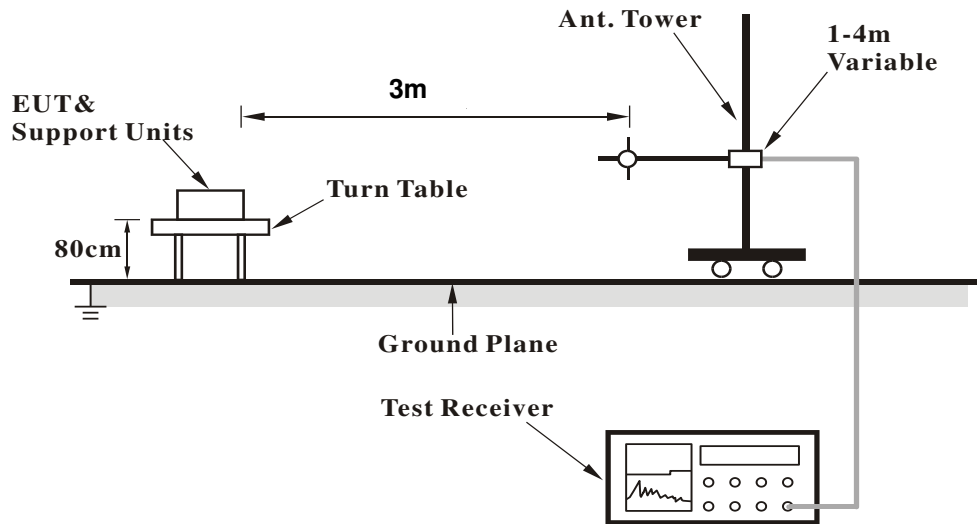

<Frequency Range above 1 GHz>

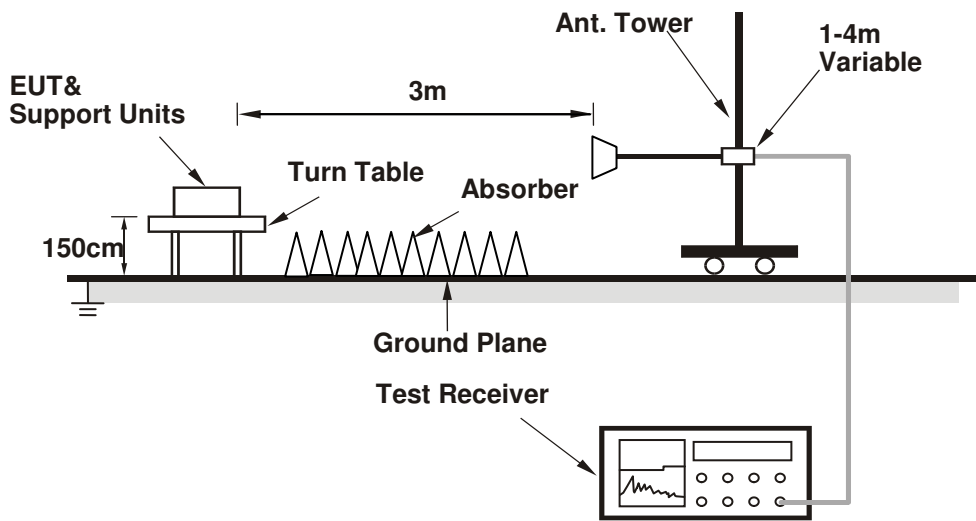

For the actual test configuration, please refer to the attached file (Test Setup Photo).

4.1.6 EUT Operating Conditions

Set the EUT under transmission condition continuously at specific channel frequency.

4.1.7 Test Results

ABOVE 1 GHz DATA :

GFSK

EUT Test Condition		Measurement Detail	
Channel	Channel 0	Frequency Range	1 GHz ~ 25 GHz
Input Power	120 Vac, 60 Hz	Detector Function	Peak (PK) Average (AV)
Environmental Conditions	25 deg. C, 65 % RH	Tested By	Gavin Wu

Antenna Polarity & Test Distance: Horizontal at 3 m										
Frequency (MHz)	Emission Level (dBuV/m)	Read Level (dBuV)	Limit (dBuV/m)	Margin (dB)	Antenna Factor (dB/m)	Cable Loss (dB)	Preamp Factor (dB)	Antenna Height (cm)	Table Angle (Degree)	Remark
2378.58	46.45	53.02	74	-27.55	26.86	4.07	37.5	159	1	Peak
2389.29	32.97	39.48	54	-21.03	26.91	4.08	37.5	159	1	Average
2402	85.31	91.83			26.91	4.09	37.52	159	1	Average
2402	96.5	103.02			26.91	4.09	37.52	159	1	Peak
4804	35.16	50.5	54	-18.84	30.97	6.79	53.1	210	73	Average
4804	45.85	61.19	74	-28.15	30.97	6.79	53.1	210	73	Peak

Antenna Polarity & Test Distance: Vertical at 3 m										
Frequency (MHz)	Emission Level (dBuV/m)	Read Level (dBuV)	Limit (dBuV/m)	Margin (dB)	Antenna Factor (dB/m)	Cable Loss (dB)	Preamp Factor (dB)	Antenna Height (cm)	Table Angle (Degree)	Remark
2312.07	46.77	53.52	74	-27.23	26.67	4.03	37.45	116	325	Peak
2388.84	33.04	39.55	54	-20.96	26.91	4.08	37.5	116	325	Average
2402	89.73	96.25			26.91	4.09	37.52	116	325	Average
2402	100.27	106.79			26.91	4.09	37.52	116	325	Peak
4804	33.63	48.97	54	-20.37	30.97	6.79	53.1	199	85	Average
4804	44.69	60.03	74	-29.31	30.97	6.79	53.1	199	85	Peak

Remarks:

- Emission Level = Read Level + Antenna Factor + Cable Loss - Preamp Factor
Margin value = Emission level – Limit value
- 2402 MHz: Fundamental frequency.

EUT Test Condition		Measurement Detail	
Channel	Channel 39	Frequency Range	1 GHz ~ 25 GHz
Input Power	120 Vac, 60 Hz	Detector Function	Peak (PK) Average (AV)
Environmental Conditions	25 deg. C, 65 % RH	Tested By	Gavin Wu

Antenna Polarity & Test Distance: Horizontal at 3 m										
Frequency (MHz)	Emission Level (dBuV/m)	Read Level (dBuV)	Limit (dBuV/m)	Margin (dB)	Antenna Factor (dB/m)	Cable Loss (dB)	Preamp Factor (dB)	Antenna Height (cm)	Table Angle (Degree)	Remark
2355.09	46.56	53.19	74	-27.44	26.81	4.05	37.49	100	68	Peak
2389.11	32.98	39.49	54	-21.02	26.91	4.08	37.5	100	68	Average
2441	85.75	91.96			27.06	4.12	37.39	100	68	Average
2441	96.96	103.17			27.06	4.12	37.39	100	68	Peak
2497.88	33.54	39.43	54	-20.46	27.2	4.16	37.25	100	68	Average
2499.2	46.97	52.86	74	-27.03	27.2	4.16	37.25	100	68	Peak
4882	36.11	51.25	54	-17.89	31.06	6.85	53.05	100	169	Average
4882	45.19	60.33	74	-28.81	31.06	6.85	53.05	100	169	Peak

Antenna Polarity & Test Distance: Vertical at 3 m										
Frequency (MHz)	Emission Level (dBuV/m)	Read Level (dBuV)	Limit (dBuV/m)	Margin (dB)	Antenna Factor (dB/m)	Cable Loss (dB)	Preamp Factor (dB)	Antenna Height (cm)	Table Angle (Degree)	Remark
2385.24	46.55	53.11	74	-27.45	26.86	4.08	37.5	118	334	Peak
2389.92	32.99	39.52	54	-21.01	26.91	4.08	37.52	118	334	Average
2441	88.52	94.73			27.06	4.12	37.39	118	334	Average
2441	99.3	105.51			27.06	4.12	37.39	118	334	Peak
2489	47.01	52.97	74	-26.99	27.2	4.16	37.32	118	334	Peak
2492.72	33.59	39.48	54	-20.41	27.2	4.16	37.25	118	334	Average
4882	34.2	49.34	54	-19.8	31.06	6.85	53.05	100	87	Average
4882	44.88	60.02	74	-29.12	31.06	6.85	53.05	100	87	Peak

Remarks:

- Emission Level = Read Level + Antenna Factor + Cable Loss - Preamp Factor
Margin value = Emission level – Limit value
- 2441 MHz: Fundamental frequency.

EUT Test Condition		Measurement Detail	
Channel	Channel 78	Frequency Range	1 GHz ~ 25 GHz
Input Power	120 Vac, 60 Hz	Detector Function	Peak (PK) Average (AV)
Environmental Conditions	25 deg. C, 65 % RH	Tested By	Gavin Wu

Antenna Polarity & Test Distance: Horizontal at 3 m										
Frequency (MHz)	Emission Level (dBuV/m)	Read Level (dBuV)	Limit (dBuV/m)	Margin (dB)	Antenna Factor (dB/m)	Cable Loss (dB)	Preamp Factor (dB)	Antenna Height (cm)	Table Angle (Degree)	Remark
2480	85.09	91.11			27.15	4.15	37.32	137	350	Average
2480	96.05	102.07			27.15	4.15	37.32	137	350	Peak
2483.52	34.21	40.23	54	-19.79	27.15	4.15	37.32	137	350	Average
2483.64	47.35	53.37	74	-26.65	27.15	4.15	37.32	137	350	Peak
4960	36.6	51.57	54	-17.4	31.16	6.91	53.04	100	158	Average
4960	45.43	60.4	74	-28.57	31.16	6.91	53.04	100	158	Peak
Antenna Polarity & Test Distance: Vertical at 3 m										
Frequency (MHz)	Emission Level (dBuV/m)	Read Level (dBuV)	Limit (dBuV/m)	Margin (dB)	Antenna Factor (dB/m)	Cable Loss (dB)	Preamp Factor (dB)	Antenna Height (cm)	Table Angle (Degree)	Remark
2480	89.31	95.33			27.15	4.15	37.32	117	335	Average
2480	100.21	106.23			27.15	4.15	37.32	117	335	Peak
2483.52	48.37	54.39	74	-25.63	27.15	4.15	37.32	117	335	Peak
2483.56	34.96	40.98	54	-19.04	27.15	4.15	37.32	117	335	Average
4960	34.9	49.87	54	-19.1	31.16	6.91	53.04	100	122	Average
4960	44.38	59.35	74	-29.62	31.16	6.91	53.04	100	122	Peak

Remarks:

- Emission Level = Read Level + Antenna Factor + Cable Loss - Preamp Factor
Margin value = Emission level – Limit value
- 2480 MHz: Fundamental frequency.

9 kHz ~ 30 MHz DATA:

The amplitude of spurious emissions attenuated more than 20 dB below the permissible value is not required to be report.

30 MHz ~ 1 GHz WORST-CASE DATA:

EUT Test Condition		Measurement Detail	
Channel	Channel 78	Frequency Range	30 MHz ~ 1 GHz
Input Power	120 Vac, 60 Hz	Detector Function	Peak (PK) Quasi-peak (QP)
Environmental Conditions	25 deg. C, 65 % RH	Tested By	Gavin Wu

Antenna Polarity & Test Distance: Horizontal at 3 m										
Frequency (MHz)	Emission Level (dBuV/m)	Read Level (dBuV)	Limit (dBuV/m)	Margin (dB)	Antenna Factor (dB/m)	Cable Loss (dB)	Preamp Factor (dB)	Antenna Height (cm)	Table Angle (Degree)	Remark
44.55	29.55	46.42	40	-10.45	13.6	0.67	31.14	117	103	Peak
114.39	28.39	48.68	43.5	-15.11	10.46	1.12	31.87	108	341	Peak
130.88	24.77	43.74	43.5	-18.73	11.75	1.14	31.86	129	165	Peak
225.94	35.5	55.44	46	-10.5	10.46	1.4	31.8	126	138	Peak
450.01	29.37	43.03	46	-16.63	16.33	1.99	31.98	131	31	Peak
499.48	30.43	42.66	46	-15.57	17.31	2.09	31.63	111	75	Peak
Antenna Polarity & Test Distance: Vertical at 3 m										
Frequency (MHz)	Emission Level (dBuV/m)	Read Level (dBuV)	Limit (dBuV/m)	Margin (dB)	Antenna Factor (dB/m)	Cable Loss (dB)	Preamp Factor (dB)	Antenna Height (cm)	Table Angle (Degree)	Remark
44.55	38.92	55.79	40	-1.08	13.6	0.67	31.14	100	12	QP
54.25	35.32	53.35	40	-4.68	12.56	0.74	31.33	100	89	QP
127.97	33.26	52.45	43.5	-10.24	11.55	1.14	31.88	110	134	Peak
232.73	30.73	50.4	46	-15.27	10.75	1.42	31.84	139	178	Peak
443.22	30.7	44.51	46	-15.3	16.2	1.98	31.99	113	185	Peak
729.37	33.48	41.35	46	-12.52	21.23	2.5	31.6	108	281	Peak

Remarks:

- Emission Level = Read Level + Antenna Factor + Cable Loss - Preamp Factor
Margin value = Emission level – Limit value

4.2 Conducted Emission Measurement

4.2.1 Limits of Conducted Emission Measurement

Frequency (MHz)	Conducted Limit (dBuV)	
	Quasi-peak	Average
0.15 - 0.5	66 - 56	56 - 46
0.50 - 5.0	56	46
5.0 - 30.0	60	50

- Note: 1. The lower limit shall apply at the transition frequencies.
 2. The limit decreases in line with the logarithm of the frequency in the range of 0.15 to 0.50 MHz.
 3. All emanations from a class A/B digital device or system, including any network of conductors and apparatus connected thereto, shall not exceed the level of field strengths specified above.

4.2.2 Test Instruments

Description & Manufacturer	Model No.	Serial No.	Date Of Calibration	Due Date Of Calibration
Test Receiver ROHDE & SCHWARZ	ESCI	100613	Nov. 21, 2016	Nov. 20, 2017
RF signal cable (with 10dB PAD) Woken	5D-FB	Cable-cond1-01	Dec. 22, 2016	Dec. 21, 2017
LISN ROHDE & SCHWARZ (EUT)	ESH3-Z5	835239/001	Mar. 10, 2017	Mar. 09, 2018
LISN ROHDE & SCHWARZ (Peripheral)	ESH3-Z5	100311	Jul. 28, 2016	Jul. 27, 2017
Software ADT	BV ADT_Cond_ V7.3.7.3	NA	NA	NA

- Note: 1. The calibration interval of the above test instruments is 12 months and the calibrations are traceable to NML/ROC and NIST/USA.
 2. The test was performed in HwaYa Shielded Room 1.
 3. The VCCI Site Registration No. is C-2040.

4.2.3 Test Procedures

- a. The EUT was placed 0.4 meters from the conducting wall of the shielded room with EUT being connected to the power mains through a line impedance stabilization network (LISN). Other support units were connected to the power mains through another LISN. The two LISNs provide 50 ohm/ 50 uH of coupling impedance for the measuring instrument.
- b. Both lines of the power mains connected to the EUT were checked for maximum conducted interference.
- c. The frequency range from 150 kHz to 30 MHz was searched. Emission levels under (Limit – 20 dB) was not recorded.

Note: All modes of operation were investigated and the worst-case emissions are reported.

4.2.4 Deviation from Test Standard

No deviation.

4.2.5 Test Setup

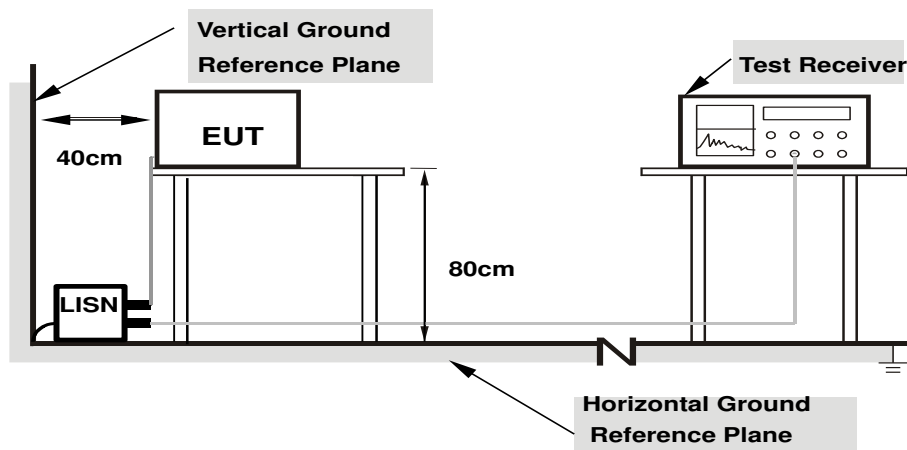

- Note:**
- 1.Support units were connected to second LISN.
 - 2.Both of LISNs (AMN) are 80 cm from EUT and at least 80 from other units and other metal planes

For the actual test configuration, please refer to the attached file (Test Setup Photo).

4.2.6 EUT Operating Condition

Set the EUT under transmission condition continuously at specific channel frequency.

4.2.7 Test Results

CONDUCTED WORST-CASE DATA : GFSK

Frequency Range	150kHz ~ 30MHz	Detector Function & Resolution Bandwidth	Quasi-Peak (QP) / Average (AV), 9kHz
Input Power	120Vac, 60Hz	Environmental Conditions	25°C, 65%RH
Tested by	Getaz Yang	Test Date	2017/4/11

Phase Of Power : Line (L)										
No	Frequency (MHz)	Correction Factor (dB)	Reading Value (dBuV)		Emission Level (dBuV)		Limit (dBuV)		Margin (dB)	
			Q.P.	AV.	Q.P.	AV.	Q.P.	AV.	Q.P.	AV.
1	0.16922	10.35	37.64	26.27	47.99	36.62	65.00	55.00	-17.01	-18.38
2	0.22434	10.37	28.45	15.45	38.82	25.82	62.66	52.66	-23.84	-26.84
3	0.25166	10.38	25.64	13.95	36.02	24.33	61.70	51.70	-25.68	-27.37
4	0.38910	10.40	29.54	21.74	39.94	32.14	58.08	48.08	-18.14	-15.94
5	0.45937	10.40	25.88	14.66	36.28	25.06	56.70	46.70	-20.42	-21.64
6	17.40874	11.22	35.81	35.54	47.03	46.76	60.00	50.00	-12.97	-3.24

Remarks:

1. Q.P. and AV. are abbreviations of quasi-peak and average individually.
2. The emission levels of other frequencies were very low against the limit.
3. Margin value = Emission level – Limit value
4. Correction factor = Insertion loss + Cable loss
5. Emission Level = Correction Factor + Reading Value

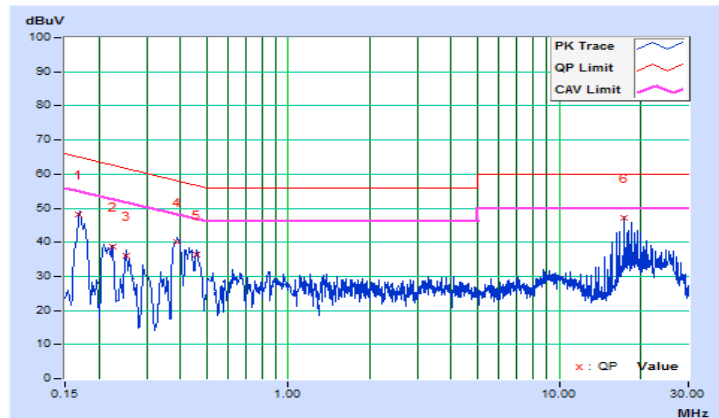

Frequency Range	150kHz ~ 30MHz	Detector Function & Resolution Bandwidth	Quasi-Peak (QP) / Average (AV), 9kHz
Input Power	120Vac, 60Hz	Environmental Conditions	25°C, 65%RH
Tested by	Getaz Yang	Test Date	2017/4/11

Phase Of Power : Neutral (N)										
No	Frequency (MHz)	Correction Factor (dB)	Reading Value (dBuV)		Emission Level (dBuV)		Limit (dBuV)		Margin (dB)	
			Q.P.	AV.	Q.P.	AV.	Q.P.	AV.	Q.P.	AV.
1	0.17346	10.12	36.28	26.06	46.40	36.18	64.79	54.79	-18.39	-18.61
2	0.21647	10.14	30.22	20.92	40.36	31.06	62.95	52.95	-22.59	-21.89
3	0.39013	10.16	28.07	20.26	38.23	30.42	58.06	48.06	-19.83	-17.64
4	0.44624	10.16	25.55	16.04	35.71	26.20	56.94	46.94	-21.23	-20.74
5	17.40483	10.86	36.03	35.85	46.89	46.71	60.00	50.00	-13.11	-3.29
6	18.40970	10.90	34.39	34.16	45.29	45.06	60.00	50.00	-14.71	-4.94

Remarks:

1. Q.P. and AV. are abbreviations of quasi-peak and average individually.
2. The emission levels of other frequencies were very low against the limit.
3. Margin value = Emission level – Limit value
4. Correction factor = Insertion loss + Cable loss
5. Emission Level = Correction Factor + Reading Value

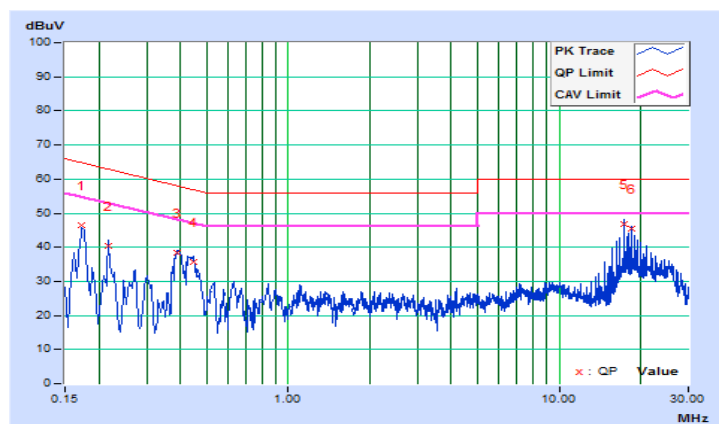

4.3 Number of Hopping Frequency Used

4.3.1 Limits of Hopping Frequency Used Measurement

At least 15 channels frequencies, and should be equally spaced.

4.3.2 Test Setup

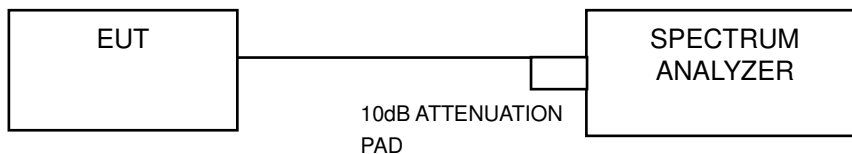

4.3.3 Test Instruments

Refer to section 4.1.2 to get information of above instrument.

4.3.4 Test Procedure

- Check the calibration of the measuring instrument (SA) using either an internal calibrator or a known signal from an external generator.
- Turn on the EUT and connect its antenna terminal to measurement via a low loss cable. Then set it to any one measured frequency within its operating range and make sure the instrument is operated in its linear range.
- Set the SA on MaxHold Mode, and then keep the EUT in hopping mode. Record all the signals from each channel until each one has been recorded.
- Set the SA on View mode and then plot the result on SA screen.
- Repeat above procedures until all frequencies measured were complete.

4.3.5 Deviation from Test Standard

No deviation.

4.3.6 Test Results

There are 79 hopping frequencies in the hopping mode. Please refer to next page for the test result. On the plots, it shows that the hopping frequencies are equally spaced.

GFSK



4.4 Dwell Time on Each Channel

4.4.1 Limits of Dwell Time on Each Channel Measurement

The average time of occupancy on any channel shall not be greater than 0.4 seconds within a period of 0.4 seconds multiplied by the number of hopping channels employed.

4.4.2 Test Setup

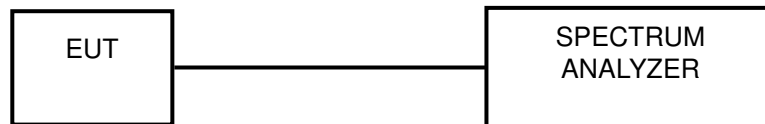

4.4.3 Test Instruments

Refer to section 4.1.2 to get information of above instrument.

4.4.4 Test Procedures

- a. Check the calibration of the measuring instrument (SA) using either an internal calibrator or a known signal from an external generator.
- b. Turn on the EUT and connect its antenna terminal to measurement via a low loss cable. Then set it to any one measured frequency within its operating range and make sure the instrument is operated in its linear range.
- c. Adjust the center frequency of SA on any frequency be measured and set SA to zero span mode. And then, set RBW and VBW of spectrum analyzer to proper value.
- d. Measure the time duration of one transmission on the measured frequency. And then plot the result with time difference of this time duration.
- e. Repeat above procedures until all different time-slot modes have been completed.

4.4.5 Deviation from Test Standard

No deviation.

4.4.6 Test Results

GFSK

Mode	Number of transmission in a 31.6 (79 Hopping*0.4)	Length of transmission time (msec)	Result (msec)	Limit (sec)
DH1	50 (times / 5 sec) * 6.32 = 316 times	0.447	141.3	0.4
DH3	26 (times / 5 sec) * 6.32 = 164.32 times	1.698	279	0.4
DH5	16 (times / 5 sec) * 6.32 = 101.12 times	2.98	301.3	0.4

Note: Test plots of the transmitting time slot are shown as below.



π/4-DQPSK

Mode	Number of transmission in a 31.6 (79 Hopping*0.4)	Length of transmission time (msec)	Result (msec)	Limit (sec)
2DH1	50 (times / 5 sec) * 6.32 = 316 times	0.443	140	0.4
2DH3	27 (times / 5 sec) * 6.32 = 170.64 times	1.73	295.2	0.4
2DH5	16 (times / 5 sec) * 6.32 = 101.12 times	2.972	300.5	0.4

Note: Test plots of the transmitting time slot are shown as below.

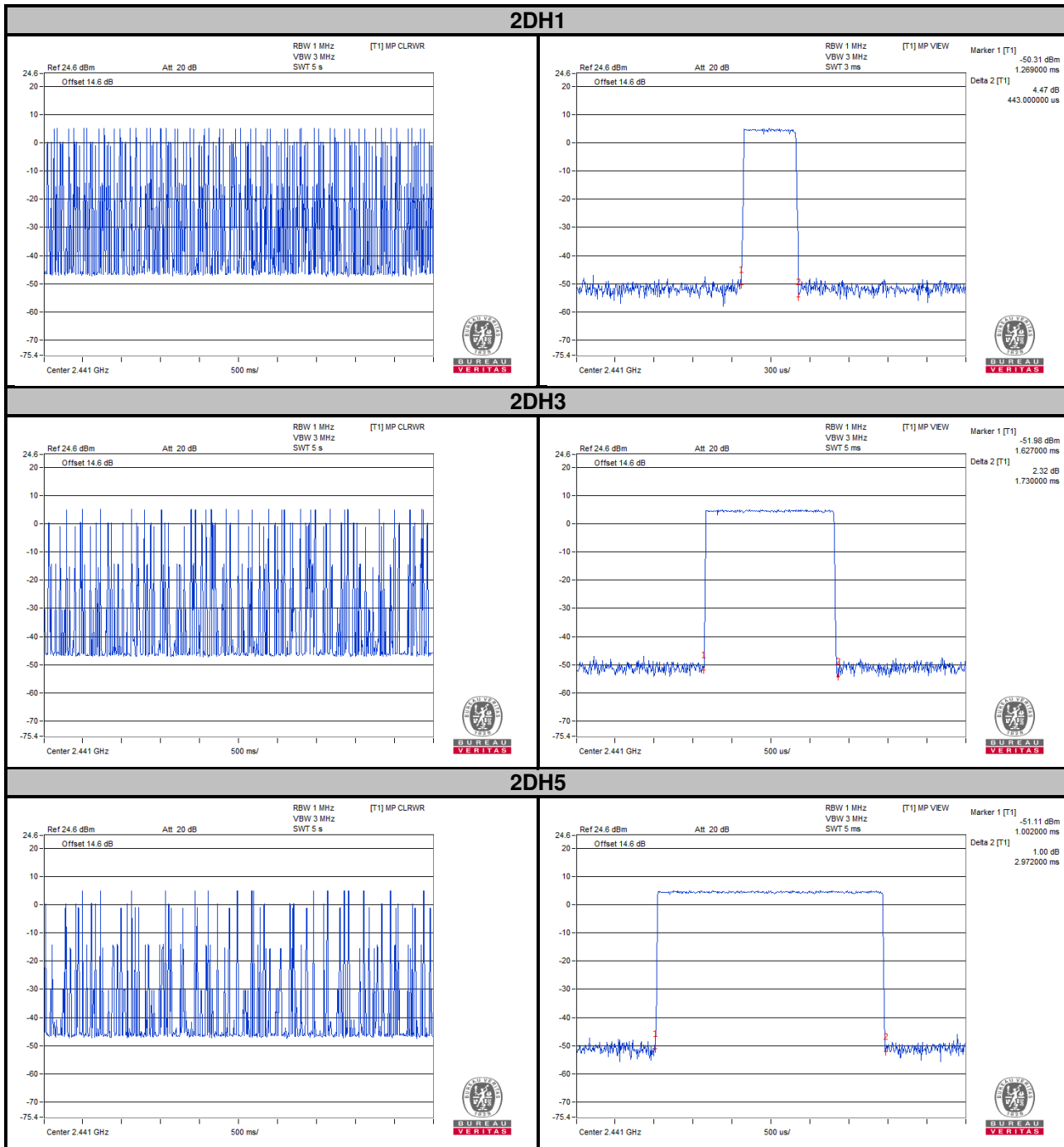

8DPSK

Mode	Number of transmission in a 31.6 (79 Hopping*0.4)	Length of transmission time (msec)	Result (msec)	Limit (sec)
3DH1	50 (times / 5 sec) * 6.32 = 316 times	0.461	145.7	0.4
3DH3	27 (times / 5 sec) * 6.32 = 170.64 times	1.738	296.6	0.4
3DH5	17 (times / 5 sec) * 6.32 = 107.44 times	3.012	323.6	0.4

Note: Test plots of the transmitting time slot are shown as below.

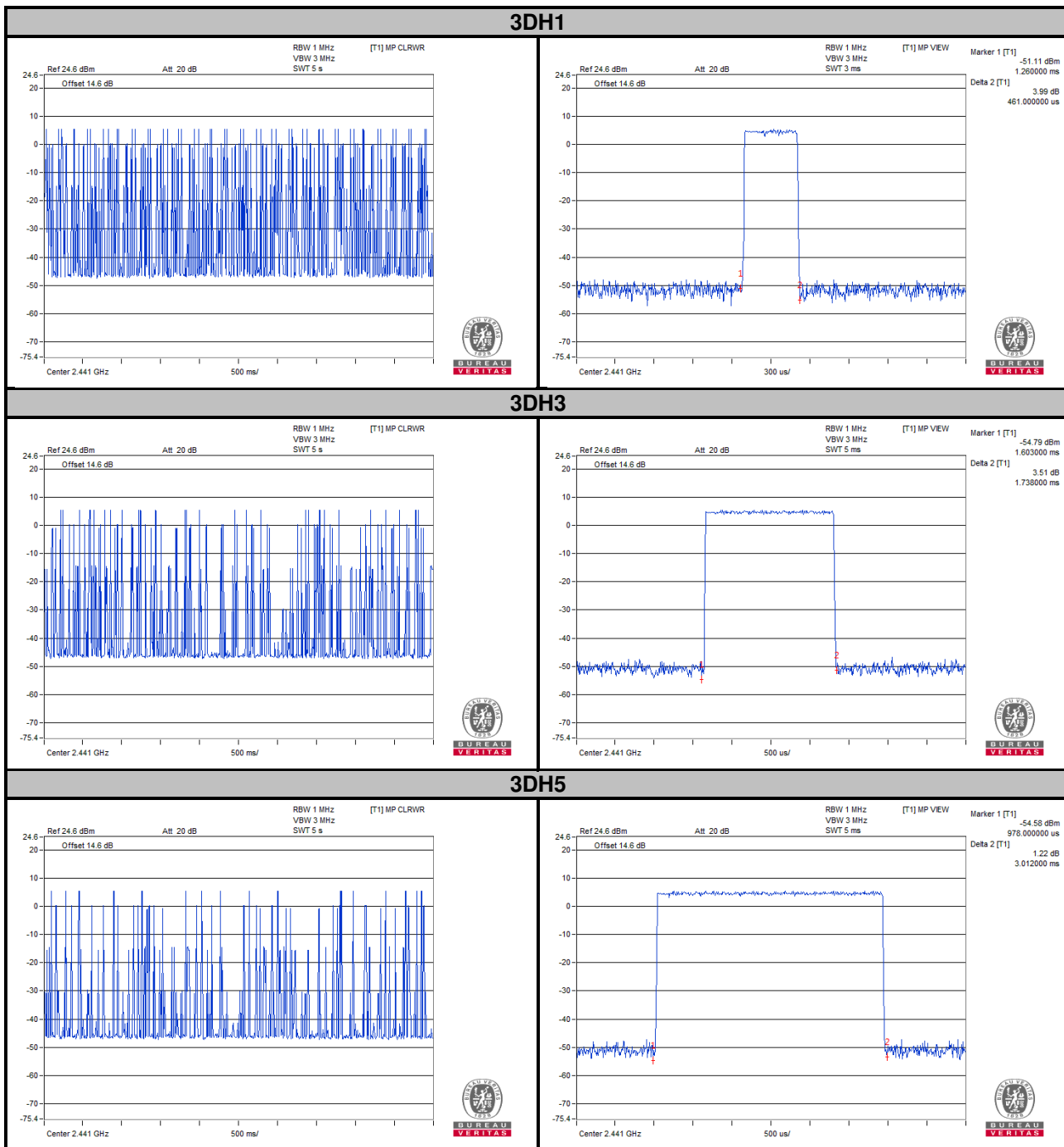

4.5 Channel Bandwidth

4.5.1 Limits of Channel Bandwidth Measurement

For frequency hopping system operating in the 2400-2483.5 MHz, if the 20 dB bandwidth of hopping channel is greater than 25 kHz, two-thirds 20 dB bandwidth of hopping channel shall be a minimum limit for the hopping channel separation.

4.5.2 Test Setup

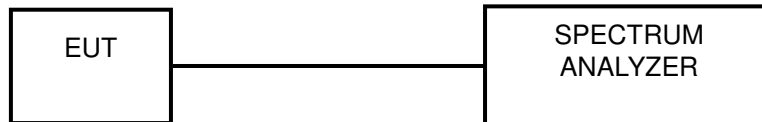

4.5.3 Test Instruments

Refer to section 4.1.2 to get information of above instrument.

4.5.4 Test Procedure

- a. Check the calibration of the measuring instrument using either an internal calibrator or a known signal from an external generator.
- b. Turn on the EUT and connect it to measurement instrument. Then set it to any one convenient frequency within its operating range. Set a reference level on the measuring instrument equal to the highest peak value.
- c. Measure the frequency difference of two frequencies that were attenuated 20 dB from the reference level. Record the frequency difference as the emission bandwidth.
- d. Repeat above procedures until all frequencies measured were complete.

4.5.5 Deviation from Test Standard

No deviation.

4.5.6 EUT Operating Condition

The software provided by client enabled the EUT to transmit and receive data at lowest, middle and highest channel frequencies individually.

4.5.7 Test Results

Channel	Frequency (MHz)	20 dB Bandwidth (MHz)		
		GFSK	$\pi/4$ -DQPSK	8DPSK
0	2402	0.94	1.29	1.26
39	2441	0.94	1.29	1.26
78	2480	0.94	1.29	1.26

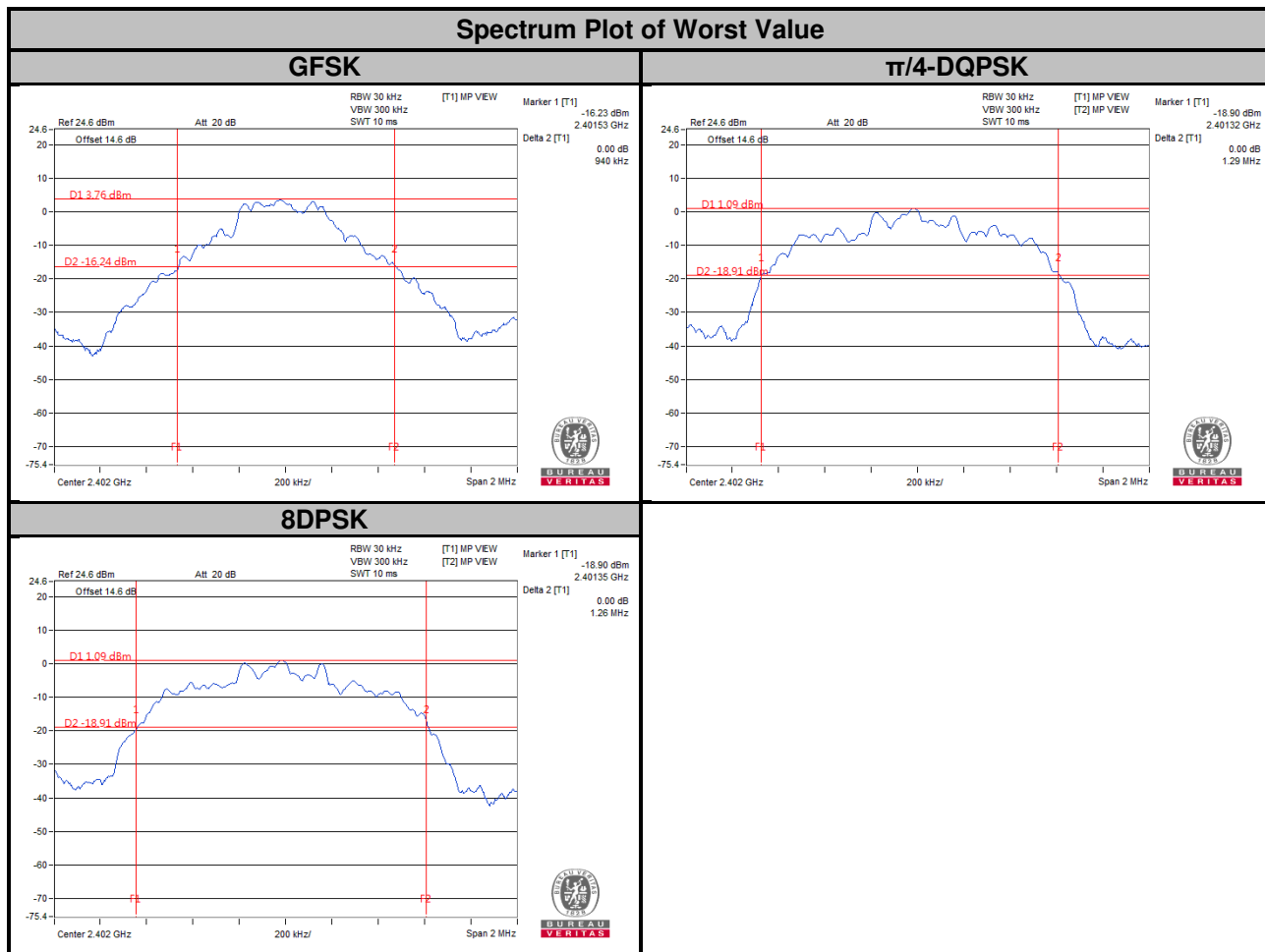

4.6 Occupied Bandwidth Measurement

4.6.1 Test Setup

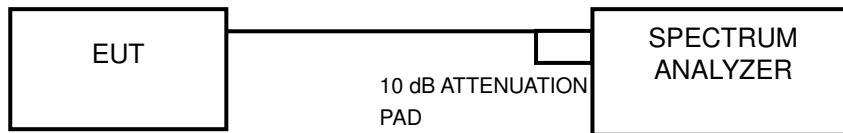

4.6.2 Test Instruments

Refer to section 4.1.2 to get information of above instrument

4.6.3 Test Procedure

The transmitter output was connected to the spectrum analyzer through an attenuator. The bandwidth of the fundamental frequency was measured by spectrum analyzer with resolution bandwidth in the range of 1 % to 5 % of the anticipated emission bandwidth, and a video bandwidth at least 3x the resolution bandwidth and set the detector to PEAK. The width of a frequency band such that, below the lower and above the upper frequency limits, the mean powers emitted are each equal to a specified percentage 0.5 % of the total mean power of a given emission.

4.6.4 Deviation from Test Standard

No deviation.

4.6.5 EUT Operating Conditions

The software provided by client to enable the EUT under transmission condition continuously at lowest, middle and highest channel frequencies individually.

4.6.6 Test Results

Channel	Frequency (MHz)	Occupied Bandwidth (MHz)		
		GFSK	$\pi/4$ -DQPSK	8DPSK
0	2402	0.85	1.16	1.14
39	2441	0.85	1.16	1.15
78	2480	0.85	1.16	1.15

Spectrum Plot of Worst Value

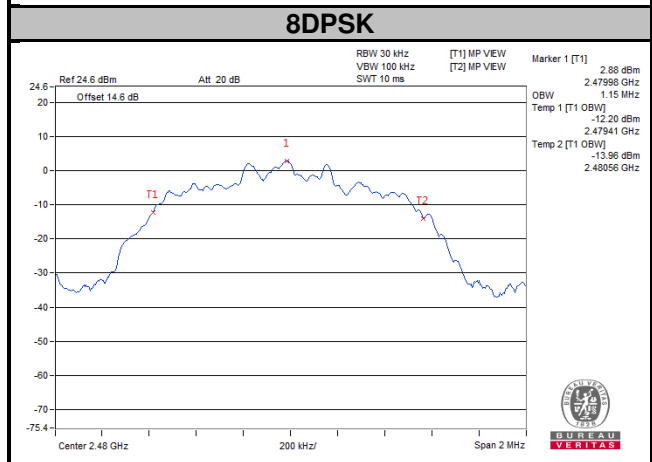
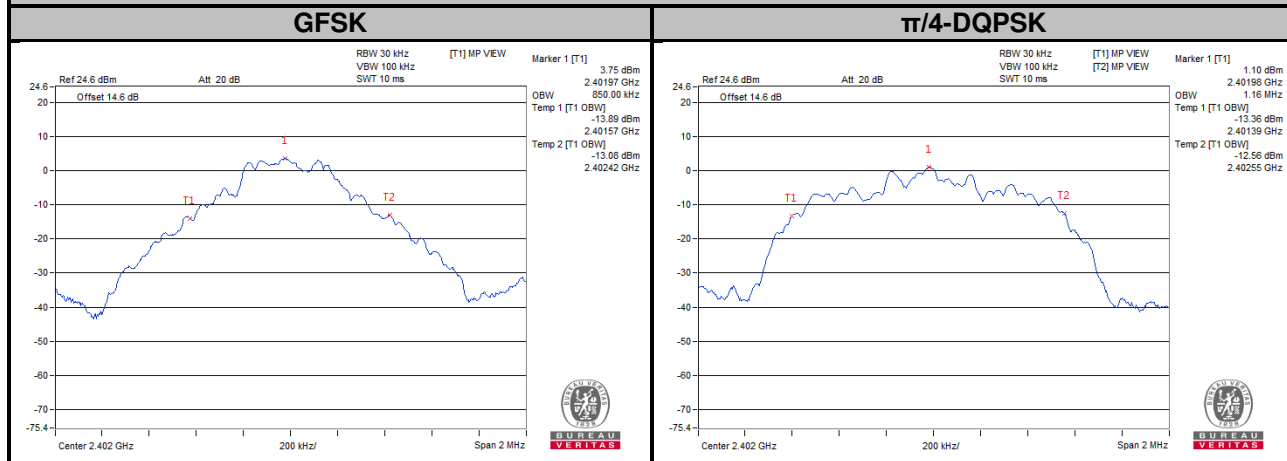

4.7 Hopping Channel Separation

4.7.1 Limits of Hopping Channel Separation Measurement

At least 25 kHz or two-third of 20 dB hopping channel bandwidth (whichever is greater).

4.7.2 Test Setup

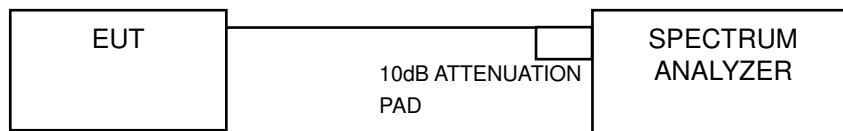

4.7.3 Test Instruments

Refer to section 4.1.2 to get information of above instrument.

4.7.4 Test Procedure

Measurement Procedure REF

- Check the calibration of the measuring instrument using either an internal calibrator or a known signal from an external generator.
- Turn on the EUT and connect it to measurement instrument. Then set it to any one convenient frequency within its operating range.
- By using the MaxHold function record the separation of two adjacent channels.
- Measure the frequency difference of these two adjacent channels by SA MARK function. And then plot the result on SA screen.
- Repeat above procedures until all frequencies measured were complete.

4.7.5 Deviation from Test Standard

No deviation.

4.7.6 Test Results

Channel	Freq. (MHz)	Adjacent Channel Separation (MHz)			20 dB Bandwidth (MHz)			Minimum Limit (MHz)			Pass / Fail
		GFSK	$\pi/4$ -DQPSK	8DPSK	GFSK	$\pi/4$ -DQPSK	8DPSK	GFSK	$\pi/4$ -DQPSK	8DPSK	
0	2402	1.00	1.00	1.00	0.94	1.29	1.26	0.63	0.86	0.84	Pass
39	2441	1.00	1.00	1.00	0.94	1.29	1.26	0.63	0.86	0.84	Pass
78	2480	1.00	1.00	1.00	0.94	1.29	1.26	0.63	0.86	0.84	Pass

Note:

- The minimum limit is two-third 20 dB bandwidth.

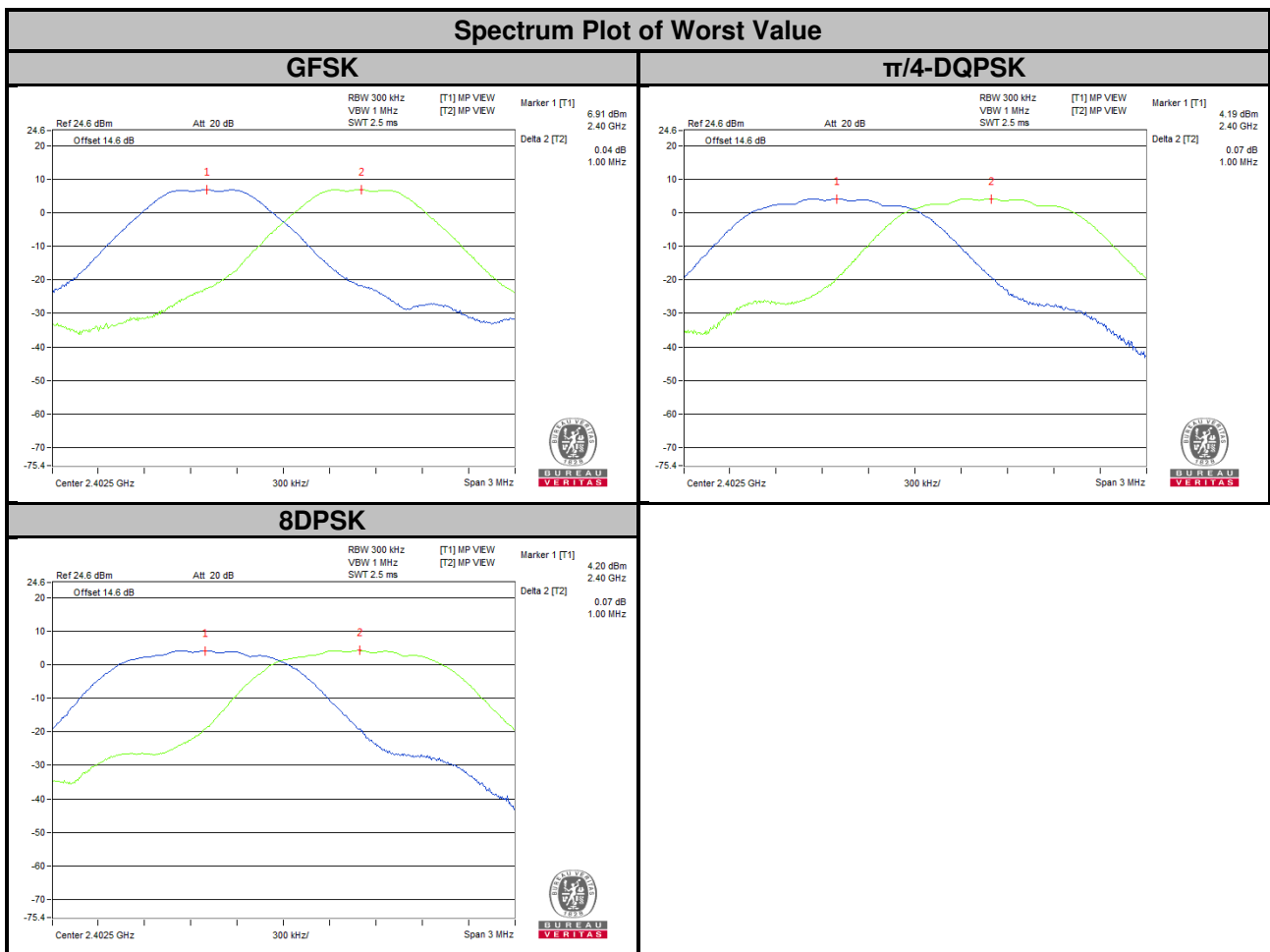

4.8 Maximum Output Power

4.8.1 Limits of Maximum Output Power Measurement

The Maximum Output Power Measurement is 125 mW.

4.8.2 Test Setup

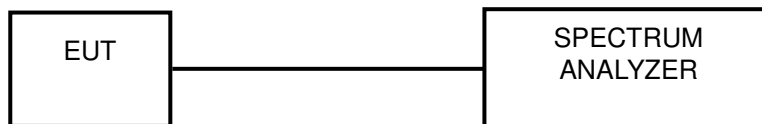

4.8.3 Test Instruments

Refer to section 4.1.2 to get information of above instrument.

4.8.4 Test Procedure

- Check the calibration of the measuring instrument using either an internal calibrator or a known signal from an external generator.
- Turn on the EUT and connect it to measurement instrument. Then set it to any one convenient frequency within its operating range. Set a reference level on the measuring instrument equal to the highest peak value.
- The center frequency of the spectrum analyzer is set to the fundamental frequency and using 3 MHz RBW and 10 MHz VBW.
- Measure the captured power within the band and recording the plot.
- Repeat above procedures until all frequencies required were complete.

4.8.5 Deviation from Test Standard

No deviation.

4.8.6 EUT Operating Condition

The software provided by client enabled the EUT to transmit and receive data at lowest, middle and highest channel frequencies individually.

4.8.7 Test Results

Channel	Freq. (MHz)	Output Power (mW)			Output Power (dBm)			Power Limit (mW)	Pass / Fail
		GFSK	$\pi/4$ -DQPSK	8DPSK	GFSK	$\pi/4$ -DQPSK	8DPSK		
0	2402	4.966	3.388	3.698	6.96	5.30	5.68	125	Pass
39	2441	5.888	4.217	4.477	7.70	6.25	6.51	125	Pass
78	2480	6.266	4.56	4.932	7.97	6.59	6.93	125	Pass

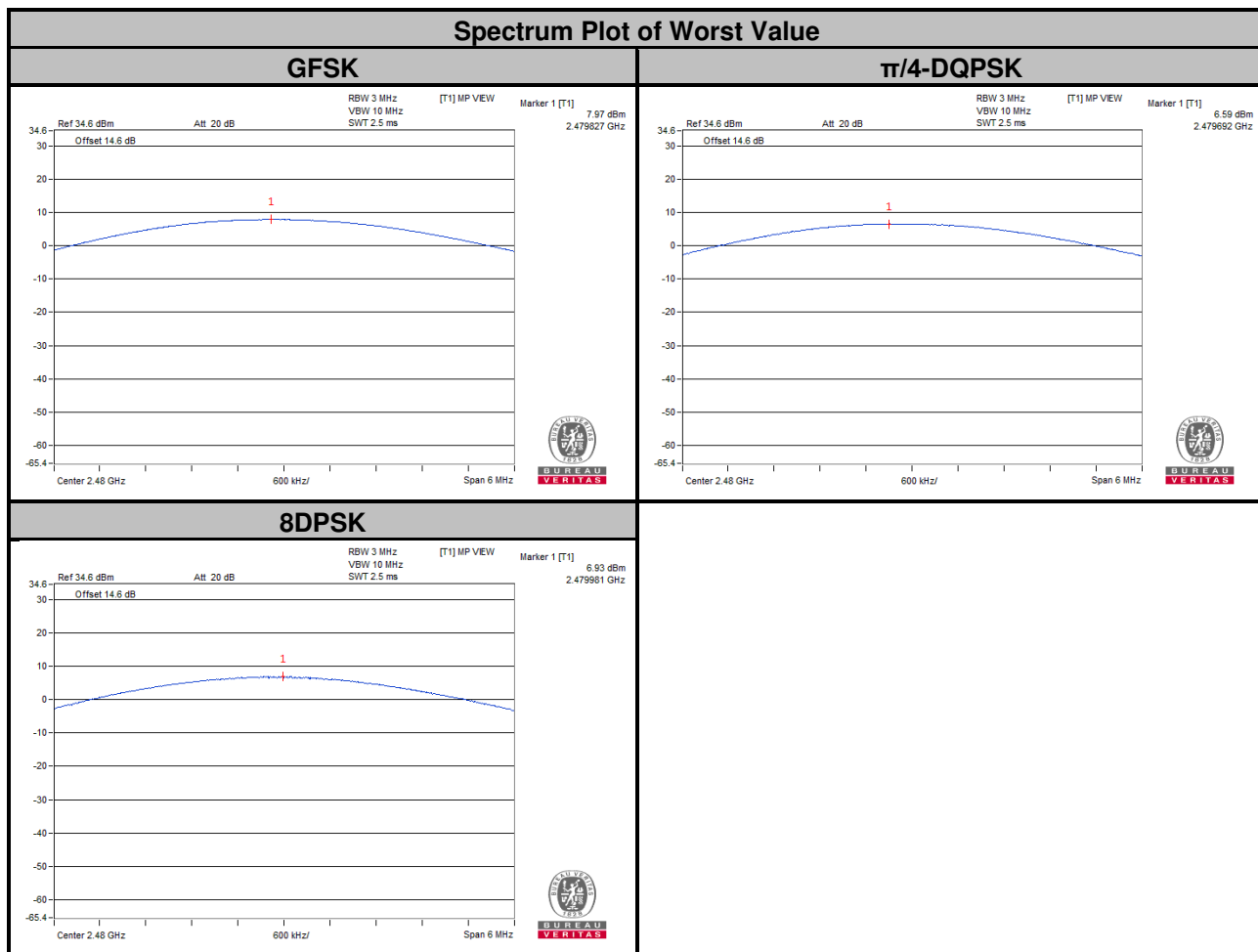

4.9 Conducted Out of Band Emission Measurement

4.9.1 Limits Of Conducted Out Of Band Emission Measurement

Below -20 dB of the highest emission level of operating band (in 100 kHz RBW).

4.9.2 Test Instruments

Refer to section 4.1.2 to get information of above instrument.

4.9.3 Test Procedure

The transmitter output was connected to the spectrum analyzer via a low lose cable. Set both RBW and VBW of spectrum analyzer to 100 kHz and 300 kHz with suitable frequency span including 100 MHz bandwidth from band edge. The band edges was measured and recorded.

4.9.4 Deviation from Test Standard

No deviation.

4.9.5 EUT Operating Condition

The software provided by client enabled the EUT to transmit and receive data at lowest, middle and highest channel frequencies individually.

4.9.6 Test Results

The spectrum plots are attached on the following images. D1 line indicates the highest level, D2 line indicates the 20 dB offset below D1. It shows compliance with the requirement.

GFSK

Hopping Disabled_Low Channel

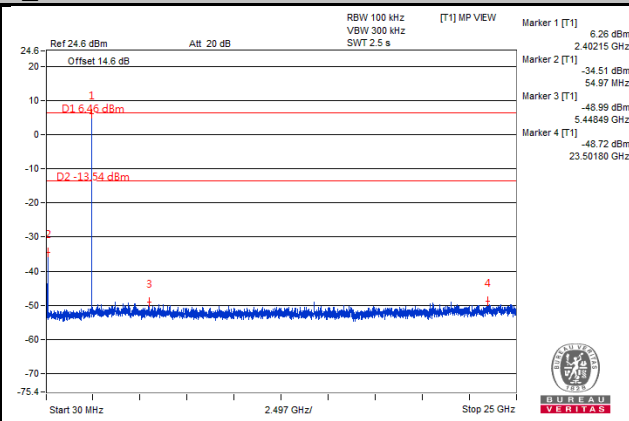
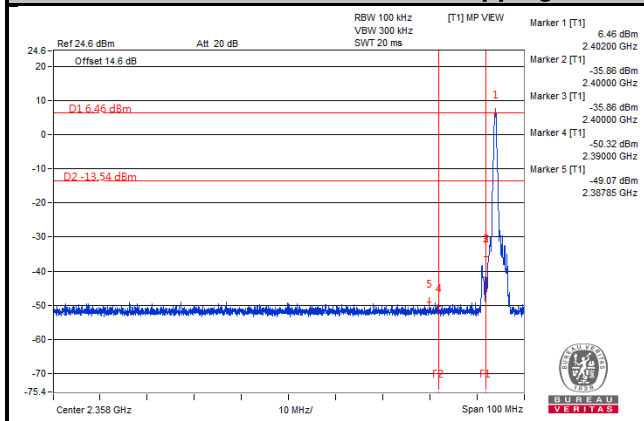

Hopping Disabled_High Channel

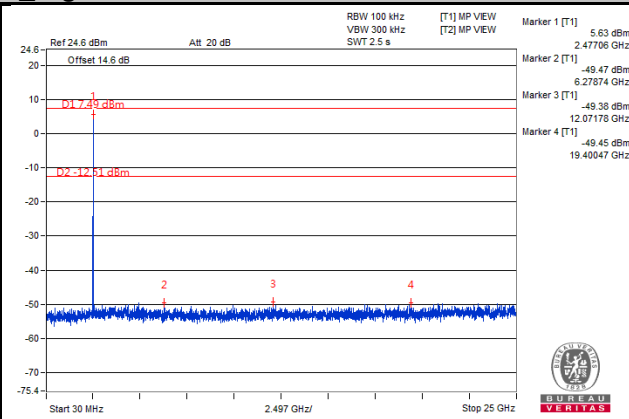
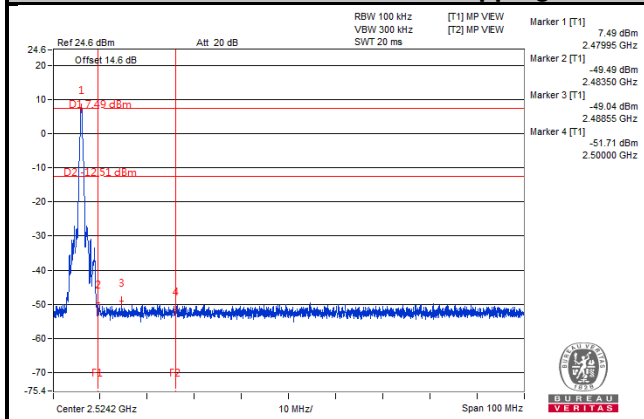

Hopping Enabled_Low Channel

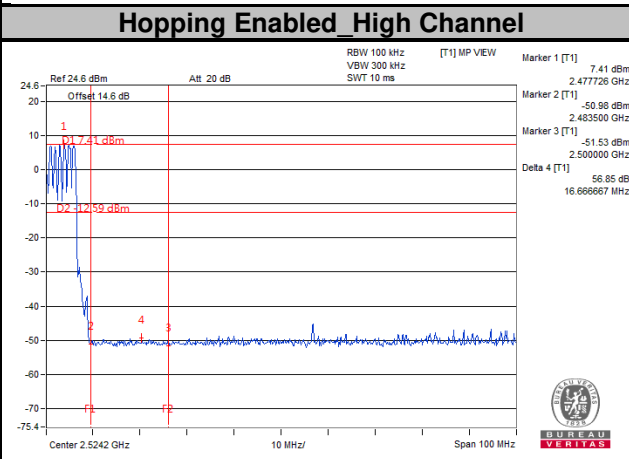
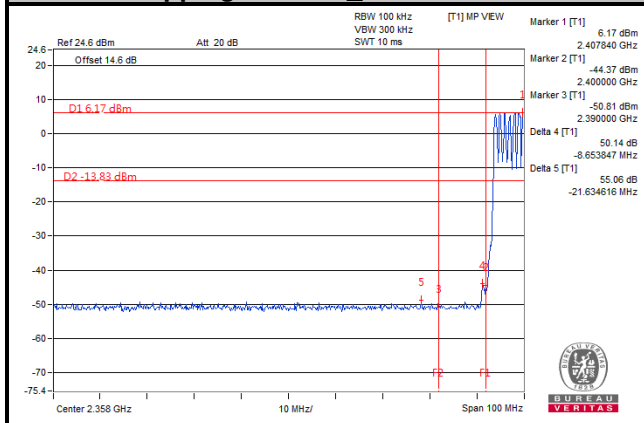

$\pi/4$ -DQPSK

Hopping Disabled_Low Channel

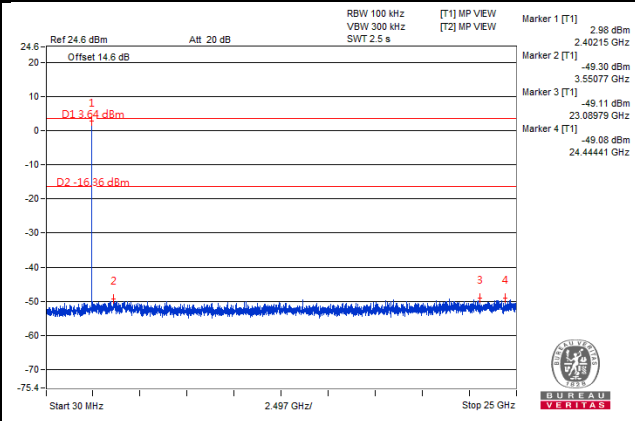
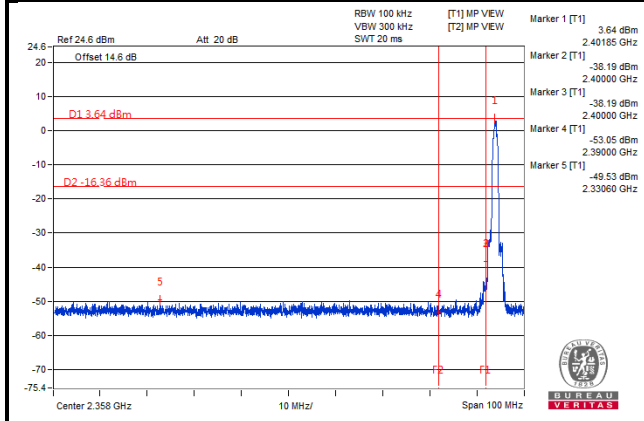

Hopping Disabled_High Channel

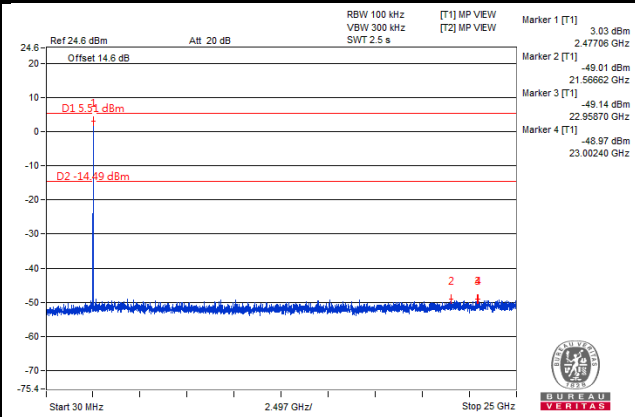
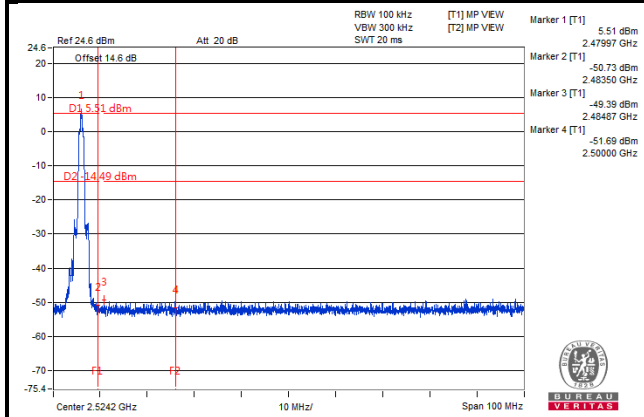

Hopping Enabled_Low Channel

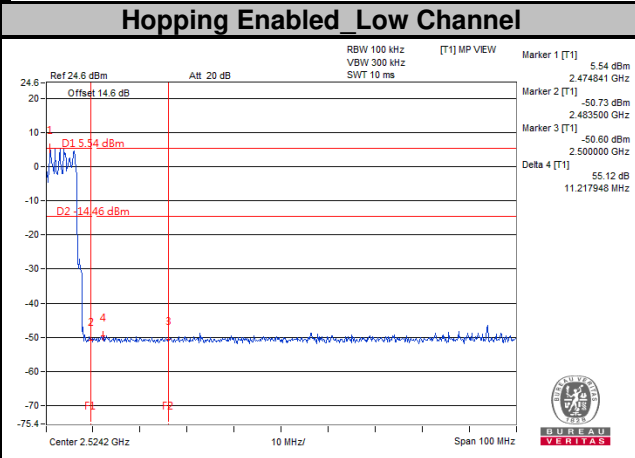
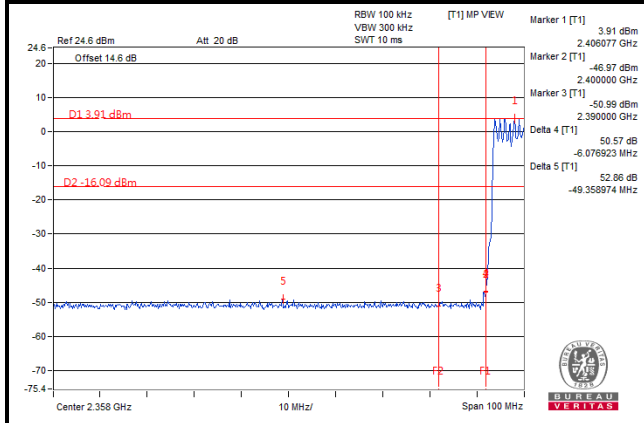

8DPSK

Hopping Disabled_Low Channel

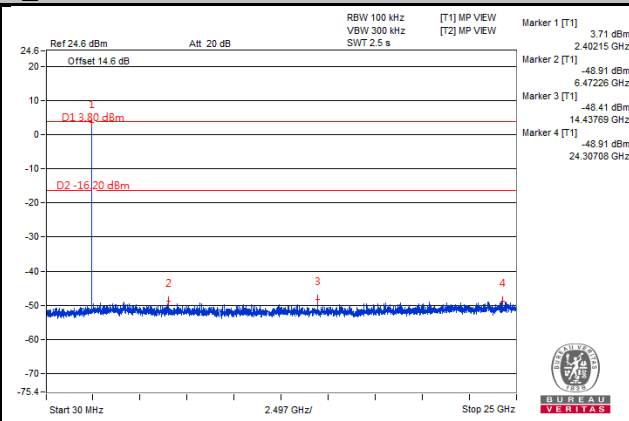
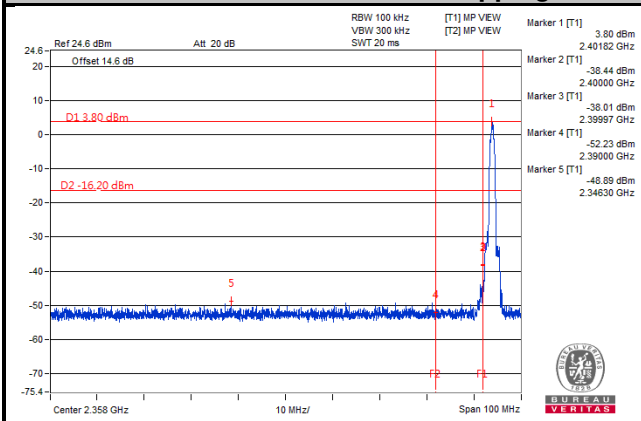

Hopping Disabled_High Channel

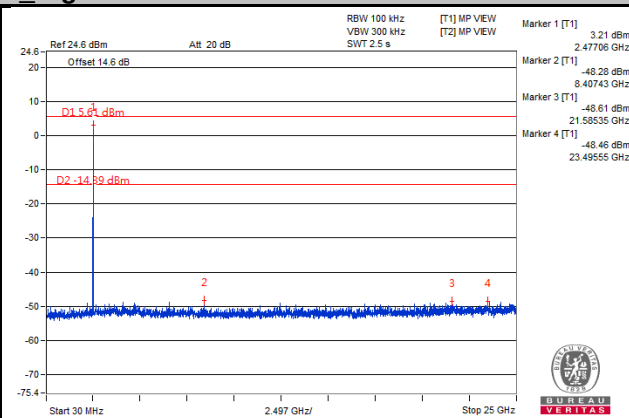
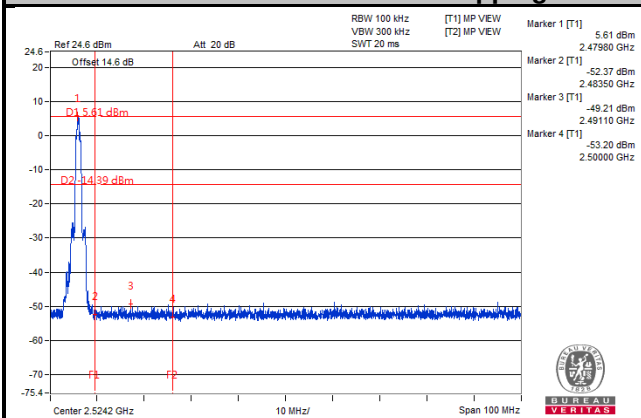

Hopping Enabled_Low Channel

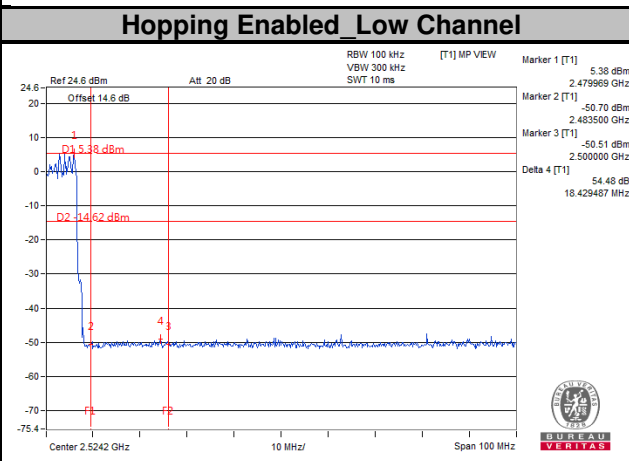
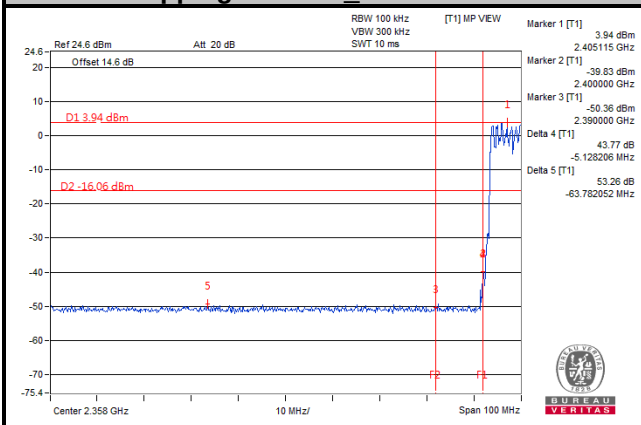

5 Pictures of Test Arrangements

Please refer to the attached file (Test Setup Photo).

Appendix – Information on the Testing Laboratories

We, Bureau Veritas Consumer Products Services (H.K.) Ltd., Taoyuan Branch, were founded in 1988 to provide our best service in EMC, Radio, Telecom and Safety consultation. Our laboratories are accredited and approved according to ISO/IEC 17025.

If you have any comments, please feel free to contact us at the following:

Linko EMC/RF Lab

Tel: 886-2-26052180

Fax: 886-2-26051924

Hsin Chu EMC/RF/Telecom Lab

Tel: 886-3-6668565

Fax: 886-3-6668323

Hwa Ya EMC/RF/Safety

Tel: 886-3-3183232

Fax: 886-3-3270892

Email: service.adt@tw.bureauveritas.com

Web Site: www.bureauveritas-adt.com

The address and road map of all our labs can be found in our web site also.

--- END ---