



FCC TEST REPORT (15.407)

REPORT NO.: RF140715C03A

MODEL NO.: PX* (* can be 0~9, A~Z or Blank)

FCC ID: HFS-PXC

RECEIVED: Jul. 21, 2014

TESTED: Aug. 14 ~ Aug. 21, 2014

ISSUED: Aug. 29, 2014

APPLICANT: Quanta Computer Inc

ADDRESS: 188 Wen Hwa 2nd Rd., Kuei Shan Hsiang Tao
Yuan Hsien Taiwan

ISSUED BY: Bureau Veritas Consumer Products Services
(H.K.) Ltd., Taoyuan Branch

LAB ADDRESS: No. 47-2, 14th Ling, Chia Pau Vil., Lin Kou Dist.,
New Taipei City, Taiwan, R.O.C.

TEST LOCATION: No. 19, Hwa Ya 2nd Rd, Wen Hwa Tsuen, Kwei
Shan Hsiang, Taoyuan Hsien 333, Taiwan, R.O.C.

This report should not be used by the client to claim product certification, approval, or endorsement by TAF or any government agencies.



This report is for your exclusive use. Any copying or replication of this report to or for any other person or entity, or use of our name or trademark, is permitted only with our prior written permission. This report sets forth our findings solely with respect to the test samples identified herein. The results set forth in this report are not indicative or representative of the quality or characteristics of the lot from which a test sample was taken or any similar or identical product unless specifically and expressly noted. Our report includes all of the tests requested by you and the results thereof based upon the information that you provided to us. You have 60 days from date of issuance of this report to notify us of any material error or omission caused by our negligence, provided, however, that such notice shall be in writing and shall specifically address the issue you wish to raise. A failure to raise such issue within the prescribed time shall constitute your unqualified acceptance of the completeness of this report, the tests conducted and the correctness of the report contents. Unless specific mention, the uncertainty of measurement has been explicitly taken into account to declare the compliance or non-compliance to the specification.



TABLE OF CONTENTS

RELEASE CONTROL RECORD.....	4
1. CERTIFICATION.....	5
2. SUMMARY OF TEST RESULTS.....	6
2.1 MEASUREMENT UNCERTAINTY.....	6
3. GENERAL INFORMATION.....	7
3.1 GENERAL DESCRIPTION OF EUT.....	7
3.2 DESCRIPTION OF TEST MODES.....	8
3.2.1 TEST MODE APPLICABILITY AND TESTED CHANNEL DETAIL.....	9
3.3 DUTY CYCLE OF TEST SIGNAL.....	11
3.4 DESCRIPTION OF SUPPORT UNITS.....	12
3.4.1 CONFIGURATION OF SYSTEM UNDER TEST.....	12
3.5 GENERAL DESCRIPTION OF APPLIED STANDARDS.....	13
4. TEST TYPES AND RESULTS.....	14
4.1 RADIATED EMISSION AND BANDEDGE MEASUREMENT.....	14
4.1.1 LIMITS OF RADIATED EMISSION AND BANDEDGE MEASUREMENT.....	14
4.1.2 LIMITS OF UNWANTED EMISSION OUT OF THE RESTRICTED BANDS.....	14
4.1.3 TEST INSTRUMENTS.....	15
4.1.4 TEST PROCEDURES.....	16
4.1.5 DEVIATION FROM TEST STANDARD.....	16
4.1.6 TEST SETUP.....	17
4.1.7 EUT OPERATING CONDITION.....	17
4.1.8 TEST RESULTS.....	18
4.2 CONDUCTED EMISSION MEASUREMENT.....	25
4.2.1 LIMITS OF CONDUCTED EMISSION MEASUREMENT.....	25
4.2.2 TEST INSTRUMENTS.....	25
4.2.3 TEST PROCEDURES.....	26
4.2.4 DEVIATION FROM TEST STANDARD.....	26
4.2.5 TEST SETUP.....	26
4.2.6 EUT OPERATING CONDITIONS.....	26
4.2.7 TEST RESULTS.....	27
4.3 TRANSMIT POWER MEASUREMENT.....	29
4.3.1 LIMITS OF TRANSMIT POWER MEASUREMENT.....	29
4.3.2 TEST SETUP.....	29
4.3.3 TEST INSTRUMENTS.....	30
4.3.4 TEST PROCEDURE.....	30
4.3.5 DEVIATION FROM TEST STANDARD.....	30
4.3.6 EUT OPERATING CONDITIONS.....	30
4.3.7 TEST RESULTS.....	31
4.4 PEAK POWER SPECTRAL DENSITY MEASUREMENT.....	32



A D T

4.4.1	LIMITS OF PEAK POWER SPECTRAL DENSITY MEASUREMENT.....	32
4.4.2	TEST SETUP	32
4.4.3	TEST INSTRUMENTS	32
4.4.4	TEST PROCEDURES.....	32
4.4.5	DEVIATION FROM TEST STANDARD.....	33
4.4.6	EUT OPERATING CONDITIONS	33
4.4.7	TEST RESULTS.....	34
4.5	FREQUENCY STABILITY	36
4.5.1	LIMITS OF FREQUENCY STABILITY MEASUREMENT	36
4.5.2	TEST SETUP	36
4.5.3	TEST INSTRUMENTS	36
4.5.4	TEST PROCEDURE	37
4.5.5	DEVIATION FROM TEST STANDARD.....	37
4.5.6	EUT OPERATING CONDITION.....	37
4.5.7	TEST RESULTS.....	38
4.6	6dB BANDWIDTH MEASUREMENT	39
4.6.1	LIMITS OF 6dB BANDWIDTH MEASUREMENT	39
4.6.2	TEST SETUP	39
4.6.3	TEST INSTRUMENTS	39
4.6.4	TEST PROCEDURE	39
4.6.5	DEVIATION FROM TEST STANDARD.....	39
4.6.6	EUT OPERATING CONDITIONS	39
4.6.7	TEST RESULTS.....	40
5.	PHOTOGRAPHS OF THE TEST CONFIGURATION.....	44
6.	INFORMATION ON THE TESTING LABORATORIES	45
7.	APPENDIX A – MODIFICATIONS RECORDERS FOR ENGINEERING CHANGES TO THE EUT BY THE LAB	46



A D T

RELEASE CONTROL RECORD

ISSUE NO.	REASON FOR CHANGE	DATE ISSUED
RF140715C03A	Original release.	Aug. 29, 2014



1. CERTIFICATION

PRODUCT: Quanta Video Presence Solution
MODEL: PX* (* can be 0~9, A~Z or Blank)
BRAND: Quanta
APPLICANT: Quanta Computer Inc
TESTED: Aug. 14 ~ Aug. 21, 2014
TEST SAMPLE: ENGINEERING SAMPLE
STANDARDS: **FCC Part 15, Subpart E (Section 15.407)**
ANSI C63.10-2009

The above equipment (model: PXC) has been tested by **Bureau Veritas Consumer Products Services (H.K.) Ltd., Taoyuan Branch**, and found compliance with the requirement of the above standards. The test record, data evaluation & Equipment Under Test (EUT) configurations represented herein are true and accurate accounts of the measurements of the sample's EMC characteristics under the conditions specified in this report.

PREPARED BY : Celine Chou , **DATE :** Aug. 29, 2014
Celine Chou / Specialist

APPROVED BY : Ken Liu , **DATE :** Aug. 29, 2014
Ken Liu / Senior Manager

2. SUMMARY OF TEST RESULTS

The EUT has been tested according to the following specifications:

APPLIED STANDARD: FCC PART 15, SUBPART E (SECTION 15.407)			
STANDARD SECTION	TEST TYPE	RESULT	REMARK
15.407(b)(6)	AC Power Conducted Emissions	PASS	Meet the requirement of limit. Minimum passing margin is -11.15dB at 0.41560MHz.
15.407(b)(1/2/3/4/6)	Radiated Emissions & Band Edge Measurement	PASS	Meet the requirement of limit. Minimum passing margin is -2.3dB at 68.30MHz.
15.407(a)(1/2/3)	Max Average Transmit Power	PASS	Meet the requirement of limit.
15.407(a)(1/2/3)	Peak Power Spectral Density	PASS	Meet the requirement of limit.
15.407(e)	6dB bandwidth	PASS	Meet the requirement of limit. (U-NII-3 Band only)
15.407(g)	Frequency Stability	PASS	Meet the requirement of limit.
15.203	Antenna Requirement	PASS	No antenna connector is used.

2.1 MEASUREMENT UNCERTAINTY

Where relevant, the following measurement uncertainty levels have been estimated for tests performed on the EUT as specified in CISPR 16-4-2:

MEASUREMENT	FREQUENCY	UNCERTAINTY
Conducted emissions	9kHz~30MHz	2.44 dB
Radiated emissions	30MHz ~ 200MHz	2.93 dB
	200MHz ~1000MHz	2.95 dB
	1GHz ~ 18GHz	2.26 dB
	18GHz ~ 40GHz	1.94 dB

This uncertainty represents an expanded uncertainty expressed at approximately the 95% confidence level using a coverage factor of $k = 2$.

3. GENERAL INFORMATION

3.1 GENERAL DESCRIPTION OF EUT

EUT	Quanta Video Presence Solution
MODEL NO.	PX* (* can be 0~9, A~Z or Blank)
POWER SUPPLY	12Vdc (Adapter)
MODULATION TYPE	QPSK
TRANSFER RATE	22Mbps
OPERATING FREQUENCY	5180 ~ 5240MHz & 5736 ~ 5814MHz
NUMBER OF CHANNEL	5180 ~ 5240MHz: 3 5736 ~ 5814MHz: 3
OUTPUT POWER	5180 ~ 5240MHz: 6.457mW 5736 ~ 5814MHz: 4.581mW
ANTENNA TYPE	Refer to note
ANTENNA CONNECTOR	NA
DATA CABLE	1.2m shielded HDMI cable without core 1.1m shielded Mini D-Sub cable without core
I/O PORTS	Refer to user's manual
ACCESSORY DEVICES	Adapter

NOTE:

1. The following models are provided to this EUT.

Brand	Model	Description
Quanta	PX* (* can be 0~9, A~Z or Blank)	where * can be 0~9, A~Z or Blank for marketing purposes only

* The model PXC was chosen for final test.

2. The EUT with follow antennas gain is listed as table below.

Ant. No.	Type	Connector	Gain(dBi)	
			5180 ~ 5240MHz	5736 ~ 5814MHz
1	Embedded	NA	2.11	3.11
2			3.12	5.22

3. The EUT consumes power from the following adapter.

BRAND:	APD
MODEL:	WA-24Q12FU
INPUT:	100-240Vac, 50-60Hz, 0.6A
OUTPUT:	12Vdc, 2A
POWER LINE:	1.8m power cable attached on adapter without core

4. The above EUT information is declared by manufacturer and for more detailed features description, please refer to the manufacturer's specifications or user's manual.

3.2 DESCRIPTION OF TEST MODES

FOR 5180 ~ 5240MHz

3 channels are provided to the EUT:

CHANNEL	FREQUENCY	CHANNEL	FREQUENCY
36	5180 MHz	48	5240 MHz
42	5210 MHz		

FOR 5736 ~ 5814MHz

3 channels are provided to the EUT:

CHANNEL	FREQUENCY	CHANNEL	FREQUENCY
147.2	5736MHz	162.8	5814MHz
152.4	5762MHz		

3.2.1 TEST MODE APPLICABILITY AND TESTED CHANNEL DETAIL

EUT CONFIGURE MODE	APPLICABLE TO				DESCRIPTION
	RE \geq 1G	RE<1G	PLC	APCM	
-	√	√	√	√	-

Where RE \geq 1G: Radiated Emission above 1GHz RE<1G: Radiated Emission below 1GHz
 PLC: Power Line Conducted Emission APCM: Antenna Port Conducted Measurement

RADIATED EMISSION TEST (ABOVE 1GHz):

- Pre-Scan has been conducted to determine the worst-case mode from all possible combinations between available modulations, data rates and antenna ports (if EUT with antenna diversity architecture).
- Following channel(s) was (were) selected for the final test as listed below.

EUT CONFIGURE MODE	MODE	FREQ. BAND (MHz)	AVAILABLE CHANNEL	TESTED CHANNEL	MODULATION TYPE	DATA RATE (Mbps)
-	802.11a	5180-5240	36 to 48	36, 42, 48	QPSK	22
-	802.11a	5736-5814	147.2 to 162.8	147.2, 152.4, 162.8	QPSK	22

RADIATED EMISSION TEST (BELOW 1GHz):

- Pre-Scan has been conducted to determine the worst-case mode from all possible combinations between available modulations, data rates and antenna ports (if EUT with antenna diversity architecture).
- Following channel(s) was (were) selected for the final test as listed below.

EUT CONFIGURE MODE	MODE	FREQ. BAND (MHz)	AVAILABLE CHANNEL	TESTED CHANNEL	MODULATION TYPE	DATA RATE (Mbps)
-	802.11a	5180-5240	36 to 48	36	QPSK	22
-	802.11a	5736-5814	147.2 to 162.8		QPSK	22

POWER LINE CONDUCTED EMISSION TEST:

- Pre-Scan has been conducted to determine the worst-case mode from all possible combinations between available modulations, data rates and antenna ports (if EUT with antenna diversity architecture).
- Following channel(s) was (were) selected for the final test as listed below.

EUT CONFIGURE MODE	MODE	FREQ. BAND (MHz)	AVAILABLE CHANNEL	TESTED CHANNEL	MODULATION TYPE	DATA RATE (Mbps)
-	802.11a	5180-5240	36 to 48	36	QPSK	22
-	802.11a	5736-5814	147.2 to 162.8		QPSK	22

ANTENNA PORT CONDUCTED MEASUREMENT:

- This item includes all test value of each mode, but only includes spectrum plot of worst value of each mode.
- Pre-Scan has been conducted to determine the worst-case mode from all possible combinations between available modulations, data rates and antenna ports (if EUT with antenna diversity architecture).
- Following channel(s) was (were) selected for the final test as listed below.

EUT CONFIGURE MODE	MODE	FREQ. BAND (MHz)	AVAILABLE CHANNEL	TESTED CHANNEL	MODULATION TYPE	DATA RATE (Mbps)
-	802.11a	5180-5240	36 to 48	36, 42, 48	QPSK	22
-	802.11a	5736-5814	147.2 to 162.8	147.2, 152.4, 162.8	QPSK	22

TEST CONDITION:

APPLICABLE TO	ENVIRONMENTAL CONDITIONS	INPUT POWER (SYSTEM)	Tested by
RE≥1G	25deg. C, 65%RH	120Vac, 60Hz	Ted Chang
RE<1G	25deg. C, 65%RH	120Vac, 60Hz	Ted Chang
PLC	24deg. C, 64%RH	120Vac, 60Hz	Match Tsui
APCM	24deg. C, 64%RH	120Vac, 60Hz	Match Tsui



A D T

3.3 DUTY CYCLE OF TEST SIGNAL

For U-NII-1 Band

Duty cycle of test signal is 100 %, duty factor is not required.

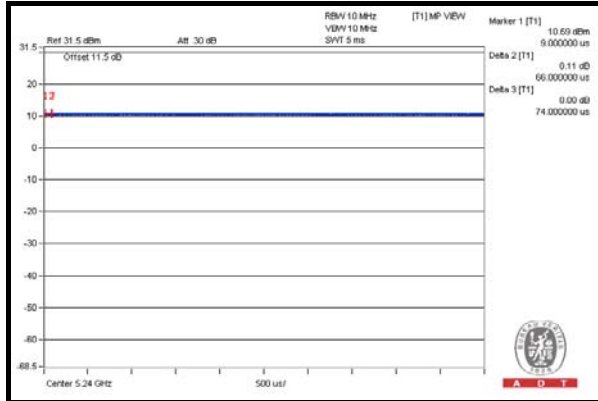

For U-NII-3 Band

Duty cycle of test signal is 100 %, duty factor is not required.

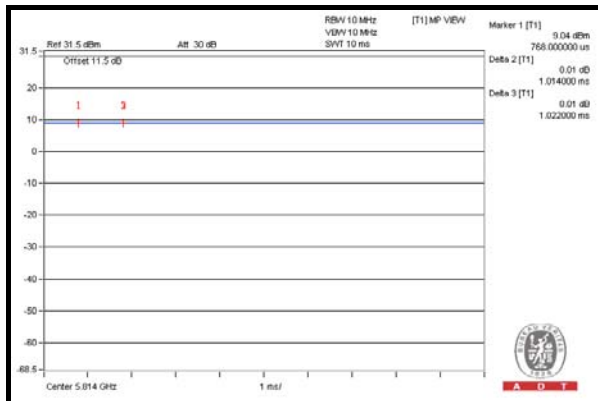

3.4 DESCRIPTION OF SUPPORT UNITS

The EUT has been tested as an independent unit.

3.4.1 CONFIGURATION OF SYSTEM UNDER TEST

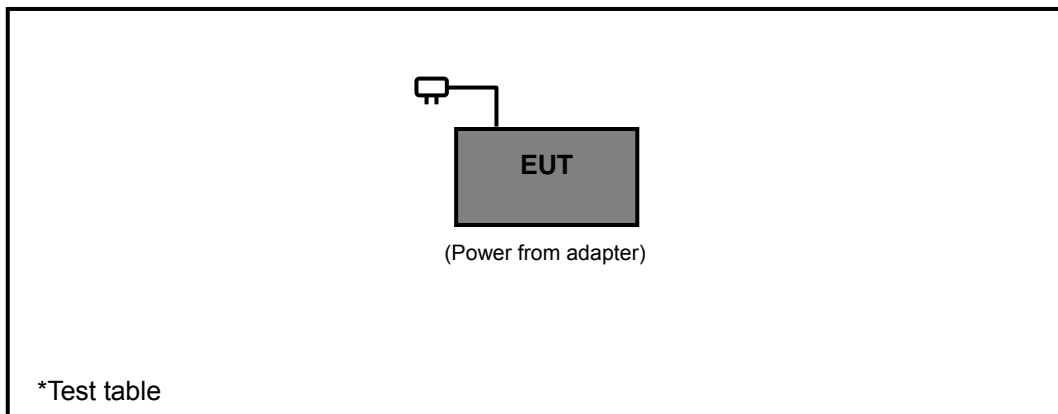

3.5 GENERAL DESCRIPTION OF APPLIED STANDARDS

The EUT is a RF Product. According to the specification of the EUT declared by the manufacturer, it must comply with the requirements of the following standards:

FCC Part 15, Subpart E (15.407)

789033 D02 General UNII Test Procedures New Rules v01

ANSI C63.10-2009

All test items have been performed and recorded as per the above standards.

NOTE: The EUT is also considered as a kind of computer peripheral, because the connection to computer is necessary for typical use. It has been verified to comply with the requirements of FCC Part 15, Subpart B, Class B (DoC). The test report has been issued separately.

4. TEST TYPES AND RESULTS

4.1 RADIATED EMISSION AND BANDEDGE MEASUREMENT

4.1.1 LIMITS OF RADIATED EMISSION AND BANDEDGE MEASUREMENT

Radiated emissions which fall in the restricted bands must comply with the radiated emission limits specified as below table:

FREQUENCIES (MHz)	FIELD STRENGTH (microvolts/meter)	MEASUREMENT DISTANCE (meters)
0.009 ~ 0.490	2400/F(kHz)	300
0.490 ~ 1.705	24000/F(kHz)	30
1.705 ~ 30.0	30	30
30 ~ 88	100	3
88 ~ 216	150	3
216 ~ 960	200	3
Above 960	500	3

NOTE:

1. The lower limit shall apply at the transition frequencies.
2. Emission level (dBuV/m) = 20 log Emission level (uV/m).
3. For frequencies above 1000MHz, the field strength limits are based on average detector, however, the peak field strength of any emission shall not exceed the maximum permitted average limits, specified above by more than 20dB under any condition of modulation.

4.1.2 LIMITS OF UNWANTED EMISSION OUT OF THE RESTRICTED BANDS

APPLICABLE TO	LIMIT	
789033 D02 General UNII Test Procedures New Rules v01	FIELD STRENGTH AT 3m	
	PK: 74 (dBµV/m)	AV: 54 (dBµV/m)
APPLICABLE TO	EIRP LIMIT	EQUIVALENT FIELD STRENGTH AT 3m
15.407(b)(1)	PK: -27 (dBm/MHz)	PK: 68.2 (dBµV/m)
15.407(b)(2)		
15.407(b)(3)		
15.407(b)(4)	PK: -27 (dBm/MHz) ^{*1} PK: -17 (dBm/MHz) ^{*2}	PK: 68.2 (dBµV/m) ^{*1} PK: 78.2 (dBµV/m) ^{*2}

NOTE: ^{*1} beyond 10MHz of the band edge ^{*2} within 10 MHz of band edge

The following formula is used to convert the equipment isotropic radiated power (eirp) to field strength:

$$E = \frac{1000000\sqrt{30P}}{3} \mu\text{V/m, where P is the eirp (Watts).}$$

4.1.3 TEST INSTRUMENTS

DESCRIPTION & MANUFACTURER	MODEL NO.	SERIAL NO.	DATE OF CALIBRATION	DUE DATE OF CALIBRATION
Test Receiver ROHDE & SCHWARZ	ESCS30	100289	Nov. 29, 2013	Nov. 28, 2014
Spectrum Analyzer ROHDE & SCHWARZ	FSP40	100269	Feb. 11, 2014	Feb. 10, 2015
BILOG Antenna SCHWARZBECK	VULB9168	9168-156	Feb. 25, 2014	Feb. 24, 2015
HORN Antenna SCHWARZBECK	BBHA 9120 D	9120D-209	Sep. 12, 2013	Sep. 11, 2014
HORN Antenna SCHWARZBECK	BBHA 9170	BBHA9170241	Feb. 17, 2014	Feb. 16, 2015
Preamplifier Agilent	8449B	3008A01911	Aug. 22, 2013	Aug. 21, 2014
Preamplifier Agilent	8447D	2944A10638	Oct. 18, 2013	Oct. 17, 2014
RF signal cable HUBER+SUHNNER	SUCOFLEX 104	248780/4 309222/4 274092/4	Aug. 26, 2013	Aug. 25, 2014
RF signal cable Worken	5D-FB	Cable-HYCH9-01	Aug. 11, 2014	Aug. 10, 2015
Software BV ADT	ADT_Radiated_ V7.6.15.9.4	NA	NA	NA
Antenna Tower EMCO	2070/2080	512.835.4684	NA	NA
Turn Table EMCO	2087-2.03	NA	NA	NA
Antenna Tower & Turn Table Controller EMCO	2090	NA	NA	NA
26GHz ~ 40GHz Amplifier	EM26400	815221	Oct. 18, 2013	Oct. 17, 2014
High Speed Peak Power Meter	ML2495A	0824011	Jul. 26, 2014	Jul. 25, 2015
Power Sensor	MA2411B	0738171	Jul. 26, 2014	Jul. 25, 2015
WIT Standard Temperature And Humidity Chamber	TH-4S-C	W981030	Jun. 9, 2014	Jun. 08, 2015

- NOTE:**
1. The calibration interval of the above test instruments is 12 months and the calibrations are traceable to NML/ROC and NIST/USA.
 2. The test was performed in HwaYa Chamber 9.
 3. The horn antenna and HP preamplifier (model: 8449B) are used only for the measurement of emission frequency above 1GHz if tested.
 4. The FCC Site Registration No. is 215374.
 5. The IC Site Registration No. is IC 7450F-9.

4.1.4 TEST PROCEDURES

- a. The EUT was placed on the top of a rotating table 0.8 meters above the ground at a 3 meter semi-anechoic chamber. The table was rotated 360 degrees to determine the position of the highest radiation.
- b. The EUT was set 3 meters away from the interference-receiving antenna, which was mounted on the top of a variable-height antenna tower.
- c. The antenna is a broadband antenna, and its height is varied from one meter to four meters above the ground to determine the maximum value of the field strength. Both horizontal and vertical polarizations of the antenna are set to make the measurement.
- d. For each suspected emission, the EUT was arranged to its worst case and then the antenna was tuned to heights from 1 meter to 4 meters and the rotatable table was turned from 0 degrees to 360 degrees to find the maximum reading.
- e. The test-receiver system was set to Peak Detect Function and Specified Bandwidth with Maximum Hold Mode.
- f. If the emission level of the EUT in peak mode was 10dB lower than the limit specified, then testing could be stopped and the peak values of the EUT would be reported. Otherwise the emissions that did not have 10dB margin would be re-tested one by one using peak, quasi-peak or average method as specified and then reported in a data sheet.

NOTE:

1. The resolution bandwidth and video bandwidth of test receiver/spectrum analyzer is 120kHz for Quasi-peak detection at frequency below 1GHz.
2. The resolution bandwidth of test receiver/spectrum analyzer is 1MHz and video bandwidth is 3MHz for Peak detection at frequency above 1GHz.
3. The resolution bandwidth of test receiver/spectrum analyzer is 1MHz and the video bandwidth is $\geq 1/T$ (Duty cycle < 98%) or 10Hz (Duty cycle > 98%) for Average detection (AV) at frequency above 1GHz.
4. All modes of operation were investigated and the worst-case emissions are reported.

4.1.5 DEVIATION FROM TEST STANDARD

No deviation.

4.1.6 TEST SETUP

Frequency range 30MHz~1GHz

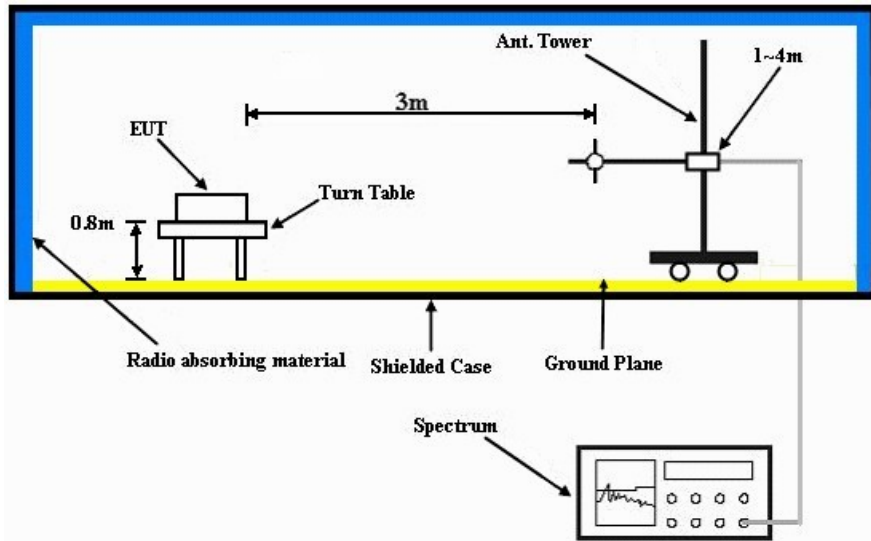

Frequency range above 1GHz

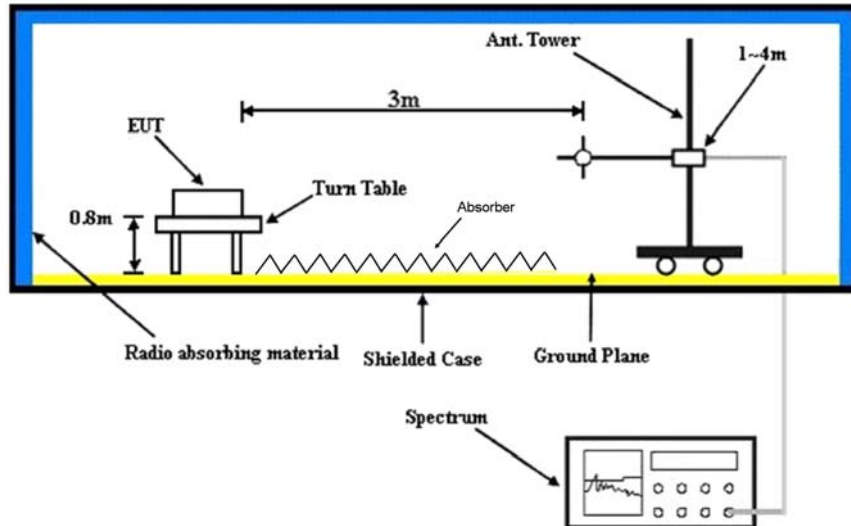

For the actual test configuration, please refer to the attached file (Test Setup Photo).

4.1.7 EUT OPERATING CONDITION

- Placed the EUT on the testing table.
- Set the EUT under transmission condition continuously at specific channel frequency.

4.1.8 TEST RESULTS

ABOVE 1GHz WORST-CASE DATA:

For U-NII-1 Band

CHANNEL	TX Channel 36	DETECTOR FUNCTION	Peak (PK)
FREQUENCY RANGE	1GHz ~ 40GHz		Average (AV)

ANTENNA POLARITY & TEST DISTANCE: HORIZONTAL AT 3 M								
NO.	FREQ. (MHz)	EMISSION LEVEL (dBuV/m)	LIMIT (dBuV/m)	MARGIN (dB)	ANTENNA HEIGHT (m)	TABLE ANGLE (Degree)	RAW VALUE (dBuV)	CORRECTION FACTOR (dB/m)
1	4500.00	56.2 PK	74.0	-17.8	1.03 H	58	55.30	0.90
2	4500.00	44.2 AV	54.0	-9.8	1.03 H	58	43.30	0.90
3	*5180.00	88.7 PK			1.03 H	58	49.30	39.40
4	*5180.00	84.7 AV			1.03 H	58	45.30	39.40
5	#10360.00	60.8 PK	74.0	-13.2	1.00 H	106	46.90	13.90
6	#10360.00	50.3 AV	54.0	-3.7	1.00 H	106	36.40	13.90

ANTENNA POLARITY & TEST DISTANCE: VERTICAL AT 3 M								
NO.	FREQ. (MHz)	EMISSION LEVEL (dBuV/m)	LIMIT (dBuV/m)	MARGIN (dB)	ANTENNA HEIGHT (m)	TABLE ANGLE (Degree)	RAW VALUE (dBuV)	CORRECTION FACTOR (dB/m)
1	4500.00	56.2 PK	74.0	-17.8	1.03 V	156	55.30	0.90
2	4500.00	44.3 AV	54.0	-9.7	1.03 V	156	43.40	0.90
3	*5180.00	91.4 PK			1.03 V	156	52.00	39.40
4	*5180.00	87.5 AV			1.03 V	156	48.10	39.40
5	#10360.00	60.5 PK	74.0	-13.5	1.00 V	204	46.60	13.90
6	#10360.00	50.0 AV	54.0	-4.0	1.00 V	204	36.10	13.90

REMARKS:

1. Emission Level(dBuV/m) = Raw Value(dBuV) + Correction Factor(dB/m)
2. Correction Factor(dB/m) = Antenna Factor(dB/m) + Cable Factor(dB) – Pre-Amplifier Factor(dB)
3. The other emission levels were very low against the limit.
4. Margin value = Emission Level – Limit value
5. " * ": Fundamental frequency.
6. " # ": The radiated frequency is out of the restricted band.

CHANNEL	TX Channel 42	DETECTOR FUNCTION	Peak (PK)
FREQUENCY RANGE	1GHz ~ 40GHz		Average (AV)

ANTENNA POLARITY & TEST DISTANCE: HORIZONTAL AT 3 M								
NO.	FREQ. (MHz)	EMISSION LEVEL (dBuV/m)	LIMIT (dBuV/m)	MARGIN (dB)	ANTENNA HEIGHT (m)	TABLE ANGLE (Degree)	RAW VALUE (dBuV)	CORRECTION FACTOR (dB/m)
1	*5210.00	90.2 PK			1.00 H	212	50.70	39.50
2	*5210.00	86.3 AV			1.00 H	212	46.80	39.50
3	#10420.00	61.3 PK	74.0	-12.7	1.00 H	129	46.90	14.40
4	#10420.00	48.6 AV	54.0	-5.4	1.00 H	129	34.20	14.40
ANTENNA POLARITY & TEST DISTANCE: VERTICAL AT 3 M								
NO.	FREQ. (MHz)	EMISSION LEVEL (dBuV/m)	LIMIT (dBuV/m)	MARGIN (dB)	ANTENNA HEIGHT (m)	TABLE ANGLE (Degree)	RAW VALUE (dBuV)	CORRECTION FACTOR (dB/m)
1	*5210.00	91.8 PK			1.01 V	157	52.30	39.50
2	*5210.00	87.7 AV			1.01 V	157	48.20	39.50
3	#10420.00	60.6 PK	74.0	-13.4	1.00 V	296	46.20	14.40
4	#10420.00	48.2 AV	54.0	-5.8	1.00 V	296	33.80	14.40

REMARKS:

1. Emission Level(dBuV/m) = Raw Value(dBuV) + Correction Factor(dB/m)
2. Correction Factor(dB/m) = Antenna Factor(dB/m) + Cable Factor(dB) – Pre-Amplifier Factor(dB)
3. The other emission levels were very low against the limit.
4. Margin value = Emission Level – Limit value
5. " * ": Fundamental frequency.
6. " # ": The radiated frequency is out of the restricted band.

CHANNEL	TX Channel 48	DETECTOR FUNCTION	Peak (PK)
FREQUENCY RANGE	1GHz ~ 40GHz		Average (AV)

ANTENNA POLARITY & TEST DISTANCE: HORIZONTAL AT 3 M								
NO.	FREQ. (MHz)	EMISSION LEVEL (dBuV/m)	LIMIT (dBuV/m)	MARGIN (dB)	ANTENNA HEIGHT (m)	TABLE ANGLE (Degree)	RAW VALUE (dBuV)	CORRECTION FACTOR (dB/m)
1	*5240.00	88.2 PK			1.00 H	210	48.60	39.60
2	*5240.00	84.3 AV			1.00 H	210	44.70	39.60
3	5460.00	58.1 PK	74.0	-15.9	1.00 H	210	55.30	2.80
4	5460.00	44.9 AV	54.0	-9.1	1.00 H	210	42.10	2.80
5	#10480.00	63.2 PK	74.0	-10.8	1.22 H	326	47.90	15.30
6	#10480.00	51.1 AV	54.0	-2.9	1.22 H	326	35.80	15.30
ANTENNA POLARITY & TEST DISTANCE: VERTICAL AT 3 M								
NO.	FREQ. (MHz)	EMISSION LEVEL (dBuV/m)	LIMIT (dBuV/m)	MARGIN (dB)	ANTENNA HEIGHT (m)	TABLE ANGLE (Degree)	RAW VALUE (dBuV)	CORRECTION FACTOR (dB/m)
1	*5240.00	90.9 PK			1.00 V	157	51.30	39.60
2	*5240.00	87.1 AV			1.00 V	157	47.50	39.60
3	5460.00	58.0 PK	74.0	-16.0	1.00 V	157	55.20	2.80
4	5460.00	45.1 AV	54.0	-8.9	1.00 V	157	42.30	2.80
5	#10480.00	62.5 PK	74.0	-11.5	1.46 V	346	47.20	15.30
6	#10480.00	50.3 AV	54.0	-3.7	1.46 V	346	35.00	15.30

REMARKS:

1. Emission Level(dBuV/m) = Raw Value(dBuV) + Correction Factor(dB/m)
2. Correction Factor(dB/m) = Antenna Factor(dB/m) + Cable Factor(dB) – Pre-Amplifier Factor(dB)
3. The other emission levels were very low against the limit.
4. Margin value = Emission Level – Limit value
5. " * ": Fundamental frequency.
6. " # ": The radiated frequency is out of the restricted band.

For U-NII-3 Band

CHANNEL	TX Channel 147.2	DETECTOR FUNCTION	Peak (PK)
FREQUENCY RANGE	1GHz ~ 40GHz		Average (AV)

ANTENNA POLARITY & TEST DISTANCE: HORIZONTAL AT 3 M								
NO.	FREQ. (MHz)	EMISSION LEVEL (dBuV/m)	LIMIT (dBuV/m)	MARGIN (dB)	ANTENNA HEIGHT (m)	TABLE ANGLE (Degree)	RAW VALUE (dBuV)	CORRECTION FACTOR (dB/m)
1	#5714.90	57.5 PK	74.0	-16.5	1.01 H	211	54.20	3.30
2	#5714.90	45.5 AV	54.0	-8.5	1.01 H	211	42.20	3.30
3	#5725.00	61.7 PK	78.2	-16.5	1.01 H	211	58.40	3.30
4	*5736.00	94.7 PK			1.01 H	211	54.40	40.30
5	*5736.00	90.8 AV			1.01 H	211	50.50	40.30
6	11472.00	60.1 PK	74.0	-13.9	1.02 H	6	44.20	15.90
7	11472.00	48.4 AV	54.0	-5.6	1.02 H	6	32.50	15.90

ANTENNA POLARITY & TEST DISTANCE: VERTICAL AT 3 M								
NO.	FREQ. (MHz)	EMISSION LEVEL (dBuV/m)	LIMIT (dBuV/m)	MARGIN (dB)	ANTENNA HEIGHT (m)	TABLE ANGLE (Degree)	RAW VALUE (dBuV)	CORRECTION FACTOR (dB/m)
1	#5714.90	58.0 PK	74.0	-16.0	1.24 V	158	54.70	3.30
2	#5714.90	45.4 AV	54.0	-8.6	1.24 V	158	42.10	3.30
3	#5725.00	60.2 PK	78.2	-18.0	1.24 V	158	56.90	3.30
4	*5736.00	97.0 PK			1.24 V	158	56.70	40.30
5	*5736.00	93.2 AV			1.24 V	158	52.90	40.30
6	11472.00	60.4 PK	74.0	-13.6	1.00 V	248	44.50	15.90
7	11472.00	48.0 AV	54.0	-6.0	1.00 V	248	32.10	15.90

REMARKS:

- Emission Level(dBuV/m) = Raw Value(dBuV) + Correction Factor(dB/m)
- Correction Factor(dB/m) = Antenna Factor(dB/m) + Cable Factor(dB) – Pre-Amplifier Factor(dB)
- The other emission levels were very low against the limit.
- Margin value = Emission Level – Limit value
- " * ": Fundamental frequency.
- " # ": The radiated frequency is out of the restricted band.

CHANNEL	TX Channel 152.4	DETECTOR FUNCTION	Peak (PK)
FREQUENCY RANGE	1GHz ~ 40GHz		Average (AV)

ANTENNA POLARITY & TEST DISTANCE: HORIZONTAL AT 3 M								
NO.	FREQ. (MHz)	EMISSION LEVEL (dBuV/m)	LIMIT (dBuV/m)	MARGIN (dB)	ANTENNA HEIGHT (m)	TABLE ANGLE (Degree)	RAW VALUE (dBuV)	CORRECTION FACTOR (dB/m)
1	*5762.00	93.3 PK			1.00 H	206	53.00	40.30
2	*5762.00	89.4 AV			1.00 H	206	49.10	40.30
3	11524.00	61.1 PK	74.0	-12.9	1.54 H	6	45.20	15.90
4	11524.00	47.1 AV	54.0	-6.9	1.54 H	6	31.20	15.90

ANTENNA POLARITY & TEST DISTANCE: VERTICAL AT 3 M								
NO.	FREQ. (MHz)	EMISSION LEVEL (dBuV/m)	LIMIT (dBuV/m)	MARGIN (dB)	ANTENNA HEIGHT (m)	TABLE ANGLE (Degree)	RAW VALUE (dBuV)	CORRECTION FACTOR (dB/m)
1	*5762.00	96.5 PK			1.00 V	157	56.20	40.30
2	*5762.00	92.8 AV			1.00 V	157	52.50	40.30
3	11524.00	61.5 PK	74.0	-12.5	1.02 V	321	45.60	15.90
4	11524.00	48.4 AV	54.0	-5.6	1.02 V	321	32.50	15.90

REMARKS:

1. Emission Level(dBuV/m) = Raw Value(dBuV) + Correction Factor(dB/m)
2. Correction Factor(dB/m) = Antenna Factor(dB/m) + Cable Factor(dB) – Pre-Amplifier Factor(dB)
3. The other emission levels were very low against the limit.
4. Margin value = Emission Level – Limit value
5. “ * “: Fundamental frequency.

CHANNEL	TX Channel 162.8	DETECTOR FUNCTION	Peak (PK)
FREQUENCY RANGE	1GHz ~ 40GHz		Average (AV)

ANTENNA POLARITY & TEST DISTANCE: HORIZONTAL AT 3 M								
NO.	FREQ. (MHz)	EMISSION LEVEL (dBuV/m)	LIMIT (dBuV/m)	MARGIN (dB)	ANTENNA HEIGHT (m)	TABLE ANGLE (Degree)	RAW VALUE (dBuV)	CORRECTION FACTOR (dB/m)
1	*5814.00	93.5 PK			1.00 H	207	53.00	40.50
2	*5814.00	90.1 AV			1.00 H	207	49.60	40.50
3	#5850.00	55.7 PK	78.2	-22.5	1.00 H	207	52.30	3.40
4	#5860.10	56.0 PK	74.0	-18.0	1.00 H	207	52.50	3.50
5	#5860.10	42.8 AV	54.0	-11.2	1.00 H	207	39.30	3.50
6	11628.00	60.1 PK	74.0	-13.9	1.00 H	106	44.20	15.90
7	11628.00	47.3 AV	54.0	-6.7	1.00 H	106	31.40	15.90
ANTENNA POLARITY & TEST DISTANCE: VERTICAL AT 3 M								
NO.	FREQ. (MHz)	EMISSION LEVEL (dBuV/m)	LIMIT (dBuV/m)	MARGIN (dB)	ANTENNA HEIGHT (m)	TABLE ANGLE (Degree)	RAW VALUE (dBuV)	CORRECTION FACTOR (dB/m)
1	*5814.00	95.9 PK			1.00 V	157	55.40	40.50
2	*5814.00	92.1 AV			1.00 V	157	51.60	40.50
3	#5850.00	56.0 PK	78.2	-22.2	1.00 V	157	52.60	3.40
4	#5860.10	55.4 PK	74.0	-18.6	1.00 V	157	51.90	3.50
5	#5860.10	42.7 AV	54.0	-11.3	1.00 V	157	39.20	3.50
6	11710.00	61.0 PK	74.0	-13.0	1.04 V	84	45.20	15.80
7	11710.00	49.0 AV	54.0	-5.0	1.04 V	84	33.20	15.80

REMARKS:

1. Emission Level(dBuV/m) = Raw Value(dBuV) + Correction Factor(dB/m)
2. Correction Factor(dB/m) = Antenna Factor(dB/m) + Cable Factor(dB)
– Pre-Amplifier Factor(dB)
3. The other emission levels were very low against the limit.
4. Margin value = Emission Level – Limit value
5. " * ": Fundamental frequency.
6. " # ": The radiated frequency is out of the restricted band.

BELOW 1GHz WORST-CASE DATA:

CHANNEL	TX Channel 36	DETECTOR FUNCTION	Quasi-Peak (QP)
FREQUENCY RANGE	30MHz ~ 1GHz		

ANTENNA POLARITY & TEST DISTANCE: HORIZONTAL AT 3 M								
NO.	FREQ. (MHz)	EMISSION LEVEL (dBuV/m)	LIMIT (dBuV/m)	MARGIN (dB)	ANTENNA HEIGHT (m)	TABLE ANGLE (Degree)	RAW VALUE (dBuV)	CORRECTION FACTOR (dB/m)
1	50.20	32.8 QP	40.0	-7.2	1.99 H	235	46.61	-13.79
2	76.60	32.9 QP	40.0	-7.1	1.99 H	173	50.54	-17.60
3	120.20	33.4 QP	43.5	-10.2	1.99 H	307	49.46	-16.11
4	180.80	26.9 QP	43.5	-16.6	1.00 H	114	42.07	-15.18
5	330.00	31.4 QP	46.0	-14.6	1.00 H	126	43.27	-11.83
6	662.70	33.8 QP	46.0	-12.2	1.00 H	157	39.78	-5.98
ANTENNA POLARITY & TEST DISTANCE: VERTICAL AT 3 M								
NO.	FREQ. (MHz)	EMISSION LEVEL (dBuV/m)	LIMIT (dBuV/m)	MARGIN (dB)	ANTENNA HEIGHT (m)	TABLE ANGLE (Degree)	RAW VALUE (dBuV)	CORRECTION FACTOR (dB/m)
1	34.70	29.7 QP	40.0	-10.3	1.00 V	94	45.25	-15.57
2	51.80	35.7 QP	40.0	-4.3	1.00 V	2	49.41	-13.68
3	68.30	37.7 QP	40.0	-2.3	1.00 V	160	53.64	-15.97
4	113.90	33.8 QP	43.5	-9.7	1.00 V	15	50.57	-16.77
5	126.40	32.6 QP	43.5	-10.9	1.00 V	9	48.33	-15.72
6	662.70	31.6 QP	46.0	-14.4	1.99 V	7	37.60	-5.98

REMARKS:

1. Emission Level(dBuV/m) = Raw Value(dBuV) + Correction Factor(dB/m)
2. Correction Factor(dB/m) = Antenna Factor(dB/m) + Cable Factor(dB) – Pre-Amplifier Factor (dB)
3. The other emission levels were very low against the limit.
4. Margin value = Emission Level – Limit value

4.2 CONDUCTED EMISSION MEASUREMENT

4.2.1 LIMITS OF CONDUCTED EMISSION MEASUREMENT

FREQUENCY OF EMISSION (MHz)	CONDUCTED LIMIT (dB μ V)	
	Quasi-peak	Average
0.15 ~ 0.5	66 to 56	56 to 46
0.5 ~ 5	56	46
5 ~ 30	60	50

- NOTE:** 1. The lower limit shall apply at the transition frequencies.
 2. The limit decreases in line with the logarithm of the frequency in the range of 0.15 to 0.50MHz.
 3. All emanations from a class A/B digital device or system, including any network of conductors and apparatus connected thereto, shall not exceed the level of field strengths specified above.

4.2.2 TEST INSTRUMENTS

DESCRIPTION & MANUFACTURER	MODEL NO.	SERIAL NO.	DATE OF CALIBRATION	DUE DATE OF CALIBRATION
Test Receiver ROHDE & SCHWARZ	ESCS30	100289	Nov. 29, 2013	Nov. 28, 2014
RF signal cable Woken	5D-FB	Cable-HYC01-01	Dec. 27, 2013	Dec. 26, 2014
LISN ROHDE & SCHWARZ (EUT)	ESH3-Z5	835239/001	Feb. 13, 2014	Feb. 12, 2015
LISN ROHDE & SCHWARZ (Peripheral)	ESH3-Z5	100311	Jul. 21, 2014	Jul. 20, 2015
Software ADT	BV ADT_Cond_ V7.3.7.3	NA	NA	NA

- NOTE:** 1. The calibration interval of the above test instruments is 12 months and the calibrations are traceable to NML/ROC and NIST/USA.
 2. The test was performed in HwaYa Shielded Room 1.
 3. The VCCI Site Registration No. is C-2040.

4.2.3 TEST PROCEDURES

- a. The EUT was placed 0.4 meters from the conducting wall of the shielded room with EUT being connected to the power mains through a line impedance stabilization network (LISN). Other support units were connected to the power mains through another LISN. The two LISNs provide 50 ohm/ 50uH of coupling impedance for the measuring instrument.
- b. Both lines of the power mains connected to the EUT were checked for maximum conducted interference.
- c. The frequency range from 150kHz to 30MHz was searched. Emission levels under (Limit - 20dB) were not recorded.

NOTE: All modes of operation were investigated and the worst-case emissions are reported.

4.2.4 DEVIATION FROM TEST STANDARD

No deviation.

4.2.5 TEST SETUP

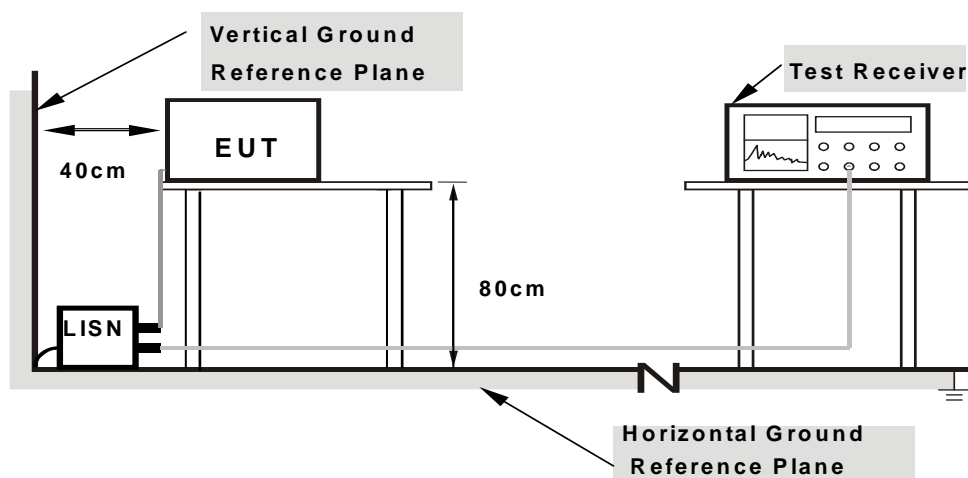

- Note:**
1. Support units were connected to second LISN.
 2. Both of LISNs (AMN) are 80 cm from EUT and at least 80 from other units and other metal planes

For the actual test configuration, please refer to the attached file (Test Setup Photo).

4.2.6 EUT OPERATING CONDITIONS

Same as 4.1.6.

4.2.7 TEST RESULTS

CONDUCTED WORST-CASE DATA:

PHASE	Line 1	6dB BANDWIDTH	9kHz
-------	--------	---------------	------

No	Freq. [MHz]	Corr. Factor (dB)	Reading Value		Emission Level		Limit		Margin	
			[dB (uV)]		[dB (uV)]		[dB (uV)]		(dB)	
			Q.P.	AV.	Q.P.	AV.	Q.P.	AV.	Q.P.	AV.
1	0.15391	0.11	48.89	33.10	49.00	33.21	65.79	55.79	-16.79	-22.58
2	0.22038	0.09	39.75	27.49	39.84	27.58	62.80	52.80	-22.96	-25.22
3	0.41560	0.11	41.39	35.87	41.50	35.98	57.54	47.54	-16.03	-11.55
4	0.67785	0.16	29.50	19.44	29.66	19.60	56.00	46.00	-26.34	-26.40
5	1.74528	0.24	29.42	22.07	29.66	22.31	56.00	46.00	-26.34	-23.69
6	19.99325	1.11	21.99	14.86	23.10	15.97	60.00	50.00	-36.90	-34.03

REMARKS:

1. Q.P. and AV. are abbreviations of quasi-peak and average individually.
2. The emission levels of other frequencies were very low against the limit.
3. Margin value = Emission level - Limit value
4. Correction factor = Insertion loss + Cable loss
5. Emission Level = Correction Factor + Reading Value

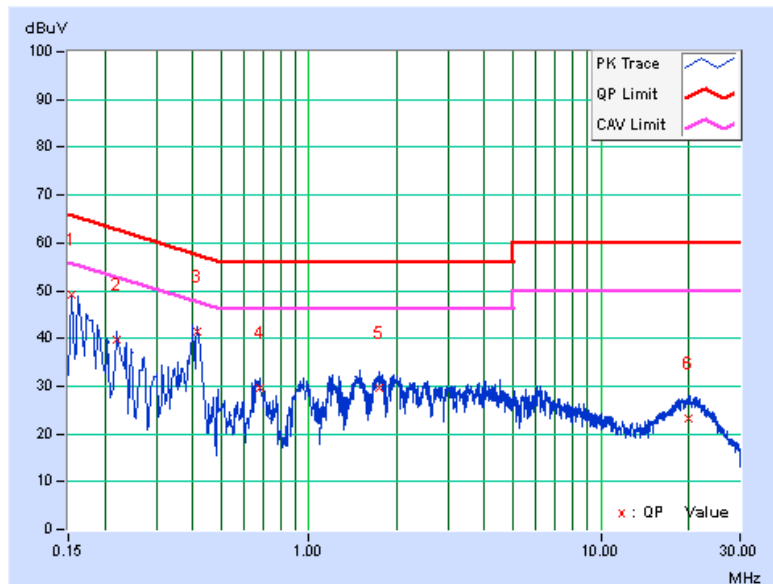



PHASE	Line 2	6dB BANDWIDTH	9kHz
-------	--------	---------------	------

No	Freq. [MHz]	Corr. Factor (dB)	Reading Value		Emission Level		Limit		Margin	
			[dB (uV)]		[dB (uV)]		[dB (uV)]		(dB)	
			Q.P.	AV.	Q.P.	AV.	Q.P.	AV.	Q.P.	AV.
1	0.15000	0.05	50.12	37.24	50.17	37.29	66.00	56.00	-15.83	-18.71
2	0.18519	0.08	45.43	27.79	45.51	27.87	64.25	54.25	-18.74	-26.38
3	0.41560	0.17	41.61	36.21	41.78	36.38	57.54	47.54	-15.75	-11.15
4	0.67003	0.19	31.88	22.57	32.07	22.76	56.00	46.00	-23.93	-23.24
5	1.22134	0.22	30.12	22.14	30.34	22.36	56.00	46.00	-25.66	-23.64
6	20.02453	1.02	24.14	17.94	25.16	18.96	60.00	50.00	-34.84	-31.04

REMARKS:

1. Q.P. and AV. are abbreviations of quasi-peak and average individually.
2. The emission levels of other frequencies were very low against the limit.
3. Margin value = Emission level - Limit value
4. Correction factor = Insertion loss + Cable loss
5. Emission Level = Correction Factor + Reading Value

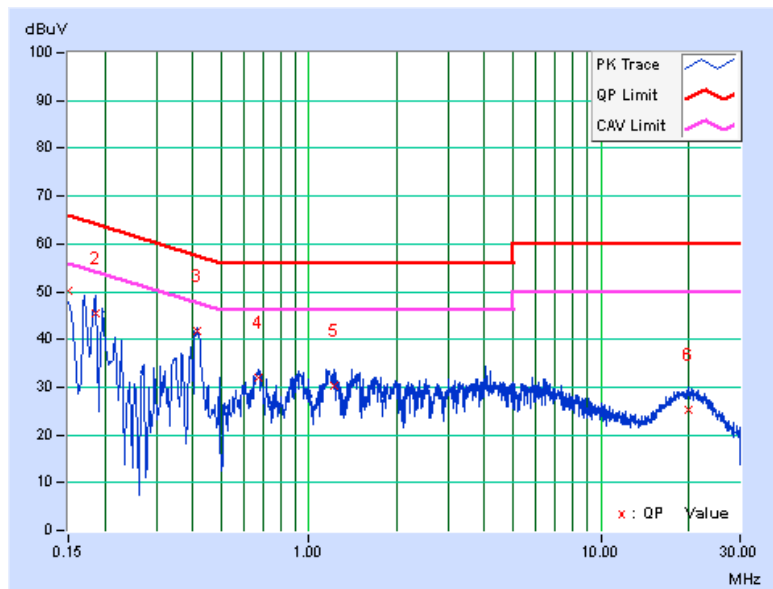

4.3 TRANSMIT POWER MEASUREMENT

4.3.1 LIMITS OF TRANSMIT POWER MEASUREMENT

Operation Band	EUT Category		LIMIT
U-NII-1		Outdoor Access Point	1 Watt (30 dBm) (Max. e.i.r.p \leq 125mW (21 dBm) at any elevation angle above 30 degrees as measured from the horizon)
		Fixed point-to-point Access Point	1 Watt (30 dBm)
		Indoor Access Point	1 Watt (30 dBm)
	√	Mobile and Portable client device	250mW (24 dBm)
U-NII-2A		---	250mW (24 dBm) or 11 dBm+10 log B*
U-NII-2C		---	250mW (24 dBm) or 11 dBm+10 log B*
U-NII-3	√	---	1 Watt (30 dBm)

*B is the 26 dB emission bandwidth in megahertz

4.3.2 TEST SETUP

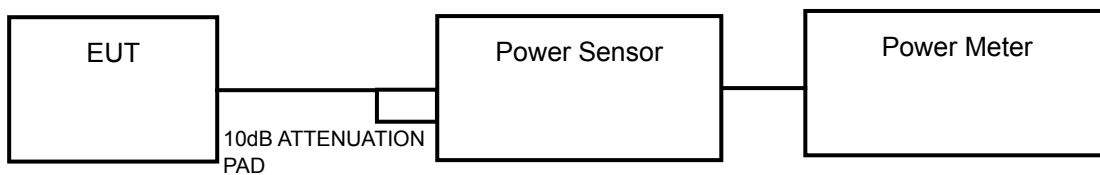

4.3.3 TEST INSTRUMENTS

Refer to section 4.1.3 to get information of above instrument.

4.3.4 TEST PROCEDURE

789033 D02 General UNII Test Procedures New Rules v01 E/3/b

Method PM is used to perform output power measurement, trigger and gating function of wide band power meter is enabled to measure max output power of TX on burst. Duty factor is not added to measured value.

4.3.5 DEVIATION FROM TEST STANDARD

No deviation.

4.3.6 EUT OPERATING CONDITIONS

The software provided by client to enable the EUT under transmission condition continuously at specific channel frequencies individually.

4.3.7 TEST RESULTS

For U-NII-1 Band

CHANNEL	CHANNEL FREQUENCY (MHz)	MAXIMUM CONDUCTED POWER (mW)	MAXIMUM CONDUCTED POWER (dBm)	POWER LIMIT (dBm)	PASS/FAIL
36	5180	5.781	7.62	24	PASS
42	5210	6.397	8.06	24	PASS
48	5240	6.457	8.10	24	PASS

For U-NII-3 Band

CHANNEL	CHANNEL FREQUENCY (MHz)	MAXIMUM CONDUCTED POWER (mW)	MAXIMUM CONDUCTED POWER (dBm)	POWER LIMIT (dBm)	PASS/FAIL
147.2	5736	4.508	6.54	30	PASS
152.4	5762	4.581	6.61	30	PASS
162.8	5814	4.305	6.34	30	PASS

4.4 PEAK POWER SPECTRAL DENSITY MEASUREMENT

4.4.1 LIMITS OF PEAK POWER SPECTRAL DENSITY MEASUREMENT

Operation Band	EUT Category		LIMIT
U-NII-1		Outdoor Access Point	17dBm/ MHz
		Fixed point-to-point Access Point	
		Indoor Access Point	
	√	Mobile and Portable client device	11dBm/ MHz
U-NII-2A		---	11dBm/ MHz
U-NII-2C		---	11dBm/ MHz
U-NII-3	√	---	30dBm/ MHz

4.4.2 TEST SETUP

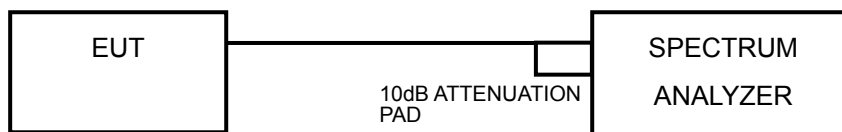

4.4.3 TEST INSTRUMENTS

Refer to section 4.1.3 to get information of above instrument.

4.4.4 TEST PROCEDURES

789033 D02 General UNII Test Procedures New Rules v01 E/2/b

For U-NII-1 Band:

Using method SA-1

- 1) Set span to encompass the entire emission bandwidth (EBW) of the signal.
- 2) Set RBW = 30 kHz, Set VBW \geq 1 MHz, Detector = RMS
- 3) Set Channel power measure = 1MHz
- 4) Sweep time = auto, trigger set to "free run".
- 5) Trace average at least 100 traces in power averaging mode.
- 6) Record the max value

789033 D02 General UNII Test Procedures New Rules v01 F/5

For U-NII-3 band:

- 1) Set the RBW = 500 kHz, VBW = 2MHz, Detector = peak.
- 2) Sweep time = auto couple, Trace mode = max hold, allow trace to fully stabilize.
- 3) Use the peak marker function to determine the maximum power level in any 100 kHz band segment within the fundamental EBW.
- 4) add $10\log(500\text{kHz}/\text{RBW})$ to the measured result

4.4.5 DEVIATION FROM TEST STANDARD

No deviation.

4.4.6 EUT OPERATING CONDITIONS

Same as 4.3.6.

4.4.7 TEST RESULTS

For U-NII-1 Band

CHANNEL	FREQUENCY (MHz)	PSD (dBm)	MAXIMUM LIMIT (dBm)	PASS/FAIL
36	5180	-2.84	11	PASS
42	5210	-2.56	11	PASS
48	5240	-3.13	11	PASS

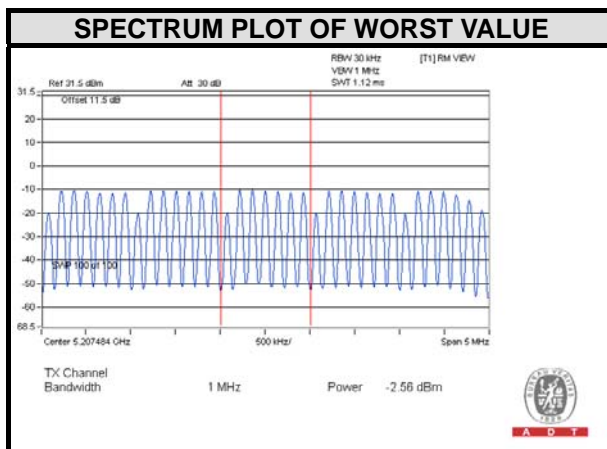



A D T

For U-NII-3 Band

Channel	Freq. (MHz)	PSD (dBm/300kHz)	PSD (dBm/500kHz)	Limit (dBm/500kHz)	PASS /FAIL
147.2	5736	-6.27	-4.05	30	PASS
152.4	5762	-6.44	-4.22	30	PASS
162.8	5814	-6.83	-4.61	30	PASS

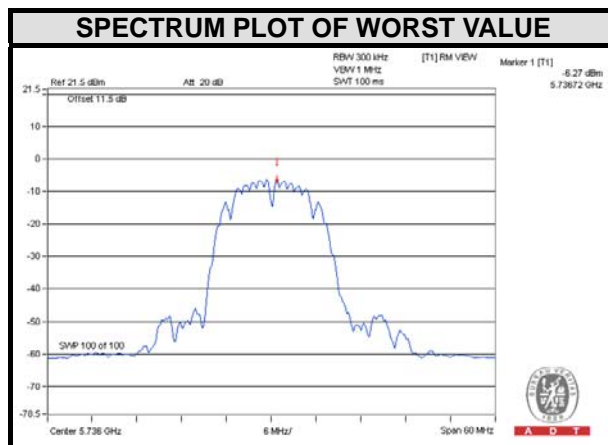

4.5 FREQUENCY STABILITY

4.5.1 LIMITS OF FREQUENCY STABILITY MEASUREMENT

The frequency of the carrier signal shall be maintained within band of operation

4.5.2 TEST SETUP

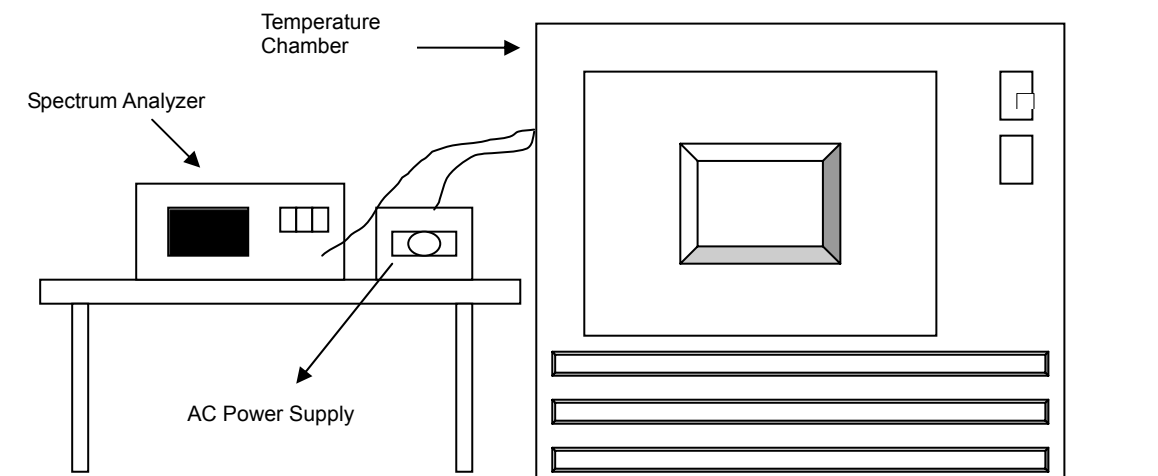

4.5.3 TEST INSTRUMENTS

Refer to section 4.1.3 to get information of above instrument.

4.5.4 TEST PROCEDURE

- a. The EUT was placed inside the environmental test chamber and powered by nominal AC voltage.
- b. Turn the EUT on and couple its output to a spectrum analyzer.
- c. Turn the EUT off and set the chamber to the highest temperature specified.
- d. Allow sufficient time (approximately 30 min) for the temperature of the chamber to stabilize, turn the EUT on and measure the operating frequency after 2, 5, and 10 minutes.
- e. Repeat step 2 and 3 with the temperature chamber set to the lowest temperature.
- f. The test chamber was allowed to stabilize at +20 degree C for a minimum of 30 minutes. The supply voltage was then adjusted on the EUT from 85% to 115% and the frequency record.

4.5.5 DEVIATION FROM TEST STANDARD

No deviation.

4.5.6 EUT OPERATING CONDITION

Set the EUT transmit at un-modulation mode to test frequency stability.

4.5.7 TEST RESULTS

FREQUENCY STABILITY VERSUS TEMP.									
OPERATING FREQUENCY: 5210MHz									
TEMP. (°C)	POWER SUPPLY (Vac)	0 MINUTE		2 MINUTE		5 MINUTE		10 MINUTE	
		Measured Frequency (MHz)	Frequency Drift (%)	Measured Frequency (MHz)	Frequency Drift (%)	Measured Frequency (MHz)	Frequency Drift (%)	Measured Frequency (MHz)	Frequency Drift (%)
50	120	5210.019	0.00036	5210.0177	0.00034	5210.0179	0.00034	5210.0165	0.00032
40	120	5209.9877	-0.00024	5209.9903	-0.00019	5209.9877	-0.00024	5209.9904	-0.00018
30	120	5210.0033	0.00006	5210.0017	0.00003	5210.0022	0.00004	5210.0038	0.00007
20	120	5209.9909	-0.00017	5209.9924	-0.00015	5209.9912	-0.00017	5209.9924	-0.00015
10	120	5210.0198	0.00038	5210.0187	0.00036	5210.0211	0.00040	5210.0199	0.00038
0	120	5209.9979	-0.00004	5209.9999	0.00000	5210.0012	0.00002	5210.0013	0.00002
-10	120	5210.0038	0.00007	5210.0040	0.00008	5210.0067	0.00013	5210.0053	0.00010
-20	120	5209.9736	-0.00051	5209.9774	-0.00043	5209.9781	-0.00042	5209.9737	-0.00050
-30	120	5210.0078	0.00015	5210.0069	0.00013	5210.0085	0.00016	5210.0103	0.00020

FREQUENCY STABILITY VERSUS TEMP.									
OPERATING FREQUENCY: 5210MHz									
TEMP. (°C)	POWER SUPPLY (Vac)	0 MINUTE		2 MINUTE		5 MINUTE		10 MINUTE	
		Measured Frequency (MHz)	Frequency Drift (%)	Measured Frequency (MHz)	Frequency Drift (%)	Measured Frequency (MHz)	Frequency Drift (%)	Measured Frequency (MHz)	Frequency Drift (%)
20	138	5209.9916	-0.00016	5209.9915	-0.00016	5209.9914	-0.00017	5209.9923	-0.00015
	120	5209.9909	-0.00017	5209.9924	-0.00015	5209.9912	-0.00017	5209.9924	-0.00015
	102	5209.9904	-0.00018	5209.9933	-0.00013	5209.9908	-0.00018	5209.9932	-0.00013

4.6 6dB BANDWIDTH MEASUREMENT

4.6.1 LIMITS OF 6dB BANDWIDTH MEASUREMENT

The minimum of 6dB Bandwidth Measurement is 0.5MHz.

4.6.2 TEST SETUP

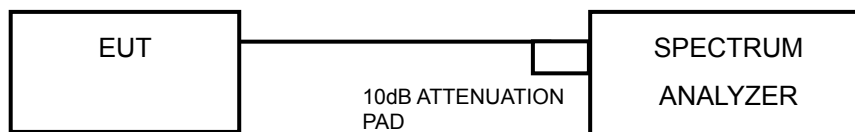

4.6.3 TEST INSTRUMENTS

Refer to section 4.1.2 to get information of above instrument.

4.6.4 TEST PROCEDURE

789033 D02 General UNII Test Procedures New Rules v01 (C)

- a. Set resolution bandwidth (RBW) = 100kHz
- b. Set the video bandwidth (VBW) $\geq 3 \times$ RBW, Detector = Peak.
- c. Trace mode = max hold.
- d. Sweep = auto couple.
- e. Measure the maximum width of the emission that is constrained by the frequencies associated with the two amplitude points (upper and lower) that are attenuated by 6 dB relative to the maximum level measured in the fundamental emission

4.6.5 DEVIATION FROM TEST STANDARD

No deviation.

4.6.6 EUT OPERATING CONDITIONS

The software provided by client to enable the EUT under transmission condition continuously at lowest, middle and highest channel frequencies individually.



A D T

4.6.7 TEST RESULTS

CHANNEL	FREQUENCY (MHz)	6dB BANDWIDTH (MHz)	MINIMUM LIMIT (MHz)	PASS / FAIL
147.2	5736	9.87	0.5	PASS
152.4	5762	9.88	0.5	PASS
162.8	5814	9.88	0.5	PASS

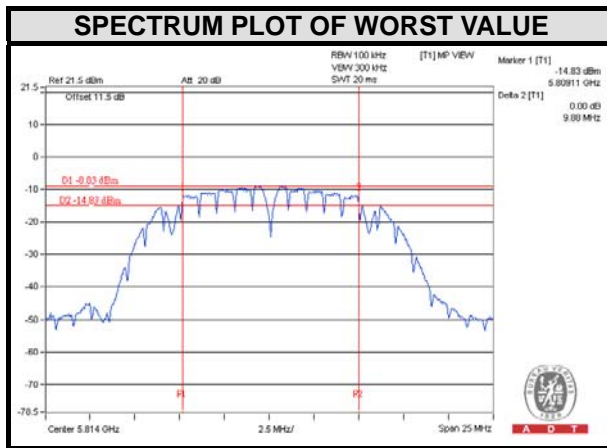

4.7 20dBc BANDWIDTH MEASUREMENT

4.7.1 LIMITS OF PEAK TRANSMIT POWER MEASUREMENT

20dBc point shall not overlap in 5150~5250MHz.

4.7.2 TEST SETUP

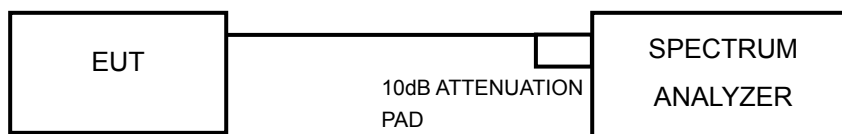

4.7.3 TEST INSTRUMENTS

Refer to section 4.1.3 to get information of above instrument.

4.7.4 TEST PROCEDURE

789033 D02 General UNII Test Procedures New Rules v01 (C)

Emission bandwidth

- 1) Set RBW = approximately 1% of the emission bandwidth.
- 2) Set the VBW > RBW.
- 3) Detector = Peak.
- 4) Trace mode = max hold.
- 5) Measure the maximum width of the emission that is 26 dB down from the peak of the emission. Compare this with the RBW setting of the analyzer. Readjust RBW and repeat measurement as needed until the RBW/EBW ratio is approximately 1%.



A D T

4.7.5 TEST RESULTS

For U-NII-1 Band

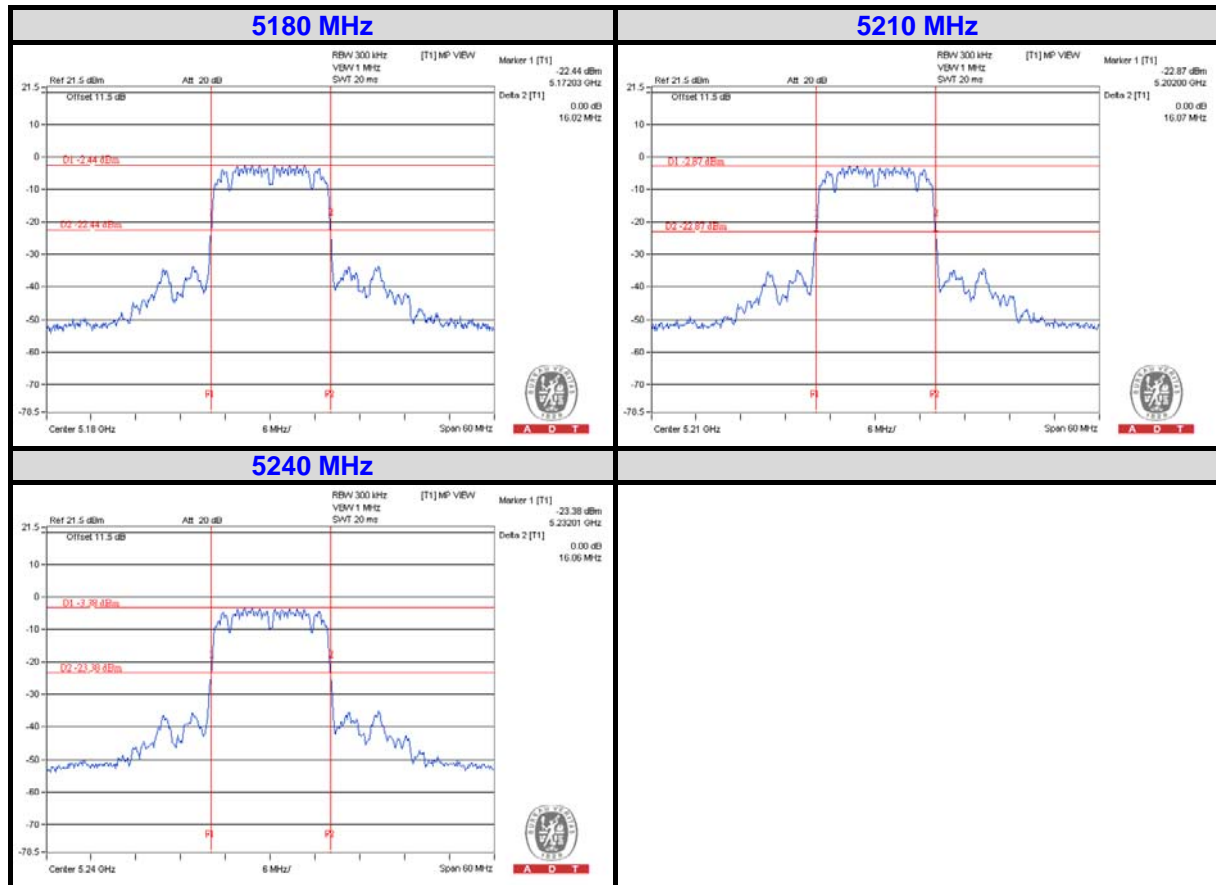



A D T

For U-NII-3 Band

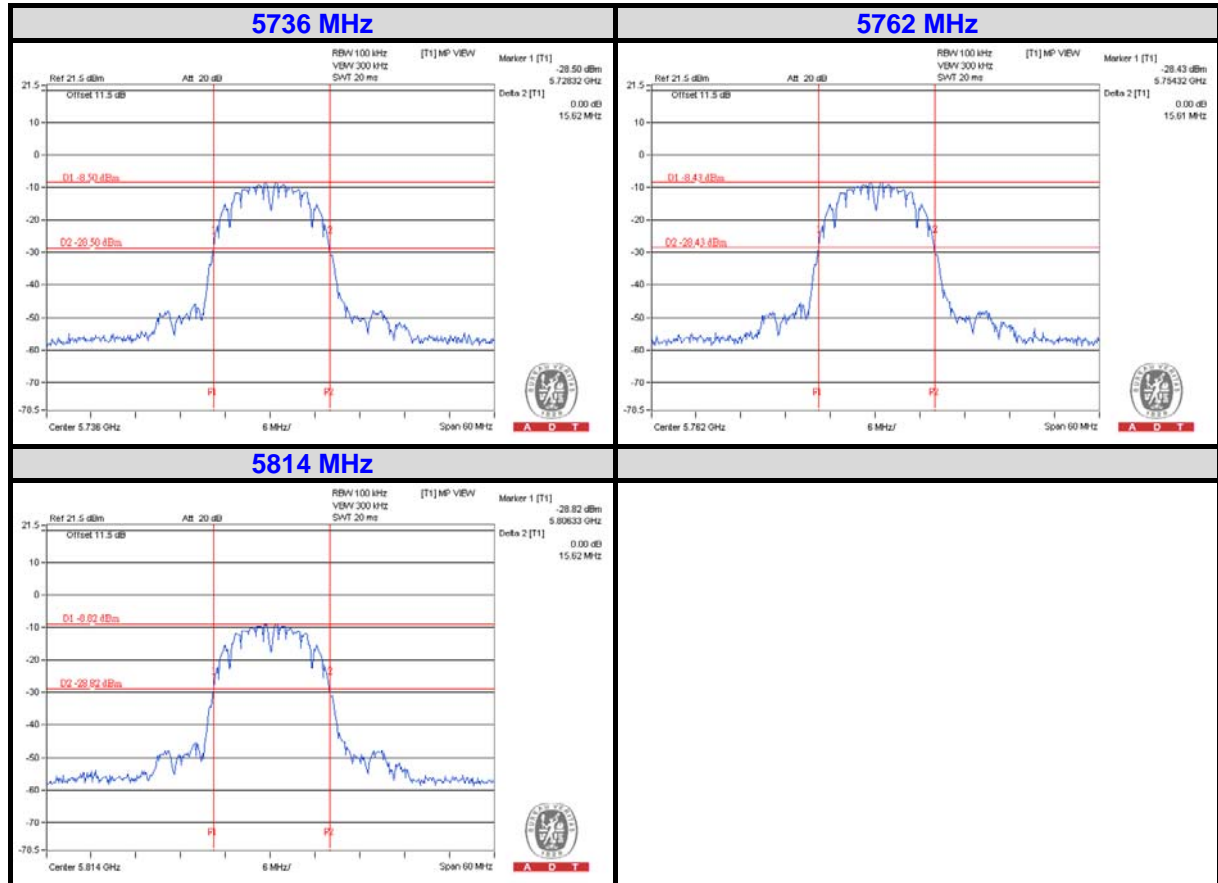

5. PHOTOGRAPHS OF THE TEST CONFIGURATION

Please refer to the attached file (Test Setup Photo).



6. INFORMATION ON THE TESTING LABORATORIES

We, Bureau Veritas Consumer Products Services (H.K.) Ltd., Taoyuan Branch, were founded in 1988 to provide our best service in EMC, Radio, Telecom and Safety consultation. Our laboratories are accredited and approved according to ISO/IEC 17025.

If you have any comments, please feel free to contact us at the following:

Linko EMC/RF Lab:

Tel: 886-2-26052180

Fax: 886-2-26051924

Hsin Chu EMC/RF/Telecom Lab:

Tel: 886-3-5935343

Fax: 886-3-5935342

Hwa Ya EMC/RF/Safety Lab:

Tel: 886-3-3183232

Fax: 886-3-3270892

Email: service.adt@tw.bureauveritas.com

Web Site: www.bureauveritas-adt.com

The address and road map of all our labs can be found in our web site also.

7. APPENDIX A – MODIFICATIONS RECORDERS FOR ENGINEERING CHANGES TO THE EUT BY THE LAB

No modifications were made to the EUT by the lab during the test.

---END---