



FCC TEST REPORT

REPORT NO.: RF120321C23-5

MODEL NO.: F-11D

FCC ID: HFS-IS3

RECEIVED: Mar. 21, 2012

TESTED: Apr. 03 ~ Apr. 06, 2012

ISSUED: May 08, 2012

APPLICANT: Quanta Computer Inc.

ADDRESS: No. 211, Wen Hwa 2nd Road, Kuei Shan Hsiang
Tao Yuan Hsien, Taiwan R.O.C.

ISSUED BY: Bureau Veritas Consumer Products Services
(H.K.) Ltd., Taoyuan Branch

LAB ADDRESS: No. 47, 14th Ling, Chia Pau Vil., Lin Kou Dist.,
New Taipei City, Taiwan (R.O.C.)

TEST LOCATION: No. 19, Hwa Ya 2nd Rd, Wen Hwa Tsuen, Kwei
Shan Hsiang, Taoyuan Hsien 333, Taiwan, R.O.C.

This test report consists of 56 pages in total. It may be duplicated completely for legal use with the approval of the applicant. It should not be reproduced except in full, without the written approval of our laboratory. The client should not use it to claim product, certification, approval or endorsement by TAF or any government agency. The test results in the report only apply to the tested sample.





A D T

Table of Contents

RELEASE CONTROL RECORD.....	4
1. CERTIFICATION.....	5
1. SUMMARY OF TEST RESULTS	6
2.1 MEASUREMENT UNCERTAINTY.....	6
2. GENERAL INFORMATION.....	7
3.1 GENERAL DESCRIPTION OF EUT	7
3.2 DESCRIPTION OF TEST MODES.....	8
3.2.1 TEST MODE APPLICABILITY AND TESTED CHANNEL DETAIL.....	9
3.3 DESCRIPTION OF SUPPORT UNITS	11
3.3.1 CONFIGURATION OF SYSTEM UNDER TEST	11
3.4 GENERAL DESCRIPTION OF APPLIED STANDARDS	11
4. TEST TYPES AND RESULTS	12
4.1 RADIATED EMISSION AND BANDEDGE MEASUREMENT	12
4.1.1 LIMITS OF RADIATED EMISSION AND BANDEDGE MEASUREMENT	12
4.1.2 TEST INSTRUMENTS.....	13
4.1.3 TEST PROCEDURES	14
4.1.4 DEVIATION FROM TEST STANDARD	14
4.1.5 TEST SETUP.....	15
4.1.6 EUT OPERATING CONDITIONS	15
4.1.7 TEST RESULTS	16
4.2 CONDUCTED EMISSION MEASUREMENT	24
4.2.1 LIMITS OF CONDUCTED EMISSION MEASUREMENT	24
4.2.2 TEST INSTRUMENTS.....	24
4.2.3 TEST PROCEDURES	25
4.2.4 DEVIATION FROM TEST STANDARD	25
4.2.5 TEST SETUP.....	26
4.2.6 EUT OPERATING CONDITIONS	26
4.2.7 TEST RESULTS	27
4.3 NUMBER OF HOPPING FREQUENCY USED.....	29
4.3.1 LIMIT OF HOPPING FREQUENCY USED	29
4.3.2 TEST SETUP.....	29
4.3.3 TEST INSTRUMENTS.....	29
4.3.4 TEST PROCEDURES	29
4.3.5 DEVIATION FROM TEST STANDARD	29
4.3.6 TEST RESULTS	29
4.4 DWELL TIME ON EACH CHANNEL	31
4.4.1 LIMIT OF DWELL TIME USED	31
4.4.2 TEST SETUP.....	31
4.4.3 TEST INSTRUMENTS.....	31
4.4.4 TEST PROCEDURES	31
4.4.5 DEVIATION FROM TEST STANDARD	31
4.4.6 TEST RESULTS	32
4.5 CHANNEL BANDWIDTH.....	44
4.5.1 LIMITS OF CHANNEL BANDWIDTH	44
4.5.2 TEST SETUP.....	44
4.5.3 TEST INSTRUMENTS.....	44
4.5.4 TEST PROCEDURE.....	44



A D T

4.5.5	DEVIATION FROM TEST STANDARD	44
4.5.6	EUT OPERATING CONDITION.....	44
4.5.7	TEST RESULTS	45
4.6	HOPPING CHANNEL SEPARATION	46
4.6.1	LIMIT OF HOPPING CHANNEL SEPARATION	46
4.6.2	TEST SETUP	46
4.6.3	TEST INSTRUMENTS	46
4.6.4	TEST PROCEDURES	46
4.6.5	DEVIATION FROM TEST STANDARD	46
4.6.6	TEST RESULTS	47
4.7	MAXIMUM OUTPUT POWER	48
4.7.1	LIMITS OF MAXIMUM OUTPUT POWER MEASUREMENT	48
4.7.2	TEST SETUP	48
4.7.3	TEST INSTRUMENTS	48
4.7.4	TEST PROCEDURES	48
4.7.5	DEVIATION FROM TEST STANDARD	48
4.7.6	EUT OPERATING CONDITION.....	48
4.7.7	TEST RESULTS	49
4.8	CONDUCTED OUT OF BAND EMISSION MEASUREMENT	50
4.8.1	LIMITS OF CONDUCTED OUT OF BAND EMISSION MEASUREMENT	50
4.8.2	TEST INSTRUMENTS	50
4.8.3	TEST PROCEDURE	50
4.8.4	DEVIATION FROM TEST STANDARD	50
4.8.5	EUT OPERATING CONDITION.....	50
4.8.6	TEST RESULTS	50
5.	PHOTOGRAPHS OF THE TEST CONFIGURATION.....	54
6.	INFORMATION ON THE TESTING LABORATORIES	55
7.	APPENDIX A - MODIFICATIONS RECORDERS FOR ENGINEERING CHANGES TO THE EUT BY THE LAB	56



RELEASE CONTROL RECORD

ISSUE NO.	REASON FOR CHANGE	DATE ISSUED
RF120321C23-5	Original release	May 08, 2012



1. CERTIFICATION

PRODUCT: Smart Phone
MODEL NO.: F-11D
BRAND: Fujitsu
APPLICANT: Quanta Computer Inc.
TESTED: Apr. 03 ~ Apr. 06, 2012
TEST SAMPLE: Production Unit
STANDARDS: **FCC Part 15, Subpart C (Section 15.247)**
ANSI C63.10-2009

The above equipment (model: F-11D) has been tested by **Bureau Veritas Consumer Products Services (H.K.) Ltd., Taoyuan Branch**, and found compliance with the requirement of the above standards. The test record, data evaluation & Equipment Under Test (EUT) configurations represented herein are true and accurate accounts of the measurements of the sample's EMC characteristics under the conditions specified in this report.

PREPARED BY :  , **DATE** : May 08, 2012
Pettie Chen / Specialist

APPROVED BY :  , **DATE** : May 08, 2012
Gary Chang / Technical Manager

1. SUMMARY OF TEST RESULTS

The EUT has been tested according to the following specifications:

APPLIED STANDARD: FCC Part 15, Subpart C			
STANDARD SECTION	TEST TYPE AND LIMIT	RESULT	REMARK
15.207	AC Power Conducted Emission	PASS	Meet the requirement of limit. Minimum passing margin is -8.93dB at 0.16172MHz.
15.247(a)(1) (iii)	Number of Hopping Frequency Used	PASS	Meet the requirement of limit.
15.247(a)(1) (iii)	Dwell Time on Each Channel	PASS	Meet the requirement of limit.
15.247(a)(1)	1. Hopping Channel Separation 2. Spectrum Bandwidth of a Frequency Hopping Sequence Spread Spectrum System	PASS	Meet the requirement of limit.
15.247(b)	Maximum Peak Output Power	PASS	Meet the requirement of limit.
15.247(d)	Transmitter Radiated Emissions	PASS	Meet the requirement of limit. Minimum passing margin is -7.29dB at 465.90MHz.
15.247(d)	Band Edge Measurement	PASS	Meet the requirement of limit.
15.203	Antenna Requirement	PASS	No antenna connector is used.

NOTE: If The Frequency Hopping System operating in 2400-2483.5MHz band and the output power less than 125mW. The hopping channel carrier frequencies separated by a minimum of 25kHz or two-thirds of the 20dB bandwidth of hopping channel whichever is greater.

2.1 MEASUREMENT UNCERTAINTY

Where relevant, the following measurement uncertainty levels have been estimated for tests performed on the EUT as specified in CISPR 16-4-2:

MEASUREMENT	FREQUENCY	UNCERTAINTY
Conducted emissions	9kHz~30MHz	2.44 dB
Radiated emissions	30MHz ~ 200MHz	2.93 dB
	200MHz ~1000MHz	2.95 dB
	1GHz ~ 18GHz	2.26 dB
	18GHz ~ 40GHz	1.94 dB

This uncertainty represents an expanded uncertainty expressed at approximately the 95% confidence level using a coverage factor of k=2.



2. GENERAL INFORMATION

3.1 GENERAL DESCRIPTION OF EUT

EUT	Smart Phone
MODEL NO.	F-11D
POWER SUPPLY	5.0Vdc (adapter or host equipment) 3.8Vdc (battery)
MODULATION TYPE	GFSK, $\pi/4$ -DQPSK, 8DPSK
MODULATION TECHNOLOGY	FHSS
TRANSFER RATE	1/2/3Mbps
OPERATING FREQUENCY	2402 ~ 2480MHz
NUMBER OF CHANNEL	79
MAX. OUTPUT POWER	0.0017W
ANTENNA TYPE	PIFAntenna with 1.5dBi gain
ANTENNA CONNECTOR	N/A
I/O PORTS	Refer to users' manual
DATA CABLE	Refer to Note as below
ACCESSORY DEVICES	Refer to Note as below

NOTE:

1. The EUT's accessories listed as below.

AC Adapter (not for sale)	Brand Name	TPT
	Model Name	MII050100
	Power Rating	I/P:100-240Vac, 50-60Hz, 13~17VA; 0.5A O/P: 5Vdc, 1A
	DC Power Cord Type	1.23 meter non-shielded cable without ferrite core
Battery	Brand Name	Fujitsu
	Model Name	IS3
	Power Rating	3.8Vdc, 1520mAh, 5.78Wh
Camera (Front)	Type	Li-ion
	Brand Name	None
	Model Name	None
Camera (Back)	Brand Name	MCNEX
	Model Name	IS3_5M_AF MC520B-2DB1E0149

*The AC adapter is for support unit only.

2. The above EUT information is declared by manufacturer and for more detailed features description, please refer to the manufacturer's specifications or User's Manual.



3.2 DESCRIPTION OF TEST MODES

79 channels are provided to this EUT:

CHANNEL	FREQ. (MHz)	CHANNEL	FREQ. (MHz)	CHANNEL	FREQ. (MHz)	CHANNEL	FREQ. (MHz)
0	2402	20	2422	40	2442	60	2462
1	2403	21	2423	41	2443	61	2463
2	2404	22	2424	42	2444	62	2464
3	2405	23	2425	43	2445	63	2465
4	2406	24	2426	44	2446	64	2466
5	2407	25	2427	45	2447	65	2467
6	2408	26	2428	46	2448	66	2468
7	2409	27	2429	47	2449	67	2469
8	2410	28	2430	48	2450	68	2470
9	2411	29	2431	49	2451	69	2471
10	2412	30	2432	50	2452	70	2472
11	2413	31	2433	51	2453	71	2473
12	2414	32	2434	52	2454	72	2474
13	2415	33	2435	53	2455	73	2475
14	2416	34	2436	54	2456	74	2476
15	2417	35	2437	55	2457	75	2477
16	2418	36	2438	56	2458	76	2478
17	2419	37	2439	57	2459	77	2479
18	2420	38	2440	58	2460	78	2480
19	2421	39	2441	59	2461		



3.2.1 TEST MODE APPLICABILITY AND TESTED CHANNEL DETAIL

EUT CONFIGURE MODE	APPLICABLE TO				DESCRIPTION
	RE \geq 1G	RE<1G	PLC	APCM	
-	√	√	√	√	-

Where **RE \geq 1G**: Radiated Emission above 1GHz **RE<1G**: Radiated Emission below 1GHz
PLC: Power Line Conducted Emission **APCM**: Antenna Port Conducted Measurement

NOTE:
The EUT had been pre-tested on the positioned of each 3 axis. The worst case was found when positioned on **X-plane**.

RADIATED EMISSION TEST (ABOVE 1 GHz):

- Pre-Scan has been conducted to determine the worst-case mode from all possible combinations between available modulations, antenna ports (if EUT with antenna diversity architecture) and packet type.
- Following channel(s) was (were) selected for the final test as listed below.

EUT CONFIGURE MODE	AVAILABLE CHANNEL	TESTED CHANNEL	MODULATION TECHNOLOGY	MODULATION TYPE	PACKET TYPE
-	0 to 78	0, 78	FHSS	GFSK	DH5

RADIATED EMISSION TEST (BELOW 1 GHz):

- Pre-Scan has been conducted to determine the worst-case mode from all possible combinations between available modulations, antenna ports (if EUT with antenna diversity architecture) and packet type.
- Following channel(s) was (were) selected for the final test as listed below.

EUT CONFIGURE MODE	AVAILABLE CHANNEL	TESTED CHANNEL	MODULATION TECHNOLOGY	MODULATION TYPE	PACKET TYPE
-	0 to 78	39	FHSS	GFSK	DH5

POWER LINE CONDUCTED EMISSION TEST:

- Pre-Scan has been conducted to determine the worst-case mode from all possible combinations between available modulations, antenna ports (if EUT with antenna diversity architecture) and packet type.
- Following channel(s) was (were) selected for the final test as listed below.

EUT CONFIGURE MODE	AVAILABLE CHANNEL	TESTED CHANNEL	MODULATION TECHNOLOGY	MODULATION TYPE	PACKET TYPE
-	0 to 78	39	FHSS	GFSK	DH5



BANDEDGE MEASUREMENT:

- Pre-Scan has been conducted to determine the worst-case mode from all possible combinations between available modulations, antenna ports (if EUT with antenna diversity architecture), and packet types.
- Following channel(s) was (were) selected for the final test as listed below.

EUT CONFIGURE MODE	AVAILABLE CHANNEL	TESTED CHANNEL	MODULATION TECHNOLOGY	MODULATION TYPE	PACKET TYPE
-	0 to 78	0, 78	FHSS	GFSK	DH5
-	0 to 78	0, 78	FHSS	8DPSK	DH5

ANTENNA PORT CONDUCTED MEASUREMENT:

- This item includes all test value of each mode, but only includes spectrum plot of worst value of each mode.
- Pre-Scan has been conducted to determine the worst-case mode from all possible combinations between available modulations, antenna ports (if EUT with antenna diversity architecture), and packet types.
- Following channel(s) was (were) selected for the final test as listed below.

EUT CONFIGURE MODE	AVAILABLE CHANNEL	TESTED CHANNEL	MODULATION TECHNOLOGY	MODULATION TYPE	PACKET TYPE
-	0 to 78	0, 78	FHSS	GFSK	DH5
-	0 to 78	0, 78	FHSS	$\pi/4$ -DQPSK	DH5
-	0 to 78	0, 78	FHSS	8DPSK	DH5

TEST CONDITION:

APPLICABLE TO	ENVIRONMENTAL CONDITIONS	INPUT POWER	TESTED BY
RE \geq 1G	25deg. C, 65%RH	120Vac, 60Hz	Kay Wu
RE<1G	25deg. C, 65%RH	120Vac, 60Hz	Kay Wu
PLC	25deg. C, 65%RH	120Vac, 60Hz	David Huang
APCM	22deg. C, 65%RH	120Vac, 60Hz	Phoenix Chen

3.3 DESCRIPTION OF SUPPORT UNITS

The EUT has been tested as an independent unit together with other necessary accessories or support units. The following support units or accessories were used to form a representative test configuration during the tests.

NO.	PRODUCT	BRAND	MODEL NO.	SERIAL NO.	FCC ID
1	Earphone	NA	NA	NA	NA

NO.	SIGNAL CABLE DESCRIPTION OF THE ABOVE SUPPORT UNITS
1	1.5m non-shielded cable

NOTE: All power cords of the above support units are non-shielded (1.8 m).

3.3.1 CONFIGURATION OF SYSTEM UNDER TEST

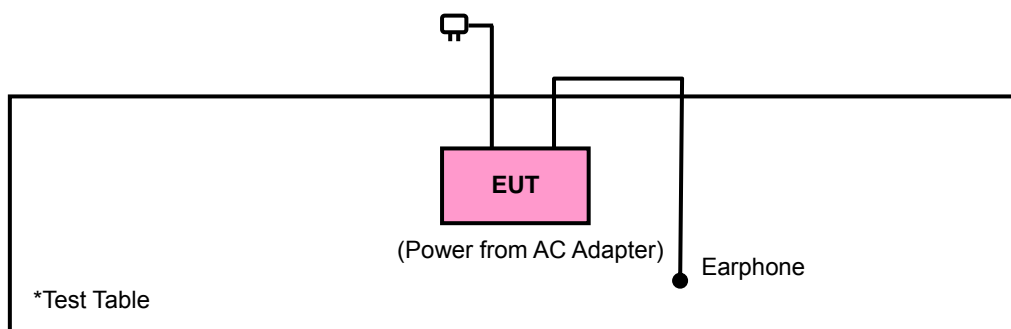

3.4 GENERAL DESCRIPTION OF APPLIED STANDARDS

The EUT is a RF Product. According to the specifications of the manufacturer, it must comply with the requirements of the following standards:

FCC Part 15, Subpart C. (15.247)

ANSI C63.10-2009

558074 D01 DTS Meas Guidance v01

All test items have been performed and recorded as per the above standards.

NOTE: The EUT is also considered as a kind of computer peripheral, because the connection to computer is necessary for typical use. It has been verified to comply with the requirements of FCC Part 15, Subpart B, Class B (DoC). The test report has been issued separately.

4. TEST TYPES AND RESULTS

4.1 RADIATED EMISSION AND BANDEGE MEASUREMENT

4.1.1 LIMITS OF RADIATED EMISSION AND BANDEGE MEASUREMENT

Radiated emissions which fall in the restricted bands must comply with the radiated emission limits specified as below table. Other emissions shall be at least 20dB below the highest level of the desired power:

FREQUENCIES (MHz)	FIELD STRENGTH (microvolts/meter)	MEASUREMENT DISTANCE (meters)
0.009 ~ 0.490	2400/F(kHz)	300
0.490 ~ 1.705	24000/F(kHz)	30
1.705 ~ 30.0	30	30
30 ~ 88	100	3
88 ~ 216	150	3
216 ~ 960	200	3
Above 960	500	3

NOTE:

1. The lower limit shall apply at the transition frequencies.
2. Emission level (dBuV/m) = 20 log Emission level (uV/m).
3. For frequencies above 1000MHz, the field strength limits are based on average detector, however, the peak field strength of any emission shall not exceed the maximum permitted average limits, specified above by more than 20dB under any condition of modulation.



A D T

4.1.2 TEST INSTRUMENTS

DESCRIPTION & MANUFACTURER	MODEL NO.	SERIAL NO.	DATE OF CALIBRATION	DUE DATE OF CALIBRATION
Test Receiver Agilent	N9038A	MY51210203	Dec. 22, 2011	Dec. 21, 2012
Spectrum Analyzer ROHDE & SCHWARZ	FSU43	101261	Dec. 21, 2011	Dec. 20, 2012
BILOG Antenna SCHWARZBECK	VULB9168	9168-472	Dec. 20, 2011	Dec. 19, 2012
HORN Antenna SCHWARZBECK	BBHA 9120 D	9120D-969	Dec. 20, 2011	Dec. 19, 2012
HORN Antenna SCHWARZBECK	BBHA 9170	9170-480	Dec. 20, 2011	Dec. 19, 2012
Loop Antenna	HFH2-Z2	100070	Jan. 31, 2012	Jan. 30, 2014
Preamplifier EMCI	EMC 012645	980115	Dec. 30, 2011	Dec. 29, 2012
Preamplifier EMCI	EMC 330H	980112	Dec. 30, 2011	Dec. 29, 2012
RF signal cable HUBER+SUHNNER	SUCOFLEX 104	309219/4	Oct. 21, 2011	Oct. 20, 2012
RF signal cable HUBER+SUHNNER	SUCOFLEX 104	250130/4	Jan. 02, 2012	Jan. 01, 2013
RF signal cable Worken	RG-213	NA	Jan. 02, 2012	Jan. 01, 2013
Software	E3 6.120103	NA	NA	NA
Antenna Tower MF	MFA-440H	NA	NA	NA
Turn Table MF	MFT-201SS	NA	NA	NA
Antenna Tower & Turn Table Controller MF	MF-7802	NA	NA	NA
Mini-Circuits Power Splitter	ZN2PD-9G	NA	May 25, 2011	May 24, 2012
JFW 20dB attenuation	50HF-020-SMA	NA	NA	NA
High Speed Peak Power Meter	ML2495A	0842014	Apr. 26, 2011	Apr. 25, 2012
Power Sensor	MA2411B	0738404	Apr. 26, 2011	Apr. 25, 2012

- NOTE:**
1. The calibration interval of the above test instruments except loop antenna is 12 months and the calibrations are traceable to NML/ROC and NIST/USA.
 2. The calibration interval of loop antenna is 24 months and the calibrations are traceable to NML/ROC and NIST/USA.
 3. The test was performed in HwaYa Chamber 9.
 4. The horn antenna and HP preamplifier (model: 8449B) are used only for the measurement of emission frequency above 1GHz if tested.
 5. The FCC Site Registration No. is 460141.
 6. The IC Site Registration No. is IC 7450F-4.

4.1.3 TEST PROCEDURES

- a. The EUT was placed on the top of a rotating table 0.8 meters above the ground at a 3 meter semi-anechoic chamber. The table was rotated 360 degrees to determine the position of the highest radiation.
- b. The EUT was set 3 meters away from the interference-receiving antenna, which was mounted on the top of a variable-height antenna tower.
- c. The antenna is a broadband antenna, and its height is varied from one meter to four meters above the ground to determine the maximum value of the field strength. Both horizontal and vertical polarizations of the antenna are set to make the measurement.
- d. For each suspected emission, the EUT was arranged to its worst case and then the antenna was tuned to heights from 1 meter to 4 meters and the rotatable table was turned from 0 degrees to 360 degrees to find the maximum reading.
- e. The test-receiver system was set to Peak Detect Function and Specified Bandwidth with Maximum Hold Mode.
- f. If the emission level of the EUT in peak mode was lower than the limit specified, then testing could be stopped and the peak values of the EUT would be reported. Otherwise the emissions would be re-tested one by one using peak, quasi-peak or average method as specified and then reported in a data sheet.

NOTE:

1. The resolution bandwidth and video bandwidth of test receiver/spectrum analyzer is 120kHz for Quasi-peak detection at frequency below 1GHz.
2. The resolution bandwidth of test receiver/spectrum analyzer is 1 MHz and video bandwidth is 3MHz for Peak detection at frequency above 1GHz.
3. All modes of operation were investigated and the worst-case emissions are reported.

4.1.4 DEVIATION FROM TEST STANDARD

No deviation.

4.1.5 TEST SETUP

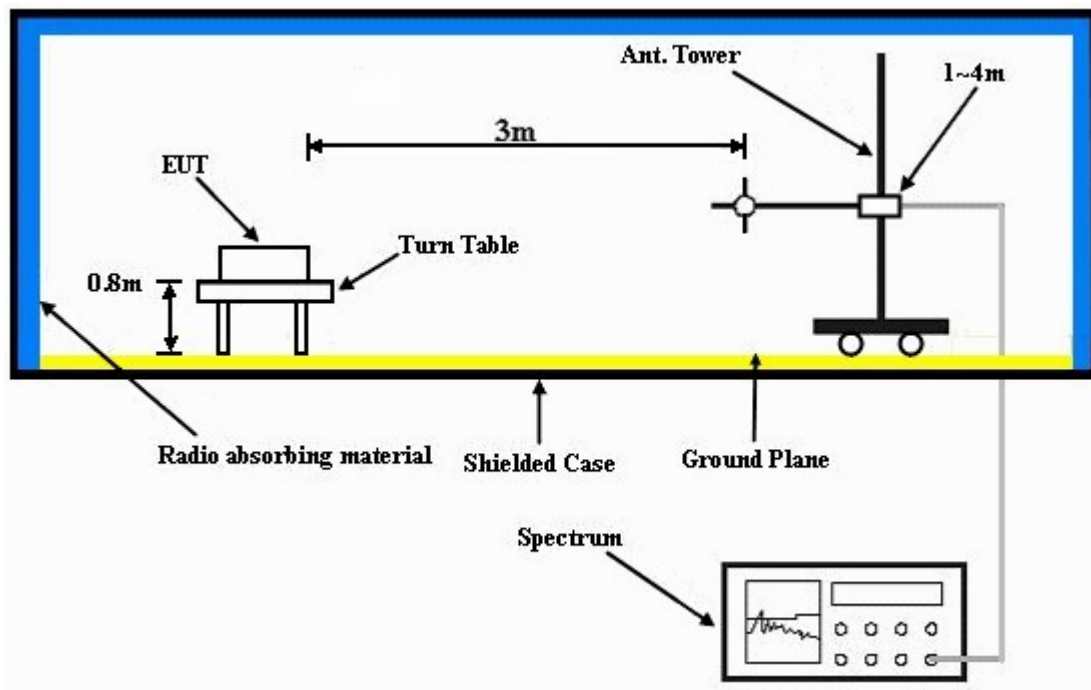

For the actual test configuration, please refer to the attached file (Test Setup Photo).

4.1.6 EUT OPERATING CONDITIONS

Set the EUT under transmission condition continuously at specific channel frequency.



A D T

4.1.7 TEST RESULTS

ABOVE 1GHz:



Bureau Veritas Consumer Products Services Ltd., Taoyuan Branch

A D T

Data: 19

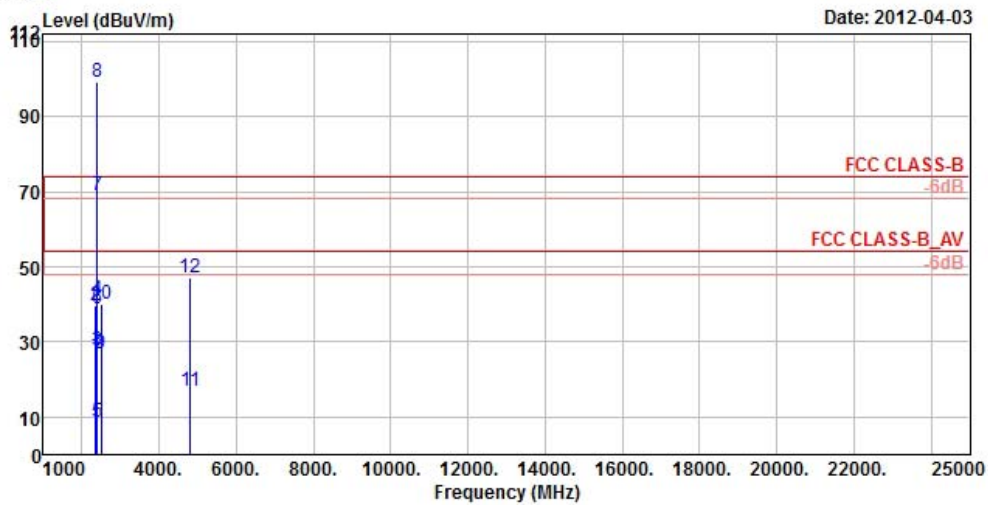

Date: 2012-04-03

Site : 966 Chamber 5
 Condition : FCC CLASS-B 3m ANT_18G~40G_HF HORIZONTAL
 Brand/Model: IS3
 Remark : BT TX CH00(GFSK)
 Tested by : Kay Wu
 Temperature : 25°C
 Humidity : 65%
 Plane : X

	Freq	Level	Read Level	Limit Line	OverLimit	Antenna Factor	Cable Loss	Preamp Factor	A/Pos	T/Pos	Remark
	MHz	dBuV/m	dBuV	dBuV/m	dB	dB/m	dB	dB	cm	deg	
1	2356.00	26.30	31.34	54.00	-27.70	27.16	5.29	37.49	104	214	Average
2	2356.00	39.77	44.81	74.00	-34.23	27.16	5.29	37.49	104	214	Peak
3	2398.00	27.81	32.73	54.00	-26.19	27.26	5.34	37.52	104	214	Average
4	2398.00	41.31	46.23	74.00	-32.69	27.26	5.34	37.52	104	214	Peak
5	2400.00	8.61	13.53	54.00	-45.39	27.26	5.34	37.52	104	214	Average
6	2400.00	38.71	43.63	74.00	-35.29	27.26	5.34	37.52	104	214	Peak
7 av	2402.00	68.94	73.86	54.00	14.94	27.26	5.34	37.52	104	214	Average
8 pp	2402.00	99.04	103.96	74.00	25.04	27.26	5.34	37.52	104	214	Peak
9	2496.00	26.74	31.04	54.00	-27.26	27.55	5.40	37.25	104	214	Average
10	2496.00	40.13	44.43	74.00	-33.87	27.55	5.40	37.25	104	214	Peak
11	4804.00	16.81	30.84	54.00	-37.19	31.38	7.69	53.10	100	84	Average
12	4804.00	46.91	60.94	74.00	-27.09	31.38	7.69	53.10	100	84	Peak

NOTE: Item 7, 8 were fundamental frequency.



A D T



Bureau Veritas Consumer Products Services Ltd., Taoyuan Branch

A D T

Data: 20

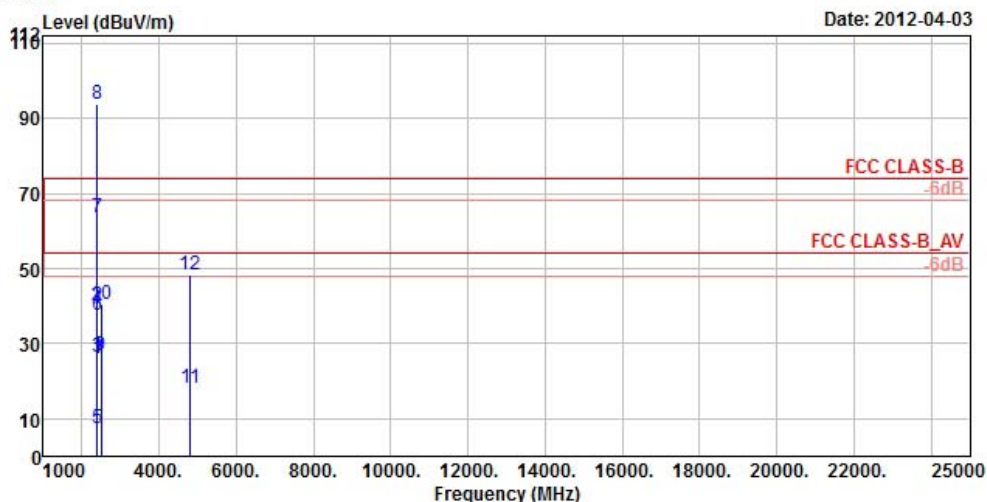

Site : 966 Chamber 5
 Condition : FCC CLASS-B 3m ANT_18G~40G_HF VERTICAL
 Brand/Model: IS3
 Remark : BT TX CH00(GFSK)
 Tested by : Kay Wu
 Temperature : 25°C
 Humidity : 65%
 Plane : X

	Freq	Level	Read Level	Limit Line	OverLimit	Antenna Factor	Cable Loss	Preamp Factor	A/Pos	T/Pos	Remark
	MHz	dBuV/m	dBuV	dBuV/m	dB	dB/m	dB	dB	cm	deg	
1	2386.00	26.22	31.14	54.00	-27.78	27.26	5.32	37.50	103	10	Average
2	2386.00	39.94	44.86	74.00	-34.06	27.26	5.32	37.50	103	10	Peak
3	2398.00	26.35	31.27	54.00	-27.65	27.26	5.34	37.52	103	10	Average
4	2398.00	39.39	44.31	74.00	-34.61	27.26	5.34	37.52	103	10	Peak
5	2400.00	7.52	12.44	54.00	-46.48	27.26	5.34	37.52	103	10	Average
6	2400.00	37.62	42.54	74.00	-36.38	27.26	5.34	37.52	103	10	Peak
7 av	2402.00	63.79	68.71	54.00	9.79	27.26	5.34	37.52	103	10	Average
8 pp	2402.00	93.89	98.81	74.00	19.89	27.26	5.34	37.52	103	10	Peak
9	2496.00	26.71	31.01	54.00	-27.29	27.55	5.40	37.25	103	10	Average
10	2496.00	40.55	44.85	74.00	-33.45	27.55	5.40	37.25	103	10	Peak
11	4804.00	18.39	32.42	54.00	-35.61	31.38	7.69	53.10	100	210	Average
12	4804.00	48.49	62.52	74.00	-25.51	31.38	7.69	53.10	100	210	Peak

NOTE: Item 7, 8 were fundamental frequency.



A D T



Bureau Veritas Consumer Products Services Ltd., Taoyuan Branch

A D T

Data: 19

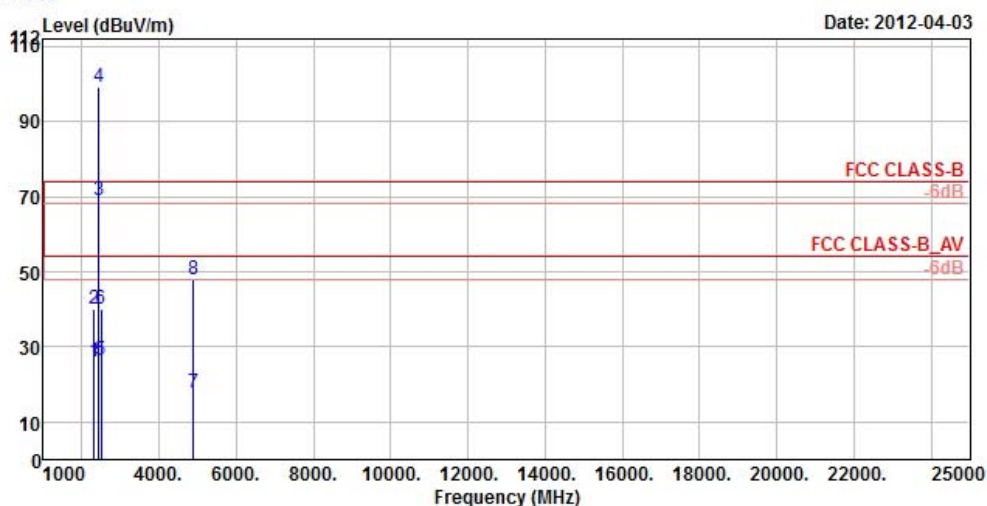

Site : 966 Chamber 5
 Condition : FCC CLASS-B 3m ANT_18G~40G_HF HORIZONTAL
 Brand/Model: IS3
 Remark : BT TX CH39(GFSK)
 Tested by : Kay Wu
 Temperature : 25°C
 Humidity : 65%
 Plane : X

	Freq	Level	Read Level	Limit Line	OverLimit	Antenna Factor	Cable Loss	Preamp Factor	A/Pos	T/Pos	Remark
	MHz	dBuV/m	dBuV	dBuV/m	dB	dB/m	dB	dB	cm	deg	
1	2316.00	25.95	31.14	54.00	-28.05	27.01	5.27	37.47	101	218	Average
2	2316.00	40.25	45.44	74.00	-33.75	27.01	5.27	37.47	101	218	Peak
3 av	2441.00	69.19	73.81	54.00	15.19	27.40	5.37	37.39	101	218	Average
4 pp	2441.00	99.29	103.91	74.00	25.29	27.40	5.37	37.39	101	218	Peak
5	2500.00	26.64	30.94	54.00	-27.36	27.55	5.40	37.25	101	218	Average
6	2500.00	40.02	44.32	74.00	-33.98	27.55	5.40	37.25	101	218	Peak
7	4882.00	17.71	31.51	54.00	-36.29	31.53	7.72	53.05	100	153	Average
8	4882.00	47.81	61.61	74.00	-26.19	31.53	7.72	53.05	100	153	Peak

NOTE: Item 3, 4 were fundamental frequency.



A D T



Bureau Veritas Consumer Products Services Ltd., Taoyuan Branch

A D T

Data: 20

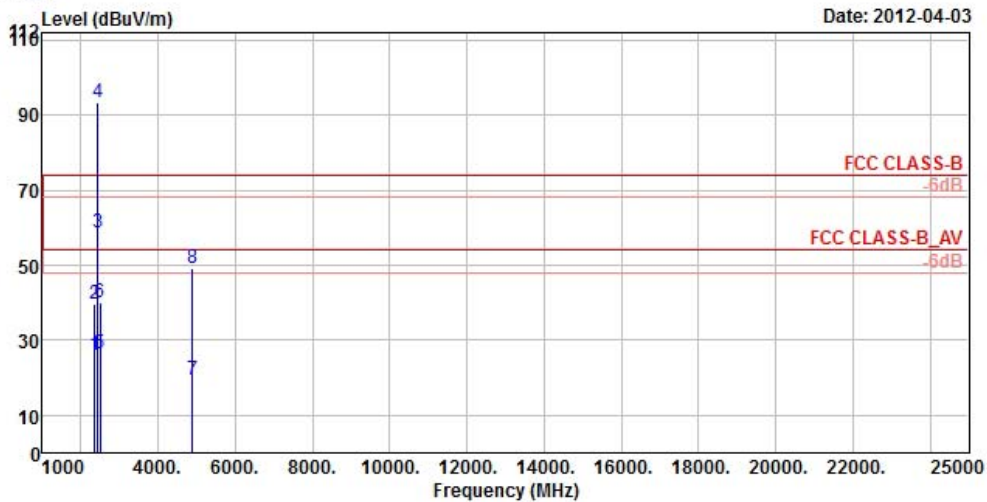

Site : 966 Chamber 5
 Condition : FCC CLASS-B 3m ANT_18G~40G_HF VERTICAL
 Brand/Model: IS3
 Remark : BT TX CH39(GFSK)
 Tested by : Kay Wu
 Temperature : 25°C
 Humidity : 65%
 Plane : X

	Freq	Level	Read Level	Limit Line	OverLimit	Antenna Factor	Cable Loss	Preamp Factor	A/Pos	T/Pos	Remark
	MHz	dBuV/m	dBuV	dBuV/m	dB	dB/m	dB	dB	cm	deg	
1	2344.00	25.90	30.99	54.00	-28.10	27.11	5.29	37.49	101	3	Average
2	2344.00	39.48	44.57	74.00	-34.52	27.11	5.29	37.49	101	3	Peak
3 av	2441.00	58.55	63.17	54.00	4.55	27.40	5.37	37.39	101	3	Average
4 pp	2441.00	93.26	97.88	74.00	19.26	27.40	5.37	37.39	101	3	Peak
5	2498.00	26.60	30.90	54.00	-27.40	27.55	5.40	37.25	101	3	Average
6	2498.00	40.15	44.45	74.00	-33.85	27.55	5.40	37.25	101	3	Peak
7	4882.00	19.23	33.03	54.00	-34.77	31.53	7.72	53.05	100	41	Average
8	4882.00	49.33	63.13	74.00	-24.67	31.53	7.72	53.05	100	41	Peak

NOTE: Item 3, 4 were fundamental frequency.



A D T



Bureau Veritas Consumer Products Services Ltd., Taoyuan Branch

A D T

Data: 19

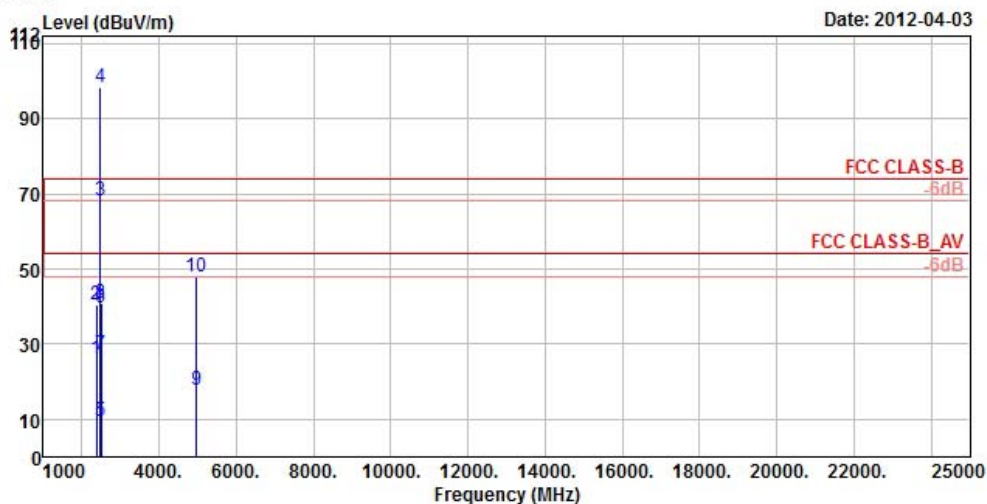

Site : 966 Chamber 5
 Condition : FCC CLASS-B 3m ANT_18G~40G_HF HORIZONTAL
 Brand/Model: IS3
 Remark : BT TX CH78(GFSK)
 Tested by : Kay Wu
 Temperature : 25°C
 Humidity : 65%
 Plane : X

	Freq	Level	Read Level	Limit Line	OverLimit	Antenna Factor	Cable Loss	Preamp Factor	A/Pos	T/Pos	Remark
	MHz	dBuV/m	dBuV	dBuV/m	dB	dB/m	dB	dB	cm	deg	
1	2380.00	26.09	31.06	54.00	-27.91	27.21	5.32	37.50	100	228	Average
2	2380.00	40.44	45.41	74.00	-33.56	27.21	5.32	37.50	100	228	Peak
3 av	2480.00	68.23	72.67	54.00	14.23	27.50	5.38	37.32	100	228	Average
4 pp	2480.00	98.33	102.77	74.00	24.33	27.50	5.38	37.32	100	228	Peak
5	2483.50	9.47	13.91	54.00	-44.53	27.50	5.38	37.32	100	228	Average
6	2483.50	39.57	44.01	74.00	-34.43	27.50	5.38	37.32	100	228	Peak
7	2485.50	27.29	31.73	54.00	-26.71	27.50	5.38	37.32	100	228	Average
8	2485.50	41.07	45.51	74.00	-32.93	27.50	5.38	37.32	100	228	Peak
9	4960.00	17.67	31.27	54.00	-36.33	31.72	7.72	53.04	100	58	Average
10	4960.00	47.77	61.37	74.00	-26.23	31.72	7.72	53.04	100	58	Peak

NOTE: Item 3, 4 were fundamental frequency.



A D T



Bureau Veritas Consumer Products Services Ltd., Taoyuan Branch

A D T

Data: 20

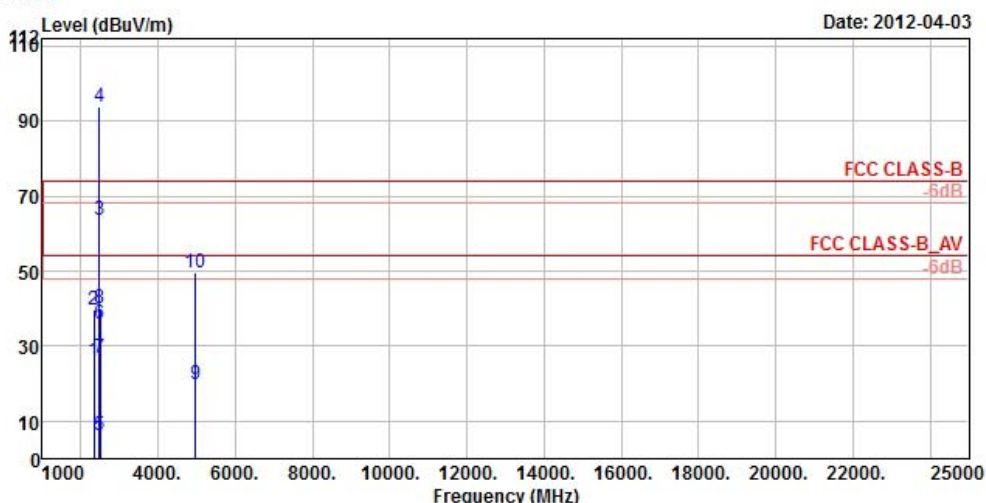

Site : 966 Chamber 5
 Condition : FCC CLASS-B 3m ANT_18G~40G_HF VERTICAL
 Brand/Model: IS3
 Remark : BT TX CH78(GFSK)
 Tested by : Kay Wu
 Temperature : 25°C
 Humidity : 65%
 Plane : X

	Freq	Level	Read Level	Limit Line	OverLimit	Antenna Factor	Cable Loss	Preamp Factor	A/Pos	T/Pos	Remark
	MHz	dBuV/m	dBuV	dBuV/m	dB	dB/m	dB	dB	cm	deg	
1	2342.00	25.93	31.02	54.00	-28.07	27.11	5.29	37.49	127	4	Average
2	2342.00	39.84	44.93	74.00	-34.16	27.11	5.29	37.49	127	4	Peak
3 av	2480.00	63.80	68.24	54.00	9.80	27.50	5.38	37.32	127	4	Average
4 pp	2480.00	93.90	98.34	74.00	19.90	27.50	5.38	37.32	127	4	Peak
5	2483.50	6.06	10.50	54.00	-47.94	27.50	5.38	37.32	127	4	Average
6	2483.50	36.16	40.60	74.00	-37.84	27.50	5.38	37.32	127	4	Peak
7	2485.50	26.67	31.11	54.00	-27.33	27.50	5.38	37.32	127	4	Average
8	2485.50	40.14	44.58	74.00	-33.86	27.50	5.38	37.32	127	4	Peak
9	4960.00	19.65	33.25	54.00	-34.35	31.72	7.72	53.04	100	78	Average
10	4960.00	49.75	63.35	74.00	-24.25	31.72	7.72	53.04	100	78	Peak

NOTE: Item 3, 4 were fundamental frequency.



A D T

BELOW 1GHz WORST-CASE DATA :



Bureau Veritas Consumer Products Services Ltd., Taoyuan Branch

A D T

Data: 5

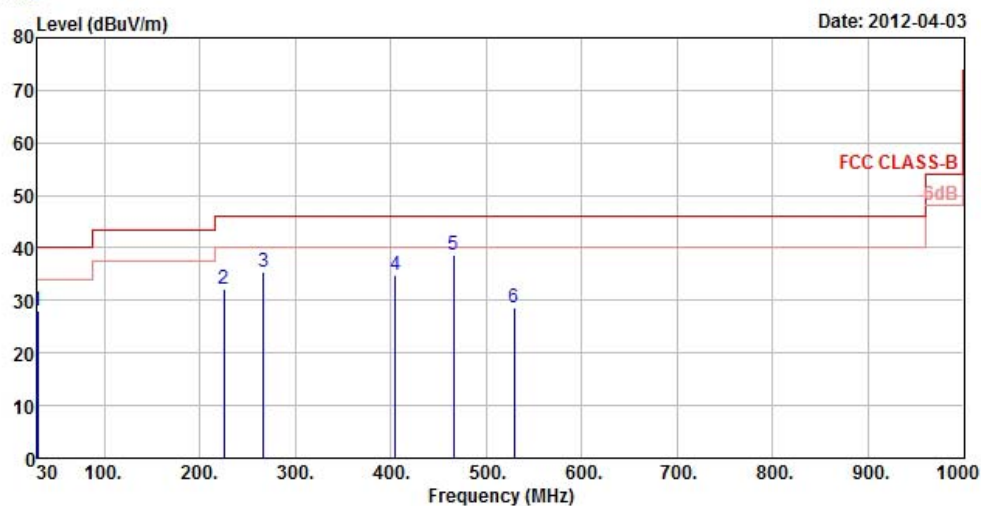

Site : 966 Chamber 5
 Condition : FCC CLASS-B 3m ANT_30M~1G_LF HORIZONTAL
 Brand/Model: IS3
 Remark : BT TX LF(GFSK)
 Tested by : Kay Wu
 Temperature : 25°C
 Humidity : 65%
 Plane : X

	Freq	Level	Read Level	Limit Line	OverLimit	Antenna Factor	Cable Loss	Preamp Factor	A/Pos	T/Pos	Remark
	MHz	dBuV/m	dBuV	dBuV/m	dB	dB/m	dB	dB	cm	deg	
1	30.27	28.17	46.76	40.00	-11.83	11.98	0.57	31.14	100	127	Peak
2	225.48	32.29	51.91	46.00	-13.71	10.46	1.72	31.80	100	107	Peak
3	266.52	35.40	53.51	46.00	-10.60	11.97	1.90	31.98	100	274	Peak
4	405.00	34.94	49.09	46.00	-11.06	15.45	2.45	32.05	100	251	Peak
5 pp	465.90	38.71	51.34	46.00	-7.29	16.64	2.67	31.94	151	127	Peak
6	528.90	28.72	39.55	46.00	-17.28	17.97	2.88	31.68	174	201	Peak



A D T



Bureau Veritas Consumer Products Services Ltd., Taoyuan Branch

A D T

Data: 6

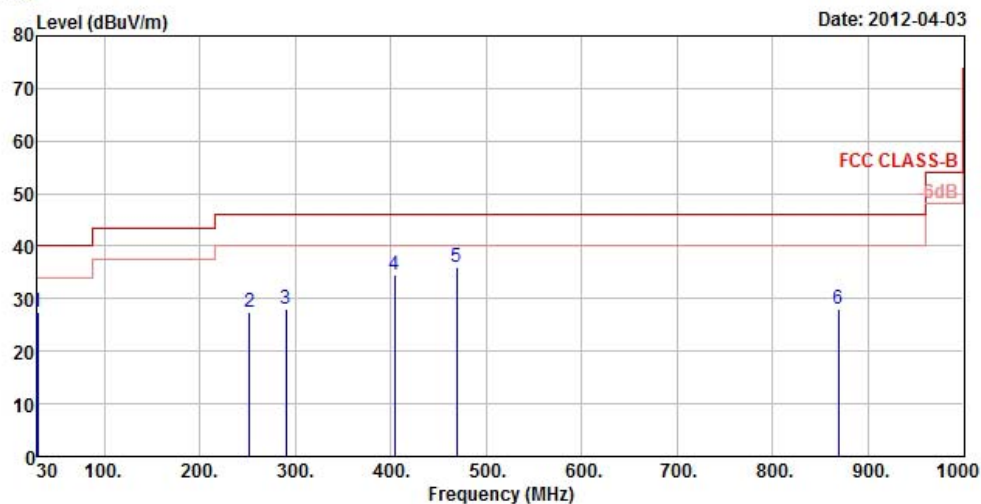

Site : 966 Chamber 5
 Condition : FCC CLASS-B 3m ANT_30M~1G_LF VERTICAL
 Brand/Model: IS3
 Remark : BT TX LF(GFSK)
 Tested by : Kay Wu
 Temperature : 25°C
 Humidity : 65%
 Plane : X

	Freq	Level	Read Level	Limit Line	OverLimit	Antenna Factor	Cable Loss	Preamp Factor	A/Pos	T/Pos	Remark
	MHz	dBuV/m	dBuV	dBuV/m	dB	dB/m	dB	dB	cm	deg	
1	30.27	27.37	45.96	40.00	-12.63	11.98	0.57	31.14	132	217	Peak
2	251.94	27.53	46.07	46.00	-18.47	11.54	1.84	31.92	107	44	Peak
3	290.55	28.13	45.13	46.00	-17.87	12.68	2.01	31.69	120	285	Peak
4	404.30	34.46	48.66	46.00	-11.54	15.43	2.44	32.07	100	37	Peak
5 pp	468.70	36.06	48.59	46.00	-9.94	16.70	2.68	31.91	210	195	Peak
6	869.10	27.91	32.92	46.00	-18.09	23.11	3.88	32.00	100	284	Peak

4.2 CONDUCTED EMISSION MEASUREMENT

4.2.1 LIMITS OF CONDUCTED EMISSION MEASUREMENT

FREQUENCY OF EMISSION (MHz)	CONDUCTED LIMIT (dB μ V)	
	Quasi-peak	Average
0.15 ~ 0.5	66 to 56	56 to 46
0.5 ~ 5	56	46
5 ~ 30	60	50

- NOTE:** 1. The lower limit shall apply at the transition frequencies.
 2. The limit decreases in line with the logarithm of the frequency in the range of 0.15 to 0.50MHz.
 3. All emanations from a class A/B digital device or system, including any network of conductors and apparatus connected thereto, shall not exceed the level of field strengths specified above.

4.2.2 TEST INSTRUMENTS

DESCRIPTION & MANUFACTURER	MODEL NO.	SERIAL NO.	DATE OF CALIBRATION	DUE DATE OF CALIBRATION
Test Receiver ROHDE & SCHWARZ	ESCS30	100289	Nov. 19, 2011	Nov. 18, 2012
RF signal cable Woken	5D-FB	Cable-HYCO2-01	Dec. 22, 2011	Dec. 21, 2012
LISN ROHDE & SCHWARZ	ESH2-Z5	100100	Dec. 30, 2011	Dec. 29, 2012
LISN ROHDE & SCHWARZ	ESH3-Z5	100312	Jul. 07, 2011	Jul. 06, 2012
Software ADT	ADT_Cond_ V7.3.7	NA	NA	NA

- NOTE:** 1. The calibration interval of the above test instruments is 12 months and the calibrations are traceable to NML/ROC and NIST/USA.
 2. The test was performed in HwaYa Shielded Room 2.
 3. The VCCI Site Registration No. is C-2047.

4.2.3 TEST PROCEDURES

- a. The EUT was placed 0.4 meters from the conducting wall of the shielded room with EUT being connected to the power mains through a line impedance stabilization network (LISN). Other support units were connected to the power mains through another LISN. The two LISNs provide 50 ohm/ 50uH of coupling impedance for the measuring instrument.
- b. Both lines of the power mains connected to the EUT were checked for maximum conducted interference.
- c. The frequency range from 150kHz to 30MHz was searched. Emission levels under (Limit - 20dB) was not recorded.

NOTE: All modes of operation were investigated and the worst-case emissions are reported.

4.2.4 DEVIATION FROM TEST STANDARD

No deviation.

4.2.5 TEST SETUP

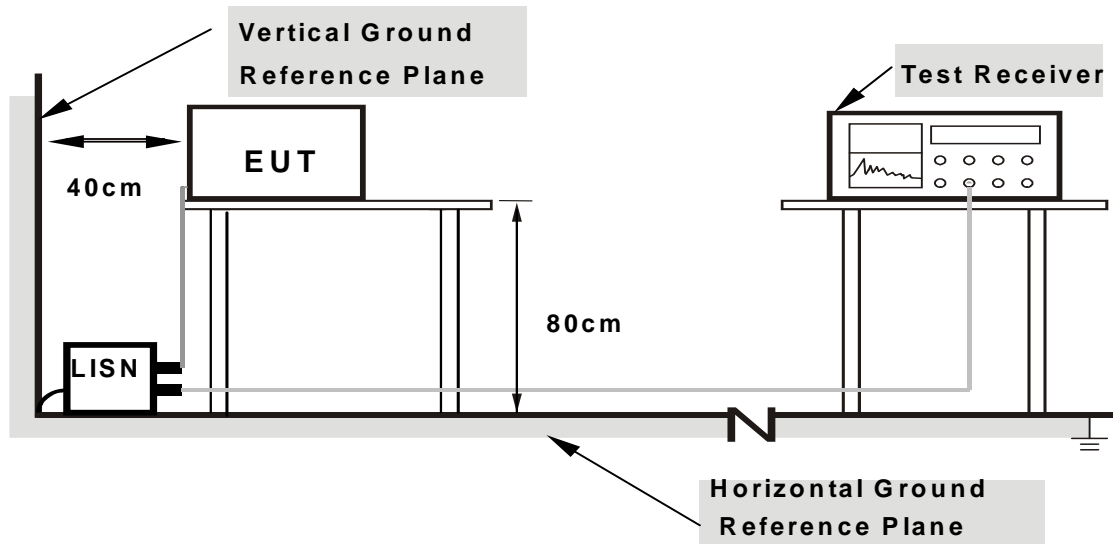

- Note: 1. Support units were connected to second LISN.**
2. Both of LISNs (AMN) are 80 cm from EUT and at least 80 from other units and other metal planes

For the actual test configuration, please refer to the attached file (Test Setup Photo).

4.2.6 EUT OPERATING CONDITIONS

Same as 4.1.6.

4.2.7 TEST RESULTS

CONDUCTED WORST-CASE DATA : GFSK

PHASE	Line 1	6dB BANDWIDTH	9kHz
--------------	--------	----------------------	------

No	Freq. [MHz]	Corr. Factor (dB)	Reading Value		Emission Level		Limit		Margin	
			[dB (uV)]		[dB (uV)]		[dB (uV)]		(dB)	
			Q.P.	AV.	Q.P.	AV.	Q.P.	AV.	Q.P.	AV.
1	0.16172	0.15	56.30	41.86	56.45	42.01	65.38	55.38	-8.93	-13.37
2	0.21641	0.15	51.41	37.40	51.56	37.55	62.96	52.96	-11.39	-15.40
3	0.85703	0.19	31.50	22.08	31.69	22.27	56.00	46.00	-24.31	-23.73
4	1.89063	0.25	31.03	22.32	31.28	22.57	56.00	46.00	-24.72	-23.43
5	7.22266	0.39	24.46	18.50	24.85	18.89	60.00	50.00	-35.15	-31.11
6	27.67969	0.54	36.81	25.99	37.35	26.53	60.00	50.00	-22.65	-23.47

- REMARKS:**
1. Q.P. and AV. are abbreviations of quasi-peak and average individually.
 2. "-": The Quasi-peak reading value also meets average limit and measurement with the average detector is unnecessary.
 3. The emission levels of other frequencies were very low against the limit.
 4. Margin value = Emission level - Limit value
 5. Correction factor = Insertion loss + Cable loss
 6. Emission Level = Correction Factor + Reading Value.

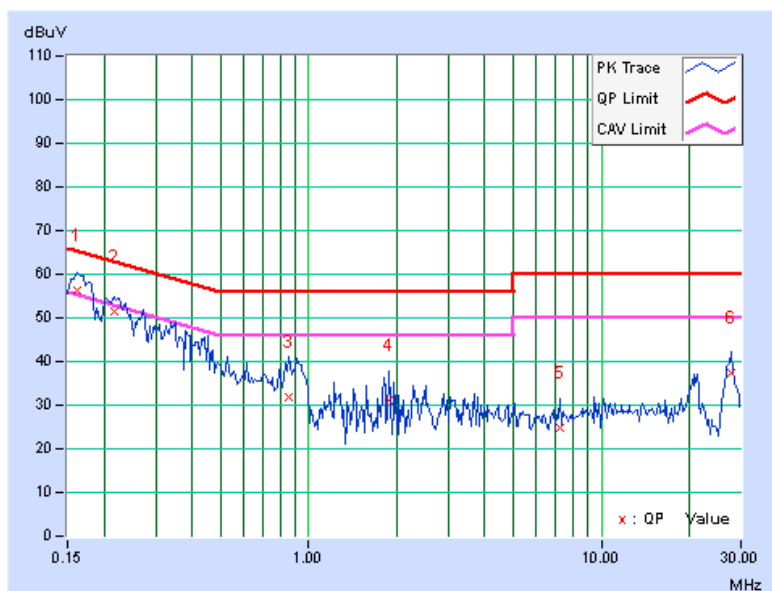



A D T

PHASE	Line 2	6dB BANDWIDTH	9kHz
-------	--------	---------------	------

No	Freq. [MHz]	Corr. Factor (dB)	Reading Value		Emission Level		Limit		Margin	
			[dB (uV)]		[dB (uV)]		[dB (uV)]		(dB)	
			Q.P.	AV.	Q.P.	AV.	Q.P.	AV.	Q.P.	AV.
1	0.15391	0.13	54.36	37.89	54.49	38.02	65.79	55.79	-11.30	-17.77
2	0.21641	0.14	50.99	36.70	51.13	36.84	62.96	52.96	-11.82	-16.11
3	0.95078	0.19	32.19	23.41	32.38	23.60	56.00	46.00	-23.62	-22.40
4	1.43359	0.22	32.27	23.35	32.49	23.57	56.00	46.00	-23.51	-22.43
5	20.73438	0.71	32.86	20.62	33.57	21.33	60.00	50.00	-26.43	-28.67
6	27.57813	0.58	36.83	25.95	37.41	26.53	60.00	50.00	-22.59	-23.47

- REMARKS:**
1. Q.P. and AV. are abbreviations of quasi-peak and average individually.
 2. "-": The Quasi-peak reading value also meets average limit and measurement with the average detector is unnecessary.
 3. The emission levels of other frequencies were very low against the limit.
 4. Margin value = Emission level - Limit value
 5. Correction factor = Insertion loss + Cable loss
 6. Emission Level = Correction Factor + Reading Value.

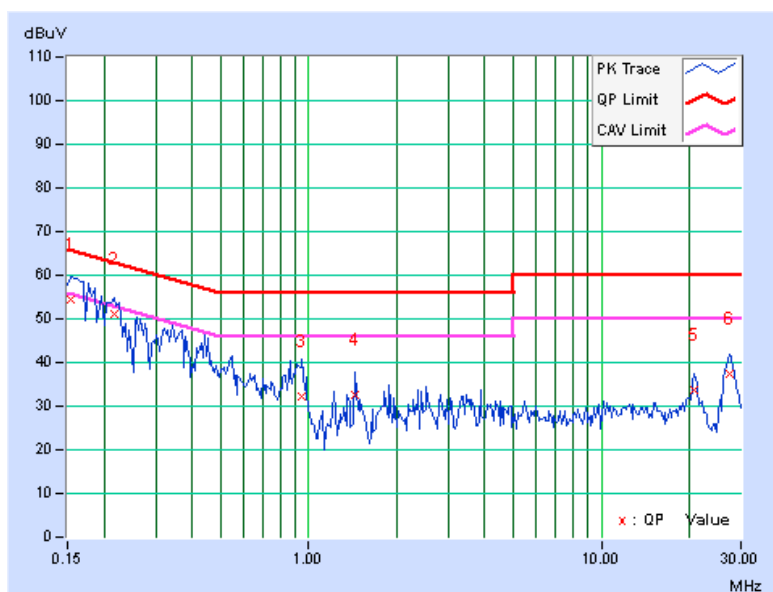

4.3 NUMBER OF HOPPING FREQUENCY USED

4.3.1 LIMIT OF HOPPING FREQUENCY USED

At least 15 channels frequencies, and should be equally spaced.

4.3.2 TEST SETUP

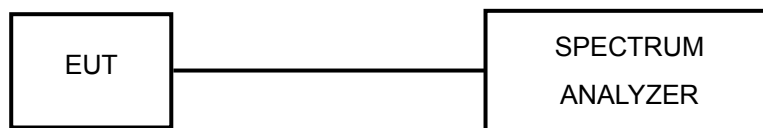

4.3.3 TEST INSTRUMENTS

Refer to section 4.1.2 to get information of above instrument.

4.3.4 TEST PROCEDURES

- a. Check the calibration of the measuring instrument (SA) using either an internal calibrator or a known signal from an external generator.
- b. Turn on the EUT and connect its antenna terminal to measurement via a low loss cable. Then set it to any one measured frequency within its operating range and make sure the instrument is operated in its linear range.
- c. Set the SA on MaxHold Mode, and then keep the EUT in hopping mode. Record all the signals from each channel until each one has been recorded.
- d. Set the SA on View mode and then plot the result on SA screen.
- e. Repeat above procedures until all frequencies measured were complete.

4.3.5 DEVIATION FROM TEST STANDARD

No deviation.

4.3.6 TEST RESULTS

There are 79 hopping frequencies in the hopping mode. Please refer to next two pages for the test result. On the plots, it shows that the hopping frequencies are equally spaced.



A D T

8DPSK

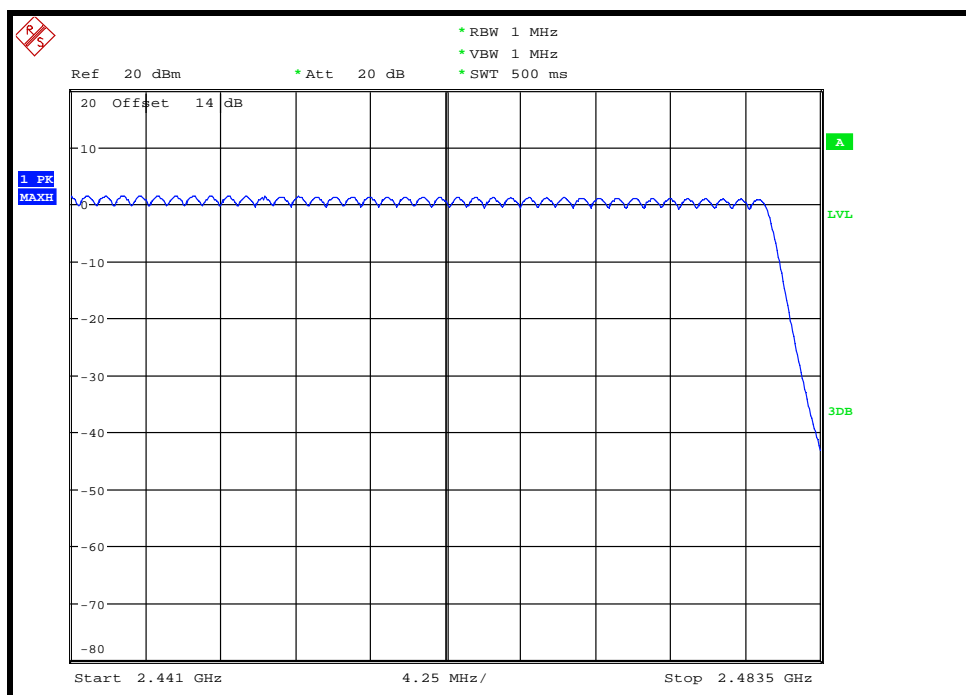
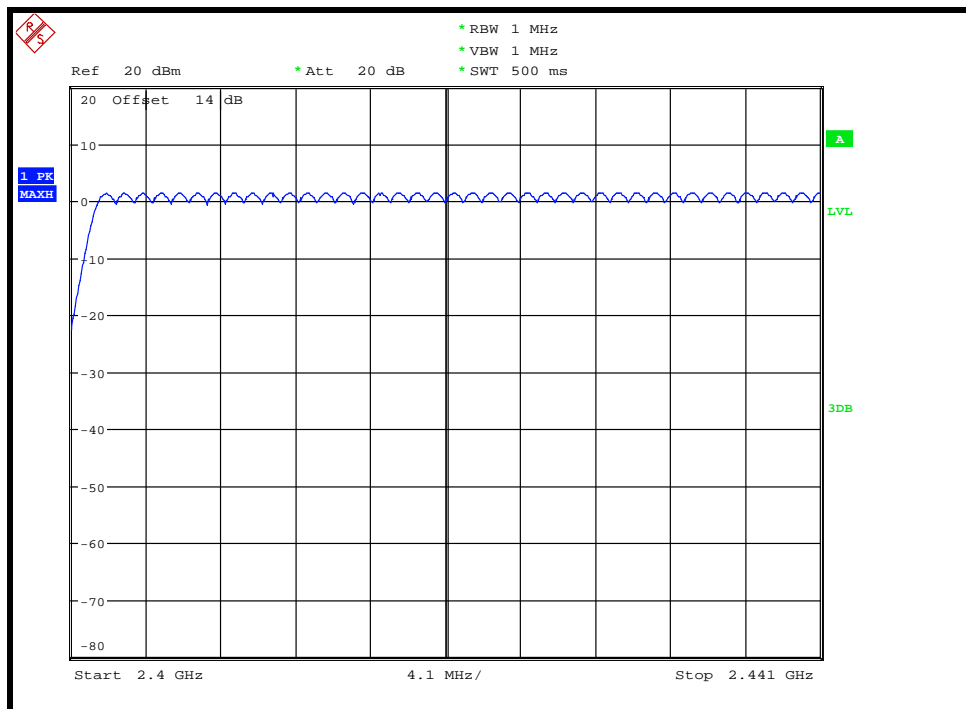

4.4 DWELL TIME ON EACH CHANNEL

4.4.1 LIMIT OF DWELL TIME USED

The average time of occupancy on any channel shall not be greater than 0.4 seconds within a period of 0.4 seconds multiplied by the number of hopping channels employed.

4.4.2 TEST SETUP

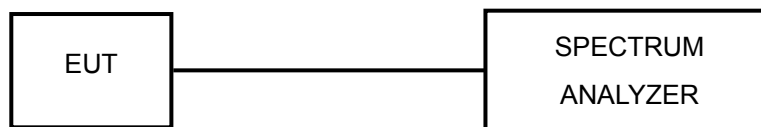

4.4.3 TEST INSTRUMENTS

Refer to section 4.1.2 to get information of above instrument.

4.4.4 TEST PROCEDURES

- a. Check the calibration of the measuring instrument (SA) using either an internal calibrator or a known signal from an external generator.
- b. Turn on the EUT and connect its antenna terminal to measurement via a low loss cable. Then set it to any one measured frequency within its operating range and make sure the instrument is operated in its linear range.
- c. Adjust the center frequency of SA on any frequency be measured and set SA to zero span mode. And then, set RBW and VBW of spectrum analyzer to proper value.
- d. Measure the time duration of one transmission on the measured frequency. And then plot the result with time difference of this time duration.
- e. Repeat above procedures until all different time-slot modes have been completed.

4.4.5 DEVIATION FROM TEST STANDARD

No deviation.

4.4.6 TEST RESULTS

GFSK

Mode	Average Hopping Channel	Package Transfer Time (usec)	Dwell Time (sec)	Limit (msec)
DH1	9.30	403.85	0.12	400
DH3	4.60	1677.89	0.24	400
DH5	4.00	2943.91	0.37	400

NOTE:

1. Dwell Time=79(channels) x 0.4(s) x average hopping channel x package transfer time
2. 79 channels come from the Hopping Channel number
3. Average Hopping Channel = hops/sweep time
4. t: Package Transfer Time(us)
5. Test plots of the transmitting time slot are shown on next 3 pages.



A D T

DH1

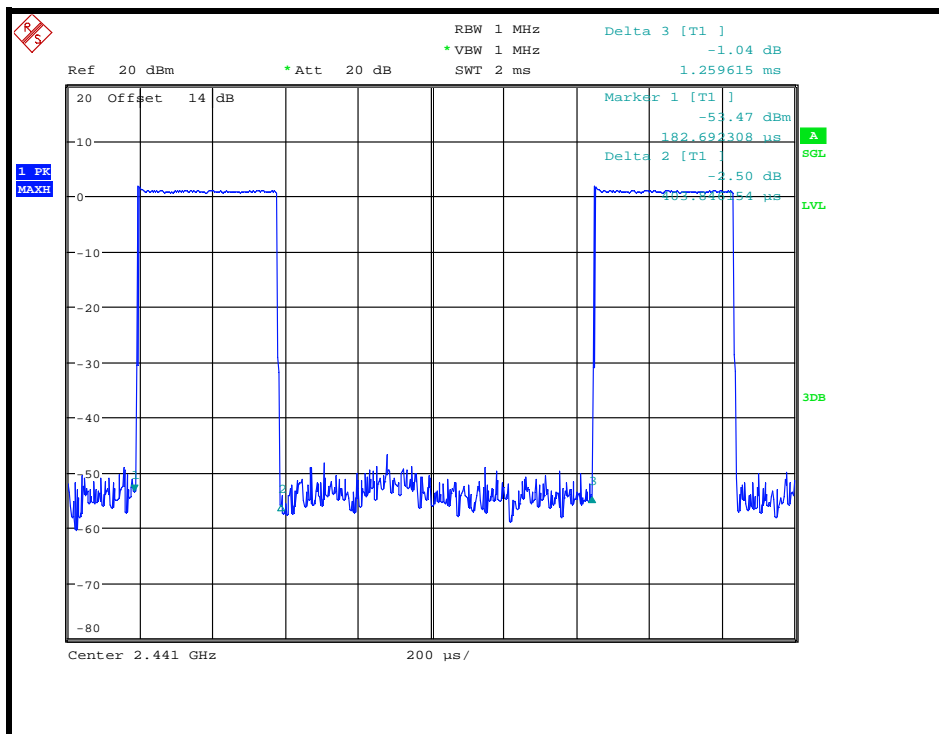
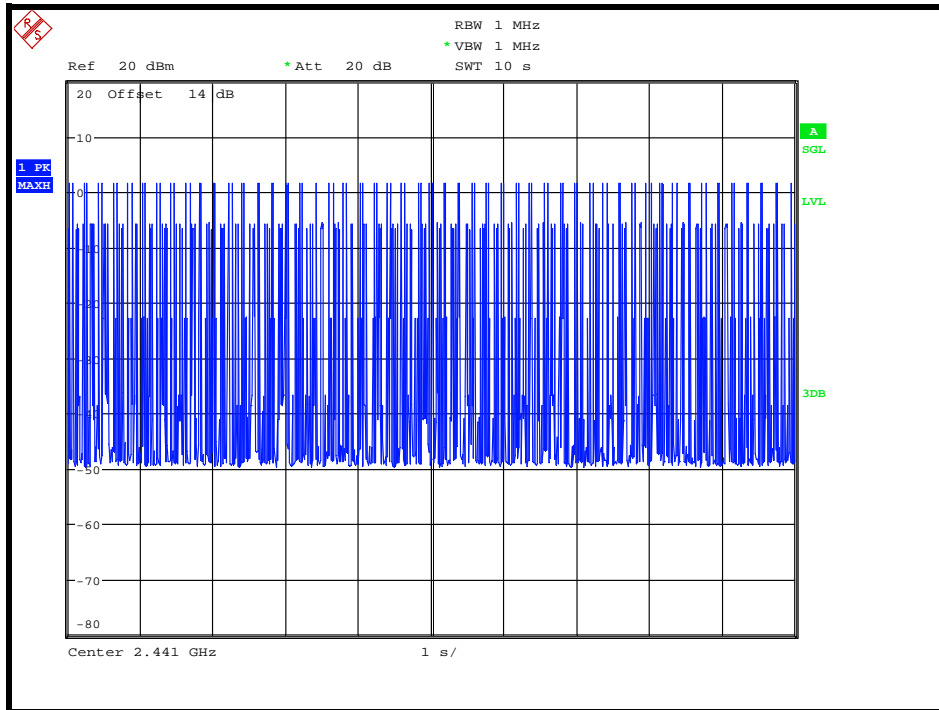



DH3

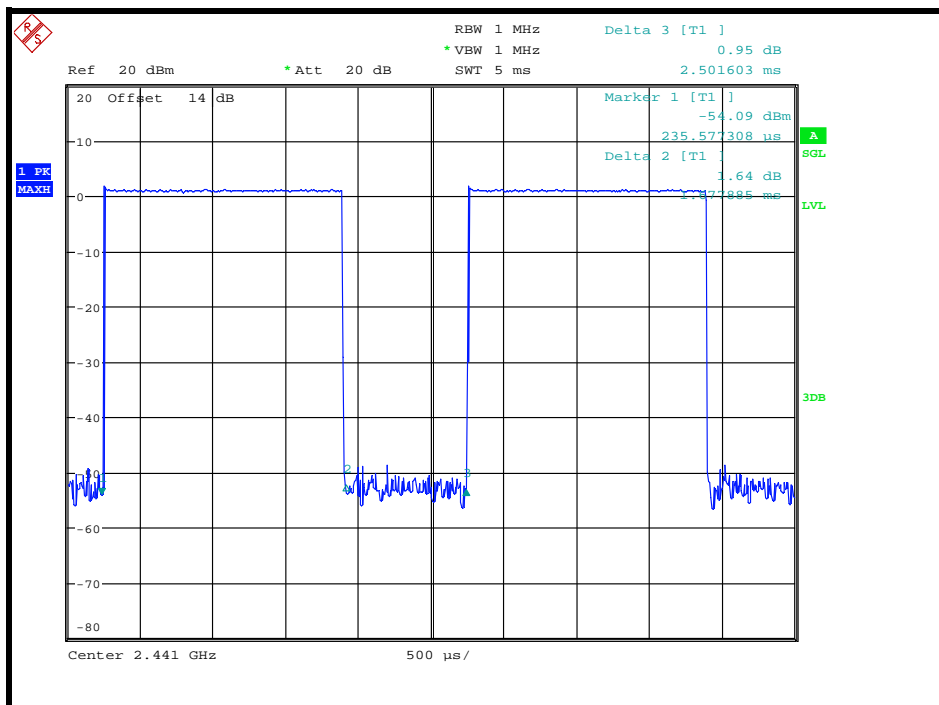
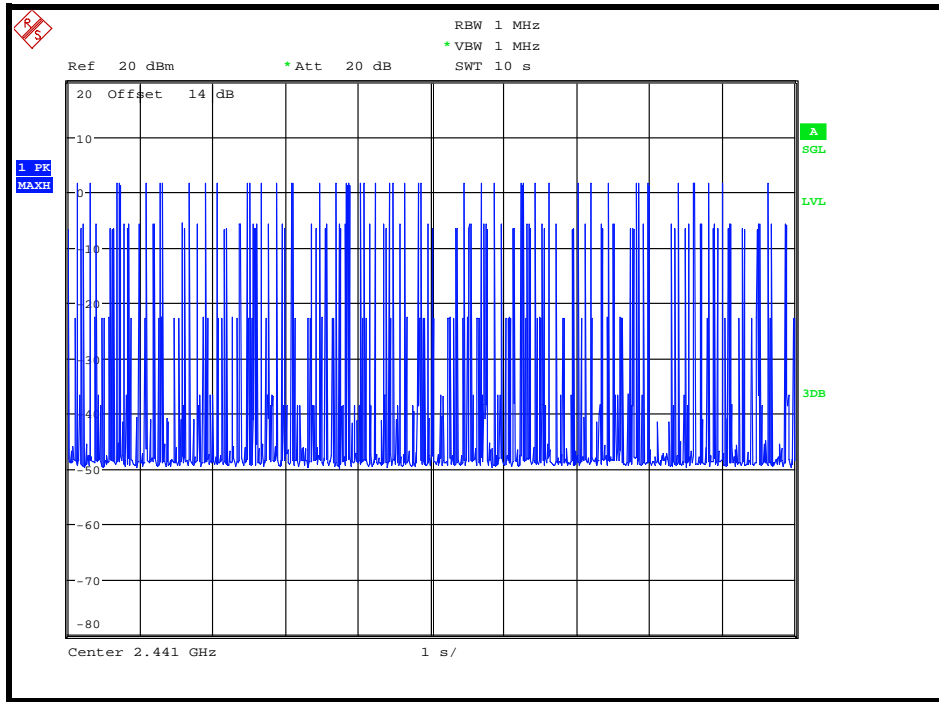



A D T

DH5

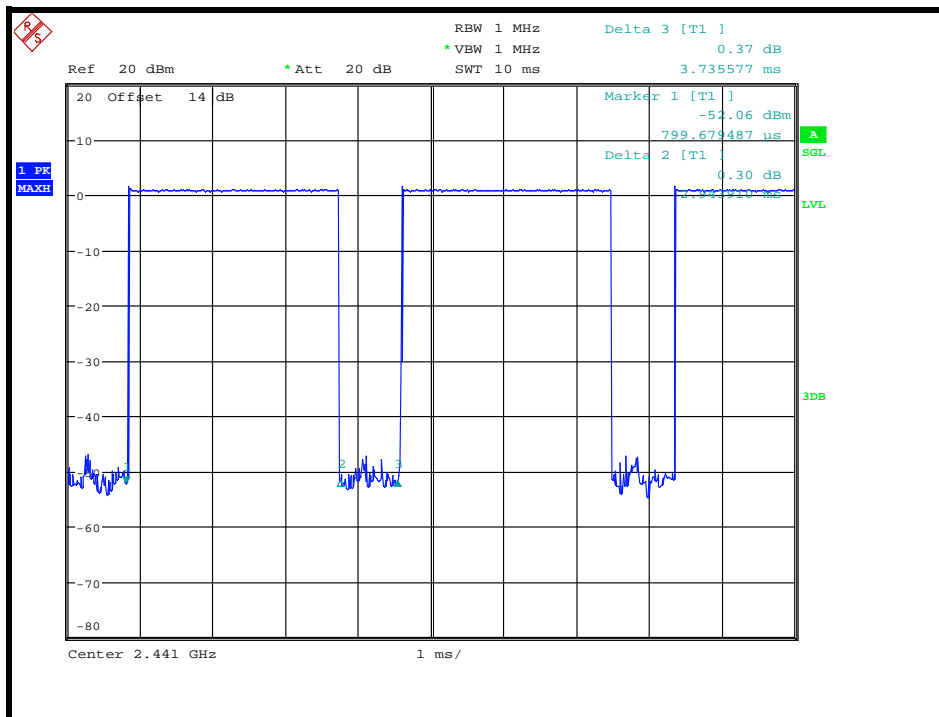
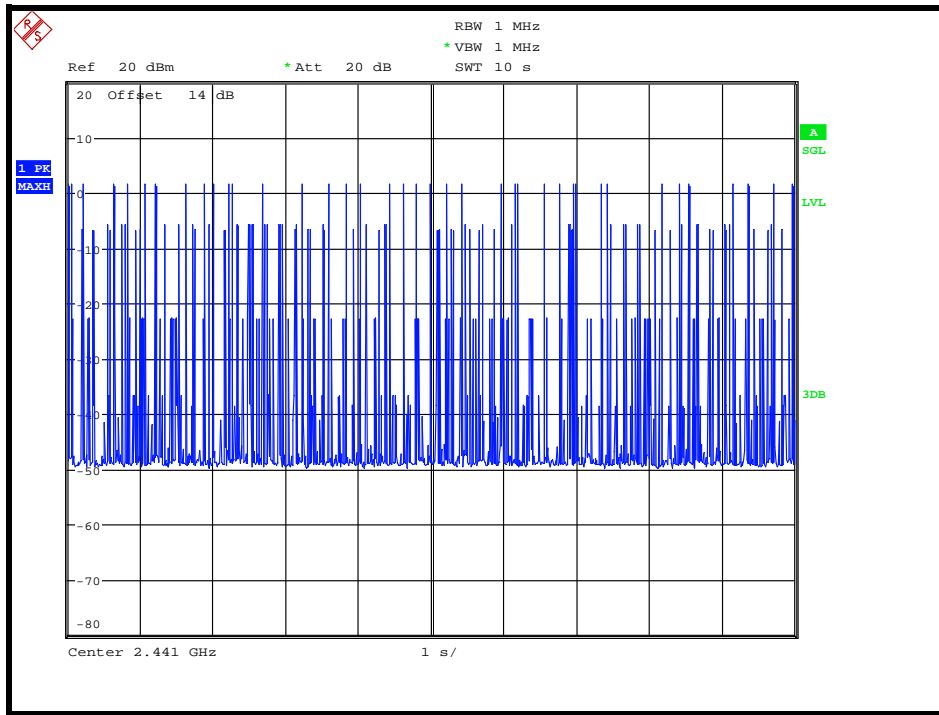

$\pi/4$ -DQPSK

Mode	Average Hopping Channel	Package Transfer Time (usec)	Dwell Time (sec)	Limit (msec)
DH1	9.70	419.82	0.13	400
DH3	5.30	1603.91	0.27	400
DH5	3.30	2964.74	0.31	400

NOTE:

1. Dwell Time=79(channels) x 0.4(s) x average hopping channel x package transfer time
2. 79 channels come from the Hopping Channel number
3. Average Hopping Channel = hops/sweep time
4. t: Package Transfer Time(us)
5. Test plots of the transmitting time slot are shown on next 3 pages.



A D T

DH3

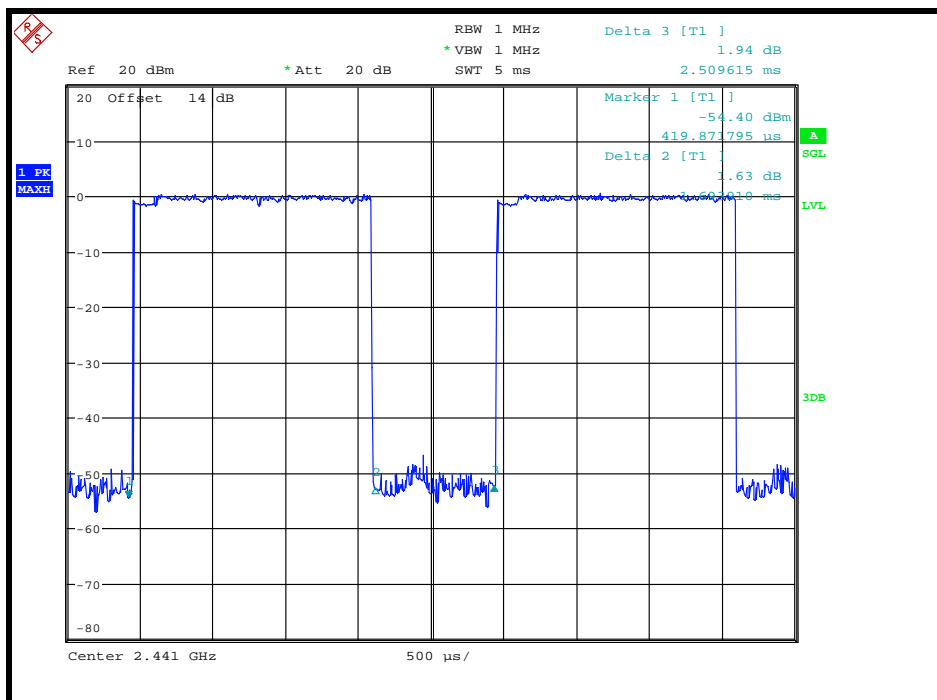
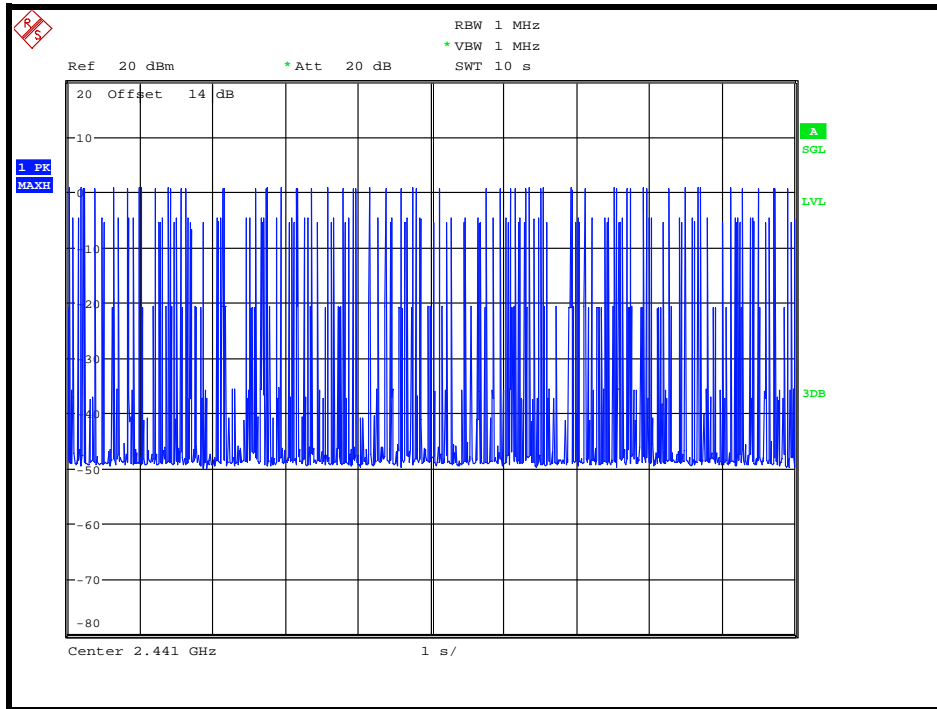



A D T

DH5

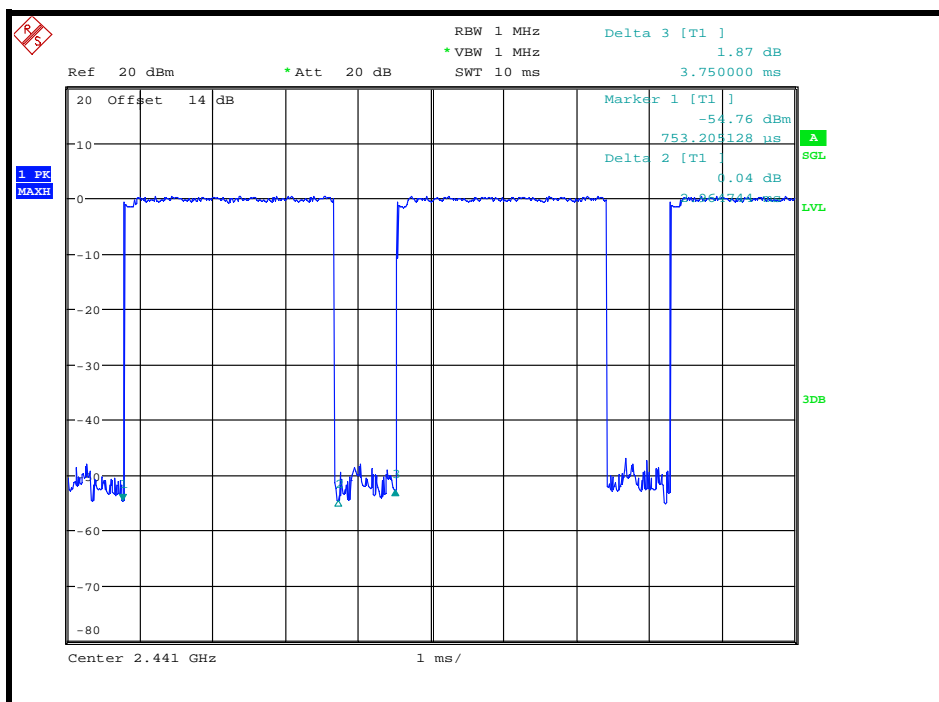
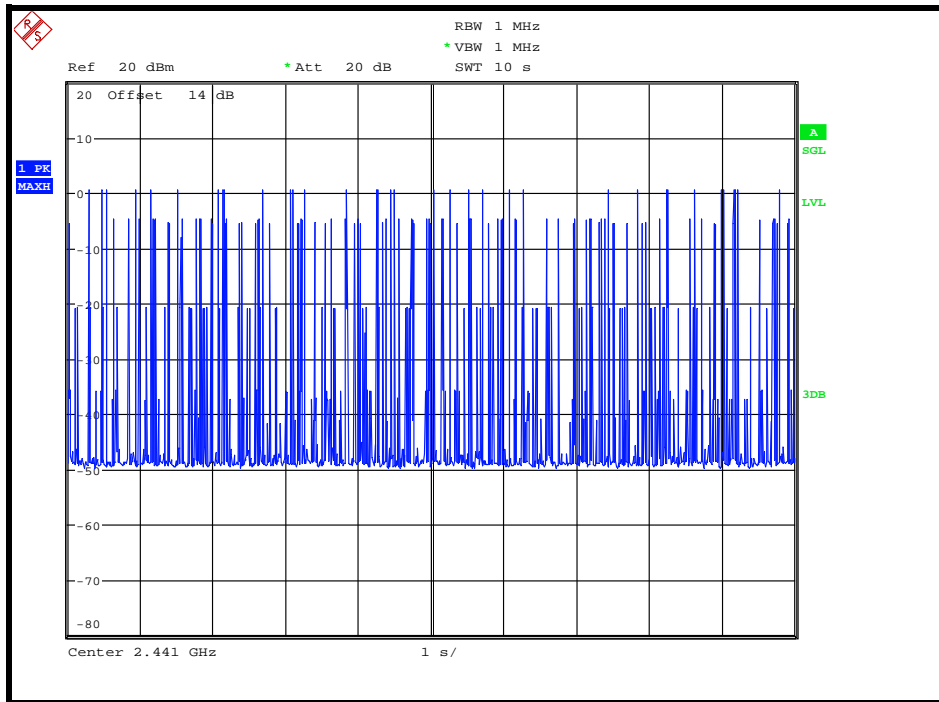



8DPSK

Mode	Average Hopping Channel	Package Transfer Time (usec)	Dwell Time (sec)	Limit (msec)
DH1	8.70	407.05	0.11	400
DH3	4.00	1714.74	0.22	400
DH5	3.70	2932.69	0.34	400

NOTE:

1. Dwell Time= $79(\text{channels}) \times 0.4(\text{s}) \times \text{average hopping channel} \times \text{package transfer time}$
2. 79 channels come from the Hopping Channel number
3. Average Hopping Channel = hops/sweep time
4. t: Package Transfer Time(us)
5. Test plots of the transmitting time slot are shown on next 3 pages.



A D T

DH1

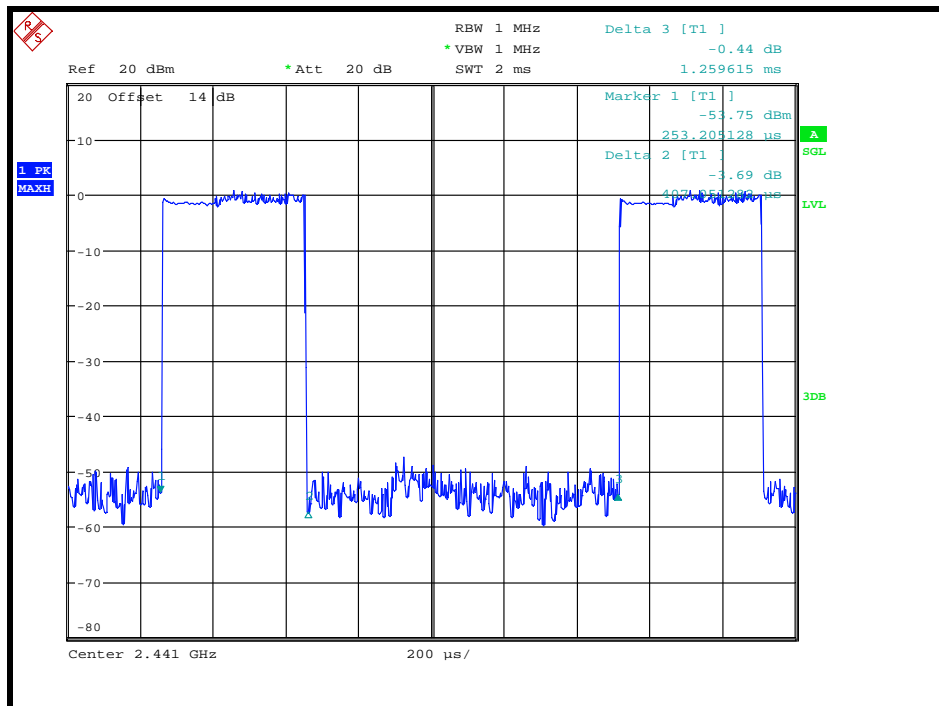
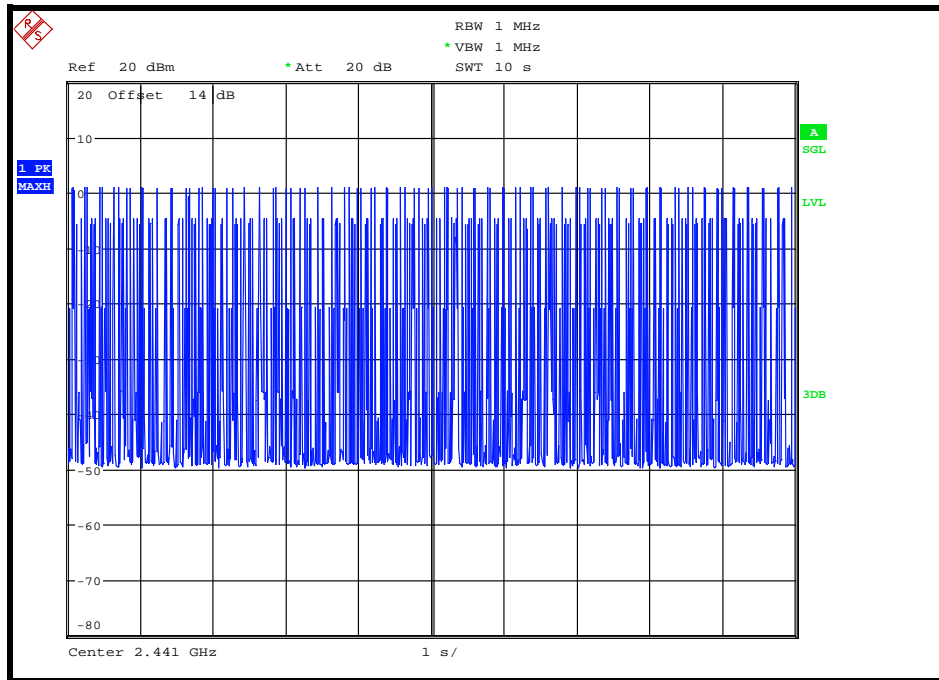



A D T

DH3

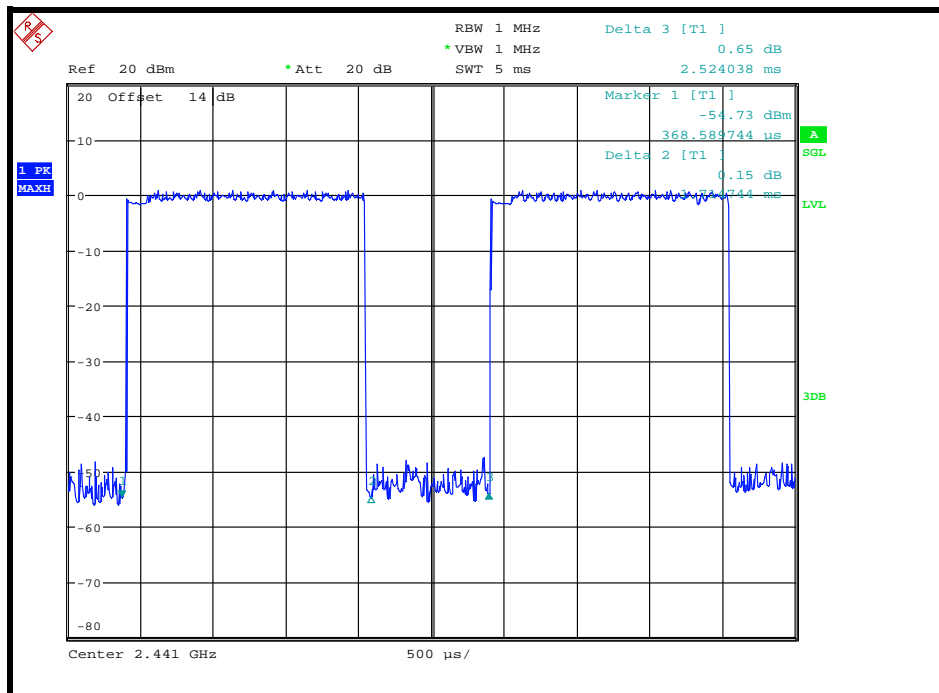
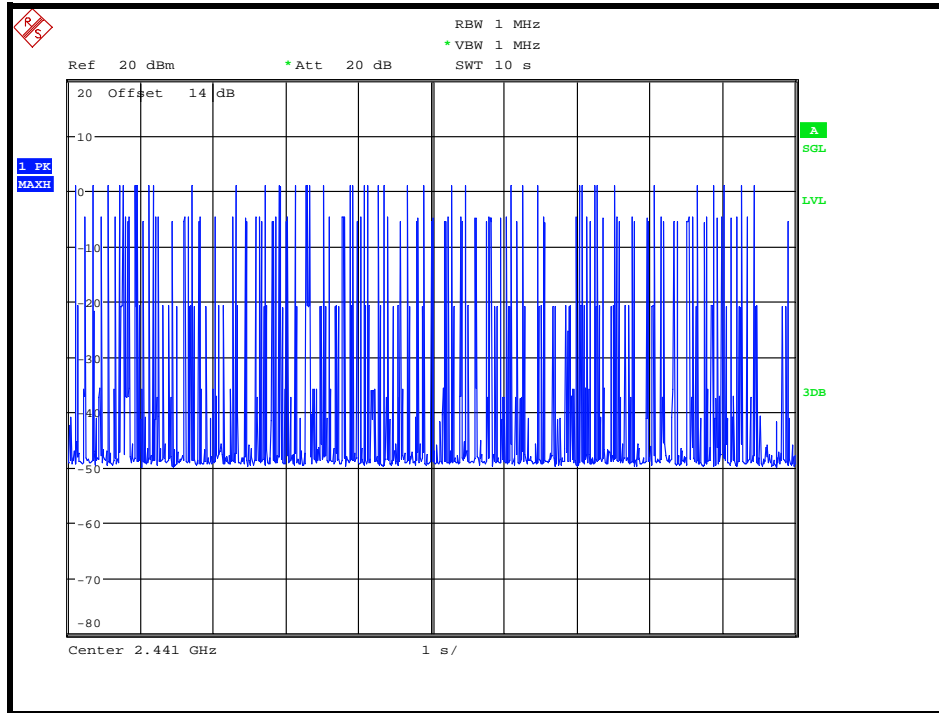



A D T

DH5

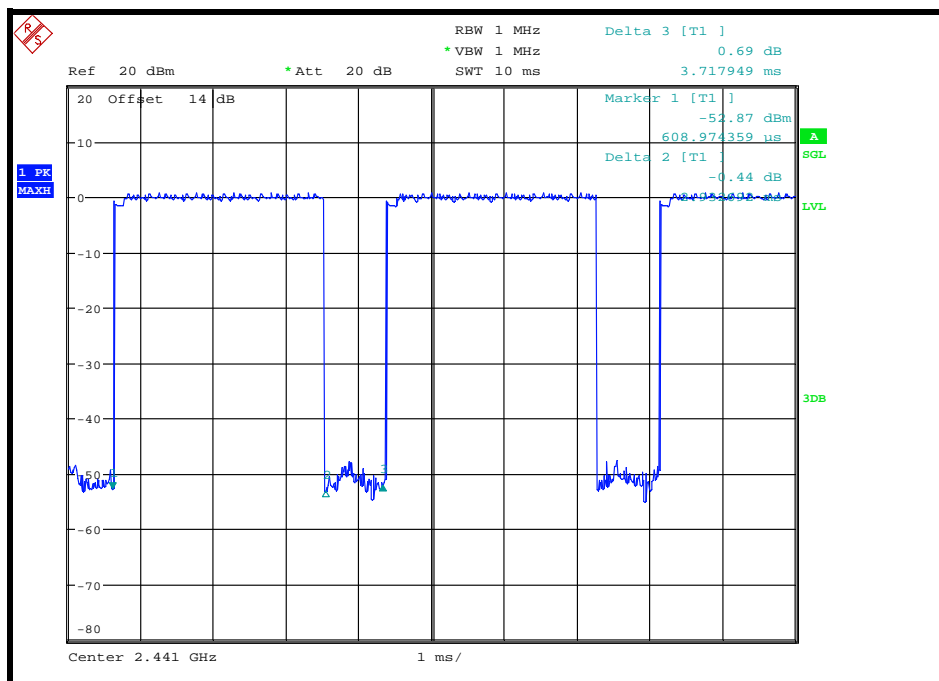
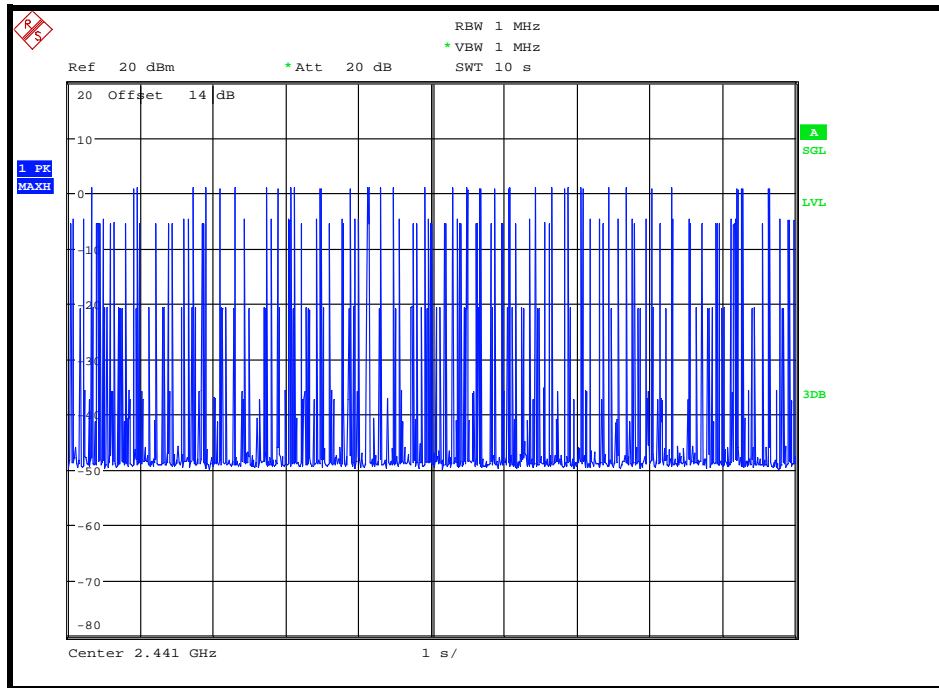

4.5 CHANNEL BANDWIDTH

4.5.1 LIMITS OF CHANNEL BANDWIDTH

For frequency hopping system operating in the 2400-2483.5MHz, If the 20dB bandwidth of hopping channel is greater than 25kHz, two-thirds 20dB bandwidth of hopping channel shall be a minimum limit for the hopping channel separation.

4.5.2 TEST SETUP

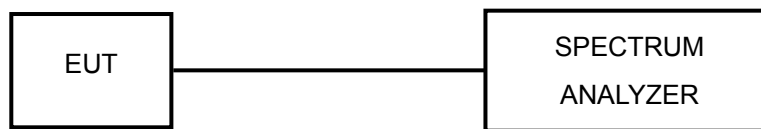

4.5.3 TEST INSTRUMENTS

Refer to section 4.1.2 to get information of above instrument.

4.5.4 TEST PROCEDURE

- a. Check the calibration of the measuring instrument using either an internal calibrator or a known signal from an external generator.
- b. Turn on the EUT and connect it to measurement instrument. Then set it to any one convenient frequency within its operating range. Set a reference level on the measuring instrument equal to the highest peak value.
- c. Measure the frequency difference of two frequencies that were attenuated 20dB from the reference level. Record the frequency difference as the emission bandwidth.
- d. Repeat above procedures until all frequencies measured were complete.

4.5.5 DEVIATION FROM TEST STANDARD

No deviation.

4.5.6 EUT OPERATING CONDITION

The software provided by client enabled the EUT to transmit and receive data at lowest, middle and highest channel frequencies individually.



A D T

4.5.7 TEST RESULTS

CHANNEL	FREQUENCY (MHz)	20dB BANDWIDTH (MHz)		
		GFSK	$\pi/4$ -DQPSK	8DPSK
0	2402	0.912	1.348	1.286
39	2441	0.906	1.326	1.286
78	2480	0.910	1.346	1.286

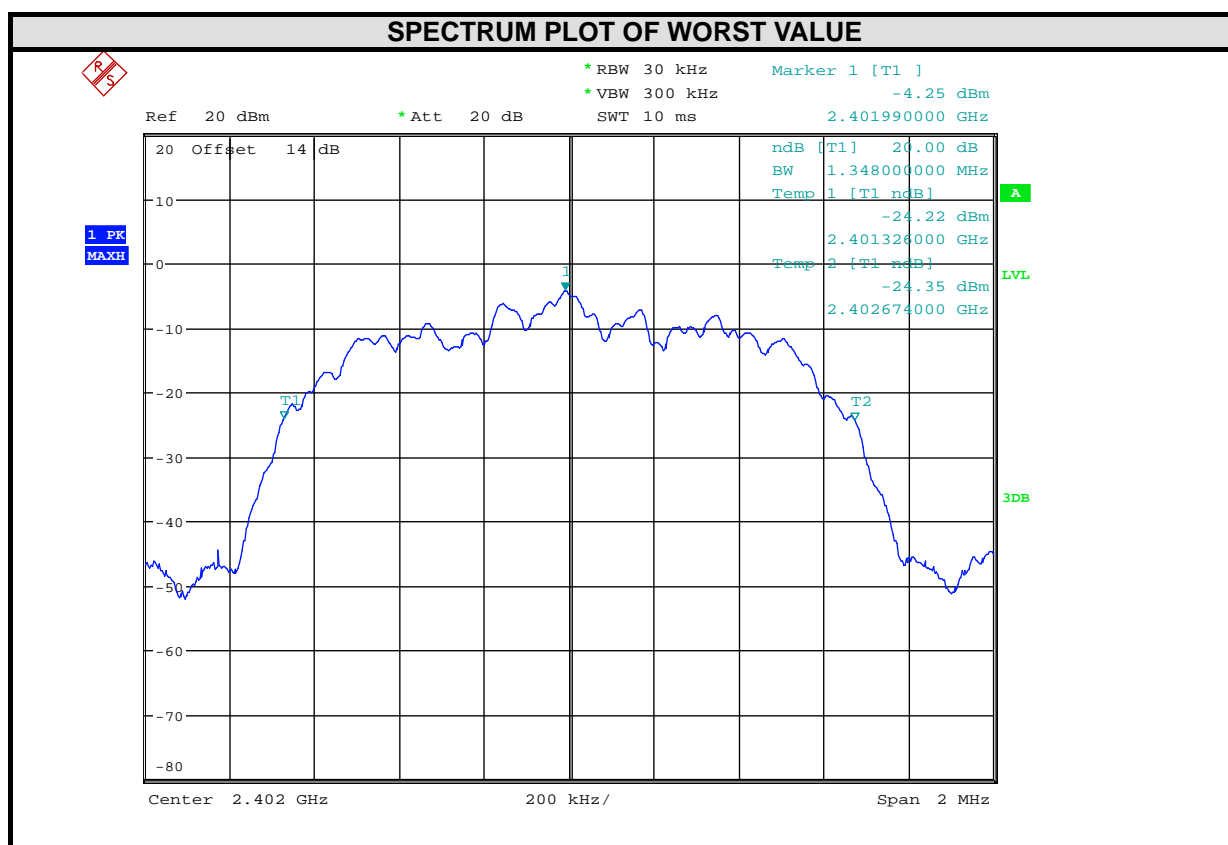

4.6 HOPPING CHANNEL SEPARATION

4.6.1 LIMIT OF HOPPING CHANNEL SEPARATION

At least 25kHz or two-third of 20dB hopping channel bandwidth (whichever is greater).

4.6.2 TEST SETUP

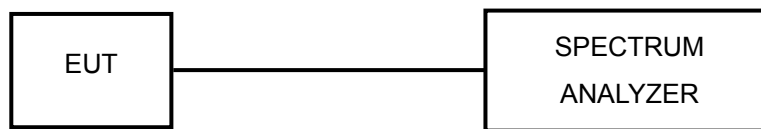

4.6.3 TEST INSTRUMENTS

Refer to section 4.1.2 to get information of above instrument.

4.6.4 TEST PROCEDURES

- a. Check the calibration of the measuring instrument using either an internal calibrator or a known signal from an external generator.
- b. Turn on the EUT and connect it to measurement instrument. Then set it to any one convenient frequency within its operating range.
- c. By using the MaxHold function record the separation of two adjacent channels.
- d. Measure the frequency difference of these two adjacent channels by SA MARK function. And then plot the result on SA screen.
- e. Repeat above procedures until all frequencies measured were complete.

4.6.5 DEVIATION FROM TEST STANDARD

No deviation.



A D T

4.6.6 TEST RESULTS

CHAN.	FREQ. (MHz)	ADJACENT CHANNEL SEPARATION (MHz)			20dB BANDWIDTH (MHz)			MINIMUM LIMIT (MHz)			PASS / FAIL
		GFSK	$\pi/4$ -DQPSK	8DPSK	GFSK	$\pi/4$ -DQPSK	8DPSK	GFSK	$\pi/4$ -DQPSK	8DPSK	
0	2402	1.002	1.002	1.002	0.912	1.348	1.286	0.608	0.899	0.857	PASS
39	2441	1.002	1.002	1.002	0.906	1.326	1.286	0.604	0.884	0.857	PASS
78	2480	1.002	1.002	1.002	0.910	1.346	1.286	0.607	0.897	0.857	PASS

NOTE: The minimum limit is two-third 20dB bandwidth.

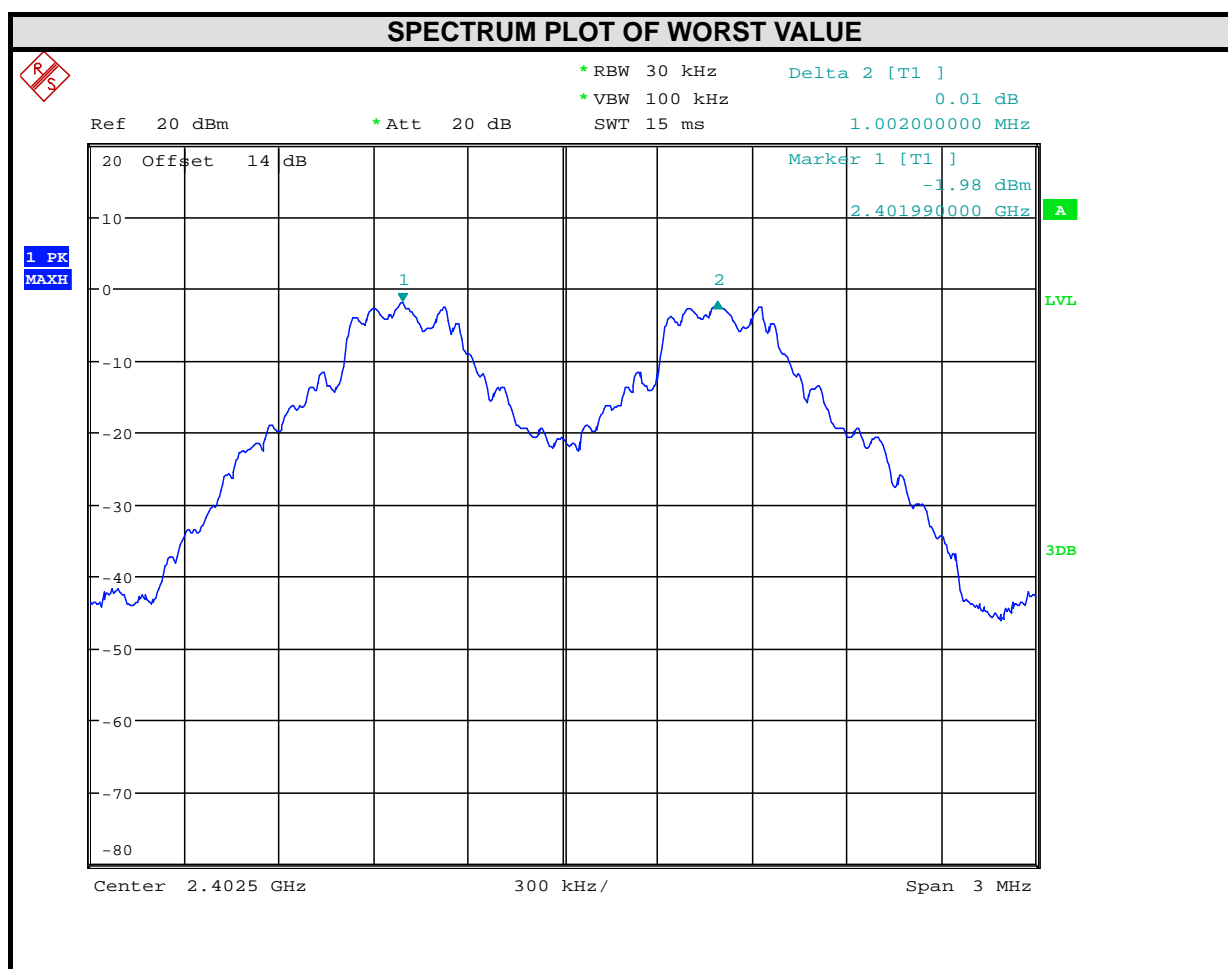

4.7 MAXIMUM OUTPUT POWER

4.7.1 LIMITS OF MAXIMUM OUTPUT POWER MEASUREMENT

The Maximum Output Power Measurement is 125mW.

4.7.2 TEST SETUP

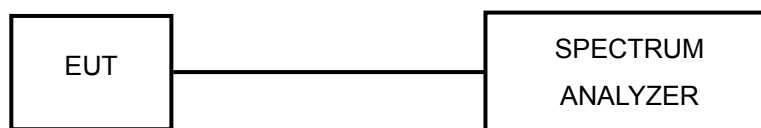

4.7.3 TEST INSTRUMENTS

Refer to section 4.1.2 to get information of above instrument.

4.7.4 TEST PROCEDURES

- a. Check the calibration of the measuring instrument using either an internal calibrator or a known signal from an external generator.
- b. Turn on the EUT and connect it to measurement instrument. Then set it to any one convenient frequency within its operating range. Set a reference level on the measuring instrument equal to the highest peak value.
- c. The center frequency of the spectrum analyzer is set to the fundamental frequency and using 3MHz RBW and 10 MHz VBW.
- d. Measure the captured power within the band and recording the plot.
- e. Repeat above procedures until all frequencies required were complete.

4.7.5 DEVIATION FROM TEST STANDARD

No deviation.

4.7.6 EUT OPERATING CONDITION

The software provided by client enabled the EUT to transmit and receive data at lowest, middle and highest channel frequencies individually.



A D T

4.7.7 TEST RESULTS

CHAN.	FREQ. (MHz)	OUTPUT POWER (W)			OUTPUT POWER (dBm)			POWER LIMIT (mW)	PASS / FAIL
		GFSK	$\pi/4$ -DQPSK	8DPSK	GFSK	$\pi/4$ -DQPSK	8DPSK		
0	2402	0.0016	0.0013	0.0014	2.02	1.11	1.50	125	PASS
39	2441	0.0017	0.0013	0.0015	2.24	1.30	1.69	125	PASS
78	2480	0.0015	0.0012	0.0013	1.62	0.70	1.15	125	PASS

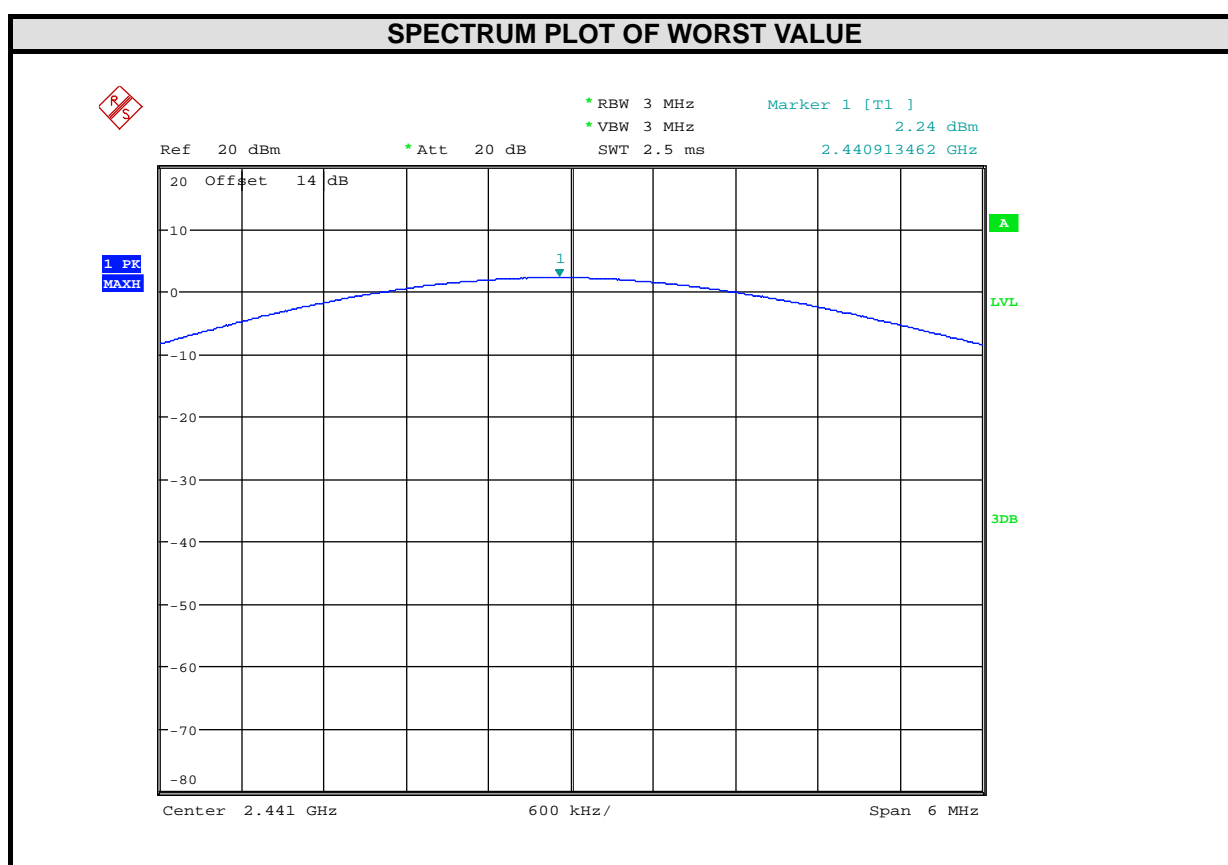

4.8 CONDUCTED OUT OF BAND EMISSION MEASUREMENT

4.8.1 LIMITS OF CONDUCTED OUT OF BAND EMISSION MEASUREMENT

Below -20dB of the highest emission level of operating band (in 100KHz RBW).

4.8.2 TEST INSTRUMENTS

Refer to section 4.1.2 to get information of above instrument.

4.8.3 TEST PROCEDURE

The transmitter output was connected to the spectrum analyzer via a low loss cable. Set both RBW and VBW of spectrum analyzer to 100 kHz with suitable frequency span including 100 MHz bandwidth from band edge. The band edges was measured and recorded.

4.8.4 DEVIATION FROM TEST STANDARD

No deviation.

4.8.5 EUT OPERATING CONDITION

The software provided by client enabled the EUT to transmit and receive data at lowest, middle and highest channel frequencies individually.

4.8.6 TEST RESULTS

The spectrum plots are attached on the following images. D1 line indicates the highest level, D2 line indicates the 20dB offset below D1. It shows compliance with the requirement.



A D T

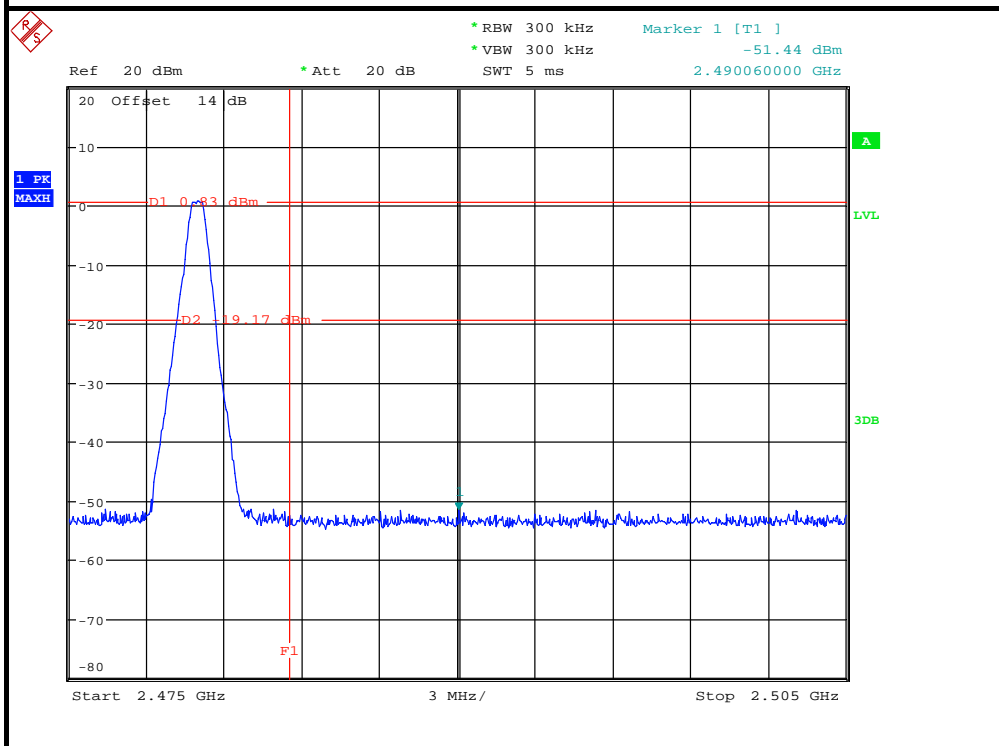
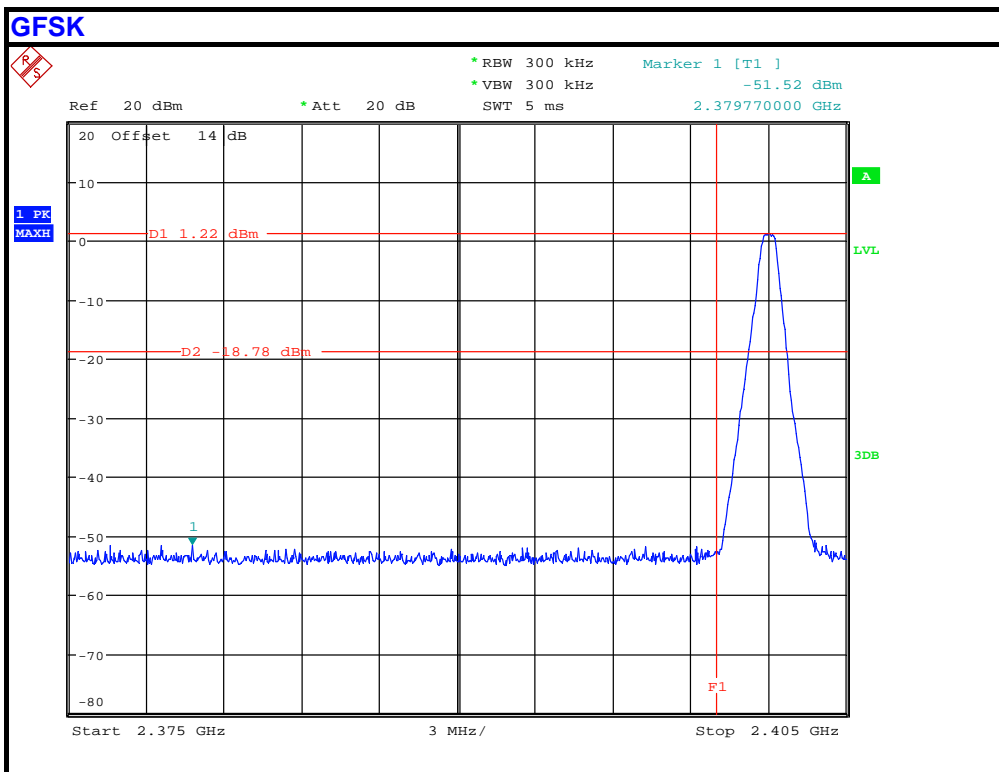



A D T

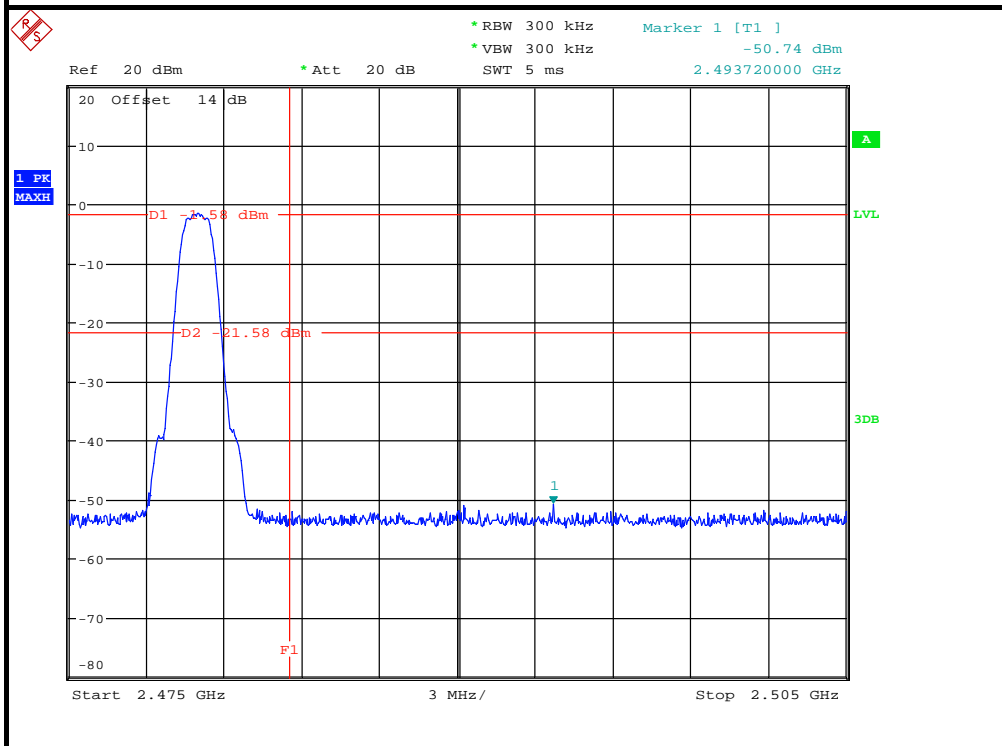
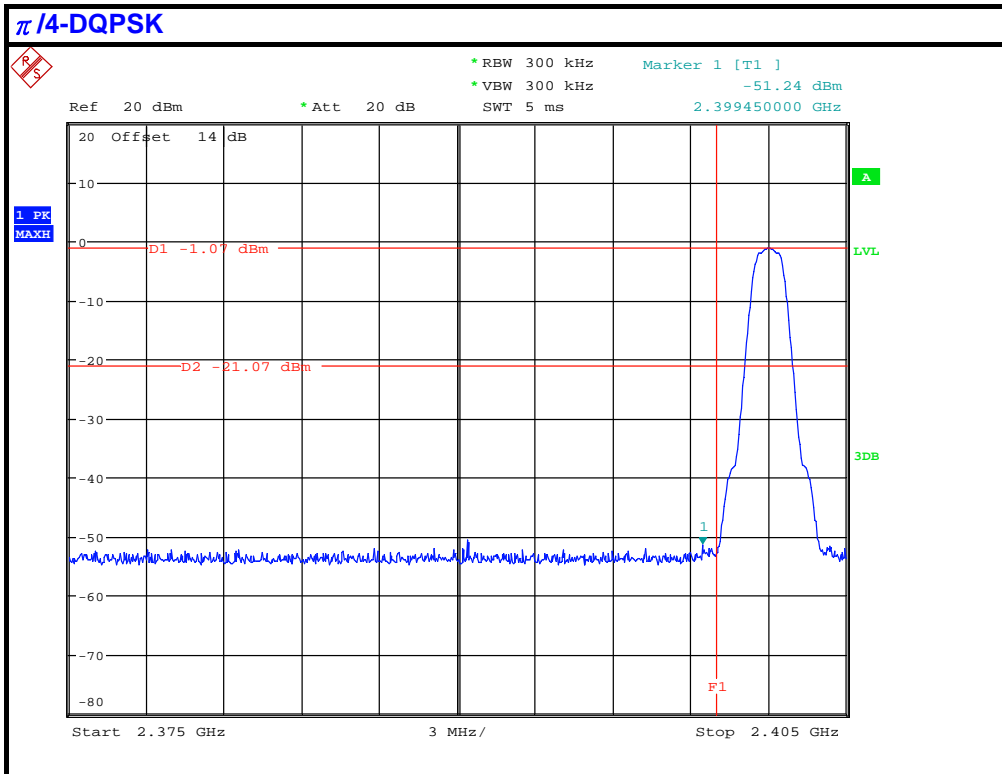



A D T

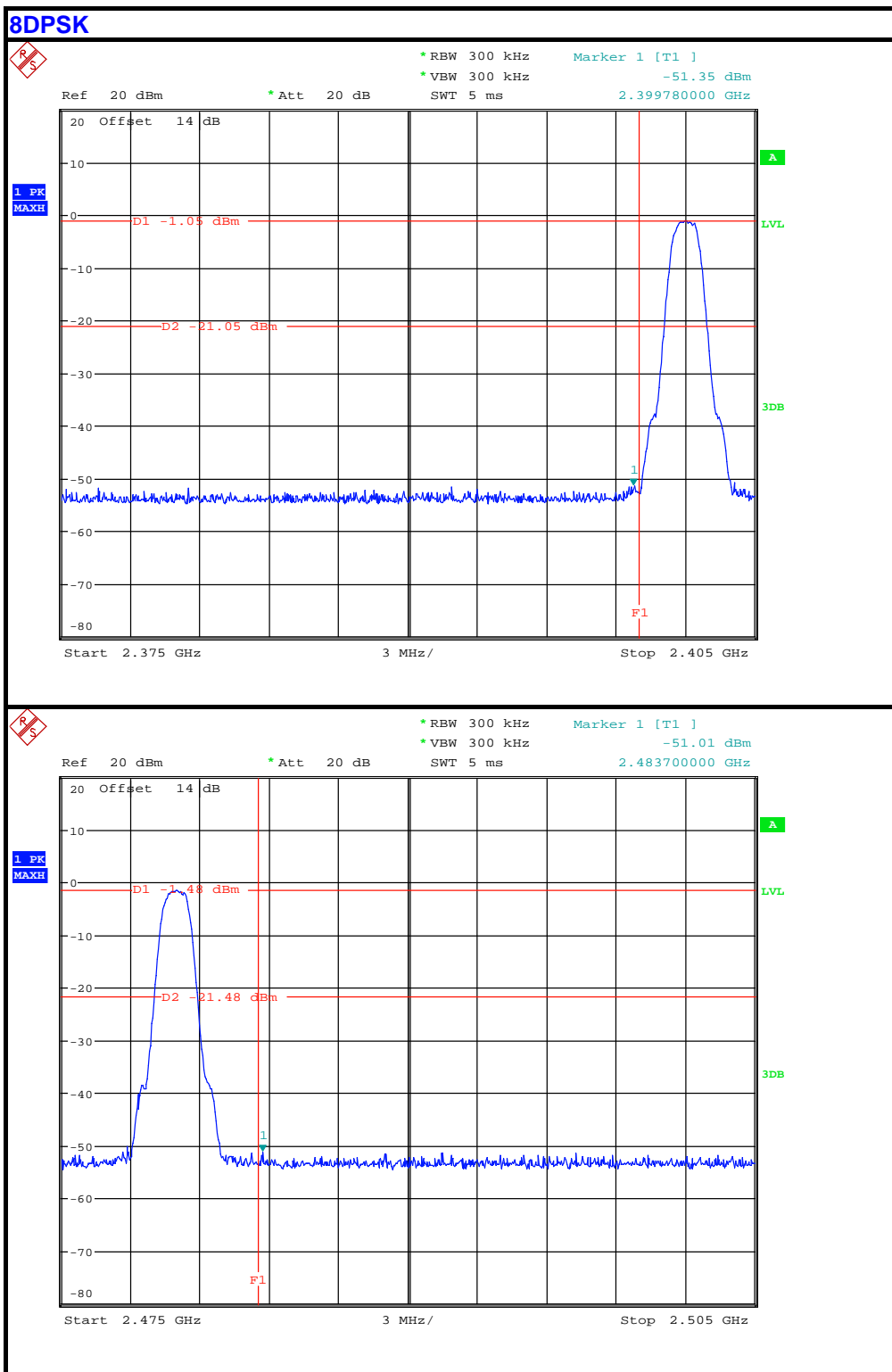

5. PHOTOGRAPHS OF THE TEST CONFIGURATION

Please refer to the attached file (Test Setup Photo).



6. INFORMATION ON THE TESTING LABORATORIES

We, Bureau Veritas Consumer Products Services (H.K.) Ltd., Taoyuan Branch, were founded in 1988 to provide our best service in EMC, Radio, Telecom and Safety consultation. Our laboratories are accredited and approved according to ISO/IEC 17025.

Copies of accreditation and authorization certificates of our laboratories obtained from approval agencies can be downloaded from our web site:

www.adt.com.tw/index.5.phtml. If you have any comments, please feel free to contact us at the following:

Linko EMC/RF Lab:

Tel: 886-2-26052180

Fax: 886-2-26051924

Hsin Chu EMC/RF Lab:

Tel: 886-3-5935343

Fax: 886-3-5935342

Hwa Ya EMC/RF/Safety Telecom Lab:

Tel: 886-3-3183232

Fax: 886-3-3270892

Email: service.adt@tw.bureauveritas.com

Web Site: www.adt.com.tw

The address and road map of all our labs can be found in our web site also.

7. APPENDIX A - MODIFICATIONS RECORDERS FOR ENGINEERING CHANGES TO THE EUT BY THE LAB

No any modifications are made to the EUT by the lab during the test.

--- END ---