



A D T

FCC TEST REPORT (15.247)

REPORT NO.: RF110829C12

MODEL NO.: TOSHIBA AT20*****

(where “ * “ can be 0-9, a-z, A-Z, /, - or blank)

FCC ID: HFS-FG2

RECEIVED: Aug. 29, 2011

TESTED: Sep. 01 ~ Sep. 05, 2011

ISSUED: Sep. 21, 2011

APPLICANT: QUANTA COMPUTER INC.

ADDRESS: No.211, Wen Hwa 2nd Road, Kuei Shan Hsiang
Taoyuan Hsien, 333 Taiwan, R.O.C.

ISSUED BY: Bureau Veritas Consumer Products Services
(H.K.) Ltd., Taoyuan Branch

LAB ADDRESS: No. 47, 14th Ling, Chia Pau Tsuen, Lin Kou
Hsiang, Taipei Hsien 244, Taiwan, R.O.C.

TEST LOCATION: No. 19, Hwa Ya 2nd Rd, Wen Hwa Tsuen, Kwei
Shan Hsiang, Taoyuan Hsien 333, Taiwan, R.O.C.

This test report consists of 63 pages in total. It may be duplicated completely for legal use with the approval of the applicant. It should not be reproduced except in full, without the written approval of our laboratory. The client should not use it to claim product certification, approval, or endorsement by TAF or any government agency. The test results in the report only apply to the tested sample.





A D T

TABLE OF CONTENTS

RELEASE CONTROL RECORD.....	4
1. CERTIFICATION.....	5
2. SUMMARY OF TEST RESULTS	6
2.1 MEASUREMENT UNCERTAINTY.....	6
3. GENERAL INFORMATION.....	7
3.1 GENERAL DESCRIPTION OF EUT	7
3.2 DESCRIPTION OF TEST MODES	8
3.2.1 CONFIGURATION OF SYSTEM UNDER TEST	9
3.2.2 TEST MODE APPLICABILITY AND TESTED CHANNEL DETAIL	10
3.3 GENERAL DESCRIPTION OF APPLIED STANDARDS	12
3.4 DESCRIPTION OF SUPPORT UNITS	12
4. TEST TYPES AND RESULTS	13
4.1 RADIATED EMISSION MEASUREMENT	13
4.1.1 LIMITS OF RADIATED EMISSION MEASUREMENT.....	13
4.1.2 TEST INSTRUMENTS.....	14
4.1.3 TEST PROCEDURES	15
4.1.4 DEVIATION FROM TEST STANDARD.....	15
4.1.5 TEST SETUP.....	16
4.1.6 EUT OPERATING CONDITIONS	16
4.1.7 TEST RESULT	17
4.2 CONDUCTED EMISSION MEASUREMENT	28
4.2.1 LIMITS OF CONDUCTED EMISSION MEASUREMENT	28
4.2.2 TEST INSTRUMENTS.....	28
4.2.3 TEST PROCEDURES	29
4.2.4 DEVIATION FROM TEST STANDARD.....	29
4.2.5 TEST SETUP.....	30
4.2.6 EUT OPERATING CONDITIONS	30
4.2.7 TEST RESULTS	31
4.3 6dB BANDWIDTH MEASUREMENT.....	35
4.3.1 LIMITS OF 6dB BANDWIDTH MEASUREMENT	35
4.3.2 TEST INSTRUMENTS.....	35
4.3.3 TEST PROCEDURE.....	35
4.3.4 DEVIATION FROM TEST STANDARD.....	35
4.3.5 TEST SETUP.....	36
4.3.6 EUT OPERATING CONDITIONS	36
4.3.7 TEST RESULTS	37
4.4 MAXIMUM OUTPUT POWER	40
4.4.1 LIMITS OF MAXIMUM OUTPUT POWER MEASUREMENT.....	40
4.4.2 INSTRUMENTS.....	40



A D T

4.4.3	TEST PROCEDURE.....	40
4.4.4	DEVIATION FROM TEST STANDARD.....	41
4.4.5	TEST SETUP.....	41
4.4.6	EUT OPERATING CONDITIONS	41
4.4.7	TEST RESULTS	42
4.5	POWER SPECTRAL DENSITY MEASUREMENT	43
4.5.1	LIMITS OF POWER SPECTRAL DENSITY MEASUREMENT	43
4.5.2	TEST INSTRUMENTS.....	43
4.5.3	TEST PROCEDURE.....	43
4.5.4	DEVIATION FROM TEST STANDARD.....	44
4.5.5	TEST SETUP.....	44
4.5.6	EUT OPERATING CONDITION.....	44
4.5.7	TEST RESULTS	45
4.6	BAND EDGES MEASUREMENT	48
4.6.1	LIMITS OF BAND EDGES MEASUREMENT	48
4.6.2	TEST INSTRUMENTS.....	48
4.6.3	TEST PROCEDURE.....	48
4.6.4	DEVIATION FROM TEST STANDARD.....	48
4.6.5	EUT OPERATING CONDITION.....	48
4.6.6	TEST RESULTS	49
5.	PHOTOGRAPHS OF THE TEST CONFIGURATION.....	61
6.	INFORMATION ON THE TESTING LABORATORIES	62
7.	APPENDIX A - MODIFICATIONS RECORDERS FOR ENGINEERING CHANGES TO THE EUT BY THE LAB.....	63



A D T

RELEASE CONTROL RECORD

ISSUE NO.	REASON FOR CHANGE	DATE ISSUED
Original release	N/A	Sep. 21, 2011



A D T

1. CERTIFICATION

PRODUCT: Tablet PC

MODEL: TOSHIBA AT20***** (where " * " can be 0-9, a-z, A-Z, /, - or blank)

BRAND: TOSHIBA

APPLICANT: QUANTA COMPUTER INC.

TEST SAMPLE: ENGINEERING SAMPLE

TESTED: Sep. 01 ~ Sep. 05, 2011

STANDARDS: **FCC Part 15, Subpart C (Section 15.247)**

ANSI C63.4-2003

ANSI C63.10-2009

The above equipment (Model: TOSHIBA AT200) has been tested by **Bureau Veritas Consumer Products Services (H.K.) Ltd., Taoyuan Branch**, and found compliance with the requirement of the above standards. The test record, data evaluation & Equipment Under Test (EUT) configurations represented herein are true and accurate accounts of the measurements of the sample's EMC characteristics under the conditions specified in this report.

PREPARED BY : Ivy Lin , DATE: Sep. 21, 2011
Ivy Lin / Specialist

APPROVED BY : Gary Chang , DATE: Sep. 21, 2011
Gary Chang / Technical Manager



A D T

2. SUMMARY OF TEST RESULTS

The EUT has been tested according to the following specifications:

APPLIED STANDARD: FCC PART 15, SUBPART C (SECTION 15.247)			
STANDARD SECTION	TEST TYPE AND LIMIT	RESULT	REMARK
15.207	AC Power Conducted Emission	PASS	Meet the requirement of limit. Minimum passing margin is -5.20dB at 0.216MHz.
15.247(a)(2)	Spectrum Bandwidth of a Direct Sequence Spread Spectrum System Limit: min. 500kHz	PASS	Meet the requirement of limit.
15.247(b)	Maximum Output Power Limit: max. 30dBm	PASS	Meet the requirement of limit.
15.247(d)	Radiated Emissions Limit: Table 15.209	PASS	Meet the requirement of limit. Minimum passing margin is -2.0dB at 2390.00MHz & 2483.50MHz.
15.247(e)	Power Spectral Density Limit: max. 8dBm	PASS	Meet the requirement of limit.
15.247(d)	Band Edge Measurement Limit: 20dB less than the peak value of fundamental frequency	PASS	Meet the requirement of limit.
15.203	Antenna Requirement	PASS	Antenna connector is IPX3 not a standard connector.

2.1 MEASUREMENT UNCERTAINTY

Where relevant, the following measurement uncertainty levels have been estimated for tests performed on the EUT as specified in CISPR 16-4-2:

MEASUREMENT	FREQUENCY	UNCERTAINTY
Conducted emissions	9kHz~30MHz	2.44 dB
Radiated emissions	30MHz ~ 200MHz	3.34 dB
	200MHz ~1000MHz	3.35 dB
	1GHz ~ 18GHz	2.26 dB
	18GHz ~ 40GHz	1.94 dB

This uncertainty represents an expanded uncertainty expressed at approximately the 95% confidence level using a coverage factor of $k = 2$.



3. GENERAL INFORMATION

3.1 GENERAL DESCRIPTION OF EUT

EUT	Tablet PC
MODEL NO.	TOSHIBA AT20***** (where “ * “ can be 0-9, a-z, A-Z, /, - or blank)
FCC ID	HFS-FG2
POWER SUPPLY	5Vdc (adapter or host equipment) 3.7Vdc (battery)
MODULATION TYPE	CCK, DQPSK, DBPSK for DSSS 64QAM, 16QAM, QPSK, BPSK for OFDM
MODULATION TECHNOLOGY	DSSS, OFDM
TRANSFER RATE	802.11b:11.0/ 5.5/ 2.0/ 1.0Mbps 802.11g: 54.0/ 48.0/ 36.0/ 24.0/ 18.0/ 12.0/ 9.0/ 6.0Mbps 802.11n (20MHz): up to 72.0Mbps
OPERATING FREQUENCY	2412 ~ 2462MHz
NUMBER OF CHANNEL	11
OUTPUT POWER	245.5mW
ANTENNA TYPE	PIFA antenna with -1.06dBi gain
ANTENNA CONNECTOR	IPX3
I/O PORTS	Refer to users' manual
DATA CABLE	1.0m non-shielded USB cable without core
ACCESSORY DEVICES	Adapter, Battery

NOTE:

1. The “ * ” in model number TOSHIBA AT20***** can be 0-9, a-z, A-Z, /, - or blank for marketing purpose.
2. The frequency bands used in this EUT are listed as follow:

Frequency Band (MHz)	2412~2462	2402~2480
802.11b	√	
802.11g	√	
802.11n (20MHz)	√	
Bluetooth		√

3. The EUT provides one completed transmitter and one receiver.

MODULATION MODE	TX FUNCTION
802.11b	1TX
802.11g	1TX
802.11n (20MHz)	1TX

4. The EUT was powered by the following charger and battery:

CHARGER	
BRAND	TOSHIBA
MODEL	ADP-10BW BA
INPUT POWER	100-240Vac, 50/60Hz, 0.4A
OUTPUT POWER	5Vdc, 2A

BATTERY	
BRAND	TOSHIBA
MODEL	PA3995U-1BRS
POWER RATING	3.7Vdc, 6690mAh, 25Wh

5. The above EUT information is declared by manufacturer and for more detailed features description, please refer to the manufacturer's specifications or user's manual.

3.2 DESCRIPTION OF TEST MODES

11 channels are provided for 802.11b, 802.11g and 802.11n (20MHz):

CHANNEL	FREQUENCY	CHANNEL	FREQUENCY
1	2412MHz	7	2442MHz
2	2417MHz	8	2447MHz
3	2422MHz	9	2452MHz
4	2427MHz	10	2457MHz
5	2432MHz	11	2462MHz
6	2437MHz		

3.2.1 CONFIGURATION OF SYSTEM UNDER TEST

For Test Mode A

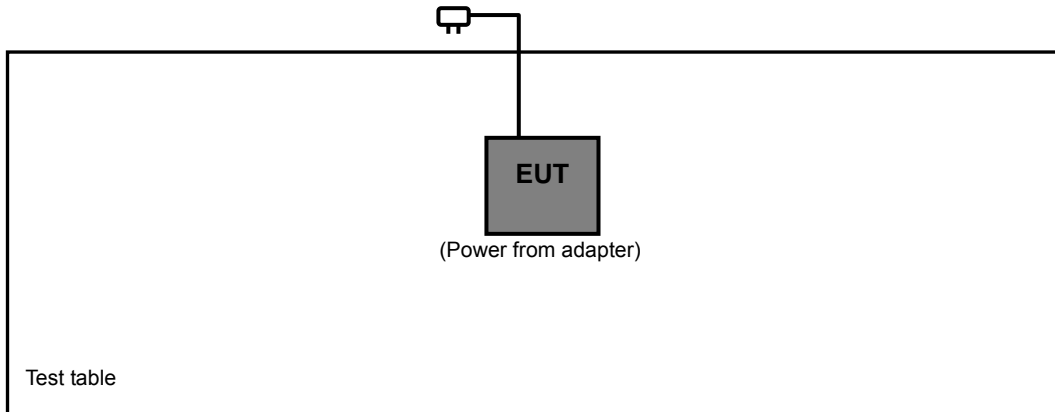

For Test Mode B

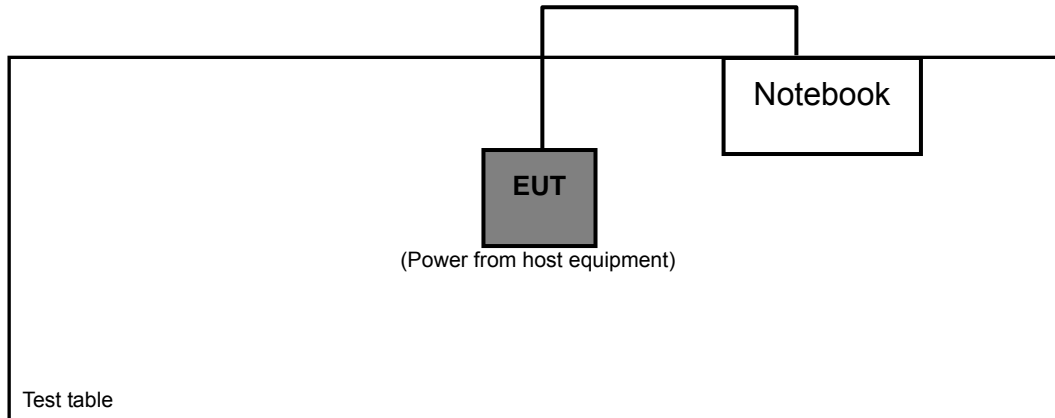



A D T

3.2.2 TEST MODE APPLICABILITY AND TESTED CHANNEL DETAIL

EUT CONFIGURE MODE	APPLICABLE TO				DESCRIPTION
	RE≥1G	RE<1G	PLC	APCM	
A	√	√	√	√	Power from adapter
B	-	√	√	-	Power from host equipment

Where **RE≥1G**: Radiated Emission above 1GHz **RE<1G**: Radiated Emission below 1GHz
PLC: Power Line Conducted Emission **APCM**: Antenna Port Conducted Measurement
NOTE: "-": Means no effect.

RADIATED EMISSION TEST (ABOVE 1GHz):

- Pre-Scan has been conducted to determine the worst-case mode from all possible combinations between available modulations, XYZ axis and antenna ports (if EUT with antenna diversity architecture).
- Following channel(s) was (were) selected for the final test as listed below.

EUT CONFIGURE MODE	MODE	AVAILABLE CHANNEL	TESTED CHANNEL	MODULATION TECHNOLOGY	MODULATION TYPE	DATA RATE (Mbps)	AXIS
A	802.11b	1 to 11	1, 6, 11	DSSS	DBPSK	1.0	Z
A	802.11g	1 to 11	1, 6, 11	OFDM	BPSK	6.0	Z
A	802.11n (20MHz)	1 to 11	1, 6, 11	OFDM	BPSK	6.5	Z

RADIATED EMISSION TEST (BELOW 1GHz):

- Pre-Scan has been conducted to determine the worst-case mode from all possible combinations between available modulations, XYZ axis and antenna ports (if EUT with antenna diversity architecture).
- Following channel(s) was (were) selected for the final test as listed below.

EUT CONFIGURE MODE	MODE	AVAILABLE CHANNEL	TESTED CHANNEL	MODULATION TECHNOLOGY	MODULATION TYPE	DATA RATE (Mbps)	AXIS
A, B	802.11g	1 to 11	11	OFDM	BPSK	6.0	Z

POWER LINE CONDUCTED EMISSION TEST:

- Pre-Scan has been conducted to determine the worst-case mode from all possible combinations between available modulations, data rates and antenna ports (if EUT with antenna diversity architecture).
- Following channel(s) was (were) selected for the final test as listed below.

EUT CONFIGURE MODE	MODE	AVAILABLE CHANNEL	TESTED CHANNEL	MODULATION TECHNOLOGY	MODULATION TYPE	DATA RATE (Mbps)
A, B	802.11g	1 to 11	11	OFDM	BPSK	6.0



ANDEGE MEASUREMENT:

- Pre-Scan has been conducted to determine the worst-case mode from all possible combinations between available modulations, data rates and antenna ports (if EUT with antenna diversity architecture).
- Following channel(s) was (were) selected for the final test as listed below.

EUT CONFIGURE MODE	MODE	AVAILABLE CHANNEL	TESTED CHANNEL	MODULATION TECHNOLOGY	MODULATION TYPE	DATA RATE (Mbps)
A	802.11b	1 to 11	1, 11	DSSS	DBPSK	1.0
A	802.11g	1 to 11	1, 11	OFDM	BPSK	6.0
A	802.11n (20MHz)	1 to 11	1, 11	OFDM	BPSK	6.5

ANTENNA PORT CONDUCTED MEASUREMENT:

- This item includes all test value of each mode, but only includes spectrum plot of worst value of each mode.
- Pre-Scan has been conducted to determine the worst-case mode from all possible combinations between available modulations, data rates and antenna ports (if EUT with antenna diversity architecture).
- Following channel(s) was (were) selected for the final test as listed below.

EUT CONFIGURE MODE	MODE	AVAILABLE CHANNEL	TESTED CHANNEL	MODULATION TECHNOLOGY	MODULATION TYPE	DATA RATE (Mbps)
A	802.11b	1 to 11	1, 6, 11	DSSS	DBPSK	1.0
A	802.11g	1 to 11	1, 6, 11	OFDM	BPSK	6.0
A	802.11n (20MHz)	1 to 11	1, 6, 11	OFDM	BPSK	6.5

TEST CONDITION:

APPLICABLE TO	ENVIRONMENTAL CONDITIONS	INPUT POWER	TESTED BY
RE≥1G	25deg. C, 66%RH	120Vac, 60Hz	David Huang
RE<1G	25deg. C, 66%RH	120Vac, 60Hz	David Huang
PLC	25deg. C, 66%RH	120Vac, 60Hz	David Huang
APCM	26deg. C, 65%RH	120Vac, 60Hz	Sun Lin



A D T

3.3 GENERAL DESCRIPTION OF APPLIED STANDARDS

The EUT is a RF Product. According to the specifications of the manufacturer, it must comply with the requirements of the following standards:

FCC Part 15, Subpart C (15.247)

ANSI C63.4-2003

ANSI C63.10-2009

All test items have been performed and recorded as per the above standards.

NOTE: The EUT is also considered as a kind of personal computer. It has been verified to comply with the requirements of FCC Part 15, Subpart B, Class B (DoC). The test report has been issued separately.

3.4 DESCRIPTION OF SUPPORT UNITS

The EUT has been tested as an independent unit together with other necessary accessories or support units. The following support units or accessories were used to form a representative test configuration during the tests.

NO.	PRODUCT	BRAND	MODEL NO.	SERIAL NO.	FCC ID
1	NOTEBOOK	DELL	E5410	1HC2XM1	NA

NO.	SIGNAL CABLE DESCRIPTION OF THE ABOVE SUPPORT UNITS
1	NA

NOTE: All power cords of the above support units are non-shielded (1.8m).



4. TEST TYPES AND RESULTS

4.1 RADIATED EMISSION MEASUREMENT

4.1.1 LIMITS OF RADIATED EMISSION MEASUREMENT

Radiated emissions which fall in the restricted bands, as defined in Section 15.205(a), must also comply with the radiated emission limits specified in Section 15.209(a). Other emissions shall be at least 20dB below the highest level of the desired power.

FREQUENCIES (MHz)	FIELD STRENGTH (microvolts/meter)	MEASUREMENT DISTANCE (meters)
0.009 ~ 0.490	2400/F(kHz)	300
0.490 ~ 1.705	24000/F(kHz)	30
1.705 ~ 30.0	30	30
30 ~ 88	100	3
88 ~ 216	150	3
216 ~ 960	200	3
Above 960	500	3

NOTE:

1. The lower limit shall apply at the transition frequencies.
2. Emission level (dBuV/m) = 20 log Emission level (uV/m).
3. As shown in 15.35(b), for frequencies above 1000MHz, the field strength limits are based on average detector, however, the peak field strength of any emission shall not exceed the maximum permitted average limits, specified above by more than 20dB under any condition of modulation.



4.1.2 TEST INSTRUMENTS

DESCRIPTION & MANUFACTURER	MODEL NO.	SERIAL NO.	DATE OF CALIBRATION	DUE DATE OF CALIBRATION
Test Receiver ROHDE & SCHWARZ	ESIB7	100212	Aug. 02, 2011	Aug. 01, 2012
Spectrum Analyzer ROHDE & SCHWARZ	FSP 40	100041	Jul. 21, 2011	Jul. 20, 2012
BILOG Antenna SCHWARZBECK	VULB9168	9168-160	Apr. 13, 2011	Apr. 12, 2012
HORN Antenna SCHWARZBECK	9120D	209	Aug. 25, 2011	Aug. 24, 2012
HORN Antenna SCHWARZBECK	BBHA 9170	BBHA9170243	Dec. 27, 2010	Dec. 26, 2011
Preamplifier Agilent	8447D	2944A10633	Nov. 02, 2010	Nov. 01, 2011
Preamplifier Agilent	8449B	3008A01964	Nov. 02, 2010	Nov. 01, 2011
RF signal cable HUBER+SUHNNER	SUCOFLEX 104	295014/4	Aug. 19, 2011	Aug. 18, 2012
RF signal cable HUBER+SUHNNER	SUCOFLEX 104	12738/6	Aug. 19, 2011	Aug. 18, 2012
Software ADT.	ADT_Radiated_ V7.6.15.9.2	NA	NA	NA
Antenna Tower inn-co GmbH	MA 4000	013303	NA	NA
Antenna Tower Controller inn-co GmbH	CO2000	017303	NA	NA
Turn Table ADT.	TT100.	TT93021703	NA	NA
Turn Table Controller ADT.	SC100.	SC93021703	NA	NA
LOOP ANTENNA	HFH2-Z2	100070	Feb. 03, 2010	Feb. 02, 2012

- NOTE:**
1. The calibration interval of the above test instruments except loop antenna is 12 months, and the calibrations are traceable to NML/ROC and NIST/USA.
 2. The calibration interval of the loop antenna is 24 months and the calibrations are traceable to NML/ROC and NIST/USA.
 3. The test was performed in HwaYa Chamber 3.
 4. The horn antenna and HP preamplifier (model: 8449B) are used only for the measurement of emission frequency above 1GHz if tested.
 5. The FCC Site Registration No. is 988962.
 6. The IC Site Registration No. is IC 7450F-3.



4.1.3 TEST PROCEDURES

- a. The EUT was placed on the top of a rotating table 0.8 meters above the ground at a 3 meters semi-anechoic chamber. The table was rotated 360 degrees to determine the position of the highest radiation.
- b. The EUT was set 3 meters away from the interference-receiving antenna, which was mounted on the top of a variable-height antenna tower.
- c. The antenna is a broadband antenna, and its height is varied from one meter to four meters above the ground to determine the maximum value of the field strength. Both horizontal and vertical polarizations of the antenna are set to make the measurement.
- d. For each suspected emission, the EUT was arranged to its worst case and then the antenna was tuned to heights from 1 meter to 4 meters and the rotatable table was turned from 0 degrees to 360 degrees to find the maximum reading.
- e. The test-receiver system was set to Peak Detect Function and Specified Bandwidth with Maximum Hold Mode.
- f. If the emission level of the EUT in peak mode was lower than the limit specified, then testing could be stopped and the peak values of the EUT would be reported. Otherwise the emissions would be re-tested one by one using peak, quasi-peak or average method as specified and then reported in a data sheet.

NOTE:

1. The resolution bandwidth and video bandwidth of test receiver/spectrum analyzer is 120kHz for Quasi-peak detection at frequency below 1GHz.
2. The resolution bandwidth of test receiver/spectrum analyzer is 1MHz and video bandwidth is 3MHz for Peak detection at frequency above 1GHz.
3. The resolution bandwidth of test receiver/spectrum analyzer is 1MHz and the video bandwidth is 10Hz for Average detection (AV) at frequency above 1GHz.
4. All modes of operation were investigated and the worst-case emissions are reported.

4.1.4 DEVIATION FROM TEST STANDARD

No deviation.

4.1.5 TEST SETUP

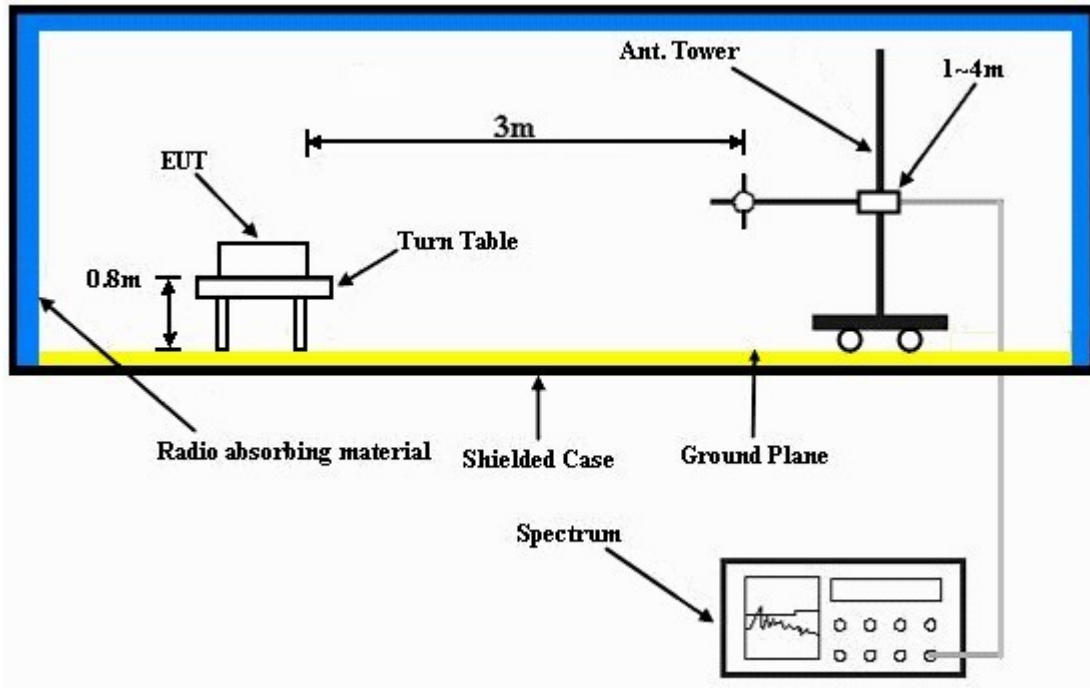

For the actual test configuration, please refer to the attached file (Test Setup Photo).

4.1.6 EUT OPERATING CONDITIONS

- a. Placed the EUT on the testing table.
- b. Set the EUT under transmitting condition continuously at specific channel frequency.



A D T

4.1.7 TEST RESULT

802.11b

EUT TEST CONDITION		MEASUREMENT DETAIL	
CHANNEL	Channel 1	FREQUENCY RANGE	1 ~ 25GHz
INPUT POWER (SYSTEM)	120Vac, 60Hz	DETECTOR FUNCTION	Peak (PK) Average (AV)
ENVIRONMENTAL CONDITIONS	25deg. C, 65%RH	TESTED BY	David Huang

ANTENNA POLARITY & TEST DISTANCE: HORIZONTAL AT 3 M								
NO.	FREQ. (MHz)	EMISSION LEVEL (dBuV/m)	LIMIT (dBuV/m)	MARGIN (dB)	ANTENNA HEIGHT (m)	TABLE ANGLE (Degree)	RAW VALUE (dBuV)	CORRECTION FACTOR (dB/m)
1	2390.00	61.2 PK	74.0	-12.8	1.10 H	285	30.10	31.10
2	2390.00	51.1 AV	54.0	-2.9	1.10 H	285	20.00	31.10
3	*2412.00	109.9 PK			1.10 H	285	78.70	31.20
4	*2412.00	101.5 AV			1.10 H	285	70.30	31.20
5	4824.00	46.6 PK	74.0	-27.4	1.25 H	121	9.70	36.90
6	4824.00	38.8 AV	54.0	-15.2	1.25 H	121	1.90	36.90
ANTENNA POLARITY & TEST DISTANCE: VERTICAL AT 3 M								
NO.	FREQ. (MHz)	EMISSION LEVEL (dBuV/m)	LIMIT (dBuV/m)	MARGIN (dB)	ANTENNA HEIGHT (m)	TABLE ANGLE (Degree)	RAW VALUE (dBuV)	CORRECTION FACTOR (dB/m)
1	2390.00	60.0 PK	74.0	-14.0	1.00 V	354	28.90	31.10
2	2390.00	50.9 AV	54.0	-3.1	1.00 V	354	19.80	31.10
3	*2412.00	107.3 PK			1.00 V	354	76.10	31.20
4	*2412.00	98.8 AV			1.00 V	354	67.60	31.20
5	4824.00	47.2 PK	74.0	-26.8	1.13 V	191	10.30	36.90
6	4824.00	38.7 AV	54.0	-15.3	1.13 V	191	1.80	36.90

- REMARKS:**
1. Emission level (dBuV/m) = Raw Value (dBuV) + Correction Factor (dB/m).
 2. Correction Factor (dB/m) = Antenna Factor (dB/m) + Cable Factor (dB).
 3. The other emission levels were very low against the limit.
 4. Margin value = Emission level – Limit value.
 5. “ * “: Fundamental frequency.



A D T

EUT TEST CONDITION		MEASUREMENT DETAIL	
CHANNEL	Channel 6	FREQUENCY RANGE	1 ~ 25GHz
INPUT POWER (SYSTEM)	120Vac, 60Hz	DETECTOR FUNCTION	Peak (PK) Average (AV)
ENVIRONMENTAL CONDITIONS	25deg. C, 65%RH	TESTED BY	David Huang

ANTENNA POLARITY & TEST DISTANCE: HORIZONTAL AT 3 M								
NO.	FREQ. (MHz)	EMISSION LEVEL (dBuV/m)	LIMIT (dBuV/m)	MARGIN (dB)	ANTENNA HEIGHT (m)	TABLE ANGLE (Degree)	RAW VALUE (dBuV)	CORRECTION FACTOR (dB/m)
1	*2437.00	111.5 PK			1.10 H	288	80.20	31.30
2	*2437.00	102.8 AV			1.10 H	288	71.50	31.30
3	4874.00	47.3 PK	74.0	-26.7	1.15 H	122	10.30	37.00
4	4874.00	39.5 AV	54.0	-14.5	1.15 H	122	2.50	37.00
5	7311.00	52.3 PK	74.0	-21.7	1.00 H	241	9.20	43.10
6	7311.00	38.7 AV	54.0	-15.3	1.00 H	241	-4.40	43.10
ANTENNA POLARITY & TEST DISTANCE: VERTICAL AT 3 M								
NO.	FREQ. (MHz)	EMISSION LEVEL (dBuV/m)	LIMIT (dBuV/m)	MARGIN (dB)	ANTENNA HEIGHT (m)	TABLE ANGLE (Degree)	RAW VALUE (dBuV)	CORRECTION FACTOR (dB/m)
1	*2437.00	108.5 PK			1.00 V	348	77.20	31.30
2	*2437.00	100.2 AV			1.00 V	348	68.90	31.30
3	4874.00	47.8 PK	74.0	-26.2	1.00 V	327	10.80	37.00
4	4874.00	41.4 AV	54.0	-12.6	1.00 V	327	4.40	37.00
5	7311.00	52.2 PK	74.0	-21.8	1.00 V	157	9.10	43.10
6	7311.00	39.3 AV	54.0	-14.7	1.00 V	157	-3.80	43.10

- REMARKS:**
1. Emission level (dBuV/m) = Raw Value (dBuV) + Correction Factor (dB/m).
 2. Correction Factor (dB/m) = Antenna Factor (dB/m) + Cable Factor (dB).
 3. The other emission levels were very low against the limit.
 4. Margin value = Emission level – Limit value.
 5. “ * “: Fundamental frequency.



A D T

EUT TEST CONDITION		MEASUREMENT DETAIL	
CHANNEL	Channel 11	FREQUENCY RANGE	1 ~ 25GHz
INPUT POWER (SYSTEM)	120Vac, 60Hz	DETECTOR FUNCTION	Peak (PK) Average (AV)
ENVIRONMENTAL CONDITIONS	25deg. C, 65%RH	TESTED BY	David Huang

ANTENNA POLARITY & TEST DISTANCE: HORIZONTAL AT 3 M								
NO.	FREQ. (MHz)	EMISSION LEVEL (dBuV/m)	LIMIT (dBuV/m)	MARGIN (dB)	ANTENNA HEIGHT (m)	TABLE ANGLE (Degree)	RAW VALUE (dBuV)	CORRECTION FACTOR (dB/m)
1	*2462.00	111.2 PK			1.09 H	289	79.80	31.40
2	*2462.00	102.7 AV			1.09 H	289	71.30	31.40
3	2483.50	62.3 PK	74.0	-11.7	1.09 H	289	30.90	31.40
4	2483.50	51.4 AV	54.0	-2.6	1.09 H	289	20.00	31.40
5	4924.00	56.5 PK	74.0	-17.5	1.00 H	158	19.40	37.10
6	4924.00	40.0 AV	54.0	-14.0	1.00 H	158	2.90	37.10

ANTENNA POLARITY & TEST DISTANCE: VERTICAL AT 3 M								
NO.	FREQ. (MHz)	EMISSION LEVEL (dBuV/m)	LIMIT (dBuV/m)	MARGIN (dB)	ANTENNA HEIGHT (m)	TABLE ANGLE (Degree)	RAW VALUE (dBuV)	CORRECTION FACTOR (dB/m)
1	*2462.00	108.1 PK			1.00 V	348	76.70	31.40
2	*2462.00	99.7 AV			1.00 V	348	68.30	31.40
3	2483.50	61.2 PK	74.0	-12.8	1.00 V	348	29.80	31.40
4	2483.50	50.2 AV	54.0	-3.8	1.00 V	348	18.80	31.40
5	4924.00	57.6 PK	74.0	-16.4	1.00 V	234	20.50	37.10
6	4924.00	41.7 AV	54.0	-12.3	1.00 V	234	4.60	37.10

- REMARKS:**
1. Emission level (dBuV/m) = Raw Value (dBuV) + Correction Factor (dB/m).
 2. Correction Factor (dB/m) = Antenna Factor (dB/m) + Cable Factor (dB).
 3. The other emission levels were very low against the limit.
 4. Margin value = Emission level – Limit value.
 5. “ * “: Fundamental frequency.



A D T

802.11g

EUT TEST CONDITION		MEASUREMENT DETAIL	
CHANNEL	Channel 1	FREQUENCY RANGE	1 ~ 25GHz
INPUT POWER (SYSTEM)	120Vac, 60Hz	DETECTOR FUNCTION	Peak (PK) Average (AV)
ENVIRONMENTAL CONDITIONS	25deg. C, 65%RH	TESTED BY	David Huang

ANTENNA POLARITY & TEST DISTANCE: HORIZONTAL AT 3 M								
NO.	FREQ. (MHz)	EMISSION LEVEL (dBuV/m)	LIMIT (dBuV/m)	MARGIN (dB)	ANTENNA HEIGHT (m)	TABLE ANGLE (Degree)	RAW VALUE (dBuV)	CORRECTION FACTOR (dB/m)
1	2390.00	67.1 PK	74.0	-6.9	1.11 H	286	36.00	31.10
2	2390.00	52.0 AV	54.0	-2.0	1.11 H	286	20.90	31.10
3	*2412.00	111.4 PK			1.11 H	286	80.20	31.20
4	*2412.00	99.5 AV			1.11 H	286	68.30	31.20
5	4824.00	46.4 PK	74.0	-27.6	1.00 H	123	9.50	36.90
6	4824.00	32.5 AV	54.0	-21.5	1.00 H	123	-4.40	36.90
ANTENNA POLARITY & TEST DISTANCE: VERTICAL AT 3 M								
NO.	FREQ. (MHz)	EMISSION LEVEL (dBuV/m)	LIMIT (dBuV/m)	MARGIN (dB)	ANTENNA HEIGHT (m)	TABLE ANGLE (Degree)	RAW VALUE (dBuV)	CORRECTION FACTOR (dB/m)
1	2390.00	65.2 PK	74.0	-8.8	1.00 V	356	34.10	31.10
2	2390.00	50.9 AV	54.0	-3.1	1.00 V	356	19.80	31.10
3	*2412.00	108.6 PK			1.00 V	356	77.40	31.20
4	*2412.00	96.9 AV			1.00 V	356	65.70	31.20
5	4824.00	46.7 PK	74.0	-27.3	1.10 V	269	9.80	36.90
6	4824.00	33.4 AV	54.0	-20.6	1.10 V	269	-3.50	36.90

- REMARKS:**
1. Emission level (dBuV/m) = Raw Value (dBuV) + Correction Factor (dB/m).
 2. Correction Factor (dB/m) = Antenna Factor (dB/m) + Cable Factor (dB).
 3. The other emission levels were very low against the limit.
 4. Margin value = Emission level – Limit value.
 5. “ * “: Fundamental frequency.



A D T

EUT TEST CONDITION		MEASUREMENT DETAIL	
CHANNEL	Channel 6	FREQUENCY RANGE	1 ~ 25GHz
INPUT POWER (SYSTEM)	120Vac, 60Hz	DETECTOR FUNCTION	Peak (PK) Average (AV)
ENVIRONMENTAL CONDITIONS	25deg. C, 65%RH	TESTED BY	David Huang

ANTENNA POLARITY & TEST DISTANCE: HORIZONTAL AT 3 M								
NO.	FREQ. (MHz)	EMISSION LEVEL (dBuV/m)	LIMIT (dBuV/m)	MARGIN (dB)	ANTENNA HEIGHT (m)	TABLE ANGLE (Degree)	RAW VALUE (dBuV)	CORRECTION FACTOR (dB/m)
1	*2437.00	112.7 PK			1.10 H	288	81.40	31.30
2	*2437.00	101.1 AV			1.10 H	288	69.80	31.30
3	4874.00	46.4 PK	74.0	-27.6	1.00 H	159	9.40	37.00
4	4874.00	32.5 AV	54.0	-21.5	1.00 H	159	-4.50	37.00
5	7311.00	51.3 PK	74.0	-22.7	1.00 H	157	8.20	43.10
6	7311.00	37.4 AV	54.0	-16.6	1.00 H	157	-5.70	43.10
ANTENNA POLARITY & TEST DISTANCE: VERTICAL AT 3 M								
NO.	FREQ. (MHz)	EMISSION LEVEL (dBuV/m)	LIMIT (dBuV/m)	MARGIN (dB)	ANTENNA HEIGHT (m)	TABLE ANGLE (Degree)	RAW VALUE (dBuV)	CORRECTION FACTOR (dB/m)
1	*2437.00	108.8 PK			1.00 V	350	77.50	31.30
2	*2437.00	97.9 AV			1.00 V	350	66.60	31.30
3	4874.00	46.4 PK	74.0	-27.6	1.00 V	213	9.40	37.00
4	4874.00	33.3 AV	54.0	-20.7	1.00 V	213	-3.70	37.00
5	7311.00	52.3 PK	74.0	-21.7	1.00 V	113	9.20	43.10
6	7311.00	38.3 AV	54.0	-15.7	1.00 V	113	-4.80	43.10

- REMARKS:**
1. Emission level (dBuV/m) = Raw Value (dBuV) + Correction Factor (dB/m).
 2. Correction Factor (dB/m) = Antenna Factor (dB/m) + Cable Factor (dB).
 3. The other emission levels were very low against the limit.
 4. Margin value = Emission level – Limit value.
 5. “ * “: Fundamental frequency.



A D T

EUT TEST CONDITION		MEASUREMENT DETAIL	
CHANNEL	Channel 11	FREQUENCY RANGE	1 ~ 25GHz
INPUT POWER (SYSTEM)	120Vac, 60Hz	DETECTOR FUNCTION	Peak (PK) Average (AV)
ENVIRONMENTAL CONDITIONS	25deg. C, 65%RH	TESTED BY	David Huang

ANTENNA POLARITY & TEST DISTANCE: HORIZONTAL AT 3 M								
NO.	FREQ. (MHz)	EMISSION LEVEL (dBuV/m)	LIMIT (dBuV/m)	MARGIN (dB)	ANTENNA HEIGHT (m)	TABLE ANGLE (Degree)	RAW VALUE (dBuV)	CORRECTION FACTOR (dB/m)
1	*2462.00	111.9 PK			1.09 H	288	80.50	31.40
2	*2462.00	101.0 AV			1.09 H	288	69.60	31.40
3	2483.50	70.2 PK	74.0	-3.8	1.09 H	288	38.80	31.40
4	2483.50	52.0 AV	54.0	-2.0	1.09 H	288	20.60	31.40
5	4924.00	45.9 PK	74.0	-28.1	1.00 H	210	8.80	37.10
6	4924.00	33.0 AV	54.0	-21.0	1.00 H	210	-4.10	37.10
ANTENNA POLARITY & TEST DISTANCE: VERTICAL AT 3 M								
NO.	FREQ. (MHz)	EMISSION LEVEL (dBuV/m)	LIMIT (dBuV/m)	MARGIN (dB)	ANTENNA HEIGHT (m)	TABLE ANGLE (Degree)	RAW VALUE (dBuV)	CORRECTION FACTOR (dB/m)
1	*2462.00	109.1 PK			1.00 V	346	77.70	31.40
2	*2462.00	97.9 AV			1.00 V	346	66.50	31.40
3	2483.50	65.0 PK	74.0	-9.0	1.00 V	346	33.60	31.40
4	2483.50	51.1 AV	54.0	-2.9	1.00 V	346	19.70	31.40
5	4924.00	46.9 PK	74.0	-27.1	1.10 V	246	9.80	37.10
6	4924.00	33.9 AV	54.0	-20.1	1.10 V	246	-3.20	37.10

- REMARKS:**
1. Emission level (dBuV/m) = Raw Value (dBuV) + Correction Factor (dB/m).
 2. Correction Factor (dB/m) = Antenna Factor (dB/m) + Cable Factor (dB).
 3. The other emission levels were very low against the limit.
 4. Margin value = Emission level – Limit value.
 5. “ * “: Fundamental frequency.



A D T

802.11n (20MHz)

EUT TEST CONDITION		MEASUREMENT DETAIL	
CHANNEL	Channel 1	FREQUENCY RANGE	1 ~ 25GHz
INPUT POWER (SYSTEM)	120Vac, 60Hz	DETECTOR FUNCTION	Peak (PK) Average (AV)
ENVIRONMENTAL CONDITIONS	25deg. C, 65%RH	TESTED BY	David Huang

ANTENNA POLARITY & TEST DISTANCE: HORIZONTAL AT 3 M								
NO.	FREQ. (MHz)	EMISSION LEVEL (dBuV/m)	LIMIT (dBuV/m)	MARGIN (dB)	ANTENNA HEIGHT (m)	TABLE ANGLE (Degree)	RAW VALUE (dBuV)	CORRECTION FACTOR (dB/m)
1	2390.00	61.3 PK	74.0	-12.7	1.09 H	288	30.20	31.10
2	2390.00	51.8 AV	54.0	-2.2	1.09 H	288	20.70	31.10
3	*2412.00	109.5 PK			1.09 H	288	78.30	31.20
4	*2412.00	97.2 AV			1.09 H	288	66.00	31.20
5	4824.00	45.4 PK	74.0	-28.6	1.00 H	193	8.50	36.90
6	4824.00	32.7 AV	54.0	-21.3	1.00 H	193	-4.20	36.90
ANTENNA POLARITY & TEST DISTANCE: VERTICAL AT 3 M								
NO.	FREQ. (MHz)	EMISSION LEVEL (dBuV/m)	LIMIT (dBuV/m)	MARGIN (dB)	ANTENNA HEIGHT (m)	TABLE ANGLE (Degree)	RAW VALUE (dBuV)	CORRECTION FACTOR (dB/m)
1	2390.00	61.0 PK	74.0	-13.0	1.00 V	355	29.90	31.10
2	2390.00	50.4 AV	54.0	-3.6	1.00 V	355	19.30	31.10
3	*2412.00	107.2 PK			1.00 V	355	76.00	31.20
4	*2412.00	94.7 AV			1.00 V	355	63.50	31.20
5	4824.00	46.2 PK	74.0	-27.8	1.00 V	172	9.30	36.90
6	4824.00	33.4 AV	54.0	-20.6	1.00 V	172	-3.50	36.90

- REMARKS:**
1. Emission level (dBuV/m) = Raw Value (dBuV) + Correction Factor (dB/m).
 2. Correction Factor (dB/m) = Antenna Factor (dB/m) + Cable Factor (dB).
 3. The other emission levels were very low against the limit.
 4. Margin value = Emission level – Limit value.
 5. “ * “: Fundamental frequency.



A D T

EUT TEST CONDITION		MEASUREMENT DETAIL	
CHANNEL	Channel 6	FREQUENCY RANGE	1 ~ 25GHz
INPUT POWER (SYSTEM)	120Vac, 60Hz	DETECTOR FUNCTION	Peak (PK) Average (AV)
ENVIRONMENTAL CONDITIONS	25deg. C, 65%RH	TESTED BY	David Huang

ANTENNA POLARITY & TEST DISTANCE: HORIZONTAL AT 3 M								
NO.	FREQ. (MHz)	EMISSION LEVEL (dBuV/m)	LIMIT (dBuV/m)	MARGIN (dB)	ANTENNA HEIGHT (m)	TABLE ANGLE (Degree)	RAW VALUE (dBuV)	CORRECTION FACTOR (dB/m)
1	*2437.00	111.2 PK			1.09 H	287	79.90	31.30
2	*2437.00	98.9 AV			1.09 H	287	67.60	31.30
3	4874.00	45.3 PK	74.0	-28.7	1.00 H	241	8.30	37.00
4	4874.00	32.5 AV	54.0	-21.5	1.00 H	241	-4.50	37.00
5	7311.00	51.2 PK	74.0	-22.8	1.00 H	161	8.10	43.10
6	7311.00	37.3 AV	54.0	-16.7	1.00 H	161	-5.80	43.10

ANTENNA POLARITY & TEST DISTANCE: VERTICAL AT 3 M								
NO.	FREQ. (MHz)	EMISSION LEVEL (dBuV/m)	LIMIT (dBuV/m)	MARGIN (dB)	ANTENNA HEIGHT (m)	TABLE ANGLE (Degree)	RAW VALUE (dBuV)	CORRECTION FACTOR (dB/m)
1	*2437.00	108.5 PK			1.00 V	349	77.20	31.30
2	*2437.00	95.9 AV			1.00 V	349	64.60	31.30
3	4874.00	46.8 PK	74.0	-27.2	1.00 V	136	9.80	37.00
4	4874.00	33.5 AV	54.0	-20.5	1.00 V	136	-3.50	37.00
5	7311.00	51.2 PK	74.0	-22.8	1.00 V	258	8.10	43.10
6	7311.00	38.7 AV	54.0	-15.3	1.00 V	258	-4.40	43.10

- REMARKS:**
1. Emission level (dBuV/m) = Raw Value (dBuV) + Correction Factor (dB/m).
 2. Correction Factor (dB/m) = Antenna Factor (dB/m) + Cable Factor (dB).
 3. The other emission levels were very low against the limit.
 4. Margin value = Emission level – Limit value.
 5. “ * “: Fundamental frequency.



A D T

EUT TEST CONDITION		MEASUREMENT DETAIL	
CHANNEL	Channel 11	FREQUENCY RANGE	1 ~ 25GHz
INPUT POWER (SYSTEM)	120Vac, 60Hz	DETECTOR FUNCTION	Peak (PK) Average (AV)
ENVIRONMENTAL CONDITIONS	25deg. C, 65%RH	TESTED BY	David Huang

ANTENNA POLARITY & TEST DISTANCE: HORIZONTAL AT 3 M								
NO.	FREQ. (MHz)	EMISSION LEVEL (dBuV/m)	LIMIT (dBuV/m)	MARGIN (dB)	ANTENNA HEIGHT (m)	TABLE ANGLE (Degree)	RAW VALUE (dBuV)	CORRECTION FACTOR (dB/m)
1	*2462.00	111.5 PK			1.09 H	289	80.10	31.40
2	*2462.00	98.8 AV			1.09 H	289	67.40	31.40
3	2483.50	62.0 PK	74.0	-12.0	1.09 H	289	30.60	31.40
4	2483.50	51.7 AV	54.0	-2.3	1.09 H	289	20.30	31.40
5	4924.00	47.6 PK	74.0	-26.4	1.00 H	254	10.50	37.10
6	4924.00	33.4 AV	54.0	-20.6	1.00 H	254	-3.70	37.10
ANTENNA POLARITY & TEST DISTANCE: VERTICAL AT 3 M								
NO.	FREQ. (MHz)	EMISSION LEVEL (dBuV/m)	LIMIT (dBuV/m)	MARGIN (dB)	ANTENNA HEIGHT (m)	TABLE ANGLE (Degree)	RAW VALUE (dBuV)	CORRECTION FACTOR (dB/m)
1	*2462.00	108.3 PK			1.00 V	347	76.90	31.40
2	*2462.00	95.7 AV			1.00 V	347	64.30	31.40
3	2483.50	63.3 PK	74.0	-10.7	1.00 V	347	31.90	31.40
4	2483.50	51.0 AV	54.0	-3.0	1.00 V	347	19.60	31.40
5	4924.00	47.9 PK	74.0	-26.1	1.10 V	116	10.80	37.10
6	4924.00	33.9 AV	54.0	-20.1	1.10 V	116	-3.20	37.10

- REMARKS:**
1. Emission level (dBuV/m) = Raw Value (dBuV) + Correction Factor (dB/m).
 2. Correction Factor (dB/m) = Antenna Factor (dB/m) + Cable Factor (dB).
 3. The other emission levels were very low against the limit.
 4. Margin value = Emission level – Limit value.
 5. “ * “: Fundamental frequency.



A D T

BELOW 1GHz WORST-CASE DATA : 802.11g

EUT TEST CONDITION		MEASUREMENT DETAIL	
CHANNEL	Channel 11	FREQUENCY RANGE	Below 1000MHz
INPUT POWER (SYSTEM)	120Vac, 60Hz	DETECTOR FUNCTION	Quasi-Peak
ENVIRONMENTAL CONDITIONS	25deg. C, 65%RH	TESTED BY	David Huang
TEST MODE	A		

ANTENNA POLARITY & TEST DISTANCE: HORIZONTAL AT 3 M								
NO.	FREQ. (MHz)	EMISSION LEVEL (dBuV/m)	LIMIT (dBuV/m)	MARGIN (dB)	ANTENNA HEIGHT (m)	TABLE ANGLE (Degree)	RAW VALUE (dBuV)	CORRECTION FACTOR (dB/m)
1	78.51	23.3 QP	40.0	-16.7	2.00 H	166	13.70	9.60
2	162.11	31.1 QP	43.5	-12.4	2.00 H	274	16.60	14.50
3	239.88	29.7 QP	46.0	-16.3	1.00 H	151	17.20	12.50
4	263.21	29.4 QP	46.0	-16.6	1.00 H	91	15.90	13.50
5	463.48	22.9 QP	46.0	-23.1	2.00 H	130	3.70	19.20
6	690.96	24.4 QP	46.0	-21.6	1.00 H	157	0.50	23.90
ANTENNA POLARITY & TEST DISTANCE: VERTICAL AT 3 M								
NO.	FREQ. (MHz)	EMISSION LEVEL (dBuV/m)	LIMIT (dBuV/m)	MARGIN (dB)	ANTENNA HEIGHT (m)	TABLE ANGLE (Degree)	RAW VALUE (dBuV)	CORRECTION FACTOR (dB/m)
1	51.29	32.8 QP	40.0	-7.2	1.00 V	10	18.50	14.30
2	74.62	26.7 QP	40.0	-13.3	1.00 V	160	16.00	10.70
3	101.84	21.9 QP	43.5	-21.6	1.00 V	349	11.50	10.40
4	160.17	24.1 QP	43.5	-19.4	1.00 V	115	9.40	14.70
5	241.83	26.7 QP	46.0	-19.3	1.00 V	211	14.10	12.60
6	506.25	22.6 QP	46.0	-23.4	1.00 V	316	2.30	20.30

- REMARKS:**
1. Emission level (dBuV/m) = Raw Value (dBuV) + Correction Factor (dB/m).
 2. Correction Factor (dB/m) = Antenna Factor (dB/m) + Cable Factor (dB).
 3. The other emission levels were very low against the limit.
 4. Margin value = Emission level – Limit value.
 5. Measured values of spurious emission below 30MHz are more than 20 dB below the limit.



A D T

EUT TEST CONDITION		MEASUREMENT DETAIL	
CHANNEL	Channel 11	FREQUENCY RANGE	Below 1000MHz
INPUT POWER (SYSTEM)	120Vac, 60Hz	DETECTOR FUNCTION	Quasi-Peak
ENVIRONMENTAL CONDITIONS	25deg. C, 65%RH	TESTED BY	David Huang
TEST MODE	B		

ANTENNA POLARITY & TEST DISTANCE: HORIZONTAL AT 3 M								
NO.	FREQ. (MHz)	EMISSION LEVEL (dBuV/m)	LIMIT (dBuV/m)	MARGIN (dB)	ANTENNA HEIGHT (m)	TABLE ANGLE (Degree)	RAW VALUE (dBuV)	CORRECTION FACTOR (dB/m)
1	132.95	25.2 QP	43.5	-18.3	2.00 H	121	11.70	13.50
2	166.00	29.4 QP	43.5	-14.1	1.00 H	85	15.40	14.00
3	276.82	36.2 QP	46.0	-9.8	2.00 H	40	22.20	14.00
4	432.37	23.8 QP	46.0	-22.2	2.00 H	139	5.50	18.30
5	527.64	26.8 QP	46.0	-19.2	2.00 H	103	6.00	20.80
6	624.85	26.9 QP	46.0	-19.1	1.00 H	136	4.00	22.90
ANTENNA POLARITY & TEST DISTANCE: VERTICAL AT 3 M								
NO.	FREQ. (MHz)	EMISSION LEVEL (dBuV/m)	LIMIT (dBuV/m)	MARGIN (dB)	ANTENNA HEIGHT (m)	TABLE ANGLE (Degree)	RAW VALUE (dBuV)	CORRECTION FACTOR (dB/m)
1	70.73	24.8 QP	40.0	-15.2	2.00 V	82	13.00	11.80
2	132.95	28.8 QP	43.5	-14.7	1.00 V	151	15.30	13.50
3	166.00	28.0 QP	43.5	-15.5	1.00 V	268	14.00	14.00
4	191.28	21.5 QP	43.5	-22.0	1.00 V	124	10.20	11.30
5	276.82	27.0 QP	46.0	-19.0	2.00 V	82	13.00	14.00
6	527.64	25.1 QP	46.0	-20.9	1.00 V	157	4.30	20.80

- REMARKS:**
1. Emission level (dBuV/m) = Raw Value (dBuV) + Correction Factor (dB/m).
 2. Correction Factor (dB/m) = Antenna Factor (dB/m) + Cable Factor (dB).
 3. The other emission levels were very low against the limit.
 4. Margin value = Emission level – Limit value.
 5. Measured values of spurious emission below 30MHz are more than 20 dB below the limit.



4.2 CONDUCTED EMISSION MEASUREMENT

4.2.1 LIMITS OF CONDUCTED EMISSION MEASUREMENT

FREQUENCY OF EMISSION (MHz)	CONDUCTED LIMIT (dBµV)	
	Quasi-peak	Average
0.15 ~ 0.5	66 to 56	56 to 46
0.5 ~ 5	56	46
5 ~ 30	60	50

- NOTE:**
1. The lower limit shall apply at the transition frequencies.
 2. The limit decreases in line with the logarithm of the frequency in the range of 0.15 to 0.50MHz.
 3. All emanations from a class A/B digital device or system, including any network of conductors and apparatus connected thereto, shall not exceed the level of field strengths specified above.

4.2.2 TEST INSTRUMENTS

DESCRIPTION & MANUFACTURER	MODEL NO.	SERIAL NO.	DATE OF CALIBRATION	DUE DATE OF CALIBRATION
Test Receiver ROHDE & SCHWARZ	ESCS30	100289	Nov. 23, 2010	Nov. 22, 2011
RF signal cable Woken	5D-FB	Cable-HYCO2-01	Dec. 30, 2010	Dec. 29, 2011
LISN ROHDE & SCHWARZ	ESH2-Z5	100100	Jan. 06, 2011	Jan. 05, 2012
LISN ROHDE & SCHWARZ	ESH3-Z5	100312	Jul. 07, 2011	Jul. 06, 2012
Software ADT	ADT_Cond_ V7.3.7	NA	NA	NA

- NOTE:**
1. The calibration interval of the above test instruments is 12 months and the calibrations are traceable to NML/ROC and NIST/USA.
 2. The test was performed in HwaYa Shielded Room 2.
 3. The VCCI Site Registration No. is C-2047.



A D T

4.2.3 TEST PROCEDURES

- a. The EUT was placed 0.4 meters from the conducting wall of the shielded room with EUT being connected to the power mains through a line impedance stabilization network (LISN). Other support units were connected to the power mains through another LISN. The two LISNs provide 50 ohm/ 50uH of coupling impedance for the measuring instrument.
- b. Both lines of the power mains connected to the EUT were checked for maximum conducted interference.
- c. The frequency range from 150kHz to 30MHz was searched. Emission levels under (Limit - 20dB) was not recorded.

NOTE: All modes of operation were investigated and the worst-case emissions are reported.

4.2.4 DEVIATION FROM TEST STANDARD

No deviation.

4.2.5 TEST SETUP

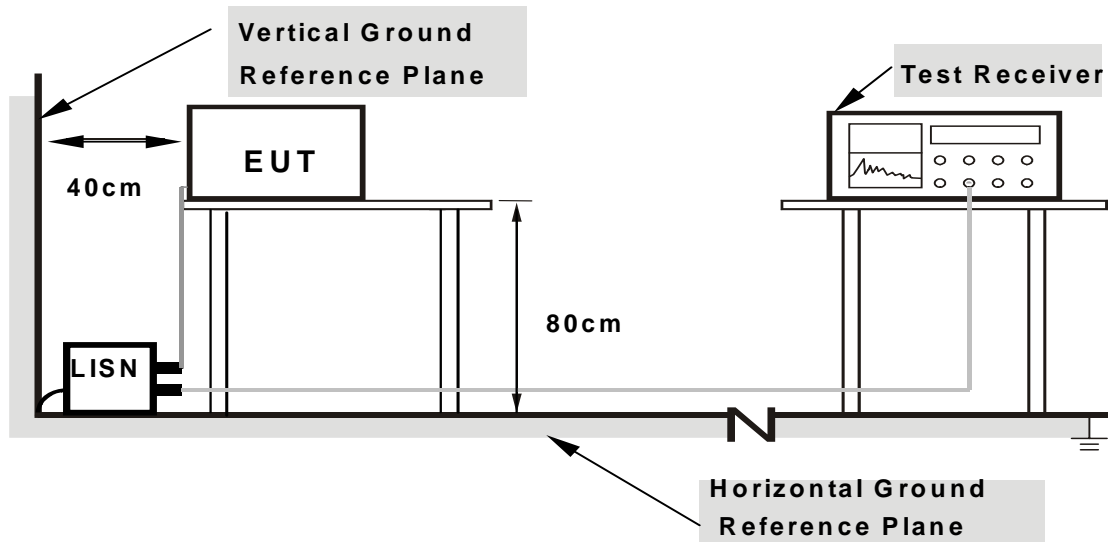

Note: 1.Support units were connected to second LISN.

2.Both of LISNs (AMN) are 80 cm from EUT and at least 80 from other units and other metal planes

For the actual test configuration, please refer to the attached file (Test Setup Photo).

4.2.6 EUT OPERATING CONDITIONS

Same as 4.1.6.

4.2.7 TEST RESULTS

CONDUCTED WORST-CASE DATA : 802.11g

PHASE	Line 1	6dB BANDWIDTH	9kHz
TEST MODE	A		

No	Freq. [MHz]	Corr. Factor (dB)	Reading Value [dB (uV)]		Emission Level [dB (uV)]		Limit [dB (uV)]		Margin (dB)	
			Q.P.	AV.	Q.P.	AV.	Q.P.	AV.	Q.P.	AV.
1	0.216	0.15	57.60	41.95	57.75	42.10	62.96	52.96	-5.20	-10.85
2	0.302	0.16	46.62	28.77	46.78	28.93	60.18	50.18	-13.40	-21.25
3	0.439	0.17	43.12	24.57	43.29	24.74	57.08	47.08	-13.79	-22.34
4	0.509	0.17	42.39	23.87	42.56	24.04	56.00	46.00	-13.44	-21.96
5	0.853	0.19	39.32	19.06	39.51	19.25	56.00	46.00	-16.49	-26.75
6	1.703	0.21	36.63	20.11	36.84	20.32	56.00	46.00	-19.16	-25.68

- REMARKS:**
1. Q.P. and AV. are abbreviations of quasi-peak and average individually.
 2. "-": The Quasi-peak reading value also meets average limit and measurement with the average detector is unnecessary.
 3. The emission levels of other frequencies were very low against the limit.
 4. Margin value = Emission level - Limit value
 5. Correction factor = Insertion loss + Cable loss
 6. Emission Level = Correction Factor + Reading Value.

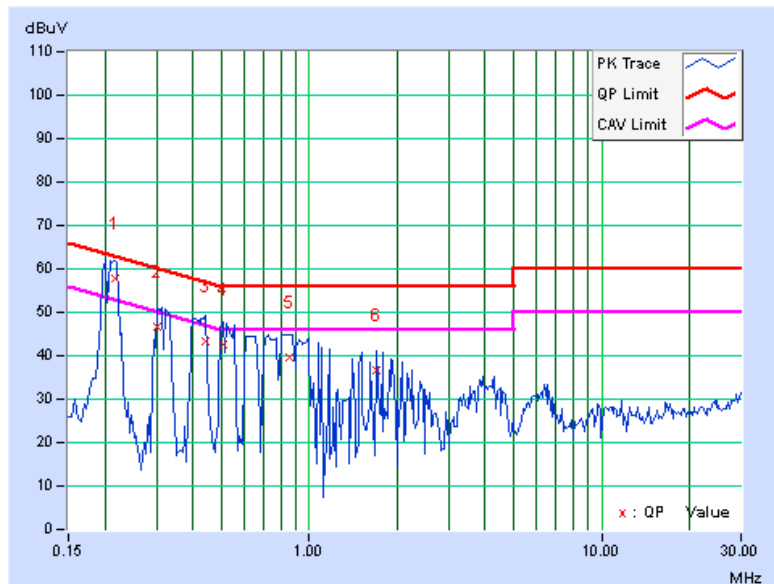



A D T

PHASE	Line 2	6dB BANDWIDTH	9kHz
TEST MODE	A		

No	Freq. [MHz]	Corr. Factor (dB)	Reading Value [dB (uV)]		Emission Level [dB (uV)]		Limit [dB (uV)]		Margin (dB)	
			Q.P.	AV.	Q.P.	AV.	Q.P.	AV.	Q.P.	AV.
1	0.201	0.17	56.27	39.00	56.44	39.17	63.58	53.58	-7.14	-14.41
2	0.306	0.18	44.66	27.99	44.84	28.17	60.07	50.07	-15.23	-21.90
3	0.416	0.19	42.03	27.49	42.22	27.68	57.54	47.54	-15.31	-19.85
4	0.521	0.19	41.74	24.11	41.93	24.30	56.00	46.00	-14.07	-21.70
5	0.814	0.20	39.42	19.51	39.62	19.71	56.00	46.00	-16.38	-26.29
6	1.199	0.21	38.81	21.13	39.02	21.34	56.00	46.00	-16.98	-24.66

- REMARKS:**
1. Q.P. and AV. are abbreviations of quasi-peak and average individually.
 2. "-": The Quasi-peak reading value also meets average limit and measurement with the average detector is unnecessary.
 3. The emission levels of other frequencies were very low against the limit.
 4. Margin value = Emission level - Limit value
 5. Correction factor = Insertion loss + Cable loss
 6. Emission Level = Correction Factor + Reading Value.

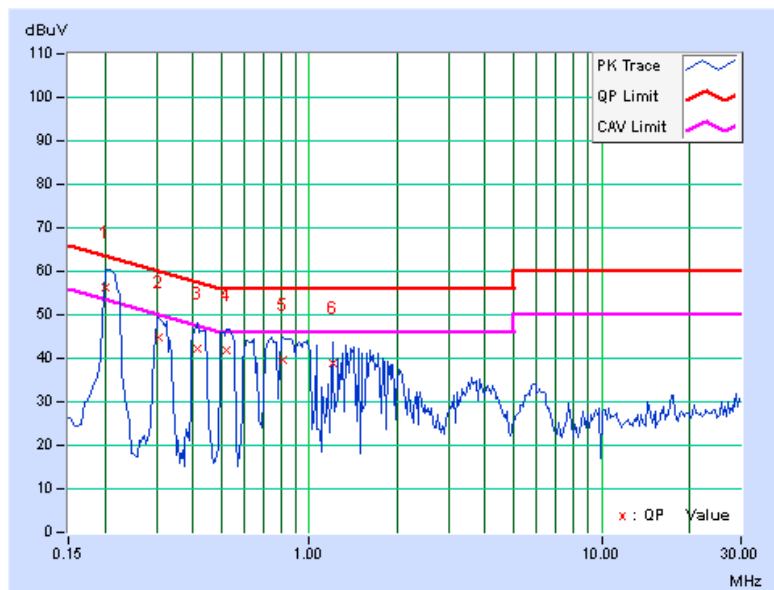

PHASE	Line 1	6dB BANDWIDTH	9kHz
TEST MODE	B		

No	Freq. [MHz]	Corr. Factor (dB)	Reading Value [dB (uV)]		Emission Level [dB (uV)]		Limit [dB (uV)]		Margin (dB)	
			Q.P.	AV.	Q.P.	AV.	Q.P.	AV.	Q.P.	AV.
1	0.158	0.15	51.90	29.19	52.05	29.34	65.58	55.58	-13.53	-26.24
2	0.197	0.15	49.95	33.38	50.10	33.53	63.74	53.74	-13.64	-20.21
3	0.255	0.16	44.24	26.15	44.40	26.31	61.58	51.58	-17.18	-25.27
4	1.688	0.21	17.94	4.78	18.15	4.99	56.00	46.00	-37.85	-41.01
5	5.113	0.36	19.04	6.05	19.40	6.41	60.00	50.00	-40.60	-43.59
6	24.516	1.22	23.20	14.28	24.42	15.50	60.00	50.00	-35.58	-34.50

- REMARKS:**
1. Q.P. and AV. are abbreviations of quasi-peak and average individually.
 2. "-": The Quasi-peak reading value also meets average limit and measurement with the average detector is unnecessary.
 3. The emission levels of other frequencies were very low against the limit.
 4. Margin value = Emission level - Limit value
 5. Correction factor = Insertion loss + Cable loss
 6. Emission Level = Correction Factor + Reading Value.

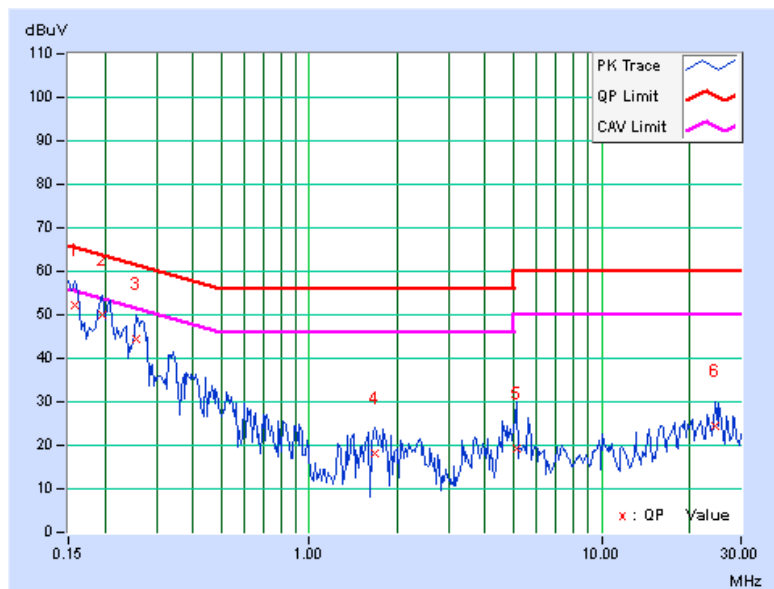

PHASE	Line 2	6dB BANDWIDTH	9kHz
TEST MODE	B		

No	Freq. [MHz]	Corr. Factor (dB)	Reading Value [dB (uV)]		Emission Level [dB (uV)]		Limit [dB (uV)]		Margin (dB)	
			Q.P.	AV.	Q.P.	AV.	Q.P.	AV.	Q.P.	AV.
1	0.150	0.16	50.65	30.49	50.81	30.65	66.00	56.00	-15.19	-25.35
2	0.193	0.17	49.42	33.03	49.59	33.20	63.91	53.91	-14.32	-20.71
3	0.275	0.18	42.31	22.40	42.49	22.58	60.97	50.97	-18.48	-28.39
4	3.914	0.32	15.23	1.75	15.55	2.07	56.00	46.00	-40.45	-43.93
5	5.031	0.35	18.92	5.82	19.27	6.17	60.00	50.00	-40.73	-43.83
6	23.941	1.01	21.91	13.93	22.92	14.94	60.00	50.00	-37.08	-35.06

- REMARKS:**
1. Q.P. and AV. are abbreviations of quasi-peak and average individually.
 2. "-": The Quasi-peak reading value also meets average limit and measurement with the average detector is unnecessary.
 3. The emission levels of other frequencies were very low against the limit.
 4. Margin value = Emission level - Limit value
 5. Correction factor = Insertion loss + Cable loss
 6. Emission Level = Correction Factor + Reading Value.

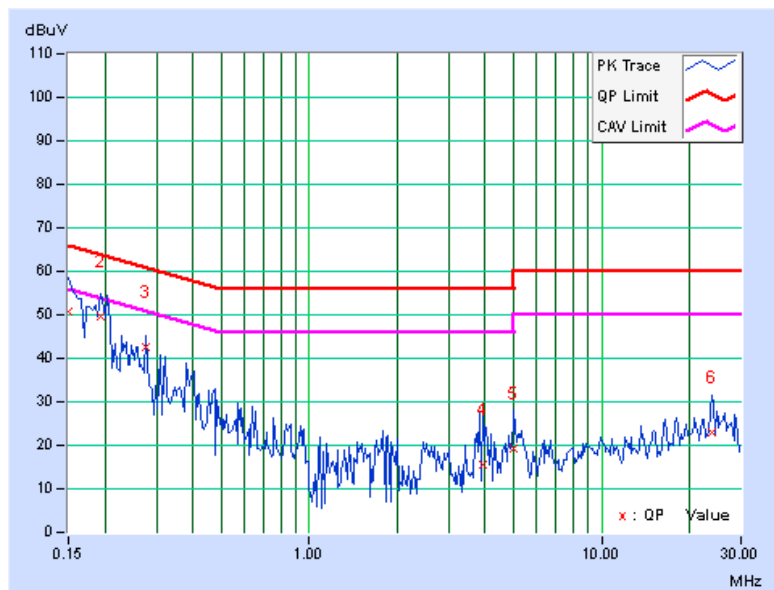

4.3 6dB BANDWIDTH MEASUREMENT

4.3.1 LIMITS OF 6dB BANDWIDTH MEASUREMENT

The minimum of 6dB Bandwidth Measurement is 0.5 MHz.

4.3.2 TEST INSTRUMENTS

DESCRIPTION & MANUFACTURER	MODEL NO.	SERIAL NO.	DATE OF CALIBRATION	DUE DATE OF CALIBRATION
SPECTRUM ANALYZER R&S	FSP40	100039	Jan. 11, 2011	Jan. 10, 2012

NOTE: The calibration interval of the above test instruments is 12 months and the calibrations are traceable to NML/ROC and NIST/USA.

4.3.3 TEST PROCEDURE

The transmitter output was connected to the spectrum analyzer through an attenuator. The bandwidth of the fundamental frequency was measured by spectrum analyzer with 100kHz RBW and 300kHz VBW. The 6dB bandwidth is defined as the total spectrum the power of which is higher than peak power minus 6dB.

4.3.4 DEVIATION FROM TEST STANDARD

No deviation.

4.3.5 TEST SETUP

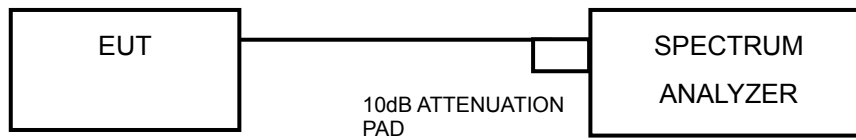

4.3.6 EUT OPERATING CONDITIONS

The software provided by client to enable the EUT under transmission condition continuously at lowest, middle and highest channel frequencies individually.



A D T

4.3.7 TEST RESULTS

802.11b

CHANNEL	CHANNEL FREQUENCY (MHz)	6dB BANDWIDTH (MHz)	MINIMUM LIMIT (MHz)	PASS / FAIL
1	2412	9.13	0.5	PASS
6	2437	9.54	0.5	PASS
11	2462	9.11	0.5	PASS

CH 6

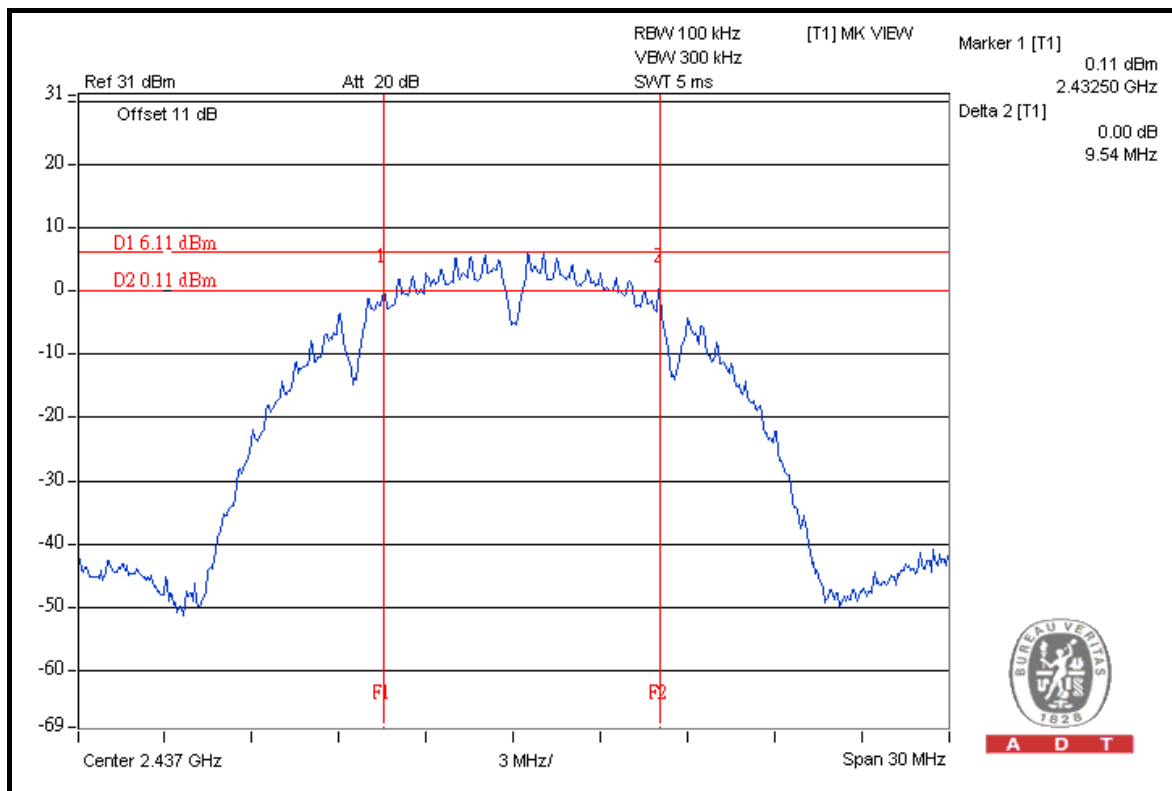



A D T

802.11g

CHANNEL	CHANNEL FREQUENCY (MHz)	6dB BANDWIDTH (MHz)	MINIMUM LIMIT (MHz)	PASS / FAIL
1	2412	15.17	0.5	PASS
6	2437	15.19	0.5	PASS
11	2462	15.17	0.5	PASS

CH 6

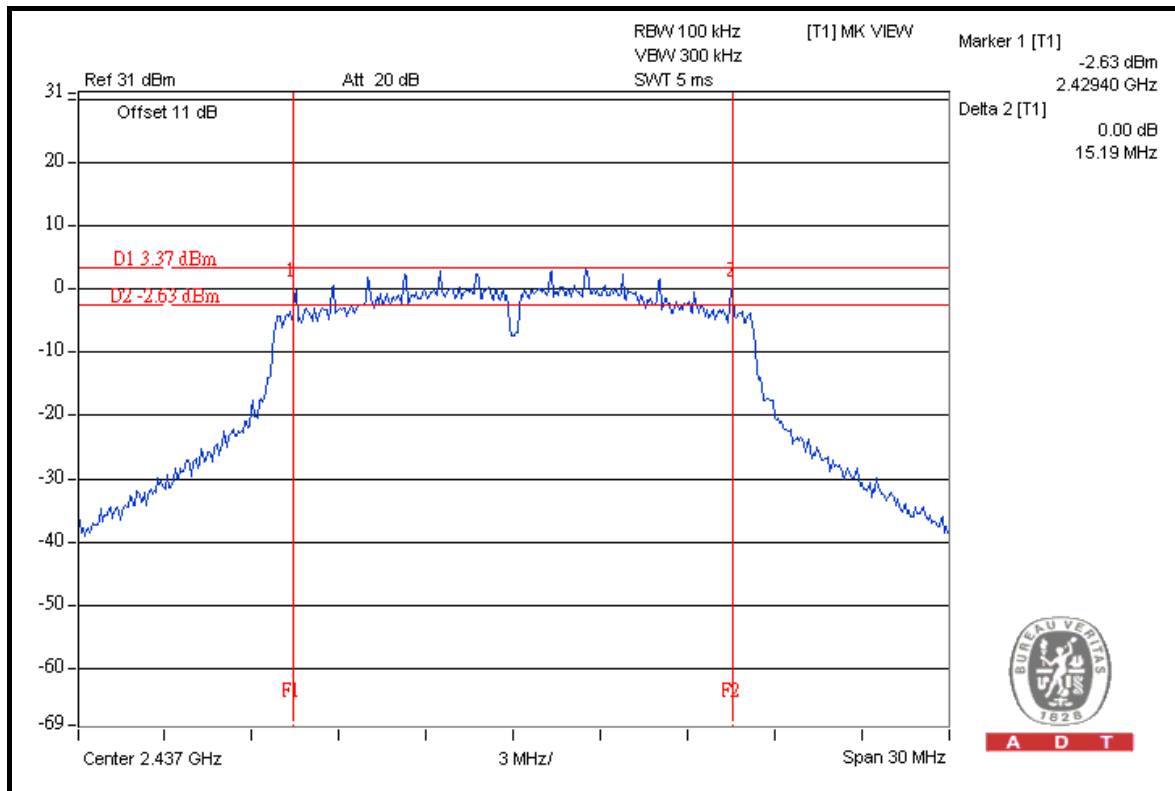



A D T

802.11n (20MHz)

CHANNEL	CHANNEL FREQUENCY (MHz)	6dB BANDWIDTH (MHz)	MINIMUM LIMIT (MHz)	PASS / FAIL
1	2412	15.17	0.5	PASS
6	2437	15.40	0.5	PASS
11	2462	15.17	0.5	PASS

CH 6

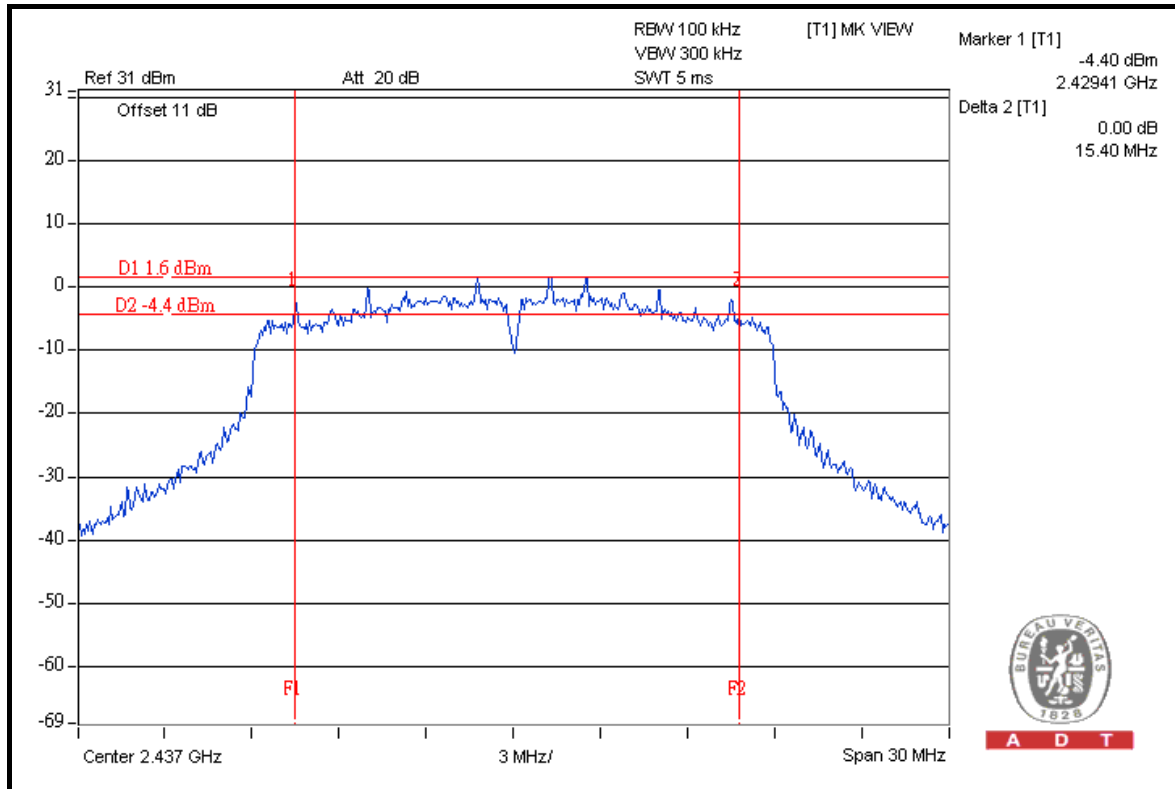

A D T



A D T

4.4 MAXIMUM OUTPUT POWER

4.4.1 LIMITS OF MAXIMUM OUTPUT POWER MEASUREMENT

The Maximum Output Power Measurement is 30dBm.

4.4.2 INSTRUMENTS

DESCRIPTION & MANUFACTURER	MODEL NO.	SERIAL NO.	DATE OF CALIBRATION	DUE DATE OF CALIBRATION
High Speed Peak Power Meter	ML2495A	0824011	Aug. 04, 2011	Aug. 03, 2012
Power Sensor	MA2411B	0738171	Aug. 04, 2011	Aug. 03, 2012

NOTE:

1. The calibration interval of the above test instruments is 12 months and the calibrations are traceable to NML/ROC and NIST/USA.
2. Measurement Bandwidth of ML2495A is 65MHz greater than 6dB bandwidth of emission.

4.4.3 TEST PROCEDURE

A power sensor was used on the output port of the EUT. A power meter was used to read the response of the power sensor. Record the power level.

4.4.4 DEVIATION FROM TEST STANDARD

No deviation.

4.4.5 TEST SETUP

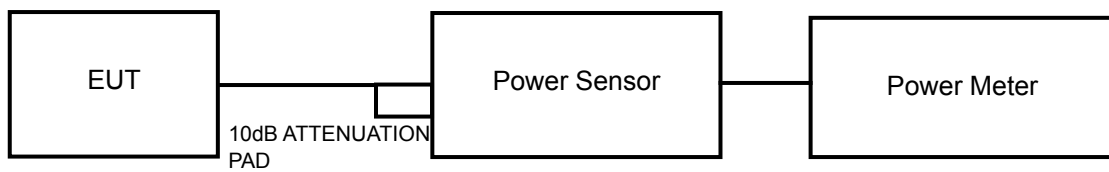

4.4.6 EUT OPERATING CONDITIONS

Same as Item 4.3.6.



4.4.7 TEST RESULTS

802.11b

CHANNEL	CHANNEL FREQUENCY (MHz)	POWER OUTPUT (mW)	POWER OUTPUT (dBm)	POWER LIMIT (dBm)	PASS/FAIL
1	2412	52.5	17.2	30	PASS
6	2437	53.7	17.3	30	PASS
11	2462	56.2	17.5	30	PASS

802.11g

CHANNEL	CHANNEL FREQUENCY (MHz)	POWER OUTPUT (mW)	POWER OUTPUT (dBm)	POWER LIMIT (dBm)	PASS/FAIL
1	2412	229.1	23.6	30	PASS
6	2437	239.9	23.8	30	PASS
11	2462	245.5	23.9	30	PASS

802.11n (20MHz)

CHANNEL	CHANNEL FREQUENCY (MHz)	POWER OUTPUT (mW)	POWER OUTPUT (dBm)	POWER LIMIT (dBm)	PASS/FAIL
1	2412	138.0	21.4	30	PASS
6	2437	144.5	21.6	30	PASS
11	2462	154.9	21.9	30	PASS



A D T

4.5 POWER SPECTRAL DENSITY MEASUREMENT

4.5.1 LIMITS OF POWER SPECTRAL DENSITY MEASUREMENT

The Maximum of Power Spectral Density Measurement is 8dBm.

4.5.2 TEST INSTRUMENTS

DESCRIPTION & MANUFACTURER	MODEL NO.	SERIAL NO.	DATE OF CALIBRATION	DUE DATE OF CALIBRATION
SPECTRUM ANALYZER R&S	FSP40	100039	Jan. 11, 2011	Jan. 10, 2012

NOTE: The calibration interval of the above test instruments is 12 months and the calibrations are traceable to NML/ROC and NIST/USA.

4.5.3 TEST PROCEDURE

The transmitter output was connected to the spectrum analyzer through an attenuator, the bandwidth of the fundamental frequency was measured with the spectrum analyzer using 3kHz RBW and 10kHz VBW, set sweep time = span/3kHz. The power spectral density was measured and recorded.

The sweep time is allowed to be longer than span/3kHz for a full response of the mixer in the spectrum analyzer.

4.5.4 DEVIATION FROM TEST STANDARD

No deviation.

4.5.5 TEST SETUP

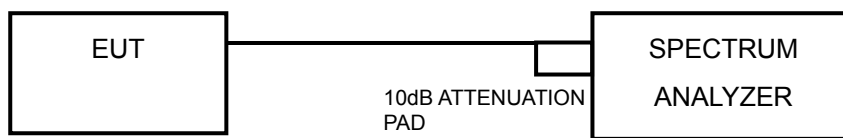

4.5.6 EUT OPERATING CONDITION

Same as Item 4.3.6.



A D T

4.5.7 TEST RESULTS

802.11b

CHANNEL	CHANNEL FREQUENCY (MHz)	RF POWER LEVEL IN 3 kHz BW (dBm)	MAXIMUM LIMIT (dBm)	PASS/FAIL
1	2412	-7.3	8	PASS
6	2437	-7.1	8	PASS
11	2462	-6.8	8	PASS

CH 6

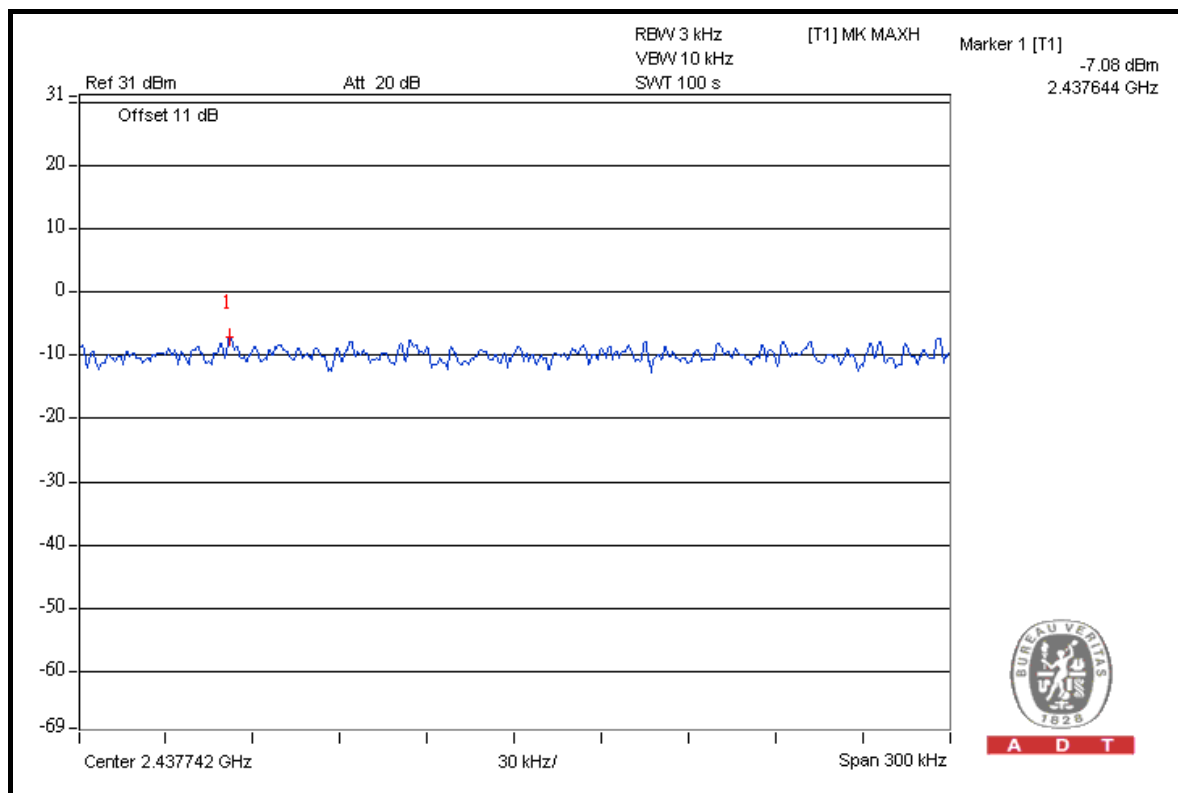



A D T

802.11g

CHANNEL	CHANNEL FREQUENCY (MHz)	RF POWER LEVEL IN 3 kHz BW (dBm)	MAXIMUM LIMIT (dBm)	PASS/FAIL
1	2412	-10.5	8	PASS
6	2437	-10.4	8	PASS
11	2462	-10.4	8	PASS

CH 11

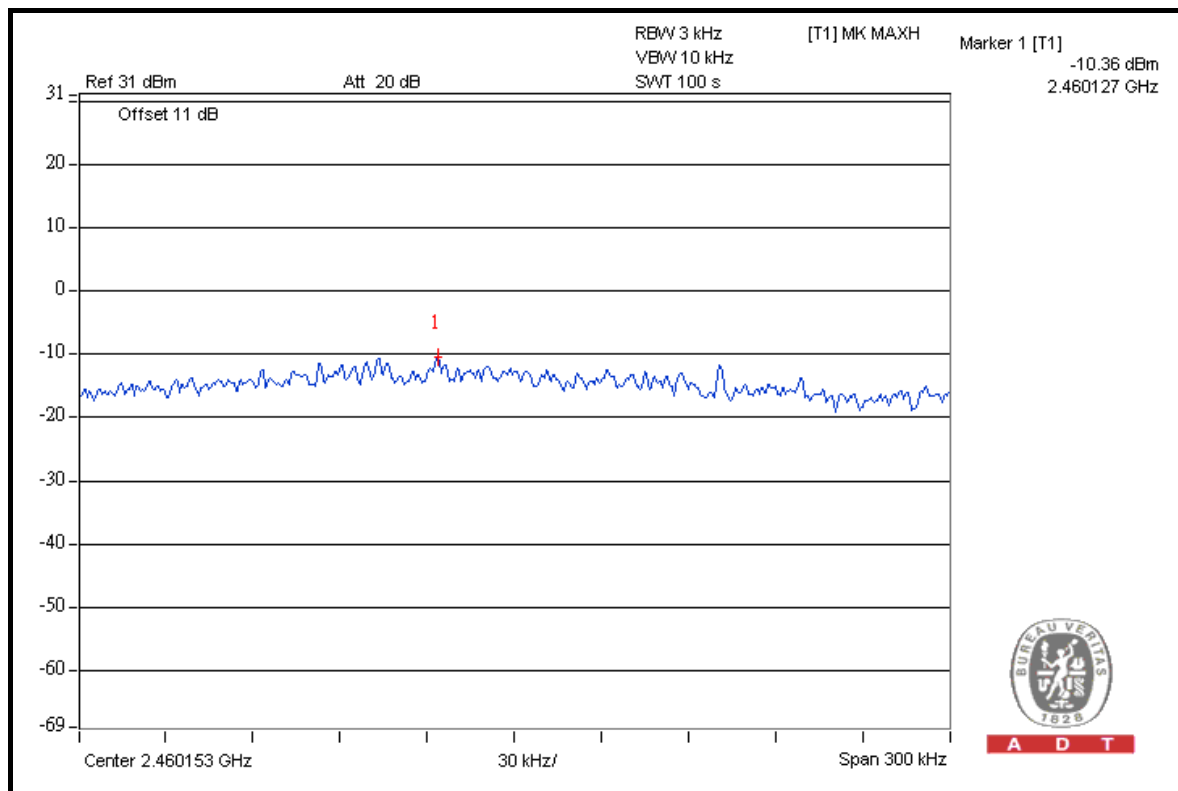

A D T



A D T

802.11n (20MHz)

CHANNEL	CHANNEL FREQUENCY (MHz)	RF POWER LEVEL IN 3 kHz BW (dBm)	MAXIMUM LIMIT (dBm)	PASS/FAIL
1	2412	-13.7	8	PASS
6	2437	-13.1	8	PASS
11	2462	-13.4	8	PASS

CH 6

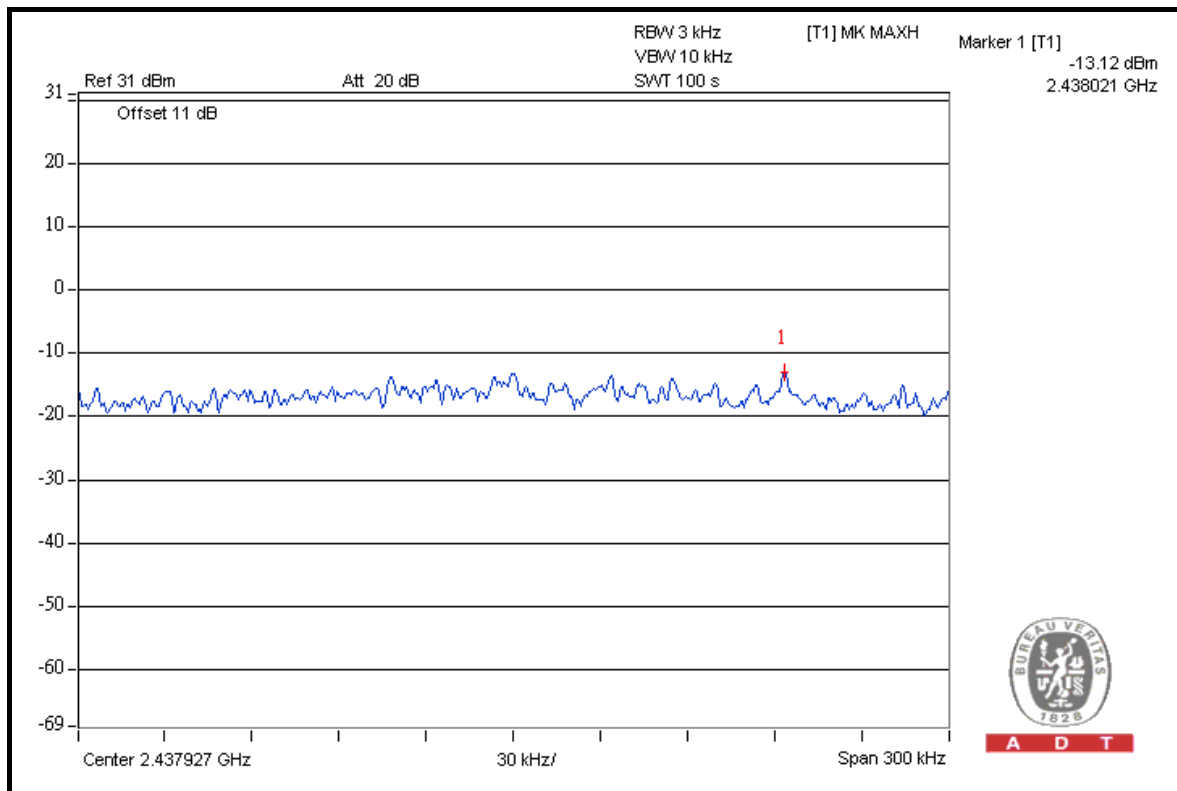

A D T



A D T

4.6 BAND EDGES MEASUREMENT

4.6.1 LIMITS OF BAND EDGES MEASUREMENT

Below -20 dB of the highest emission level of operating band (in 100kHz Resolution Bandwidth).

Note: Follow DTS measurement, If the device complies with the use of power option 2 the attenuation under this paragraph shall be 30 dB instead of 20 dB.

4.6.2 TEST INSTRUMENTS

DESCRIPTION & MANUFACTURER	MODEL NO.	SERIAL NO.	DATE OF CALIBRATION	DUE DATE OF CALIBRATION
SPECTRUM ANALYZER R&S	FSP40	100039	Jan. 11, 2011	Jan. 10, 2012

NOTE: The calibration interval of the above test instruments is 12 months and the calibrations are traceable to NML/ROC and NIST/USA.

4.6.3 TEST PROCEDURE

The transmitter output was connected to the spectrum analyzer via a low loss cable. Set both RBW and VBW of spectrum analyzer to 100kHz and 300kHz with suitable frequency span including 100MHz bandwidth from band edge. The band edges was measured and recorded.

The spectrum plots (Peak RBW = 100kHz, VBW = 300kHz; Average RBW = 1MHz, VBW = 10Hz) are attached on the following pages.

4.6.4 DEVIATION FROM TEST STANDARD

No deviation.

4.6.5 EUT OPERATING CONDITION

Same as Item 4.3.6.



A D T

4.6.6 TEST RESULTS

The spectrum plots are attached on the following pages. D1 line indicates the highest level, and D2 line indicates the 20dB offset below D1. It shows compliance with the requirement in part 15.247(d).

802.11b

RESTRICT BAND (2310 ~ 2390 MHz)

FREQUENCY (MHz)	FUNDAMENTAL EMISSION (dBuV/m)	DELTA (dB)	MAXIMUM FIELD STRENGTH IN RESTRICT BAND (dBuV/m)	LIMIT (dBuV/m)
2412.00 (PK)	109.9	52.49	57.41	74.00
2412.00 (AV)	101.5	52.08	49.42	54.00

RESTRICT BAND (2483.5 ~ 2500 MHz)

FREQUENCY (MHz)	FUNDAMENTAL EMISSION (dBuV/m)	DELTA (dB)	MAXIMUM FIELD STRENGTH IN RESTRICT BAND (dBuV/m)	LIMIT (dBuV/m)
2462.00 (PK)	111.2	52.67	58.53	74.00
2462.00 (AV)	102.7	52.65	50.05	54.00

NOTE:

1. Delta = Amplitude between the peak of the fundamental and the peak of the band edge emission. Please check following 3 pages.
2. Maximum field strength in restrict band = Fundamental emission – Delta.



A D T

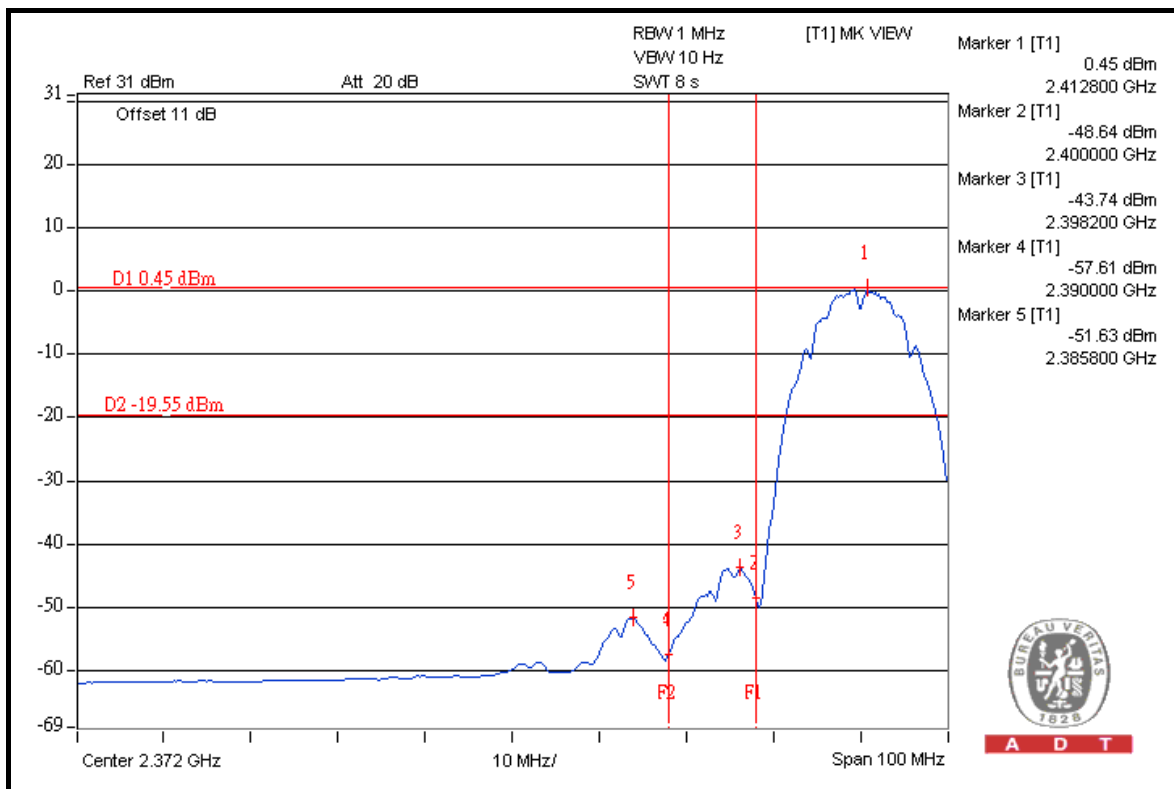
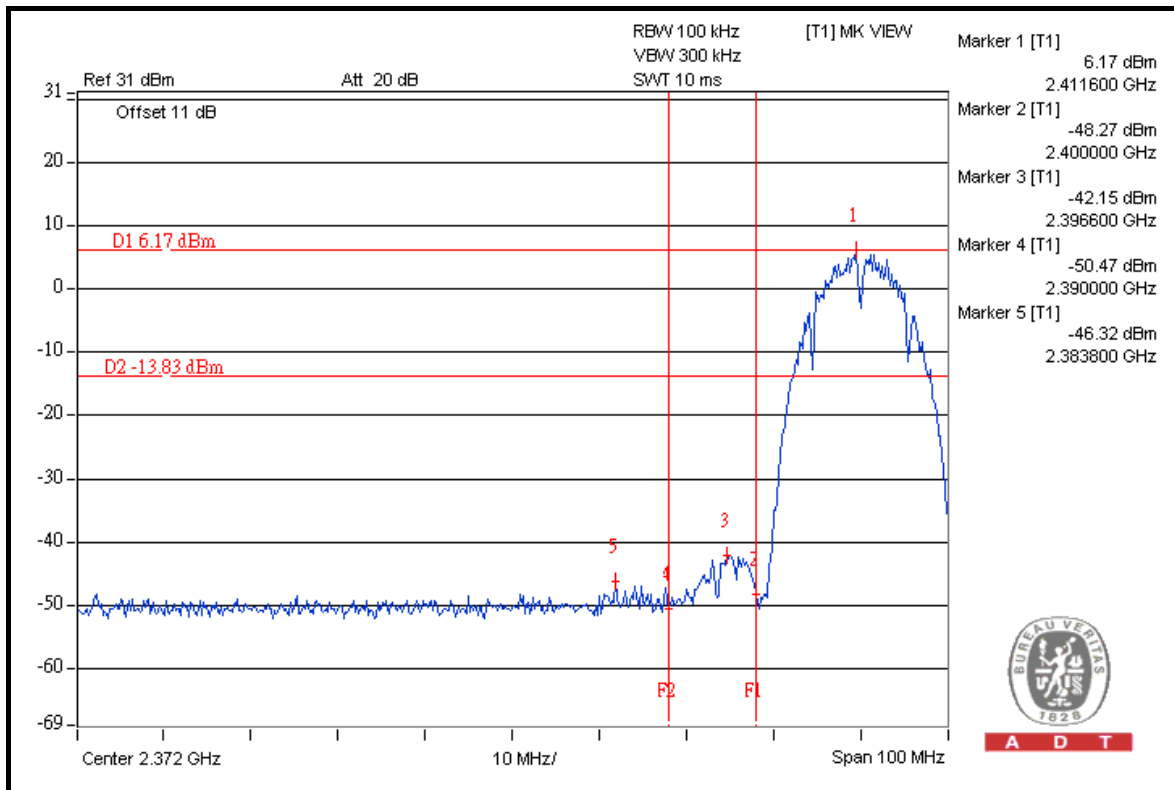



A D T

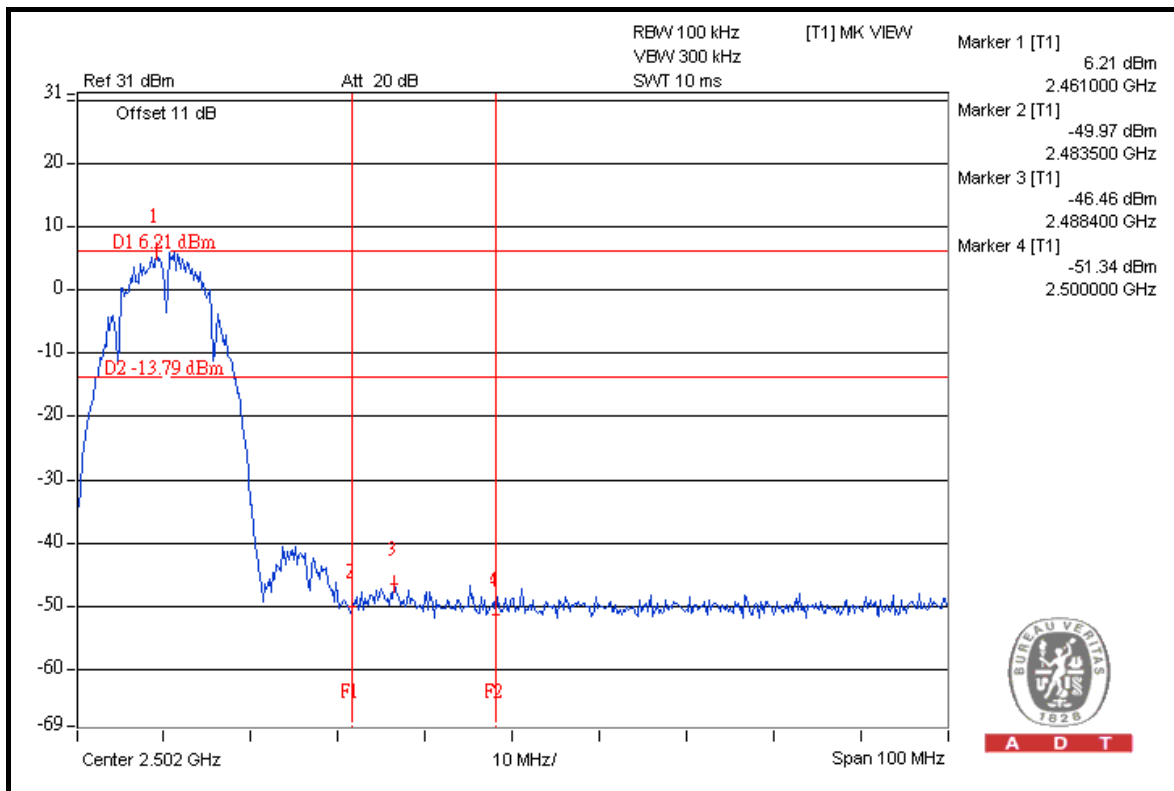
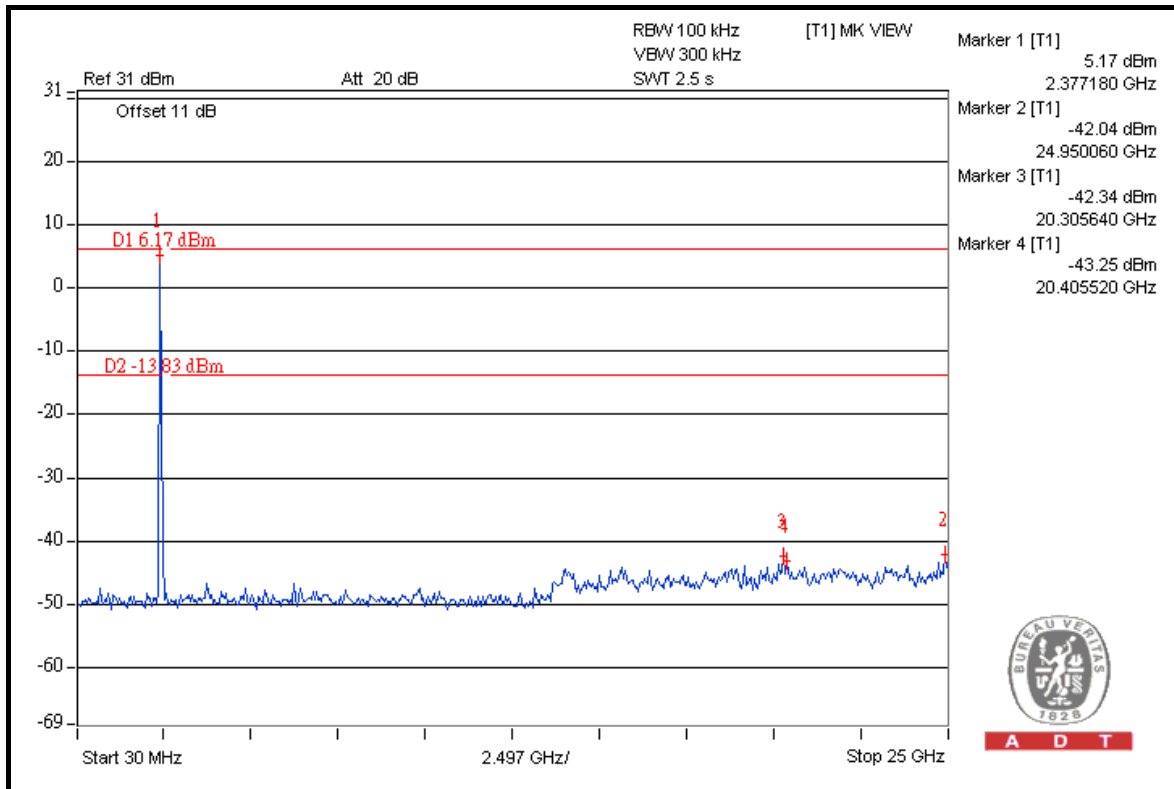



A D T

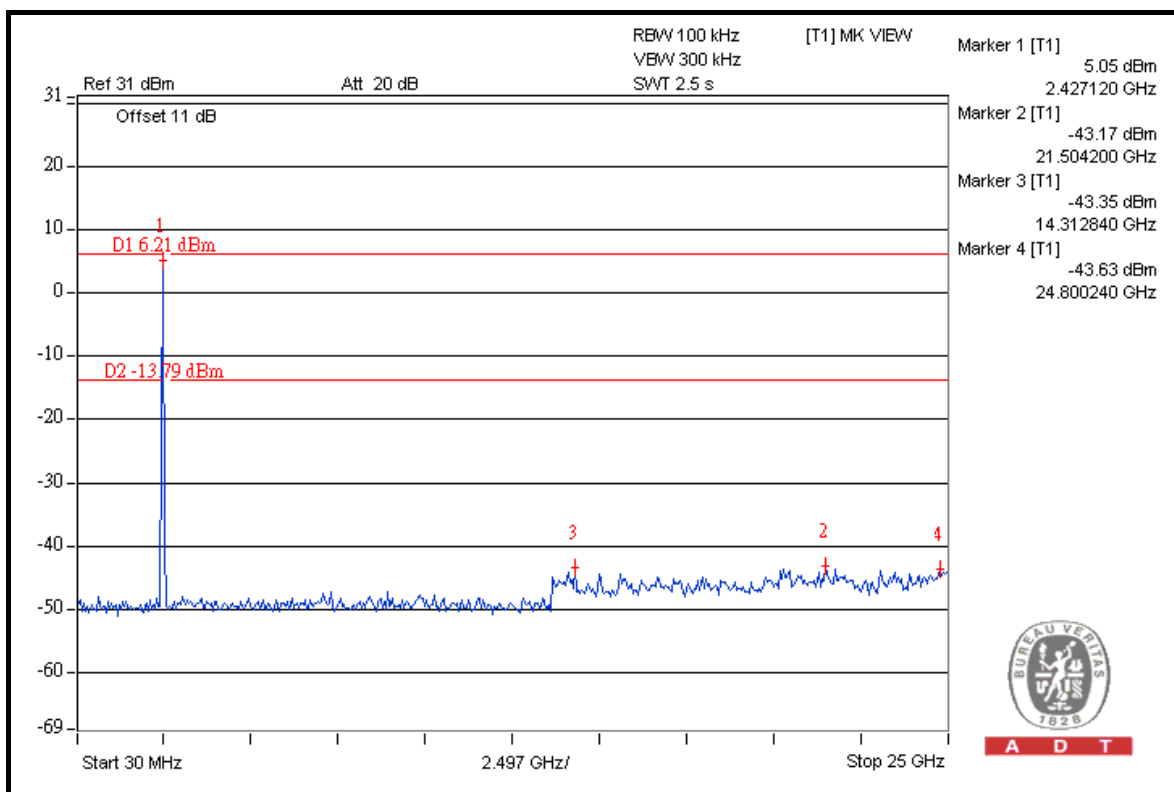
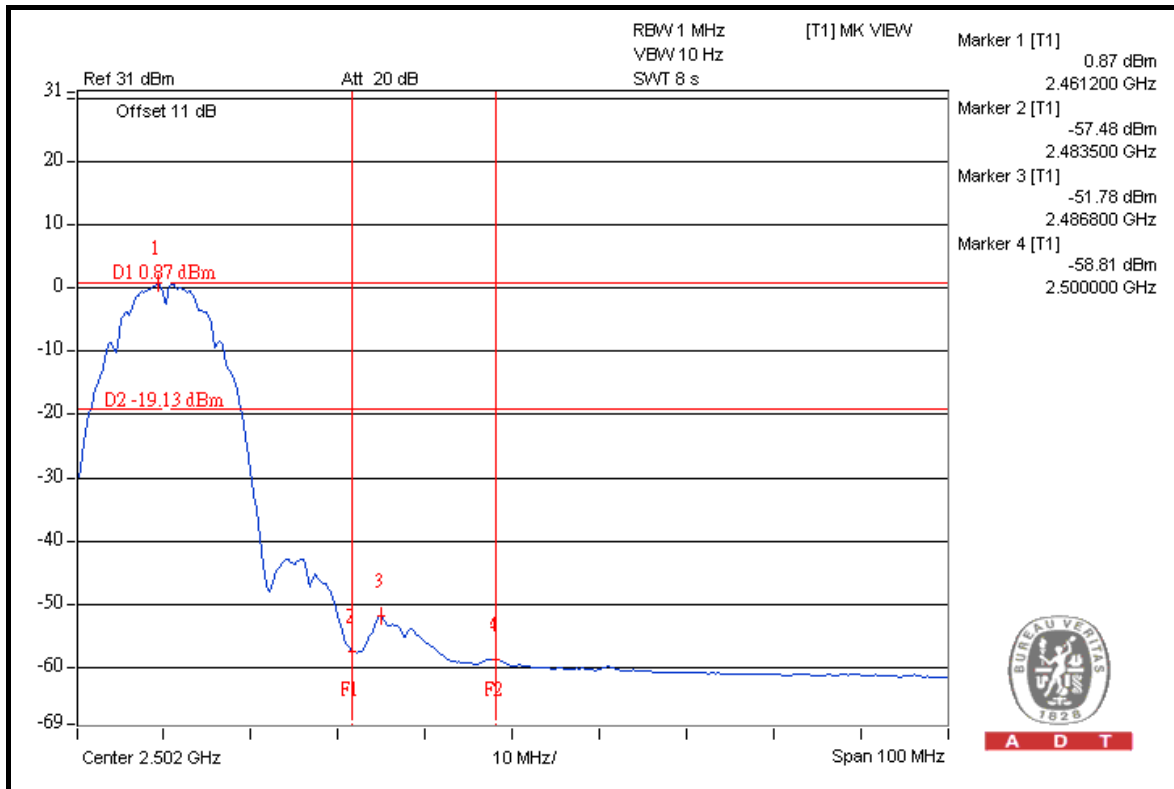



A D T

802.11g

RESTRICT BAND (2310 ~ 2390 MHz)

FREQUENCY (MHz)	FUNDAMENTAL EMISSION (dBuV/m)	DELTA (dB)	MAXIMUM FIELD STRENGTH IN RESTRICT BAND (dBuV/m)	LIMIT (dBuV/m)
2412.00 (PK)	111.4	50.18	61.22	74.00
2412.00 (AV)	99.5	53.16	46.34	54.00

RESTRICT BAND (2483.5 ~ 2500 MHz)

FREQUENCY (MHz)	FUNDAMENTAL EMISSION (dBuV/m)	DELTA (dB)	MAXIMUM FIELD STRENGTH IN RESTRICT BAND (dBuV/m)	LIMIT (dBuV/m)
2462.00 (PK)	111.9	50.62	61.28	74.00
2462.00 (AV)	101.0	51.98	49.02	54.00

NOTE:

1. Delta = Amplitude between the peak of the fundamental and the peak of the band edge emission. Please check following 3 pages.
2. Maximum field strength in restrict band = Fundamental emission – Delta.



A D T

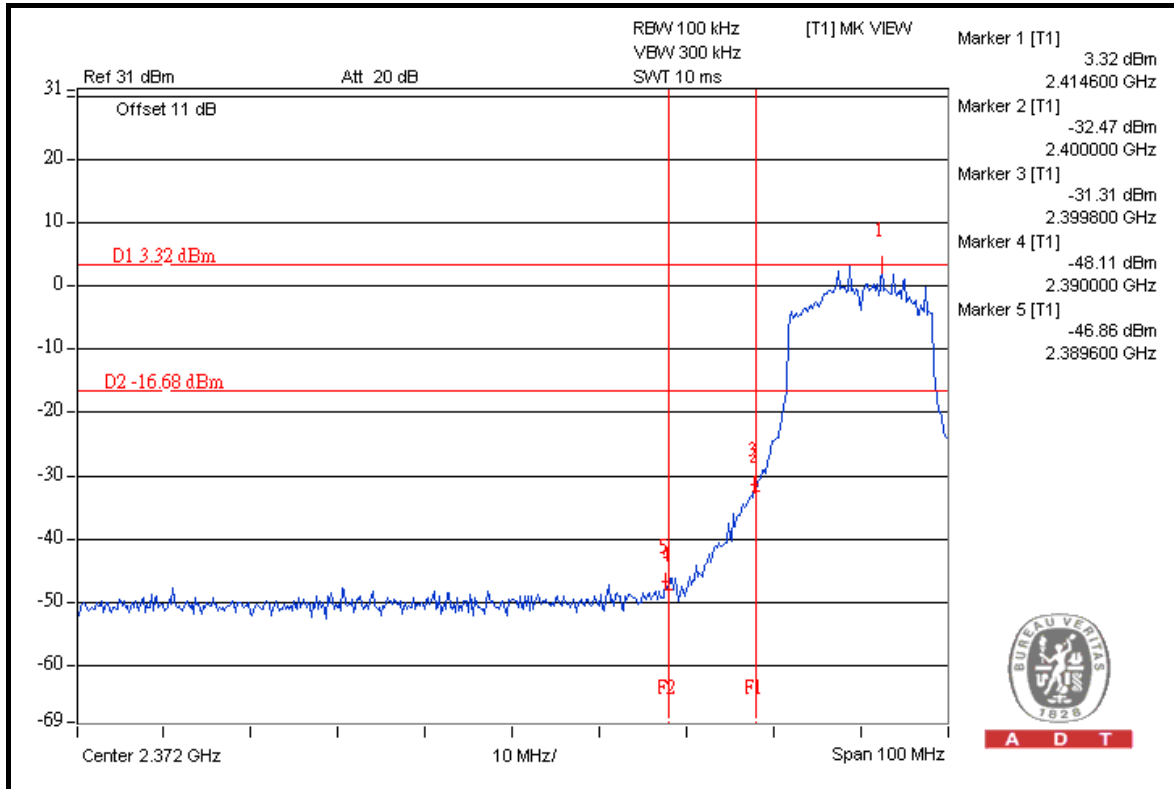

A D T

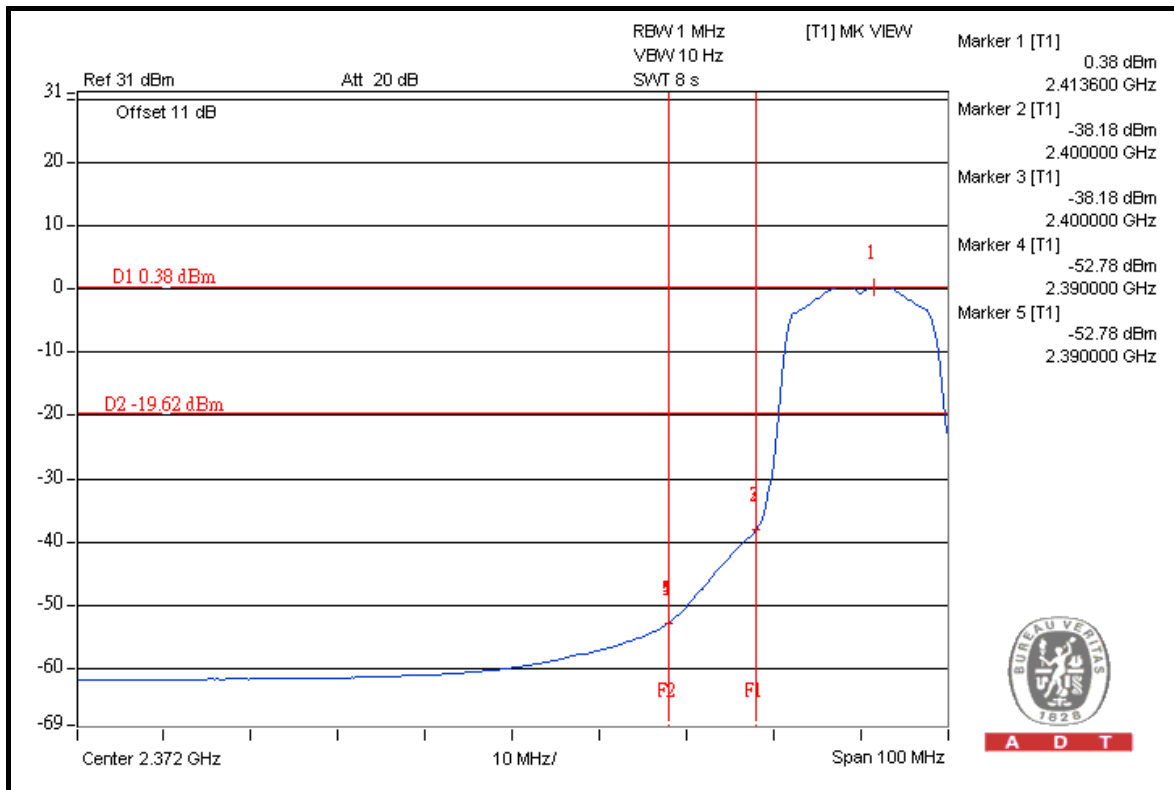

A D T



A D T

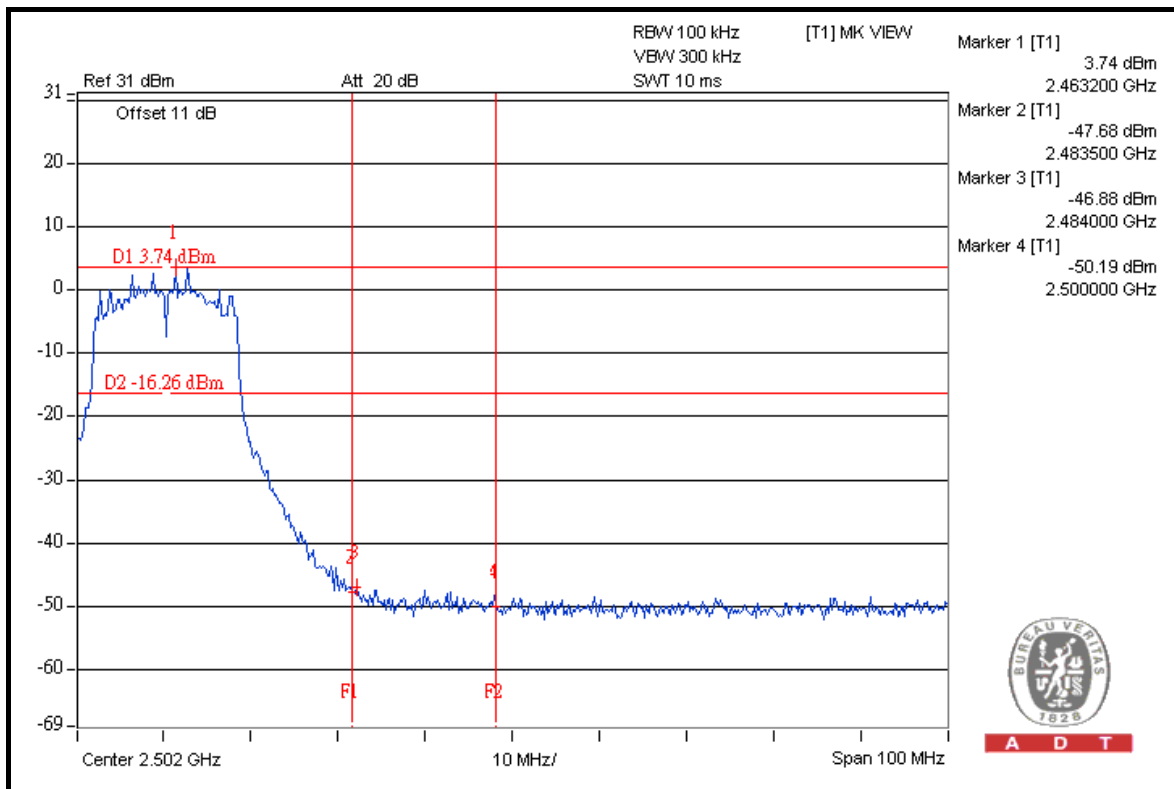
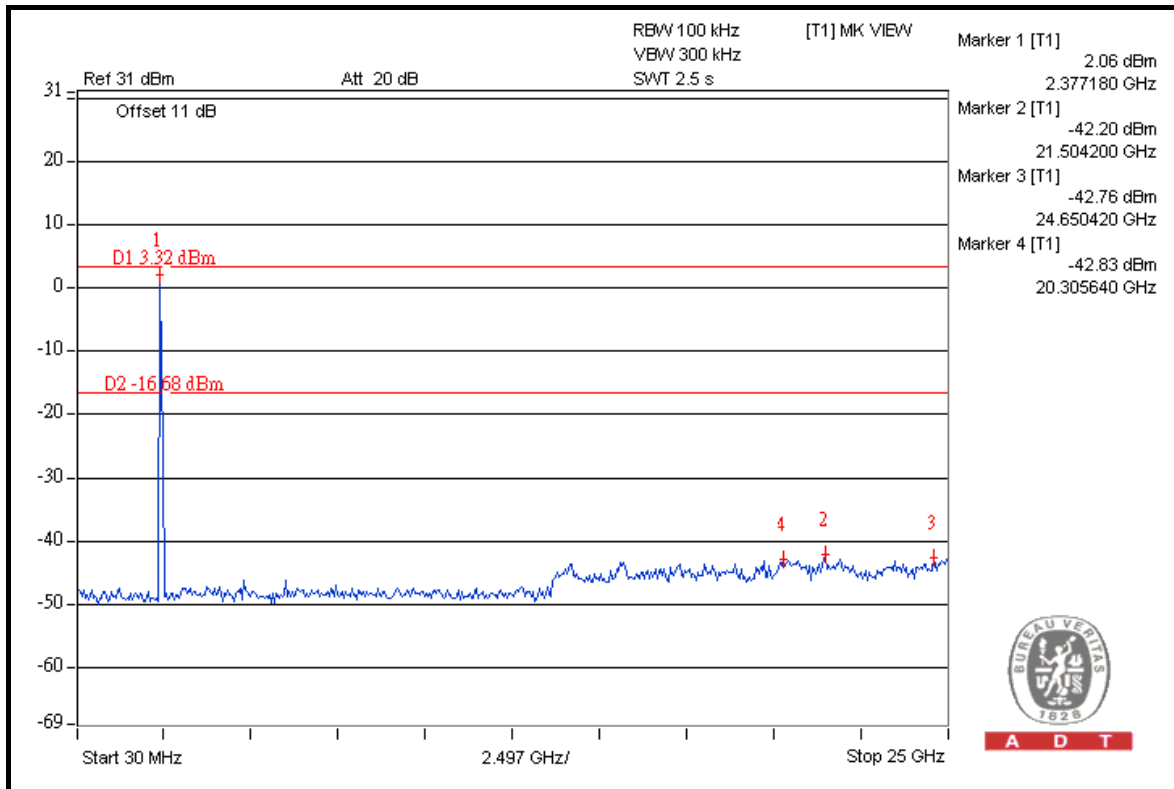



A D T

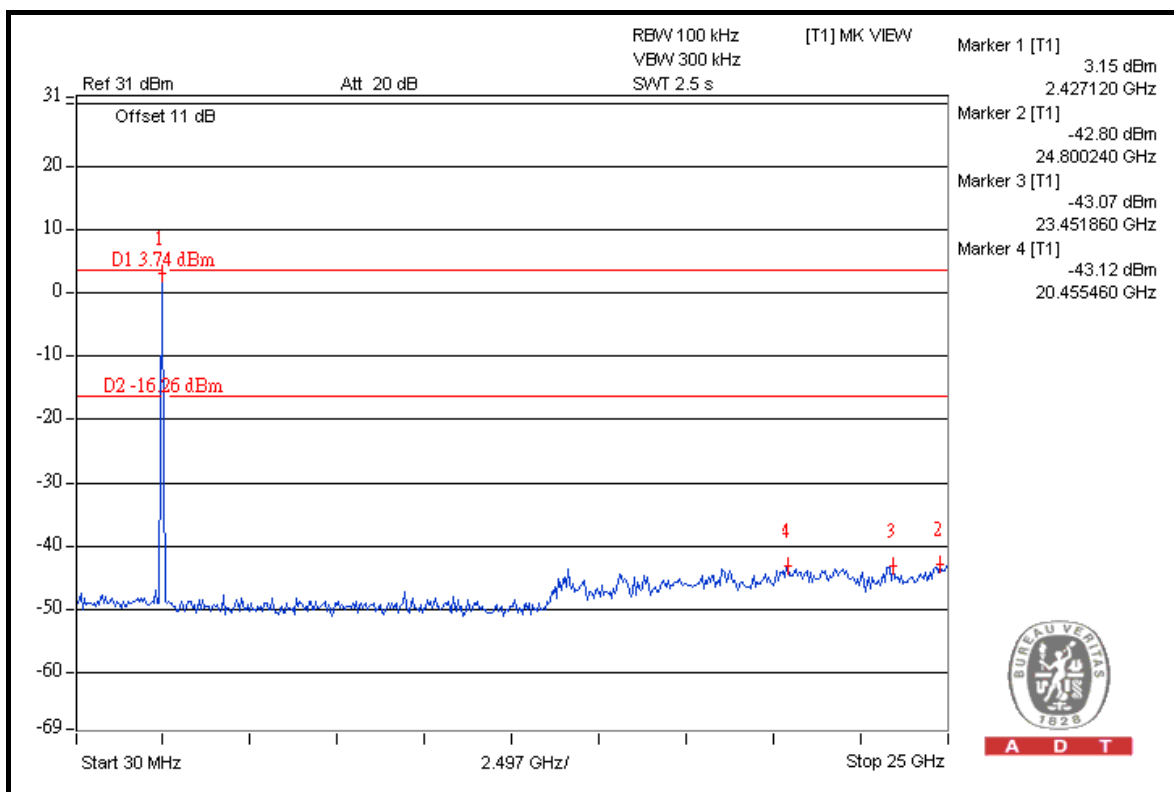
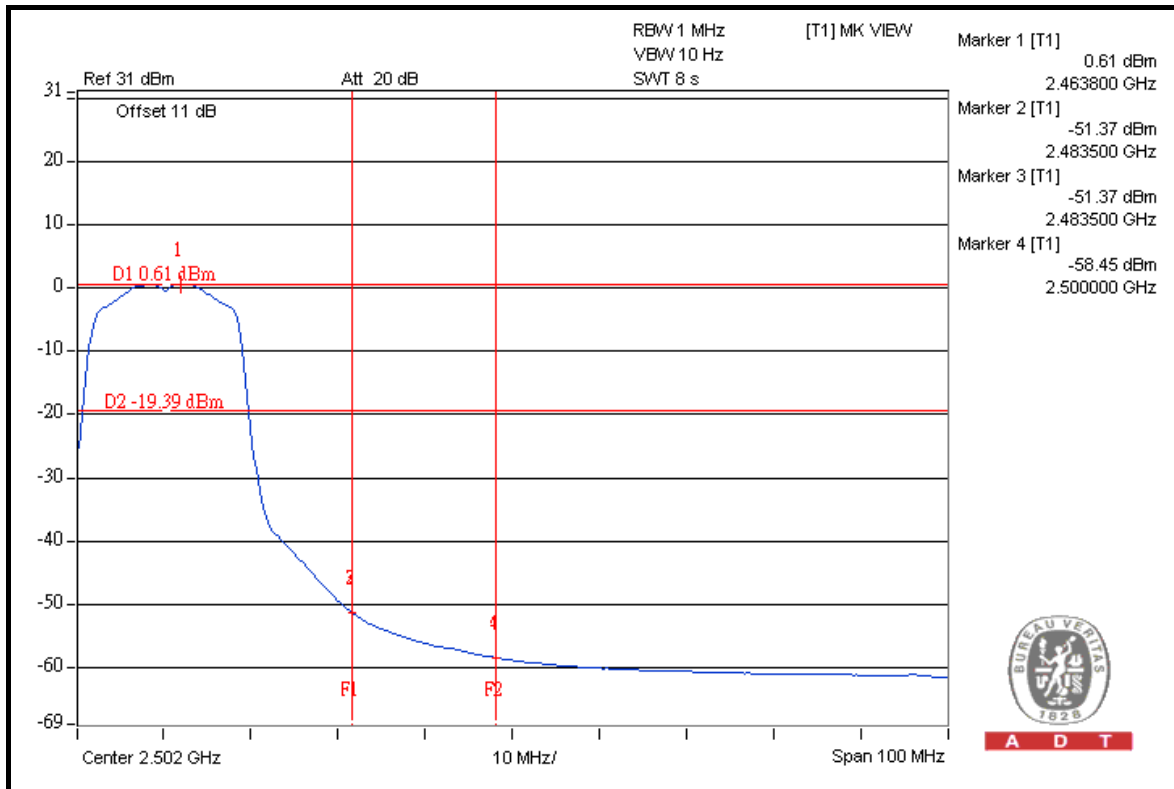



A D T

802.11n (20MHz)

RESTRICT BAND (2310 ~ 2390 MHz)

FREQUENCY (MHz)	FUNDAMENTAL EMISSION (dBuV/m)	DELTA (dB)	MAXIMUM FIELD STRENGTH IN RESTRICT BAND (dBuV/m)	LIMIT (dBuV/m)
2412.00 (PK)	109.5	47.05	62.45	74.00
2412.00 (AV)	97.2	51.61	45.59	54.00

RESTRICT BAND (2483.5 ~ 2500 MHz)

FREQUENCY (MHz)	FUNDAMENTAL EMISSION (dBuV/m)	DELTA (dB)	MAXIMUM FIELD STRENGTH IN RESTRICT BAND (dBuV/m)	LIMIT (dBuV/m)
2462.00 (PK)	111.5	47.78	63.72	74.00
2462.00 (AV)	98.8	50.50	48.30	54.00

NOTE:

1. Delta = Amplitude between the peak of the fundamental and the peak of the band edge emission. Please check following 3 pages.
2. Maximum field strength in restrict band = Fundamental emission – Delta.



A D T

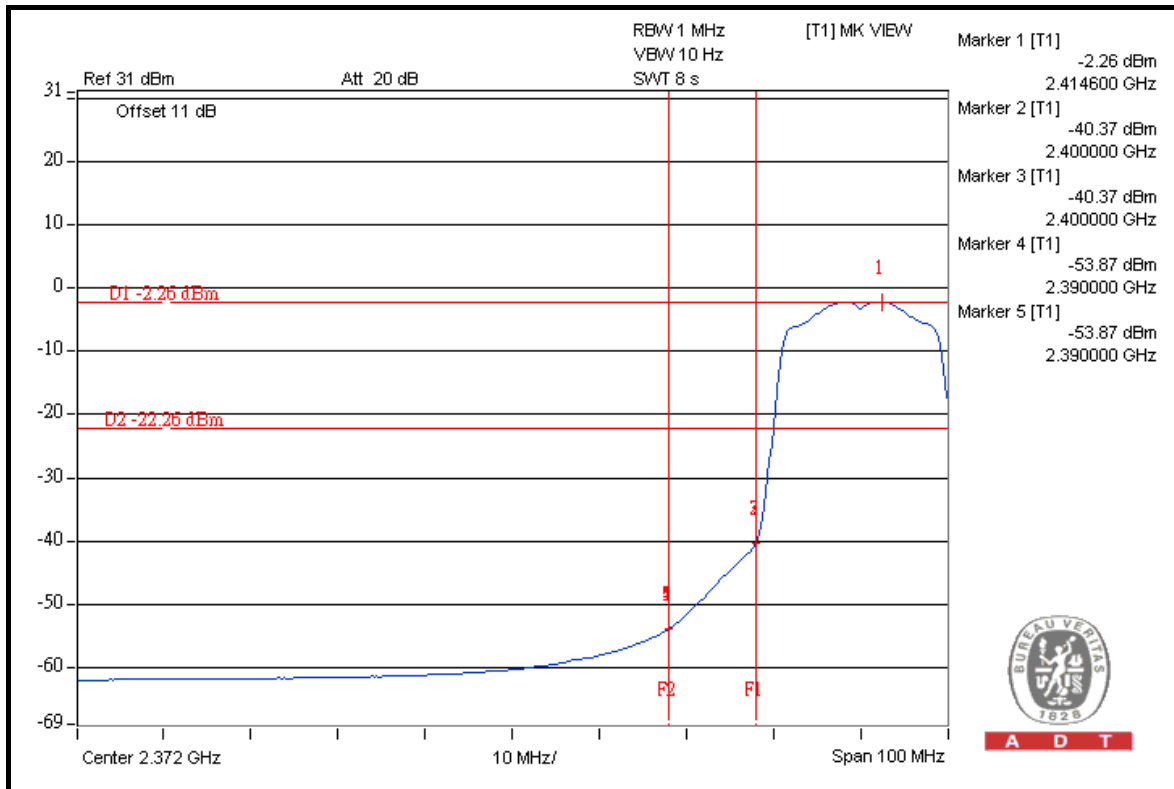
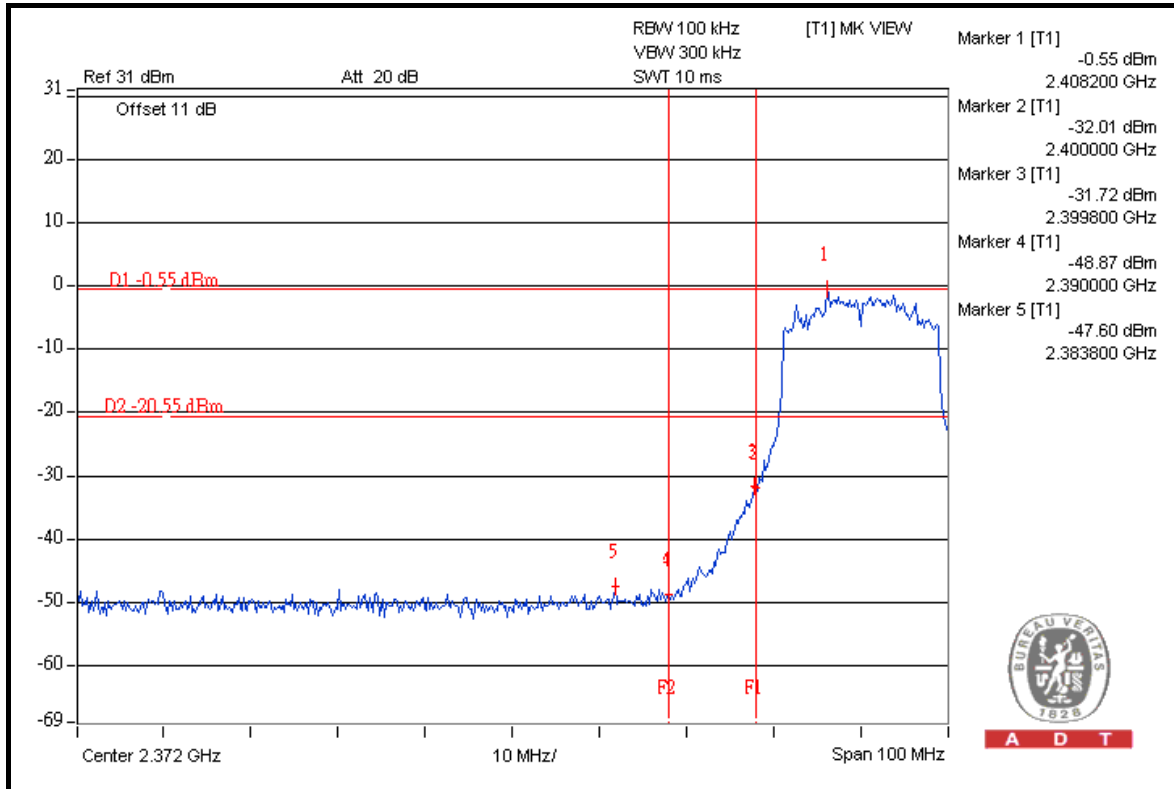



A D T

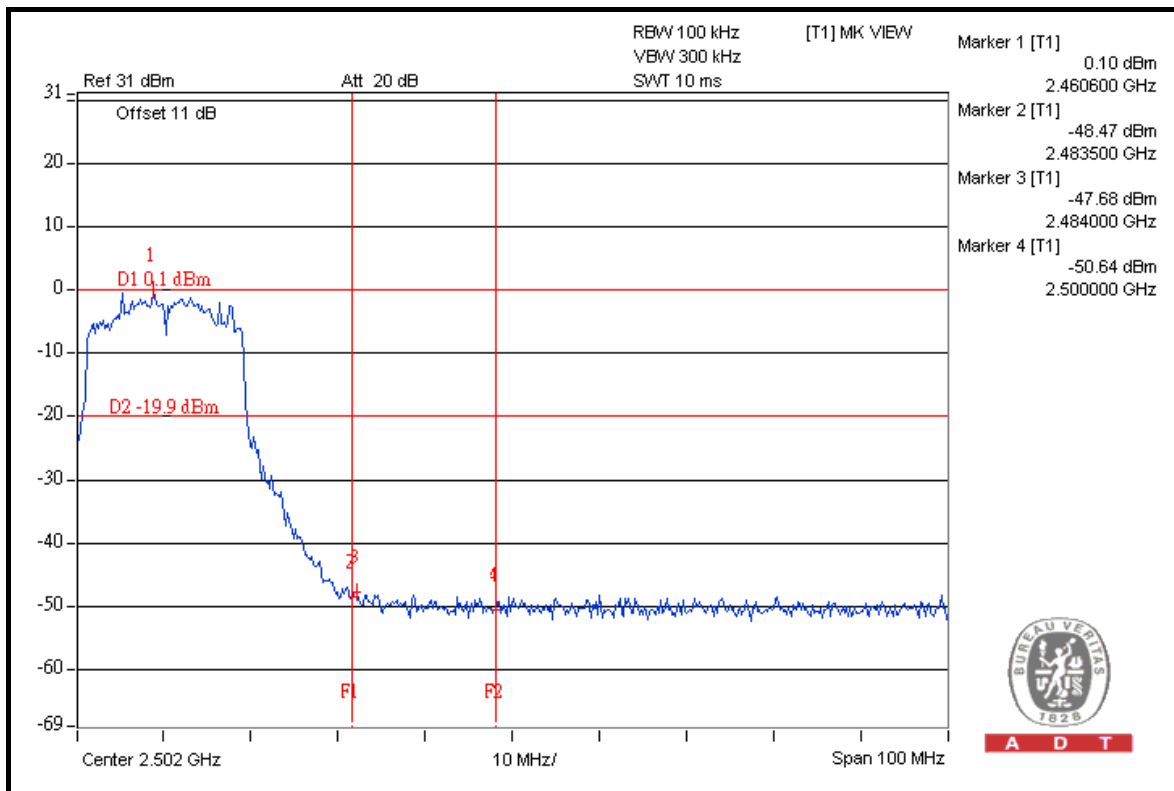
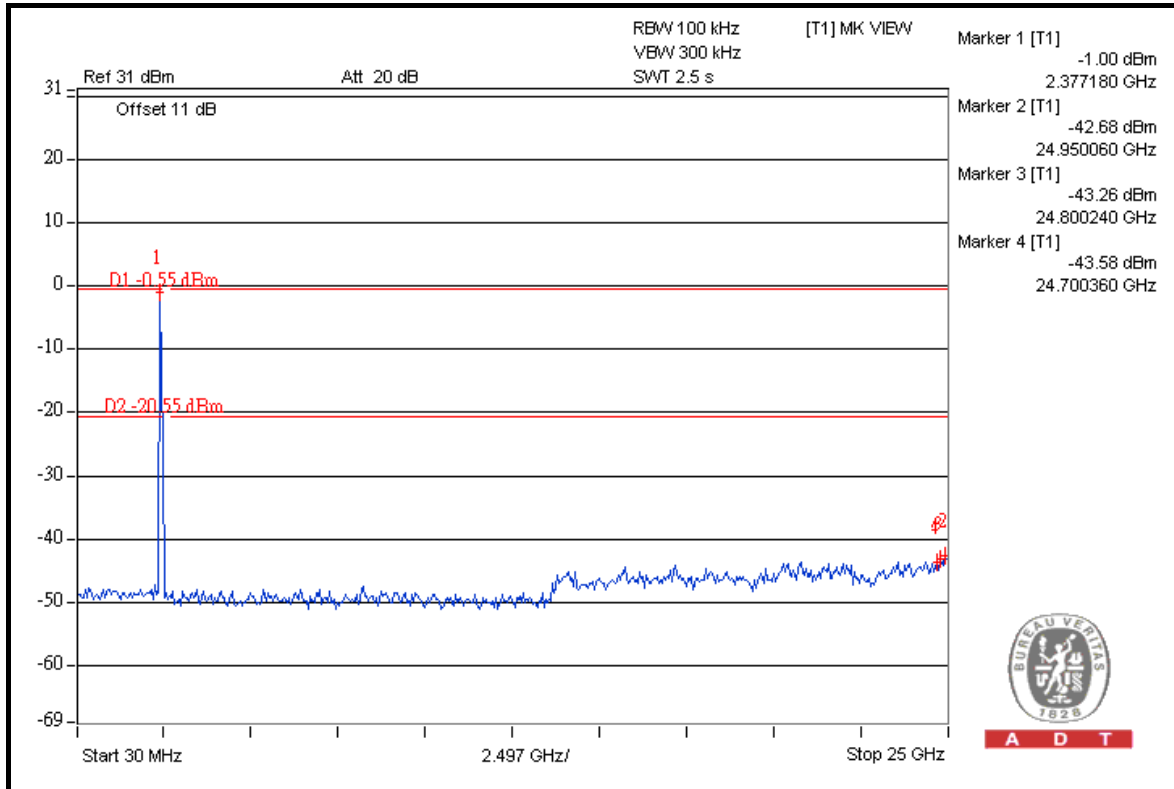



A D T

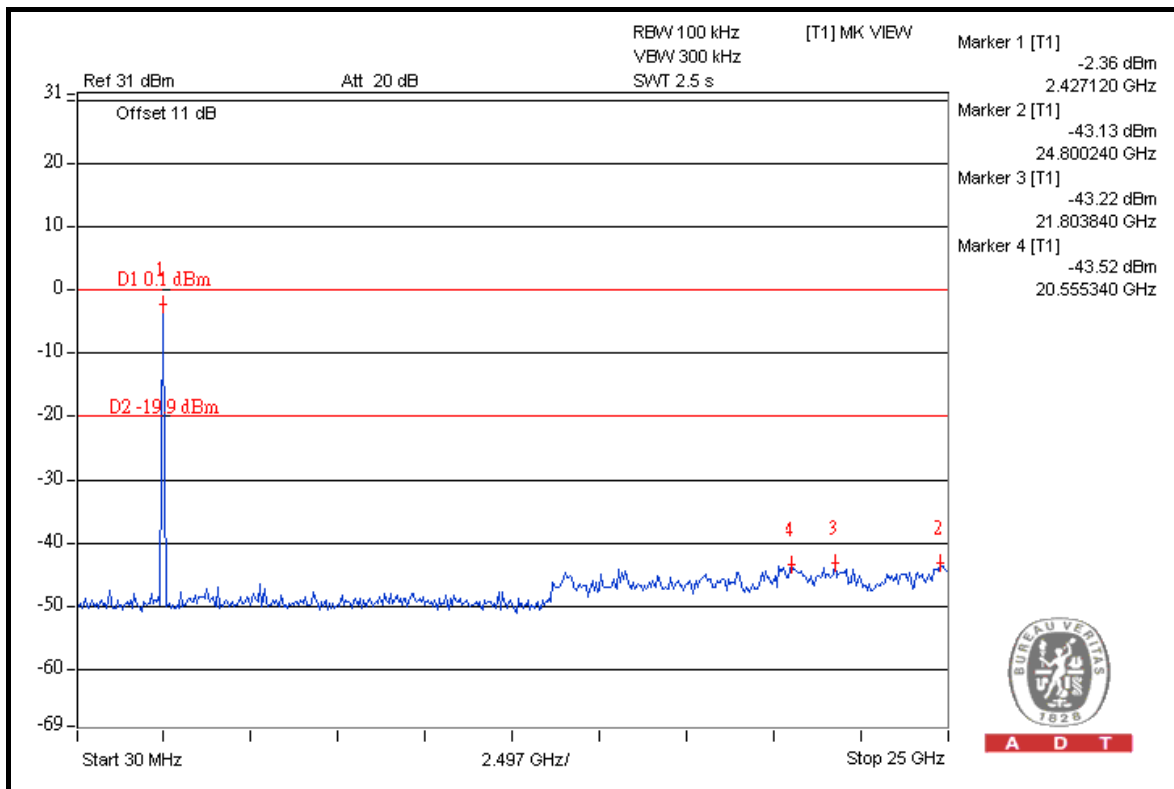
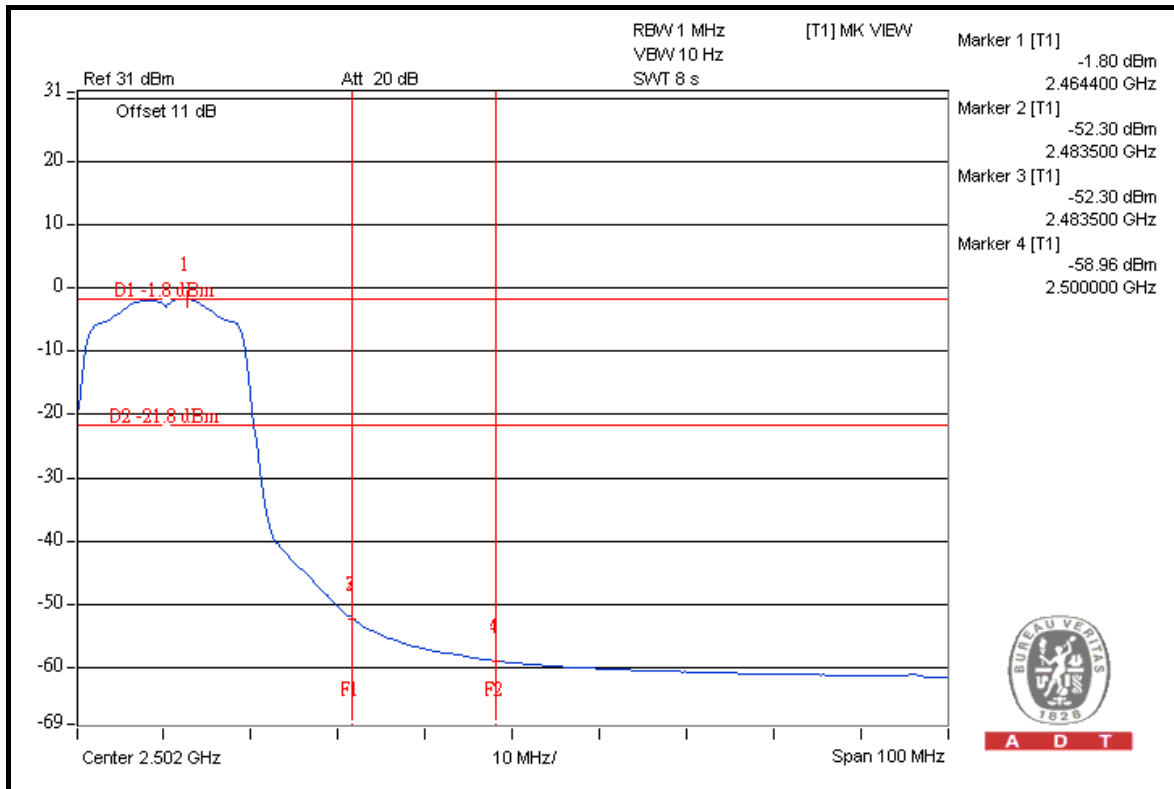



A D T

5. PHOTOGRAPHS OF THE TEST CONFIGURATION

Please refer to the attached file (Test Setup Photo).



A D T

6. INFORMATION ON THE TESTING LABORATORIES

We, Bureau Veritas Consumer Products Services (H.K.) Ltd., Taoyuan Branch, were founded in 1988 to provide our best service in EMC, Radio, Telecom and Safety consultation. Our laboratories are accredited and approved according to ISO/IEC 17025.

Copies of accreditation certificates of our laboratories obtained from approval agencies can be downloaded from our web site: www.adt.com.tw/index.5.phtml. If you have any comments, please feel free to contact us at the following:

Linko EMC/RF Lab:

Tel: 886-2-26052180

Fax: 886-2-26051924

Hsin Chu EMC/RF Lab:

Tel: 886-3-5935343

Fax: 886-3-5935342

Hwa Ya EMC/RF/Safety Telecom Lab:

Tel: 886-3-3183232

Fax: 886-3-3185050

Email: service.adt@tw.bureauveritas.com

Web Site: www.adt.com.tw

The address and road map of all our labs can be found in our web site also.



A D T

7. APPENDIX A - MODIFICATIONS RECORDERS FOR ENGINEERING CHANGES TO THE EUT BY THE LAB

No any modifications are made to the EUT by the lab during the test.

---END---