



FCC TEST REPORT

for

47 CFR Part 15 Subpart C

Equipment : GSM Phone with GPRS and Bluetooth
Trade Name : Philips Consumer Electronics
Model No. : 768
FCC ID : HFS-CT7688
Filing Type : Certification
Applicant : **Quanta Computer Inc.**
No. 188, Wen Hwa 2nd Road, Kuei Shan Hsiang, Tao Yuan
Shien, Taiwan

- The test result refers exclusively to the test presented test model / sample.
- Without written approval of SPORTON International Inc., the test report shall not be reproduced except in full.
- **Certificate or Test Report must not be used by the applicant to claim the product in this test report endorsement by NVLAP or any agency of U.S. government.**
- The data shown in this test report were carried out on Sep. 12, 2005 at **Sporton International Inc. LAB.**

A handwritten signature in blue ink, appearing to read 'Daniel Lee'.

Dr. Daniel Lee
EMC/SAR Manager

SPORTON International Inc.

6F, No.106, Sec. 1, Hsin Tai Wu Rd., Hsi Chih, Taipei Hsien, Taiwan, R.O.C.

SPORTON International Inc.

TEL : 886-2-2696-2468

FAX : 886-2-2696-2255



Table of Contents

History of this test report..... ii

1. General Description of Equipment under Test..... 1

 1.1. Applicant 1

 1.2. Manufacturer 1

 1.3. Basic Description of Equipment under Test 1

 1.4. Feature of Equipment under Test 2

2. Test Configuration of Equipment under Test 3

 2.1. Test Manner 3

 2.2. Test Mode 3

 2.3. Connection Diagram of Test System 4

 2.4. Ancillary Equipment List 4

3. RF Utility 5

4. General Information of Test..... 6

 4.1. Test Voltage 6

 4.2. Standard for Methods of Measurement 6

 4.3. Test in Compliance with 6

 4.4. Frequency Range Investigated 6

 4.5. Test Distance 6

5. Report of Measurements and Examinations 7

 5.1. List of Measurements and Examinations 7

 5.2. Hopping Channel Separation 8

 5.3. Number of Hopping Frequency 12

 5.5 Dwell Time of Each Frequency within a 30 Seconds Period 18

 5.6 Output Power 38

 5.7 100kHz Bandwidth of Frequency Band Edges 42

 5.8 Conducted Emission 46

 5.9 Radiated Emission Measurement 51

 5.10 Antenna Requirements 57

6. List of Measuring Equipments Used 58

7. Uncertainty Evaluation..... 59

Appendix A. External Product Photograph

Appendix B. Internal Photograph

Appendix C. Setup Photograph



1. General Description of Equipment under Test

1.1. Applicant

Quanta Computer Inc.

No. 188, Wen Hwa 2nd Road, Kuei Shan Hsiang, Tao Yuan Shien, Taiwan

1.2. Manufacturer

Quanta Computer Inc.

No. 188, Wen Hwa 2nd Road, Kuei Shan Hsiang, Tao Yuan Shien, Taiwan

1.3. Basic Description of Equipment under Test

Equipment	: GSM Phone with GPRS and Bluetooth
Trade Name	: Philips Consumer Electronics
Model No.	: 768
Power Supply Type	: Switching, DC 4.2V
AC Power Cord	: AC 120V, Weave-shielded, Wall-mount, 1.8meter, 2pin
Earpiece	: Minami, ME-826N-05
Adapter	: PHILIPS, P925BW05050AB65
Battery	: Sanyo, 1UF553450S-QC



1.4. Feature of Equipment under Test

Product Feature & Specification			
1. Modulation Type/Data Rate	GFSK		
2. Frequency Range.	2400 MHz ~ 2483.5 MHz		
3. Number of Channels	79		
4. Carrier Frequency of each channel	2402MHz+n*1MHz, n=0~78		
5. Channel Spacing	1 MHz		
6. HW Version	B2B		
7. SW Version	050711n-08.00 HPV.POP-0.15D TPWM		
8. Maximum Output Power to Antenna (Normal condition)	1.58 dBm		
9. Type of Antenna Connector	N/A		
10. Antenna Type	Embedded Antenna		
11. Antenna Gain	-3 dBi		
12. Power Rating (DC/AC, Voltage)	4.2V / 150mA		
13. Function Type	Transmitter		Transceiver V



2. Test Configuration of Equipment under Test

2.1. Test Manner

- a. The EUT has been associated with peripherals pursuant to ANSI C63.4-2003 and configuration operated in a manner tended to maximize its emission characteristics in a typical application.
- b. For spurious emission below 1GHz, only one channel of each application was tested because it is not related to channel selection.
- c. The EUT is programmed to transmit signal continuously for all testings.
- d. Frequency range investigated: conduction 150 kHz to 30 MHz, radiation 30 MHz to 25000MHz.

2.2. Test Mode

Application	Bluetooth
Radiated Emission	Mode 1: Tx_CH00_2402 MHz Mode 2: Tx_CH39_2441 MHz Mode 3: Tx_CH78_2480 MHz
Conducted Emission	Mode 1: PCS Idle + MP3 + BT Link + Adapter Mode 2: PCS Idle + Camera + BT Link + Adapter

2.3. Connection Diagram of Test System

<Radiation Emission>

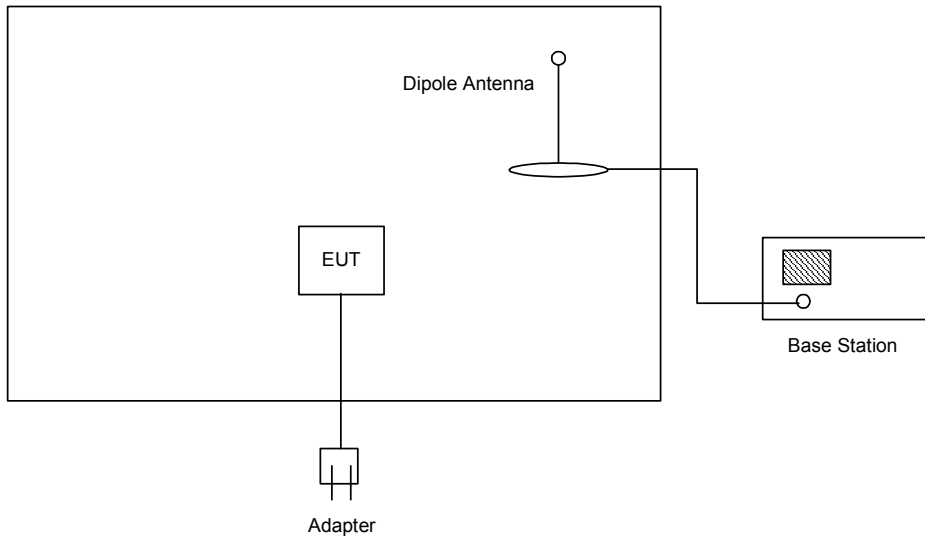

<Conducted Emission>

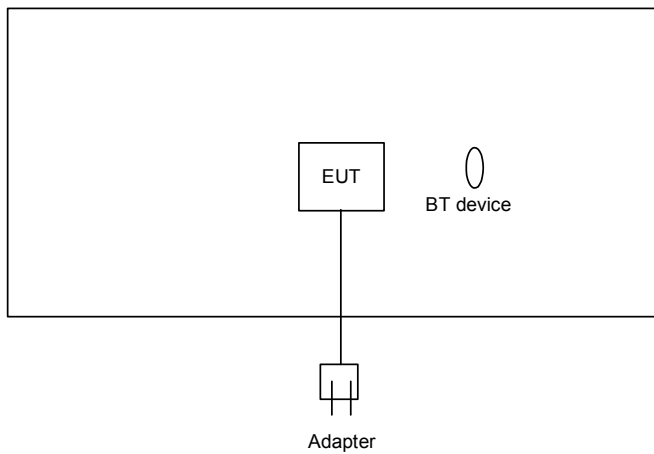

2.4. Ancillary Equipment List

Item	Equipment	Model Name	Serial No.
1.	Base Station	CMU200	105934



3. RF Utility

The EUT is in BT Link mode with BT device for conducted emission or in BT continuous Tx mode controlled by base station simulator.



4. General Information of Test

Test Site Location : No. 52, Hwa Ya 1st Rd., Hwa Ya Technology Park,
Kwei-Shan Hsiang, Tao Yuan Hsien, Taiwan, R.O.C.
TEL : 886-3-327-3456
FAX : 886-3-318-0055
Test Site No : CO01-HY, 03CH06-HY

4.1. Test Voltage

AC 120V

4.2. Standard for Methods of Measurement

ANSI C63.4-2003

4.3. Test in Compliance with

47 CFR Part 15 Subpart C

4.4. Frequency Range Investigated

Conduction: from 150 kHz to 30 MHz
Radiation: from 30 MHz to 25000MHz

4.5. Test Distance

The test distance of radiated emission from antenna to EUT is 3 m.



5. Report of Measurements and Examinations

5.1. List of Measurements and Examinations

FCC Rule	Description of Test	Result	Section
15.247(a)(1)	Hopping Channel Separation	Pass	5.2
15.247(a)(1)(iii)	Number of Hopping Frequency Used	Pass	5.3
15.247(a)(1)	Hopping Channel Bandwidth	Pass	5.4
15.247(a)(1)(iii)	Dwell Time of Each Frequency within a 30 Second Period	Pass	5.5
15.247(b)(1)	Output Power	Pass	5.6
15.247(c)	100kHz Bandwidth of Frequency Band Edges	Pass	5.7
15.207	Conducted Emission	Pass	5.8
15.209	Radiated Emission	Pass	5.9
15.203	Antenna Requirement	Pass	5.10

5.2. Hopping Channel Separation

5.2.1. Measuring Instruments :

As described in chapter 6 of this test report.

5.2.2. Test Procedure :

1. The transmitter output was connected to the spectrum analyzer directly.
2. Set RBW of spectrum analyzer to 30kHz and VBW to 100kHz.
3. The Hopping Channel Separation is defined as the channel is separated with the next channel.

5.2.3. Test Setup Layout :

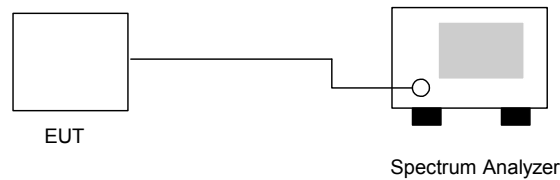

5.2.4. Test Result : The spectrum analyzer plots are attached as below

- Temperature: 26°C
- Relative Humidity: 54%
- Test Engineer : Jay

Channel	Frequency (MHz)	Hopping Channel Separation (MHz)	Limits (MHz)	Plot Ref. No.
00	2402	1.0	0.874	Mode 1
39	2441	1.0	0.824	Mode 2
78	2480	1.0	0.868	Mode 3

Remark: Limit is the greater one of 25kHz or the 20dB bandwidth of the hopping channel.



5.2.5 Hopping Channel Separation

Mode 1: CH00 (2402MHz)

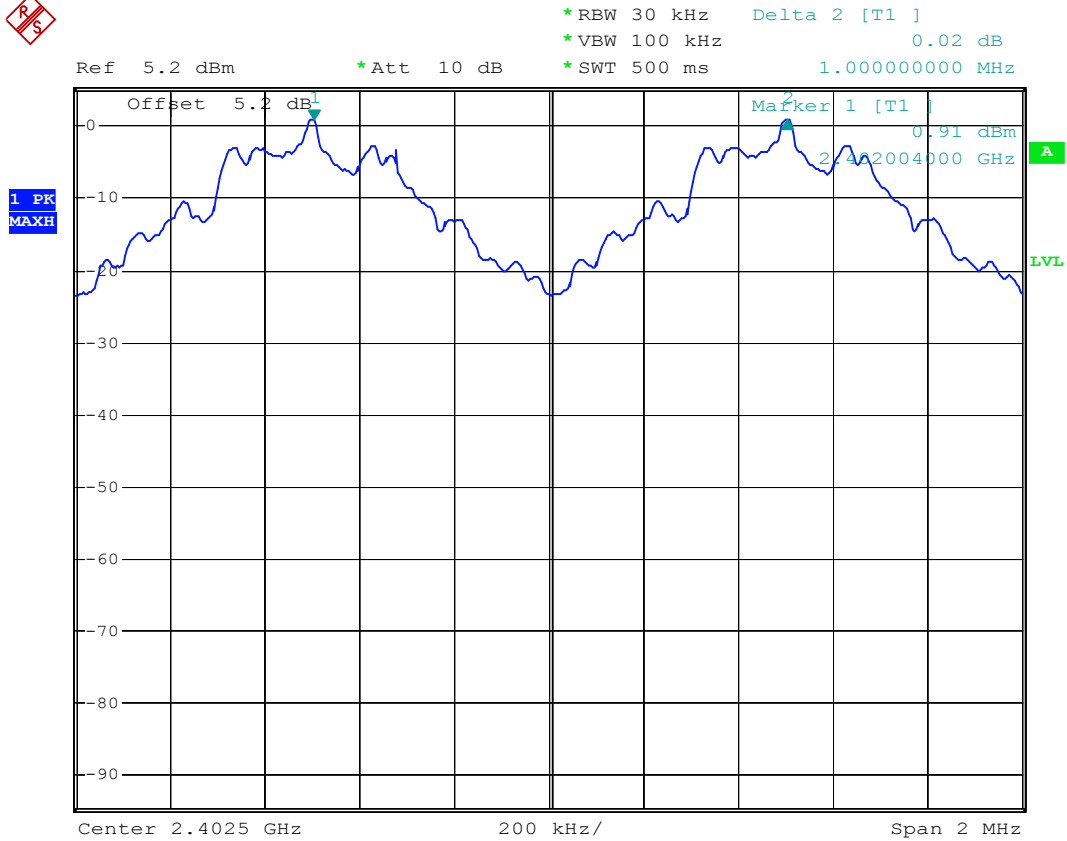

Date: 12.SEP.2005 14:58:02



Mode 2: CH39 (2441MHz)



Ref 5.2 dBm *Att 10 dB *RBW 30 kHz Delta 2 [T1]
 *VBW 100 kHz 0.03 dB
 *SWT 500 ms 1.000000000 MHz

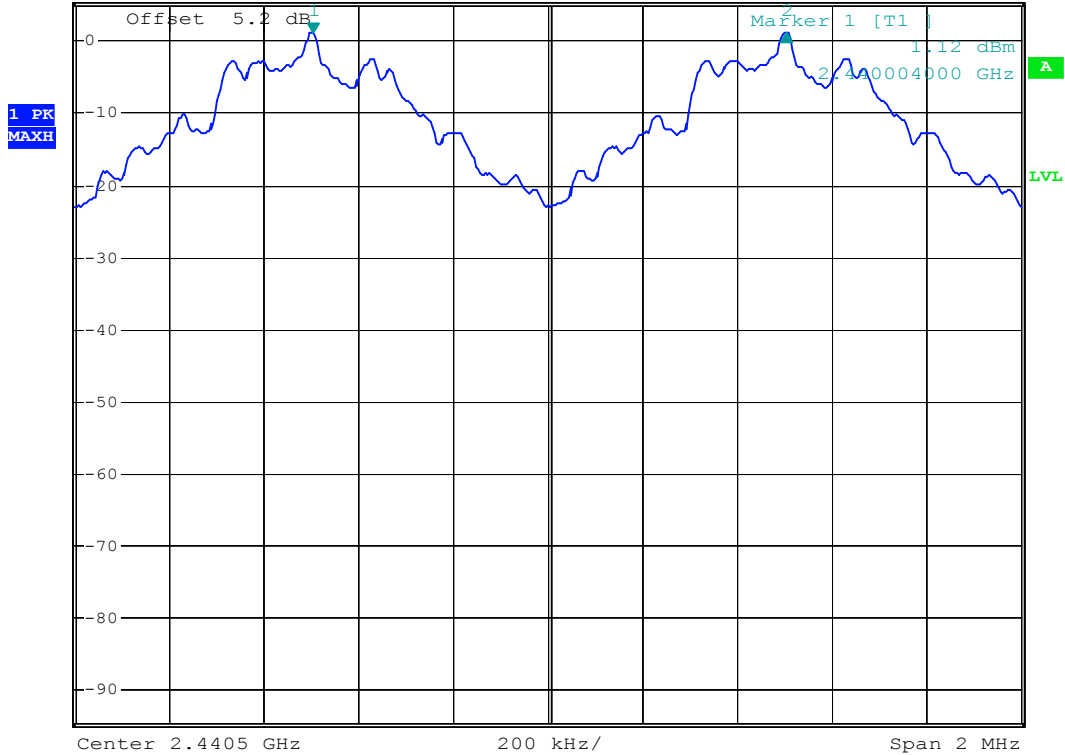

Date: 12.SEP.2005 14:58:33



Mode 3: CH78 (2480MHz)



Ref 5.2 dBm *Att 10 dB *RBW 30 kHz Delta 2 [T1]
 *VBW 100 kHz -0.00 dB
 *SWT 500 ms 1.000000000 MHz

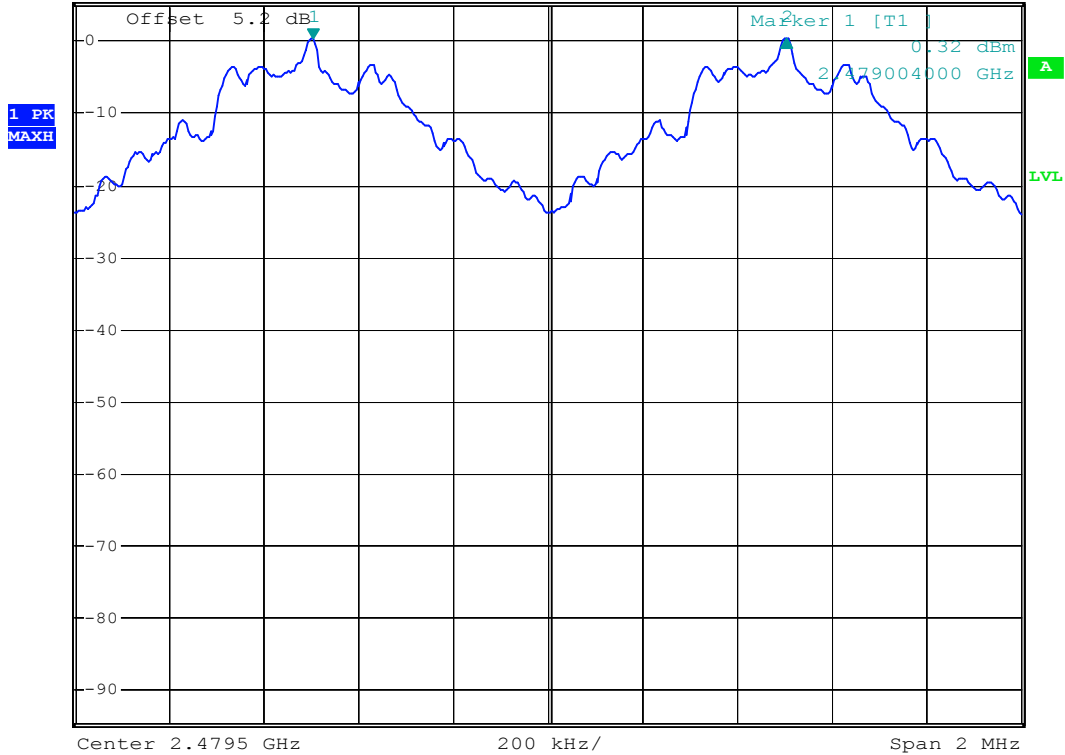

Date: 12.SEP.2005 15:00:40

5.3. Number of Hopping Frequency

5.3.1. Measuring Instruments :

As described in chapter 6 of this test report.

5.3.2. Test Procedure :

1. The transmitter output was connected to the spectrum analyzer directly.
2. Set RBW of spectrum analyzer to 100kHz and VBW to 100kHz.
3. The number of hopping frequency used is defined as the device has the numbers of total channel.

5.3.3. Test Setup Layout :

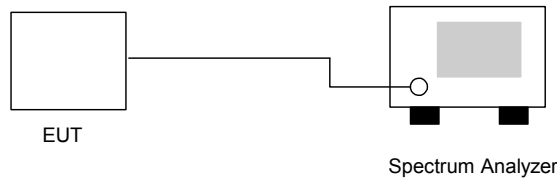

5.3.4. Test Result : See spectrum analyzer plots below

- Temperature: 26°C
- Relative Humidity: 54%
- Test Engineer : Jay

Number of Hopping Frequency (Channel)	Limits (Channel)
79	15



5.3.5 Number of Hopping Frequency

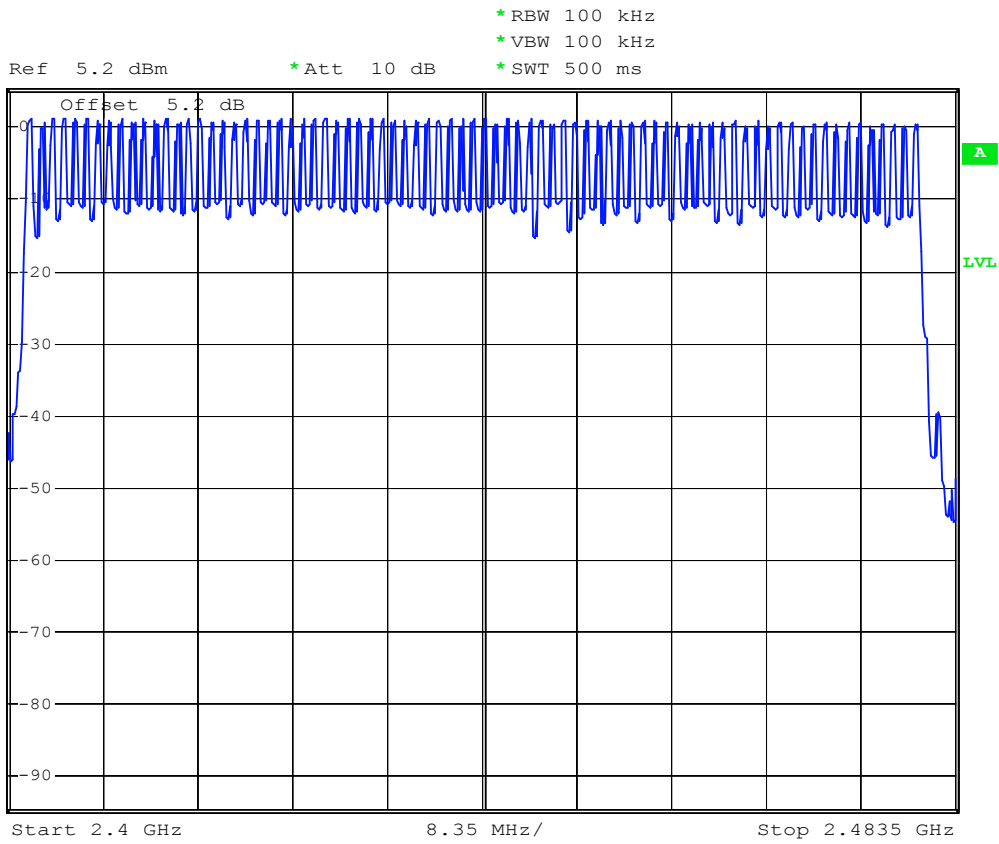

Date: 12.SEP.2005 15:16:13

5.4 Hopping Channel Bandwidth

5.4.1 Measuring Instruments :

As described in chapter 6 of this test report.

5.4.2 Test Procedure :

1. The transmitter output was connected to the spectrum analyzer directly.
2. Set RBW of spectrum analyzer to 30kHz and VBW to 300kHz.
3. The Hopping Channel bandwidth is defined as the frequency range where the power is higher than peak power minus 20dB.

5.4.3 Test Setup Layout :

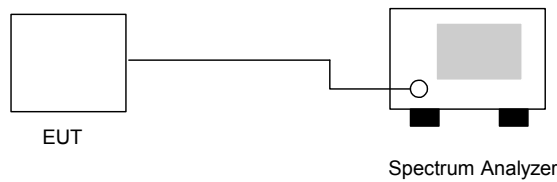

5.4.4 Test Result : See spectrum analyzer plots below

- Temperature: 26°C
- Relative Humidity: 54%
- Test Engineer : Jay

Channel	Frequency (MHz)	Hopping Channel Bandwidth (MHz)	Limits (MHz)	Plot Ref. No.
00	2402	0.874	1.0	Mode 1
39	2441	0.824	1.0	Mode 2
78	2480	0.868	1.0	Mode 3



5.4.5 Hopping Channel Bandwidth

Mode 1: CH00 (2402MHz)



*RBW 30 kHz Delta 2 [T1]
 *VBW 300 kHz -0.27 dB
 *SWT 500 ms 874.00000000 kHz
 Ref 5.2 dBm *Att 10 dB



Date: 12.SEP.2005 14:56:23



Mode 2: CH39 (2441MHz)



Ref 5.2 dBm *Att 10 dB *RBW 30 kHz Delta 2 [T1]
 *VBW 300 kHz -0.17 dB
 *SWT 500 ms 824.000000000 kHz

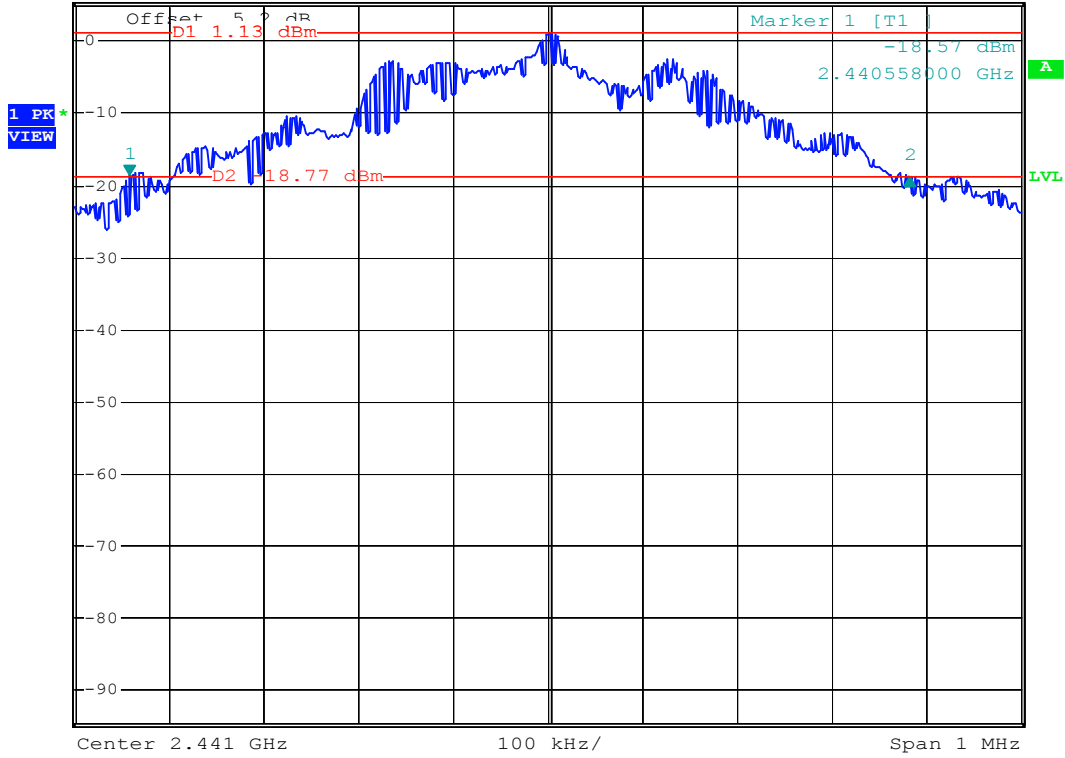

Date: 12.SEP.2005 14:59:37



Mode 3: CH78 (2480MHz)

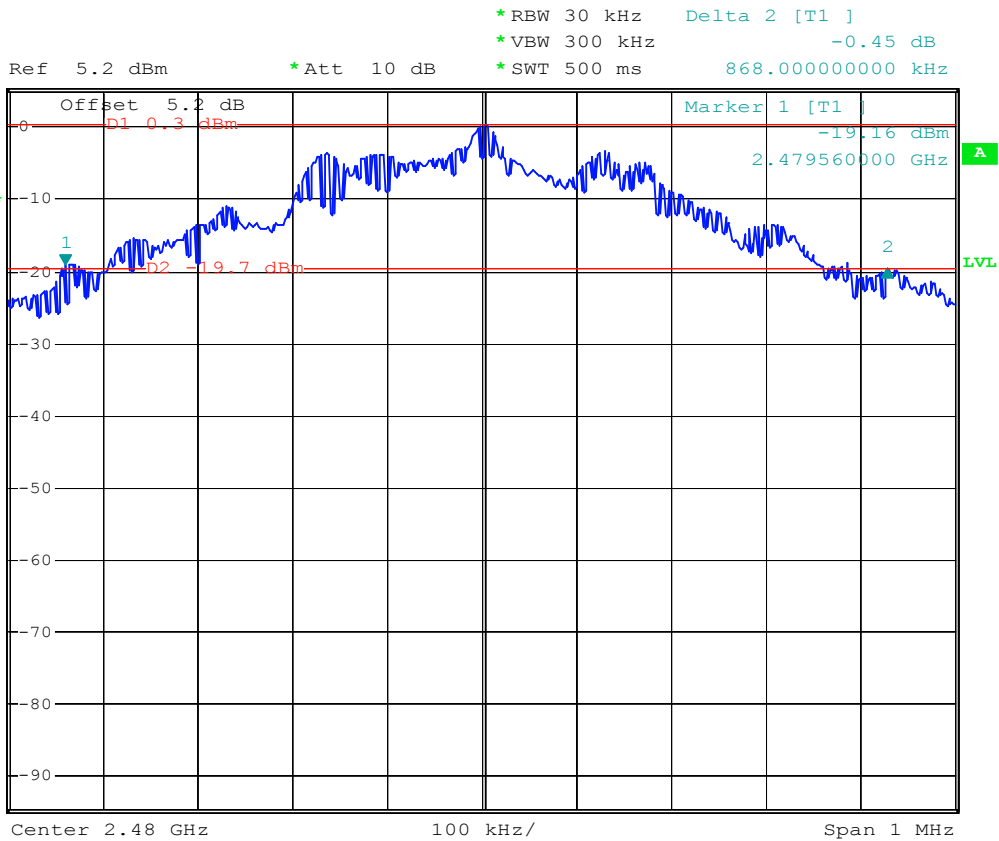

Date: 12.SEP.2005 15:01:35

5.5 Dwell Time of Each Frequency within a 30 Seconds Period

5.5.1 Measuring Instruments :

As described in chapter 6 of this test report.

5.5.2 Test Procedure :

1. The transmitter output was connected to the spectrum analyzer directly.
2. Set RBW of spectrum analyzer to 1MHz and VBW to 1MHz.
3. Set the center frequency on any frequency would be measured and set the frequency span to zero span.
4. The equation = $30 \cdot (1600/79) \cdot t$ (t = the time duration of one single pulse)

5.5.3 Test Setup Layout :

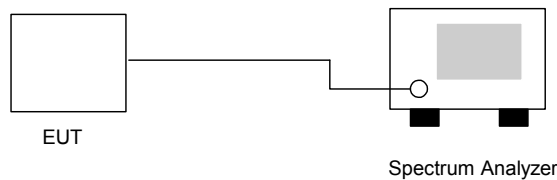

5.5.4 Test Result : See spectrum analyzer plots below

- Temperature: 26°C
- Relative Humidity: 54%
- Test Engineer : Jay

Ch00

Package Mode	Average Hopping Channel	Package Transfer Time (us)	Dwell Time (s)	Limit (s)
DH1	8.9	548	0.15	0.4
DH3	5	1808	0.29	0.4
DH5	3.1	3088	0.30	0.4



CH39

Package Mode	Average Hopping Channel	Package Transfer Time (us)	Dwell Time (s)	Limit (s)
DH1	9	548	0.16	0.4
DH3	4.6	1810	0.26	0.4
DH5	3.4	3050	0.33	0.4

CH78

Package Mode	Average Hopping Channel	Package Transfer Time (us)	Dwell Time (s)	Limit (s)
DH1	9.1	544	0.16	0.4
DH3	5.1	1814	0.29	0.4
DH5	3.5	3054	0.34	0.4

※ Remark:

1. Dwell Time=79(channels) x 0.4(s) x average hopping channel x package transfer time
2. 79channels come from the Hopping Channel number.
3. Average Hopping Channel = hops/sweep time
4. t: Package Transfer Time(us)



5.5.5 Dwell Time

DH1 (CH00)



RBW 1 MHz Delta 3 [T1]
 *VBW 1 MHz 0.12 dB
 Ref 5.2 dBm *Att 10 dB SWT 2 ms 1.260000 ms

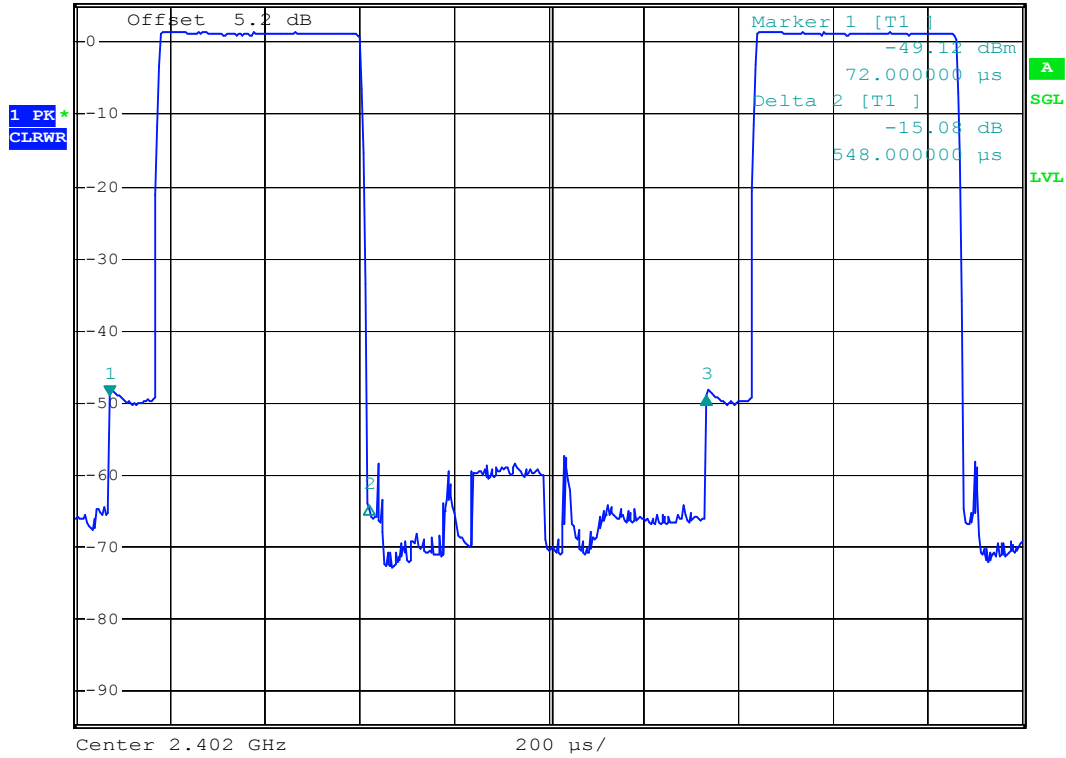

Date: 12.SEP.2005 15:07:06

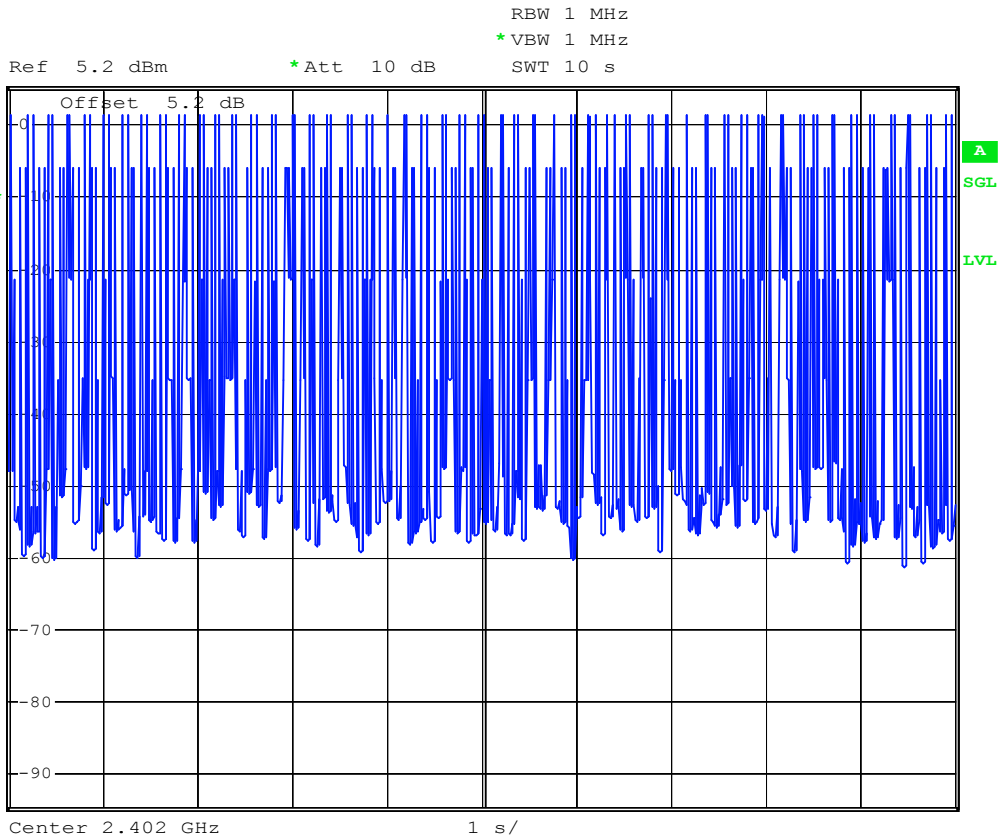

Date: 12.SEP.2005 15:11:17



DH1 (CH39)

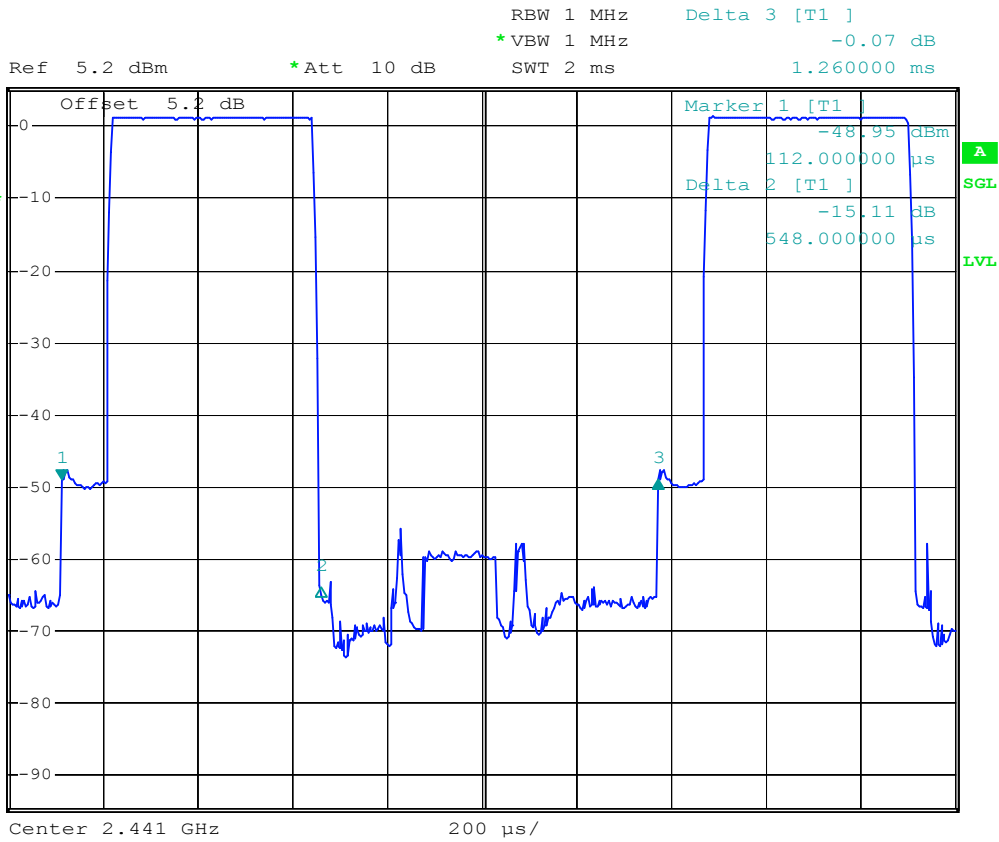

Date: 12.SEP.2005 15:06:37

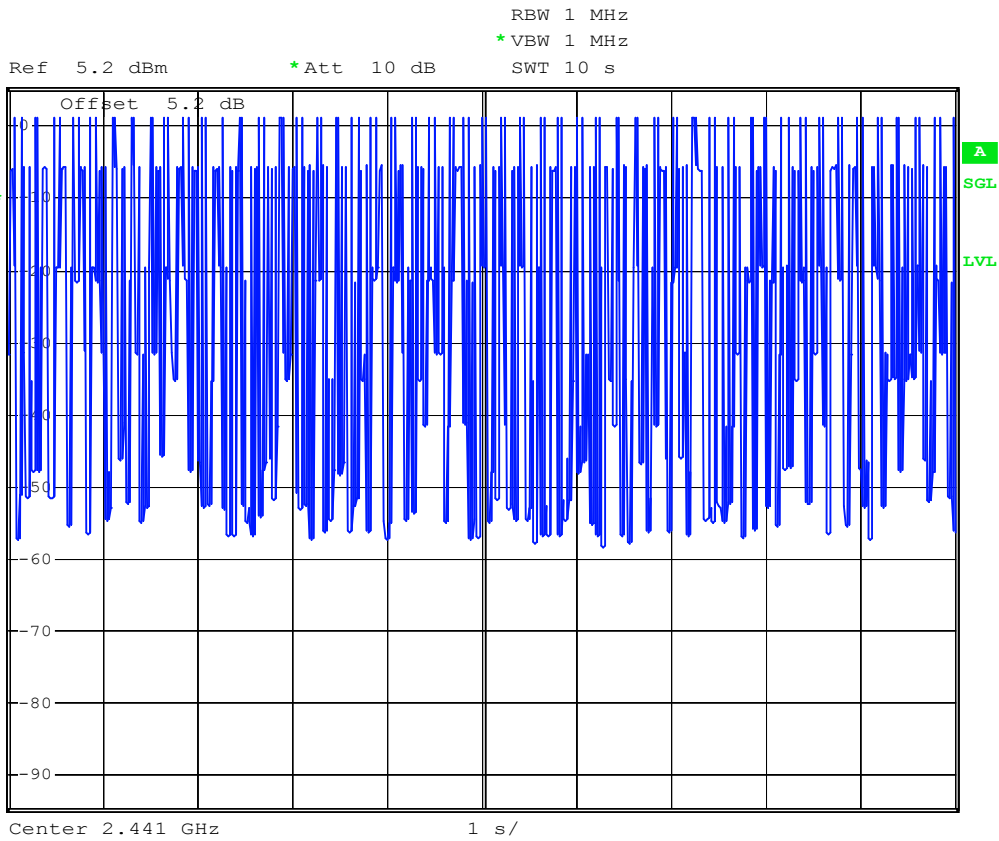

Date: 12.SEP.2005 15:11:39



DH1 (CH78)

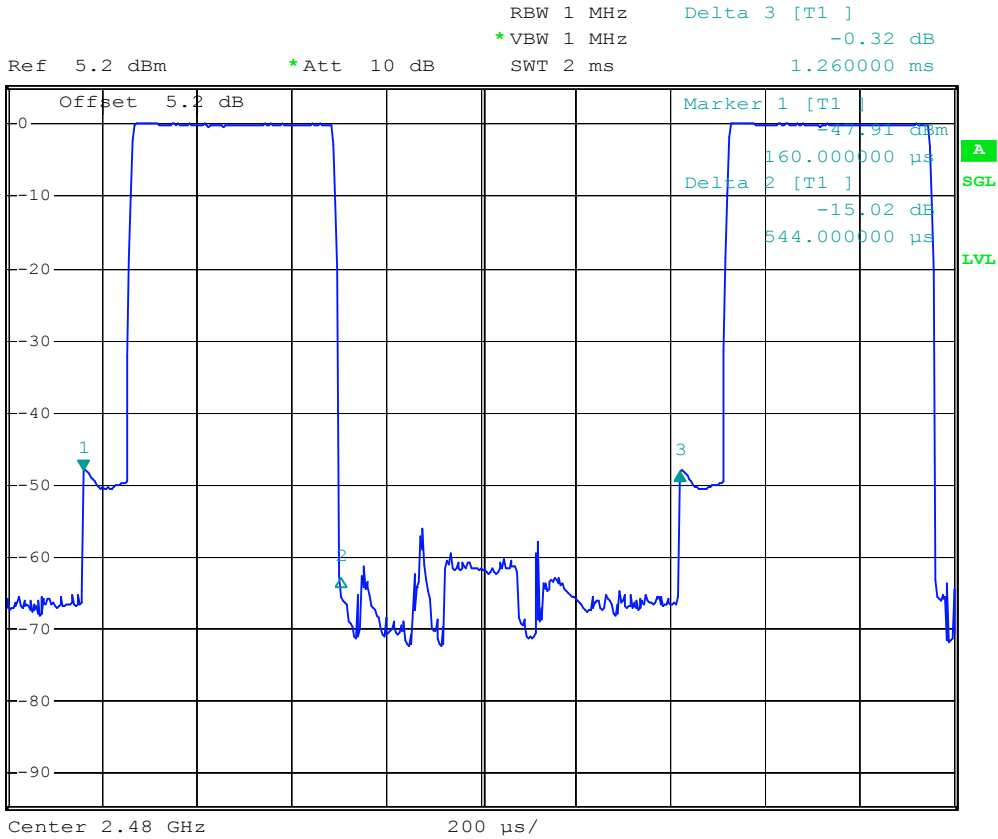

Date: 12.SEP.2005 15:04:05

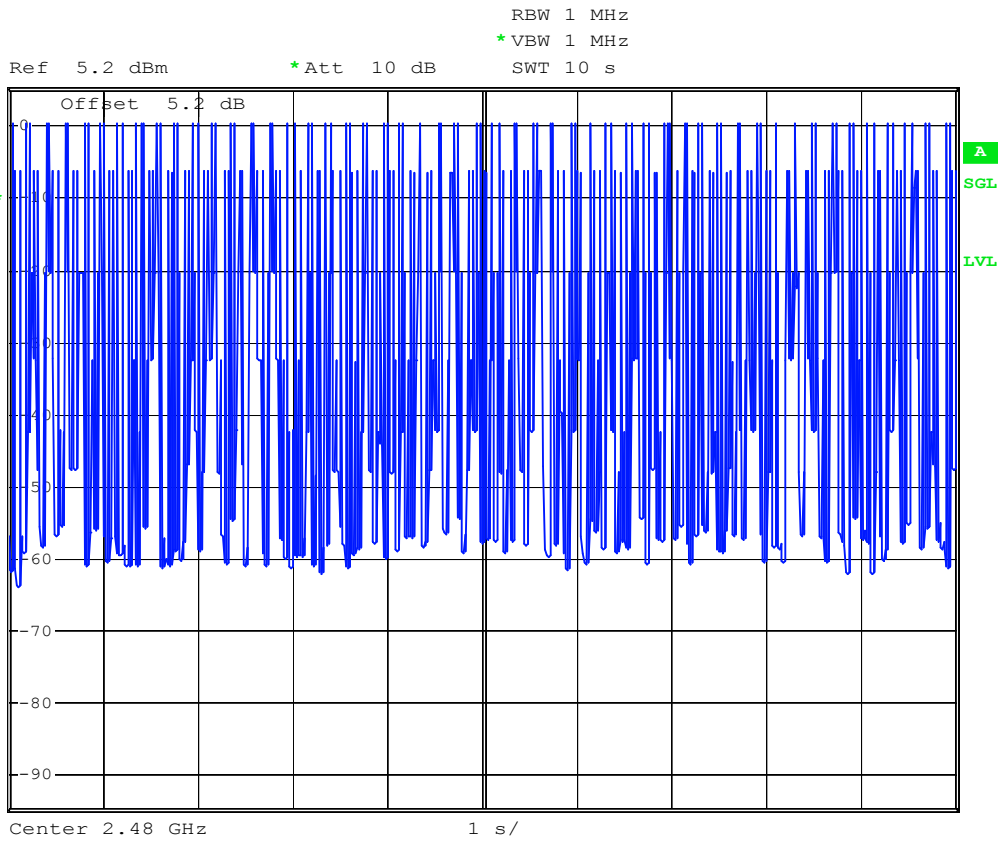

Date: 12.SEP.2005 15:12:04



DH3 (CH00)

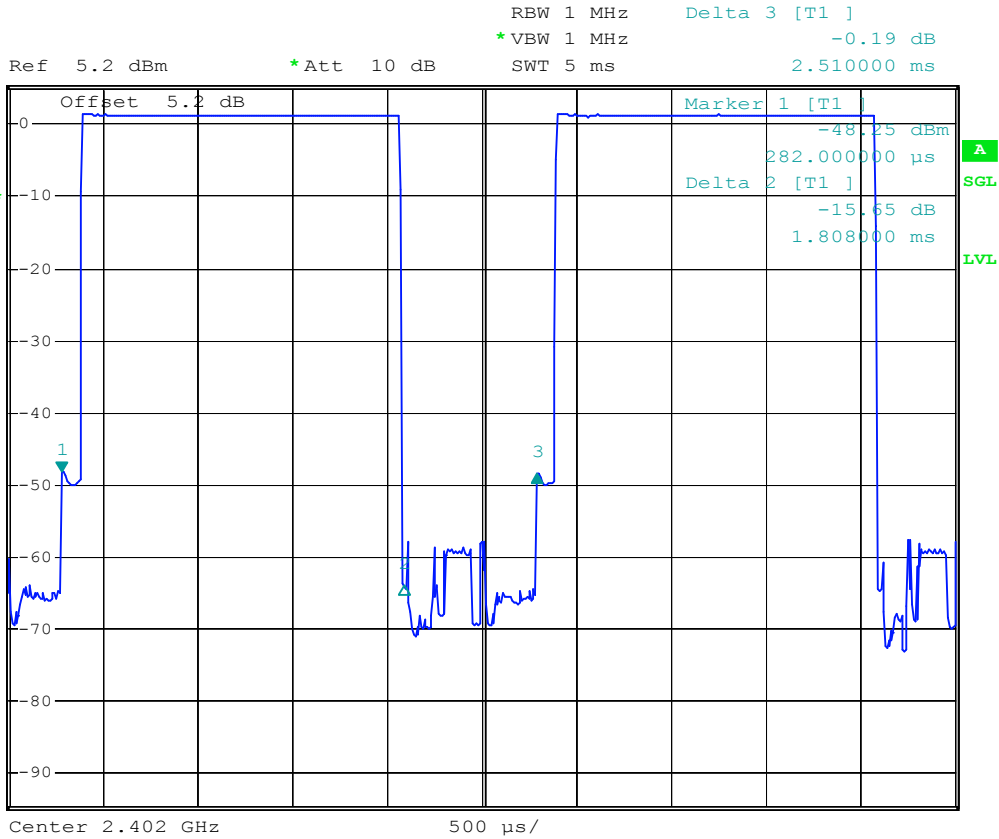

Date: 12.SEP.2005 15:07:32

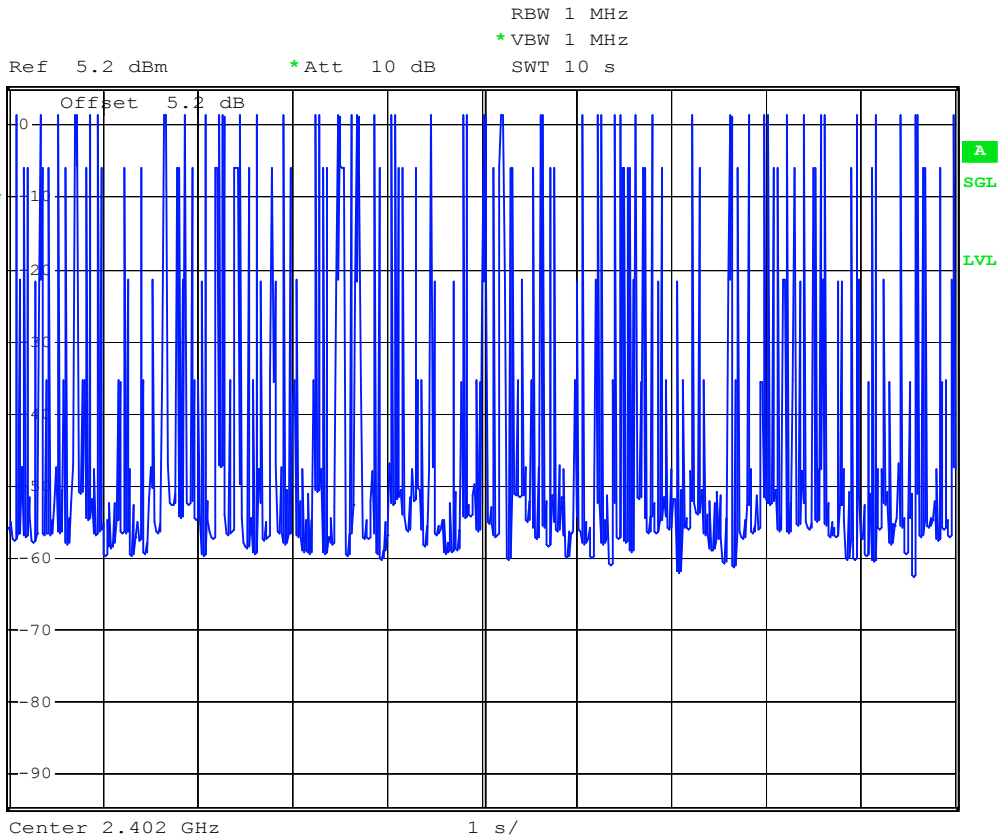

Date: 12.SEP.2005 15:10:55



DH3 (CH39)



RBW 1 MHz Delta 3 [T1]
 *VBW 1 MHz -0.31 dB
 Ref 5.2 dBm *Att 10 dB SWT 5 ms 2.510000 ms

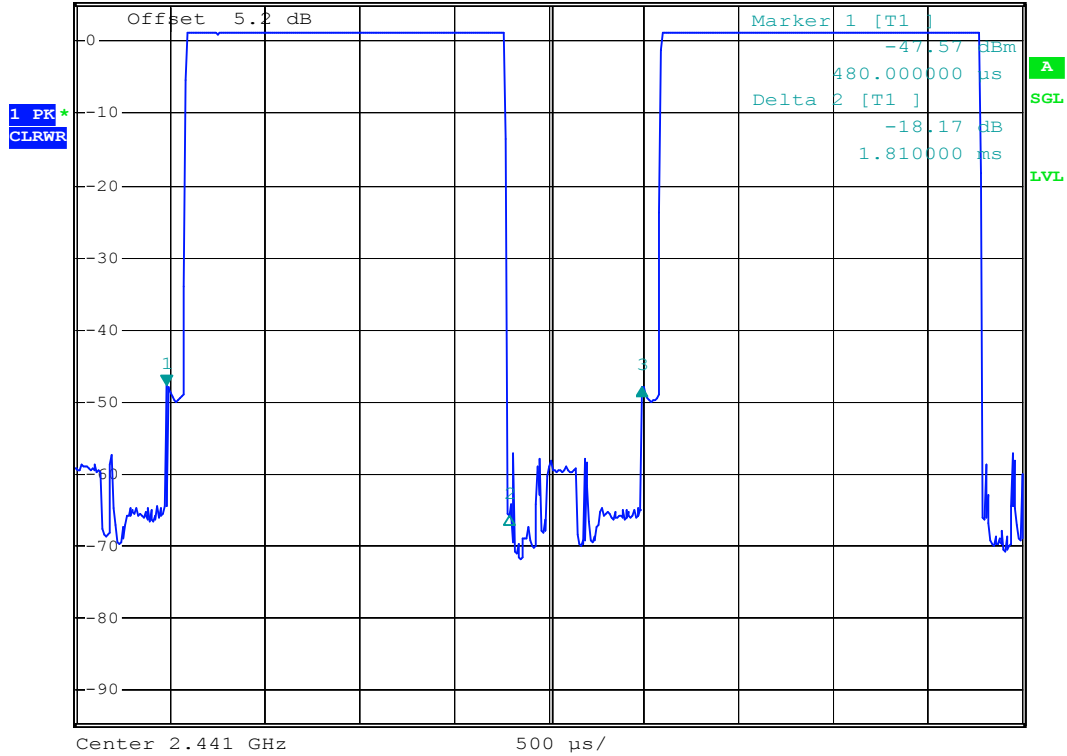

Date: 12.SEP.2005 15:06:07



Ref 5.2 dBm *Att 10 dB RBW 1 MHz
*VBW 1 MHz SWT 10 s

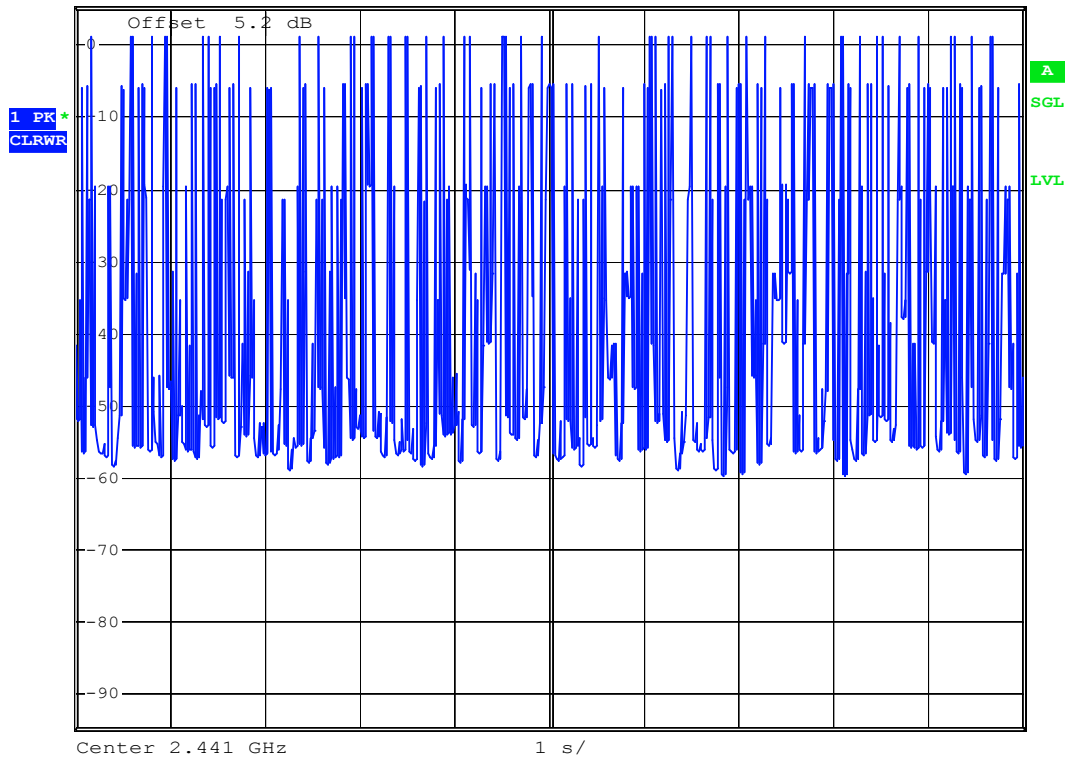

Date: 12.SEP.2005 15:10:24



DH3 (CH78)

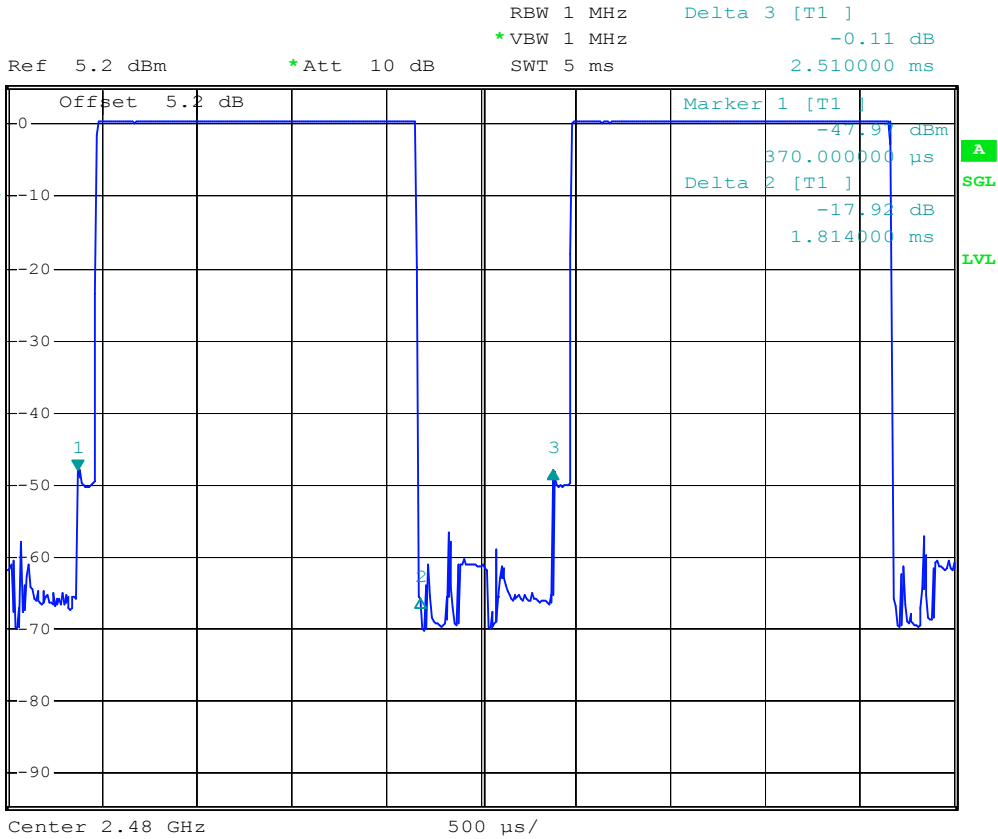

Date: 12.SEP.2005 15:04:32



Ref 5.2 dBm *Att 10 dB RBW 1 MHz
*VBW 1 MHz SWT 10 s

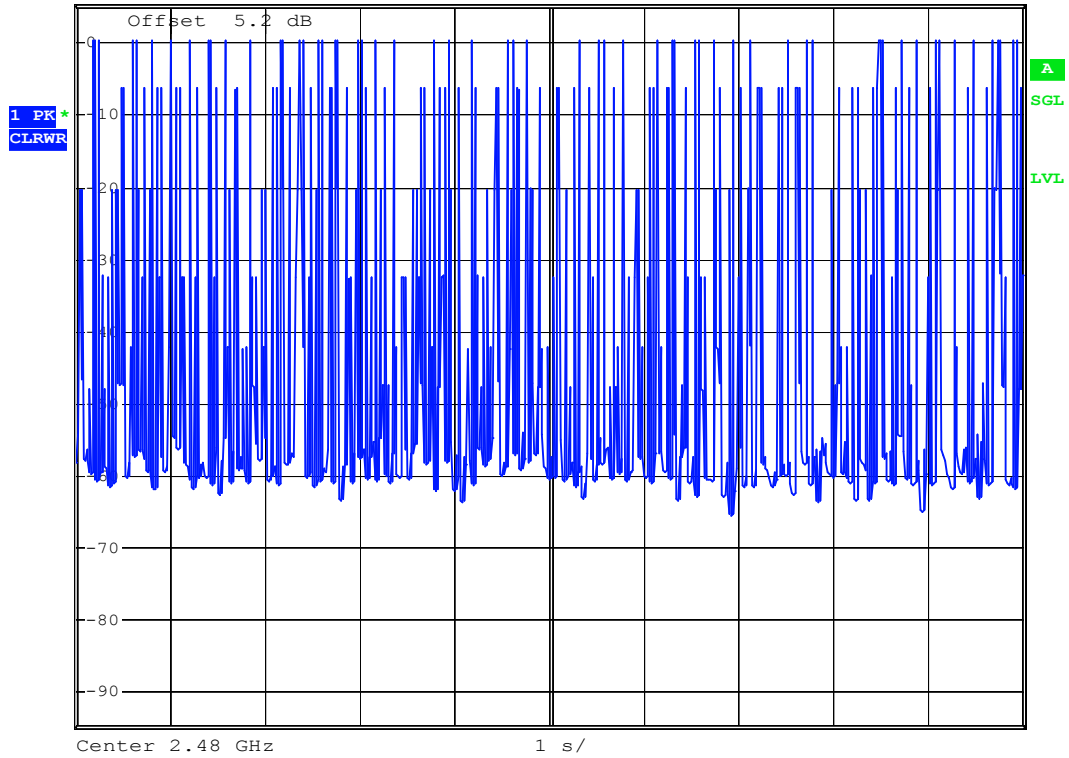

Date: 12.SEP.2005 15:09:58



DH5 (CH00)



RBW 1 MHz Delta 3 [T1]
 *VBW 1 MHz -0.03 dB
 Ref 5.2 dBm *Att 10 dB SWT 10 ms 3.750000 ms

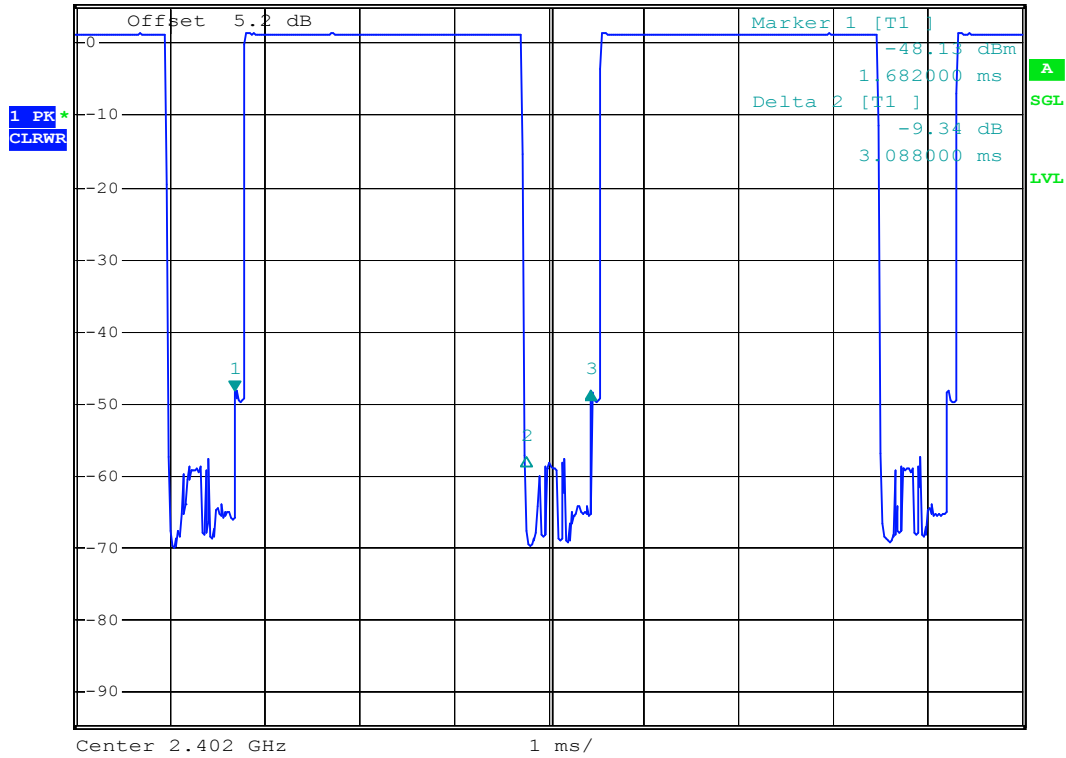

Date: 12.SEP.2005 15:07:58

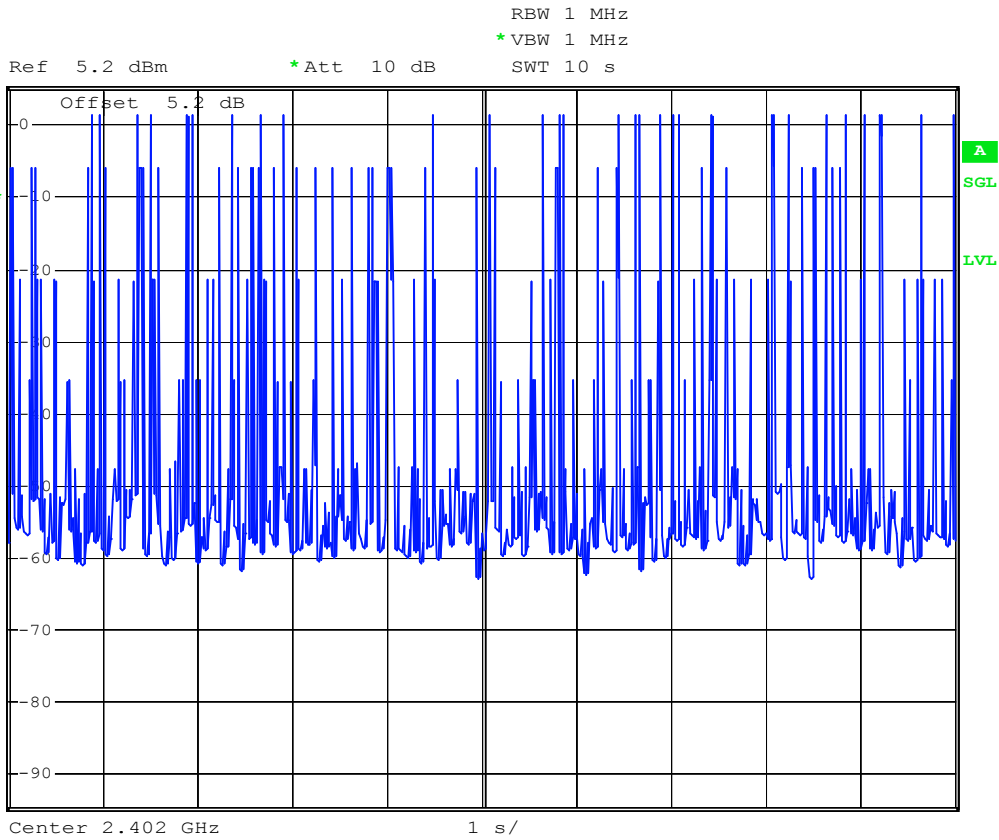

Date: 12.SEP.2005 15:08:30



DH5 (CH39)



RBW 1 MHz Delta 3 [T1]
 *VBW 1 MHz 0.01 dB
 Ref 5.2 dBm *Att 10 dB SWT 10 ms 3.750000 ms

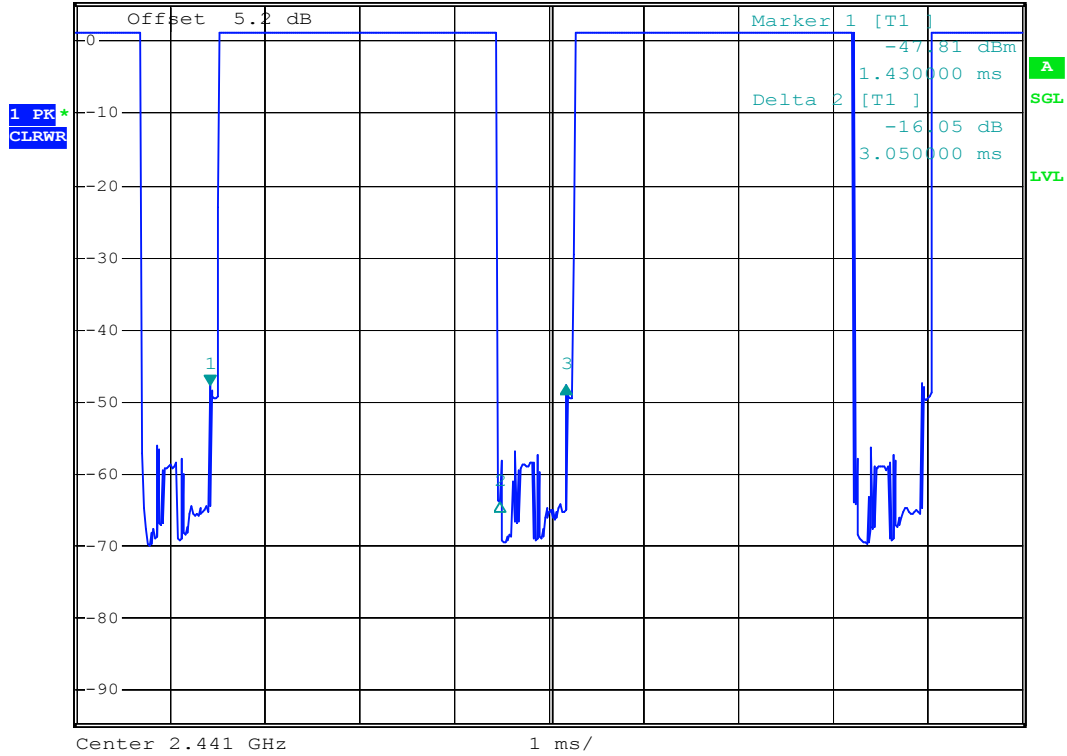

Date: 12.SEP.2005 15:05:37

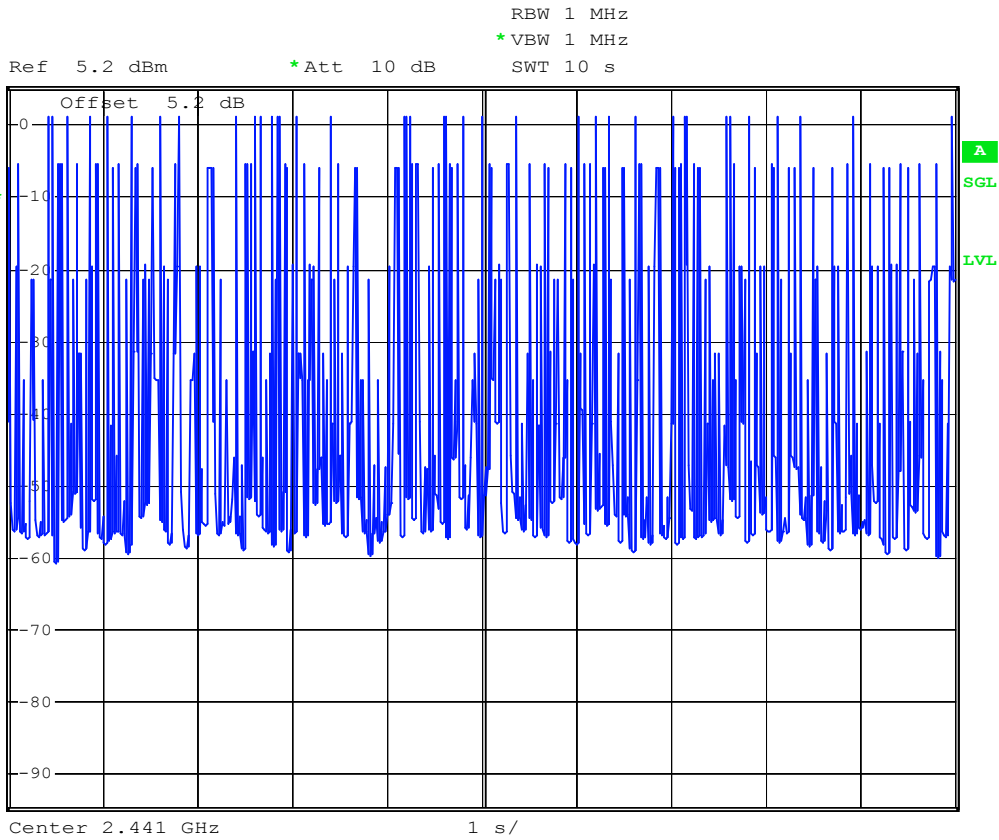

Date: 12.SEP.2005 15:08:55



DH5 (CH78)



RBW 1 MHz Delta 3 [T1]
 *VBW 1 MHz 0.07 dB
 Ref 5.2 dBm *Att 10 dB SWT 10 ms 3.750000 ms

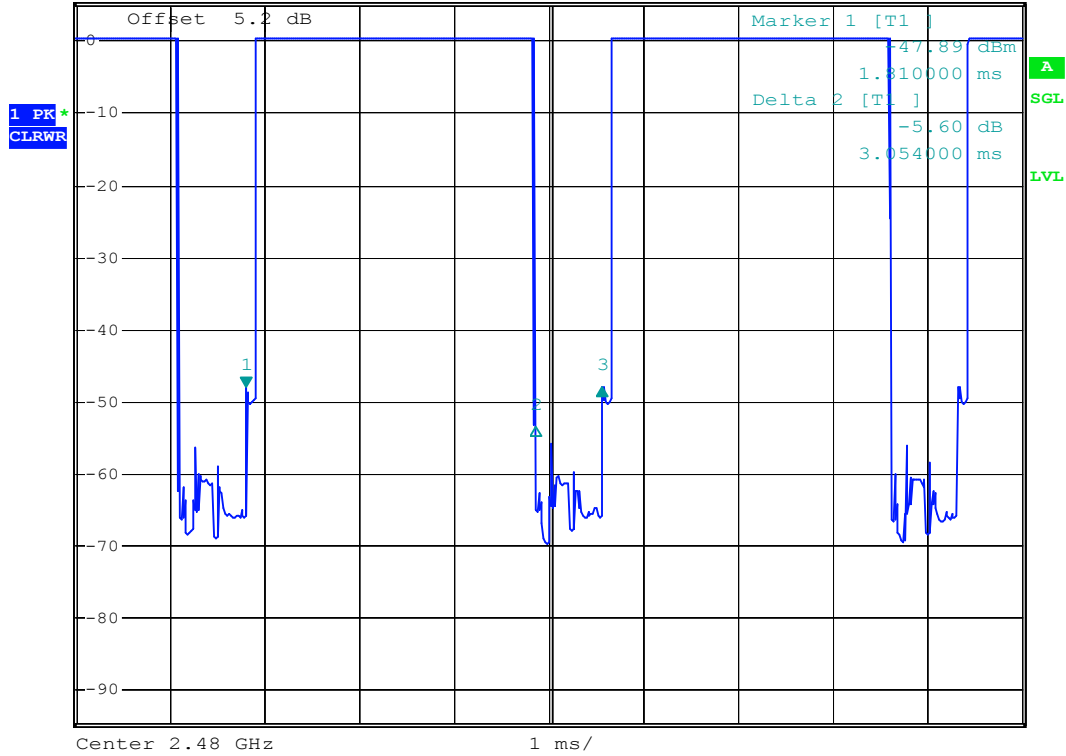

Date: 12.SEP.2005 15:05:01

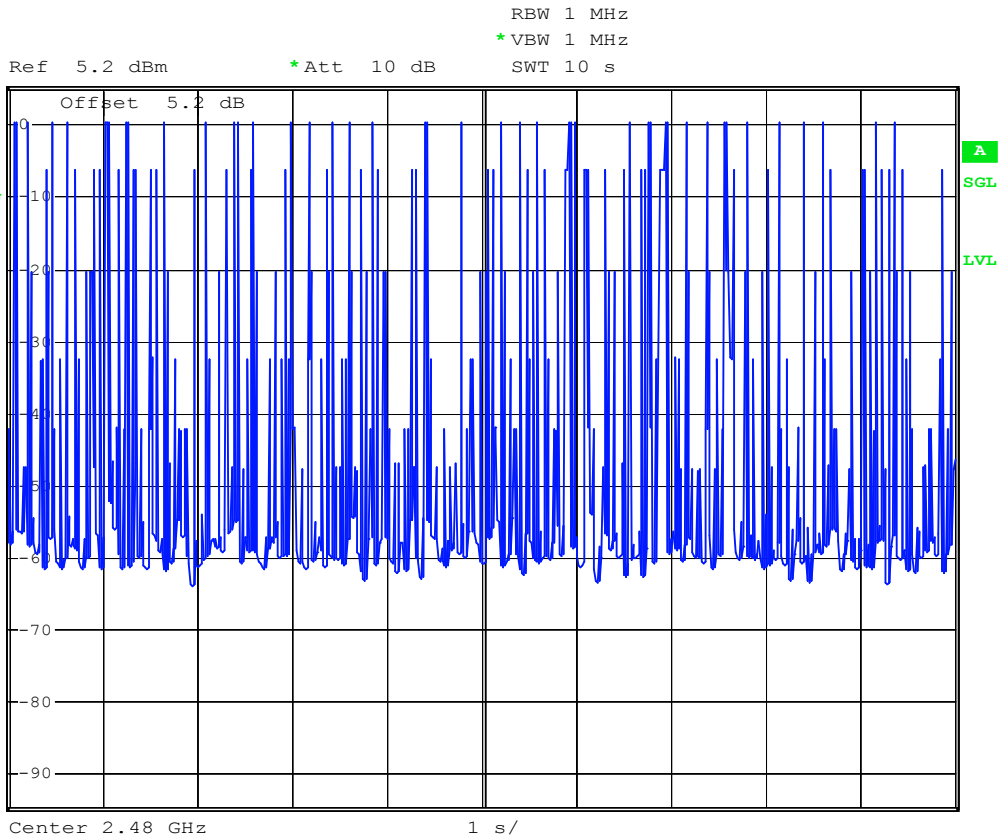

Date: 12.SEP.2005 15:09:18

5.6 Output Power

5.6.1 Measuring Instruments :

As described in chapter 6 of this test report.

5.6.2 Test Procedure :

1. The transmitter output was connected to the spectrum analyzer directly.
2. The center frequency of the spectrum analyzer was set to the fundamental frequency and set RBW to 3MHz and VBW to 3MHz.

5.6.3 Test Setup Layout :

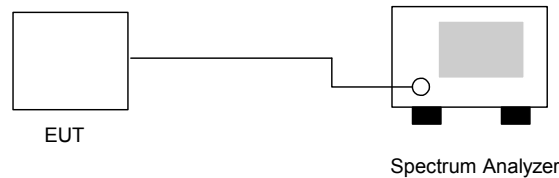

5.6.4 Test Result : See spectrum analyzer plots below

- Temperature: 26°C
- Relative Humidity: 54%
- Test Engineer : Jay

Channel	Frequency (MHz)	Measured Output Power (dBm)	Limits (Watt/dBm)	Plot Ref. No.
00	2402	1.58	1W/30 dBm	Mode 1
39	2441	1.39	1W/30 dBm	Mode 2
78	2480	0.19	1W/30 dBm	Mode 3



5.6.5 Output Power

Mode 1: CH00 (2402MHz)

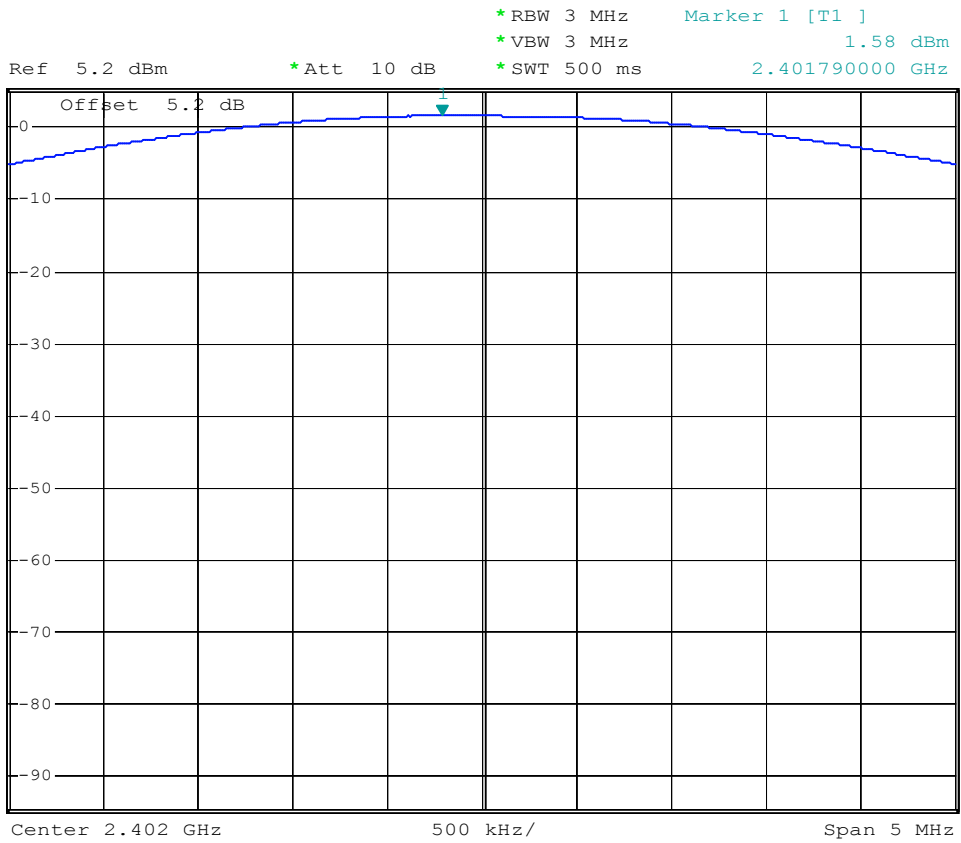

Date: 12.SEP.2005 14:55:26



Mode 2: CH39 (2441MHz)

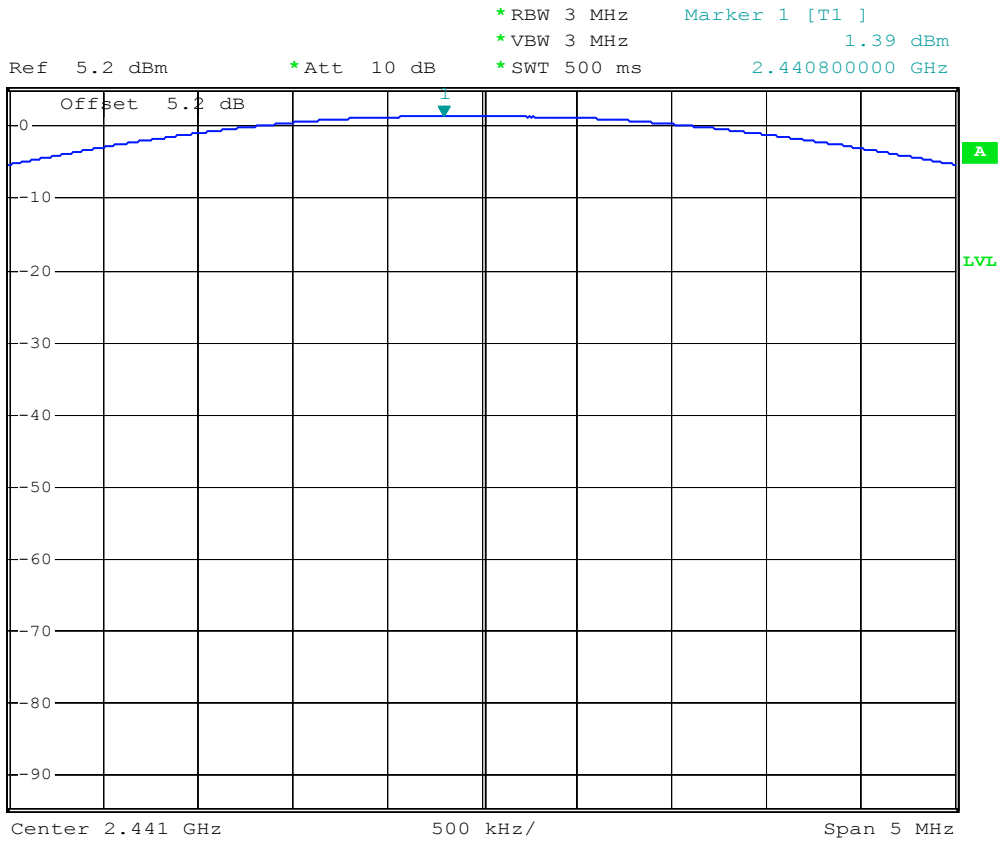

Date: 12.SEP.2005 15:00:04



Mode 3: CH78 (2480MHz)



Ref 5.2 dBm *Att 10 dB *RBW 3 MHz Marker 1 [T1] 0.19 dBm
*VBW 3 MHz 2.479790000 GHz
*SWT 500 ms

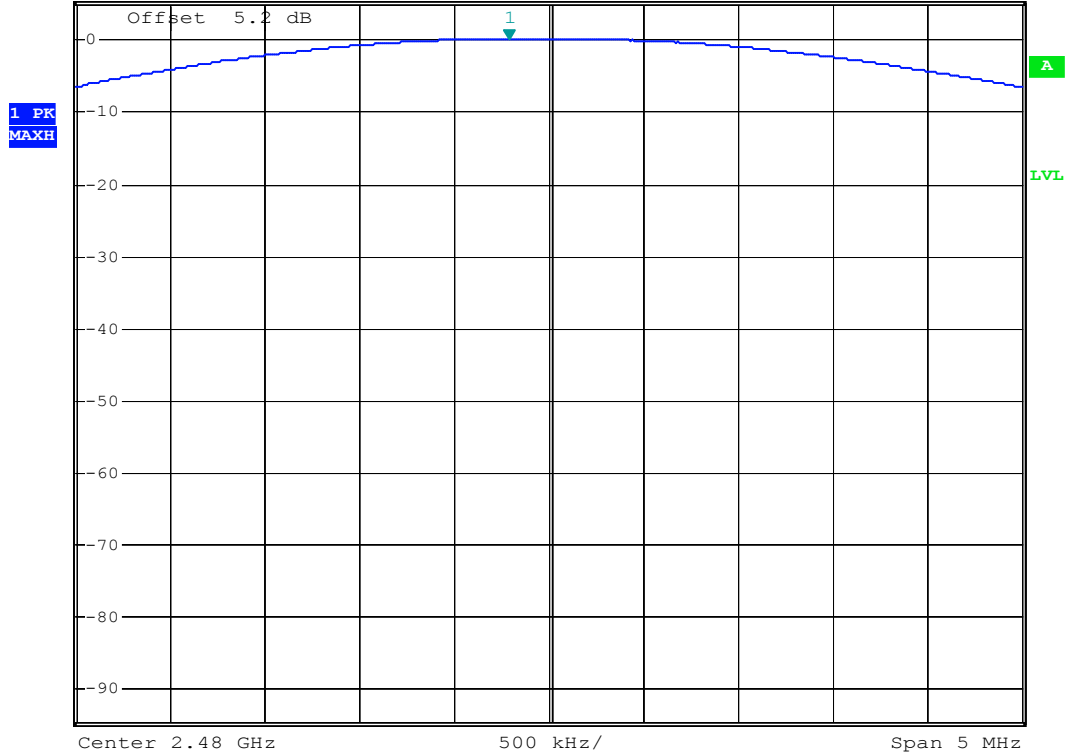

Date: 12.SEP.2005 15:03:17



5.7 100kHz Bandwidth of Frequency Band Edges

5.7.1 Measuring Instruments :

As described in chapter 6 of this test report.

5.7.2 Test Procedure :

1. The transmitter output was connected to the spectrum analyzer via a low lose cable.
2. Set both RBW and VBW of spectrum analyzer to 100kHz with suitable frequency span including 100 kHz bandwidth from band edge.
3. The band edges was measured and recorded.

5.7.3 Test Result :

- Temperature: 26°C
- Relative Humidity: 54%
- Test Enginner : Jay

Test Result in lower band (Channel 00) : PASS

Test Result in higher band(Channel 78) : PASS

5.7.4 Note on Band edge Emission

CH00 (Horizontal)

Frequency (MHz)	Level (dBuV/m)	Over Limit (dB)	Limit Line (dBuV/m)	Read Level (dBuV)	Antenna Factor (dB)	Cable Loss (dB)	Preamp Factor (dB)	Ant Pos (cm)	Table Pos (deg)	Detect Mode
2390.00	53.03	-20.97	74.00	53.74	30.48	4.26	35.46	100	0	Peak
2390.00	39.07	-14.93	54.00	39.78	30.48	4.26	35.46	100	203	Average

CH00 (Vertical)

Frequency (MHz)	Level (dBuV/m)	Over Limit (dB)	Limit Line (dBuV/m)	Read Level (dBuV)	Antenna Factor (dB)	Cable Loss (dB)	Preamp Factor (dB)	Ant Pos (cm)	Table Pos (deg)	Detect Mode
2390.00	53.05	-20.95	74.00	53.76	30.48	4.26	35.46	100	0	Peak
2390.00	39.06	-14.94	54.00	39.77	30.48	4.26	35.46	100	320	Average



CH78 (Horizontal)

Frequency (MHz)	Level (dBuV/m)	Over Limit (dB)	Limit Line (dBuV/m)	Read Level (dBuV)	Antenna Factor (dB)	Cable Loss (dB)	Preamp Factor (dB)	Ant Pos (cm)	Table Pos (deg)	Detect Mode
2483.50	68.60	-5.40	74.00	69.34	30.41	4.36	35.51	100	0	Peak
2483.50	50.52	-3.48	54.00	51.26	30.41	4.36	35.51	100	196	Average

CH78 (Vertical)

Frequency (MHz)	Level (dBuV/m)	Over Limit (dB)	Limit Line (dBuV/m)	Read Level (dBuV)	Antenna Factor (dB)	Cable Loss (dB)	Preamp Factor (dB)	Ant Pos (cm)	Table Pos (deg)	Detect Mode
2483.50	65.84	-8.16	74.00	66.58	30.41	4.36	35.51	100	0	Peak
2483.50	49.61	-4.39	54.00	50.35	30.41	4.36	35.51	100	319	Average



5.7.5 Frequency Band Edge

Mode 1: CH00 (2402 MHz)



*RBW 100 kHz Marker 1 [T1]
 *VBW 100 kHz -40.27 dBm
 *SWT 500 ms 2.400000000 GHz

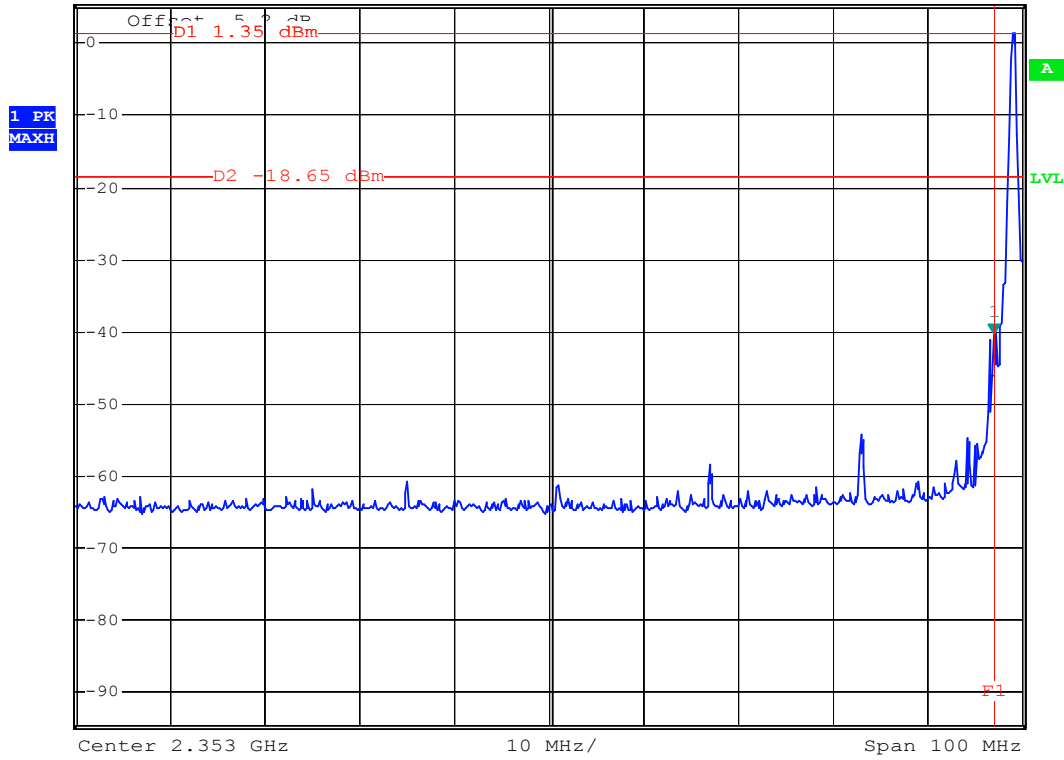

Date: 12.SEP.2005 14:57:17



Mode 3: CH78 (2480 MHz)



*RBW 100 kHz Marker 1 [T1]
*VBW 100 kHz -49.55 dBm
*SWT 500 ms 2.483900000 GHz

Ref 5.2 dBm

*Att 10 dB

1 PK
MAXH

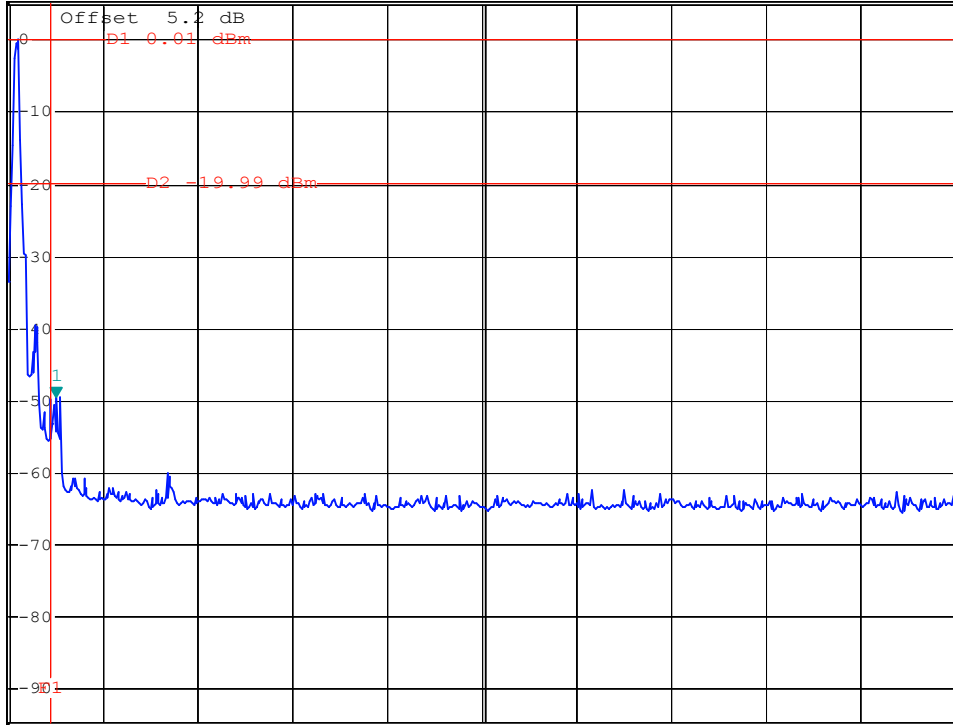

Center 2.529 GHz 10 MHz/ Span 100 MHz

Date: 12.SEP.2005 15:02:33



5.8 Conducted Emission

5.8.1 Measuring Instruments

As described in chapter 6 of this test Report.

5.8.2 Test Procedures :

- a. The EUT was placed 0.4 meter from the conducting wall of the shielding room was kept at least 80 centimeters from any other grounded conducting surface.
- b. Connect EUT to the power port of a line impedance stabilization network (LISN).
- c. All the support units are connected to the other LISN.
- d. The LISN provides 50 ohm coupling impedance for the measuring instrument.
- e. The FCC states that a 50 ohm, 50 microhenry LISN should be used.
- f. Both sides of AC line were checked for maximum conducted interference.
- g. The frequency range from 150 kHz to 30 MHz was searched.
- h. Set the test-receiver system to Peak Detect Function and specified bandwidth with Maximum Hold Mode.



5.8.3 Test Data

- Temperature : 26 °C
- Relating Humidity : 54 %
- Test Engineer : Jay
- Test Mode : Mode 1

The test that passed at minimum margin was marked by the frame in the following table.

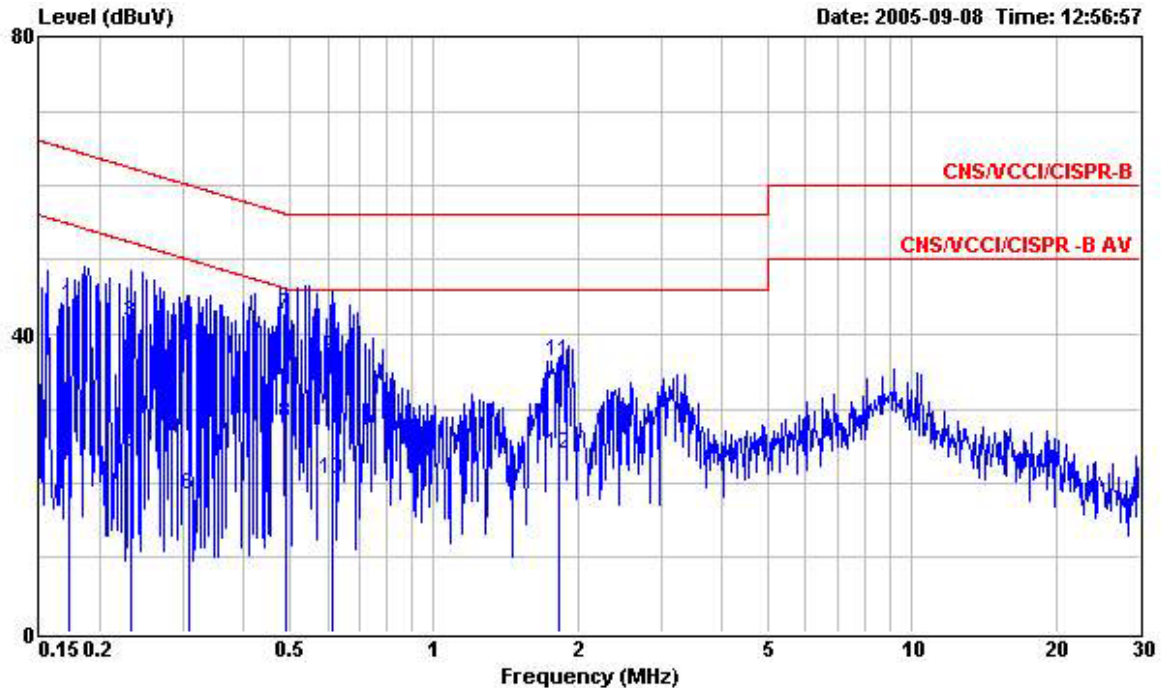

Site : CO01-HY
 Condition : CNS/VCCI/CISPR-B 2001/004 200505 LINE
 EUT : GSM Phone with GPRS and Bluetooth
 Power : 120V/60Hz
 Model : EW580903
 Memo : PCS 1900 IDLE+MP3+BT LINK+CHARGER
 Memo :
 Memo :

	Freq	Level	Over Limit	Limit Line	Read Level	Probe Factor	Cable Loss	Remark
	MHz	dBuV	dB	dBuV	dBuV	dB	dB	
1	0.173	43.81	-21.01	64.82	43.71	0.06	0.04	QP
2	0.173	26.20	-28.62	54.82	26.10	0.06	0.04	Average
3	0.233	41.68	-20.66	62.34	41.58	0.06	0.04	QP
4	0.233	23.62	-28.72	52.34	23.52	0.06	0.04	Average
5	0.308	38.33	-21.69	60.02	38.22	0.06	0.05	QP
6	0.308	18.50	-31.52	50.02	18.39	0.06	0.05	Average
7	0.491	42.73	-13.42	56.15	42.60	0.07	0.06	QP
8	0.491	28.11	-18.04	46.15	27.98	0.07	0.06	Average
9	0.611	36.96	-19.04	56.00	36.81	0.08	0.07	QP
10	0.611	20.41	-25.59	46.00	20.26	0.08	0.07	Average
11	1.827	36.33	-19.67	56.00	36.11	0.11	0.11	QP
12	1.827	23.78	-22.22	46.00	23.56	0.11	0.11	Average

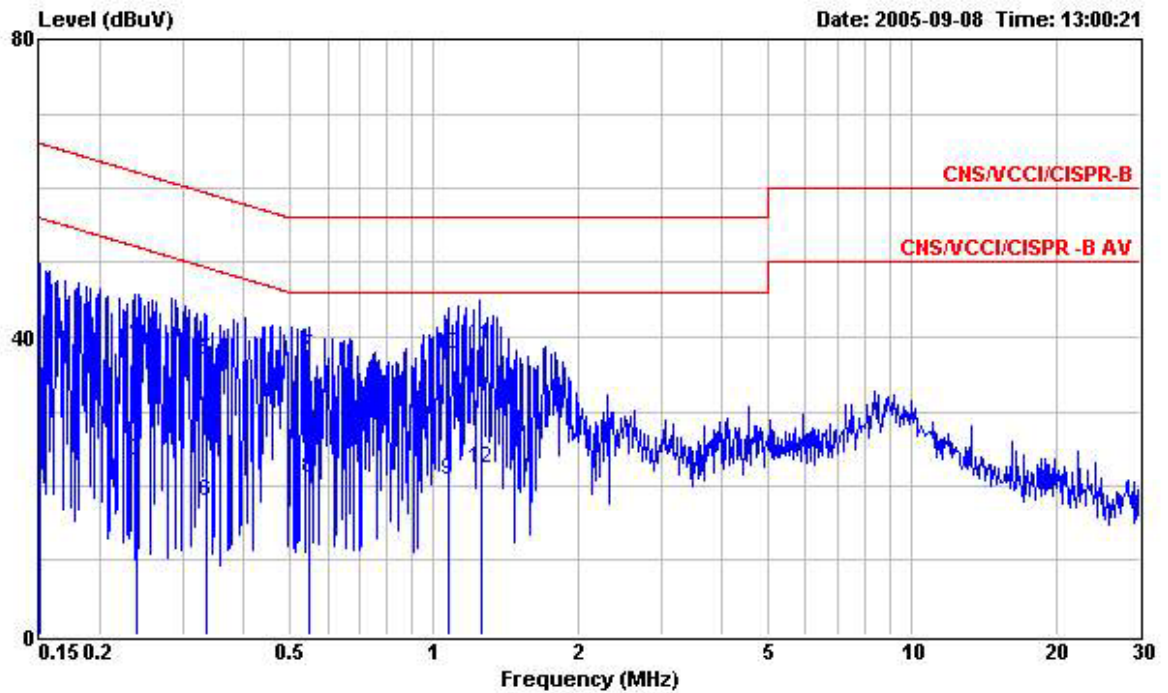

Site : CO01-HY
 Condition : CNS/VCCI/CISPR-B 2001/004 200505 NEUTRAL
 EUT : GSM Phone with GPRS and Bluetooth
 Power : 120V/60Hz
 Model : EW580903
 Memo : PCS 1900 IDLE+MP3+BT LINK+CHARGER
 Memo :
 Memo :

	Freq	Level	Over Limit	Limit Line	Read Level	Probe Factor	Cable Loss	Remark
	MHz	dBuV	dB	dBuV	dBuV	dB	dB	
1	0.150	40.33	-25.67	66.00	40.18	0.11	0.04	QP
2	0.150	26.38	-29.62	56.00	26.23	0.11	0.04	Average
3	0.240	23.28	-28.82	52.10	23.13	0.11	0.04	Average
4	0.240	39.67	-22.43	62.10	39.52	0.11	0.04	QP
5	0.336	36.94	-22.36	59.30	36.78	0.11	0.05	QP
6	0.336	17.79	-31.51	49.30	17.63	0.11	0.05	Average
7	0.546	37.32	-18.68	56.00	37.10	0.15	0.07	QP
8	0.546	21.01	-24.99	46.00	20.79	0.15	0.07	Average
9	1.070	20.76	-25.24	46.00	20.45	0.23	0.08	Average
10	1.070	37.66	-18.34	56.00	37.35	0.23	0.08	QP
11	1.257	38.91	-17.09	56.00	38.59	0.23	0.09	QP
12	1.257	22.46	-23.54	46.00	22.14	0.23	0.09	Average



5.8.4 Test Data

- Temperature : 26 °C
- Relating Humidity : 54 %
- Test Enginner : Jay
- Test Mode : Mode 2

The test that passed at minimum margin was marked by the frame in the following table.

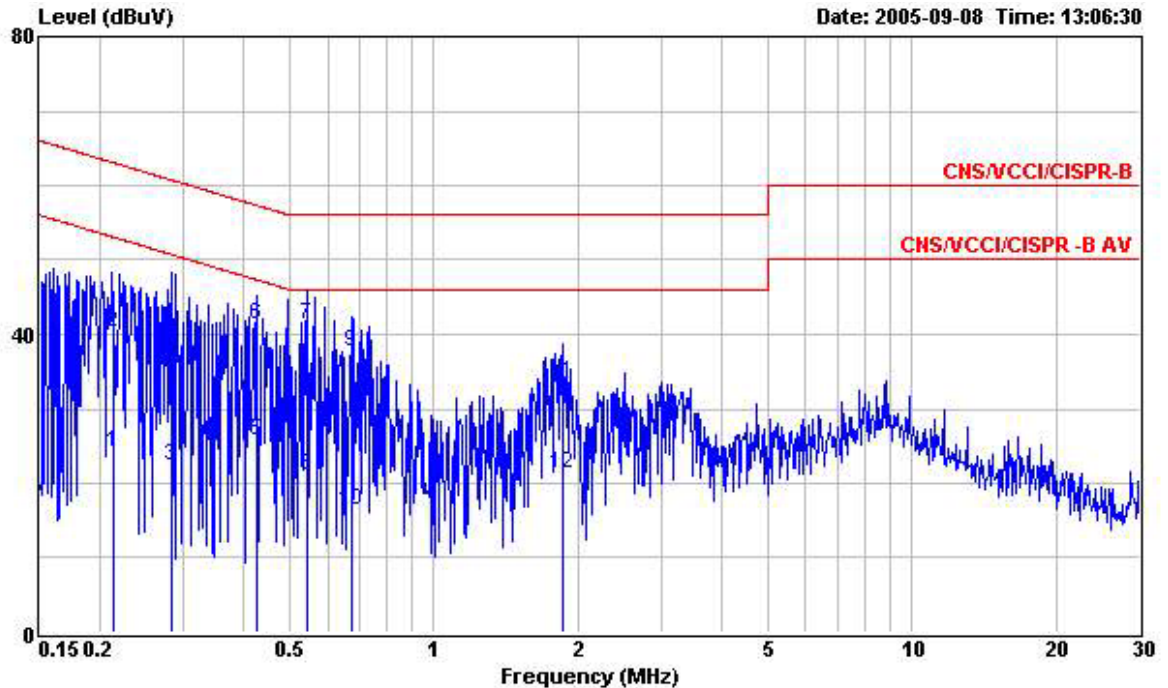

Site : CO01-HY
 Condition : CNS/VCCI/CISPR-B 2001/004 200505 LINE
 EUT : GSM Phone with GPRS and Bluetooth
 Power : 120V/60Hz
 Model : EW580903
 Memo : PCS 1900 IDLE+CAMERA+BT LINK+CHARGER
 Memo :
 Memo :

	Freq	Level	Over Limit	Limit Line	Read Level	Probe Factor	Cable Loss	Remark
	MHz	dBuV	dB	dBuV	dBuV	dB	dB	
1	0.213	24.09	-29.00	53.09	24.00	0.06	0.03	Average
2	0.213	40.23	-22.86	63.09	40.14	0.06	0.03	QP
3	0.283	22.43	-28.30	50.73	22.32	0.06	0.05	Average
4	0.283	39.54	-21.19	60.73	39.43	0.06	0.05	QP
5	0.426	25.73	-21.60	47.33	25.61	0.06	0.06	Average
6	0.426	41.35	-15.98	57.33	41.23	0.06	0.06	QP
7	0.544	41.30	-14.70	56.00	41.15	0.08	0.07	QP
8	0.544	21.13	-24.87	46.00	20.98	0.08	0.07	Average
9	0.672	37.65	-18.35	56.00	37.49	0.09	0.07	QP
10	0.672	16.40	-29.60	46.00	16.24	0.09	0.07	Average
11	1.860	33.44	-22.56	56.00	33.21	0.11	0.12	QP
12	1.860	21.31	-24.69	46.00	21.08	0.11	0.12	Average

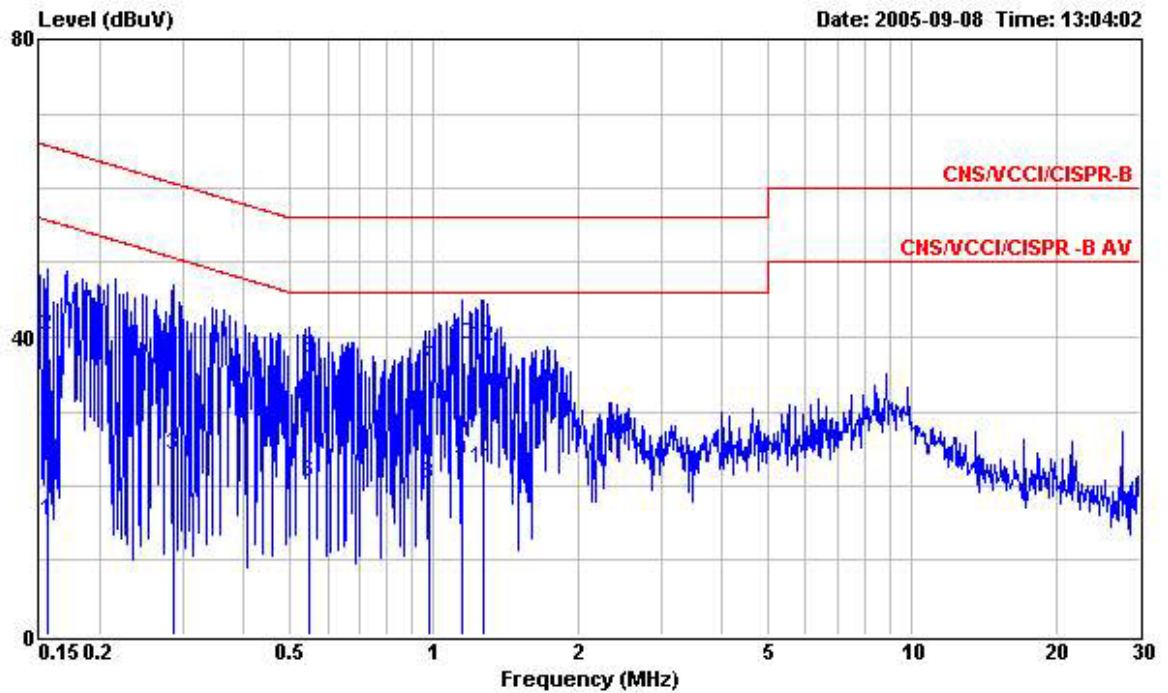

Site : CO01-HY
 Condition : CNS/VCCI/CISPR-B 2001/004 200505 NEUTRAL
 EUT : GSM Phone with GPRS and Bluetooth
 Power : 120V/60Hz
 Model : EW580903
 Memo : PCS 1900 IDLE+CAMERA+BT LINK+CHARGER
 Memo :
 Memo :

	Freq	Level	Over Limit	Limit Line	Read Level	Probe Factor	Cable Loss	Remark
	MHz	dBuV	dB	dBuV	dBuV	dB	dB	
1	0.156	15.39	-40.28	55.67	15.24	0.11	0.04	Average
2	0.156	40.19	-25.48	65.67	40.04	0.11	0.04	QP
3	0.286	24.20	-26.44	50.64	24.04	0.11	0.05	Average
4	0.286	38.36	-22.28	60.64	38.20	0.11	0.05	QP
5	0.549	37.26	-18.74	56.00	37.04	0.15	0.07	QP
6	0.549	20.44	-25.56	46.00	20.22	0.15	0.07	Average
7	0.979	35.93	-20.07	56.00	35.62	0.23	0.08	QP
8	0.979	20.23	-25.77	46.00	19.92	0.23	0.08	Average
9	1.150	23.28	-22.72	46.00	22.96	0.23	0.09	Average
10	1.150	38.90	-17.10	56.00	38.58	0.23	0.09	QP
11	1.270	22.39	-23.61	46.00	22.07	0.23	0.09	Average
12	1.270	38.70	-17.30	56.00	38.38	0.23	0.09	QP



5.9 Radiated Emission Measurement

5.9.1 Measuring Instruments

As described in chapter 6 of this Report.

5.9.2 Test Procedures

1. The EUT was placed on a rotatable table top 0.8 meter above ground.
2. The EUT was set 3 meters from the interference receiving antenna which was mounted on the top of a variable height antenna tower.
3. The table was rotated 360 degrees to determine the position of the highest radiation.
4. The antenna is a broadband antenna and its height is varied between one meter and four meters above ground to find the maximum value of the field strength for both horizontal polarization and vertical polarization of the antenna.
5. For each suspected emission, the EUT was arranged to its worst case and then tune the antenna tower (from 1 m to 4 m) and turntable (from 0 degree to 360 degrees) to find the maximum reading.
6. Set the test-receiver system to Peak or CISPR quasi-peak Detect Function and specified bandwidth with Maximum Hold Mode.
7. For testing below 1GHz, If the emission level of the EUT in peak mode was 3 dB lower than the limit specified, then testing will be stopped and peak values of EUT will be reported, otherwise, the emissions will be repeated one by one using the quasi-peak method and reported.
8. For testing above 1GHz, the emission level of the EUT in peak mode was 20dB lower than average limit (that means the emission level in average mode also complies with the limit in average mode), then testing will be stopped and peak values of EUT will be reported, otherwise, the emissions will be measured in average mode again and reported.

5.9.3 Typical Test Setup Layout of Radiated Emission

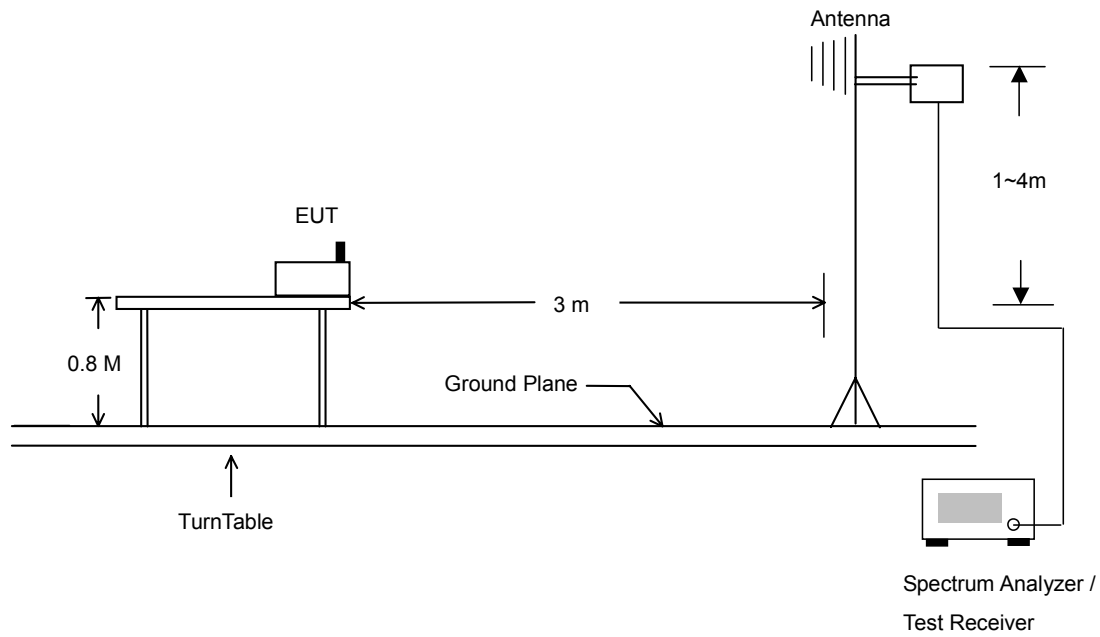



5.9.4 Test Data

- Temperature : 28 °C
- Relating Humidity : 64 %
- Test Engineer : Jay
- Test Mode : Mode 1
- Polarization : Horizontal

The test that passed at the minimum margin was marked by the frame in the following test record

	Freq	Level	Over Limit	Limit Line	ReadAntenna Level	Antenna Factor	Cable Loss	Preamp Factor	Ant Pos	Table Pos	Remark
	MHz	dBuV/m	dB	dBuV/m	dBuV	dB/m	dB	dB	cm	deg	
1 @	2390.00	39.07	-14.93	54.00	39.78	30.48	4.26	35.46	100	203	Average
2	2390.00	53.03	-20.97	74.00	53.74	30.48	4.26	35.46	100	0	Peak
3 @	2402.00	86.50			87.21	30.48	4.26	35.46	100	203	Average
4 @	2402.00	90.16			90.87	30.48	4.26	35.46	100	0	Peak
5 @	2500.00	39.11	-14.89	54.00	39.85	30.40	4.39	35.53	100	203	Average
6	2500.00	49.59	-24.41	74.00	50.32	30.40	4.39	35.53	100	0	Peak

Remark: #3 and #4 Fundamental Signal

- Test Mode : Mode 1
- Polarization : Vertical

The test that passed at minimum margin was marked by the frame in the following table.

	Freq	Level	Over Limit	Limit Line	ReadAntenna Level	Antenna Factor	Cable Loss	Preamp Factor	Ant Pos	Table Pos	Remark
	MHz	dBuV/m	dB	dBuV/m	dBuV	dB/m	dB	dB	cm	deg	
1	2390.00	53.05	-20.95	74.00	53.76	30.48	4.26	35.46	100	0	Peak
2 @	2390.00	39.06	-14.94	54.00	39.77	30.48	4.26	35.46	100	320	Average
3 @	2402.00	85.36			86.07	30.48	4.26	35.46	100	0	Peak
4 @	2402.00	82.48			83.19	30.48	4.26	35.46	100	320	Average
5	2484.00	49.50	-24.50	74.00	50.24	30.41	4.36	35.51	100	0	Peak
6 @	2484.00	39.00	-15.00	54.00	39.74	30.41	4.36	35.51	100	320	Average

Remark: #3 and #4 Fundamental Signal



- Test Mode : Mode 2
- Polarization : Horizontal

The test that passed at minimum margin was marked by the frame in the following table.

	Freq	Level	Over Limit	Limit Line	ReadAntenna Level	Antenna Factor	Cable Loss	Preamp Factor	Ant Pos	Table Pos	Remark
	MHz	dBuV/m	dB	dBuV/m	dBuV	dB/m	dB	dB	cm	deg	
1 @	109.38	25.50	-18.00	43.50	43.57	11.59	1.24	30.90	400	0	Peak
2 @	122.34	30.56	-12.94	43.50	48.13	12.49	1.51	31.56	123	207	Peak
3 @	133.68	28.64	-14.86	43.50	47.28	11.39	1.54	31.57	400	0	Peak

	Freq	Level	Over Limit	Limit Line	ReadAntenna Level	Antenna Factor	Cable Loss	Preamp Factor	Ant Pos	Table Pos	Remark
	MHz	dBuV/m	dB	dBuV/m	dBuV	dB/m	dB	dB	cm	deg	
1	780.90	27.40	-18.60	46.00	31.38	21.34	4.75	30.07	100	0	Peak
2	885.90	26.44	-19.56	46.00	31.24	20.23	5.54	30.56	100	0	Peak
3	997.90	29.19	-24.81	54.00	30.65	22.91	6.20	30.57	100	0	Peak

	Freq	Level	Over Limit	Limit Line	ReadAntenna Level	Antenna Factor	Cable Loss	Preamp Factor	Ant Pos	Table Pos	Remark
	MHz	dBuV/m	dB	dBuV/m	dBuV	dB/m	dB	dB	cm	deg	
1 @	2328.00	39.42	-14.58	54.00	40.12	30.54	4.17	35.40	100	224	Average
2	2328.00	50.29	-23.71	74.00	50.99	30.54	4.17	35.40	100	0	Peak
3 @	2441.00	84.21			84.94	30.44	4.33	35.49	100	224	Average
4 @	2441.00	89.48			90.21	30.44	4.33	35.49	100	0	Peak
5 @	2498.00	39.34	-14.66	54.00	40.08	30.40	4.39	35.53	100	224	Average
6	2498.00	50.08	-23.92	74.00	50.82	30.40	4.39	35.53	100	0	Peak

Remark: #3 and #4 Fundamental Signal



- Test Mode : Mode 2
- Polarization : Vertical

The test that passed at minimum margin was marked by the frame in the following table.

	Freq	Level	Over Limit	Limit Line	ReadAntenna Level	Antenna Factor	Cable Loss	Preamp Factor	Ant Pos	Table Pos	Remark
	MHz	dBuV/m	dB	dBuV/m	dBuV	dB/m	dB	dB	cm	deg	
1 @	30.54	24.92	-15.08	40.00	37.15	18.40	0.89	31.52	400	0	Peak
2 @	58.08	32.10	-7.90	40.00	55.19	7.21	1.13	31.43	100	97	Peak
3 @	132.33	28.70	-14.80	43.50	47.23	11.52	1.54	31.59	400	0	Peak

	Freq	Level	Over Limit	Limit Line	ReadAntenna Level	Antenna Factor	Cable Loss	Preamp Factor	Ant Pos	Table Pos	Remark
	MHz	dBuV/m	dB	dBuV/m	dBuV	dB/m	dB	dB	cm	deg	
1	768.30	26.89	-19.11	46.00	31.74	20.98	4.64	30.48	100	0	Peak
2	803.30	27.36	-18.64	46.00	30.87	21.84	4.91	30.26	100	0	Peak
3	988.80	29.17	-24.83	54.00	30.72	22.62	6.13	30.30	100	0	Peak

	Freq	Level	Over Limit	Limit Line	ReadAntenna Level	Antenna Factor	Cable Loss	Preamp Factor	Ant Pos	Table Pos	Remark
	MHz	dBuV/m	dB	dBuV/m	dBuV	dB/m	dB	dB	cm	deg	
1	2368.00	50.42	-23.58	74.00	51.12	30.51	4.23	35.44	100	0	Peak
2 @	2368.00	39.14	-14.86	54.00	39.84	30.51	4.23	35.44	171	319	Average
3 @	2441.00	88.34			89.07	30.44	4.33	35.49	100	0	Peak
4 @	2441.00	84.66			85.39	30.44	4.33	35.49	171	319	Average
5	2488.00	50.10	-23.90	74.00	50.86	30.40	4.36	35.51	100	0	Peak
6 @	2488.00	38.93	-15.07	54.00	39.68	30.40	4.36	35.51	171	319	Average

Remark: #3 and #4 Fundamental Signal

	Freq	Level	Over Limit	Limit Line	ReadAntenna Level	Antenna Factor	Cable Loss	Preamp Factor	Ant Pos	Table Pos	Remark
	MHz	dBuV/m	dB	dBuV/m	dBuV	dB/m	dB	dB	cm	deg	
1	4884.00	51.06	-22.94	74.00	47.53	33.39	6.30	36.16	200	360	Peak
2 @	4884.00	45.53	-8.47	54.00	42.00	33.39	6.30	36.16	184	207	Average



- Test Mode : Mode 3
- Polarization : Horizontal

The test that passed at minimum margin was marked by the frame in the following table.

	Freq	Level	Over Limit	Limit Line	ReadAntenna Level	Antenna Factor	Cable Loss	Preamp Factor	Ant Pos	Table Pos	Remark
	MHz	dBuV/m	dB	dBuV/m	dBuV	dB/m	dB	dB	cm	deg	
1	2328.00	50.19	-23.81	74.00	50.89	30.54	4.17	35.40	100	0	Peak
2	2328.00	39.35	-14.65	54.00	40.05	30.54	4.17	35.40	100	196	Average
3 X	2480.00	89.17			89.91	30.41	4.36	35.51	100	0	Peak
4 @	2480.00	85.46			86.20	30.41	4.36	35.51	100	196	Average
5 !	2483.50	68.60	-5.40	74.00	69.34	30.41	4.36	35.51	100	0	Peak
6 !	2483.50	50.52	-3.48	54.00	51.26	30.41	4.36	35.51	100	196	Average

Remark: #3 and #4 Fundamental Signal.

- Test Mode : Mode 3
- Polarization : Vertical

The test that passed at minimum margin was marked by the frame in the following table.

	Freq	Level	Over Limit	Limit Line	ReadAntenna Level	Antenna Factor	Cable Loss	Preamp Factor	Ant Pos	Table Pos	Remark
	MHz	dBuV/m	dB	dBuV/m	dBuV	dB/m	dB	dB	cm	deg	
1	2344.00	49.76	-24.24	74.00	50.45	30.52	4.20	35.42	100	0	Peak
2 @	2344.00	39.22	-14.78	54.00	39.92	30.52	4.20	35.42	100	319	Average
3 @	2480.00	88.00			88.74	30.41	4.36	35.51	100	0	Peak
4 @	2480.00	84.41			85.15	30.41	4.36	35.51	100	319	Average
5 @	2483.50	65.84	-8.16	74.00	66.58	30.41	4.36	35.51	100	0	Peak
6 @	2483.50	49.61	-4.39	54.00	50.35	30.41	4.36	35.51	100	319	Average

Remark: #3 and #4 Fundamental Signal

	Freq	Level	Over Limit	Limit Line	ReadAntenna Level	Antenna Factor	Cable Loss	Preamp Factor	Ant Pos	Table Pos	Remark
	MHz	dBuV/m	dB	dBuV/m	dBuV	dB/m	dB	dB	cm	deg	
1	4958.00	53.32	-20.68	74.00	49.47	33.68	6.39	36.23	200	360	Peak
2 @	4958.00	46.23	-7.77	54.00	42.38	33.68	6.39	36.23	143	274	Average



5.10 Antenna Requirements

5.10.1 Standard Applicable

For intentional device, according to FCC 47 CFR Section 15.203, an intentional radiator shall be designed to ensure that no other antenna except assembled by the responsible party shall be used with the device.

And according to FCC 47 CFR Section 15.247 (b), if directional gain of transmitting antennas is greater than 6dBi, the power shall be reduced by the same level in dB comparing to gain minus 6dBi.

5.10.2 Antenna Connected Construction

The antenna used in this product is a Embedded Antenna without connector and it is considered to meet antenna requirement of FCC.



6. List of Measuring Equipments Used

Instrument	Manufacturer	Model No.	Serial No.	Characteristics	Calibration Date	Due Date	Remark
EMC Receiver	R&S	ESCS 30	100174	9kHz – 2.75GHz	Feb. 19, 2005	Feb. 19, 2006	Conduction (CO01-HY)
LISN	MessTec	NNB-2/16 Z	2001/009	9kHz – 30MHz	Apr. 26, 2005	Apr. 26, 2006	Conduction (CO01-HY)
LISN (Support Unit)	MessTec	NNB-2/16 Z	2001/008	9kHz – 30MHz	May 06, 2005	May 06, 2006	Conduction (CO01-HY)
EMI Filter	LINDGREN	LRE-2060	1004	< 450Hz	N/A	N/A	Conduction (CO01-HY)
EMI Filter	LINDGREN	N6006	201052	0 – 60Hz	N/A	N/A	Conduction (CO01-HY)
RF Cable-CON	Suhner Switzerland	RG223/U	CB029	9kHz – 30MHz	Dec. 23, 2004	Dec. 23, 2005	Conduction (CO01-HY)
Spectrum analyzer	Agilent	E4408B	MY44211030	9KHz-26.5GHz	Jul. 27, 2004	Jul. 27, 2006	Radiation (03CH06-HY)
Receiver	R&S	ESCS30	100356	9KHz-2.75GHz	Jul. 09,2004	Jul. 09,2006	Radiation (03CH06-HY)
Controller	CT	SC100	N/A	N/A	N/A	N/A	Radiation (03CH06-HY)
Bilog Antenna	SCHAFFNER	CBL6112B	2885	30MHz -2GHz	Nov. 22, 2004	Nov. 22, 2005	Radiation (03CH06-HY)
Horn Antenna	Com-Power	AH118	071025	1G-18G	Feb. 22, 2005	Feb. 22, 2006	Radiation (03CH06-HY)
SHF-EHF Horn	SCHWARZBECK	BBHA 9170	9170-249	14G - 40G	Jul. 21, 2005	Jul. 20, 2006	Radiation (03CH06-HY)
HF Amplifier	MITEQ	AFS44	973248	0.1G - 26.5G	Dec. 17, 2004	Dec. 17, 2005	Radiation (03CH06-HY)
Amplifier	MITEQ	AMF-6F	997165	26G - 40G	Jul. 21, 2005	Jul. 20, 2006	Radiation (03CH06-HY)
Turn Table	HD	DS 420	420/650/00	0 ~ 360 degree	N/A	N/A	Radiation (03CH06-HY)
Antenna Mast	HD	MA 240	240/560/00	1 m - 4 m	N/A	N/A	Radiation (03CH06-HY)



7. Uncertainty Evaluation

Uncertainty of Radiated Emission Evaluation (30MHz ~ 1000MHz)

Contribution	Uncertainty of x_i		$u(x_i)$
	dB	Probability Distribution	
Receiver reading	0.41	Normal(k=2)	0.21
Antenna factor calibration	0.83	Normal(k=2)	0.42
Cable loss calibration	0.25	Normal(k=2)	0.13
Pre Amplifier Gain calibration	0.27	Normal(k=2)	0.14
RCV/SPA specification	2.50	Rectangular	0.72
Antenna Factor Interpolation for Frequency	1.00	Rectangular	0.29
Site imperfection	1.43	Rectangular	0.83
Mismatch Receiver VSWR $\Gamma_1 = 0.20$ Antenna VSWR $\Gamma_2 = 0.23$ Uncertainty = $20\log(1 - \Gamma_1 * \Gamma_2)$	+0.39/-0.41	U-shaped	0.28
combined standard uncertainty $U_c(y)$	1.27		
Measuring uncertainty for a level of confidence of 95% $U = 2U_c(y)$	2.54		

Uncertainty of Radiated Emission Evaluation (1GHz ~ 40GHz)

Contribution	Uncertainty of x_i		$u(x_i)$	C_i	$C_i * u(x_i)$
	dB	Probability Distribution			
Receiver reading	± 0.10	Normal(k=1)	0.10	1	0.10
Antenna factor calibration	± 1.70	Normal(k=2)	0.85	1	0.85
Cable loss calibration	± 0.50	Normal(k=2)	0.25	1	0.25
Receiver Correction	± 2.00	Rectangular	1.15	1	1.15
Antenna Factor Directional	± 1.50	Rectangular	0.87	1	0.87
Site imperfection	± 2.80	Triangular	1.14	1	1.14
Mismatch Receiver VSWR $\Gamma_1 = 0.197$ Antenna VSWR $\Gamma_2 = 0.194$ Uncertainty = $20\log(1 - \Gamma_1 * \Gamma_2 * \Gamma_3)$	+0.34/-0.35	U-shaped	0.244	1	0.244
Combined standard uncertainty $U_c(y)$	2.36				
Measuring uncertainty for a level of confidence of 95% $U = 2U_c(y)$	4.72				