

# FCC TEST REPORT

for

**47 CFR Part 24E**

**Equipment** : GSM Tri-band Phone with GPRS  
**Trade Name** : TOSHIBA  
**Model No.** : CD3-E01 (TS10/GS10)  
**FCC ID** : HFS-CD3-E01  
**Tx Frequency Range** : PCS 1900: 1850.2~1909.8MHz  
**Max. RF Output Power** : PCS 1900: 1.69W  
**Emission Designator** : 300 KGXW  
**Applicant** : **Quanta Computer Inc.**  
No. 188, Wen Hwa 2nd Rd., Kuei Shan Hsiang,  
Tao Yuan Shien, Taiwan, R.O.C.

- The test result refers exclusively to the test presented test model / sample.
- Without written approval of SPORTON International Inc., the test report shall not be reproduced except in full.
- **Certificate or Test Report must not be used by the applicant to claim the product in this test report endorsement by NVLAP or any agency of U.S. government.**
- The data shown in this test report were carried out on Jul. 30, 2005 at **Sporton International Inc. LAB.**

  
Dr. Daniel Lee  
EMC/SAR Manager

**SPORTON International Inc.**

6F, No.106, Sec. 1, Hsin Tai Wu Rd., Hsi Chih, Taipei Hsien, Taiwan, R.O.C.

**SPORTON International Inc.**

TEL : 886-2-2696-2468

FAX : 886-2-2696-2255



# Table of Contents

**History of this test report.....ii**

**1. General Information ..... 1**

    1.1. Applicant..... 1

    1.2. Manufacturer..... 1

    1.3. Basic Description of Equipment under Test..... 1

    1.2 Feature of Equipment under Test..... 2

    1.3 Report Date ..... 2

**2 Test Configuration of Equipment under Test.....3**

    2.1 Test Manner..... 3

    2.2 Test Mode..... 3

    2.3 Connection Diagram of Test System ..... 3

    2.4 Ancillary Equipment List..... 3

**3. General Information of Test Site .....4**

    3.1 Test Voltage..... 4

    3.2 Test in Compliance with ..... 4

    3.3 Frequency Range Investigated..... 4

    3.4 Test Distance..... 4

**4. Test Data and Test Result.....5**

    4.1 List of Measurements and Examinations..... 5

    4.2 RF Output Power ..... 6

    4.3 ERP / EIRP Measurement..... 7

    4.4 Occupied Bandwidth and Band Edge Measurement..... 9

    4.5 Conducted Emission ..... 14

    4.6 Field Strength of Spurious Radiation ..... 20

    4.7 Frequency Stability (Temperature Variation) ..... 24

    4.8 Frequency Stability (Voltage Variation) ..... 26

**5 List of Measurement Equipments .....27**

**6 Uncertainty Evaluation.....28**

**Appendix A. Photographs of EUT External**

**Appendix B. Photographs of EUT Internal**

**Appendix C. Photographs of Setup**



History of this test report

Report Issue Date: Aug. 01, 2005

Original Report Issue Date	Description



## 1. General Information

### 1.1. Applicant

**Quanta Computer Inc.**

No. 188, Wen Hwa 2nd Rd., Kuei Shan Hsiang, Tao Yuan Shien, Taiwan, R.O.C.

### 1.2. Manufacturer

**Quanta Computer Inc.**

No. 188, Wen Hwa 2nd Rd., Kuei Shan Hsiang, Tao Yuan Shien, Taiwan, R.O.C.

### 1.3. Basic Description of Equipment under Test

Equipment	: GSM Tri-band Phone with GPRS
Trade Name	: TOSHIBA
Model No.	: CD3-E01 (TS10/GS10)
FCC ID	: HFS-CD3-E01
Power Supply Type	: DC 3.7V
Earphone	: Merry CO. LTD, Vendor – EMC143-036
Charger	: PI CO. LTD, Vendor – P925BW05050
Battery	: Foxlink CO. LTD, Vendor – SI4

**1.2 Feature of Equipment under Test**

<b>DUT Type :</b>	GSM Tri-band Phone with GPRS
<b>Trade Name :</b>	TOSHIBA
<b>Model Name :</b>	CD3-E01 (TS10/GS10)
<b>FCC ID :</b>	HFS-CD3-E01
<b>Tx Frequency :</b>	1850.2~1909.8MHz
<b>Rx Frequency :</b>	1930~1989.8MHz
<b>Antenna Type :</b>	Fixed Internal
<b>Maximum Output Power to Antenna :</b>	29.49 dBm
<b>Maximum EIRP :</b>	1.69 W (32.29 dBm)
<b>HW Version :</b>	B1A
<b>SW Version :</b>	050624n-08.00SI4.BOI-0.06 DTPWM
<b>Power Rating (DC/AC Voltage) :</b>	3.8V/140mA
<b>Digital Modulation Emission :</b>	GMSK
<b>Type of Emission :</b>	300 KGXW
<b>DUT Stage :</b>	Production Unit

**1.3 Report Date**

EUT Received : Jul. 08, 2005

Report Date : Aug. 01, 2005

## 2 Test Configuration of Equipment under Test

### 2.1 Test Manner

- a. The spurious emission measurements were carried out in semi-anechoic chamber with 3-meter test range.
- b. During all testings, EUT is in link mode with base station emulator at maximum power level. (PCL=0 for PCS 1900)
- c. Frequency range investigated: radiated emission 30MHz to 19000 MHz for PCS 1900.

### 2.2 Test Mode

<b>Application</b>	<b>PCS 1900</b>
Radiated Emission	<input checked="" type="checkbox"/> Mode 1: CH 661
Conducted Measurement	<input checked="" type="checkbox"/> Mode 1: CH 661

### 2.3 Connection Diagram of Test System

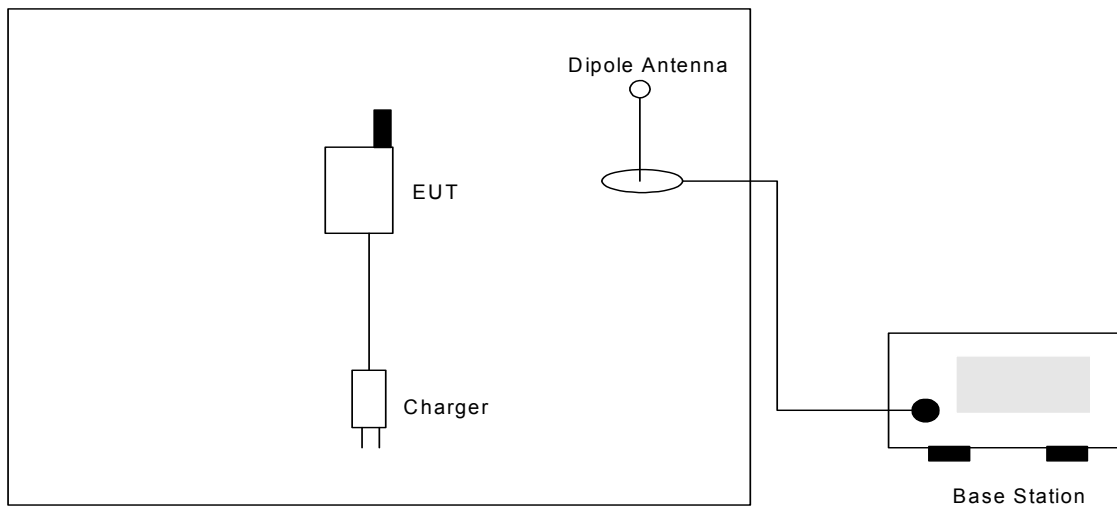

### 2.4 Ancillary Equipment List

Item	Equipment	Model No.	Serial No.
1.	Base Station	CMU200	105934



### **3. General Information of Test Site**

Test Site Location : No. 52, Hwa Ya 1st Rd., Hwa Ya Technology Park,  
Kwei-Shan Hsiang, Tao Yuan Hsien, Taiwan, R.O.C.  
TEL : 886-3-327-3456  
FAX : 886-3-318-0055

Test Site No : 03CH06-HY

The chamber meets the characteristics of ANSI C63.4-2003. This site is on file with the FCC. The Industry Canada file number for this site is IC 4088.

#### **3.1 Test Voltage**

120V/ 60Hz

#### **3.2 Test in Compliance with**

47 CFR Part 24E

#### **3.3 Frequency Range Investigated**

a. Radiation: from 30 MHz to 19000 MHz for PCS 1900.

#### **3.4 Test Distance**

The test distance of radiated emission from antenna to EUT is 3 m.

**4. Test Data and Test Result****4.1 List of Measurements and Examinations**

FCC Rule	IC RULE	DESCRIPTION OF TEST	Result	Section
§2.1046	RSS-133 § 6.2	RF Output Power	Passed	4.2
§24.232	RSS-133 § 6.2	ERP / EIRP	Passed	4.3
§2.1049, § 24.238(b)	RSS-133 § 6.3	Occupied Bandwidth & Band Edge Measurement	Passed	4.4
§2.1051	RSS-133 § 6.3	Conducted Emission	Passed	4.5
§2.1053	RSS-133 § 6.3	Field Strength of Spurious Radiation	Passed	4.6
§2.1055, §24.235	RSS-133 § 7	Frequency Stability vs. Temperature	Passed	4.7
§2.1055, §24.235	RSS-133 § 7	Frequency Stability vs. Voltage	Passed	4.8



## 4.2 RF Output Power

### 4.2.1 Measurement Instruments :

As described in chapter 5 of this test report.

### 4.2.2 Test Procedure :

1. The transmitter output was connected to power meter and base station through power divider.
2. Set EUT at PCL=0 for PCS 1900 through base station.
3. Select lowest, middle, and highest channels for each band.

### 4.2.3 Test Setup Layout :

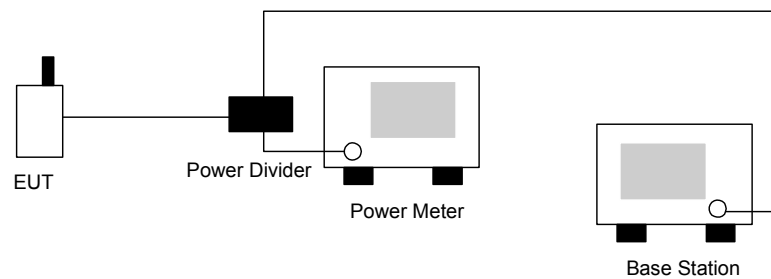

### 4.2.4 Test Result :

Bands	Channel	Frequency (MHz)	Conducted Power (dBm)	Conducted Power (Watts)
PCS 1900	512	1850.2 (Low)	29.49	0.889
	661	1880.0 (Mid)	29.19	0.830
	810	1909.8 (High)	28.96	0.787



### **4.3 ERP / EIRP Measurement**

Equivalent isotropic radiated power measurements by substitution method according to ANSI/TIA/EIA-603-A.

#### **4.3.1 Measurement Instruments**

As described in chapter 5 of this test report.

#### **4.3.2 Test Procedure**

1. The EUT was placed on a rotatable table with 1.5 meter height.
2. The EUT was set 3 meters from the receiving antenna which was mounted on the antenna tower.
3. The table was rotated 360 degrees to determine the position of the highest radiated power.
4. The height of the receiving antenna is also kept at 1.5m height.
5. Taking the record of maximum ERP/EIRP.
6. A Horn antenna was substituted in place of the EUT and was driven by a signal generator.
7. The conducted power at the terminal of the Horn antenna is measured.
8. Repeat step 3 to step 5 to get the maximum ERP/EIRP of the substitution antenna.

9.  $ERP/EIRP = P_s + E_t - E_s + G_s = P_s + R_t - R_s + G_s$

$P_s$  (dBm): Input power to substitution antenna.

$G_s$  (dBi or dBd): Substitution antenna Gain.

$$E_t = R_t + AF$$

$$E_s + R_s + AF$$

$AF$  (dB/m): Receive antenna factor

10.  $R_t$ : the highest received signal in Spectrum Analyzer for EUT.

4.3.3 Test Setup Layout of ERP/EIRP

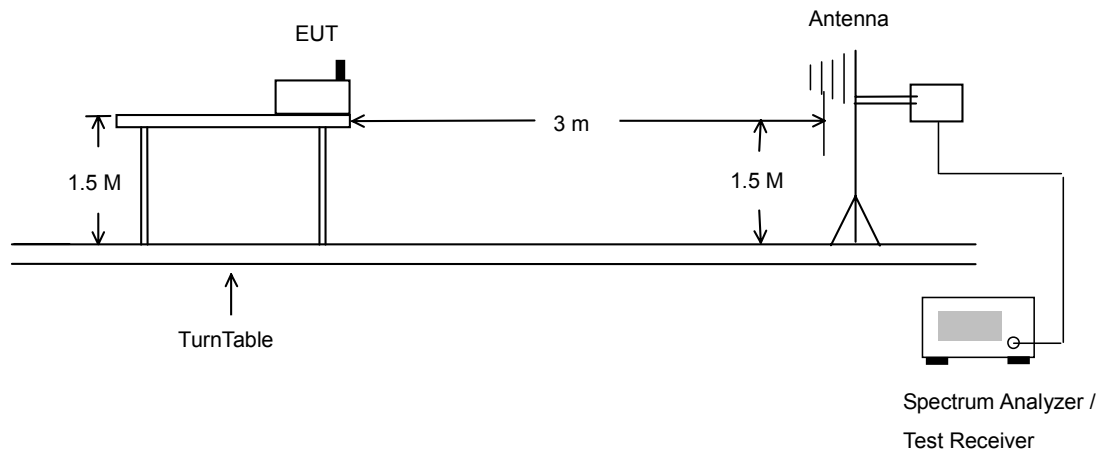

4.3.4 Test Result

PCS1900 Radiated Power EIRP					
H Polarization			V Polarization		
Frequency (MHz)	EIRP (dBm)	EIRP (Watts)	Frequency (MHz)	EIRP (dBm)	EIRP (Watts)
1850.220	26.450	0.44	1850.190	31.570	1.44
1879.970	26.910	0.49	1879.970	32.240	1.67
1909.720	27.180	0.52	1909.690	32.290	1.69

## 4.4 Occupied Bandwidth and Band Edge Measurement

### 4.4.1 Measurement Instruments

As described in chapter 5 of this test report.

### 4.4.2 Test Procedure

1. The EUT was connected to Spectrum Analyzer and Base Station via power divider.
2. The occupied bandwidth of middle channel for the highest and lowest RF powers were measured.
3. The bandedge of low and high channels for the highest RF powers within the transmitting frequency band were measured. Setting RBW as roughly  $BW/10$ .

### 4.4.3 Test Setup Layout

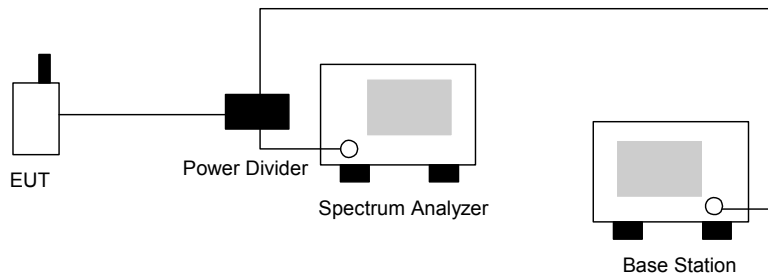



4.4.4 Test Result

- Test Mode : PCS 1900 CH512 Lower Band Edge
- Power State : High

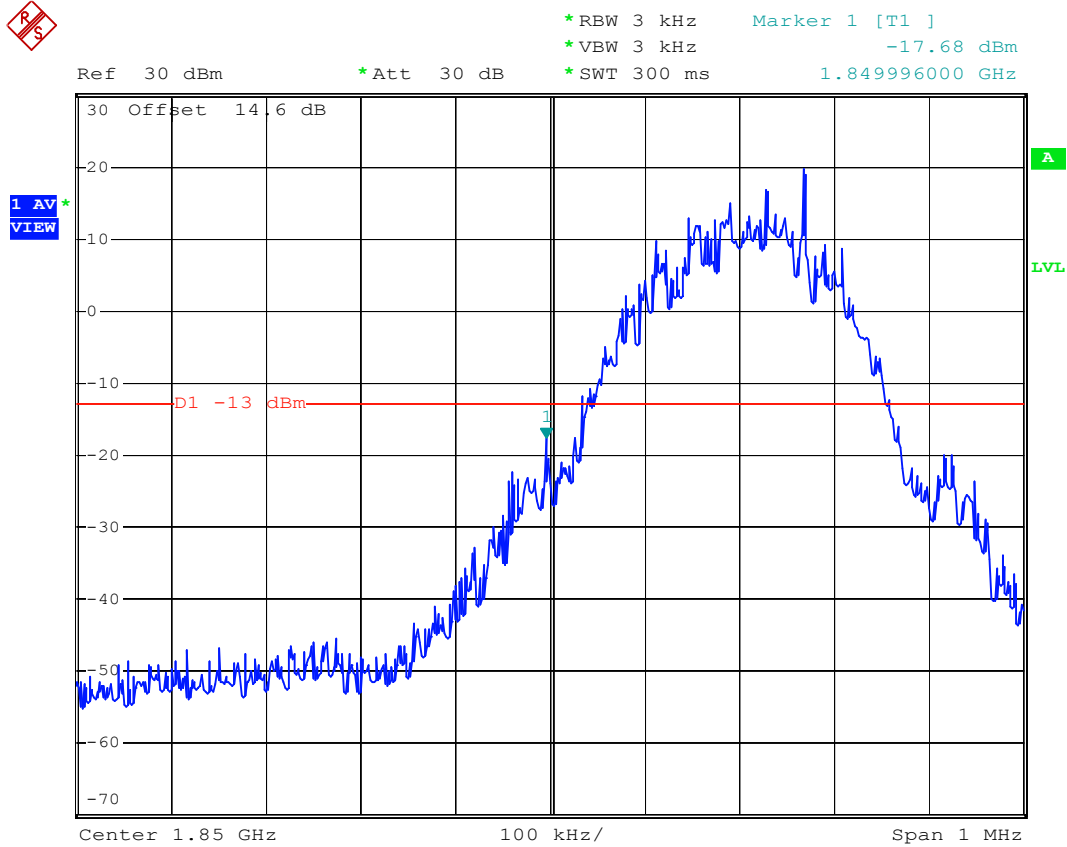

Date: 31.JUL.2005 02:47:42



- Test Mode : PCS 1900 CH661 99% Occupied Bandwidth
- Power State : Low

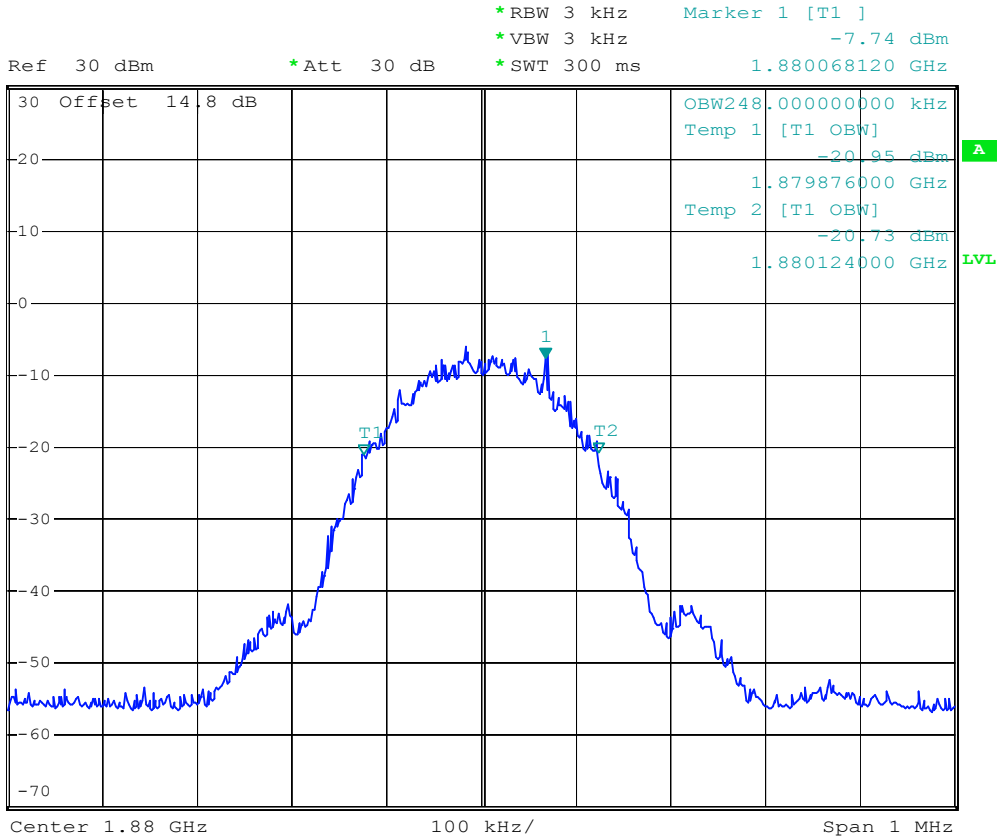

Date: 30.JUL.2005 13:18:53



- Test Mode : PCS 1900 CH661 99% Occupied Bandwidth
- Power State : High

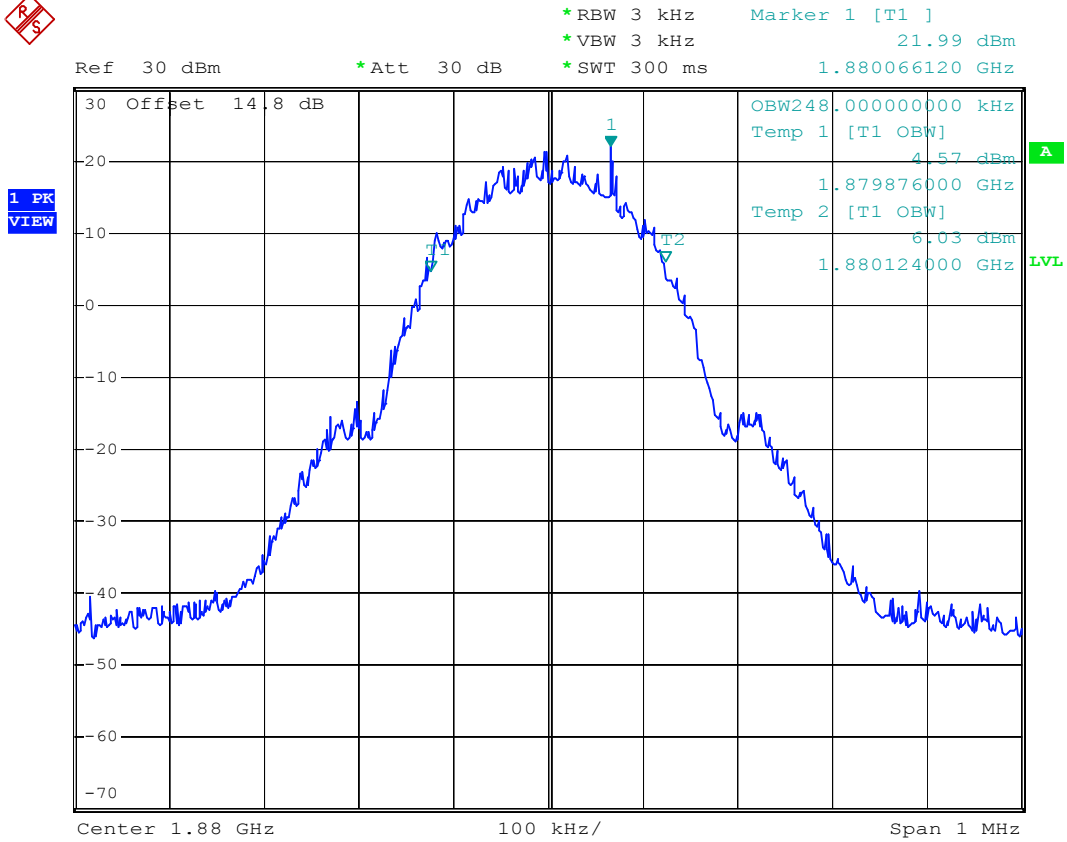

Date: 30.JUL.2005 13:16:13



- Test Mode : PCS 1900 CH810 Higher Band Edge
- Power State : High

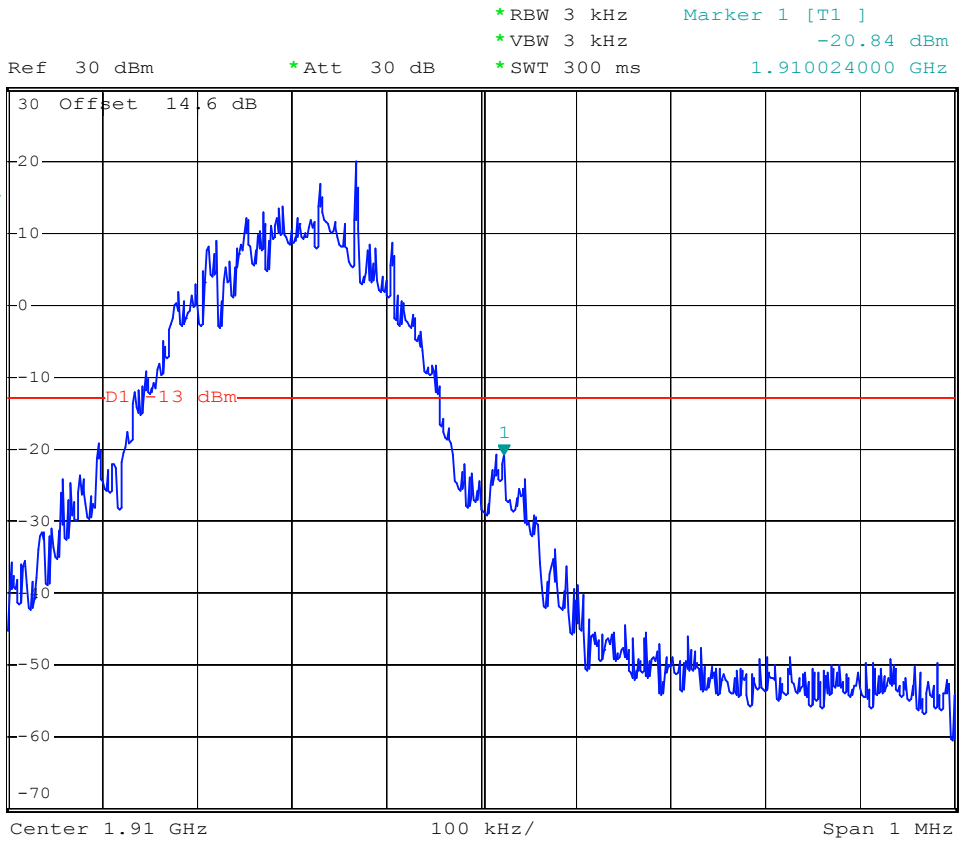

Date: 31.JUL.2005 02:49:28



## 4.5 Conducted Emission

### 4.5.1 Measurement Instruments

As described in chapter 5 of this test report.

### 4.5.2 Test Procedure

1. The EUT was connected to Spectrum Analyzer and Base Station via power divider.
2. The middle channel for the highest RF power within the transmitting frequency was measured.
3. The conducted spurious emission for the whole frequency range was taken.

### 4.5.3 Test Setup Layout

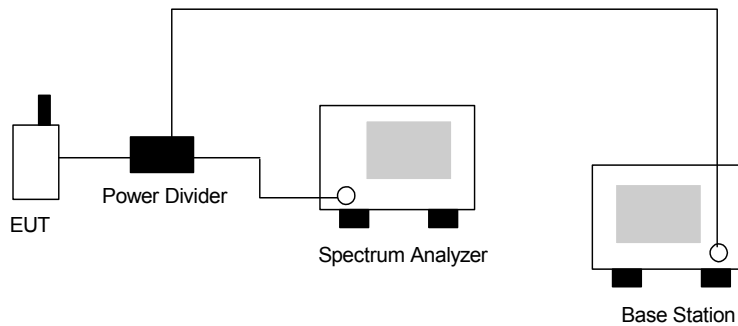



4.5.4 Test Result

- Test Mode : PCS 1900 CH661
- Frequency Range : 0.3G-1G

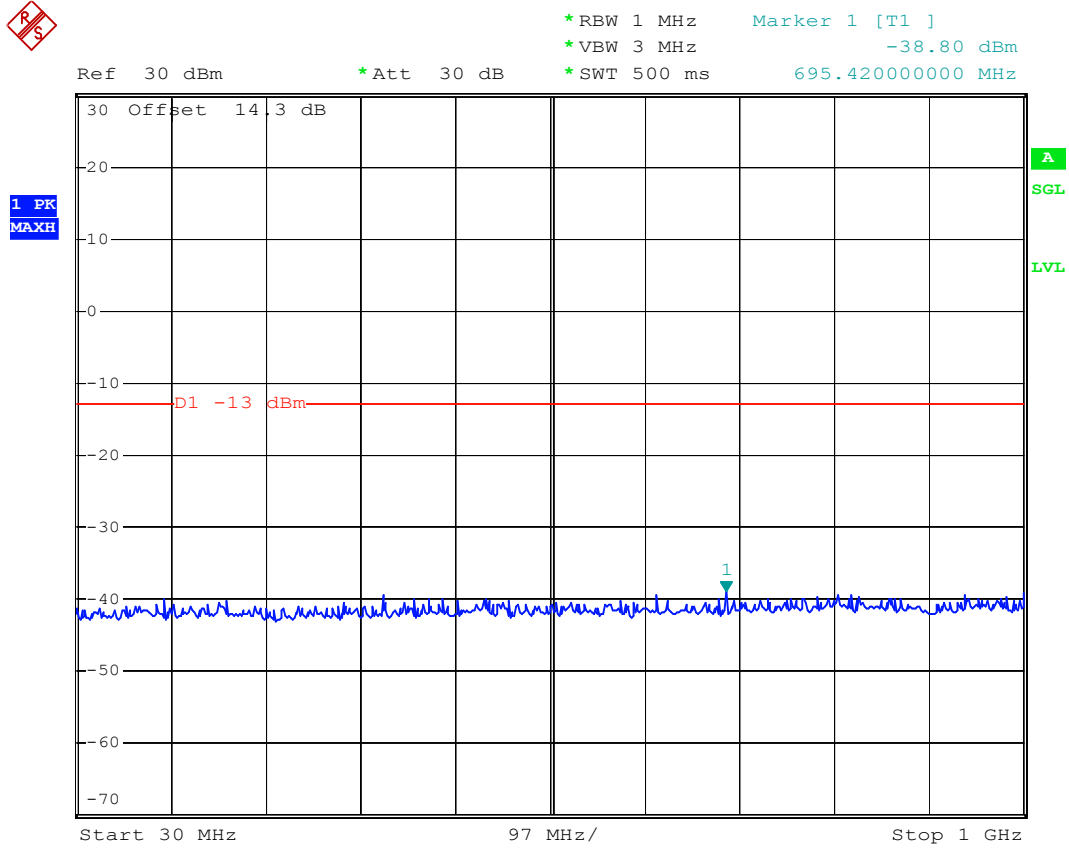

Date: 30.JUL.2005 14:24:35



- Test Mode : PCS 1900 CH661
- Frequency Range : 1G-3G

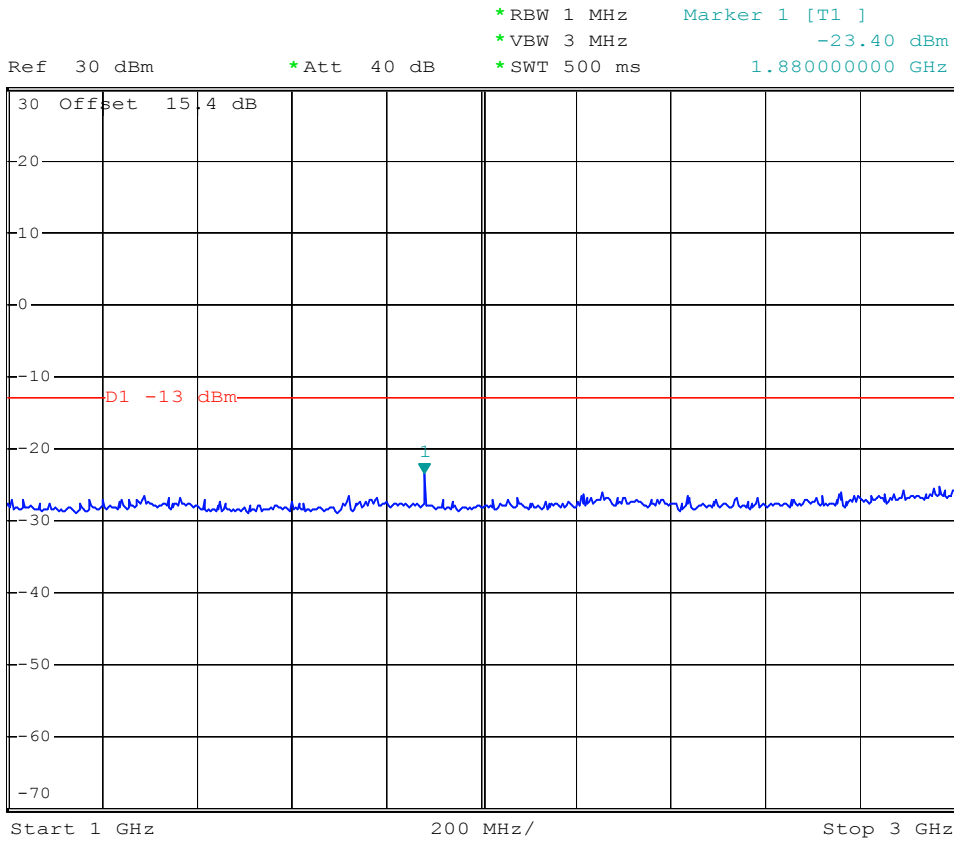

Date: 31.JUL.2005 02:36:57



- Test Mode : PCS 1900 CH661
- Frequency Range : 3G-7G

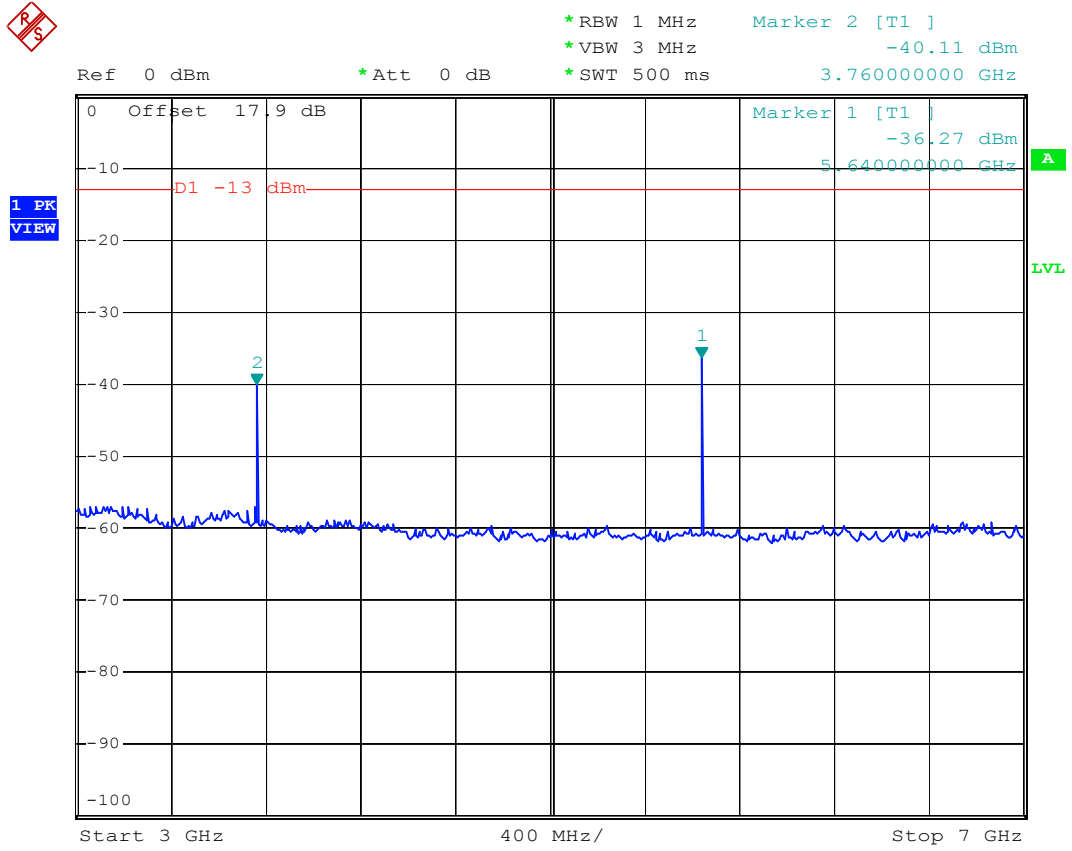

Date: 30.JUL.2005 13:54:40



- Test Mode : PCS 1900 CH661
- Frequency Range : 7G-13.6G

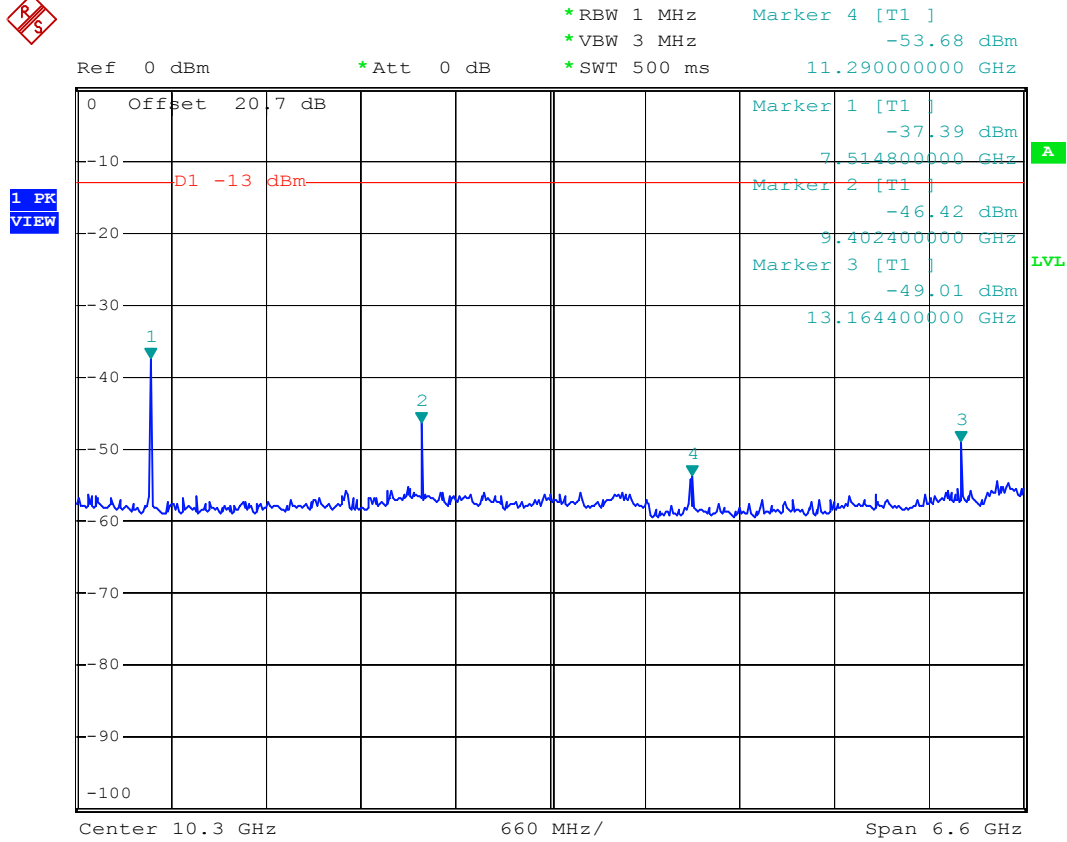

Date: 31.JUL.2005 02:42:49



- Test Mode : PCS 1900 CH661
- Frequency Range : 13.6G-19.1G

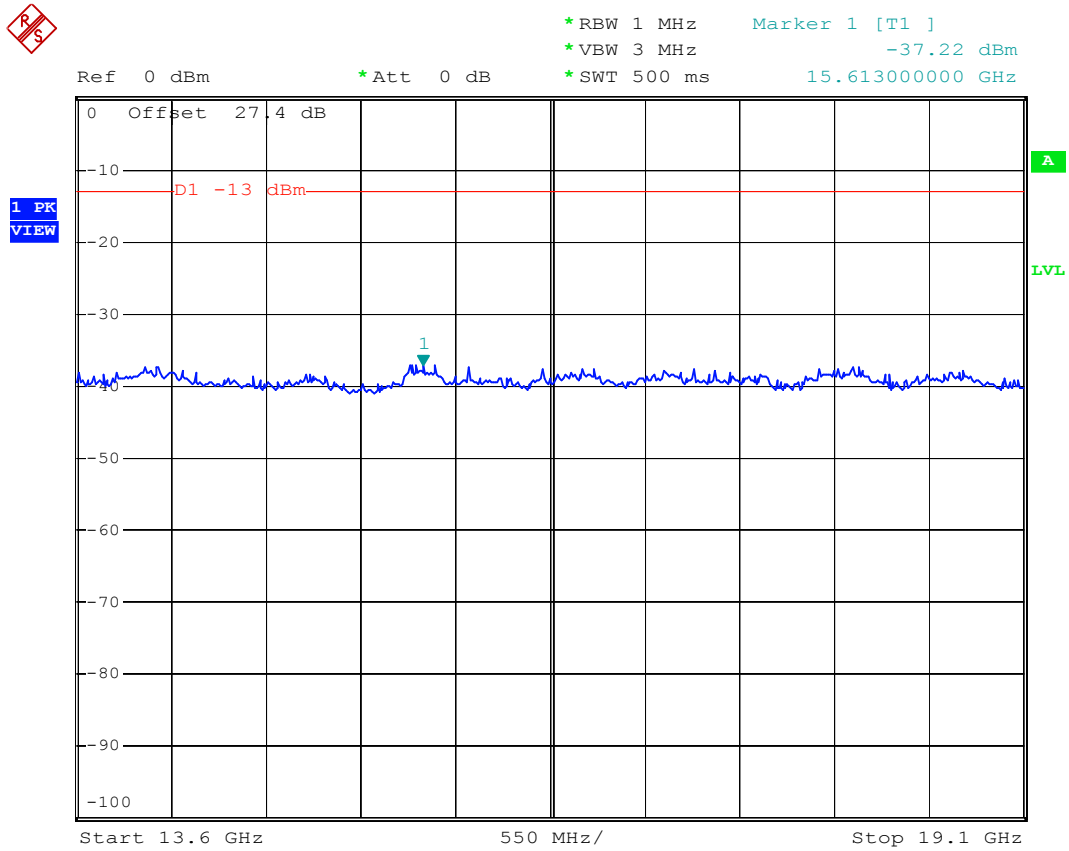

Date: 30.JUL.2005 14:39:56



## **4.6 Field Strength of Spurious Radiation**

Equivalent isotropic radiated Power Measurements by substitution method according to ANSI/TIA/EIA-603-A.

### **4.6.1 Measurement Instruments**

As described in chapter 5 of this test report.

### **4.6.2 Test Procedure**

1. The EUT was placed on a rotatable wooden table with 0.8 meter about ground.
2. The EUT was set 3 meters from the receiving antenna which was mounted on the antenna tower.
3. The table was rotated 360 degrees to determine the position of the highest spurious emission.
4. The height of the receiving antenna is varied between one meter and four meters to reach the maximum spurious emission for both horizontal and vertical polarizations.
5. Taking the record of maximum spurious emission.
6. A Horn antenna was substituted in place of the EUT and was driven by a signal generator.
7. Tune the output power of signal generator to the same emission level with EUT maximum spurious emission.
8. Taking the recored of output power at antenna port.
9. Repeat step 7 to step 8 for another polariztion.
10. Emission level (dBm) = output power + substituion Gain.

### **4.6.3 Test Setup Layout**

As the setup in section 4.3.3.



4.6.4 Test Result

- Test Mode : Mode 1

PCS1900 Radiated Spurious EIRP							
H Polarization				V Polarization			
Frequency (MHz)	EIRP (dBm)	Limit (dBm)	Margin (dB)	Frequency (MHz)	EIRP (dBm)	Limit (dBm)	Margin (dB)
31.080	-59.06	-13	-46.1	58.890	-64.97	-13	-52.0
918.800	-61.31	-13	-48.3	610.800	-60.01	-13	-47.0
1718.000	-48.29	-13	-35.3	1718.000	-51.02	-13	-38.0
7518.000	-42.92	-13	-29.9	2418.000	-53.08	-13	-40.1
<b>9398.000</b>	<b>-39.09</b>	<b>-13</b>	<b>-26.1</b>	3758.000	-48.13	-13	-35.1
				7518.000	-44.84	-13	-31.8
				9398.000	-39.54	-13	-26.5





4.6.5 Test Data

4.6.5.1 Mode 1

Horizontal Polarization

	Freq	Level	Over Limit	Limit Line	Read Level	Remark
	MHz	dBm	dB	dBm	dBm	
1 @	31.08	-59.06	-46.06	-13.00	-58.81	Peak

	Freq	Level	Over Limit	Limit Line	Read Level	Remark
	MHz	dBm	dB	dBm	dBm	
1	918.80	-61.31	-48.31	-13.00	-60.76	Peak

	Freq	Level	Over Limit	Limit Line	Read Level	Remark
	MHz	dBm	dB	dBm	dBm	
1 @	1718.00	-48.29	-35.29	-13.00	-48.37	Peak
2 @	1878.00	-50.15	-37.15	-13.00	-49.64	Peak
3 @	2038.00	-55.11	-42.11	-13.00	-54.38	Peak

	Freq	Level	Over Limit	Limit Line	Read Level	Remark
	MHz	dBm	dB	dBm	dBm	
1 @	7518.00	-42.92	-29.92	-13.00	-58.72	Peak

	Freq	Level	Over Limit	Limit Line	Read Level	Remark
	MHz	dBm	dB	dBm	dBm	
1 @	9398.00	-39.09	-26.09	-13.00	-57.31	Peak



Vertical Polarization

	Freq	Level	Over Limit	Limit Line	Read Level	Remark
	MHz	dBm	dB	dBm	dBm	

1	58.89	-64.97	-51.97	-13.00	-51.41	Peak
---	-------	--------	--------	--------	--------	------

	Freq	Level	Over Limit	Limit Line	Read Level	Remark
	MHz	dBm	dB	dBm	dBm	

1	610.80	-60.01	-47.01	-13.00	-58.24	Peak
---	--------	--------	--------	--------	--------	------

	Freq	Level	Over Limit	Limit Line	Read Level	Remark
	MHz	dBm	dB	dBm	dBm	

1 @	1718.00	-51.02	-38.02	-13.00	-50.60	Peak
2 @	1878.00	-49.43	-36.43	-13.00	-49.03	Peak
3 @	2038.00	-53.83	-40.83	-13.00	-53.79	Peak
4 @	2418.00	-53.08	-40.08	-13.00	-55.10	Peak

	Freq	Level	Over Limit	Limit Line	Read Level	Remark
	MHz	dBm	dB	dBm	dBm	

1 @	3758.00	-48.13	-35.13	-13.00	-54.76	Peak
-----	---------	--------	--------	--------	--------	------

	Freq	Level	Over Limit	Limit Line	Read Level	Remark
	MHz	dBm	dB	dBm	dBm	

1 @	7518.00	-44.84	-31.84	-13.00	-58.21	Peak
-----	---------	--------	--------	--------	--------	------

	Freq	Level	Over Limit	Limit Line	Read Level	Remark
	MHz	dBm	dB	dBm	dBm	

1 @	9398.00	-39.54	-26.54	-13.00	-56.75	Peak
-----	---------	--------	--------	--------	--------	------

## 4.7 Frequency Stability (Temperature Variation)

### 4.7.1 Measurement Instrument

As described in chapter 5 of this test report.

### 4.7.2 Test Procedure

1. The EUT and test equipment were set up as shown on the following section.
2. With all power removed, the temperature was decreased to -30°C and permitted to stabilize for three hours. Power was applied and the maximum change in frequency was noted within one minute.
3. With power OFF, the temperature was raised in 10°C steps. The sample was permitted to stabilize at each step for at least one-half hour. Power was applied and the maximum frequency change was noted within one minute.
4. The temperature tests were performed for the worst case.
5. Test data was recorded.

### 4.7.3 Test Setup Layout

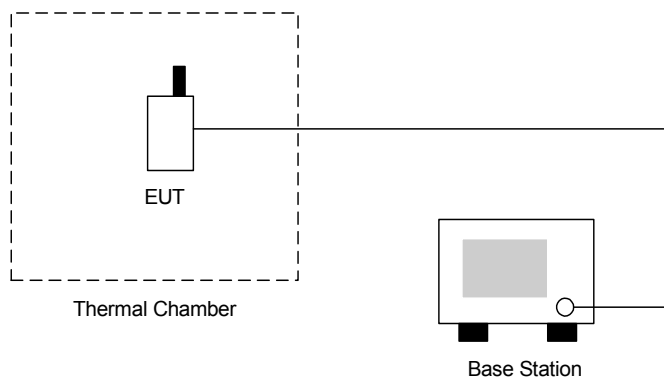



4.7.4 Test Result

▪ Test Mode : PCS 1900 CH661

Temperature(°C)	Change (Hz)	Change (ppm)	Limit (ppm)	Result
-30	15	0.01	2.5	Passed
-20	19	0.01		
-10	-30	-0.02		
0	-31	-0.02		
10	-26	-0.01		
20	24	0.01		
30	-27	-0.01		
40	-23	-0.01		
50	23	0.01		

### 4.8 Frequency Stability (Voltage Variation)

#### 4.8.1 Measurement Instrument

As described in chapter 5 of this test report.

#### 4.8.2 Test Procedure

1. The EUT was placed in a temperature chamber at  $25 \pm 5^\circ\text{C}$  and connected as the following section.
2. The power supply voltage to the EUT was varied from BEP to 115% of the nominal value measured at the input to the EUT.
3. The variation in frequency was measured for the worst case.

#### 4.8.3 Test Setup Layout

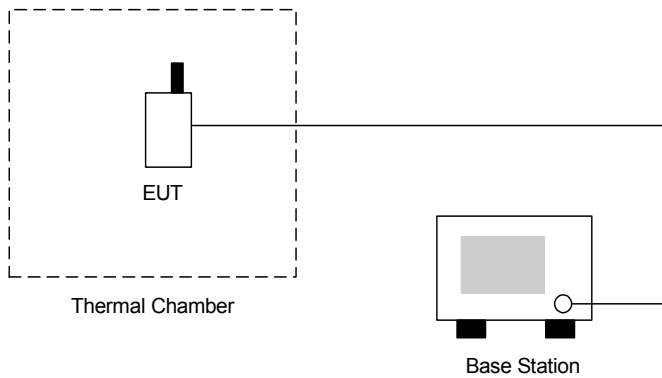

#### 4.8.4 Test Result

- Test Mode : PCS 1900 CH661

Voltage(Volt)	Change (Hz)	Change (ppm)	Limit (ppm)	Result
3.7	-45	-0.02	2.5	Passed
BEP	23	0.01		
4.3	-22	-0.01		

Remark:

1. Normal Voltage=3.7V
2. Battery End Point (BEP)=3.1 V



## 5 List of Measurement Equipments

Instrument	Manufacturer	Model No.	Serial No.	Characteristics	Calibration Date	Due Date	Remark
Antenna Mast	INN-CO	MM3000	114/8000604/L	1m~4m	NCR	N/A	Radiation (03CH06-HY)
Bilog Antenna	Schaffner	CBL6112B	2885	30MHz~2GHz	Nov. 21, 2004	Nov. 20, 2005	Radiation (03CH06-HY)
Controller	INN-CO	CO2000	114/8000604/L	N/A	NCR	N/A	Radiation (03CH06-HY)
Digital Radio Communication Tester	R&S	CMD55	832796/0061	RF Link	Feb. 18, 2004	Feb. 17, 2006	Radiation (03CH06-HY)
Double Ridge Horn Antenna	Com-Power	AH118	071025	1G~18G	Feb. 01, 2005	Jan. 31, 2006	Radiation (03CH06-HY)
EMI Test Receiver	R&S	ESCS30	100356	9KHz~2.75GHz	Jun. 28, 2005	Jun. 27, 2006	Radiation (03CH06-HY)
PreAmplifier	Agilent	8449B	3008A01917	1~26.5GHz	Mar. 29, 2005	Mar. 28, 2006	Radiation (03CH06-HY)
PreAmplifier	Com-Power	PA-103	161055	1MHz~1000MHz	Mar. 29, 2005	Mar. 28, 2006	Radiation (03CH06-HY)
SHF-EHF Horn	Schwarzbeck	BBHA 9170	9170-249	14G~40G	Jul. 21, 2004	Jul. 20, 2006	Radiation (03CH06-HY)
Spectrum Analyzer	Agilent	E4408B	MY44211030	9KHz~26.5GHz	Jul. 25, 2005	Jul. 24, 2006	Radiation (03CH06-HY)
Turn Table	INN-CO	DS2000	420/650/00	0~360 Degree	NCR	N/A	Radiation (03CH06-HY)



## 6 Uncertainty Evaluation

### Uncertainty of Conducted Emission Evaluation (30kHz ~ 1000MHz) (03CH03)

Contribution	Uncertainty of $x_i$		$u(x_i)$
	dB	Probability Distribution	
Receiver reading	0.41	Normal(k=2)	0.21
Antenna factor calibration	0.83	Normal(k=2)	0.42
Cable loss calibration	0.25	Normal(k=2)	0.13
Pre Amplifier Gain calibration	0.27	Normal(k=2)	0.14
RCV/SPA specification	2.50	Rectangular	0.72
Antenna Factor Interpolation for Frequency	1.00	Rectangular	0.29
Site imperfection	1.43	Rectangular	0.83
Mismatch Receiver VSWR $\Gamma_1 = 0.20$ Antenna VSWR $\Gamma_2 = 0.23$ Uncertainty = $20\log(1-\Gamma_1*\Gamma_2)$	+0.39/-0.41	U-shaped	0.28
<b>combined standard uncertainty <math>U_c(y)</math></b>	<b>1.27</b>		
<b>Measuring uncertainty for a level of confidence of 95% <math>U=2U_c(y)</math></b>	<b>2.54</b>		

### Uncertainty of Radiated Emission Evaluation (1GHz ~ 40GHz) (03CH03)

Contribution	Uncertainty of $x_i$		$u(x_i)$	$C_i$	$C_i * u(x_i)$
	dB	Probability Distribution			
Receiver reading	$\pm 0.10$	Normal(k=1)	0.10	1	0.10
Antenna factor calibration	$\pm 1.70$	Normal(k=2)	0.85	1	0.85
Cable loss calibration	$\pm 0.50$	Normal(k=2)	0.25	1	0.25
Receiver Correction	$\pm 2.00$	Rectangular	1.15	1	1.15
Antenna Factor Directional	$\pm 1.50$	Rectangular	0.87	1	0.87
Site imperfection	$\pm 2.80$	Triangular	1.14	1	1.14
Mismatch Receiver VSWR $\Gamma_1 = 0.197$ Antenna VSWR $\Gamma_2 = 0.194$ Uncertainty = $20\log(1-\Gamma_1*\Gamma_2*\Gamma_3)$	+0.34/-0.35	U-shaped	0.244	1	0.244
<b>Combined standard uncertainty <math>U_c(y)</math></b>	<b>2.36</b>				
<b>Measuring uncertainty for a level of confidence of 95% <math>U=2U_c(y)</math></b>	<b>4.72</b>				

END OF TEST REPORT