

**ELECTROMAGNETIC EMISSIONS
COMPLIANCE REPORT**

Applicant: Quanta Computer Inc.
No. 188, Wenhua 2nd Road, Guishan District, Taoyuan City
33377, Taiwan

Manufacturer: Quanta Computer Inc.
No. 188, Wenhua 2nd Road, Guishan District, Taoyuan City
33377, Taiwan

Product Name: Clover Compact

Brand Name: Clover

Model No.: C801

Report Number: TERF2403000759E2

FCC ID HFS-C801

Date of EUT Received: Mar. 21, 2024

Date of Test: Mar. 26, 2024 ~ Apr. 01, 2024

Issue Date: May 03, 2024

Approved By

Arno Hsieh

Arno Hsieh

We hereby certify that:

The above equipment was tested by SGS Taiwan Ltd. Central RF Lab The test data, data evaluation, test procedures, and equipment configurations shown in this report were made in accordance with the procedures given in ANSI C63.10:2013 and the energy emitted by the sample EUT comply with FCC rule part §15.407.

The results of this report relate only to the sample identified in this report.

Unless otherwise stated the results shown in this test report refer only to the sample(s) tested and such sample(s) are retained for 90 days only.

除非另有說明，此報告結果僅對測試之樣品負責，同時此樣品僅保留90天。本報告未經本公司書面許可，不可部份複製。

This document is issued by the Company subject to its General Conditions of Service printed overleaf, available on request or accessible at <http://www.sgs.com.tw/Terms-and-Conditions>, and for electronic format documents, subject to Terms and Conditions for Electronic Documents at <http://www.sgs.com.tw/Terms-and-Conditions>. Attention is drawn to the limitation of liability, indemnification and jurisdiction issues defined therein. Any holder of this document is advised that information contained hereon reflects the Company's findings at the time of its intervention only and within the limits of Client's instructions, if any. The Company's sole responsibility is to its Client and this document does not exonerate parties to a transaction from exercising all their rights and obligations under the transaction documents. This document cannot be reproduced except in full, without prior written approval of the Company. Any unauthorized alteration, forgery or falsification of the content or appearance of this document is unlawful and offenders may be prosecuted to the fullest extent of the law.

Revision History					
Report Number	Revision	Description	Issue Date	Revised By	Remark
TERF2403000759E2	00	Original	Apr. 22, 2024	Yami Kuo	
TERF2403000759E2	01	Revised chapter 1.2	Apr. 25, 2024	Yami Kuo	*
TERF2403000759E2	02	Revised chapter 2.6	May 03, 2024	Yami Kuo	*

Note:

- 1、The remark "*" indicates modification of the report upon requests from certification body.

Unless otherwise stated the results shown in this test report refer only to the sample(s) tested and such sample(s) are retained for 90 days only.

除非另有說明，此報告結果僅對測試之樣品負責，同時此樣品僅保留90天。本報告未經本公司書面許可，不可部份複製。

This document is issued by the Company subject to its General Conditions of Service printed overleaf, available on request or accessible at <http://www.sgs.com.tw/Terms-and-Conditions> and for electronic format documents, subject to Terms and Conditions for Electronic Documents at <http://www.sgs.com.tw/Terms-and-Conditions>. Attention is drawn to the limitation of liability, indemnification and jurisdiction issues defined therein. Any holder of this document is advised that information contained hereon reflects the Company's findings at the time of its intervention only and within the limits of Client's instructions, if any. The Company's sole responsibility is to its Client and this document does not exonerate parties to a transaction from exercising all their rights and obligations under the transaction documents. This document cannot be reproduced except in full, without prior written approval of the Company. Any unauthorized alteration, forgery or falsification of the content or appearance of this document is unlawful and offenders may be prosecuted to the fullest extent of the law.

SGS Taiwan Ltd.

No.134,Wu Kung Road, New Taipei Industrial Park, Wuku District, New Taipei City, Taiwan/新北市五股區新北產業園區五工路 134 號

台灣檢驗科技股份有限公司

t (886-2) 2299-3279

f (886-2) 2298-0488

www.sgs.com.tw

Member of SGS Group

Contents

1	GENERAL INFORMATION	4
2	SYSTEM TEST CONFIGURATION.....	7
3	SUMMARY OF TEST RESULT	9
4	DESCRIPTION OF TEST MODES.....	10
5	MEASUREMENT UNCERTAINTY	13
6	MEASUREMENT EQUIPMENT USED	14
7	MAXIMUM CONDUCTED OUTPUT POWER MEASUREMENT	15
8	UNDESIRABLE RADIATED EMISSION MEASUREMENT	23

Unless otherwise stated the results shown in this test report refer only to the sample(s) tested and such sample(s) are retained for 90 days only.

除非另有說明，此報告結果僅對測試之樣品負責，同時此樣品僅保留90天。本報告未經本公司書面許可，不可部份複製。

This document is issued by the Company subject to its General Conditions of Service printed overleaf, available on request or accessible at <http://www.sgs.com.tw/Terms-and-Conditions> and for electronic format documents, subject to Terms and Conditions for Electronic Documents at <http://www.sgs.com.tw/Terms-and-Conditions>. Attention is drawn to the limitation of liability, indemnification and jurisdiction issues defined therein. Any holder of this document is advised that information contained hereon reflects the Company's findings at the time of its intervention only and within the limits of Client's instructions, if any. The Company's sole responsibility is to its Client and this document does not exonerate parties to a transaction from exercising all their rights and obligations under the transaction documents. This document cannot be reproduced except in full, without prior written approval of the Company. Any unauthorized alteration, forgery or falsification of the content or appearance of this document is unlawful and offenders may be prosecuted to the fullest extent of the law.

SGS Taiwan Ltd.

No.134,Wu Kung Road, New Taipei Industrial Park, Wuku District, New Taipei City, Taiwan/新北市五股區新北產業園區五工路 134 號

台灣檢驗科技股份有限公司

t (886-2) 2299-3279

f (886-2) 2298-0488

www.sgs.com.tw

Member of SGS Group

1 GENERAL INFORMATION

1.1 Product Description

Product Name:	Clover Compact
Brand Name:	Clover
Model No.:	C801
Hardware Version:	N/A
Firmware Version:	N/A
EUT Series No.:	C081UG40850176
Power Supply:	12Vdc
Test Software (Name/Version)	QRCT V4.0

1.2 Modulation & Data Rate

Modulation type:	64QAM, 16QAM, QPSK, BPSK for OFDM in 802.11a, 11n
	256QAM, 64QAM, 16QAM, QPSK, BPSK for OFDM in 802.11ac
Transition Rate:	802.11 a: 6 - 54 Mbps
	802.11 n_HT20: up to 72.2 Mbps
	802.11 n_HT40: up to 150 Mbps
	802.11 ac_VHT20: up to 86.7 Mbps
	802.11 ac_VHT40: up to 200 Mbps
	802.11 ac_VHT80: up to 433.3 Mbps

1.3 Antenna Designation

Antenna Type	Supplier	Antenna Part No.	Freq. (MHz)	Peak Antenna Gain (dBi)
PIFA	Advanced Wireless & Antenna INC.	ALF6Y-100003	5150~5250	1.75
			5250~5350	1.75
			5475~5725	1.75
			5725~5825	1.75

Note:

1. Antenna information is provided by the applicant.

Unless otherwise stated the results shown in this test report refer only to the sample(s) tested and such sample(s) are retained for 90 days only.

除非另有說明，此報告結果僅對測試之樣品負責，同時此樣品僅保留90天。本報告未經本公司書面許可，不可部份複製。

This document is issued by the Company subject to its General Conditions of Service printed overleaf, available on request or accessible at <http://www.sgs.com.tw/Terms-and-Conditions>, and for electronic format documents, subject to Terms and Conditions for Electronic Documents at <http://www.sgs.com.tw/Terms-and-Conditions>. Attention is drawn to the limitation of liability, indemnification and jurisdiction issues defined therein. Any holder of this document is advised that information contained hereon reflects the Company's findings at the time of its intervention only and within the limits of Client's instructions, if any. The Company's sole responsibility is to its Client and this document does not exonerate parties to a transaction from exercising all their rights and obligations under the transaction documents. This document cannot be reproduced except in full, without prior written approval of the Company. Any unauthorized alteration, forgery or falsification of the content or appearance of this document is unlawful and offenders may be prosecuted to the fullest extent of the law.

1.4 FCC

Wi-Fi	Frequency Range	Channels	Rated Power(Avg) (dBm) (Worst Case)	Modulation Technology
802.11a/ 802.11n_HT20/ 802.11ac_VHT20	5180~5240	4	16.01 dBm	OFDM
	5260~5320	4	18.45 dBm	OFDM
	5500~5720	12	18.48 dBm	OFDM
	5745-5825	5	18.44 dBm	OFDM
802.11n_HT40/ 802.11ac_VHT40	5190~5230	2	16.51 dBm	OFDM
	5270~5310	2	16.15 dBm	OFDM
	5510~5710	6	16.31 dBm	OFDM
	5755-5795	2	16.43 dBm	OFDM
802.11ac_VHT80	5210	1	10.16 dBm	OFDM
	5290	1	9.11 dBm	OFDM
	5530~5690	3	15.86 dBm	OFDM
	5775	1	15.40 dBm	OFDM

Unless otherwise stated the results shown in this test report refer only to the sample(s) tested and such sample(s) are retained for 90 days only.

除非另有說明，此報告結果僅對測試之樣品負責，同時此樣品僅保留90天。本報告未經本公司書面許可，不可部份複製。

This document is issued by the Company subject to its General Conditions of Service printed overleaf, available on request or accessible at <http://www.sgs.com.tw/Terms-and-Conditions> and for electronic format documents, subject to Terms and Conditions for Electronic Documents at <http://www.sgs.com.tw/Terms-and-Conditions>. Attention is drawn to the limitation of liability, indemnification and jurisdiction issues defined therein. Any holder of this document is advised that information contained hereon reflects the Company's findings at the time of its intervention only and within the limits of Client's instructions, if any. The Company's sole responsibility is to its Client and this document does not exonerate parties to a transaction from exercising all their rights and obligations under the transaction documents. This document cannot be reproduced except in full, without prior written approval of the Company. Any unauthorized alteration, forgery or falsification of the content or appearance of this document is unlawful and offenders may be prosecuted to the fullest extent of the law.

1.5 Test Methodology of Applied Standards

FCC Part 15, Subpart E §15.407
 FCC KDB 789033 D02 General UNII Test Procedures New Rules v02r01
 ANSI C63.10:2013

1.6 Test Facility

Laboratory	Test Site Address	Test Site Name	FCC Designation number	IC CAB identifier
SGS Taiwan Ltd. Central RF Lab. (TAF code 3702)	No.134, Wu Kung Road, New Taipei Industrial Park, Wuku District, New Taipei City, Taiwan.	SAC 1	TW0027	TW3702
		SAC 2		
		SAC 3		
		Conduction 1		
		Conducted 1		
		Conducted 2		
		Conducted 3		
		Conducted 4		
		Conducted 5		
	Conducted 6			
	No.2, Keji 1st Rd., Guishan District, Taoyuan City, Taiwan 333	Conduction C	TW0028	
		SAC C		
		SAC D		
		SAC G		
		Conducted A		
		Conducted B		
		Conducted C		
		Conducted D		
		Conducted E		
Conducted F				
Conducted G				

Note: Test site name is remarked on the equipment list in each section of this report as an indication where measurements occurred in specific test site and address.

1.7 Special Accessories

There are no special accessories used while test was conducted.

1.8 Equipment Modifications

There was no modification incorporated into the EUT.

Unless otherwise stated the results shown in this test report refer only to the sample(s) tested and such sample(s) are retained for 90 days only.

除非另有說明，此報告結果僅對測試之樣品負責，同時此樣品僅保留90天。本報告未經本公司書面許可，不可部份複製。

This document is issued by the Company subject to its General Conditions of Service printed overleaf, available on request or accessible at <http://www.sgs.com.tw/Terms-and-Conditions>, and for electronic format documents, subject to Terms and Conditions for Electronic Documents at <http://www.sgs.com.tw/Terms-and-Conditions>. Attention is drawn to the limitation of liability, indemnification and jurisdiction issues defined therein. Any holder of this document is advised that information contained hereon reflects the Company's findings at the time of its intervention only and within the limits of Client's instructions, if any. The Company's sole responsibility is to its Client and this document does not exonerate parties to a transaction from exercising all their rights and obligations under the transaction documents. This document cannot be reproduced except in full, without prior written approval of the Company. Any unauthorized alteration, forgery or falsification of the content or appearance of this document is unlawful and offenders may be prosecuted to the fullest extent of the law.

2 SYSTEM TEST CONFIGURATION

2.1 EUT Configuration

The EUT configuration for testing is installed on RF field strength measurement to meet the Commissions requirement and operating in a manner which intends to maximize its emission characteristics in a continuous normal application.

2.2 EUT Exercise

An engineering test mode (software/firmware) that applicant provided was utilized to manipulate the EUT into transmit, selection of the test channel, and modulation scheme.

2.3 Test Procedure

2.3.1 Conducted Emissions

The EUT is placed on a table which is 0.8 m above ground plane. Conducted emissions from the EUT measured in the frequency range between 0.15 MHz and 30MHz. The CISPR Quasi-Peak and Average detector mode is employed. The two LISNs provide 50uH/50 ohm of coupling impedance for the measuring instrument. Both lines of the power mains connected to the EUT were checked for maximum conducted interference.

2.3.2 Conducted Test (RF)

The active antenna port of the unlicensed wireless device is connected to the spectrum analyzer with attenuator to protect the instrumentation. If a second antenna port is available, it is tested at one operating frequency, with other port(s) appropriately terminated, to verify it has similar output characteristics as the fully tested port.

2.3.3 Radiated Emissions

The EUT is placed on a turn table. For emissions testing at or below 1 GHz, the table height shall be 0.8 m above the reference ground plane. For emission measurements above 1 GHz, the table height shall be 1.5 m. The turn table shall rotate 360 degrees to determine the position of maximum emission level. EUT is set 3m away from the receiving antenna which varied from 1m to 4m to find out the highest emission. And also, each emission was to be maximized by changing the polarization of receiving antenna both horizontal and vertical. In order to find out the max. emission, the relative positions of this transmitter (EUT) was rotated through three orthogonal axes and measurement procedures for electric field radiated emissions above 1 GHz the EUT measurement is to be made "while keeping the antenna in the 'cone of radiation' from that area and pointed at the area both in azimuth and elevation, with polarization oriented for maximum response." is still within the 3dB illumination BW of the measurement antenna.

Unless otherwise stated the results shown in this test report refer only to the sample(s) tested and such sample(s) are retained for 90 days only.

除非另有說明，此報告結果僅對測試之樣品負責，同時此樣品僅保留90天。本報告未經本公司書面許可，不可部份複製。

This document is issued by the Company subject to its General Conditions of Service printed overleaf, available on request or accessible at <http://www.sgs.com.tw/Terms-and-Conditions>, and for electronic format documents, subject to Terms and Conditions for Electronic Documents at <http://www.sgs.com.tw/Terms-and-Conditions>. Attention is drawn to the limitation of liability, indemnification and jurisdiction issues defined therein. Any holder of this document is advised that information contained hereon reflects the Company's findings at the time of its intervention only and within the limits of Client's instructions, if any. The Company's sole responsibility is to its Client and this document does not exonerate parties to a transaction from exercising all their rights and obligations under the transaction documents. This document cannot be reproduced except in full, without prior written approval of the Company. Any unauthorized alteration, forgery or falsification of the content or appearance of this document is unlawful and offenders may be prosecuted to the fullest extent of the law.

2.4 Measurement Results Explanation Example

2.4.1 Radiated Emission Test Sites For Measurements From 9 kHz To 30 MHz

Radiated emission below 30MHz is measured in a 9m*6m*6m semi-anechoic chamber, the measurements correspond to those obtained at an open-field test site.

There is a comparison data of both open-field test site and semi-Anechoic chamber, and the result came out very similar.

2.4.2 For all conducted test items:

The offset level is set in the spectrum analyzer to compensate the RF cable loss and attenuation factor between EUT conducted port and spectrum analyzer. With the offset compensation, the spectrum analyzer reading level is exactly EUT RF output level.

2.5 Test Configuration

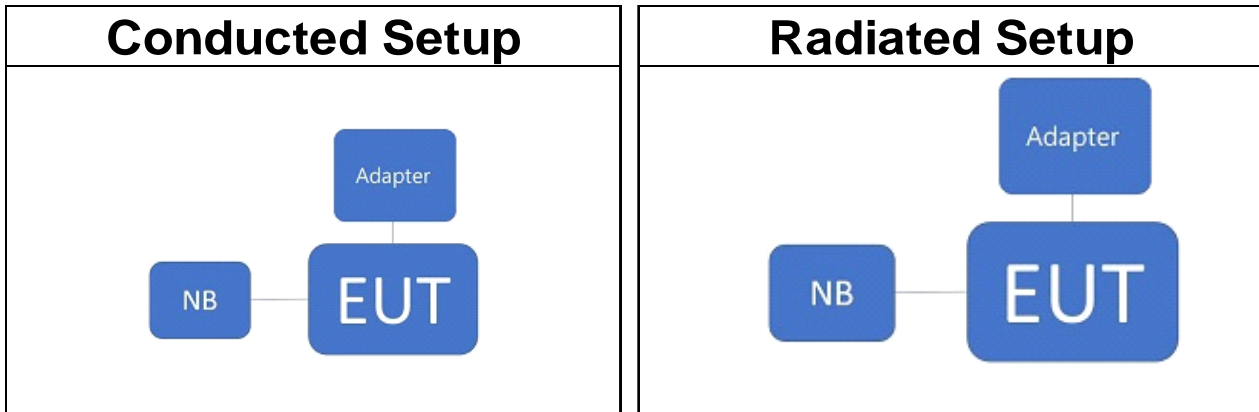

2.6 Control Unit(s)

Conducted Emission Test Site: Conducted D					
EQUIPMENT TYPE	MFR	MODEL NUMBER	SERIAL NUMBER	LAST CAL.	CAL DUE.
Adapter	clover	S024CEU1200200	N/A	N/A	N/A
Notebook	Lenovo	T14	P0003332	N/A	N/A

Radiated Emission Test Site: SAC G					
EQUIPMENT TYPE	MFR	MODEL NUMBER	SERIAL NUMBER	LAST CAL.	CAL DUE.
Adapter	clover	S024CEU1200200	N/A	N/A	N/A
Notebook	Lenovo	L480	P0002332	N/A	N/A

Unless otherwise stated the results shown in this test report refer only to the sample(s) tested and such sample(s) are retained for 90 days only.

除非另有說明，此報告結果僅對測試之樣品負責，同時此樣品僅保留90天。本報告未經本公司書面許可，不可部份複製。

This document is issued by the Company subject to its General Conditions of Service printed overleaf, available on request or accessible at <http://www.sgs.com.tw/Terms-and-Conditions>, and for electronic format documents, subject to Terms and Conditions for Electronic Documents at <http://www.sgs.com.tw/Terms-and-Conditions>. Attention is drawn to the limitation of liability, indemnification and jurisdiction issues defined therein. Any holder of this document is advised that information contained herein reflects the Company's findings at the time of its intervention only and within the limits of Client's instructions, if any. The Company's sole responsibility is to its Client and this document does not exonerate parties to a transaction from exercising all their rights and obligations under the transaction documents. This document cannot be reproduced except in full, without prior written approval of the Company. Any unauthorized alteration, forgery or falsification of the content or appearance of this document is unlawful and offenders may be prosecuted to the fullest extent of the law.

3 SUMMARY OF TEST RESULT

FCC Rules	Description Of Test	Result
§15.407(a)	Maximum Conducted Output Power	Compliant
§15.205 §15.209 §15.407(b)	Undesirable Radiated Emissions	Compliant

Unless otherwise stated the results shown in this test report refer only to the sample(s) tested and such sample(s) are retained for 90 days only.

除非另有說明，此報告結果僅對測試之樣品負責，同時此樣品僅保留90天。本報告未經本公司書面許可，不可部份複製。

This document is issued by the Company subject to its General Conditions of Service printed overleaf, available on request or accessible at <http://www.sgs.com.tw/Terms-and-Conditions> and for electronic format documents, subject to Terms and Conditions for Electronic Documents at <http://www.sgs.com.tw/Terms-and-Conditions>. Attention is drawn to the limitation of liability, indemnification and jurisdiction issues defined therein. Any holder of this document is advised that information contained hereon reflects the Company's findings at the time of its intervention only and within the limits of Client's instructions, if any. The Company's sole responsibility is to its Client and this document does not exonerate parties to a transaction from exercising all their rights and obligations under the transaction documents. This document cannot be reproduced except in full, without prior written approval of the Company. Any unauthorized alteration, forgery or falsification of the content or appearance of this document is unlawful and offenders may be prosecuted to the fullest extent of the law.

SGS Taiwan Ltd.

No.134,Wu Kung Road, New Taipei Industrial Park, Wuku District, New Taipei City, Taiwan/新北市五股區新北產業園區五工路 134 號

台灣檢驗科技股份有限公司

t (886-2) 2299-3279

f (886-2) 2298-0488

www.sgs.com.tw

Member of SGS Group

4 DESCRIPTION OF TEST MODES

4.1 Operating Frequencies

UNII-1 5150 MHz ~ 5250MHz

20MHz		40MHz		80MHz	
CH	Freq. (MHz)	CH	Freq. (MHz)	CH	Freq. (MHz)
36	5180	38	5190	42	5210
40	5200	46	5230		
44	5220				
48	5240				

UNII-2A 5250 MHz ~ 5350MHz

20MHz		40MHz		80MHz	
CH	Freq. (MHz)	CH	Freq. (MHz)	CH	Freq. (MHz)
52	5260	54	5270	58	5290
56	5280	62	5310		
60	5300				
64	5320				

UNII-2C 5470 MHz ~ 5725MHz

20MHz		40MHz		80MHz	
CH	Freq. (MHz)	CH	Freq. (MHz)	CH	Freq. (MHz)
100	5500	102	5510	106	5530
104	5520	110	5550	122	5610
108	5540	118	5590	138	5690
112	5560	126	5630		
116	5580	134	5670		
120	5600	142	5710		
124	5620				
128	5640				
132	5660				
136	5680				
140	5700				
144	5720				

UNII-3 5725 MHz ~ 5850MHz

20MHz		40MHz		80MHz	
CH	Freq. (MHz)	CH	Freq. (MHz)	CH	Freq. (MHz)
149	5745	151	5755	155	5775
153	5765	159	5795		
157	5785				
161	5805				
165	5825				

Unless otherwise stated the results shown in this test report refer only to the sample(s) tested and such sample(s) are retained for 90 days only.

除非另有說明，此報告結果僅對測試之樣品負責，同時此樣品僅保留90天。本報告未經本公司書面許可，不可部份複製。

This document is issued by the Company subject to its General Conditions of Service printed overleaf, available on request or accessible at <http://www.sgs.com.tw/Terms-and-Conditions> and for electronic format documents, subject to Terms and Conditions for Electronic Documents at <http://www.sgs.com.tw/Terms-and-Conditions>. Attention is drawn to the limitation of liability, indemnification and jurisdiction issues defined therein. Any holder of this document is advised that information contained hereon reflects the Company's findings at the time of its intervention only and within the limits of Client's instructions, if any. The Company's sole responsibility is to its Client and this document does not exonerate parties to a transaction from exercising all their rights and obligations under the transaction documents. This document cannot be reproduced except in full, without prior written approval of the Company. Any unauthorized alteration, forgery or falsification of the content or appearance of this document is unlawful and offenders may be prosecuted to the fullest extent of the law.

4.2 The Worst Test Modes and Channel Details

1. The EUT has been tested under operating condition.
2. Test program used to control the EUT for staying in continuous transmitting mode is programmed.
3. Investigation has been done on all the possible configurations for searching the worst case. The given UE is pre-scanned among below modes.

Modulation	Transmission Chain				Single Transmission Spatial	Multiple Transmission Spatial
<input checked="" type="checkbox"/> 802.11 a	<input checked="" type="checkbox"/> Ch0	<input type="checkbox"/> Ch1	<input type="checkbox"/> Ch2	<input type="checkbox"/> Ch3	<input checked="" type="checkbox"/> 1TX	<input type="checkbox"/> 2TX
<input checked="" type="checkbox"/> 802.11 n	<input checked="" type="checkbox"/> Ch0	<input type="checkbox"/> Ch1	<input type="checkbox"/> Ch2	<input type="checkbox"/> Ch3	<input checked="" type="checkbox"/> 1TX	<input type="checkbox"/> 2TX
<input checked="" type="checkbox"/> 802.11 ac	<input checked="" type="checkbox"/> Ch0	<input type="checkbox"/> Ch1	<input type="checkbox"/> Ch2	<input type="checkbox"/> Ch3	<input checked="" type="checkbox"/> 1TX	<input type="checkbox"/> 2TX
<input type="checkbox"/> 802.11 ax	<input type="checkbox"/> Ch0	<input type="checkbox"/> Ch1	<input type="checkbox"/> Ch2	<input type="checkbox"/> Ch3	<input type="checkbox"/> 1TX	<input type="checkbox"/> 2TX

4. Therefore, below summary is the modes of test configuration that yield the highest reading and generate the highest emission chosen to carry out the relevantly mandatory test items.

CONDUCTED TEST						
MODE	FREQUENCY BAND (MHz)	AVAILABLE CHANNEL	TESTED CHANNEL	MODULATION	DATA RATE (Mbps)	ANTENNA PORT
802.11a	5180~5240	36 to 48	36,44,48	OFDM	6	ch0
	5260~5320	52 to 64	52,60,64			
	5500~5720	100 to 144	100,116,140,144			
	5745~5825	149 to 165	149,157,165			
802.11n_HT20	5180~5240	36 to 48	36,44,48	OFDM	MCS0	ch0
	5260~5320	52 to 64	52,60,64			
	5500~5720	100 to 144	100,116,140,144			
	5745~5825	149 to 165	149,157,165			
802.11n_HT40	5190~5230	38 to 46	38,46	OFDM	MCS0	ch0
	5270~5310	54 to 62	54,62			
	5510~5710	102 to 142	102,110,134,142			
	5755~5795	151 to 159	151,159			
802.11ac_VHT80	5210	42	42	OFDM	MCS0	ch0
	5290	58	58			
	5530~5690	106 to 138	106,122,138			
	5775	155	155			

Unless otherwise stated the results shown in this test report refer only to the sample(s) tested and such sample(s) are retained for 90 days only.

除非另有說明，此報告結果僅對測試之樣品負責，同時此樣品僅保留90天。本報告未經本公司書面許可，不可部份複製。

This document is issued by the Company subject to its General Conditions of Service printed overleaf, available on request or accessible at <http://www.sgs.com.tw/Terms-and-Conditions>, and for electronic format documents, subject to Terms and Conditions for Electronic Documents at <http://www.sgs.com.tw/Terms-and-Conditions>. Attention is drawn to the limitation of liability, indemnification and jurisdiction issues defined therein. Any holder of this document is advised that information contained hereon reflects the Company's findings at the time of its intervention only and within the limits of Client's instructions, if any. The Company's sole responsibility is to its Client and this document does not exonerate parties to a transaction from exercising all their rights and obligations under the transaction documents. This document cannot be reproduced except in full, without prior written approval of the Company. Any unauthorized alteration, forgery or falsification of the content or appearance of this document is unlawful and offenders may be prosecuted to the fullest extent of the law.

TRANSMIT RADIATED EMISSION TEST (BELOW 1 GHz)						
MODE	FREQUENCY BAND (MHz)	AVAILABLE CHANNEL	TESTED CHANNEL	MODULATION	DATA RATE (Mbps)	ANTENNA PORT
802.11a	5180~5240	36 to 48	44	OFDM	6	ch0
	5260~5320	52 to 64	60			
	5500~5720	100 to 144	116			
	5745~5825	149 to 165	157			
TRANSMIT RADIATED EMISSION TEST (ABOVE 1 GHz)						
MODE	FREQUENCY BAND (MHz)	AVAILABLE CHANNEL	TESTED CHANNEL	MODULATION	DATA RATE (Mbps)	ANTENNA PORT
802.11a	5180~5240	36 to 48	36,44,48	OFDM	6	ch0
	5260~5320	52 to 64	52,60,64			
	5500~5720	100 to 144	100,116,140,144			
	5745~5825	149 to 165	149,157,165			
802.11ac_VHT20	5180~5240	36 to 48	36,44,48	OFDM	MCS0	ch0
	5260~5320	52 to 64	52,60,64			
	5500~5720	100 to 144	100,116,140,144			
	5745~5825	149 to 165	149,157,165			
802.11ac_VHT40	5190~5230	38 to 46	38,46	OFDM	MCS0	ch0
	5270~5310	54 to 62	54,62			
	5510~5710	102 to 142	102,118,134,142			
	5755~5795	151 to 159	151,159			
802.11ac_VHT80	5210	42	42	OFDM	MCS0	ch0
	5290	58	58			
	5530~5690	106 to 138	106,122,138			
	5775	155	155			

Note:

The field strength of radiated emission was measured as the EUT positioned in different orthogonal planes (E1/E2/H) based on actual usage of the EUT to pre-scan the emissions for determining the worst case scenario.

Unless otherwise stated the results shown in this test report refer only to the sample(s) tested and such sample(s) are retained for 90 days only.

除非另有說明，此報告結果僅對測試之樣品負責，同時此樣品僅保留90天。本報告未經本公司書面許可，不可部份複製。

This document is issued by the Company subject to its General Conditions of Service printed overleaf, available on request or accessible at <http://www.sgs.com.tw/Terms-and-Conditions>, and for electronic format documents, subject to Terms and Conditions for Electronic Documents at <http://www.sgs.com.tw/Terms-and-Conditions>. Attention is drawn to the limitation of liability, indemnification and jurisdiction issues defined therein. Any holder of this document is advised that information contained hereon reflects the Company's findings at the time of its intervention only and within the limits of Client's instructions, if any. The Company's sole responsibility is to its Client and this document does not exonerate parties to a transaction from exercising all their rights and obligations under the transaction documents. This document cannot be reproduced except in full, without prior written approval of the Company. Any unauthorized alteration, forgery or falsification of the content or appearance of this document is unlawful and offenders may be prosecuted to the fullest extent of the law.

5 MEASUREMENT UNCERTAINTY

Test Items	Uncertainty
AC Power Line Conducted Emission	+/- 1.54 dB
Output Power measurement	+/- 0.97 dB
Emission Bandwidth	+/- 1.38 Hz
Conducted emission measurement	+/- 0.77 dB
Peak Power Density	+/- 0.61 dB
Temperature	+/- 0.6 °C
Humidity	+/- 3 %
DC / AC Power Source	+/- 1 %

Radiated Spurious Emission Measurement Uncertainty			
Polarization: Vertical	+/-	1.89 dB	9kHz~30MHz
	+/-	4.15 dB	30MHz - 1000MHz
	+/-	3.43 dB	1GHz - 18GHz
	+/-	3.86 dB	18GHz - 40GHz
Polarization: Horizontal	+/-	1.89 dB	9kHz~30MHz
	+/-	4.02 dB	30MHz - 1000MHz
	+/-	3.43 dB	1GHz - 18GHz
	+/-	3.86 dB	18GHz - 40GHz
Radiated Spurious Emission	+/-	2 dB	33GHz-50GHz
	+/-	1.59 dB	50GHz-60GHz
	+/-	1.7 dB	60GHz-90GHz
	+/-	1.64 dB	90GHz-140GHz
	+/-	3.83 dB	140GHz-220GHz

Note:

1. This uncertainty represents an expanded uncertainty expressed at approximately the 95% confidence level using a coverage factor of k=2.
2. The conformity assessment statement in this report is based solely on the test results, measurement uncertainty is excluded.

Unless otherwise stated the results shown in this test report refer only to the sample(s) tested and such sample(s) are retained for 90 days only.

除非另有說明，此報告結果僅對測試之樣品負責，同時此樣品僅保留90天。本報告未經本公司書面許可，不可部份複製。

This document is issued by the Company subject to its General Conditions of Service printed overleaf, available on request or accessible at <http://www.sgs.com.tw/Terms-and-Conditions> and for electronic format documents, subject to Terms and Conditions for Electronic Documents at <http://www.sgs.com.tw/Terms-and-Conditions>. Attention is drawn to the limitation of liability, indemnification and jurisdiction issues defined therein. Any holder of this document is advised that information contained hereon reflects the Company's findings at the time of its intervention only and within the limits of Client's instructions, if any. The Company's sole responsibility is to its Client and this document does not exonerate parties to a transaction from exercising all their rights and obligations under the transaction documents. This document cannot be reproduced except in full, without prior written approval of the Company. Any unauthorized alteration, forgery or falsification of the content or appearance of this document is unlawful and offenders may be prosecuted to the fullest extent of the law.

6 MEASUREMENT EQUIPMENT USED

6.1 Condcuted Measurement

Conducted Emission Test Site: Conducted D					
EQUIPMENT TYPE	MFR	MODEL NUMBER	SERIAL NUMBER	LAST CAL.	CAL DUE.
Spectrum Analyzer	KEYSIGHT	N9010B	MY59071573	05/23/2023	05/22/2024
Power Meter	Anritsu	ML2496A	2138002	08/31/2023	08/30/2024
Power Sensor	Anritsu	MA2411B	1911390	08/31/2023	08/30/2024
Power Sensor	Anritsu	MA2411B	1911398	08/31/2023	08/30/2024
Test Software	SGS Taiwan	Radio Test Software	Ver.21	N.C.R	N.C.R
Attenuator	Woken	WATT-218FS-10	RF18	11/15/2023	11/14/2024
Attenuator	Woken	WATT-218FS-10	RF19	11/15/2023	11/14/2024
DC Block	PASTERNAK	PE8210	RF155	11/15/2023	11/14/2024

6.2 Radiated Measurement

Radiated Emission Test Site: SAC G					
EQUIPMENT TYPE	MFR	MODEL NUMBER	SERIAL NUMBER	LAST CAL.	CAL DUE.
Broadband Antenna	SCHWARZBECK	VULB 9168	1208	07/21/2023	07/20/2024
Horn Antenna	Schwarzbeck	BBHA9170	185	08/21/2023	08/20/2024
Horn Antenna	RF SPIN	DRH18-E	210105A18E	04/18/2023	04/17/2024
Loop Antenna	ETS.LINDGREN	6502	143303	05/23/2023	05/22/2024
3m Site NSA	SGS	966 chamber G	N/A	03/30/2023	03/29/2024
Spectrum Analyzer	KEYSIGHT	N9010A	MY51440113	07/17/2023	07/16/2024
Test Software	audix	e3	E3 20923 SGS Ver.9 (C)	N.C.R	N.C.R
Pre-Amplifier	EMC Instruments	EMC330N	980781	03/15/2024	03/14/2025
Pre-Amplifier	EMC Instruments	EMC118A45SE	980815	03/15/2024	03/14/2025
Pre-Amplifier	EMC Instruments	EMC184945SEE	980938	11/15/2023	11/14/2024
Coaxial Cable	EMC Instruments	EMCCFD400-NM-NM-8000-5000-2000	210216、210217、210218	03/15/2024	03/14/2025
Coaxial Cable	EMC Instruments	EMC104-SM-SM-8000-5000-5000	210219、210220、210221	03/15/2024	03/14/2025

NOTE: N.C.R refers to Not Calibrated Required.

Unless otherwise stated the results shown in this test report refer only to the sample(s) tested and such sample(s) are retained for 90 days only.

除非另有說明，此報告結果僅對測試之樣品負責，同時此樣品僅保留90天。本報告未經本公司書面許可，不可部份複製。

This document is issued by the Company subject to its General Conditions of Service printed overleaf, available on request or accessible at <http://www.sgs.com.tw/Terms-and-Conditions> and for electronic format documents, subject to Terms and Conditions for Electronic Documents at <http://www.sgs.com.tw/Terms-and-Conditions>. Attention is drawn to the limitation of liability, indemnification and jurisdiction issues defined therein. Any holder of this document is advised that information contained hereon reflects the Company's findings at the time of its intervention only and within the limits of Client's instructions, if any. The Company's sole responsibility is to its Client and this document does not exonerate parties to a transaction from exercising all their rights and obligations under the transaction documents. This document cannot be reproduced except in full, without prior written approval of the Company. Any unauthorized alteration, forgery or falsification of the content or appearance of this document is unlawful and offenders may be prosecuted to the fullest extent of the law.

7 MAXIMUM CONDUCTED OUTPUT POWER MEASUREMENT

7.1 Standard Applicable

7.1.1 Duty Cycle

Pre-analysis Check: While conducting average power measurement, duty cycle of each mode shall be checked to ensure its duty cycle in order to compensate for the loss due to insufficient ratio of duty cycle.

All duty cycle is pre-scanned, and result as obtained below shows only the most representative ones where duty cycle is conducted as the given transmission with given virtual operation that expresses the percentage.

Unless otherwise stated the results shown in this test report refer only to the sample(s) tested and such sample(s) are retained for 90 days only.
除非另有說明，此報告結果僅對測試之樣品負責，同時此樣品僅保留90天。本報告未經本公司書面許可，不可部份複製。

This document is issued by the Company subject to its General Conditions of Service printed overleaf, available on request or accessible at <http://www.sgs.com.tw/Terms-and-Conditions> and for electronic format documents, subject to Terms and Conditions for Electronic Documents at <http://www.sgs.com.tw/Terms-and-Conditions>. Attention is drawn to the limitation of liability, indemnification and jurisdiction issues defined therein. Any holder of this document is advised that information contained hereon reflects the Company's findings at the time of its intervention only and within the limits of Client's instructions, if any. The Company's sole responsibility is to its Client and this document does not exonerate parties to a transaction from exercising all their rights and obligations under the transaction documents. This document cannot be reproduced except in full, without prior written approval of the Company. Any unauthorized alteration, forgery or falsification of the content or appearance of this document is unlawful and offenders may be prosecuted to the fullest extent of the law.

Band	EUT CATEGORY		e-CRF Title 47 §15.407			
			Conducted Output Power	EIRP	TPC	Antenna Directional Gain Requirements
U-NII-1		Fixed point-to-point	1 Watt(30dBm)	Not required	Not required	23dBi
		Outdoor AP	1 Watt(30dBm)	Elevation angle above 30 degrees 125mW (21dBm)	Not required	6dBi
		Indoor AP	1 Watt(30dBm)	Not required	Not required	6dBi
	V	Other	250mW(23.98dBm)	Not required	Not required	6dBi
U-NII-2A	V	Other	250mW(23.98dBm) or 11dBm+10 log B	Not required	When EIRP >500mW At least 6dB below EIRP 1W (30dBm)	6dBi
U-NII-2C	V	Other	250mW(23.98dBm) or 11dBm+10 log B	Not required		6dBi
U-NII-3	V	Other	1 Watt(30dBm)	Not required	Not required	6dBi
		Fixed point-to-point	1 Watt(30dBm)	Not required	Not required	Not required
U-NII-4		Indoor AP (a channel spans 5725~5850 and 5850~5895MHz)	Not required	36dBm	Not required	Not required
		indoor client (a channel spans 5725~5850 and 5850~5895MHz)	Not required	30dBm	Not required	Not required
		subordinate device	Not required	36dBm	Not required	Not required

1. If transmitting antennas of directional gain greater than the antenna requirements column, the Maximum transmit power shall be reduced by the amount in dB that the direction-al gain of the antenna.
2. For the 10 log B, B is the 26 dB emission bandwidth.

Unless otherwise stated the results shown in this test report refer only to the sample(s) tested and such sample(s) are retained for 90 days only.

除非另有說明，此報告結果僅對測試之樣品負責，同時此樣品僅保留90天。本報告未經本公司書面許可，不可部份複製。

This document is issued by the Company subject to its General Conditions of Service printed overleaf, available on request or accessible at <http://www.sgs.com.tw/Terms-and-Conditions> and for electronic format documents, subject to Terms and Conditions for Electronic Documents at <http://www.sgs.com.tw/Terms-and-Conditions>. Attention is drawn to the limitation of liability, indemnification and jurisdiction issues defined therein. Any holder of this document is advised that information contained hereon reflects the Company's findings at the time of its intervention only and within the limits of Client's instructions, if any. The Company's sole responsibility is to its Client and this document does not exonerate parties to a transaction from exercising all their rights and obligations under the transaction documents. This document cannot be reproduced except in full, without prior written approval of the Company. Any unauthorized alteration, forgery or falsification of the content or appearance of this document is unlawful and offenders may be prosecuted to the fullest extent of the law.

7.2 Test Setup

7.2.1 Duty Cycle

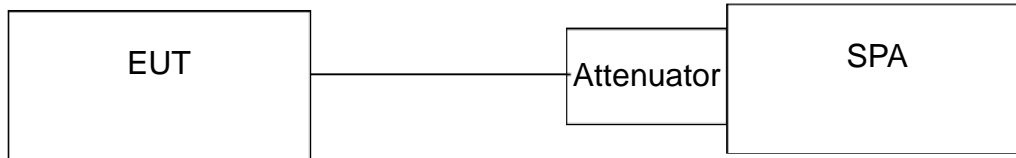

7.2.2 Output Power

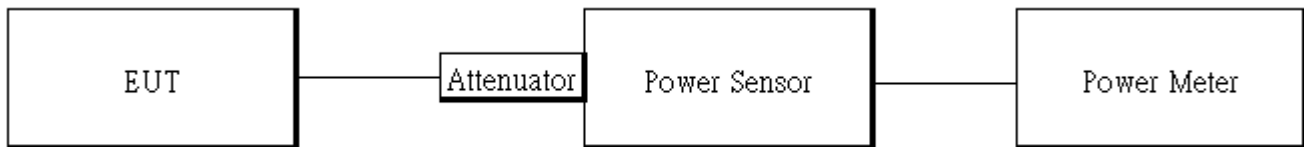

7.3 Measurement Procedure

7.3.1 Duty Cycle Measurements

1. Set span = Zero
2. RBW = 8MHz
3. VBW = 8MHz,
4. Detector = Peak

7.3.2 Output Power Measurements

1. Place the EUT on the table and set it in transmitting mode.
2. The testing follows FCC KDB 789033 D02 General UNII Test Procedures New Rules .
3. Remove the antenna from the EUT and then connect a low loss RF cable from the antenna port to the power meter
4. Power Meter is used as the auxiliary test equipment to conduct the output power measurement.
5. Record the max. reading and add $10 \log(1/\text{duty cycle})$.
6. Repeat above procedures until all frequency (low, middle, and high channel) measured were complete.

The antenna gain is not greater than 6 dBi. Therefore, reduction of power is not required.

Unless otherwise stated the results shown in this test report refer only to the sample(s) tested and such sample(s) are retained for 90 days only.

除非另有說明，此報告結果僅對測試之樣品負責，同時此樣品僅保留90天。本報告未經本公司書面許可，不可部份複製。
 This document is issued by the Company subject to its General Conditions of Service printed overleaf, available on request or accessible at <http://www.sgs.com.tw/Terms-and-Conditions> and for electronic format documents, subject to Terms and Conditions for Electronic Documents at <http://www.sgs.com.tw/Terms-and-Conditions>. Attention is drawn to the limitation of liability, indemnification and jurisdiction issues defined therein. Any holder of this document is advised that information contained hereon reflects the Company's findings at the time of its intervention only and within the limits of Client's instructions, if any. The Company's sole responsibility is to its Client and this document does not exonerate parties to a transaction from exercising all their rights and obligations under the transaction documents. This document cannot be reproduced except in full, without prior written approval of the Company. Any unauthorized alteration, forgery or falsification of the content or appearance of this document is unlawful and offenders may be prosecuted to the fullest extent of the law.

7.4 Duty Cycle Measurement Result

Mode	Duty Cycle (%) =Ton / (Ton+Toff)	Duty Factor (dB) =10*log (1/Duty Cycle)	1/T (kHz)	VBW setting (kHz)
802.11a	98.29	0.07	0.48	0.01
802.11n_20	98.16	0.08	0.52	0.01
802.11ac_20	98.07	0.08	0.52	0.01
802.11n_40	96.34	0.16	1.05	2.00
802.11ac_40	96.36	0.16	1.05	2.00
802.11ac_80	92.80	0.32	2.16	3.00

Unless otherwise stated the results shown in this test report refer only to the sample(s) tested and such sample(s) are retained for 90 days only.

除非另有說明，此報告結果僅對測試之樣品負責，同時此樣品僅保留90天。本報告未經本公司書面許可，不可部份複製。

This document is issued by the Company subject to its General Conditions of Service printed overleaf, available on request or accessible at <http://www.sgs.com.tw/Terms-and-Conditions> and for electronic format documents, subject to Terms and Conditions for Electronic Documents at <http://www.sgs.com.tw/Terms-and-Conditions>. Attention is drawn to the limitation of liability, indemnification and jurisdiction issues defined therein. Any holder of this document is advised that information contained hereon reflects the Company's findings at the time of its intervention only and within the limits of Client's instructions, if any. The Company's sole responsibility is to its Client and this document does not exonerate parties to a transaction from exercising all their rights and obligations under the transaction documents. This document cannot be reproduced except in full, without prior written approval of the Company. Any unauthorized alteration, forgery or falsification of the content or appearance of this document is unlawful and offenders may be prosecuted to the fullest extent of the law.

802.11a_20MHz_Chain0_5180MHz

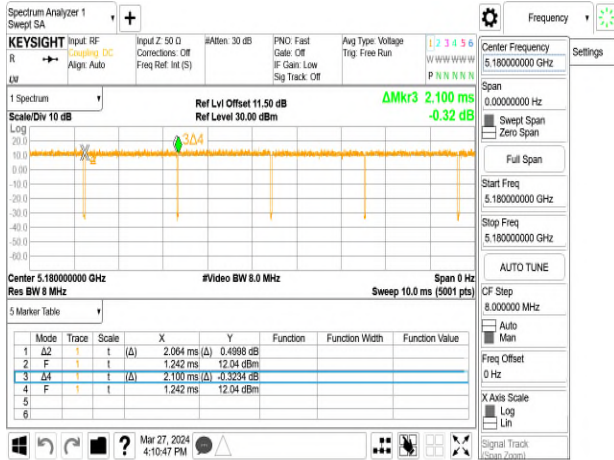

802.11ac_20MHz_Chain0_5180MHz



802.11n_20MHz_Chain0_5180MHz

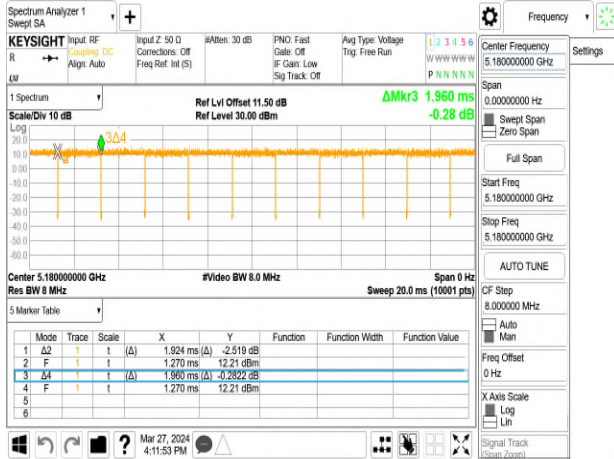

802.11ac_40MHz_Chain0_5190MHz



802.11n_40MHz_Chain0_5190MHz



802.11ac_80MHz_Chain0_5210MHz

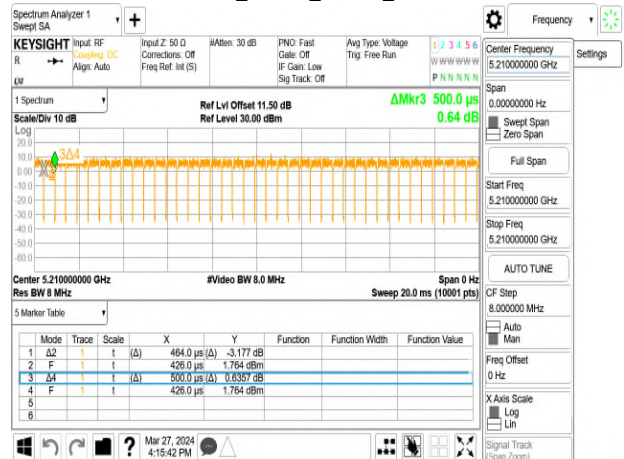

Unless otherwise stated the results shown in this test report refer only to the sample(s) tested and such sample(s) are retained for 90 days only.

除非另有說明，此報告結果僅對測試之樣品負責，同時此樣品僅保留90天。本報告未經本公司書面許可，不可部份複製。

This document is issued by the Company subject to its General Conditions of Service printed overleaf, available on request or accessible at <http://www.sgs.com.tw/Terms-and-Conditions> and for electronic format documents, subject to Terms and Conditions for Electronic Documents at <http://www.sgs.com.tw/Terms-and-Conditions>. Attention is drawn to the limitation of liability, indemnification and jurisdiction issues defined therein. Any holder of this document is advised that information contained hereon reflects the Company's findings at the time of its intervention only and within the limits of Client's instructions, if any. The Company's sole responsibility is to its Client and this document does not exonerate parties to a transaction from exercising all their rights and obligations under the transaction documents. This document cannot be reproduced except in full, without prior written approval of the Company. Any unauthorized alteration, forgery or falsification of the content or appearance of this document is unlawful and offenders may be prosecuted to the fullest extent of the law.

7.5 Output Power Measurement Result

7.5.1 FCC Output power

802.11a_Ch0

CH	Frequency (MHz)	Data Rate	Power Setting	TOTAL POWER (mW)	TOTAL POWER (dBm)	REQUIRED LIMIT (dBm)	RESULT
36	5180	6	17	39.948	16.01	23.98	PASS
44	5220	6	17	39.673	15.98	23.98	PASS
48	5240	6	17	39.038	15.91	23.98	PASS
52	5260	6	19.5	68.154	18.33	23.98	PASS
60	5300	6	19.5	70.063	18.45	23.98	PASS
64	5320	6	18	52.904	17.23	23.98	PASS
100	5500	6	19	54.012	17.32	23.98	PASS
116	5580	6	20.5	70.549	18.48	23.98	PASS
140	5700	6	19	55.270	17.42	23.98	PASS
144	5720(U-NII 2C)	6	20.5	46.697	16.69	23.98	PASS
144	5720 (U-NII 3)	6	20.5	22.884	13.60	30	PASS
149	5745	6	20.5	69.902	18.44	30	PASS
157	5785	6	20.5	64.937	18.12	30	PASS
165	5825	6	21	68.626	18.36	30	PASS

802.11n_HT20_Ch0

CH	Frequency (MHz)	Data Rate	Power Setting	TOTAL POWER (mW)	TOTAL POWER (dBm)	REQUIRED LIMIT (dBm)	RESULT
36	5180	MCS0	16.5	37.159	15.70	23.98	PASS
44	5220	MCS0	17	39.543	15.97	23.98	PASS
48	5240	MCS0	17	38.732	15.88	23.98	PASS
52	5260	MCS0	19	56.763	17.54	23.98	PASS
60	5300	MCS0	18.5	54.084	17.33	23.98	PASS
64	5320	MCS0	17	41.027	16.13	23.98	PASS
100	5500	MCS0	18.5	46.673	16.69	23.98	PASS
116	5580	MCS0	20	55.984	17.48	23.98	PASS
140	5700	MCS0	16.5	29.449	14.69	23.98	PASS
144	5720(U-NII 2C)	MCS0	20	38.442	15.85	23.98	PASS
144	5720 (U-NII 3)	MCS0	20	18.978	12.78	30	PASS
149	5745	MCS0	20	55.089	17.41	30	PASS
157	5785	MCS0	20	53.342	17.27	30	PASS
165	5825	MCS0	20.5	55.343	17.43	30	PASS

Unless otherwise stated the results shown in this test report refer only to the sample(s) tested and such sample(s) are retained for 90 days only.

除非另有說明，此報告結果僅對測試之樣品負責，同時此樣品僅保留90天。本報告未經本公司書面許可，不可部份複製。

This document is issued by the Company subject to its General Conditions of Service printed overleaf, available on request or accessible at <http://www.sgs.com.tw/Terms-and-Conditions> and for electronic format documents, subject to Terms and Conditions for Electronic Documents at <http://www.sgs.com.tw/Terms-and-Conditions>. Attention is drawn to the limitation of liability, indemnification and jurisdiction issues defined therein. Any holder of this document is advised that information contained hereon reflects the Company's findings at the time of its intervention only and within the limits of Client's instructions, if any. The Company's sole responsibility is to its Client and this document does not exonerate parties to a transaction from exercising all their rights and obligations under the transaction documents. This document cannot be reproduced except in full, without prior written approval of the Company. Any unauthorized alteration, forgery or falsification of the content or appearance of this document is unlawful and offenders may be prosecuted to the fullest extent of the law.

802.11n_HT40_Ch0

CH	Frequency (MHz)	Data Rate	Power Setting	TOTAL POWER (mW)	TOTAL POWER (dBm)	REQUIRED LIMIT (dBm)	RESULT
38	5190	MCS0	10.5	11.071	10.44	23.98	PASS
46	5230	MCS0	17	44.381	16.47	23.98	PASS
54	5270	MCS0	16.5	40.850	16.11	23.98	PASS
62	5310	MCS0	11	12.451	10.95	23.98	PASS
102	5510	MCS0	13	19.733	12.95	23.98	PASS
110	5550	MCS0	17.5	41.802	16.21	23.98	PASS
134	5670	MCS0	17.5	41.133	16.14	23.98	PASS
142	5710(U-NII 2C)	MCS0	18	35.023	15.44	23.98	PASS
142	5710 (U-NII 3)	MCS0	18	8.951	9.52	30	PASS
151	5755	MCS0	18	43.271	16.36	30	PASS
159	5795	MCS0	18.5	43.271	16.36	30	PASS

802.11ac_VHT20_Ch0

CH	Frequency (MHz)	Data Rate	Power Setting	TOTAL POWER (mW)	TOTAL POWER (dBm)	REQUIRED LIMIT (dBm)	RESULT
36	5180	MCS0	16.5	37.711	15.76	23.98	PASS
44	5220	MCS0	17	39.945	16.01	23.98	PASS
48	5240	MCS0	17	39.488	15.96	23.98	PASS
52	5260	MCS0	19	57.738	17.61	23.98	PASS
60	5300	MCS0	18.5	55.394	17.43	23.98	PASS
64	5320	MCS0	17	46.394	16.66	23.98	PASS
100	5500	MCS0	18.5	47.584	16.77	23.98	PASS
116	5580	MCS0	20	56.294	17.50	23.98	PASS
140	5700	MCS0	16.5	29.886	14.75	23.98	PASS
144	5720(U-NII 2C)	MCS0	20	39.103	15.92	23.98	PASS
144	5720 (U-NII 3)	MCS0	20	19.304	12.86	30	PASS
149	5745	MCS0	20	56.554	17.52	30	PASS
157	5785	MCS0	20	54.133	17.33	30	PASS
165	5825	MCS0	20.5	56.165	17.49	30	PASS

802.11ac_VHT40_Ch0

CH	Frequency (MHz)	Data Rate	Power Setting	TOTAL POWER (mW)	TOTAL POWER (dBm)	REQUIRED LIMIT (dBm)	RESULT
38	5190	MCS0	10.5	11.353	10.55	23.98	PASS
46	5230	MCS0	17	44.782	16.51	23.98	PASS
54	5270	MCS0	16.5	41.220	16.15	23.98	PASS
62	5310	MCS0	11	12.709	11.04	23.98	PASS
102	5510	MCS0	13	19.820	12.97	23.98	PASS
110	5550	MCS0	17.5	42.374	16.27	23.98	PASS
134	5670	MCS0	17.5	42.766	16.31	23.98	PASS
142	5710(U-NII 2C)	MCS0	18	35.748	15.53	23.98	PASS
142	5710 (U-NII 3)	MCS0	18	9.137	9.61	30	PASS
151	5755	MCS0	18	43.965	16.43	30	PASS
159	5795	MCS0	18.5	43.763	16.41	30	PASS

Unless otherwise stated the results shown in this test report refer only to the sample(s) tested and such sample(s) are retained for 90 days only.

除非另有說明，此報告結果僅對測試之樣品負責，同時此樣品僅保留90天。本報告未經本公司書面許可，不可部份複製。

This document is issued by the Company subject to its General Conditions of Service printed overleaf, available on request or accessible at <http://www.sgs.com.tw/Terms-and-Conditions>, and for electronic format documents, subject to Terms and Conditions for Electronic Documents at <http://www.sgs.com.tw/Terms-and-Conditions>. Attention is drawn to the limitation of liability, indemnification and jurisdiction issues defined therein. Any holder of this document is advised that information contained hereon reflects the Company's findings at the time of its intervention only and within the limits of Client's instructions, if any. The Company's sole responsibility is to its Client and this document does not exonerate parties to a transaction from exercising all their rights and obligations under the transaction documents. This document cannot be reproduced except in full, without prior written approval of the Company. Any unauthorized alteration, forgery or falsification of the content or appearance of this document is unlawful and offenders may be prosecuted to the fullest extent of the law.

802.11ac_VHT80_Ch0

CH	Frequency (MHz)	Data Rate	Power Setting	TOTAL POWER (mW)	TOTAL POWER (dBm)	REQUIRED LIMIT (dBm)	RESULT
42	5210	MCS0	10	10.386	10.16	23.98	PASS
58	5290	MCS0	9	8.156	9.11	23.98	PASS
106	5530	MCS0	10	10.080	10.03	23.98	PASS
122	5610	MCS0	17.5	38.588	15.86	23.98	PASS
138	5690(U-NII 2C)	MCS0	17	30.295	14.81	23.98	PASS
138	5690 (U-NII 3)	MCS0	17	4.175	6.21	30	PASS
155	5775	MCS0	17.5	34.710	15.40	30	PASS

Unless otherwise stated the results shown in this test report refer only to the sample(s) tested and such sample(s) are retained for 90 days only.

除非另有說明，此報告結果僅對測試之樣品負責，同時此樣品僅保留90天。本報告未經本公司書面許可，不可部份複製。

This document is issued by the Company subject to its General Conditions of Service printed overleaf, available on request or accessible at <http://www.sgs.com.tw/Terms-and-Conditions> and for electronic format documents, subject to Terms and Conditions for Electronic Documents at <http://www.sgs.com.tw/Terms-and-Conditions>. Attention is drawn to the limitation of liability, indemnification and jurisdiction issues defined therein. Any holder of this document is advised that information contained hereon reflects the Company's findings at the time of its intervention only and within the limits of Client's instructions, if any. The Company's sole responsibility is to its Client and this document does not exonerate parties to a transaction from exercising all their rights and obligations under the transaction documents. This document cannot be reproduced except in full, without prior written approval of the Company. Any unauthorized alteration, forgery or falsification of the content or appearance of this document is unlawful and offenders may be prosecuted to the fullest extent of the law.

SGS Taiwan Ltd.

No.134,Wu Kung Road, New Taipei Industrial Park, Wuku District, New Taipei City, Taiwan/新北市五股區新北產業園區五工路 134 號

台灣檢驗科技股份有限公司

t (886-2) 2299-3279

f (886-2) 2298-0488

www.sgs.com.tw

Member of SGS Group

8 UNDESIRABLE RADIATED EMISSION MEASUREMENT

8.1 Standard Applicable

$EIRP = (E \cdot d)^2 / 30$, where E is the field strength in V/m, d is the measurement distance (3m), $EIRP$ is the equivalent isotropically radiated power in Watts.

8.1.1 5150~5850 MHz

Applicable to	Operation Freq. (MHz)	EIRP		Field Strength @ 3m (dBμV/m)
		Freq. (MHz)	Limits (dBm/MHz)	
15.407(b)(1) RSS-247 §6.2.1.2	5150~5250	f ≤ 5150 f ≥ 5350	PK: -27	PK: 68.2
15.407(b)(2) RSS-247 §6.2.2.2	5250~5350			
15.407(b)(3) RSS-247 §6.2.3.2	5475~5725			
15.407(b)(4)(i) RSS-247 §6.2.4.3	5725~5850	at 75 MHz or more above or below the band edge	PK:-27	PK: 68.2
		increasing linearly from 75~25MHz above or below the band edge	PK:-27~10	PK: 68.2~105.2
		increasing linearly from 25~5MHz above or below the band edge	PK:10~15.6	PK: 105.2~110.8
		increasing linearly from 5~0 MHz above or below the band edge	PK: 15.6~27	PK:110.8~122.2

8.1.2 Spurious Emission

Unwanted spurious emissions which fall in the restricted bands must comply with the radiated emission limits specified as below table:

Frequency (MHz)	Field strength (microvolts/meter)	Distance (meters)
0.009-0.490	2400/F(kHz)	300
0.490-1.705	24000/F(kHz)	30
1.705-30	30	30
30-88	100	3
88-216	150	3
216-960	200	3
Above 960	500	3

Note:

1. The lower limit shall apply at the transition frequencies.

Unless otherwise stated the results shown in this test report refer only to the sample(s) tested and such sample(s) are retained for 90 days only.

除非另有說明，此報告結果僅對測試之樣品負責，同時此樣品僅保留90天。本報告未經本公司書面許可，不可部份複製。

This document is issued by the Company subject to its General Conditions of Service printed overleaf, available on request or accessible at <http://www.sgs.com.tw/Terms-and-Conditions>, and for electronic format documents, subject to Terms and Conditions for Electronic Documents at <http://www.sgs.com.tw/Terms-and-Conditions>. Attention is drawn to the limitation of liability, indemnification and jurisdiction issues defined therein. Any holder of this document is advised that information contained hereon reflects the Company's findings at the time of its intervention only and within the limits of Client's instructions, if any. The Company's sole responsibility is to its Client and this document does not exonerate parties to a transaction from exercising all their rights and obligations under the transaction documents. This document cannot be reproduced except in full, without prior written approval of the Company. Any unauthorized alteration, forgery or falsification of the content or appearance of this document is unlawful and offenders may be prosecuted to the fullest extent of the law.

8.2 Test Setup

(A) Radiated Emission Test Set-Up, Frequency Below 30MHz.

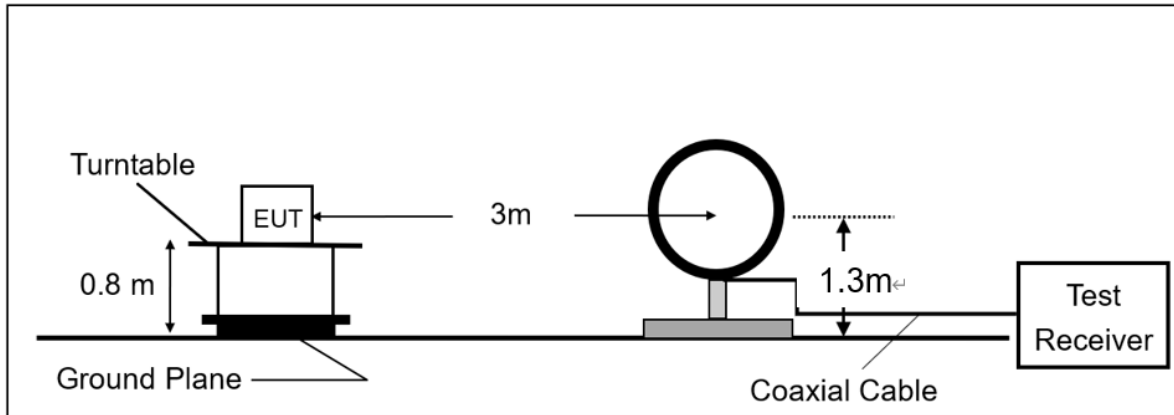

(B) Radiated Emission Test Set-Up, Frequency From 30MHz to 1000MHz

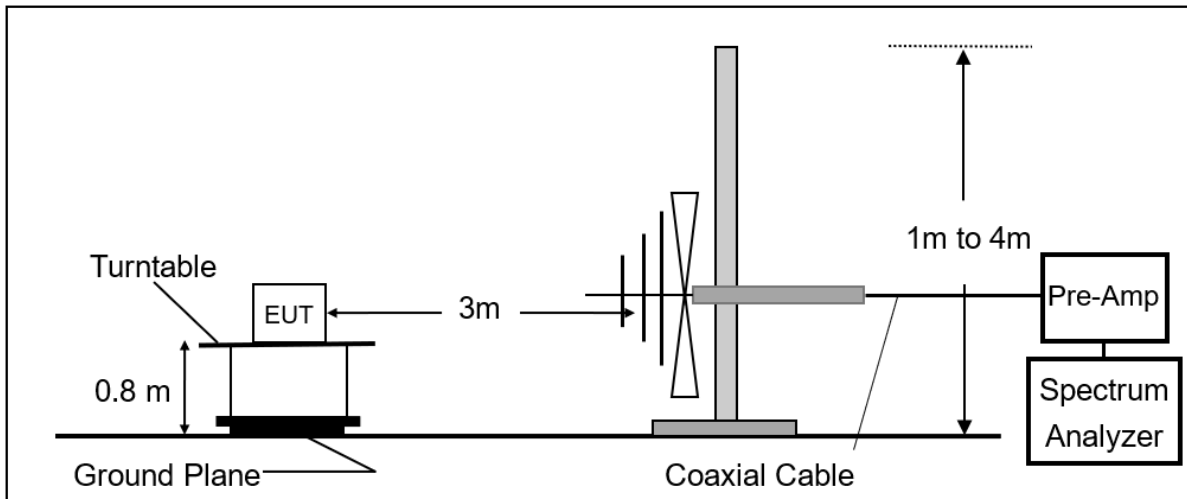

(C) Radiated Emission Test Set-Up, Frequency Above 1GHz

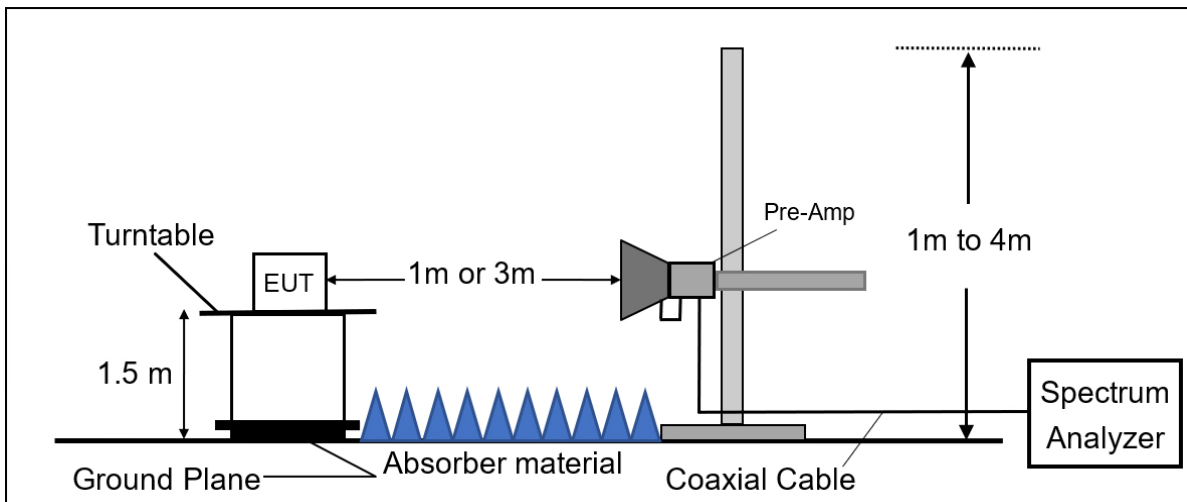

Unless otherwise stated the results shown in this test report refer only to the sample(s) tested and such sample(s) are retained for 90 days only.

除非另有說明，此報告結果僅對測試之樣品負責，同時此樣品僅保留90天。本報告未經本公司書面許可，不可部份複製。

This document is issued by the Company subject to its General Conditions of Service printed overleaf, available on request or accessible at <http://www.sgs.com.tw/Terms-and-Conditions> and for electronic format documents, subject to Terms and Conditions for Electronic Documents at <http://www.sgs.com.tw/Terms-and-Conditions>. Attention is drawn to the limitation of liability, indemnification and jurisdiction issues defined therein. Any holder of this document is advised that information contained herein reflects the Company's findings at the time of its intervention only and within the limits of Client's instructions, if any. The Company's sole responsibility is to its Client and this document does not exonerate parties to a transaction from exercising all their rights and obligations under the transaction documents. This document cannot be reproduced except in full, without prior written approval of the Company. Any unauthorized alteration, forgery or falsification of the content or appearance of this document is unlawful and offenders may be prosecuted to the fullest extent of the law.

8.3 Measurement Procedure

1. The testing follows FCC KDB 789033 D02.
2. The EUT was placed on a turn table with 0.8m for frequency < 1GHz and 1.5m for frequency > 1GHz above ground plane.
3. The turn table shall rotate 360 degrees to determine the position of maximum emission level.
4. EUT is set 3m away from the receiving antenna which varied from 1m to 4m to find out the highest emissions.
5. Set the spectrum analyzer as RBW=100 kHz and VBW=300 kHz for Peak Detector (PK) at frequency between 30MHz and 1 GHz
6. Use receiver mode as RBW=120 kHz for Quasi-peak (QP) at frequency between 30MHz and 1 GHz.
7. Set the spectrum analyzer as RBW=1 MHz, VBW=3 MHz for Maximum Emission Measurements at frequency above 1 GHz.
8. Set the spectrum analyzer as RBW=1 MHz, VBW=10 Hz (Duty cycle > 98%) or VBW ≥ 1/T (Duty cycle < 98%) for Average Emission Measurements at frequency above 1 GHz.
9. When measurement procedures for electric field radiated emissions above 1 GHz the EUT measurement is to be made “while keeping the antenna in the ‘cone of radiation’ from that area and pointed at the area both in azimuth and elevation, with polarization oriented for maximum response.” is still within the 3dB illumination BW of the measurement antenna.
10. Maximum procedure was performed on the six highest emissions to ensure EUT compliance.
11. And also, each emission was to be maximized by changing the polarization of receiving antenna both horizontal and vertical.
12. Repeat above procedures until all frequency measured were complete.

Unless otherwise stated the results shown in this test report refer only to the sample(s) tested and such sample(s) are retained for 90 days only.

除非另有說明，此報告結果僅對測試之樣品負責，同時此樣品僅保留90天。本報告未經本公司書面許可，不可部份複製。

This document is issued by the Company subject to its General Conditions of Service printed overleaf, available on request or accessible at <http://www.sgs.com.tw/Terms-and-Conditions> and for electronic format documents, subject to Terms and Conditions for Electronic Documents at <http://www.sgs.com.tw/Terms-and-Conditions>. Attention is drawn to the limitation of liability, indemnification and jurisdiction issues defined therein. Any holder of this document is advised that information contained hereon reflects the Company's findings at the time of its intervention only and within the limits of Client's instructions, if any. The Company's sole responsibility is to its Client and this document does not exonerate parties to a transaction from exercising all their rights and obligations under the transaction documents. This document cannot be reproduced except in full, without prior written approval of the Company. Any unauthorized alteration, forgery or falsification of the content or appearance of this document is unlawful and offenders may be prosecuted to the fullest extent of the law.

8.4 Field Strength Calculation

The field strength is calculated by adding the Antenna Factor and Cable Factor and subtracting the Amplifier Gain and Duty Cycle Correction Factor (if any) from the measured reading. The basic equation with a sample calculation is as follows:

$$FS = RA + AF + CL - AG$$

Where *FS* = Field Strength

CL = Cable Attenuation Factor (Cable Loss)

RA = Reading Amplitude

AG = Amplifier Gain

AF = Antenna Factor

The limit of the emission level is expressed in dBuV/m, which converts $20 \cdot \log(uV/m)$

Actual FS(dBuV/m) = SPA. Reading level(dBuV) + Factor(dB)

Factor(dB) = Antenna Factor(dBuV/m) + Cable Loss(dB) – Pre_Amplifier Gain(dB)

8.5 Test Results of Radiated Spurious Emissions from 9 kHz to 30 MHz

The low frequency, which started from 9 kHz to 30MHz, was pre-scanned and the result which was 20dB lower than the limit per 15.31(o) was not reported.

Unless otherwise stated the results shown in this test report refer only to the sample(s) tested and such sample(s) are retained for 90 days only.
 除非另有說明，此報告結果僅對測試之樣品負責，同時此樣品僅保留90天。本報告未經本公司書面許可，不可部份複製。

This document is issued by the Company subject to its General Conditions of Service printed overleaf, available on request or accessible at <http://www.sgs.com.tw/Terms-and-Conditions> and for electronic format documents, subject to Terms and Conditions for Electronic Documents at <http://www.sgs.com.tw/Terms-and-Conditions>. Attention is drawn to the limitation of liability, indemnification and jurisdiction issues defined therein. Any holder of this document is advised that information contained hereon reflects the Company's findings at the time of its intervention only and within the limits of Client's instructions, if any. The Company's sole responsibility is to its Client and this document does not exonerate parties to a transaction from exercising all their rights and obligations under the transaction documents. This document cannot be reproduced except in full, without prior written approval of the Company. Any unauthorized alteration, forgery or falsification of the content or appearance of this document is unlawful and offenders may be prosecuted to the fullest extent of the law.

SGS Taiwan Ltd. No.134,Wu Kung Road, New Taipei Industrial Park, Wuku District, New Taipei City, Taiwan/新北市五股區新北產業園區五工路 134 號

8.6 Radiated Spurious Emission Measurement Result

8.6.1 Spurious Emission

Report Number	:TERF2403000759E2	Test Site	:SAC G Chamber
Operation Mode	:802.11a	Test Date	:2024-03-29
Test Frequency	:5220 MHz	Temp./Humi.	:24.3°C/58%
Test Mode	:Tx	Antenna Pol.	:Vertical
EUT Pol	:E2 Plane	Engineer	:Temo Chen

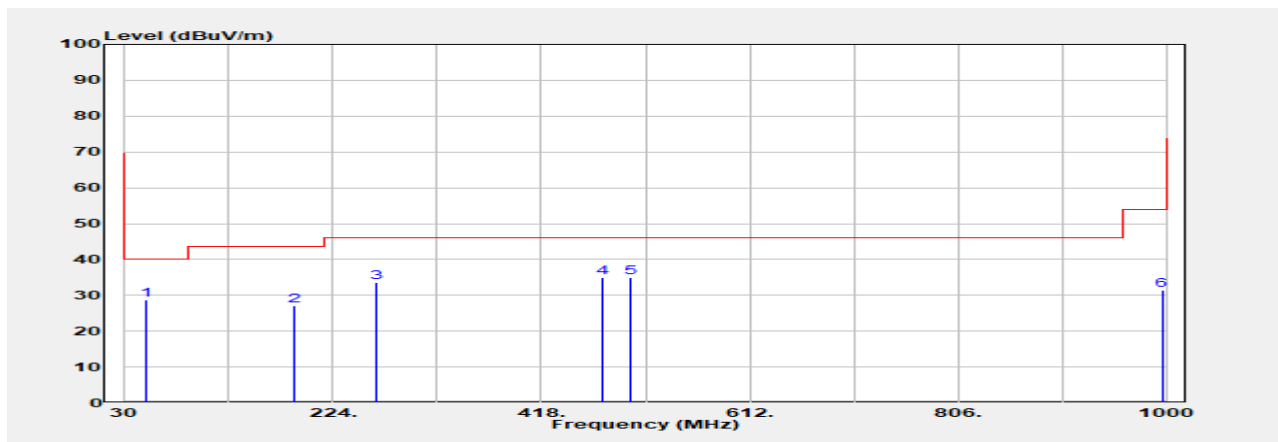

Freq. MHz	Detector Mode PK/QP/AVG	Spectrum Reading Level dB μ V	Factor dB	Actual FS dB μ V/m	Limit @3m dB μ V/m	Margin dB
50.370	QP	41.30	-12.64	28.66	40.00	-11.34
188.110	Peak	42.24	-15.06	27.18	43.50	-16.32
264.740	Peak	46.79	-13.30	33.49	46.00	-12.51
475.230	Peak	42.34	-7.37	34.97	46.00	-11.03
500.450	Peak	42.26	-7.30	34.96	46.00	-11.04
996.120	Peak	30.55	0.77	31.32	54.00	-22.68

Unless otherwise stated the results shown in this test report refer only to the sample(s) tested and such sample(s) are retained for 90 days only.

除非另有說明，此報告結果僅對測試之樣品負責，同時此樣品僅保留90天。本報告未經本公司書面許可，不可部份複製。

This document is issued by the Company subject to its General Conditions of Service printed overleaf, available on request or accessible at <http://www.sgs.com.tw/Terms-and-Conditions> and for electronic format documents, subject to Terms and Conditions for Electronic Documents at <http://www.sgs.com.tw/Terms-and-Conditions>. Attention is drawn to the limitation of liability, indemnification and jurisdiction issues defined therein. Any holder of this document is advised that information contained hereon reflects the Company's findings at the time of its intervention only and within the limits of Client's instructions, if any. The Company's sole responsibility is to its Client and this document does not exonerate parties to a transaction from exercising all their rights and obligations under the transaction documents. This document cannot be reproduced except in full, without prior written approval of the Company. Any unauthorized alteration, forgery or falsification of the content or appearance of this document is unlawful and offenders may be prosecuted to the fullest extent of the law.

Report Number :TERF2403000759E2
 Operation Mode :802.11a
 Test Frequency :5220 MHz
 Test Mode :Tx
 EUT Pol :E2 Plane

Test Site :SAC G Chamber
 Test Date :2024-03-29
 Temp./Humi. :24.3°C/58%
 Antenna Pol. :Horizontal
 Engineer :Temo Chen

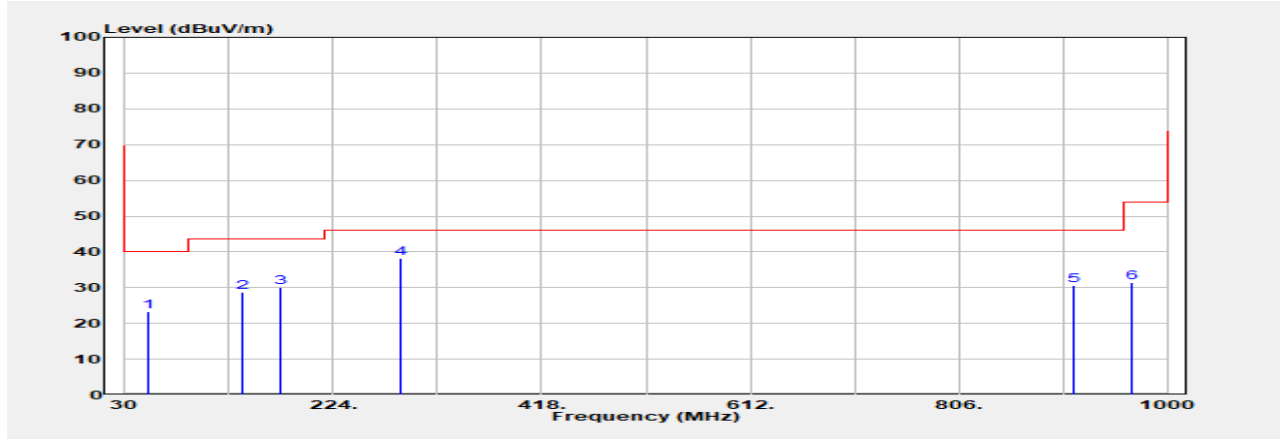

Freq. MHz	Detector Mode PK/QP/AVG	Spectrum Reading Level dBμV	Factor dB	Actual FS dBμV/m	Limit @3m dBμV/m	Margin dB
51.340	Peak	35.87	-12.61	23.26	40.00	-16.74
138.640	Peak	42.44	-13.63	28.81	43.50	-14.69
175.500	Peak	43.87	-13.88	29.99	43.50	-13.51
287.050	Peak	50.48	-12.20	38.29	46.00	-7.71
912.700	Peak	31.17	-0.41	30.76	46.00	-15.24
967.020	Peak	30.16	1.16	31.32	54.00	-22.68

Unless otherwise stated the results shown in this test report refer only to the sample(s) tested and such sample(s) are retained for 90 days only.

除非另有說明，此報告結果僅對測試之樣品負責，同時此樣品僅保留90天。本報告未經本公司書面許可，不可部份複製。

This document is issued by the Company subject to its General Conditions of Service printed overleaf, available on request or accessible at <http://www.sgs.com.tw/Terms-and-Conditions> and for electronic format documents, subject to Terms and Conditions for Electronic Documents at <http://www.sgs.com.tw/Terms-and-Conditions>. Attention is drawn to the limitation of liability, indemnification and jurisdiction issues defined therein. Any holder of this document is advised that information contained hereon reflects the Company's findings at the time of its intervention only and within the limits of Client's instructions, if any. The Company's sole responsibility is to its Client and this document does not exonerate parties to a transaction from exercising all their rights and obligations under the transaction documents. This document cannot be reproduced except in full, without prior written approval of the Company. Any unauthorized alteration, forgery or falsification of the content or appearance of this document is unlawful and offenders may be prosecuted to the fullest extent of the law.

Report Number :TERF2403000759E2
 Operation Mode :802.11a
 Test Frequency :5300 MHz
 Test Mode :Tx
 EUT Pol :E2 Plane

Test Site :SAC G Chamber
 Test Date :2024-03-29
 Temp./Humi. :24.3°C/58%
 Antenna Pol. :Vertical
 Engineer :Temo Chen

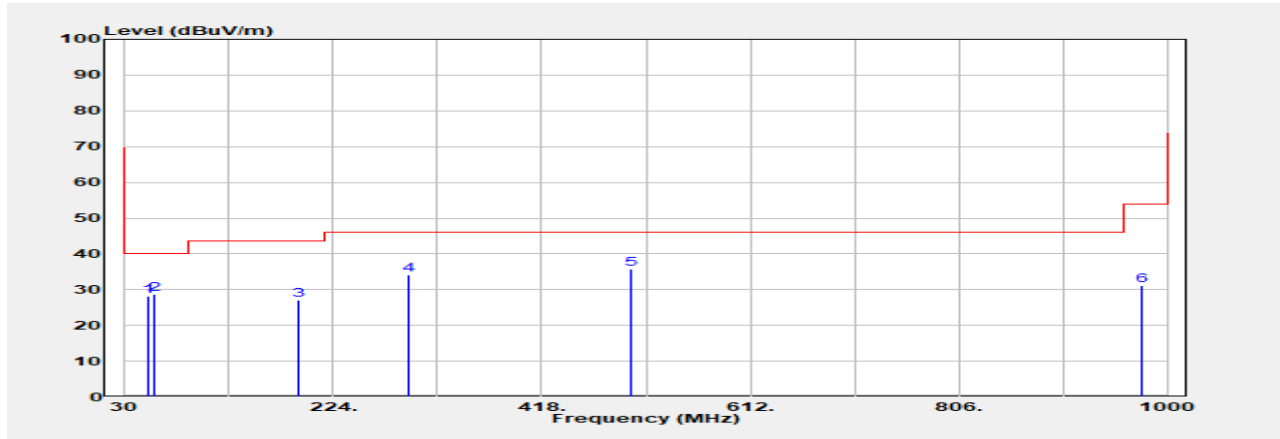

Freq. MHz	Detector Mode PK/QP/AVG	Spectrum Reading Level dBμV	Factor dB	Actual FS dBμV/m	Limit @3m dBμV/m	Margin dB
51.340	QP	40.70	-12.61	28.09	40.00	-11.91
58.130	Peak	41.80	-12.95	28.85	40.00	-11.15
191.990	Peak	42.55	-15.34	27.21	43.50	-16.29
293.840	Peak	46.22	-12.09	34.12	46.00	-11.88
501.420	Peak	43.02	-7.26	35.76	46.00	-10.24
976.720	Peak	30.22	1.03	31.25	54.00	-22.75

Unless otherwise stated the results shown in this test report refer only to the sample(s) tested and such sample(s) are retained for 90 days only.

除非另有說明，此報告結果僅對測試之樣品負責，同時此樣品僅保留90天。本報告未經本公司書面許可，不可部份複製。

This document is issued by the Company subject to its General Conditions of Service printed overleaf, available on request or accessible at <http://www.sgs.com.tw/Terms-and-Conditions> and for electronic format documents, subject to Terms and Conditions for Electronic Documents at <http://www.sgs.com.tw/Terms-and-Conditions>. Attention is drawn to the limitation of liability, indemnification and jurisdiction issues defined therein. Any holder of this document is advised that information contained hereon reflects the Company's findings at the time of its intervention only and within the limits of Client's instructions, if any. The Company's sole responsibility is to its Client and this document does not exonerate parties to a transaction from exercising all their rights and obligations under the transaction documents. This document cannot be reproduced except in full, without prior written approval of the Company. Any unauthorized alteration, forgery or falsification of the content or appearance of this document is unlawful and offenders may be prosecuted to the fullest extent of the law.

Report Number :TERF2403000759E2
 Operation Mode :802.11a
 Test Frequency :5300 MHz
 Test Mode :Tx
 EUT Pol :E2 Plane

Test Site :SAC G Chamber
 Test Date :2024-03-29
 Temp./Humi. :24.3°C/58%
 Antenna Pol. :Horizontal
 Engineer :Temo Chen

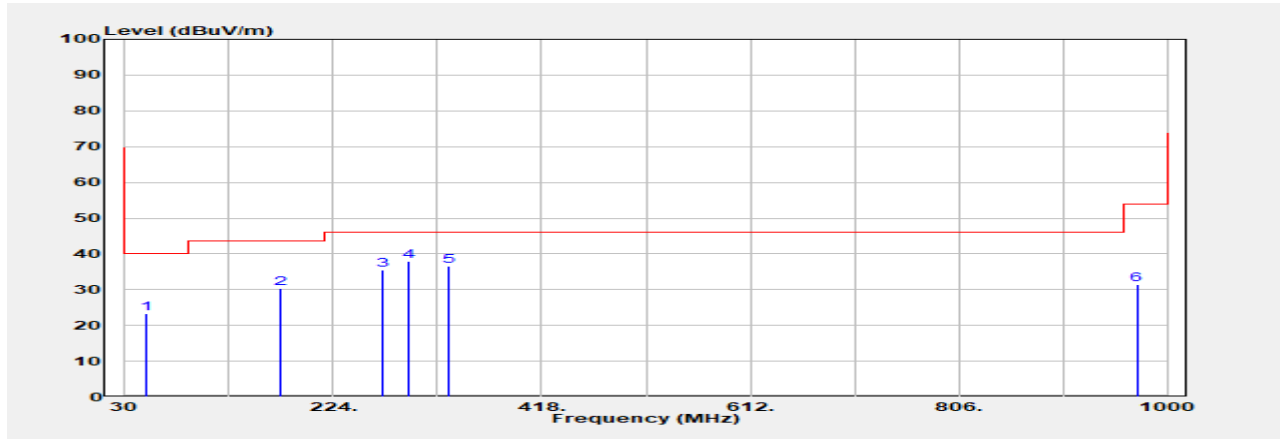

Freq. MHz	Detector Mode PK/QP/AVG	Spectrum Reading Level dBμV	Factor dB	Actual FS dBμV/m	Limit @3m dBμV/m	Margin dB
50.370	Peak	36.07	-12.64	23.43	40.00	-16.57
175.500	Peak	44.15	-13.88	30.27	43.50	-13.23
269.590	QP	48.40	-12.94	35.46	46.00	-10.54
294.810	Peak	50.14	-12.08	38.06	46.00	-7.94
331.670	Peak	47.66	-11.12	36.54	46.00	-9.46
971.870	Peak	30.20	1.22	31.42	54.00	-22.58

Unless otherwise stated the results shown in this test report refer only to the sample(s) tested and such sample(s) are retained for 90 days only.

除非另有說明，此報告結果僅對測試之樣品負責，同時此樣品僅保留90天。本報告未經本公司書面許可，不可部份複製。

This document is issued by the Company subject to its General Conditions of Service printed overleaf, available on request or accessible at <http://www.sgs.com.tw/Terms-and-Conditions> and for electronic format documents, subject to Terms and Conditions for Electronic Documents at <http://www.sgs.com.tw/Terms-and-Conditions>. Attention is drawn to the limitation of liability, indemnification and jurisdiction issues defined therein. Any holder of this document is advised that information contained hereon reflects the Company's findings at the time of its intervention only and within the limits of Client's instructions, if any. The Company's sole responsibility is to its Client and this document does not exonerate parties to a transaction from exercising all their rights and obligations under the transaction documents. This document cannot be reproduced except in full, without prior written approval of the Company. Any unauthorized alteration, forgery or falsification of the content or appearance of this document is unlawful and offenders may be prosecuted to the fullest extent of the law.

Report Number :TERF2403000759E2
 Operation Mode :802.11a
 Test Frequency :5580 MHz
 Test Mode :Tx
 EUT Pol :E2 Plane

Test Site :SAC G Chamber
 Test Date :2024-03-29
 Temp./Humi. :24.3°C/58%
 Antenna Pol. :Vertical
 Engineer :Temo Chen

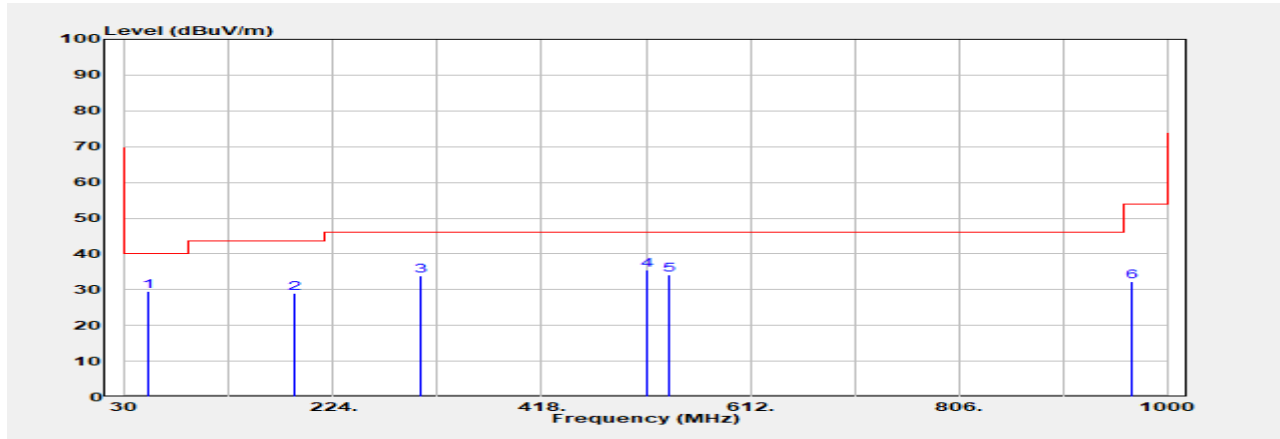

Freq. MHz	Detector Mode PK/QP/AVG	Spectrum Reading Level dBμV	Factor dB	Actual FS dBμV/m	Limit @3m dBμV/m	Margin dB
51.340	QP	42.10	-12.61	29.49	40.00	-10.51
188.110	Peak	43.95	-15.06	28.89	43.50	-14.61
305.480	Peak	45.65	-11.85	33.80	46.00	-12.20
515.970	Peak	42.42	-6.99	35.43	46.00	-10.57
536.340	Peak	41.13	-7.06	34.06	46.00	-11.94
967.990	Peak	30.98	1.21	32.19	54.00	-21.81

Unless otherwise stated the results shown in this test report refer only to the sample(s) tested and such sample(s) are retained for 90 days only.

除非另有說明，此報告結果僅對測試之樣品負責，同時此樣品僅保留90天。本報告未經本公司書面許可，不可部份複製。

This document is issued by the Company subject to its General Conditions of Service printed overleaf, available on request or accessible at <http://www.sgs.com.tw/Terms-and-Conditions> and for electronic format documents, subject to Terms and Conditions for Electronic Documents at <http://www.sgs.com.tw/Terms-and-Conditions>. Attention is drawn to the limitation of liability, indemnification and jurisdiction issues defined therein. Any holder of this document is advised that information contained hereon reflects the Company's findings at the time of its intervention only and within the limits of Client's instructions, if any. The Company's sole responsibility is to its Client and this document does not exonerate parties to a transaction from exercising all their rights and obligations under the transaction documents. This document cannot be reproduced except in full, without prior written approval of the Company. Any unauthorized alteration, forgery or falsification of the content or appearance of this document is unlawful and offenders may be prosecuted to the fullest extent of the law.

Report Number :TERF2403000759E2
 Operation Mode :802.11a
 Test Frequency :5580 MHz
 Test Mode :Tx
 EUT Pol :E2 Plane

Test Site :SAC G Chamber
 Test Date :2024-03-29
 Temp./Humi. :24.3°C/58%
 Antenna Pol. :Horizontal
 Engineer :Temo Chen

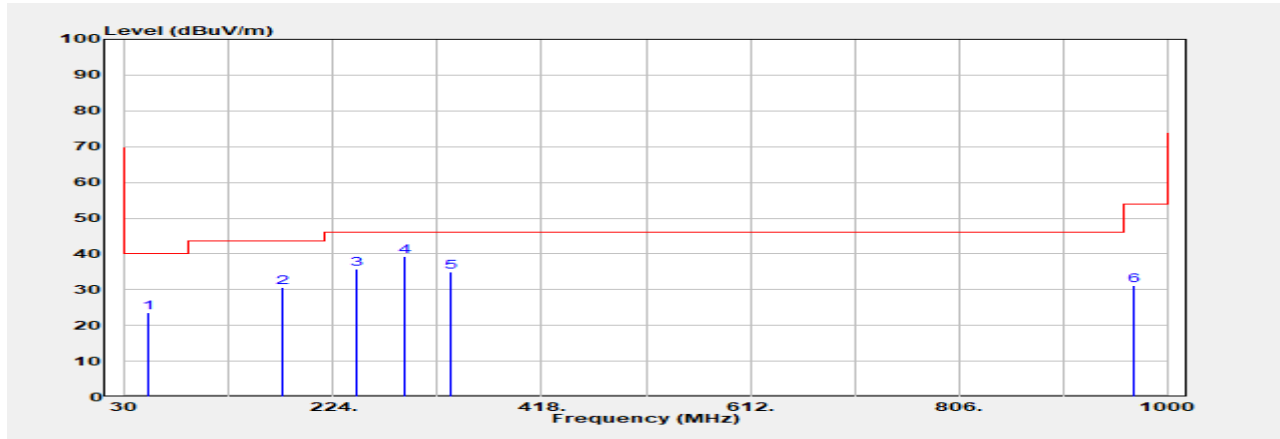

Freq. MHz	Detector Mode PK/QP/AVG	Spectrum Reading Level dBμV	Factor dB	Actual FS dBμV/m	Limit @3m dBμV/m	Margin dB
51.340	Peak	36.19	-12.61	23.58	40.00	-16.42
177.440	Peak	44.68	-14.13	30.55	43.50	-12.95
245.340	Peak	49.74	-13.96	35.78	46.00	-10.22
290.930	Peak	51.30	-12.13	39.17	46.00	-6.83
333.610	Peak	46.03	-11.10	34.93	46.00	-11.07
968.960	Peak	30.03	1.25	31.28	54.00	-22.72

Unless otherwise stated the results shown in this test report refer only to the sample(s) tested and such sample(s) are retained for 90 days only.

除非另有說明，此報告結果僅對測試之樣品負責，同時此樣品僅保留90天。本報告未經本公司書面許可，不可部份複製。

This document is issued by the Company subject to its General Conditions of Service printed overleaf, available on request or accessible at <http://www.sgs.com.tw/Terms-and-Conditions> and for electronic format documents, subject to Terms and Conditions for Electronic Documents at <http://www.sgs.com.tw/Terms-and-Conditions>. Attention is drawn to the limitation of liability, indemnification and jurisdiction issues defined therein. Any holder of this document is advised that information contained hereon reflects the Company's findings at the time of its intervention only and within the limits of Client's instructions, if any. The Company's sole responsibility is to its Client and this document does not exonerate parties to a transaction from exercising all their rights and obligations under the transaction documents. This document cannot be reproduced except in full, without prior written approval of the Company. Any unauthorized alteration, forgery or falsification of the content or appearance of this document is unlawful and offenders may be prosecuted to the fullest extent of the law.

Report Number :TERF2403000759E2
 Operation Mode :802.11a
 Test Frequency :5785 MHz
 Test Mode :Tx
 EUT Pol :E2 Plane

Test Site :SAC G Chamber
 Test Date :2024-03-29
 Temp./Humi. :24.3°C/58%
 Antenna Pol. :Vertical
 Engineer :Temo Chen

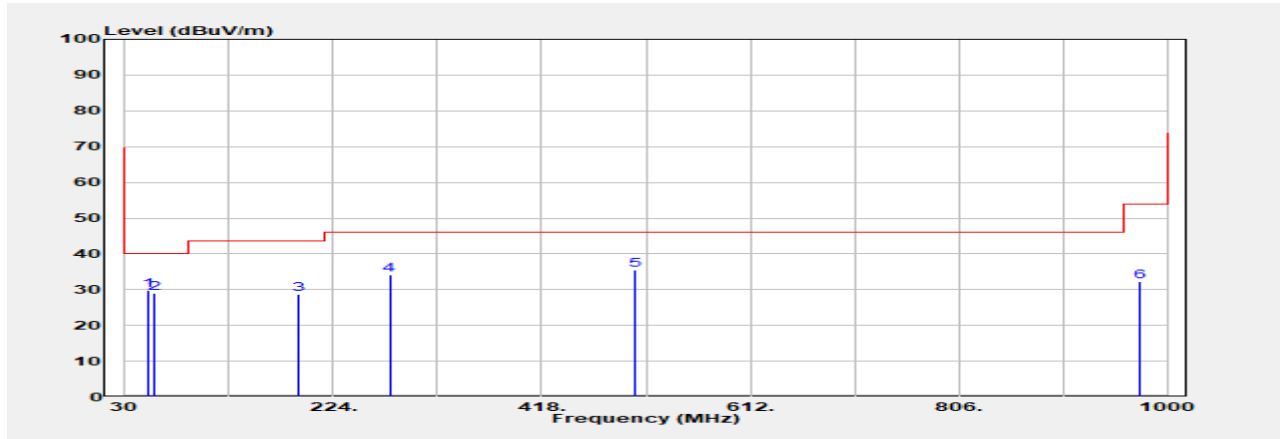

Freq. MHz	Detector Mode PK/QP/AVG	Spectrum Reading Level dBμV	Factor dB	Actual FS dBμV/m	Limit @3m dBμV/m	Margin dB
51.340	QP	42.50	-12.61	29.89	40.00	-10.11
58.130	Peak	41.95	-12.95	29.00	40.00	-11.00
191.020	Peak	44.02	-15.33	28.69	43.50	-14.81
276.380	Peak	46.74	-12.61	34.13	46.00	-11.87
504.330	Peak	42.78	-7.15	35.63	46.00	-10.37
973.810	Peak	31.00	1.13	32.13	54.00	-21.87

Unless otherwise stated the results shown in this test report refer only to the sample(s) tested and such sample(s) are retained for 90 days only.

除非另有說明，此報告結果僅對測試之樣品負責，同時此樣品僅保留90天。本報告未經本公司書面許可，不可部份複製。

This document is issued by the Company subject to its General Conditions of Service printed overleaf, available on request or accessible at <http://www.sgs.com.tw/Terms-and-Conditions> and for electronic format documents, subject to Terms and Conditions for Electronic Documents at <http://www.sgs.com.tw/Terms-and-Conditions>. Attention is drawn to the limitation of liability, indemnification and jurisdiction issues defined therein. Any holder of this document is advised that information contained hereon reflects the Company's findings at the time of its intervention only and within the limits of Client's instructions, if any. The Company's sole responsibility is to its Client and this document does not exonerate parties to a transaction from exercising all their rights and obligations under the transaction documents. This document cannot be reproduced except in full, without prior written approval of the Company. Any unauthorized alteration, forgery or falsification of the content or appearance of this document is unlawful and offenders may be prosecuted to the fullest extent of the law.

Report Number :TERF2403000759E2
 Operation Mode :802.11a
 Test Frequency :5785 MHz
 Test Mode :Tx
 EUT Pol :E2 Plane

Test Site :SAC G Chamber
 Test Date :2024-03-29
 Temp./Humi. :24.3°C/58%
 Antenna Pol. :Horizontal
 Engineer :Temo Chen

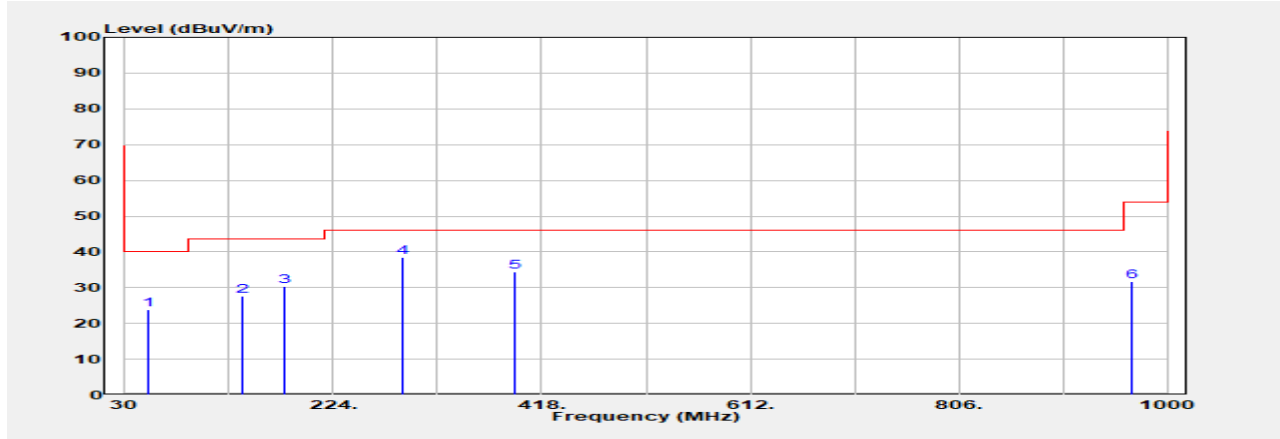

Freq. MHz	Detector Mode PK/QP/AVG	Spectrum Reading Level dB μ V	Factor dB	Actual FS dB μ V/m	Limit @3m dB μ V/m	Margin dB
51.340	Peak	36.48	-12.61	23.87	40.00	-16.13
139.610	Peak	41.21	-13.59	27.62	43.50	-15.88
178.410	Peak	44.44	-14.20	30.24	43.50	-13.26
288.020	Peak	50.56	-12.18	38.38	46.00	-7.62
393.750	Peak	43.86	-9.34	34.52	46.00	-11.48
967.990	Peak	30.62	1.21	31.82	54.00	-22.18

Unless otherwise stated the results shown in this test report refer only to the sample(s) tested and such sample(s) are retained for 90 days only.

除非另有說明，此報告結果僅對測試之樣品負責，同時此樣品僅保留90天。本報告未經本公司書面許可，不可部份複製。

This document is issued by the Company subject to its General Conditions of Service printed overleaf, available on request or accessible at <http://www.sgs.com.tw/Terms-and-Conditions> and for electronic format documents, subject to Terms and Conditions for Electronic Documents at <http://www.sgs.com.tw/Terms-and-Conditions>. Attention is drawn to the limitation of liability, indemnification and jurisdiction issues defined therein. Any holder of this document is advised that information contained hereon reflects the Company's findings at the time of its intervention only and within the limits of Client's instructions, if any. The Company's sole responsibility is to its Client and this document does not exonerate parties to a transaction from exercising all their rights and obligations under the transaction documents. This document cannot be reproduced except in full, without prior written approval of the Company. Any unauthorized alteration, forgery or falsification of the content or appearance of this document is unlawful and offenders may be prosecuted to the fullest extent of the law.

Report Number :TERF2403000759E2
 Operation Mode :802.11a
 Test Frequency :5180 MHz
 Test Mode :Tx
 EUT Pol :E2 Plane

Test Site :SAC G Chamber
 Test Date :2024-03-29
 Temp./Humi. :24.3°C/58%
 Antenna Pol. :Vertical
 Engineer :Temo Chen

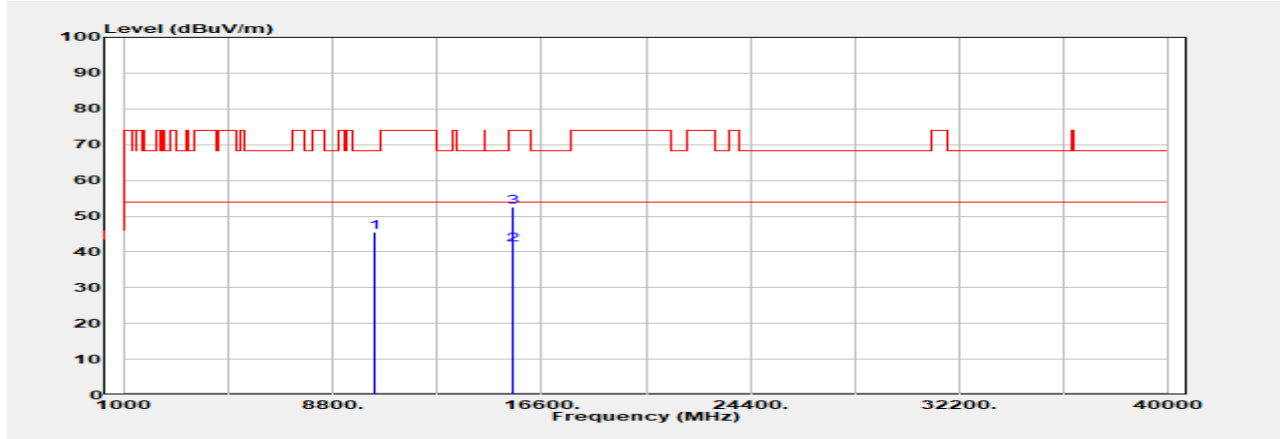

Freq. MHz	Detector Mode PK/QP/AVG	Spectrum Reading Level dB μ V	Factor dB	Actual FS dB μ V/m	Limit @3m dB μ V/m	Margin dB
10360.000	Peak	35.62	9.94	45.56	68.20	-22.64
15540.000	Average	29.46	12.54	42.00	54.00	-12.00
15540.000	Peak	39.93	12.54	52.46	74.00	-21.54

Unless otherwise stated the results shown in this test report refer only to the sample(s) tested and such sample(s) are retained for 90 days only.

除非另有說明，此報告結果僅對測試之樣品負責，同時此樣品僅保留90天。本報告未經本公司書面許可，不可部份複製。

This document is issued by the Company subject to its General Conditions of Service printed overleaf, available on request or accessible at <http://www.sgs.com.tw/Terms-and-Conditions> and for electronic format documents, subject to Terms and Conditions for Electronic Documents at <http://www.sgs.com.tw/Terms-and-Conditions>. Attention is drawn to the limitation of liability, indemnification and jurisdiction issues defined therein. Any holder of this document is advised that information contained hereon reflects the Company's findings at the time of its intervention only and within the limits of Client's instructions, if any. The Company's sole responsibility is to its Client and this document does not exonerate parties to a transaction from exercising all their rights and obligations under the transaction documents. This document cannot be reproduced except in full, without prior written approval of the Company. Any unauthorized alteration, forgery or falsification of the content or appearance of this document is unlawful and offenders may be prosecuted to the fullest extent of the law.

Report Number :TERF2403000759E2
 Operation Mode :802.11a
 Test Frequency :5180 MHz
 Test Mode :Tx
 EUT Pol :E2 Plane

Test Site :SAC G Chamber
 Test Date :2024-03-29
 Temp./Humi. :24.3°C/58%
 Antenna Pol. :Horizontal
 Engineer :Temo Chen

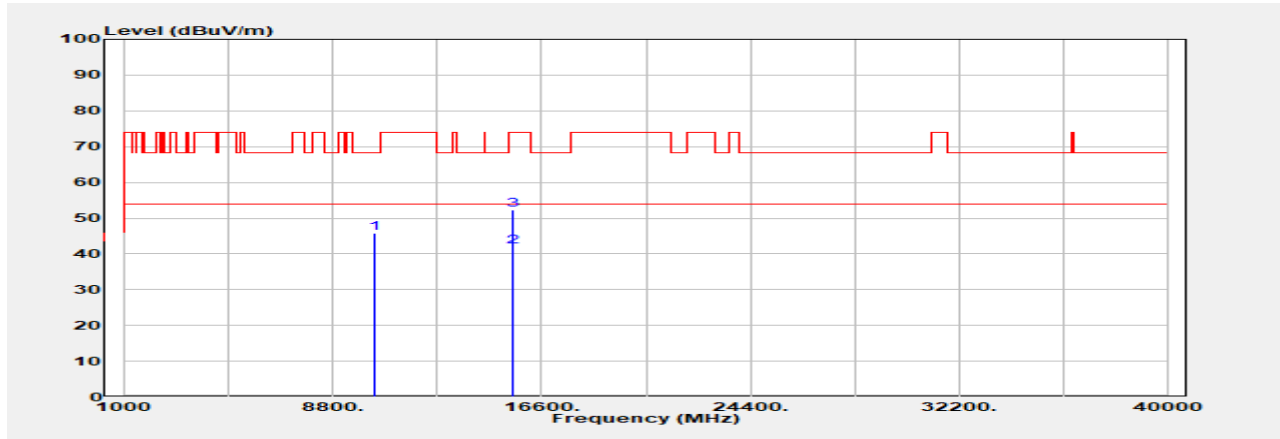

Freq. MHz	Detector Mode PK/QP/AVG	Spectrum Reading Level dB μ V	Factor dB	Actual FS dB μ V/m	Limit @3m dB μ V/m	Margin dB
10360.000	Peak	35.74	9.94	45.68	68.20	-22.52
15540.000	Average	29.54	12.54	42.08	54.00	-11.92
15540.000	Peak	39.84	12.54	52.38	74.00	-21.62

Unless otherwise stated the results shown in this test report refer only to the sample(s) tested and such sample(s) are retained for 90 days only.

除非另有說明，此報告結果僅對測試之樣品負責，同時此樣品僅保留90天。本報告未經本公司書面許可，不可部份複製。

This document is issued by the Company subject to its General Conditions of Service printed overleaf, available on request or accessible at <http://www.sgs.com.tw/Terms-and-Conditions> and for electronic format documents, subject to Terms and Conditions for Electronic Documents at <http://www.sgs.com.tw/Terms-and-Conditions>. Attention is drawn to the limitation of liability, indemnification and jurisdiction issues defined therein. Any holder of this document is advised that information contained hereon reflects the Company's findings at the time of its intervention only and within the limits of Client's instructions, if any. The Company's sole responsibility is to its Client and this document does not exonerate parties to a transaction from exercising all their rights and obligations under the transaction documents. This document cannot be reproduced except in full, without prior written approval of the Company. Any unauthorized alteration, forgery or falsification of the content or appearance of this document is unlawful and offenders may be prosecuted to the fullest extent of the law.

Report Number :TERF2403000759E2
 Operation Mode :802.11a
 Test Frequency :5220 MHz
 Test Mode :Tx
 EUT Pol :E2 Plane

Test Site :SAC G Chamber
 Test Date :2024-03-29
 Temp./Humi. :24.3°C/58%
 Antenna Pol. :Vertical
 Engineer :Temo Chen

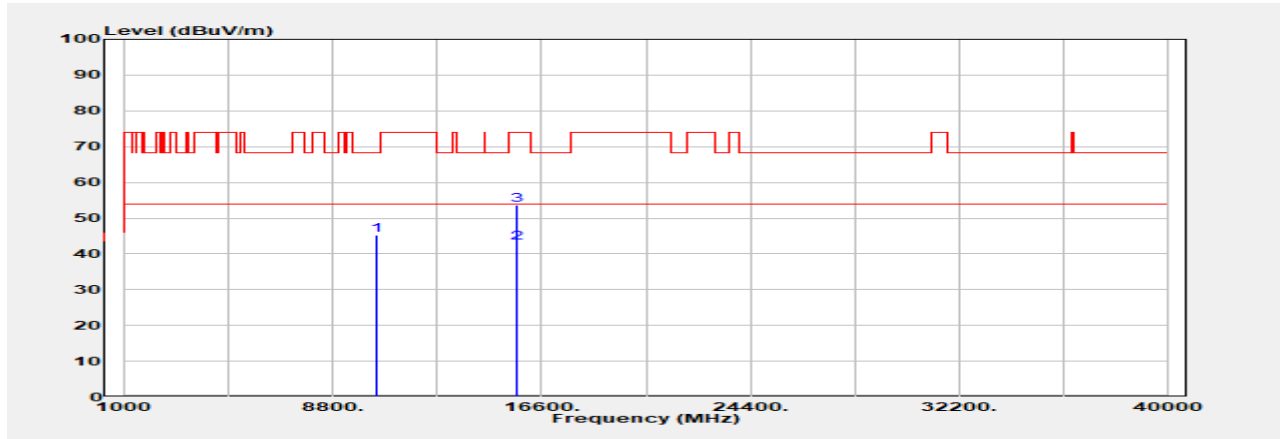

Freq. MHz	Detector Mode PK/QP/AVG	Spectrum Reading Level dB μ V	Factor dB	Actual FS dB μ V/m	Limit @3m dB μ V/m	Margin dB
10440.000	Peak	35.47	9.92	45.39	68.20	-22.81
15660.000	Average	29.93	13.20	43.12	54.00	-10.88
15660.000	Peak	40.43	13.20	53.63	74.00	-20.37

Unless otherwise stated the results shown in this test report refer only to the sample(s) tested and such sample(s) are retained for 90 days only.

除非另有說明，此報告結果僅對測試之樣品負責，同時此樣品僅保留90天。本報告未經本公司書面許可，不可部份複製。

This document is issued by the Company subject to its General Conditions of Service printed overleaf, available on request or accessible at <http://www.sgs.com.tw/Terms-and-Conditions> and for electronic format documents, subject to Terms and Conditions for Electronic Documents at <http://www.sgs.com.tw/Terms-and-Conditions>. Attention is drawn to the limitation of liability, indemnification and jurisdiction issues defined therein. Any holder of this document is advised that information contained hereon reflects the Company's findings at the time of its intervention only and within the limits of Client's instructions, if any. The Company's sole responsibility is to its Client and this document does not exonerate parties to a transaction from exercising all their rights and obligations under the transaction documents. This document cannot be reproduced except in full, without prior written approval of the Company. Any unauthorized alteration, forgery or falsification of the content or appearance of this document is unlawful and offenders may be prosecuted to the fullest extent of the law.

Report Number :TERF2403000759E2
 Operation Mode :802.11a
 Test Frequency :5220 MHz
 Test Mode :Tx
 EUT Pol :E2 Plane

Test Site :SAC G Chamber
 Test Date :2024-03-29
 Temp./Humi. :24.3°C/58%
 Antenna Pol. :Horizontal
 Engineer :Temo Chen

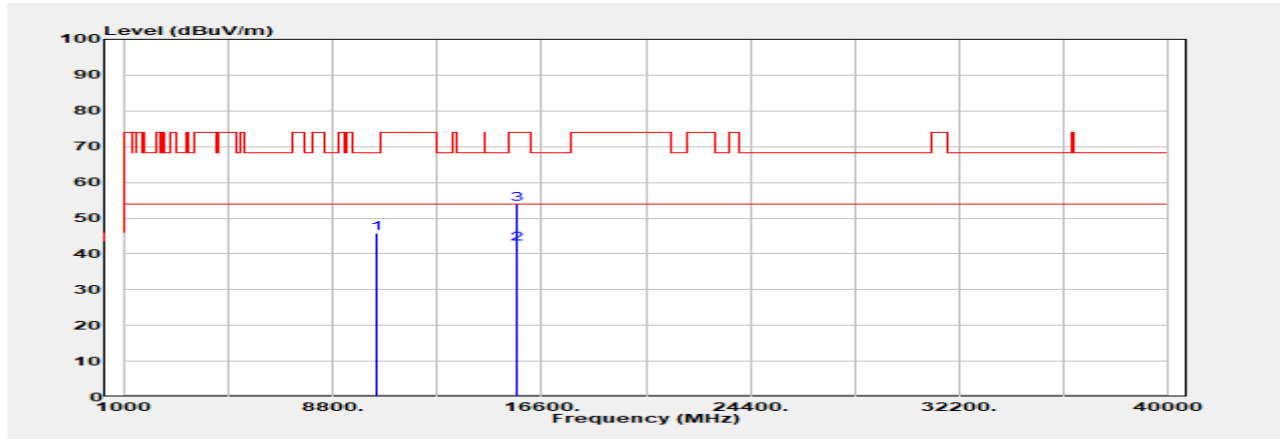

Freq. MHz	Detector Mode PK/QP/AVG	Spectrum Reading Level dB μ V	Factor dB	Actual FS dB μ V/m	Limit @3m dB μ V/m	Margin dB
10440.000	Peak	35.94	9.92	45.86	68.20	-22.34
15660.000	Average	29.70	13.20	42.90	54.00	-11.10
15660.000	Peak	40.62	13.20	53.82	74.00	-20.18

Unless otherwise stated the results shown in this test report refer only to the sample(s) tested and such sample(s) are retained for 90 days only.

除非另有說明，此報告結果僅對測試之樣品負責，同時此樣品僅保留90天。本報告未經本公司書面許可，不可部份複製。

This document is issued by the Company subject to its General Conditions of Service printed overleaf, available on request or accessible at <http://www.sgs.com.tw/Terms-and-Conditions> and for electronic format documents, subject to Terms and Conditions for Electronic Documents at <http://www.sgs.com.tw/Terms-and-Conditions>. Attention is drawn to the limitation of liability, indemnification and jurisdiction issues defined therein. Any holder of this document is advised that information contained hereon reflects the Company's findings at the time of its intervention only and within the limits of Client's instructions, if any. The Company's sole responsibility is to its Client and this document does not exonerate parties to a transaction from exercising all their rights and obligations under the transaction documents. This document cannot be reproduced except in full, without prior written approval of the Company. Any unauthorized alteration, forgery or falsification of the content or appearance of this document is unlawful and offenders may be prosecuted to the fullest extent of the law.

Report Number :TERF2403000759E2
 Operation Mode :802.11a
 Test Frequency :5260 MHz
 Test Mode :Tx
 EUT Pol :E2 Plane

Test Site :SAC G Chamber
 Test Date :2024-03-29
 Temp./Humi. :24.3°C/58%
 Antenna Pol. :Vertical
 Engineer :Temo Chen

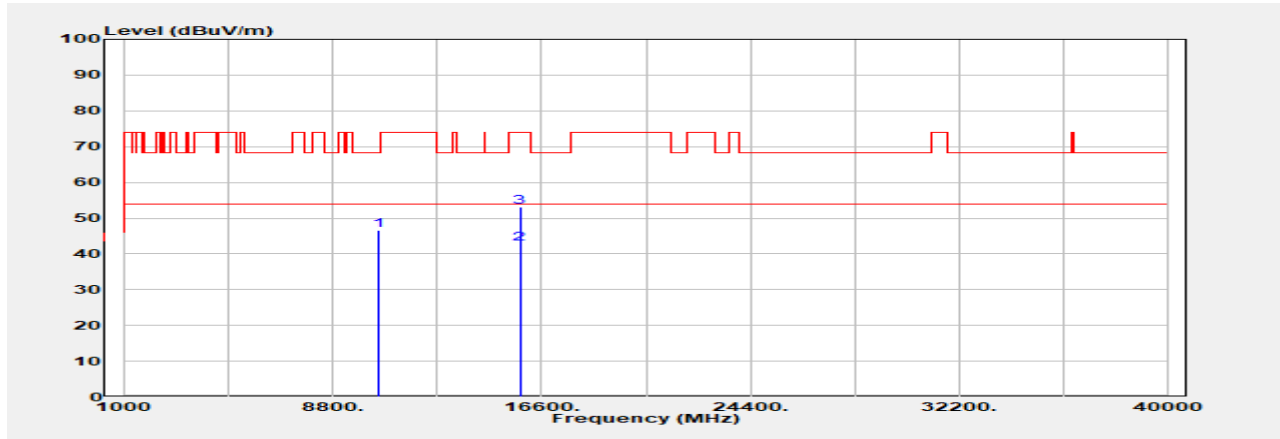

Freq. MHz	Detector Mode PK/QP/AVG	Spectrum Reading Level dBμV	Factor dB	Actual FS dBμV/m	Limit @3m dBμV/m	Margin dB
10520.000	Peak	37.07	9.53	46.60	68.20	-21.60
15780.000	Average	29.66	13.20	42.86	54.00	-11.14
15780.000	Peak	39.96	13.20	53.15	74.00	-20.85

Unless otherwise stated the results shown in this test report refer only to the sample(s) tested and such sample(s) are retained for 90 days only.

除非另有說明，此報告結果僅對測試之樣品負責，同時此樣品僅保留90天。本報告未經本公司書面許可，不可部份複製。

This document is issued by the Company subject to its General Conditions of Service printed overleaf, available on request or accessible at <http://www.sgs.com.tw/Terms-and-Conditions> and for electronic format documents, subject to Terms and Conditions for Electronic Documents at <http://www.sgs.com.tw/Terms-and-Conditions>. Attention is drawn to the limitation of liability, indemnification and jurisdiction issues defined therein. Any holder of this document is advised that information contained hereon reflects the Company's findings at the time of its intervention only and within the limits of Client's instructions, if any. The Company's sole responsibility is to its Client and this document does not exonerate parties to a transaction from exercising all their rights and obligations under the transaction documents. This document cannot be reproduced except in full, without prior written approval of the Company. Any unauthorized alteration, forgery or falsification of the content or appearance of this document is unlawful and offenders may be prosecuted to the fullest extent of the law.

Report Number :TERF2403000759E2
 Operation Mode :802.11a
 Test Frequency :5260 MHz
 Test Mode :Tx
 EUT Pol :E2 Plane

Test Site :SAC G Chamber
 Test Date :2024-03-29
 Temp./Humi. :24.3°C/58%
 Antenna Pol. :Horizontal
 Engineer :Temo Chen

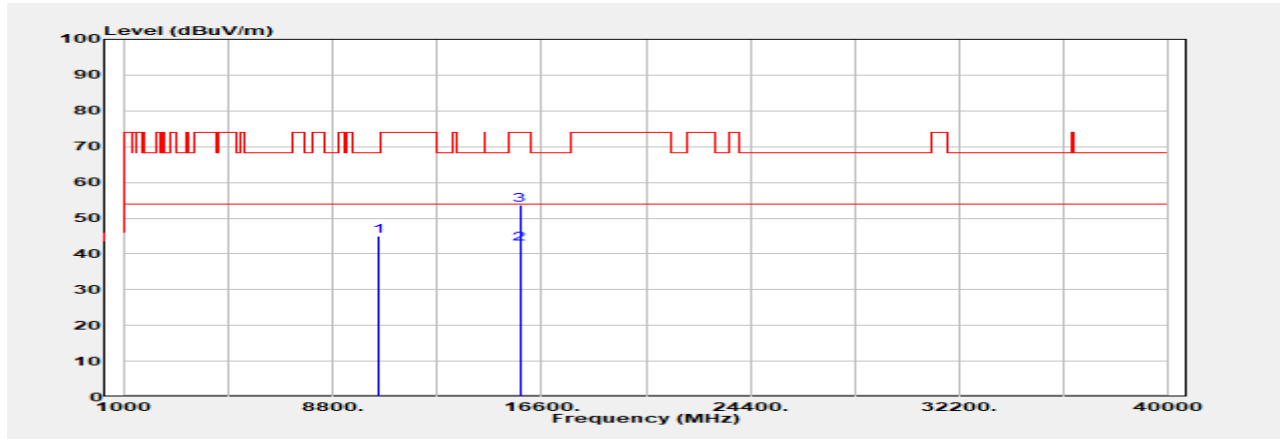

Freq. MHz	Detector Mode PK/QP/AVG	Spectrum Reading Level dB μ V	Factor dB	Actual FS dB μ V/m	Limit @3m dB μ V/m	Margin dB
10520.000	Peak	35.42	9.53	44.95	68.20	-23.25
15780.000	Average	29.70	13.20	42.90	54.00	-11.10
15780.000	Peak	40.39	13.20	53.59	74.00	-20.41

Unless otherwise stated the results shown in this test report refer only to the sample(s) tested and such sample(s) are retained for 90 days only.

除非另有說明，此報告結果僅對測試之樣品負責，同時此樣品僅保留90天。本報告未經本公司書面許可，不可部份複製。

This document is issued by the Company subject to its General Conditions of Service printed overleaf, available on request or accessible at <http://www.sgs.com.tw/Terms-and-Conditions> and for electronic format documents, subject to Terms and Conditions for Electronic Documents at <http://www.sgs.com.tw/Terms-and-Conditions>. Attention is drawn to the limitation of liability, indemnification and jurisdiction issues defined therein. Any holder of this document is advised that information contained hereon reflects the Company's findings at the time of its intervention only and within the limits of Client's instructions, if any. The Company's sole responsibility is to its Client and this document does not exonerate parties to a transaction from exercising all their rights and obligations under the transaction documents. This document cannot be reproduced except in full, without prior written approval of the Company. Any unauthorized alteration, forgery or falsification of the content or appearance of this document is unlawful and offenders may be prosecuted to the fullest extent of the law.

Report Number :TERF2403000759E2
 Operation Mode :802.11a
 Test Frequency :5300 MHz
 Test Mode :Tx
 EUT Pol :E2 Plane

Test Site :SAC G Chamber
 Test Date :2024-03-29
 Temp./Humi. :24.3°C/58%
 Antenna Pol. :Vertical
 Engineer :Temo Chen

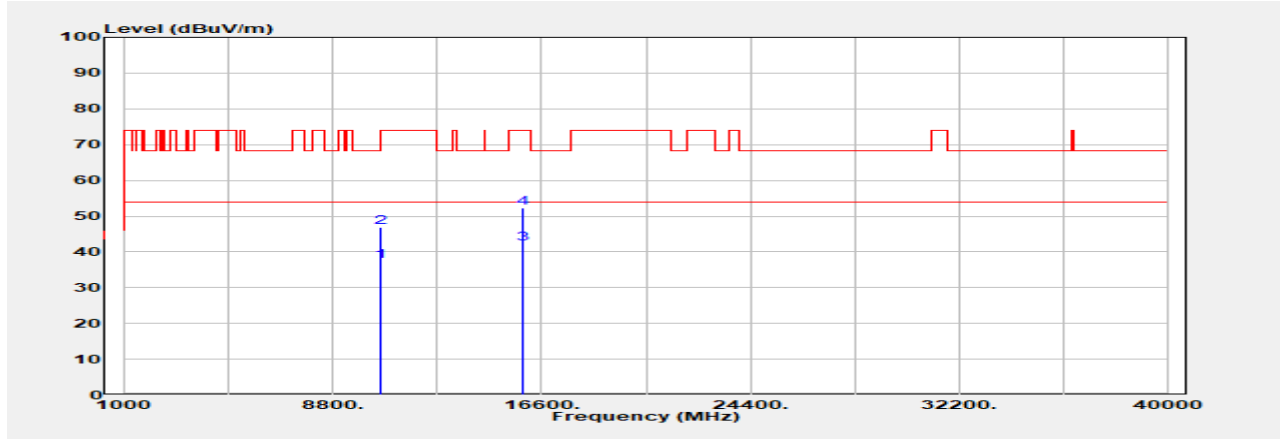

Freq. MHz	Detector Mode PK/QP/AVG	Spectrum Reading Level dB μ V	Factor dB	Actual FS dB μ V/m	Limit @3m dB μ V/m	Margin dB
10600.000	Average	27.40	9.94	37.34	54.00	-16.66
10600.000	Peak	36.86	9.94	46.80	74.00	-27.20
15900.000	Average	29.11	13.15	42.26	54.00	-11.74
15900.000	Peak	39.06	13.15	52.21	74.00	-21.79

Unless otherwise stated the results shown in this test report refer only to the sample(s) tested and such sample(s) are retained for 90 days only.

除非另有說明，此報告結果僅對測試之樣品負責，同時此樣品僅保留90天。本報告未經本公司書面許可，不可部份複製。

This document is issued by the Company subject to its General Conditions of Service printed overleaf, available on request or accessible at <http://www.sgs.com.tw/Terms-and-Conditions> and for electronic format documents, subject to Terms and Conditions for Electronic Documents at <http://www.sgs.com.tw/Terms-and-Conditions>. Attention is drawn to the limitation of liability, indemnification and jurisdiction issues defined therein. Any holder of this document is advised that information contained hereon reflects the Company's findings at the time of its intervention only and within the limits of Client's instructions, if any. The Company's sole responsibility is to its Client and this document does not exonerate parties to a transaction from exercising all their rights and obligations under the transaction documents. This document cannot be reproduced except in full, without prior written approval of the Company. Any unauthorized alteration, forgery or falsification of the content or appearance of this document is unlawful and offenders may be prosecuted to the fullest extent of the law.

Report Number :TERF2403000759E2
 Operation Mode :802.11a
 Test Frequency :5300 MHz
 Test Mode :Tx
 EUT Pol :E2 Plane

Test Site :SAC G Chamber
 Test Date :2024-03-29
 Temp./Humi. :24.3°C/58%
 Antenna Pol. :Horizontal
 Engineer :Temo Chen

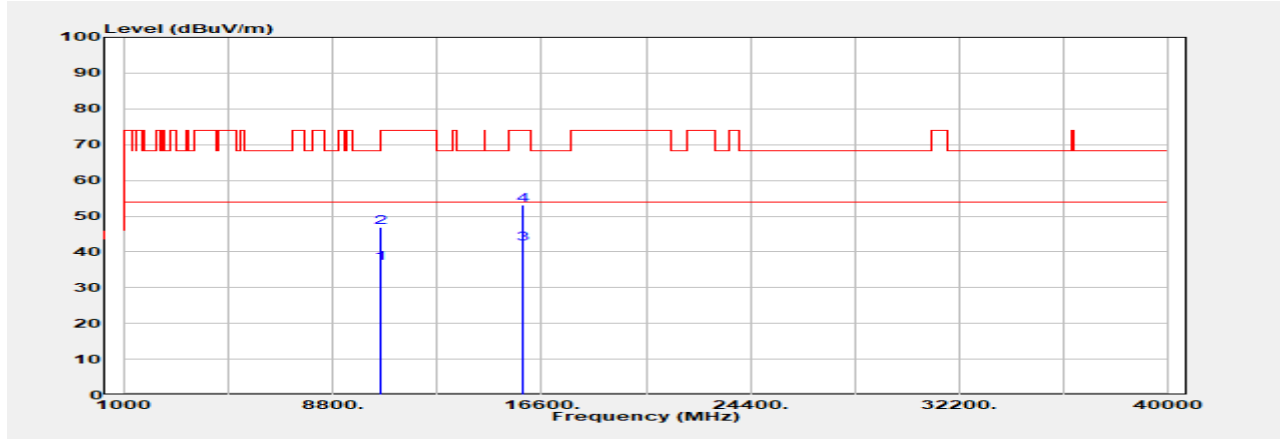

Freq. MHz	Detector Mode PK/QP/AVG	Spectrum Reading Level dB μ V	Factor dB	Actual FS dB μ V/m	Limit @3m dB μ V/m	Margin dB
10600.000	Average	26.90	9.94	36.84	54.00	-17.16
10600.000	Peak	36.91	9.94	46.85	74.00	-27.15
15900.000	Average	29.07	13.15	42.22	54.00	-11.78
15900.000	Peak	40.01	13.15	53.16	74.00	-20.84

Unless otherwise stated the results shown in this test report refer only to the sample(s) tested and such sample(s) are retained for 90 days only.

除非另有說明，此報告結果僅對測試之樣品負責，同時此樣品僅保留90天。本報告未經本公司書面許可，不可部份複製。

This document is issued by the Company subject to its General Conditions of Service printed overleaf, available on request or accessible at <http://www.sgs.com.tw/Terms-and-Conditions> and for electronic format documents, subject to Terms and Conditions for Electronic Documents at <http://www.sgs.com.tw/Terms-and-Conditions>. Attention is drawn to the limitation of liability, indemnification and jurisdiction issues defined therein. Any holder of this document is advised that information contained hereon reflects the Company's findings at the time of its intervention only and within the limits of Client's instructions, if any. The Company's sole responsibility is to its Client and this document does not exonerate parties to a transaction from exercising all their rights and obligations under the transaction documents. This document cannot be reproduced except in full, without prior written approval of the Company. Any unauthorized alteration, forgery or falsification of the content or appearance of this document is unlawful and offenders may be prosecuted to the fullest extent of the law.

Report Number :TERF2403000759E2
 Operation Mode :802.11a
 Test Frequency :5320 MHz
 Test Mode :Tx
 EUT Pol :E2 Plane

Test Site :SAC G Chamber
 Test Date :2024-03-29
 Temp./Humi. :24.3°C/58%
 Antenna Pol. :Vertical
 Engineer :Temo Chen

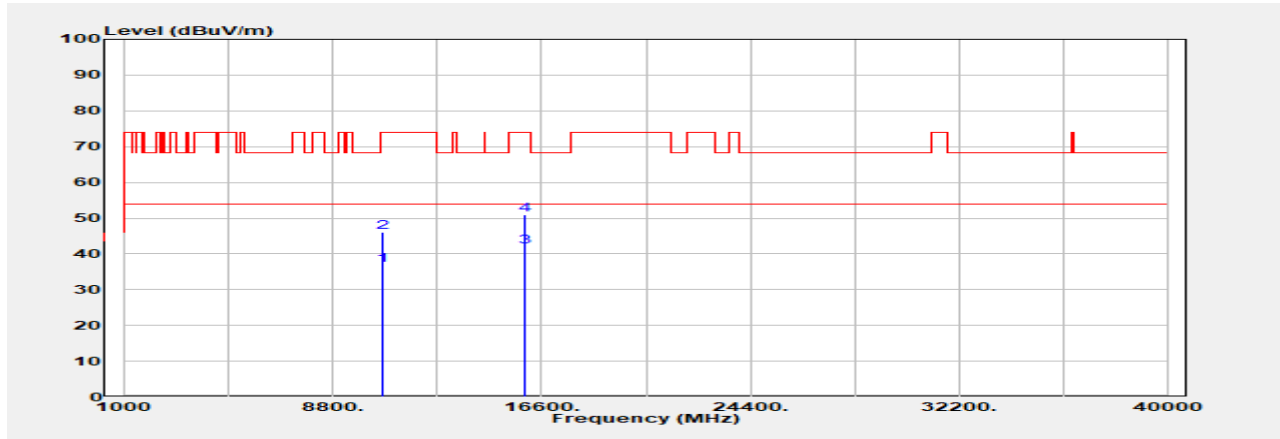

Freq. MHz	Detector Mode PK/QP/AVG	Spectrum Reading Level dBμV	Factor dB	Actual FS dBμV/m	Limit @3m dBμV/m	Margin dB
10640.000	Average	26.87	9.98	36.85	54.00	-17.15
10640.000	Peak	36.12	9.98	46.09	74.00	-27.91
15960.000	Average	29.43	12.70	42.13	54.00	-11.87
15960.000	Peak	38.15	12.70	50.85	74.00	-23.15

Unless otherwise stated the results shown in this test report refer only to the sample(s) tested and such sample(s) are retained for 90 days only.

除非另有說明，此報告結果僅對測試之樣品負責，同時此樣品僅保留90天。本報告未經本公司書面許可，不可部份複製。

This document is issued by the Company subject to its General Conditions of Service printed overleaf, available on request or accessible at <http://www.sgs.com.tw/Terms-and-Conditions> and for electronic format documents, subject to Terms and Conditions for Electronic Documents at <http://www.sgs.com.tw/Terms-and-Conditions>. Attention is drawn to the limitation of liability, indemnification and jurisdiction issues defined therein. Any holder of this document is advised that information contained hereon reflects the Company's findings at the time of its intervention only and within the limits of Client's instructions, if any. The Company's sole responsibility is to its Client and this document does not exonerate parties to a transaction from exercising all their rights and obligations under the transaction documents. This document cannot be reproduced except in full, without prior written approval of the Company. Any unauthorized alteration, forgery or falsification of the content or appearance of this document is unlawful and offenders may be prosecuted to the fullest extent of the law.

Report Number :TERF2403000759E2
 Operation Mode :802.11a
 Test Frequency :5320 MHz
 Test Mode :Tx
 EUT Pol :E2 Plane

Test Site :SAC G Chamber
 Test Date :2024-03-29
 Temp./Humi. :24.3°C/58%
 Antenna Pol. :Horizontal
 Engineer :Temo Chen

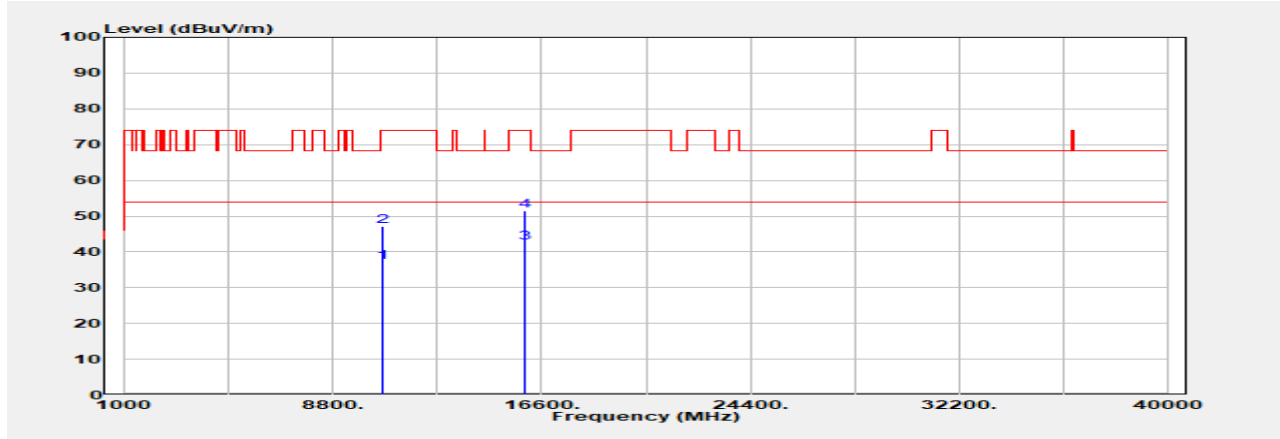

Freq. MHz	Detector Mode PK/QP/AVG	Spectrum Reading Level dB μ V	Factor dB	Actual FS dB μ V/m	Limit @3m dB μ V/m	Margin dB
10640.000	Average	27.15	9.98	37.13	54.00	-16.87
10640.000	Peak	37.29	9.98	47.27	74.00	-26.73
15960.000	Average	29.85	12.70	42.55	54.00	-11.45
15960.000	Peak	38.87	12.70	51.57	74.00	-22.43

Unless otherwise stated the results shown in this test report refer only to the sample(s) tested and such sample(s) are retained for 90 days only.

除非另有說明，此報告結果僅對測試之樣品負責，同時此樣品僅保留90天。本報告未經本公司書面許可，不可部份複製。

This document is issued by the Company subject to its General Conditions of Service printed overleaf, available on request or accessible at <http://www.sgs.com.tw/Terms-and-Conditions> and for electronic format documents, subject to Terms and Conditions for Electronic Documents at <http://www.sgs.com.tw/Terms-and-Conditions>. Attention is drawn to the limitation of liability, indemnification and jurisdiction issues defined therein. Any holder of this document is advised that information contained hereon reflects the Company's findings at the time of its intervention only and within the limits of Client's instructions, if any. The Company's sole responsibility is to its Client and this document does not exonerate parties to a transaction from exercising all their rights and obligations under the transaction documents. This document cannot be reproduced except in full, without prior written approval of the Company. Any unauthorized alteration, forgery or falsification of the content or appearance of this document is unlawful and offenders may be prosecuted to the fullest extent of the law.

Report Number :TERF2403000759E2
 Operation Mode :802.11a
 Test Frequency :5500 MHz
 Test Mode :Tx
 EUT Pol :E2 Plane

Test Site :SAC G Chamber
 Test Date :2024-03-29
 Temp./Humi. :24.3°C/58%
 Antenna Pol. :Vertical
 Engineer :Temo Chen

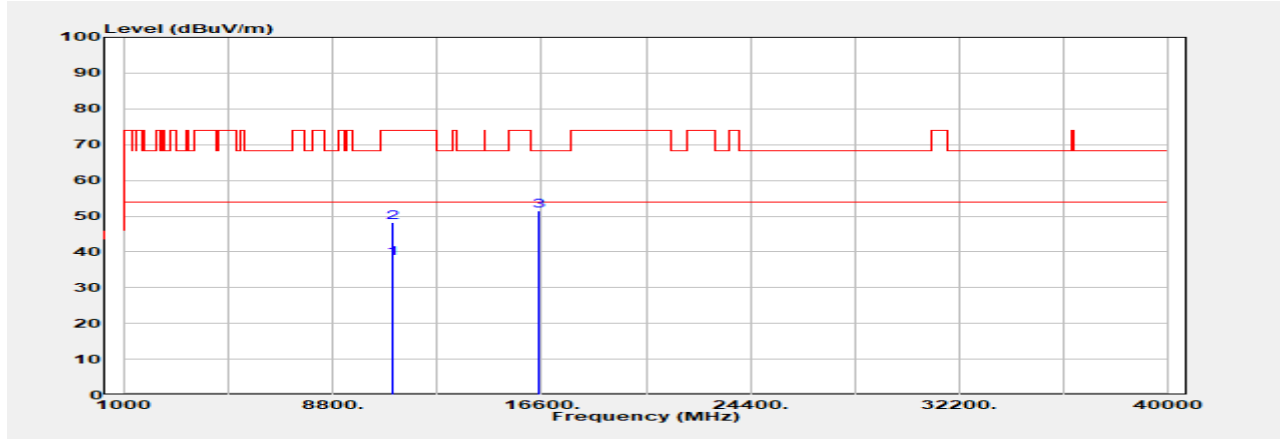

Freq. MHz	Detector Mode PK/QP/AVG	Spectrum Reading Level dBμV	Factor dB	Actual FS dBμV/m	Limit @3m dBμV/m	Margin dB
11000.000	Average	27.92	10.27	38.19	54.00	-15.81
11000.000	Peak	38.04	10.27	48.31	74.00	-25.69
16500.000	Peak	38.60	12.85	51.45	68.20	-16.75

Unless otherwise stated the results shown in this test report refer only to the sample(s) tested and such sample(s) are retained for 90 days only.

除非另有說明，此報告結果僅對測試之樣品負責，同時此樣品僅保留90天。本報告未經本公司書面許可，不可部份複製。

This document is issued by the Company subject to its General Conditions of Service printed overleaf, available on request or accessible at <http://www.sgs.com.tw/Terms-and-Conditions> and for electronic format documents, subject to Terms and Conditions for Electronic Documents at <http://www.sgs.com.tw/Terms-and-Conditions>. Attention is drawn to the limitation of liability, indemnification and jurisdiction issues defined therein. Any holder of this document is advised that information contained hereon reflects the Company's findings at the time of its intervention only and within the limits of Client's instructions, if any. The Company's sole responsibility is to its Client and this document does not exonerate parties to a transaction from exercising all their rights and obligations under the transaction documents. This document cannot be reproduced except in full, without prior written approval of the Company. Any unauthorized alteration, forgery or falsification of the content or appearance of this document is unlawful and offenders may be prosecuted to the fullest extent of the law.

Report Number :TERF2403000759E2
 Operation Mode :802.11a
 Test Frequency :5500 MHz
 Test Mode :Tx
 EUT Pol :E2 Plane

Test Site :SAC G Chamber
 Test Date :2024-03-29
 Temp./Humi. :24.3°C/58%
 Antenna Pol. :Horizontal
 Engineer :Temo Chen

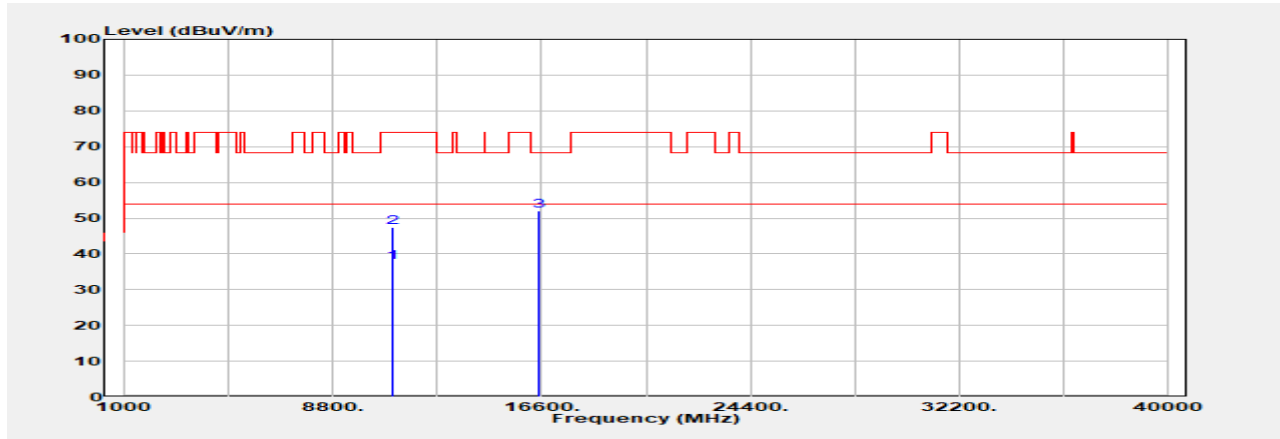

Freq. MHz	Detector Mode PK/QP/AVG	Spectrum Reading Level dBμV	Factor dB	Actual FS dBμV/m	Limit @3m dBμV/m	Margin dB
11000.000	Average	27.42	10.27	37.69	54.00	-16.31
11000.000	Peak	37.10	10.27	47.37	74.00	-26.63
16500.000	Peak	39.29	12.85	52.14	68.20	-16.06

Unless otherwise stated the results shown in this test report refer only to the sample(s) tested and such sample(s) are retained for 90 days only.

除非另有說明，此報告結果僅對測試之樣品負責，同時此樣品僅保留90天。本報告未經本公司書面許可，不可部份複製。

This document is issued by the Company subject to its General Conditions of Service printed overleaf, available on request or accessible at <http://www.sgs.com.tw/Terms-and-Conditions> and for electronic format documents, subject to Terms and Conditions for Electronic Documents at <http://www.sgs.com.tw/Terms-and-Conditions>. Attention is drawn to the limitation of liability, indemnification and jurisdiction issues defined therein. Any holder of this document is advised that information contained hereon reflects the Company's findings at the time of its intervention only and within the limits of Client's instructions, if any. The Company's sole responsibility is to its Client and this document does not exonerate parties to a transaction from exercising all their rights and obligations under the transaction documents. This document cannot be reproduced except in full, without prior written approval of the Company. Any unauthorized alteration, forgery or falsification of the content or appearance of this document is unlawful and offenders may be prosecuted to the fullest extent of the law.

Report Number :TERF2403000759E2
 Operation Mode :802.11a
 Test Frequency :5580 MHz
 Test Mode :Tx
 EUT Pol :E2 Plane

Test Site :SAC G Chamber
 Test Date :2024-03-29
 Temp./Humi. :24.3°C/58%
 Antenna Pol. :Vertical
 Engineer :Temo Chen

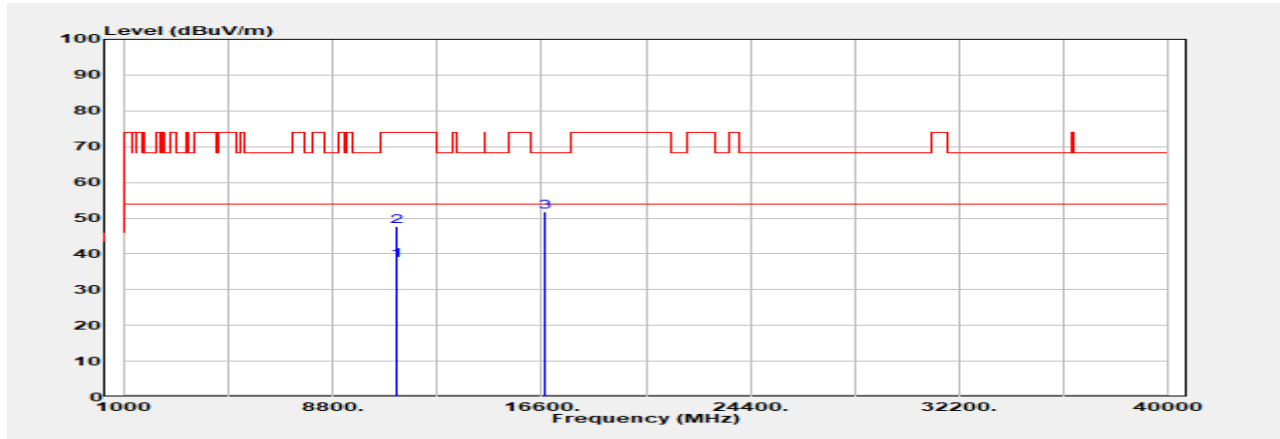

Freq. MHz	Detector Mode PK/QP/AVG	Spectrum Reading Level dBμV	Factor dB	Actual FS dBμV/m	Limit @3m dBμV/m	Margin dB
11160.000	Average	28.13	10.10	38.23	54.00	-15.77
11160.000	Peak	37.60	10.10	47.69	74.00	-26.31
16740.000	Peak	39.15	12.58	51.74	68.20	-16.46

Unless otherwise stated the results shown in this test report refer only to the sample(s) tested and such sample(s) are retained for 90 days only.

除非另有說明，此報告結果僅對測試之樣品負責，同時此樣品僅保留90天。本報告未經本公司書面許可，不可部份複製。

This document is issued by the Company subject to its General Conditions of Service printed overleaf, available on request or accessible at <http://www.sgs.com.tw/Terms-and-Conditions> and for electronic format documents, subject to Terms and Conditions for Electronic Documents at <http://www.sgs.com.tw/Terms-and-Conditions>. Attention is drawn to the limitation of liability, indemnification and jurisdiction issues defined therein. Any holder of this document is advised that information contained hereon reflects the Company's findings at the time of its intervention only and within the limits of Client's instructions, if any. The Company's sole responsibility is to its Client and this document does not exonerate parties to a transaction from exercising all their rights and obligations under the transaction documents. This document cannot be reproduced except in full, without prior written approval of the Company. Any unauthorized alteration, forgery or falsification of the content or appearance of this document is unlawful and offenders may be prosecuted to the fullest extent of the law.

Report Number :TERF2403000759E2
 Operation Mode :802.11a
 Test Frequency :5580 MHz
 Test Mode :Tx
 EUT Pol :E2 Plane

Test Site :SAC G Chamber
 Test Date :2024-03-29
 Temp./Humi. :24.3°C/58%
 Antenna Pol. :Horizontal
 Engineer :Temo Chen

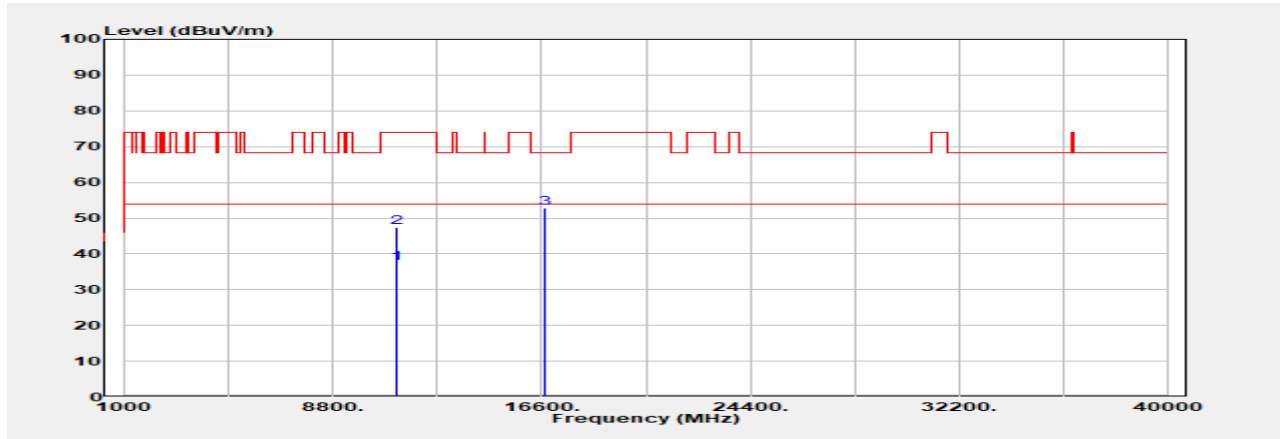

Freq. MHz	Detector Mode PK/QP/AVG	Spectrum Reading Level dBμV	Factor dB	Actual FS dBμV/m	Limit @3m dBμV/m	Margin dB
11160.000	Average	27.37	10.10	37.47	54.00	-16.53
11160.000	Peak	37.44	10.10	47.54	74.00	-26.46
16740.000	Peak	40.24	12.58	52.82	68.20	-15.38

Unless otherwise stated the results shown in this test report refer only to the sample(s) tested and such sample(s) are retained for 90 days only.

除非另有說明，此報告結果僅對測試之樣品負責，同時此樣品僅保留90天。本報告未經本公司書面許可，不可部份複製。

This document is issued by the Company subject to its General Conditions of Service printed overleaf, available on request or accessible at <http://www.sgs.com.tw/Terms-and-Conditions> and for electronic format documents, subject to Terms and Conditions for Electronic Documents at <http://www.sgs.com.tw/Terms-and-Conditions>. Attention is drawn to the limitation of liability, indemnification and jurisdiction issues defined therein. Any holder of this document is advised that information contained hereon reflects the Company's findings at the time of its intervention only and within the limits of Client's instructions, if any. The Company's sole responsibility is to its Client and this document does not exonerate parties to a transaction from exercising all their rights and obligations under the transaction documents. This document cannot be reproduced except in full, without prior written approval of the Company. Any unauthorized alteration, forgery or falsification of the content or appearance of this document is unlawful and offenders may be prosecuted to the fullest extent of the law.

Report Number :TERF2403000759E2

Test Site :SAC G Chamber

Operation Mode :802.11a

Test Date :2024-03-29

Test Frequency :5700 MHz

Temp./Humi. :24.3°C/58%

Test Mode :Tx

Antenna Pol. :Vertical

EUT Pol :E2 Plane

Engineer :Temo Chen

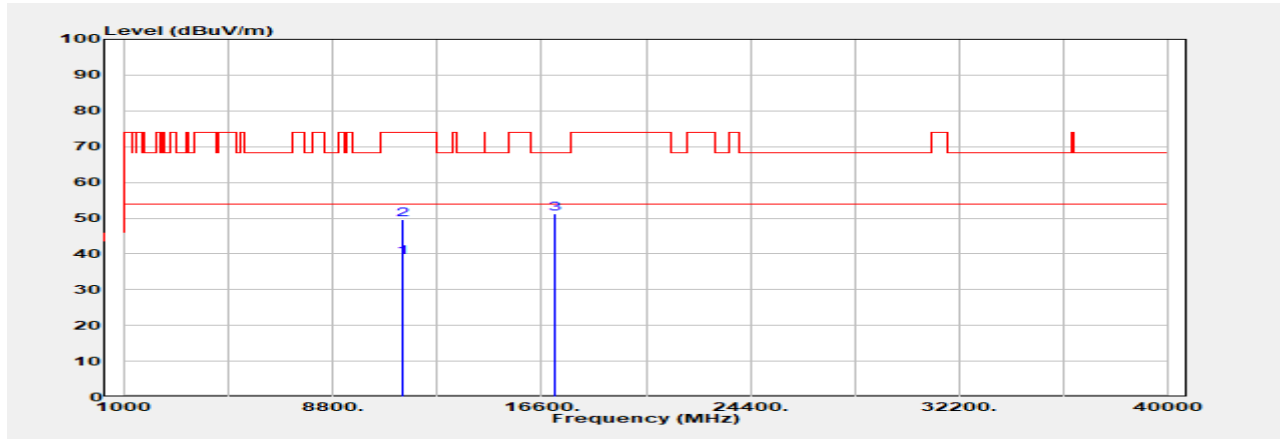

Freq. MHz	Detector Mode PK/QP/AVG	Spectrum Reading Level dBμV	Factor dB	Actual FS dBμV/m	Limit @3m dBμV/m	Margin dB
11400.000	Average	26.75	12.32	39.07	54.00	-14.93
11400.000	Peak	37.39	12.32	49.71	74.00	-24.29
17100.000	Peak	38.62	12.62	51.24	68.20	-16.96

Unless otherwise stated the results shown in this test report refer only to the sample(s) tested and such sample(s) are retained for 90 days only.

除非另有說明，此報告結果僅對測試之樣品負責，同時此樣品僅保留90天。本報告未經本公司書面許可，不可部份複製。

This document is issued by the Company subject to its General Conditions of Service printed overleaf, available on request or accessible at <http://www.sgs.com.tw/Terms-and-Conditions> and for electronic format documents, subject to Terms and Conditions for Electronic Documents at <http://www.sgs.com.tw/Terms-and-Conditions>. Attention is drawn to the limitation of liability, indemnification and jurisdiction issues defined therein. Any holder of this document is advised that information contained hereon reflects the Company's findings at the time of its intervention only and within the limits of Client's instructions, if any. The Company's sole responsibility is to its Client and this document does not exonerate parties to a transaction from exercising all their rights and obligations under the transaction documents. This document cannot be reproduced except in full, without prior written approval of the Company. Any unauthorized alteration, forgery or falsification of the content or appearance of this document is unlawful and offenders may be prosecuted to the fullest extent of the law.

Report Number :TERF2403000759E2

Test Site :SAC G Chamber

Operation Mode :802.11a

Test Date :2024-03-29

Test Frequency :5700 MHz

Temp./Humi. :24.3°C/58%

Test Mode :Tx

Antenna Pol. :Horizontal

EUT Pol :E2 Plane

Engineer :Temo Chen

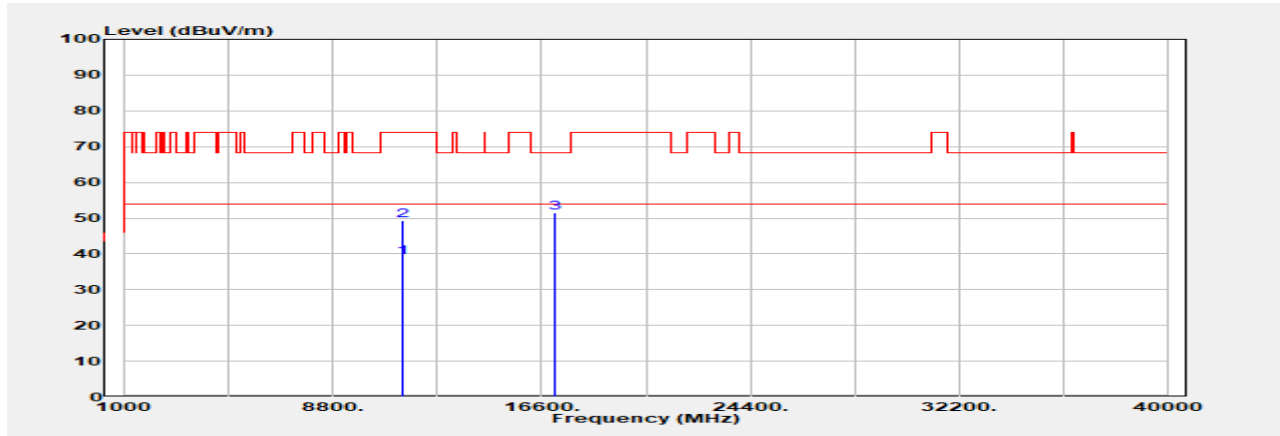

Freq. MHz	Detector Mode PK/QP/AVG	Spectrum Reading Level dBμV	Factor dB	Actual FS dBμV/m	Limit @3m dBμV/m	Margin dB
11400.000	Average	26.64	12.32	38.96	54.00	-15.04
11400.000	Peak	36.90	12.32	49.22	74.00	-24.78
17100.000	Peak	38.75	12.62	51.37	68.20	-16.83

Unless otherwise stated the results shown in this test report refer only to the sample(s) tested and such sample(s) are retained for 90 days only.

除非另有說明，此報告結果僅對測試之樣品負責，同時此樣品僅保留90天。本報告未經本公司書面許可，不可部份複製。

This document is issued by the Company subject to its General Conditions of Service printed overleaf, available on request or accessible at <http://www.sgs.com.tw/Terms-and-Conditions> and for electronic format documents, subject to Terms and Conditions for Electronic Documents at <http://www.sgs.com.tw/Terms-and-Conditions>. Attention is drawn to the limitation of liability, indemnification and jurisdiction issues defined therein. Any holder of this document is advised that information contained hereon reflects the Company's findings at the time of its intervention only and within the limits of Client's instructions, if any. The Company's sole responsibility is to its Client and this document does not exonerate parties to a transaction from exercising all their rights and obligations under the transaction documents. This document cannot be reproduced except in full, without prior written approval of the Company. Any unauthorized alteration, forgery or falsification of the content or appearance of this document is unlawful and offenders may be prosecuted to the fullest extent of the law.

Report Number :TERF2403000759E2

Test Site :SAC G Chamber

Operation Mode :802.11a

Test Date :2024-03-29

Test Frequency :5720 MHz

Temp./Humi. :24.3°C/58%

Test Mode :Tx

Antenna Pol. :Vertical

EUT Pol :E2 Plane

Engineer :Temo Chen

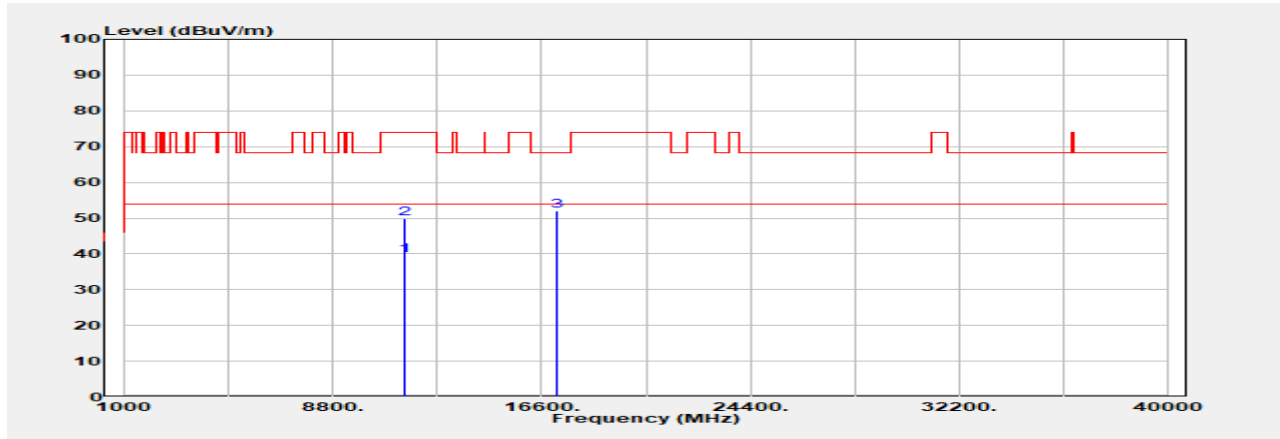

Freq. MHz	Detector Mode PK/QP/AVG	Spectrum Reading Level dB μ V	Factor dB	Actual FS dB μ V/m	Limit @3m dB μ V/m	Margin dB
11440.000	Average	27.97	11.53	39.49	54.00	-14.51
11440.000	Peak	38.31	11.53	49.84	74.00	-24.16
17160.000	Peak	39.67	12.24	51.91	68.20	-16.29

Unless otherwise stated the results shown in this test report refer only to the sample(s) tested and such sample(s) are retained for 90 days only.

除非另有說明，此報告結果僅對測試之樣品負責，同時此樣品僅保留90天。本報告未經本公司書面許可，不可部份複製。

This document is issued by the Company subject to its General Conditions of Service printed overleaf, available on request or accessible at <http://www.sgs.com.tw/Terms-and-Conditions> and for electronic format documents, subject to Terms and Conditions for Electronic Documents at <http://www.sgs.com.tw/Terms-and-Conditions>. Attention is drawn to the limitation of liability, indemnification and jurisdiction issues defined therein. Any holder of this document is advised that information contained hereon reflects the Company's findings at the time of its intervention only and within the limits of Client's instructions, if any. The Company's sole responsibility is to its Client and this document does not exonerate parties to a transaction from exercising all their rights and obligations under the transaction documents. This document cannot be reproduced except in full, without prior written approval of the Company. Any unauthorized alteration, forgery or falsification of the content or appearance of this document is unlawful and offenders may be prosecuted to the fullest extent of the law.

Report Number :TERF2403000759E2

Test Site :SAC G Chamber

Operation Mode :802.11a

Test Date :2024-03-29

Test Frequency :5720 MHz

Temp./Humi. :24.3°C/58%

Test Mode :Tx

Antenna Pol. :Horizontal

EUT Pol :E2 Plane

Engineer :Temo Chen

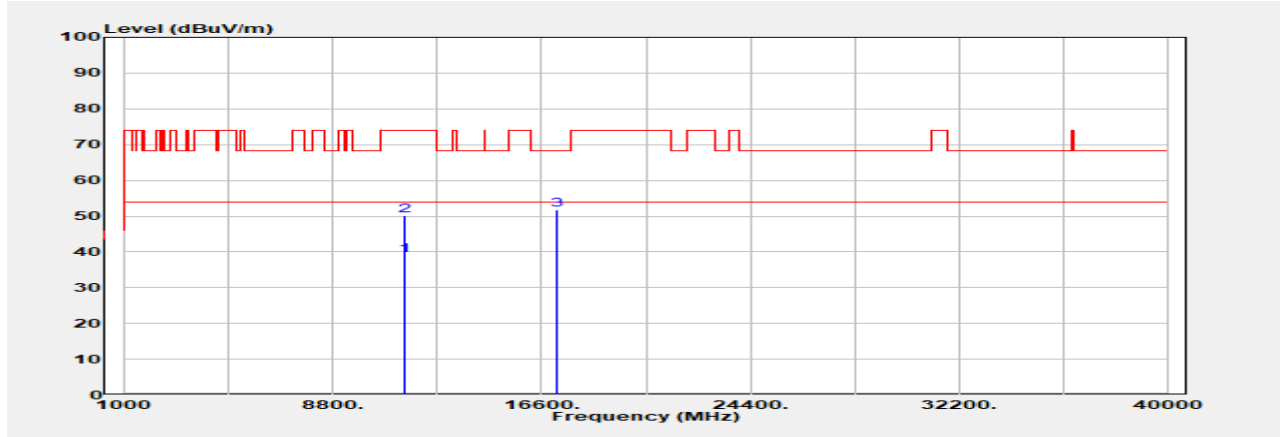

Freq. MHz	Detector Mode PK/QP/AVG	Spectrum Reading Level dBμV	Factor dB	Actual FS dBμV/m	Limit @3m dBμV/m	Margin dB
11440.000	Average	27.63	11.53	39.15	54.00	-14.85
11440.000	Peak	38.64	11.53	50.17	74.00	-23.83
17160.000	Peak	39.53	12.24	51.77	68.20	-16.43

Unless otherwise stated the results shown in this test report refer only to the sample(s) tested and such sample(s) are retained for 90 days only.

除非另有說明，此報告結果僅對測試之樣品負責，同時此樣品僅保留90天。本報告未經本公司書面許可，不可部份複製。

This document is issued by the Company subject to its General Conditions of Service printed overleaf, available on request or accessible at <http://www.sgs.com.tw/Terms-and-Conditions> and for electronic format documents, subject to Terms and Conditions for Electronic Documents at <http://www.sgs.com.tw/Terms-and-Conditions>. Attention is drawn to the limitation of liability, indemnification and jurisdiction issues defined therein. Any holder of this document is advised that information contained hereon reflects the Company's findings at the time of its intervention only and within the limits of Client's instructions, if any. The Company's sole responsibility is to its Client and this document does not exonerate parties to a transaction from exercising all their rights and obligations under the transaction documents. This document cannot be reproduced except in full, without prior written approval of the Company. Any unauthorized alteration, forgery or falsification of the content or appearance of this document is unlawful and offenders may be prosecuted to the fullest extent of the law.

Report Number :TERF2403000759E2

Test Site :SAC G Chamber

Operation Mode :802.11a

Test Date :2024-03-29

Test Frequency :5745 MHz

Temp./Humi. :24.3°C/58%

Test Mode :Tx

Antenna Pol. :Vertical

EUT Pol :E2 Plane

Engineer :Temo Chen

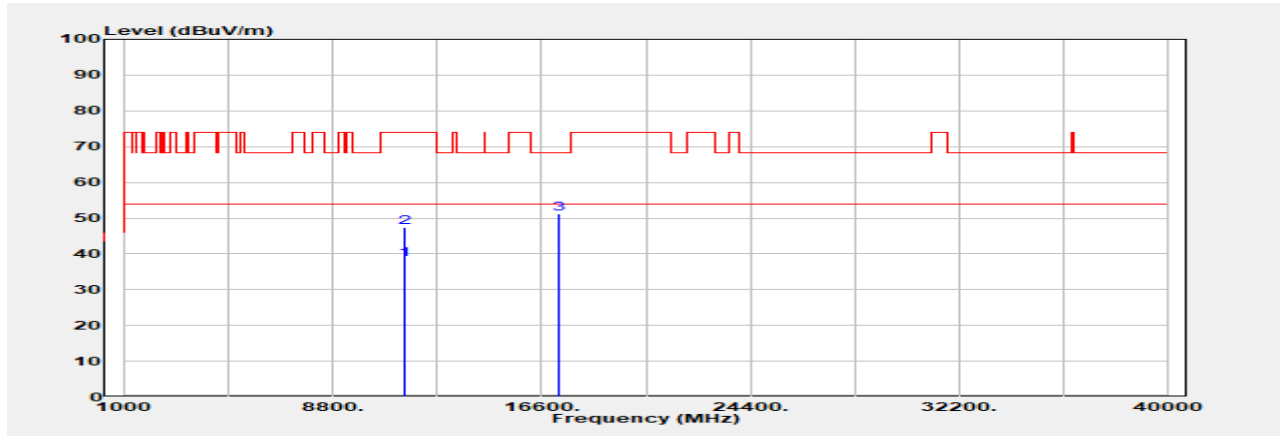

Freq. MHz	Detector Mode PK/QP/AVG	Spectrum Reading Level dBμV	Factor dB	Actual FS dBμV/m	Limit @3m dBμV/m	Margin dB
11490.000	Average	27.89	10.54	38.43	54.00	-15.57
11490.000	Peak	36.76	10.54	47.30	74.00	-26.70
17235.000	Peak	38.66	12.49	51.16	68.20	-17.04

Unless otherwise stated the results shown in this test report refer only to the sample(s) tested and such sample(s) are retained for 90 days only.

除非另有說明，此報告結果僅對測試之樣品負責，同時此樣品僅保留90天。本報告未經本公司書面許可，不可部份複製。

This document is issued by the Company subject to its General Conditions of Service printed overleaf, available on request or accessible at <http://www.sgs.com.tw/Terms-and-Conditions> and for electronic format documents, subject to Terms and Conditions for Electronic Documents at <http://www.sgs.com.tw/Terms-and-Conditions>. Attention is drawn to the limitation of liability, indemnification and jurisdiction issues defined therein. Any holder of this document is advised that information contained hereon reflects the Company's findings at the time of its intervention only and within the limits of Client's instructions, if any. The Company's sole responsibility is to its Client and this document does not exonerate parties to a transaction from exercising all their rights and obligations under the transaction documents. This document cannot be reproduced except in full, without prior written approval of the Company. Any unauthorized alteration, forgery or falsification of the content or appearance of this document is unlawful and offenders may be prosecuted to the fullest extent of the law.

Report Number :TERF2403000759E2
 Operation Mode :802.11a
 Test Frequency :5745 MHz
 Test Mode :Tx
 EUT Pol :E2 Plane

Test Site :SAC G Chamber
 Test Date :2024-03-29
 Temp./Humi. :24.3°C/58%
 Antenna Pol. :Horizontal
 Engineer :Temo Chen



Freq. MHz	Detector Mode PK/QP/AVG	Spectrum Reading Level dB μ V	Factor dB	Actual FS dB μ V/m	Limit @3m dB μ V/m	Margin dB
11490.000	Average	28.07	10.54	38.61	54.00	-15.39
11490.000	Peak	35.92	10.54	46.46	74.00	-27.54
17235.000	Peak	38.91	12.49	51.40	68.20	-16.80

Unless otherwise stated the results shown in this test report refer only to the sample(s) tested and such sample(s) are retained for 90 days only.

除非另有說明，此報告結果僅對測試之樣品負責，同時此樣品僅保留90天。本報告未經本公司書面許可，不可部份複製。

This document is issued by the Company subject to its General Conditions of Service printed overleaf, available on request or accessible at <http://www.sgs.com.tw/Terms-and-Conditions> and for electronic format documents, subject to Terms and Conditions for Electronic Documents at <http://www.sgs.com.tw/Terms-and-Conditions>. Attention is drawn to the limitation of liability, indemnification and jurisdiction issues defined therein. Any holder of this document is advised that information contained hereon reflects the Company's findings at the time of its intervention only and within the limits of Client's instructions, if any. The Company's sole responsibility is to its Client and this document does not exonerate parties to a transaction from exercising all their rights and obligations under the transaction documents. This document cannot be reproduced except in full, without prior written approval of the Company. Any unauthorized alteration, forgery or falsification of the content or appearance of this document is unlawful and offenders may be prosecuted to the fullest extent of the law.

Report Number :TERF2403000759E2

Test Site :SAC G Chamber

Operation Mode :802.11a

Test Date :2024-03-29

Test Frequency :5785 MHz

Temp./Humi. :24.3°C/58%

Test Mode :Tx

Antenna Pol. :Vertical

EUT Pol :E2 Plane

Engineer :Temo Chen

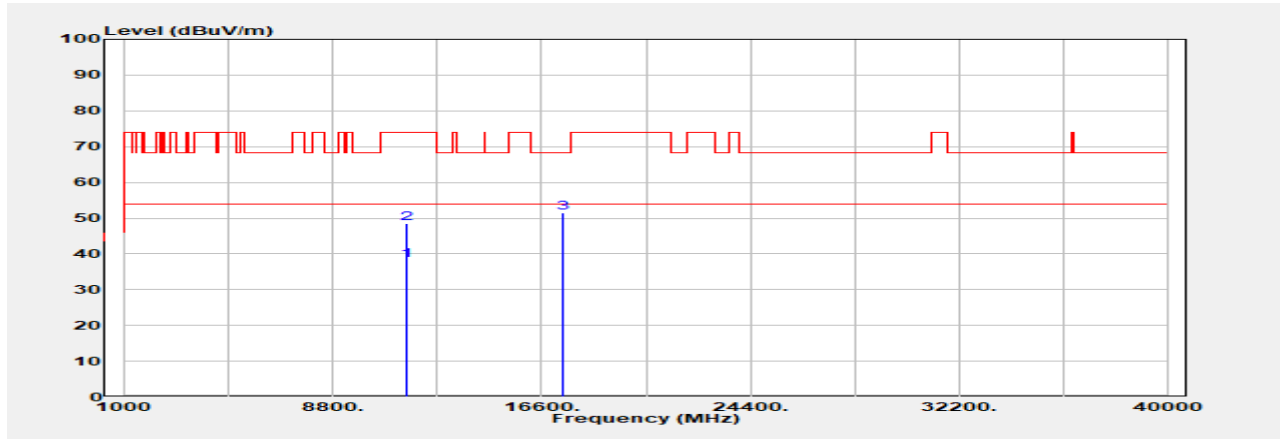

Freq. MHz	Detector Mode PK/QP/AVG	Spectrum Reading Level dB μ V	Factor dB	Actual FS dB μ V/m	Limit @3m dB μ V/m	Margin dB
11570.000	Average	27.76	10.42	38.18	54.00	-15.82
11570.000	Peak	38.04	10.42	48.46	74.00	-25.54
17355.000	Peak	38.69	12.84	51.53	68.20	-16.67

Unless otherwise stated the results shown in this test report refer only to the sample(s) tested and such sample(s) are retained for 90 days only.

除非另有說明，此報告結果僅對測試之樣品負責，同時此樣品僅保留90天。本報告未經本公司書面許可，不可部份複製。

This document is issued by the Company subject to its General Conditions of Service printed overleaf, available on request or accessible at <http://www.sgs.com.tw/Terms-and-Conditions> and for electronic format documents, subject to Terms and Conditions for Electronic Documents at <http://www.sgs.com.tw/Terms-and-Conditions>. Attention is drawn to the limitation of liability, indemnification and jurisdiction issues defined therein. Any holder of this document is advised that information contained hereon reflects the Company's findings at the time of its intervention only and within the limits of Client's instructions, if any. The Company's sole responsibility is to its Client and this document does not exonerate parties to a transaction from exercising all their rights and obligations under the transaction documents. This document cannot be reproduced except in full, without prior written approval of the Company. Any unauthorized alteration, forgery or falsification of the content or appearance of this document is unlawful and offenders may be prosecuted to the fullest extent of the law.

Report Number :TERF2403000759E2

Test Site :SAC G Chamber

Operation Mode :802.11a

Test Date :2024-03-29

Test Frequency :5785 MHz

Temp./Humi. :24.3°C/58%

Test Mode :Tx

Antenna Pol. :Horizontal

EUT Pol :E2 Plane

Engineer :Temo Chen

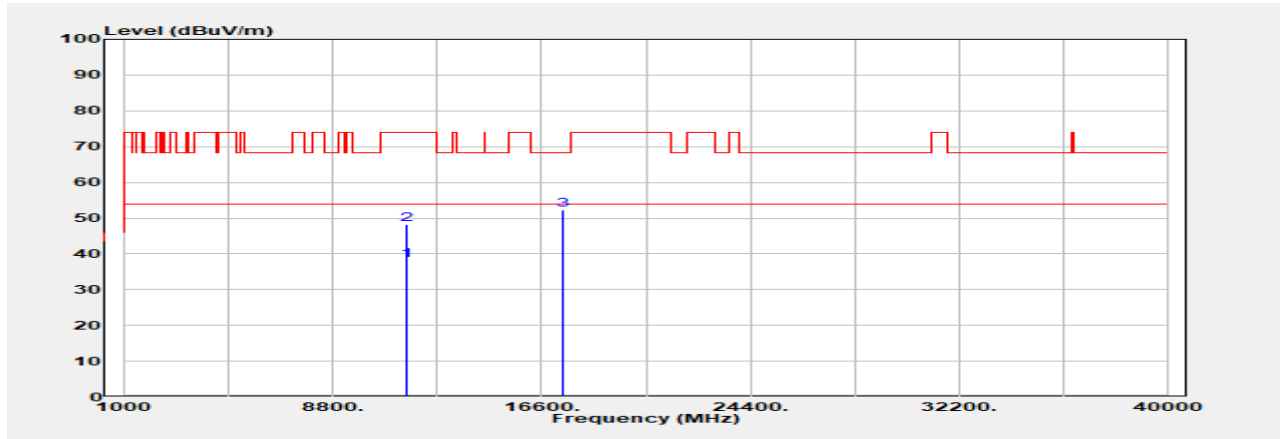

Freq. MHz	Detector Mode PK/QP/AVG	Spectrum Reading Level dBμV	Factor dB	Actual FS dBμV/m	Limit @3m dBμV/m	Margin dB
11570.000	Average	27.67	10.42	38.09	54.00	-15.91
11570.000	Peak	37.79	10.42	48.21	74.00	-25.79
17355.000	Peak	39.37	12.84	52.21	68.20	-15.99

Unless otherwise stated the results shown in this test report refer only to the sample(s) tested and such sample(s) are retained for 90 days only.

除非另有說明，此報告結果僅對測試之樣品負責，同時此樣品僅保留90天。本報告未經本公司書面許可，不可部份複製。

This document is issued by the Company subject to its General Conditions of Service printed overleaf, available on request or accessible at <http://www.sgs.com.tw/Terms-and-Conditions> and for electronic format documents, subject to Terms and Conditions for Electronic Documents at <http://www.sgs.com.tw/Terms-and-Conditions>. Attention is drawn to the limitation of liability, indemnification and jurisdiction issues defined therein. Any holder of this document is advised that information contained hereon reflects the Company's findings at the time of its intervention only and within the limits of Client's instructions, if any. The Company's sole responsibility is to its Client and this document does not exonerate parties to a transaction from exercising all their rights and obligations under the transaction documents. This document cannot be reproduced except in full, without prior written approval of the Company. Any unauthorized alteration, forgery or falsification of the content or appearance of this document is unlawful and offenders may be prosecuted to the fullest extent of the law.

Report Number :TERF2403000759E2	Test Site :SAC G Chamber
Operation Mode :802.11a	Test Date :2024-03-29
Test Frequency :5825 MHz	Temp./Humi. :24.3°C/58%
Test Mode :Tx	Antenna Pol. :Vertical
EUT Pol :E2 Plane	Engineer :Temo Chen

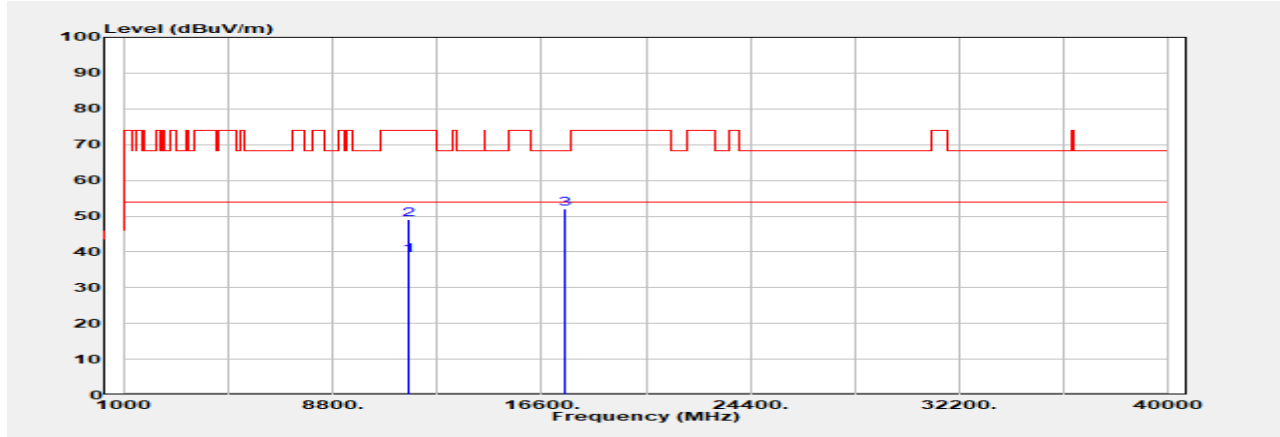

Freq. MHz	Detector Mode PK/QP/AVG	Spectrum Reading Level dBμV	Factor dB	Actual FS dBμV/m	Limit @3m dBμV/m	Margin dB
11650.000	Average	28.06	10.84	38.90	54.00	-15.10
11650.000	Peak	38.20	10.84	49.04	74.00	-24.96
17475.000	Peak	39.47	12.69	52.16	68.20	-16.04

Unless otherwise stated the results shown in this test report refer only to the sample(s) tested and such sample(s) are retained for 90 days only.

除非另有說明，此報告結果僅對測試之樣品負責，同時此樣品僅保留90天。本報告未經本公司書面許可，不可部份複製。

This document is issued by the Company subject to its General Conditions of Service printed overleaf, available on request or accessible at <http://www.sgs.com.tw/Terms-and-Conditions> and for electronic format documents, subject to Terms and Conditions for Electronic Documents at <http://www.sgs.com.tw/Terms-and-Conditions>. Attention is drawn to the limitation of liability, indemnification and jurisdiction issues defined therein. Any holder of this document is advised that information contained hereon reflects the Company's findings at the time of its intervention only and within the limits of Client's instructions, if any. The Company's sole responsibility is to its Client and this document does not exonerate parties to a transaction from exercising all their rights and obligations under the transaction documents. This document cannot be reproduced except in full, without prior written approval of the Company. Any unauthorized alteration, forgery or falsification of the content or appearance of this document is unlawful and offenders may be prosecuted to the fullest extent of the law.

Report Number :TERF2403000759E2
 Operation Mode :802.11a
 Test Frequency :5825 MHz
 Test Mode :Tx
 EUT Pol :E2 Plane

Test Site :SAC G Chamber
 Test Date :2024-03-29
 Temp./Humi. :24.3°C/58%
 Antenna Pol. :Horizontal
 Engineer :Temo Chen

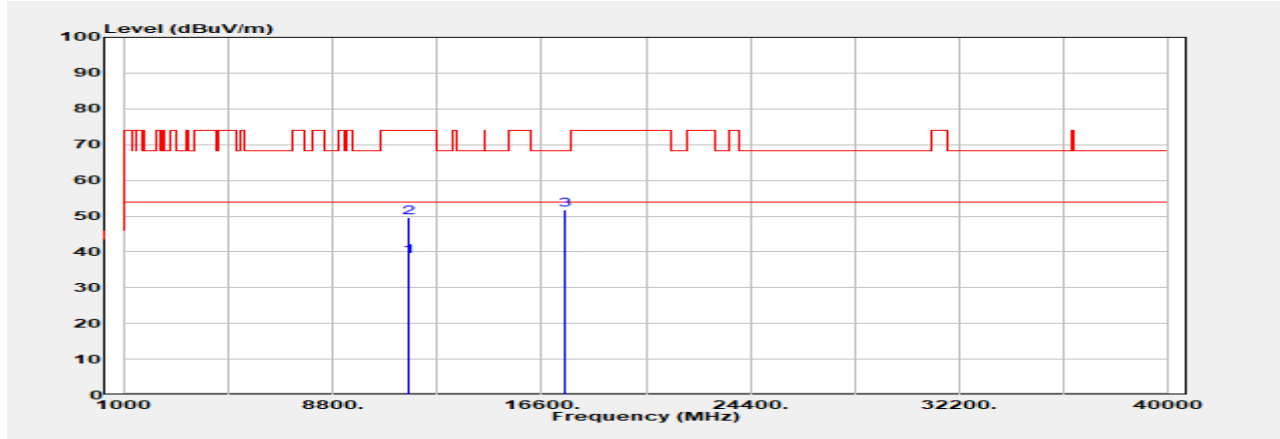

Freq. MHz	Detector Mode PK/QP/AVG	Spectrum Reading Level dBμV	Factor dB	Actual FS dBμV/m	Limit @3m dBμV/m	Margin dB
11650.000	Average	27.93	10.84	38.77	54.00	-15.23
11650.000	Peak	38.89	10.84	49.73	74.00	-24.27
17475.000	Peak	38.94	12.69	51.63	68.20	-16.57

Unless otherwise stated the results shown in this test report refer only to the sample(s) tested and such sample(s) are retained for 90 days only.

除非另有說明，此報告結果僅對測試之樣品負責，同時此樣品僅保留90天。本報告未經本公司書面許可，不可部份複製。

This document is issued by the Company subject to its General Conditions of Service printed overleaf, available on request or accessible at <http://www.sgs.com.tw/Terms-and-Conditions> and for electronic format documents, subject to Terms and Conditions for Electronic Documents at <http://www.sgs.com.tw/Terms-and-Conditions>. Attention is drawn to the limitation of liability, indemnification and jurisdiction issues defined therein. Any holder of this document is advised that information contained hereon reflects the Company's findings at the time of its intervention only and within the limits of Client's instructions, if any. The Company's sole responsibility is to its Client and this document does not exonerate parties to a transaction from exercising all their rights and obligations under the transaction documents. This document cannot be reproduced except in full, without prior written approval of the Company. Any unauthorized alteration, forgery or falsification of the content or appearance of this document is unlawful and offenders may be prosecuted to the fullest extent of the law.

Report Number :TERF2403000759E2
 Operation Mode :802.11ac20
 Test Frequency :5180 MHz
 Test Mode :Tx
 EUT Pol :E2 Plane

Test Site :SAC G Chamber
 Test Date :2024-03-29
 Temp./Humi. :24.3°C/58%
 Antenna Pol. :Vertical
 Engineer :Temo Chen

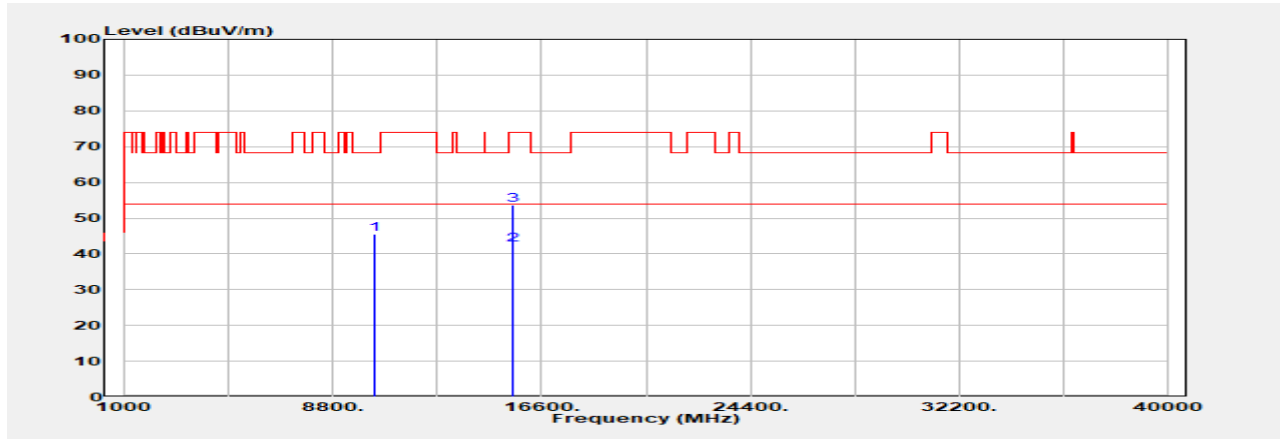

Freq. MHz	Detector Mode PK/QP/AVG	Spectrum Reading Level dBμV	Factor dB	Actual FS dBμV/m	Limit @3m dBμV/m	Margin dB
10360.000	Peak	35.62	9.94	45.56	68.20	-22.64
15540.000	Average	29.90	12.54	42.44	54.00	-11.56
15540.000	Peak	41.05	12.54	53.59	74.00	-20.41

Unless otherwise stated the results shown in this test report refer only to the sample(s) tested and such sample(s) are retained for 90 days only.

除非另有說明，此報告結果僅對測試之樣品負責，同時此樣品僅保留90天。本報告未經本公司書面許可，不可部份複製。

This document is issued by the Company subject to its General Conditions of Service printed overleaf, available on request or accessible at <http://www.sgs.com.tw/Terms-and-Conditions> and for electronic format documents, subject to Terms and Conditions for Electronic Documents at <http://www.sgs.com.tw/Terms-and-Conditions>. Attention is drawn to the limitation of liability, indemnification and jurisdiction issues defined therein. Any holder of this document is advised that information contained hereon reflects the Company's findings at the time of its intervention only and within the limits of Client's instructions, if any. The Company's sole responsibility is to its Client and this document does not exonerate parties to a transaction from exercising all their rights and obligations under the transaction documents. This document cannot be reproduced except in full, without prior written approval of the Company. Any unauthorized alteration, forgery or falsification of the content or appearance of this document is unlawful and offenders may be prosecuted to the fullest extent of the law.

Report Number :TERF2403000759E2
 Operation Mode :802.11ac20
 Test Frequency :5180 MHz
 Test Mode :Tx
 EUT Pol :E2 Plane

Test Site :SAC G Chamber
 Test Date :2024-03-29
 Temp./Humi. :24.3°C/58%
 Antenna Pol. :Horizontal
 Engineer :Temo Chen

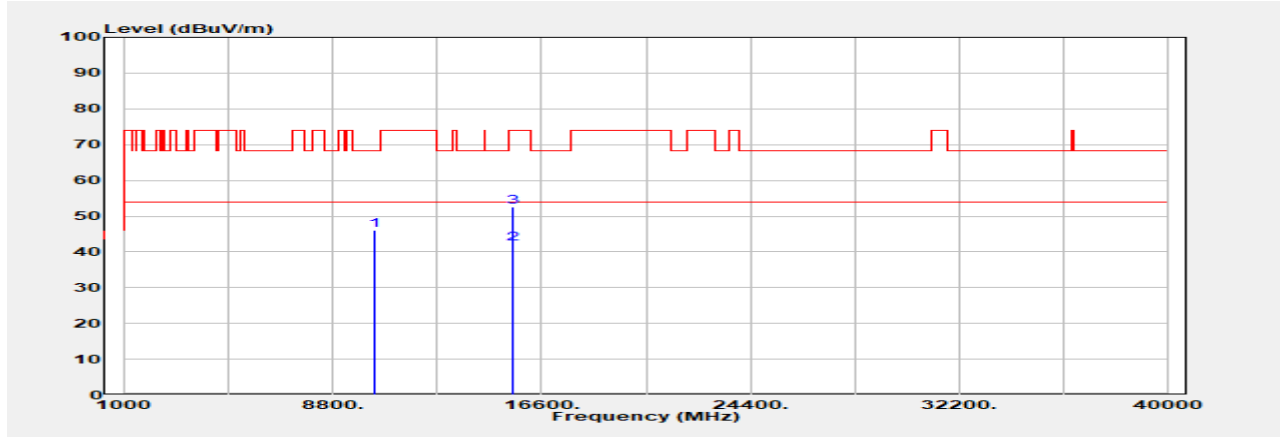

Freq. MHz	Detector Mode PK/QP/AVG	Spectrum Reading Level dB μ V	Factor dB	Actual FS dB μ V/m	Limit @3m dB μ V/m	Margin dB
10360.000	Peak	36.12	9.94	46.06	68.20	-22.14
15540.000	Average	29.79	12.54	42.33	54.00	-11.67
15540.000	Peak	40.09	12.54	52.63	74.00	-21.37

Unless otherwise stated the results shown in this test report refer only to the sample(s) tested and such sample(s) are retained for 90 days only.

除非另有說明，此報告結果僅對測試之樣品負責，同時此樣品僅保留90天。本報告未經本公司書面許可，不可部份複製。

This document is issued by the Company subject to its General Conditions of Service printed overleaf, available on request or accessible at <http://www.sgs.com.tw/Terms-and-Conditions> and for electronic format documents, subject to Terms and Conditions for Electronic Documents at <http://www.sgs.com.tw/Terms-and-Conditions>. Attention is drawn to the limitation of liability, indemnification and jurisdiction issues defined therein. Any holder of this document is advised that information contained hereon reflects the Company's findings at the time of its intervention only and within the limits of Client's instructions, if any. The Company's sole responsibility is to its Client and this document does not exonerate parties to a transaction from exercising all their rights and obligations under the transaction documents. This document cannot be reproduced except in full, without prior written approval of the Company. Any unauthorized alteration, forgery or falsification of the content or appearance of this document is unlawful and offenders may be prosecuted to the fullest extent of the law.

Report Number :TERF2403000759E2
 Operation Mode :802.11ac20
 Test Frequency :5220 MHz
 Test Mode :Tx
 EUT Pol :E2 Plane

Test Site :SAC G Chamber
 Test Date :2024-03-29
 Temp./Humi. :24.3°C/58%
 Antenna Pol. :Vertical
 Engineer :Temo Chen

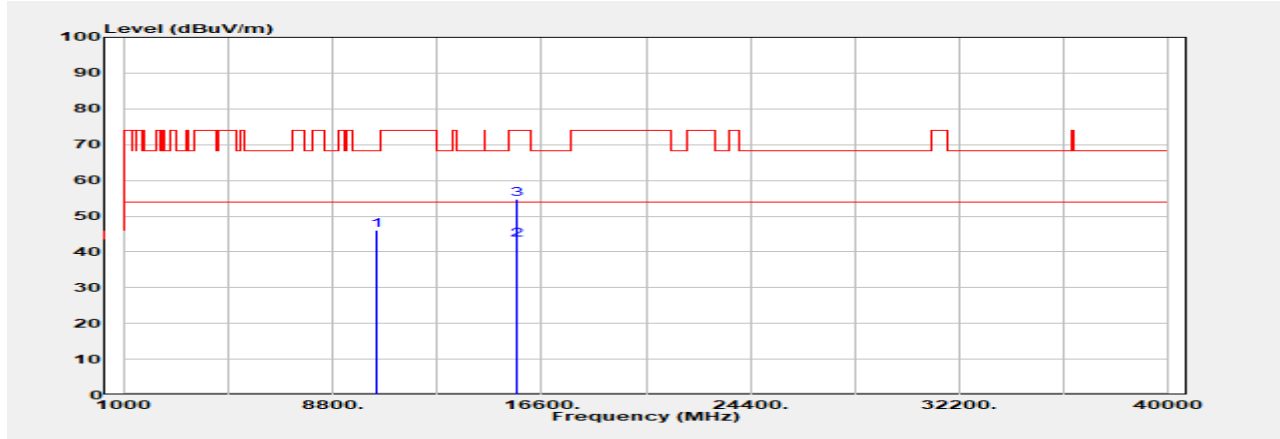

Freq. MHz	Detector Mode PK/QP/AVG	Spectrum Reading Level dB μ V	Factor dB	Actual FS dB μ V/m	Limit @3m dB μ V/m	Margin dB
10440.000	Peak	36.07	9.92	45.99	68.20	-22.21
15660.000	Average	30.04	13.20	43.24	54.00	-10.76
15660.000	Peak	41.58	13.20	54.78	74.00	-19.22

Unless otherwise stated the results shown in this test report refer only to the sample(s) tested and such sample(s) are retained for 90 days only.

除非另有說明，此報告結果僅對測試之樣品負責，同時此樣品僅保留90天。本報告未經本公司書面許可，不可部份複製。

This document is issued by the Company subject to its General Conditions of Service printed overleaf, available on request or accessible at <http://www.sgs.com.tw/Terms-and-Conditions> and for electronic format documents, subject to Terms and Conditions for Electronic Documents at <http://www.sgs.com.tw/Terms-and-Conditions>. Attention is drawn to the limitation of liability, indemnification and jurisdiction issues defined therein. Any holder of this document is advised that information contained hereon reflects the Company's findings at the time of its intervention only and within the limits of Client's instructions, if any. The Company's sole responsibility is to its Client and this document does not exonerate parties to a transaction from exercising all their rights and obligations under the transaction documents. This document cannot be reproduced except in full, without prior written approval of the Company. Any unauthorized alteration, forgery or falsification of the content or appearance of this document is unlawful and offenders may be prosecuted to the fullest extent of the law.

Report Number :TERF2403000759E2
 Operation Mode :802.11ac20
 Test Frequency :5220 MHz
 Test Mode :Tx
 EUT Pol :E2 Plane

Test Site :SAC G Chamber
 Test Date :2024-03-29
 Temp./Humi. :24.3°C/58%
 Antenna Pol. :Horizontal
 Engineer :Temo Chen

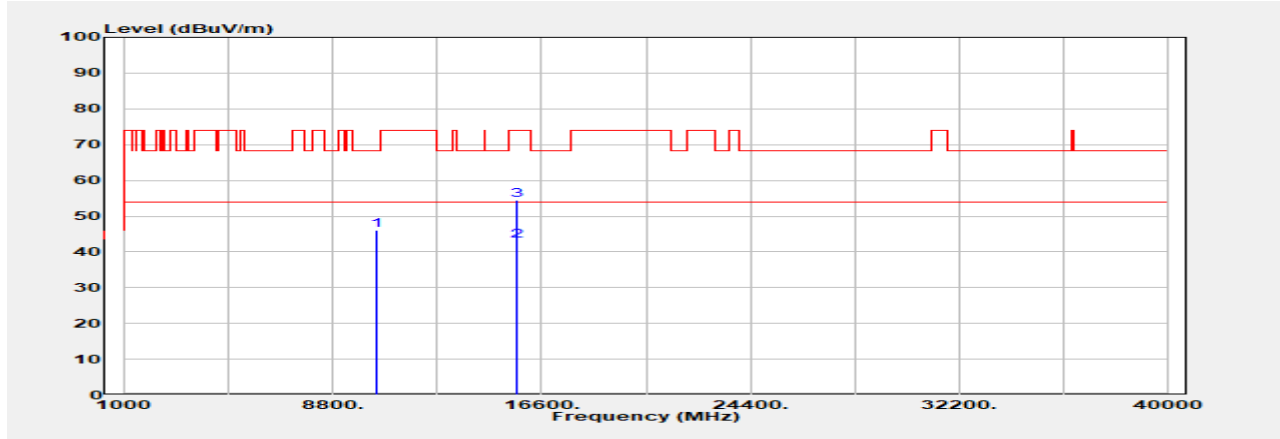

Freq. MHz	Detector Mode PK/QP/AVG	Spectrum Reading Level dBμV	Factor dB	Actual FS dBμV/m	Limit @3m dBμV/m	Margin dB
10440.000	Peak	36.03	9.92	45.95	68.20	-22.25
15660.000	Average	30.01	13.20	43.21	54.00	-10.79
15660.000	Peak	41.22	13.20	54.42	74.00	-19.58

Unless otherwise stated the results shown in this test report refer only to the sample(s) tested and such sample(s) are retained for 90 days only.

除非另有說明，此報告結果僅對測試之樣品負責，同時此樣品僅保留90天。本報告未經本公司書面許可，不可部份複製。

This document is issued by the Company subject to its General Conditions of Service printed overleaf, available on request or accessible at <http://www.sgs.com.tw/Terms-and-Conditions> and for electronic format documents, subject to Terms and Conditions for Electronic Documents at <http://www.sgs.com.tw/Terms-and-Conditions>. Attention is drawn to the limitation of liability, indemnification and jurisdiction issues defined therein. Any holder of this document is advised that information contained hereon reflects the Company's findings at the time of its intervention only and within the limits of Client's instructions, if any. The Company's sole responsibility is to its Client and this document does not exonerate parties to a transaction from exercising all their rights and obligations under the transaction documents. This document cannot be reproduced except in full, without prior written approval of the Company. Any unauthorized alteration, forgery or falsification of the content or appearance of this document is unlawful and offenders may be prosecuted to the fullest extent of the law.

Report Number :TERF2403000759E2
 Operation Mode :802.11ac20
 Test Frequency :5240 MHz
 Test Mode :Tx
 EUT Pol :E2 Plane

Test Site :SAC G Chamber
 Test Date :2024-03-29
 Temp./Humi. :24.3°C/58%
 Antenna Pol. :Vertical
 Engineer :Temo Chen

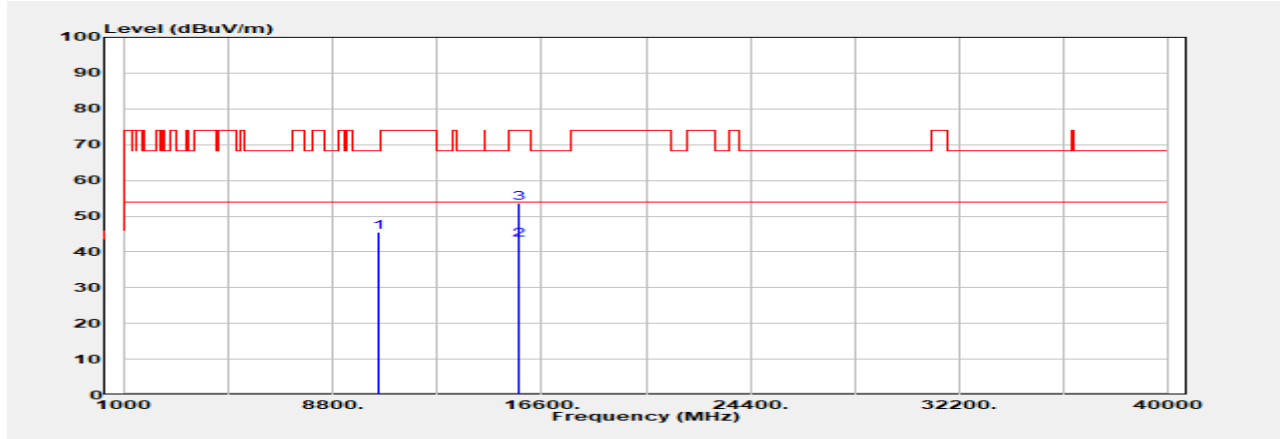

Freq. MHz	Detector Mode PK/QP/AVG	Spectrum Reading Level dB μ V	Factor dB	Actual FS dB μ V/m	Limit @3m dB μ V/m	Margin dB
10480.000	Peak	35.87	9.59	45.46	68.20	-22.74
15720.000	Average	29.68	13.67	43.35	54.00	-10.65
15720.000	Peak	39.92	13.67	53.60	74.00	-20.40

Unless otherwise stated the results shown in this test report refer only to the sample(s) tested and such sample(s) are retained for 90 days only.

除非另有說明，此報告結果僅對測試之樣品負責，同時此樣品僅保留90天。本報告未經本公司書面許可，不可部份複製。

This document is issued by the Company subject to its General Conditions of Service printed overleaf, available on request or accessible at <http://www.sgs.com.tw/Terms-and-Conditions> and for electronic format documents, subject to Terms and Conditions for Electronic Documents at <http://www.sgs.com.tw/Terms-and-Conditions>. Attention is drawn to the limitation of liability, indemnification and jurisdiction issues defined therein. Any holder of this document is advised that information contained hereon reflects the Company's findings at the time of its intervention only and within the limits of Client's instructions, if any. The Company's sole responsibility is to its Client and this document does not exonerate parties to a transaction from exercising all their rights and obligations under the transaction documents. This document cannot be reproduced except in full, without prior written approval of the Company. Any unauthorized alteration, forgery or falsification of the content or appearance of this document is unlawful and offenders may be prosecuted to the fullest extent of the law.

Report Number :TERF2403000759E2
 Operation Mode :802.11ac20
 Test Frequency :5240 MHz
 Test Mode :Tx
 EUT Pol :E2 Plane

Test Site :SAC G Chamber
 Test Date :2024-03-29
 Temp./Humi. :24.3°C/58%
 Antenna Pol. :Horizontal
 Engineer :Temo Chen

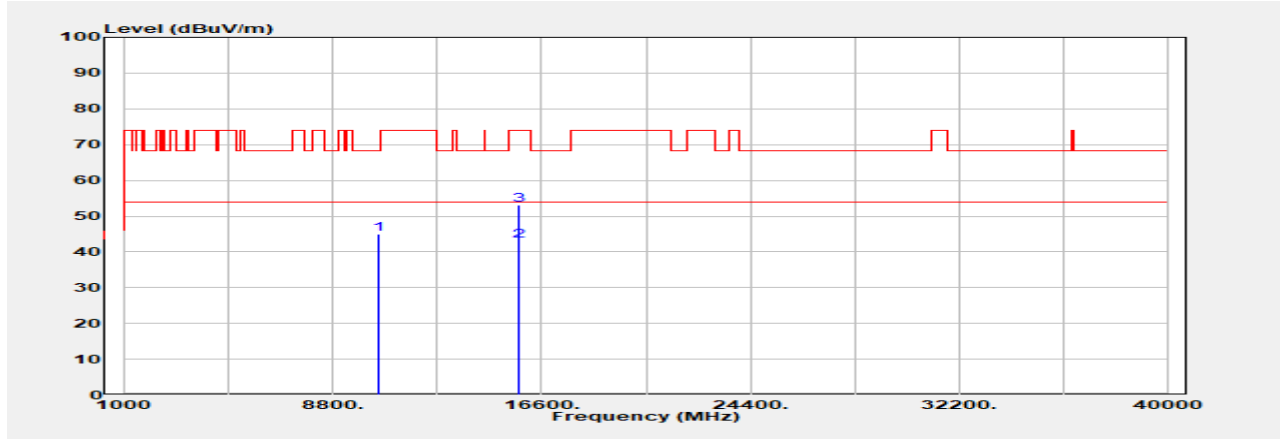

Freq. MHz	Detector Mode PK/QP/AVG	Spectrum Reading Level dB μ V	Factor dB	Actual FS dB μ V/m	Limit @3m dB μ V/m	Margin dB
10480.000	Peak	35.52	9.59	45.12	68.20	-23.08
15720.000	Average	29.50	13.67	43.17	54.00	-10.83
15720.000	Peak	39.37	13.67	53.04	74.00	-20.96

Unless otherwise stated the results shown in this test report refer only to the sample(s) tested and such sample(s) are retained for 90 days only.

除非另有說明，此報告結果僅對測試之樣品負責，同時此樣品僅保留90天。本報告未經本公司書面許可，不可部份複製。

This document is issued by the Company subject to its General Conditions of Service printed overleaf, available on request or accessible at <http://www.sgs.com.tw/Terms-and-Conditions> and for electronic format documents, subject to Terms and Conditions for Electronic Documents at <http://www.sgs.com.tw/Terms-and-Conditions>. Attention is drawn to the limitation of liability, indemnification and jurisdiction issues defined therein. Any holder of this document is advised that information contained hereon reflects the Company's findings at the time of its intervention only and within the limits of Client's instructions, if any. The Company's sole responsibility is to its Client and this document does not exonerate parties to a transaction from exercising all their rights and obligations under the transaction documents. This document cannot be reproduced except in full, without prior written approval of the Company. Any unauthorized alteration, forgery or falsification of the content or appearance of this document is unlawful and offenders may be prosecuted to the fullest extent of the law.

Report Number :TERF2403000759E2
 Operation Mode :802.11ac20
 Test Frequency :5260 MHz
 Test Mode :Tx
 EUT Pol :E2 Plane

Test Site :SAC G Chamber
 Test Date :2024-03-29
 Temp./Humi. :24.3°C/58%
 Antenna Pol. :Vertical
 Engineer :Temo Chen

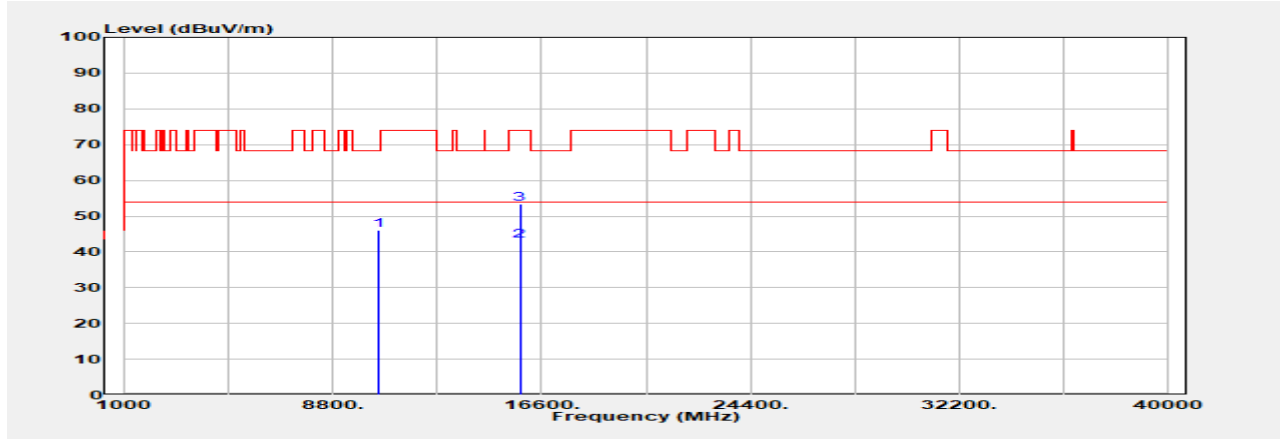

Freq. MHz	Detector Mode PK/QP/AVG	Spectrum Reading Level dBμV	Factor dB	Actual FS dBμV/m	Limit @3m dBμV/m	Margin dB
10520.000	Peak	36.63	9.53	46.17	68.20	-22.03
15780.000	Average	29.98	13.20	43.18	54.00	-10.82
15780.000	Peak	40.12	13.20	53.32	74.00	-20.68

Unless otherwise stated the results shown in this test report refer only to the sample(s) tested and such sample(s) are retained for 90 days only.

除非另有說明，此報告結果僅對測試之樣品負責，同時此樣品僅保留90天。本報告未經本公司書面許可，不可部份複製。

This document is issued by the Company subject to its General Conditions of Service printed overleaf, available on request or accessible at <http://www.sgs.com.tw/Terms-and-Conditions> and for electronic format documents, subject to Terms and Conditions for Electronic Documents at <http://www.sgs.com.tw/Terms-and-Conditions>. Attention is drawn to the limitation of liability, indemnification and jurisdiction issues defined therein. Any holder of this document is advised that information contained hereon reflects the Company's findings at the time of its intervention only and within the limits of Client's instructions, if any. The Company's sole responsibility is to its Client and this document does not exonerate parties to a transaction from exercising all their rights and obligations under the transaction documents. This document cannot be reproduced except in full, without prior written approval of the Company. Any unauthorized alteration, forgery or falsification of the content or appearance of this document is unlawful and offenders may be prosecuted to the fullest extent of the law.

Report Number :TERF2403000759E2
 Operation Mode :802.11ac20
 Test Frequency :5260 MHz
 Test Mode :Tx
 EUT Pol :E2 Plane

Test Site :SAC G Chamber
 Test Date :2024-03-29
 Temp./Humi. :24.3°C/58%
 Antenna Pol. :Horizontal
 Engineer :Temo Chen

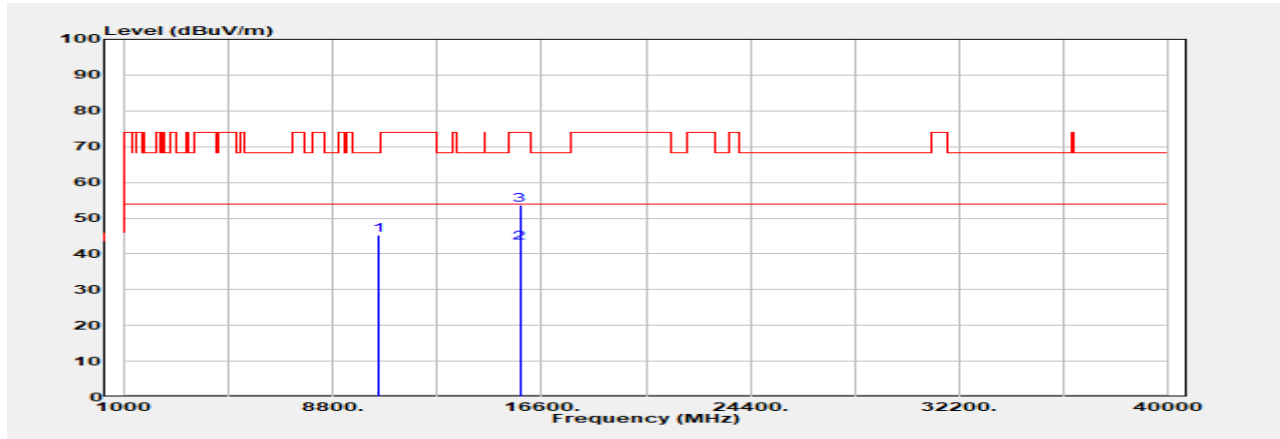

Freq. MHz	Detector Mode PK/QP/AVG	Spectrum Reading Level dB μ V	Factor dB	Actual FS dB μ V/m	Limit @3m dB μ V/m	Margin dB
10520.000	Peak	35.85	9.53	45.38	68.20	-22.82
15780.000	Average	29.90	13.20	43.10	54.00	-10.90
15780.000	Peak	40.52	13.20	53.71	74.00	-20.29

Unless otherwise stated the results shown in this test report refer only to the sample(s) tested and such sample(s) are retained for 90 days only.

除非另有說明，此報告結果僅對測試之樣品負責，同時此樣品僅保留90天。本報告未經本公司書面許可，不可部份複製。

This document is issued by the Company subject to its General Conditions of Service printed overleaf, available on request or accessible at <http://www.sgs.com.tw/Terms-and-Conditions> and for electronic format documents, subject to Terms and Conditions for Electronic Documents at <http://www.sgs.com.tw/Terms-and-Conditions>. Attention is drawn to the limitation of liability, indemnification and jurisdiction issues defined therein. Any holder of this document is advised that information contained hereon reflects the Company's findings at the time of its intervention only and within the limits of Client's instructions, if any. The Company's sole responsibility is to its Client and this document does not exonerate parties to a transaction from exercising all their rights and obligations under the transaction documents. This document cannot be reproduced except in full, without prior written approval of the Company. Any unauthorized alteration, forgery or falsification of the content or appearance of this document is unlawful and offenders may be prosecuted to the fullest extent of the law.

Report Number :TERF2403000759E2
 Operation Mode :802.11ac20
 Test Frequency :5300 MHz
 Test Mode :Tx
 EUT Pol :E2 Plane

Test Site :SAC G Chamber
 Test Date :2024-03-29
 Temp./Humi. :24.3°C/58%
 Antenna Pol. :Vertical
 Engineer :Temo Chen

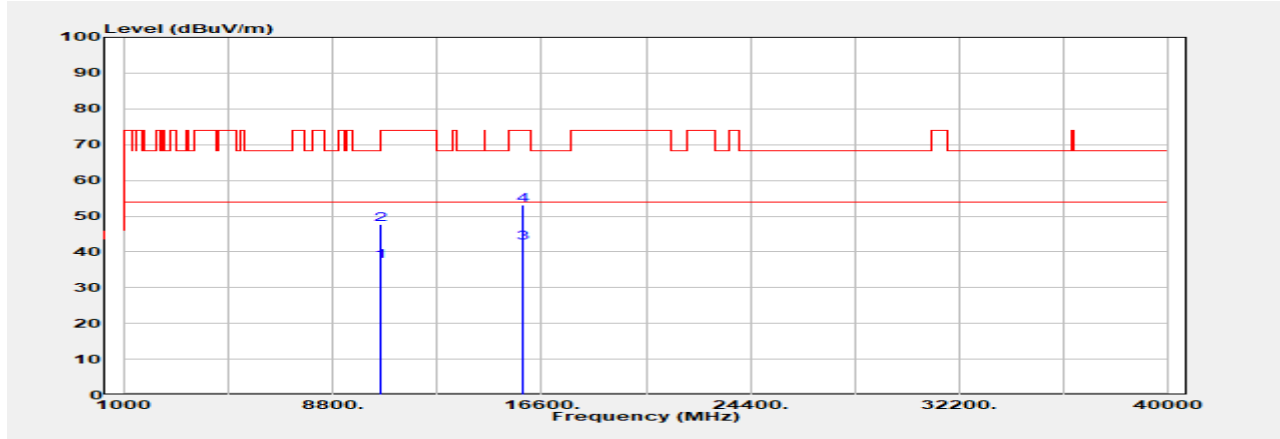

Freq. MHz	Detector Mode PK/QP/AVG	Spectrum Reading Level dB μ V	Factor dB	Actual FS dB μ V/m	Limit @3m dB μ V/m	Margin dB
10600.000	Average	27.59	9.94	37.53	54.00	-16.47
10600.000	Peak	37.64	9.94	47.58	74.00	-26.42
15900.000	Average	29.34	13.15	42.49	54.00	-11.51
15900.000	Peak	39.97	13.15	53.12	74.00	-20.88

Unless otherwise stated the results shown in this test report refer only to the sample(s) tested and such sample(s) are retained for 90 days only.

除非另有說明，此報告結果僅對測試之樣品負責，同時此樣品僅保留90天。本報告未經本公司書面許可，不可部份複製。

This document is issued by the Company subject to its General Conditions of Service printed overleaf, available on request or accessible at <http://www.sgs.com.tw/Terms-and-Conditions> and for electronic format documents, subject to Terms and Conditions for Electronic Documents at <http://www.sgs.com.tw/Terms-and-Conditions>. Attention is drawn to the limitation of liability, indemnification and jurisdiction issues defined therein. Any holder of this document is advised that information contained hereon reflects the Company's findings at the time of its intervention only and within the limits of Client's instructions, if any. The Company's sole responsibility is to its Client and this document does not exonerate parties to a transaction from exercising all their rights and obligations under the transaction documents. This document cannot be reproduced except in full, without prior written approval of the Company. Any unauthorized alteration, forgery or falsification of the content or appearance of this document is unlawful and offenders may be prosecuted to the fullest extent of the law.

Report Number :TERF2403000759E2
 Operation Mode :802.11ac20
 Test Frequency :5300 MHz
 Test Mode :Tx
 EUT Pol :E2 Plane

Test Site :SAC G Chamber
 Test Date :2024-03-29
 Temp./Humi. :24.3°C/58%
 Antenna Pol. :Horizontal
 Engineer :Temo Chen

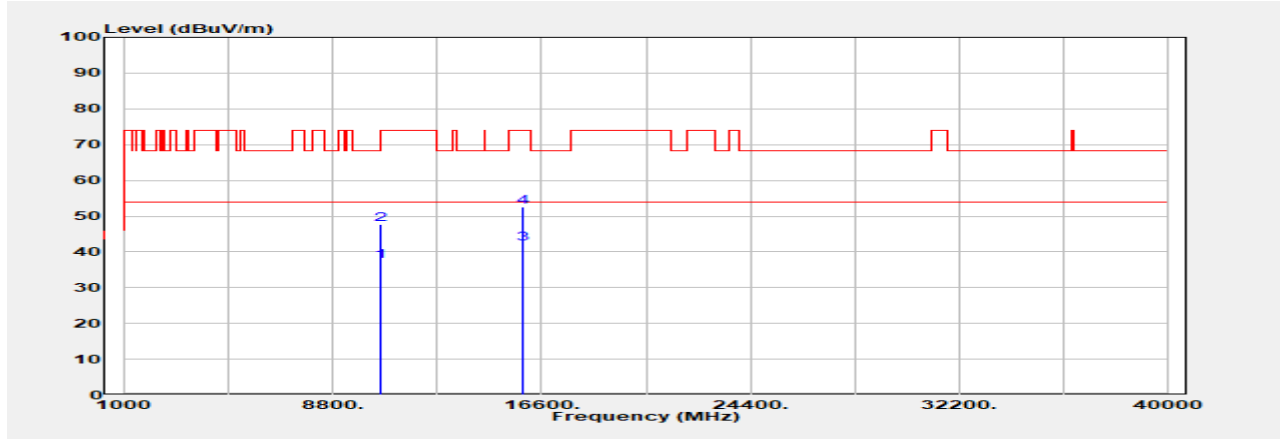

Freq. MHz	Detector Mode PK/QP/AVG	Spectrum Reading Level dB μ V	Factor dB	Actual FS dB μ V/m	Limit @3m dB μ V/m	Margin dB
10600.000	Average	27.39	9.94	37.33	54.00	-16.67
10600.000	Peak	37.74	9.94	47.68	74.00	-26.32
15900.000	Average	29.13	13.15	42.28	54.00	-11.72
15900.000	Peak	39.42	13.15	52.57	74.00	-21.43

Unless otherwise stated the results shown in this test report refer only to the sample(s) tested and such sample(s) are retained for 90 days only.

除非另有說明，此報告結果僅對測試之樣品負責，同時此樣品僅保留90天。本報告未經本公司書面許可，不可部份複製。

This document is issued by the Company subject to its General Conditions of Service printed overleaf, available on request or accessible at <http://www.sgs.com.tw/Terms-and-Conditions> and for electronic format documents, subject to Terms and Conditions for Electronic Documents at <http://www.sgs.com.tw/Terms-and-Conditions>. Attention is drawn to the limitation of liability, indemnification and jurisdiction issues defined therein. Any holder of this document is advised that information contained hereon reflects the Company's findings at the time of its intervention only and within the limits of Client's instructions, if any. The Company's sole responsibility is to its Client and this document does not exonerate parties to a transaction from exercising all their rights and obligations under the transaction documents. This document cannot be reproduced except in full, without prior written approval of the Company. Any unauthorized alteration, forgery or falsification of the content or appearance of this document is unlawful and offenders may be prosecuted to the fullest extent of the law.

Report Number :TERF2403000759E2
 Operation Mode :802.11ac20
 Test Frequency :5320 MHz
 Test Mode :Tx
 EUT Pol :E2 Plane

Test Site :SAC G Chamber
 Test Date :2024-03-29
 Temp./Humi. :24.3°C/58%
 Antenna Pol. :Vertical
 Engineer :Temo Chen

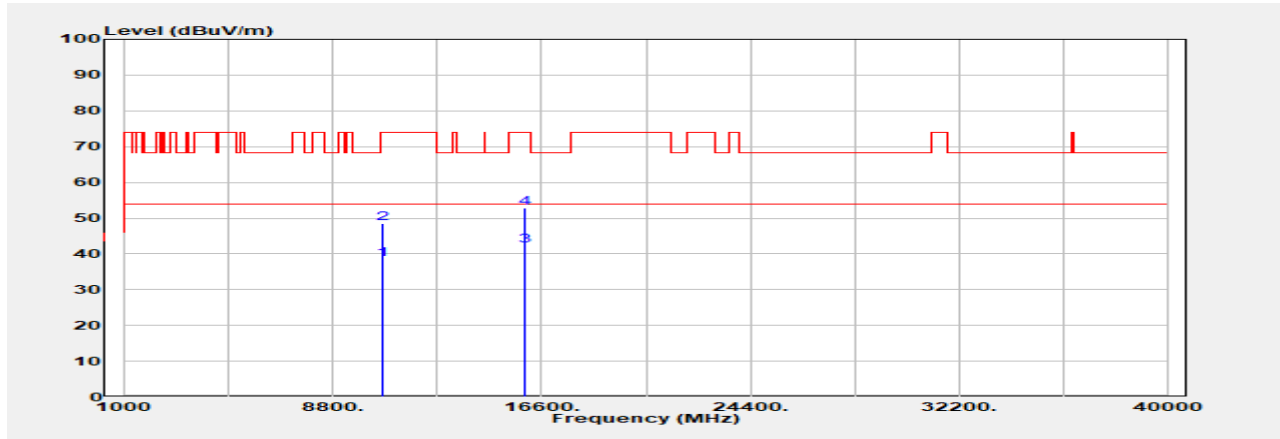

Freq. MHz	Detector Mode PK/QP/AVG	Spectrum Reading Level dB μ V	Factor dB	Actual FS dB μ V/m	Limit @3m dB μ V/m	Margin dB
10640.000	Average	28.56	9.98	38.54	54.00	-15.46
10640.000	Peak	38.45	9.98	48.43	74.00	-25.57
15960.000	Average	29.70	12.70	42.40	54.00	-11.60
15960.000	Peak	40.03	12.70	52.73	74.00	-21.27

Unless otherwise stated the results shown in this test report refer only to the sample(s) tested and such sample(s) are retained for 90 days only.

除非另有說明，此報告結果僅對測試之樣品負責，同時此樣品僅保留90天。本報告未經本公司書面許可，不可部份複製。

This document is issued by the Company subject to its General Conditions of Service printed overleaf, available on request or accessible at <http://www.sgs.com.tw/Terms-and-Conditions> and for electronic format documents, subject to Terms and Conditions for Electronic Documents at <http://www.sgs.com.tw/Terms-and-Conditions>. Attention is drawn to the limitation of liability, indemnification and jurisdiction issues defined therein. Any holder of this document is advised that information contained hereon reflects the Company's findings at the time of its intervention only and within the limits of Client's instructions, if any. The Company's sole responsibility is to its Client and this document does not exonerate parties to a transaction from exercising all their rights and obligations under the transaction documents. This document cannot be reproduced except in full, without prior written approval of the Company. Any unauthorized alteration, forgery or falsification of the content or appearance of this document is unlawful and offenders may be prosecuted to the fullest extent of the law.

Report Number :TERF2403000759E2
 Operation Mode :802.11ac20
 Test Frequency :5320 MHz
 Test Mode :Tx
 EUT Pol :E2 Plane

Test Site :SAC G Chamber
 Test Date :2024-03-29
 Temp./Humi. :24.3°C/58%
 Antenna Pol. :Horizontal
 Engineer :Temo Chen

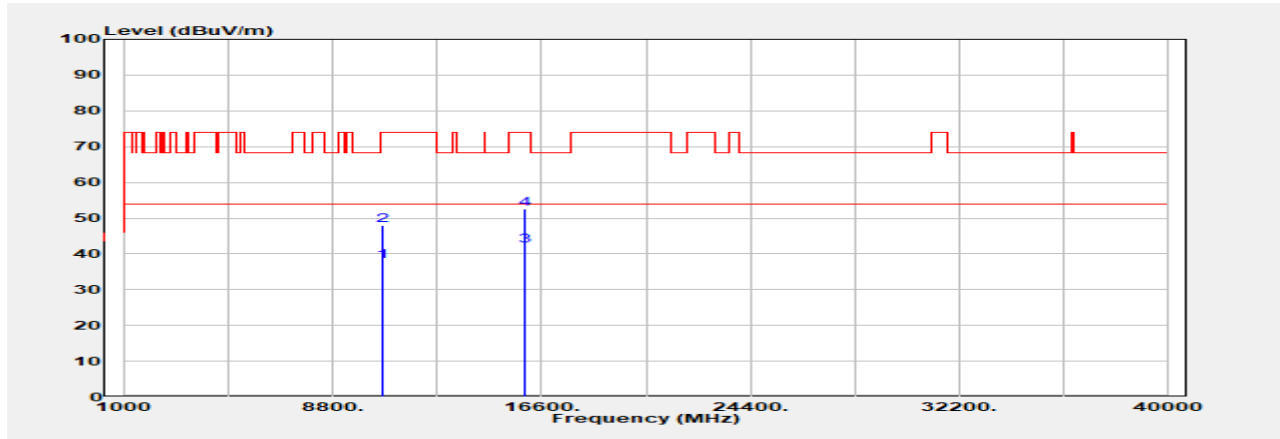

Freq. MHz	Detector Mode PK/QP/AVG	Spectrum Reading Level dB μ V	Factor dB	Actual FS dB μ V/m	Limit @3m dB μ V/m	Margin dB
10640.000	Average	27.92	9.98	37.90	54.00	-16.10
10640.000	Peak	38.00	9.98	47.98	74.00	-26.02
15960.000	Average	29.67	12.70	42.37	54.00	-11.63
15960.000	Peak	39.81	12.70	52.51	74.00	-21.49

Unless otherwise stated the results shown in this test report refer only to the sample(s) tested and such sample(s) are retained for 90 days only.

除非另有說明，此報告結果僅對測試之樣品負責，同時此樣品僅保留90天。本報告未經本公司書面許可，不可部份複製。

This document is issued by the Company subject to its General Conditions of Service printed overleaf, available on request or accessible at <http://www.sgs.com.tw/Terms-and-Conditions> and for electronic format documents, subject to Terms and Conditions for Electronic Documents at <http://www.sgs.com.tw/Terms-and-Conditions>. Attention is drawn to the limitation of liability, indemnification and jurisdiction issues defined therein. Any holder of this document is advised that information contained hereon reflects the Company's findings at the time of its intervention only and within the limits of Client's instructions, if any. The Company's sole responsibility is to its Client and this document does not exonerate parties to a transaction from exercising all their rights and obligations under the transaction documents. This document cannot be reproduced except in full, without prior written approval of the Company. Any unauthorized alteration, forgery or falsification of the content or appearance of this document is unlawful and offenders may be prosecuted to the fullest extent of the law.

Report Number :TERF2403000759E2
 Operation Mode :802.11ac20
 Test Frequency :5500 MHz
 Test Mode :Tx
 EUT Pol :E2 Plane

Test Site :SAC G Chamber
 Test Date :2024-03-29
 Temp./Humi. :24.3°C/58%
 Antenna Pol. :Vertical
 Engineer :Temo Chen

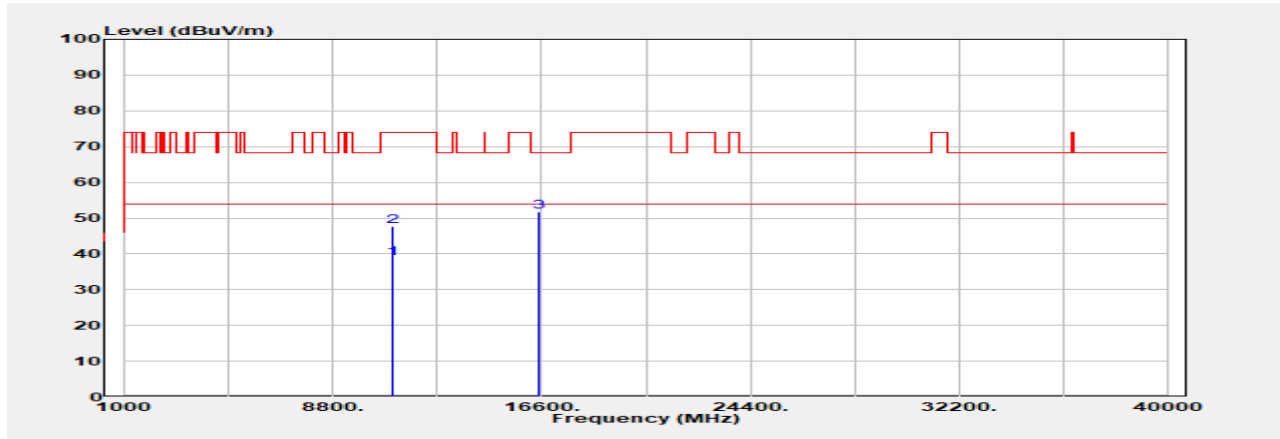

Freq. MHz	Detector Mode PK/QP/AVG	Spectrum Reading Level dBμV	Factor dB	Actual FS dBμV/m	Limit @3m dBμV/m	Margin dB
11000.000	Average	28.60	10.27	38.87	54.00	-15.13
11000.000	Peak	37.34	10.27	47.61	74.00	-26.39
16500.000	Peak	39.04	12.85	51.89	68.20	-16.31

Unless otherwise stated the results shown in this test report refer only to the sample(s) tested and such sample(s) are retained for 90 days only.

除非另有說明，此報告結果僅對測試之樣品負責，同時此樣品僅保留90天。本報告未經本公司書面許可，不可部份複製。

This document is issued by the Company subject to its General Conditions of Service printed overleaf, available on request or accessible at <http://www.sgs.com.tw/Terms-and-Conditions> and for electronic format documents, subject to Terms and Conditions for Electronic Documents at <http://www.sgs.com.tw/Terms-and-Conditions>. Attention is drawn to the limitation of liability, indemnification and jurisdiction issues defined therein. Any holder of this document is advised that information contained hereon reflects the Company's findings at the time of its intervention only and within the limits of Client's instructions, if any. The Company's sole responsibility is to its Client and this document does not exonerate parties to a transaction from exercising all their rights and obligations under the transaction documents. This document cannot be reproduced except in full, without prior written approval of the Company. Any unauthorized alteration, forgery or falsification of the content or appearance of this document is unlawful and offenders may be prosecuted to the fullest extent of the law.

Report Number :TERF2403000759E2
 Operation Mode :802.11ac20
 Test Frequency :5500 MHz
 Test Mode :Tx
 EUT Pol :E2 Plane

Test Site :SAC G Chamber
 Test Date :2024-03-29
 Temp./Humi. :24.3°C/58%
 Antenna Pol. :Horizontal
 Engineer :Temo Chen

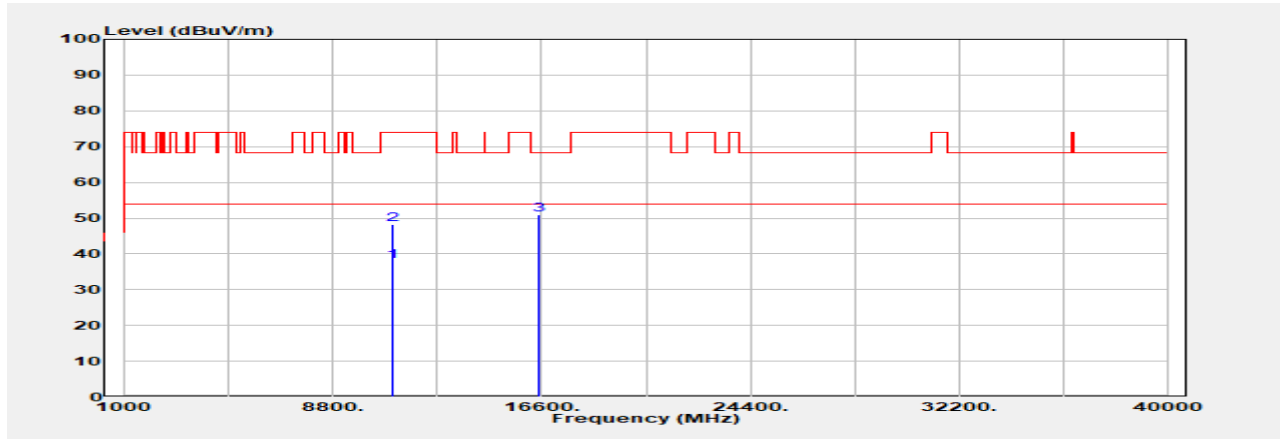

Freq. MHz	Detector Mode PK/QP/AVG	Spectrum Reading Level dBμV	Factor dB	Actual FS dBμV/m	Limit @3m dBμV/m	Margin dB
11000.000	Average	27.62	10.27	37.89	54.00	-16.11
11000.000	Peak	38.06	10.27	48.33	74.00	-25.67
16500.000	Peak	38.04	12.85	50.89	68.20	-17.31

Unless otherwise stated the results shown in this test report refer only to the sample(s) tested and such sample(s) are retained for 90 days only.

除非另有說明，此報告結果僅對測試之樣品負責，同時此樣品僅保留90天。本報告未經本公司書面許可，不可部份複製。

This document is issued by the Company subject to its General Conditions of Service printed overleaf, available on request or accessible at <http://www.sgs.com.tw/Terms-and-Conditions> and for electronic format documents, subject to Terms and Conditions for Electronic Documents at <http://www.sgs.com.tw/Terms-and-Conditions>. Attention is drawn to the limitation of liability, indemnification and jurisdiction issues defined therein. Any holder of this document is advised that information contained hereon reflects the Company's findings at the time of its intervention only and within the limits of Client's instructions, if any. The Company's sole responsibility is to its Client and this document does not exonerate parties to a transaction from exercising all their rights and obligations under the transaction documents. This document cannot be reproduced except in full, without prior written approval of the Company. Any unauthorized alteration, forgery or falsification of the content or appearance of this document is unlawful and offenders may be prosecuted to the fullest extent of the law.

Report Number :TERF2403000759E2
 Operation Mode :802.11ac20
 Test Frequency :5580 MHz
 Test Mode :Tx
 EUT Pol :E2 Plane

Test Site :SAC G Chamber
 Test Date :2024-03-29
 Temp./Humi. :24.3°C/58%
 Antenna Pol. :Vertical
 Engineer :Temo Chen

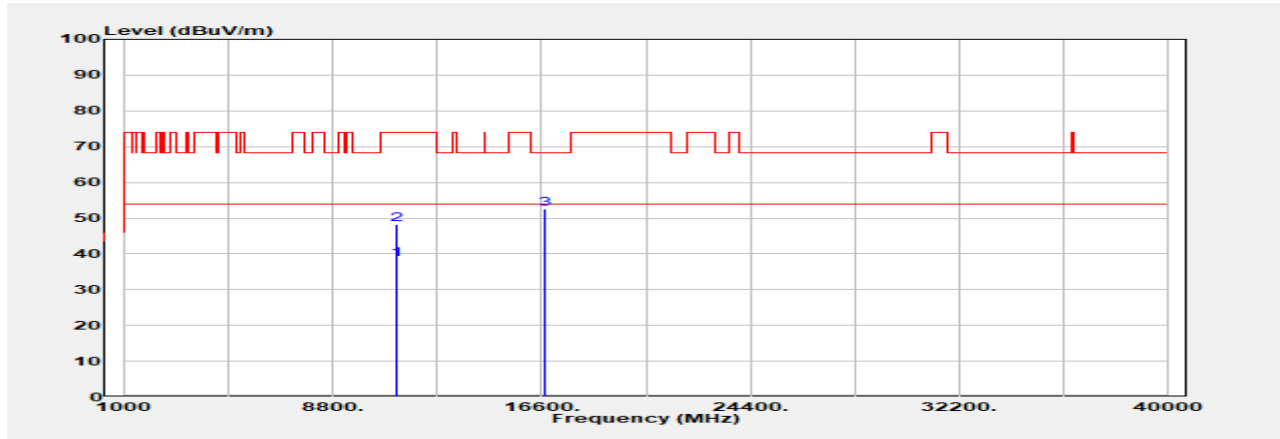

Freq. MHz	Detector Mode PK/QP/AVG	Spectrum Reading Level dB μ V	Factor dB	Actual FS dB μ V/m	Limit @3m dB μ V/m	Margin dB
11160.000	Average	28.35	10.10	38.45	54.00	-15.55
11160.000	Peak	38.01	10.10	48.11	74.00	-25.89
16740.000	Peak	40.01	12.58	52.60	68.20	-15.60

Unless otherwise stated the results shown in this test report refer only to the sample(s) tested and such sample(s) are retained for 90 days only.

除非另有說明，此報告結果僅對測試之樣品負責，同時此樣品僅保留90天。本報告未經本公司書面許可，不可部份複製。

This document is issued by the Company subject to its General Conditions of Service printed overleaf, available on request or accessible at <http://www.sgs.com.tw/Terms-and-Conditions> and for electronic format documents, subject to Terms and Conditions for Electronic Documents at <http://www.sgs.com.tw/Terms-and-Conditions>. Attention is drawn to the limitation of liability, indemnification and jurisdiction issues defined therein. Any holder of this document is advised that information contained hereon reflects the Company's findings at the time of its intervention only and within the limits of Client's instructions, if any. The Company's sole responsibility is to its Client and this document does not exonerate parties to a transaction from exercising all their rights and obligations under the transaction documents. This document cannot be reproduced except in full, without prior written approval of the Company. Any unauthorized alteration, forgery or falsification of the content or appearance of this document is unlawful and offenders may be prosecuted to the fullest extent of the law.

Report Number :TERF2403000759E2
 Operation Mode :802.11ac20
 Test Frequency :5580 MHz
 Test Mode :Tx
 EUT Pol :E2 Plane

Test Site :SAC G Chamber
 Test Date :2024-03-29
 Temp./Humi. :24.3°C/58%
 Antenna Pol. :Horizontal
 Engineer :Temo Chen



Freq. MHz	Detector Mode PK/QP/AVG	Spectrum Reading Level dB μ V	Factor dB	Actual FS dB μ V/m	Limit @3m dB μ V/m	Margin dB
11160.000	Average	28.75	10.10	38.85	54.00	-15.15
11160.000	Peak	36.77	10.10	46.87	74.00	-27.13
16740.000	Peak	39.31	12.58	51.90	68.20	-16.30

Unless otherwise stated the results shown in this test report refer only to the sample(s) tested and such sample(s) are retained for 90 days only.

除非另有說明，此報告結果僅對測試之樣品負責，同時此樣品僅保留90天。本報告未經本公司書面許可，不可部份複製。

This document is issued by the Company subject to its General Conditions of Service printed overleaf, available on request or accessible at <http://www.sgs.com.tw/Terms-and-Conditions> and for electronic format documents, subject to Terms and Conditions for Electronic Documents at <http://www.sgs.com.tw/Terms-and-Conditions>. Attention is drawn to the limitation of liability, indemnification and jurisdiction issues defined therein. Any holder of this document is advised that information contained hereon reflects the Company's findings at the time of its intervention only and within the limits of Client's instructions, if any. The Company's sole responsibility is to its Client and this document does not exonerate parties to a transaction from exercising all their rights and obligations under the transaction documents. This document cannot be reproduced except in full, without prior written approval of the Company. Any unauthorized alteration, forgery or falsification of the content or appearance of this document is unlawful and offenders may be prosecuted to the fullest extent of the law.

Report Number :TERF2403000759E2
 Operation Mode :802.11ac20
 Test Frequency :5700 MHz
 Test Mode :Tx
 EUT Pol :E2 Plane

Test Site :SAC G Chamber
 Test Date :2024-03-29
 Temp./Humi. :24.3°C/58%
 Antenna Pol. :Vertical
 Engineer :Temo Chen

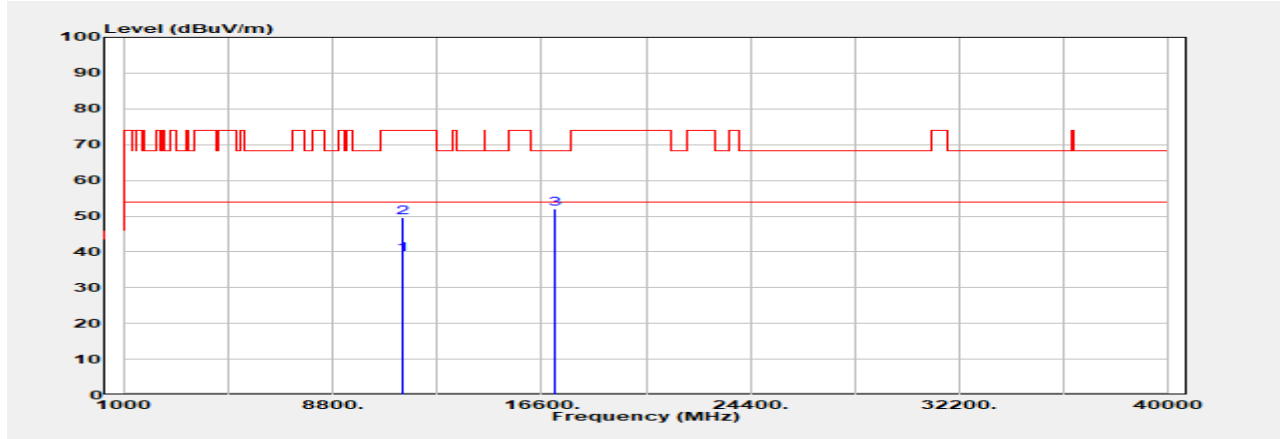

Freq. MHz	Detector Mode PK/QP/AVG	Spectrum Reading Level dB μ V	Factor dB	Actual FS dB μ V/m	Limit @3m dB μ V/m	Margin dB
11400.000	Average	26.87	12.32	39.19	54.00	-14.81
11400.000	Peak	37.40	12.32	49.72	74.00	-24.28
17100.000	Peak	39.48	12.62	52.10	68.20	-16.10

Unless otherwise stated the results shown in this test report refer only to the sample(s) tested and such sample(s) are retained for 90 days only.

除非另有說明，此報告結果僅對測試之樣品負責，同時此樣品僅保留90天。本報告未經本公司書面許可，不可部份複製。

This document is issued by the Company subject to its General Conditions of Service printed overleaf, available on request or accessible at <http://www.sgs.com.tw/Terms-and-Conditions> and for electronic format documents, subject to Terms and Conditions for Electronic Documents at <http://www.sgs.com.tw/Terms-and-Conditions>. Attention is drawn to the limitation of liability, indemnification and jurisdiction issues defined therein. Any holder of this document is advised that information contained hereon reflects the Company's findings at the time of its intervention only and within the limits of Client's instructions, if any. The Company's sole responsibility is to its Client and this document does not exonerate parties to a transaction from exercising all their rights and obligations under the transaction documents. This document cannot be reproduced except in full, without prior written approval of the Company. Any unauthorized alteration, forgery or falsification of the content or appearance of this document is unlawful and offenders may be prosecuted to the fullest extent of the law.

Report Number :TERF2403000759E2
 Operation Mode :802.11ac20
 Test Frequency :5700 MHz
 Test Mode :Tx
 EUT Pol :E2 Plane

Test Site :SAC G Chamber
 Test Date :2024-03-29
 Temp./Humi. :24.3°C/58%
 Antenna Pol. :Horizontal
 Engineer :Temo Chen

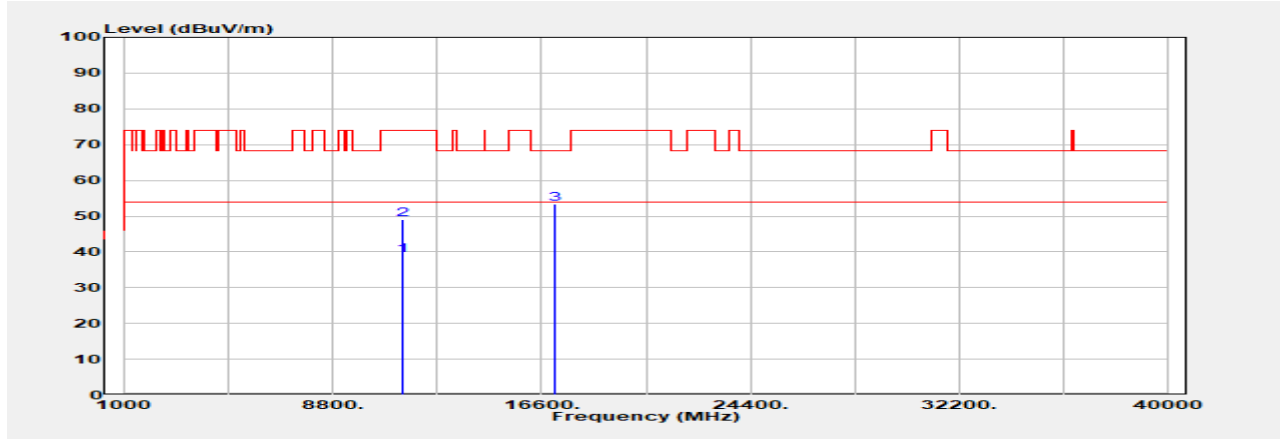

Freq. MHz	Detector Mode PK/QP/AVG	Spectrum Reading Level dB μ V	Factor dB	Actual FS dB μ V/m	Limit @3m dB μ V/m	Margin dB
11400.000	Average	26.80	12.32	39.12	54.00	-14.88
11400.000	Peak	36.75	12.32	49.07	74.00	-24.93
17100.000	Peak	40.70	12.62	53.32	68.20	-14.88

Unless otherwise stated the results shown in this test report refer only to the sample(s) tested and such sample(s) are retained for 90 days only.

除非另有說明，此報告結果僅對測試之樣品負責，同時此樣品僅保留90天。本報告未經本公司書面許可，不可部份複製。

This document is issued by the Company subject to its General Conditions of Service printed overleaf, available on request or accessible at <http://www.sgs.com.tw/Terms-and-Conditions> and for electronic format documents, subject to Terms and Conditions for Electronic Documents at <http://www.sgs.com.tw/Terms-and-Conditions>. Attention is drawn to the limitation of liability, indemnification and jurisdiction issues defined therein. Any holder of this document is advised that information contained hereon reflects the Company's findings at the time of its intervention only and within the limits of Client's instructions, if any. The Company's sole responsibility is to its Client and this document does not exonerate parties to a transaction from exercising all their rights and obligations under the transaction documents. This document cannot be reproduced except in full, without prior written approval of the Company. Any unauthorized alteration, forgery or falsification of the content or appearance of this document is unlawful and offenders may be prosecuted to the fullest extent of the law.

Report Number	:TERF2403000759E2	Test Site	:SAC G Chamber
Operation Mode	:802.11ac20	Test Date	:2024-03-29
Test Frequency	:5720 MHz	Temp./Humi.	:24.3°C/58%
Test Mode	:Tx	Antenna Pol.	:Vertical
EUT Pol	:E2 Plane	Engineer	:Temo Chen

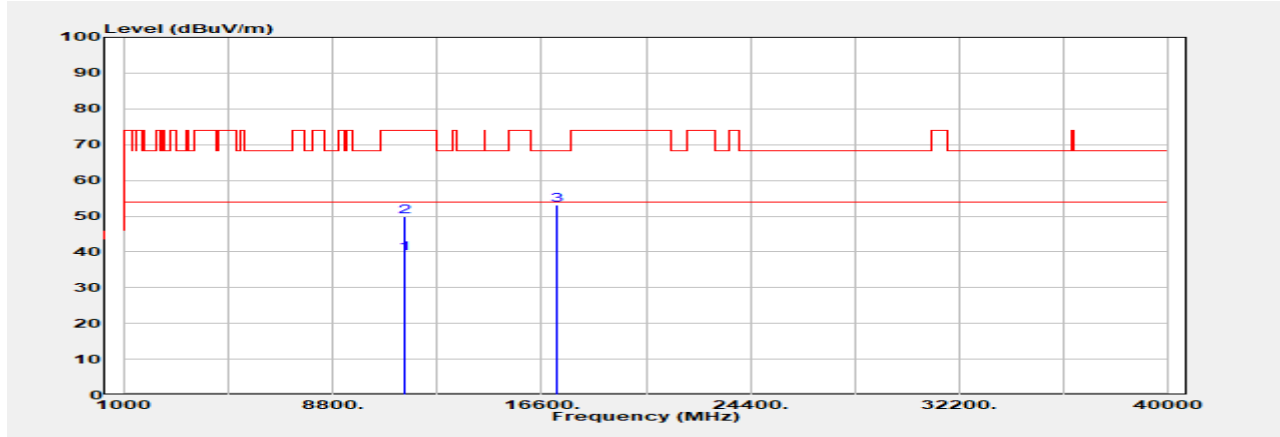

Freq. MHz	Detector Mode PK/QP/AVG	Spectrum Reading Level dB μ V	Factor dB	Actual FS dB μ V/m	Limit @3m dB μ V/m	Margin dB
11440.000	Average	28.17	11.53	39.70	54.00	-14.30
11440.000	Peak	38.45	11.53	49.98	74.00	-24.02
17160.000	Peak	40.75	12.24	53.00	68.20	-15.20

Unless otherwise stated the results shown in this test report refer only to the sample(s) tested and such sample(s) are retained for 90 days only.

除非另有說明，此報告結果僅對測試之樣品負責，同時此樣品僅保留90天。本報告未經本公司書面許可，不可部份複製。

This document is issued by the Company subject to its General Conditions of Service printed overleaf, available on request or accessible at <http://www.sgs.com.tw/Terms-and-Conditions> and for electronic format documents, subject to Terms and Conditions for Electronic Documents at <http://www.sgs.com.tw/Terms-and-Conditions>. Attention is drawn to the limitation of liability, indemnification and jurisdiction issues defined therein. Any holder of this document is advised that information contained hereon reflects the Company's findings at the time of its intervention only and within the limits of Client's instructions, if any. The Company's sole responsibility is to its Client and this document does not exonerate parties to a transaction from exercising all their rights and obligations under the transaction documents. This document cannot be reproduced except in full, without prior written approval of the Company. Any unauthorized alteration, forgery or falsification of the content or appearance of this document is unlawful and offenders may be prosecuted to the fullest extent of the law.

Report Number :TERF2403000759E2	Test Site :SAC G Chamber
Operation Mode :802.11ac20	Test Date :2024-03-29
Test Frequency :5720 MHz	Temp./Humi. :24.3°C/58%
Test Mode :Tx	Antenna Pol. :Horizontal
EUT Pol :E2 Plane	Engineer :Temo Chen

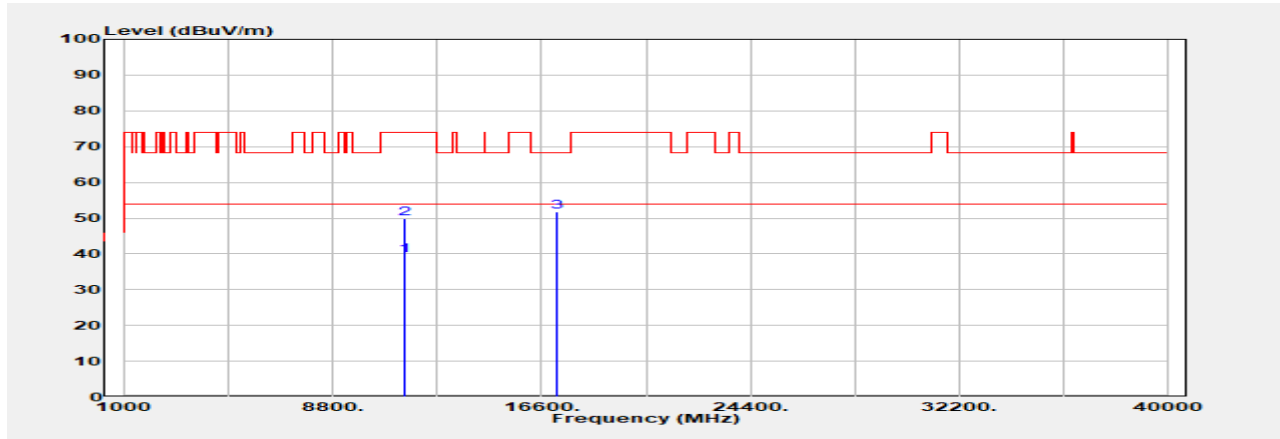

Freq. MHz	Detector Mode PK/QP/AVG	Spectrum Reading Level dBμV	Factor dB	Actual FS dBμV/m	Limit @3m dBμV/m	Margin dB
11440.000	Average	28.12	11.53	39.65	54.00	-14.35
11440.000	Peak	38.38	11.53	49.90	74.00	-24.10
17160.000	Peak	39.45	12.24	51.69	68.20	-16.51

Unless otherwise stated the results shown in this test report refer only to the sample(s) tested and such sample(s) are retained for 90 days only.

除非另有說明，此報告結果僅對測試之樣品負責，同時此樣品僅保留90天。本報告未經本公司書面許可，不可部份複製。

This document is issued by the Company subject to its General Conditions of Service printed overleaf, available on request or accessible at <http://www.sgs.com.tw/Terms-and-Conditions> and for electronic format documents, subject to Terms and Conditions for Electronic Documents at <http://www.sgs.com.tw/Terms-and-Conditions>. Attention is drawn to the limitation of liability, indemnification and jurisdiction issues defined therein. Any holder of this document is advised that information contained hereon reflects the Company's findings at the time of its intervention only and within the limits of Client's instructions, if any. The Company's sole responsibility is to its Client and this document does not exonerate parties to a transaction from exercising all their rights and obligations under the transaction documents. This document cannot be reproduced except in full, without prior written approval of the Company. Any unauthorized alteration, forgery or falsification of the content or appearance of this document is unlawful and offenders may be prosecuted to the fullest extent of the law.

Report Number :TERF2403000759E2

Test Site :SAC G Chamber

Operation Mode :802.11ac20

Test Date :2024-03-29

Test Frequency :5745 MHz

Temp./Humi. :24.3°C/58%

Test Mode :Tx

Antenna Pol. :Vertical

EUT Pol :E2 Plane

Engineer :Temo Chen

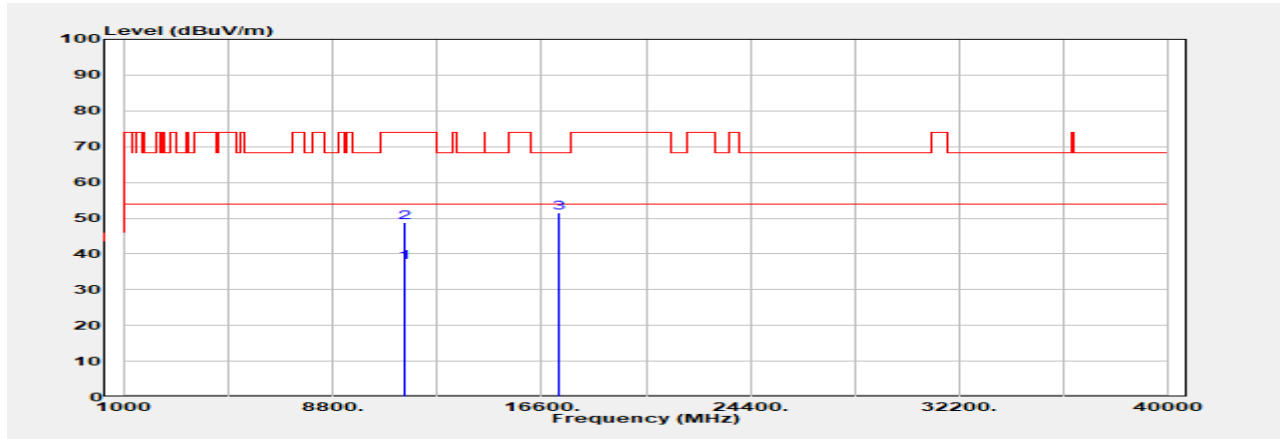

Freq. MHz	Detector Mode PK/QP/AVG	Spectrum Reading Level dB μ V	Factor dB	Actual FS dB μ V/m	Limit @3m dB μ V/m	Margin dB
11490.000	Average	27.19	10.54	37.72	54.00	-16.28
11490.000	Peak	38.27	10.54	48.81	74.00	-25.19
17235.000	Peak	39.04	12.49	51.53	68.20	-16.67

Unless otherwise stated the results shown in this test report refer only to the sample(s) tested and such sample(s) are retained for 90 days only.

除非另有說明，此報告結果僅對測試之樣品負責，同時此樣品僅保留90天。本報告未經本公司書面許可，不可部份複製。

This document is issued by the Company subject to its General Conditions of Service printed overleaf, available on request or accessible at <http://www.sgs.com.tw/Terms-and-Conditions> and for electronic format documents, subject to Terms and Conditions for Electronic Documents at <http://www.sgs.com.tw/Terms-and-Conditions>. Attention is drawn to the limitation of liability, indemnification and jurisdiction issues defined therein. Any holder of this document is advised that information contained hereon reflects the Company's findings at the time of its intervention only and within the limits of Client's instructions, if any. The Company's sole responsibility is to its Client and this document does not exonerate parties to a transaction from exercising all their rights and obligations under the transaction documents. This document cannot be reproduced except in full, without prior written approval of the Company. Any unauthorized alteration, forgery or falsification of the content or appearance of this document is unlawful and offenders may be prosecuted to the fullest extent of the law.

Report Number :TERF2403000759E2	Test Site :SAC G Chamber
Operation Mode :802.11ac20	Test Date :2024-03-29
Test Frequency :5745 MHz	Temp./Humi. :24.3°C/58%
Test Mode :Tx	Antenna Pol. :Horizontal
EUT Pol :E2 Plane	Engineer :Temo Chen

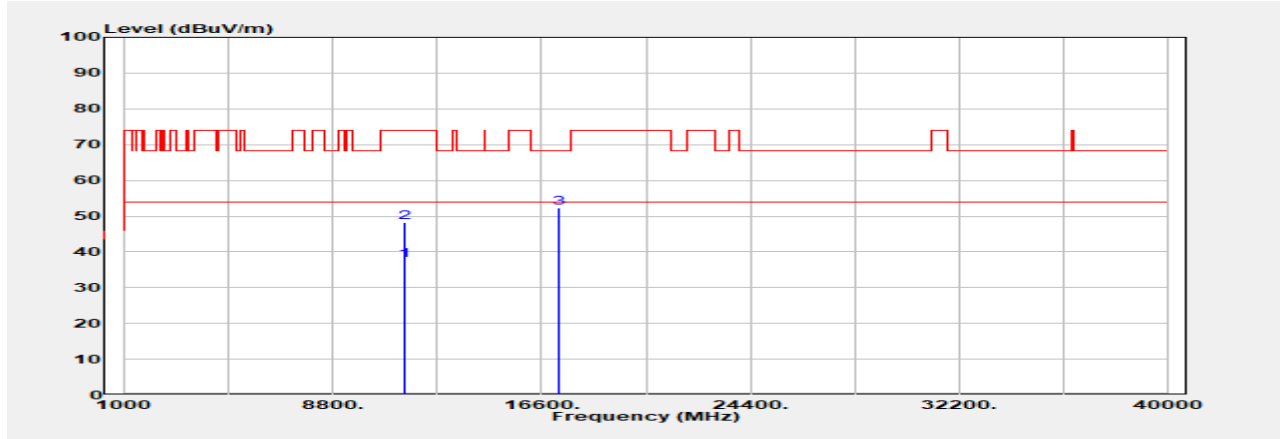

Freq. MHz	Detector Mode PK/QP/AVG	Spectrum Reading Level dB μ V	Factor dB	Actual FS dB μ V/m	Limit @3m dB μ V/m	Margin dB
11490.000	Average	27.13	10.54	37.67	54.00	-16.33
11490.000	Peak	37.62	10.54	48.16	74.00	-25.84
17235.000	Peak	39.71	12.49	52.21	68.20	-15.99

Unless otherwise stated the results shown in this test report refer only to the sample(s) tested and such sample(s) are retained for 90 days only.

除非另有說明，此報告結果僅對測試之樣品負責，同時此樣品僅保留90天。本報告未經本公司書面許可，不可部份複製。

This document is issued by the Company subject to its General Conditions of Service printed overleaf, available on request or accessible at <http://www.sgs.com.tw/Terms-and-Conditions> and for electronic format documents, subject to Terms and Conditions for Electronic Documents at <http://www.sgs.com.tw/Terms-and-Conditions>. Attention is drawn to the limitation of liability, indemnification and jurisdiction issues defined therein. Any holder of this document is advised that information contained hereon reflects the Company's findings at the time of its intervention only and within the limits of Client's instructions, if any. The Company's sole responsibility is to its Client and this document does not exonerate parties to a transaction from exercising all their rights and obligations under the transaction documents. This document cannot be reproduced except in full, without prior written approval of the Company. Any unauthorized alteration, forgery or falsification of the content or appearance of this document is unlawful and offenders may be prosecuted to the fullest extent of the law.

Report Number :TERF2403000759E2	Test Site :SAC G Chamber
Operation Mode :802.11ac20	Test Date :2024-03-29
Test Frequency :5785 MHz	Temp./Humi. :24.3°C/58%
Test Mode :Tx	Antenna Pol. :Vertical
EUT Pol :E2 Plane	Engineer :Temo Chen



Freq. MHz	Detector Mode PK/QP/AVG	Spectrum Reading Level dBμV	Factor dB	Actual FS dBμV/m	Limit @3m dBμV/m	Margin dB
11570.000	Average	27.99	10.42	38.40	54.00	-15.60
11570.000	Peak	38.50	10.42	48.92	74.00	-25.08
17355.000	Peak	39.47	12.84	52.31	68.20	-15.89

Unless otherwise stated the results shown in this test report refer only to the sample(s) tested and such sample(s) are retained for 90 days only.

除非另有說明，此報告結果僅對測試之樣品負責，同時此樣品僅保留90天。本報告未經本公司書面許可，不可部份複製。

This document is issued by the Company subject to its General Conditions of Service printed overleaf, available on request or accessible at <http://www.sgs.com.tw/Terms-and-Conditions> and for electronic format documents, subject to Terms and Conditions for Electronic Documents at <http://www.sgs.com.tw/Terms-and-Conditions>. Attention is drawn to the limitation of liability, indemnification and jurisdiction issues defined therein. Any holder of this document is advised that information contained hereon reflects the Company's findings at the time of its intervention only and within the limits of Client's instructions, if any. The Company's sole responsibility is to its Client and this document does not exonerate parties to a transaction from exercising all their rights and obligations under the transaction documents. This document cannot be reproduced except in full, without prior written approval of the Company. Any unauthorized alteration, forgery or falsification of the content or appearance of this document is unlawful and offenders may be prosecuted to the fullest extent of the law.

Report Number :TERF2403000759E2

Test Site :SAC G Chamber

Operation Mode :802.11ac20

Test Date :2024-03-29

Test Frequency :5785 MHz

Temp./Humi. :24.3°C/58%

Test Mode :Tx

Antenna Pol. :Horizontal

EUT Pol :E2 Plane

Engineer :Temo Chen

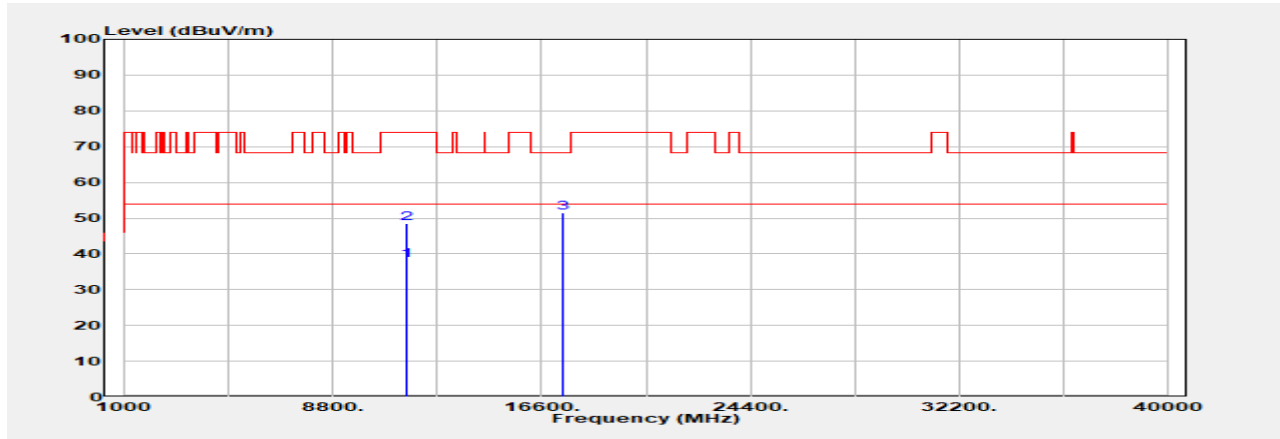

Freq. MHz	Detector Mode PK/QP/AVG	Spectrum Reading Level dBμV	Factor dB	Actual FS dBμV/m	Limit @3m dBμV/m	Margin dB
11570.000	Average	27.91	10.42	38.33	54.00	-15.67
11570.000	Peak	37.99	10.42	48.41	74.00	-25.59
17355.000	Peak	38.73	12.84	51.57	68.20	-16.63

Unless otherwise stated the results shown in this test report refer only to the sample(s) tested and such sample(s) are retained for 90 days only.

除非另有說明，此報告結果僅對測試之樣品負責，同時此樣品僅保留90天。本報告未經本公司書面許可，不可部份複製。

This document is issued by the Company subject to its General Conditions of Service printed overleaf, available on request or accessible at <http://www.sgs.com.tw/Terms-and-Conditions> and for electronic format documents, subject to Terms and Conditions for Electronic Documents at <http://www.sgs.com.tw/Terms-and-Conditions>. Attention is drawn to the limitation of liability, indemnification and jurisdiction issues defined therein. Any holder of this document is advised that information contained hereon reflects the Company's findings at the time of its intervention only and within the limits of Client's instructions, if any. The Company's sole responsibility is to its Client and this document does not exonerate parties to a transaction from exercising all their rights and obligations under the transaction documents. This document cannot be reproduced except in full, without prior written approval of the Company. Any unauthorized alteration, forgery or falsification of the content or appearance of this document is unlawful and offenders may be prosecuted to the fullest extent of the law.

Report Number :TERF2403000759E2

Test Site :SAC G Chamber

Operation Mode :802.11ac20

Test Date :2024-03-29

Test Frequency :5825 MHz

Temp./Humi. :24.3°C/58%

Test Mode :Tx

Antenna Pol. :Vertical

EUT Pol :E2 Plane

Engineer :Temo Chen

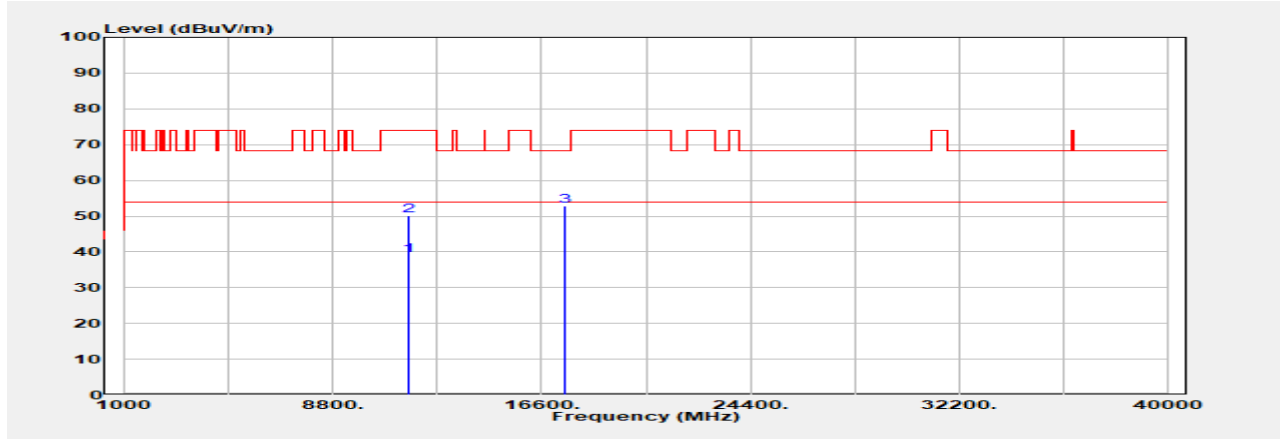

Freq. MHz	Detector Mode PK/QP/AVG	Spectrum Reading Level dBμV	Factor dB	Actual FS dBμV/m	Limit @3m dBμV/m	Margin dB
11650.000	Average	28.28	10.84	39.12	54.00	-14.88
11650.000	Peak	39.41	10.84	50.25	74.00	-23.75
17475.000	Peak	40.03	12.69	52.72	68.20	-15.48

Unless otherwise stated the results shown in this test report refer only to the sample(s) tested and such sample(s) are retained for 90 days only.

除非另有說明，此報告結果僅對測試之樣品負責，同時此樣品僅保留90天。本報告未經本公司書面許可，不可部份複製。

This document is issued by the Company subject to its General Conditions of Service printed overleaf, available on request or accessible at <http://www.sgs.com.tw/Terms-and-Conditions> and for electronic format documents, subject to Terms and Conditions for Electronic Documents at <http://www.sgs.com.tw/Terms-and-Conditions>. Attention is drawn to the limitation of liability, indemnification and jurisdiction issues defined therein. Any holder of this document is advised that information contained hereon reflects the Company's findings at the time of its intervention only and within the limits of Client's instructions, if any. The Company's sole responsibility is to its Client and this document does not exonerate parties to a transaction from exercising all their rights and obligations under the transaction documents. This document cannot be reproduced except in full, without prior written approval of the Company. Any unauthorized alteration, forgery or falsification of the content or appearance of this document is unlawful and offenders may be prosecuted to the fullest extent of the law.

Report Number :TERF2403000759E2	Test Site :SAC G Chamber
Operation Mode :802.11ac20	Test Date :2024-03-29
Test Frequency :5825 MHz	Temp./Humi. :24.3°C/58%
Test Mode :Tx	Antenna Pol. :Horizontal
EUT Pol :E2 Plane	Engineer :Temo Chen

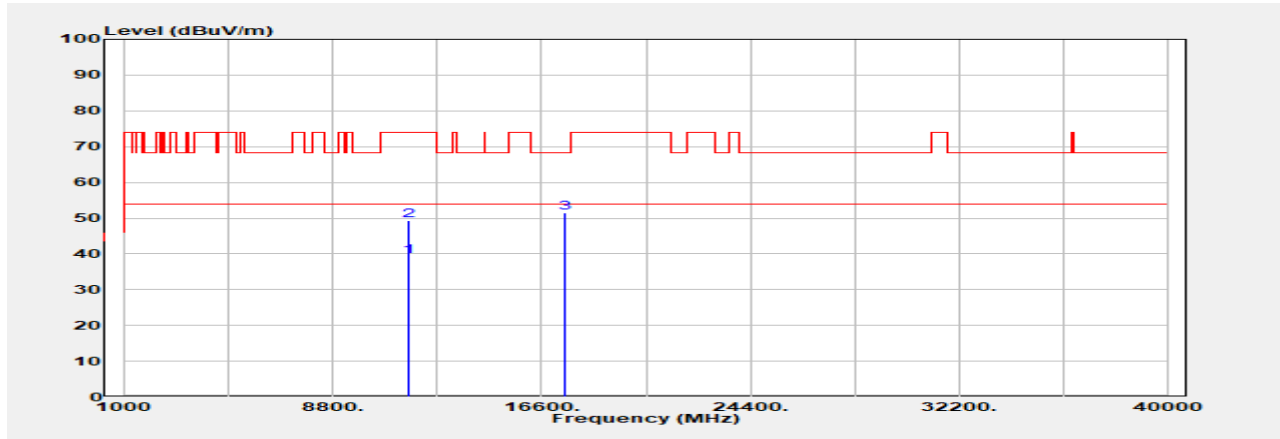

Freq. MHz	Detector Mode PK/QP/AVG	Spectrum Reading Level dBμV	Factor dB	Actual FS dBμV/m	Limit @3m dBμV/m	Margin dB
11650.000	Average	28.35	10.84	39.19	54.00	-14.81
11650.000	Peak	38.59	10.84	49.43	74.00	-24.57
17475.000	Peak	38.78	12.69	51.47	68.20	-16.73

Unless otherwise stated the results shown in this test report refer only to the sample(s) tested and such sample(s) are retained for 90 days only.

除非另有說明，此報告結果僅對測試之樣品負責，同時此樣品僅保留90天。本報告未經本公司書面許可，不可部份複製。

This document is issued by the Company subject to its General Conditions of Service printed overleaf, available on request or accessible at <http://www.sgs.com.tw/Terms-and-Conditions> and for electronic format documents, subject to Terms and Conditions for Electronic Documents at <http://www.sgs.com.tw/Terms-and-Conditions>. Attention is drawn to the limitation of liability, indemnification and jurisdiction issues defined therein. Any holder of this document is advised that information contained hereon reflects the Company's findings at the time of its intervention only and within the limits of Client's instructions, if any. The Company's sole responsibility is to its Client and this document does not exonerate parties to a transaction from exercising all their rights and obligations under the transaction documents. This document cannot be reproduced except in full, without prior written approval of the Company. Any unauthorized alteration, forgery or falsification of the content or appearance of this document is unlawful and offenders may be prosecuted to the fullest extent of the law.

Report Number :TERF2403000759E2
 Operation Mode :802.11ac40
 Test Frequency :5190 MHz
 Test Mode :Tx
 EUT Pol :E2 Plane

Test Site :SAC G Chamber
 Test Date :2024-03-29
 Temp./Humi. :24.3°C/58%
 Antenna Pol. :Vertical
 Engineer :Temo Chen

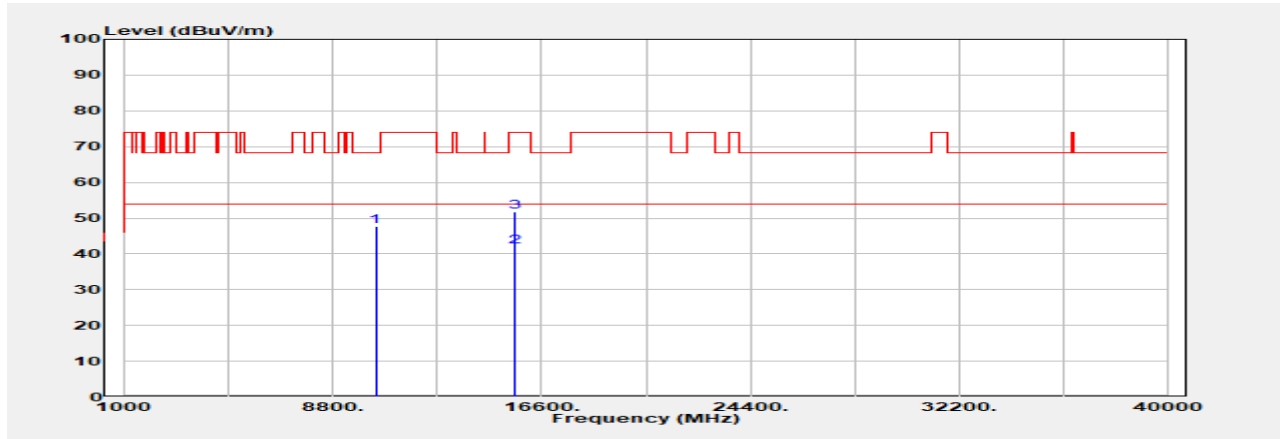

Freq. MHz	Detector Mode PK/QP/AVG	Spectrum Reading Level dB μ V	Factor dB	Actual FS dB μ V/m	Limit @3m dB μ V/m	Margin dB
10380.000	Peak	37.66	10.09	47.76	68.20	-20.44
15570.000	Average	29.74	12.39	42.13	54.00	-11.87
15570.000	Peak	39.26	12.39	51.66	74.00	-22.34

Unless otherwise stated the results shown in this test report refer only to the sample(s) tested and such sample(s) are retained for 90 days only.

除非另有說明，此報告結果僅對測試之樣品負責，同時此樣品僅保留90天。本報告未經本公司書面許可，不可部份複製。

This document is issued by the Company subject to its General Conditions of Service printed overleaf, available on request or accessible at <http://www.sgs.com.tw/Terms-and-Conditions> and for electronic format documents, subject to Terms and Conditions for Electronic Documents at <http://www.sgs.com.tw/Terms-and-Conditions>. Attention is drawn to the limitation of liability, indemnification and jurisdiction issues defined therein. Any holder of this document is advised that information contained hereon reflects the Company's findings at the time of its intervention only and within the limits of Client's instructions, if any. The Company's sole responsibility is to its Client and this document does not exonerate parties to a transaction from exercising all their rights and obligations under the transaction documents. This document cannot be reproduced except in full, without prior written approval of the Company. Any unauthorized alteration, forgery or falsification of the content or appearance of this document is unlawful and offenders may be prosecuted to the fullest extent of the law.

Report Number :TERF2403000759E2
 Operation Mode :802.11ac40
 Test Frequency :5190 MHz
 Test Mode :Tx
 EUT Pol :E2 Plane

Test Site :SAC G Chamber
 Test Date :2024-03-29
 Temp./Humi. :24.3°C/58%
 Antenna Pol. :Horizontal
 Engineer :Temo Chen

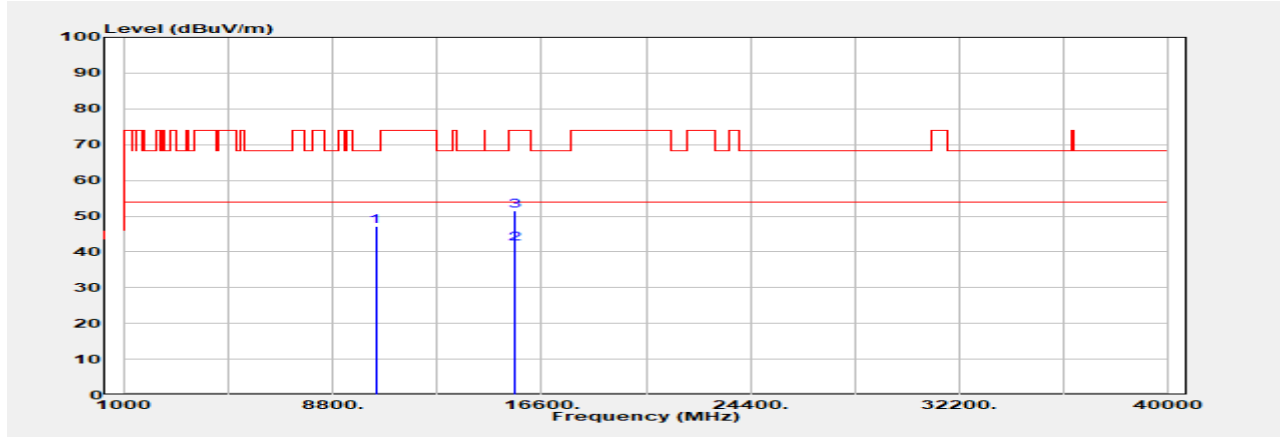

Freq. MHz	Detector Mode PK/QP/AVG	Spectrum Reading Level dB μ V	Factor dB	Actual FS dB μ V/m	Limit @3m dB μ V/m	Margin dB
10380.000	Peak	36.96	10.09	47.05	68.20	-21.15
15570.000	Average	29.86	12.39	42.25	54.00	-11.75
15570.000	Peak	39.02	12.39	51.42	74.00	-22.58

Unless otherwise stated the results shown in this test report refer only to the sample(s) tested and such sample(s) are retained for 90 days only.

除非另有說明，此報告結果僅對測試之樣品負責，同時此樣品僅保留90天。本報告未經本公司書面許可，不可部份複製。

This document is issued by the Company subject to its General Conditions of Service printed overleaf, available on request or accessible at <http://www.sgs.com.tw/Terms-and-Conditions> and for electronic format documents, subject to Terms and Conditions for Electronic Documents at <http://www.sgs.com.tw/Terms-and-Conditions>. Attention is drawn to the limitation of liability, indemnification and jurisdiction issues defined therein. Any holder of this document is advised that information contained hereon reflects the Company's findings at the time of its intervention only and within the limits of Client's instructions, if any. The Company's sole responsibility is to its Client and this document does not exonerate parties to a transaction from exercising all their rights and obligations under the transaction documents. This document cannot be reproduced except in full, without prior written approval of the Company. Any unauthorized alteration, forgery or falsification of the content or appearance of this document is unlawful and offenders may be prosecuted to the fullest extent of the law.

Report Number :TERF2403000759E2
 Operation Mode :802.11ac40
 Test Frequency :5230 MHz
 Test Mode :Tx
 EUT Pol :E2 Plane

Test Site :SAC G Chamber
 Test Date :2024-03-29
 Temp./Humi. :24.3°C/58%
 Antenna Pol. :Vertical
 Engineer :Temo Chen

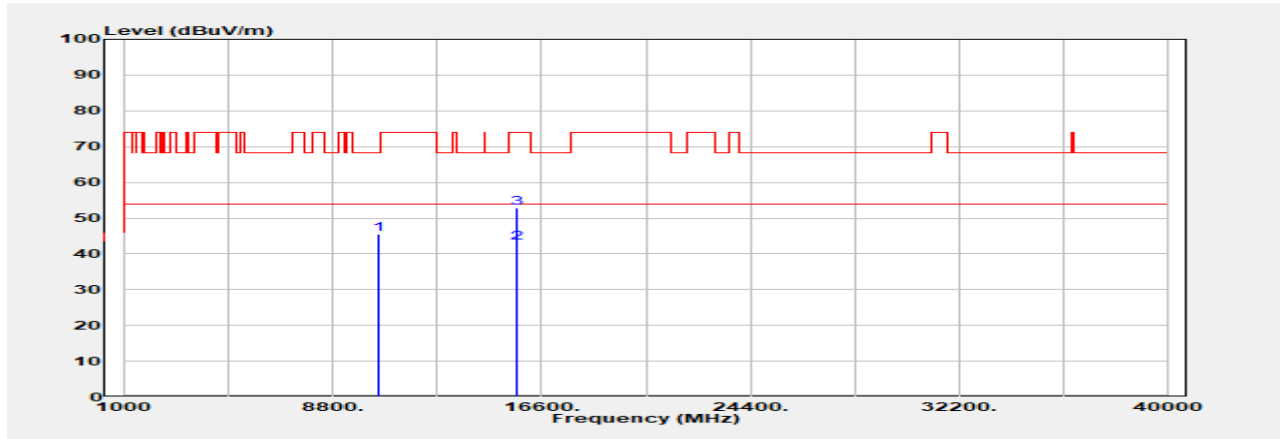

Freq. MHz	Detector Mode PK/QP/AVG	Spectrum Reading Level dB μ V	Factor dB	Actual FS dB μ V/m	Limit @3m dB μ V/m	Margin dB
10460.000	Peak	35.71	9.76	45.46	68.20	-22.74
15690.000	Average	29.31	13.67	42.98	54.00	-11.02
15690.000	Peak	39.08	13.67	52.75	74.00	-21.25

Unless otherwise stated the results shown in this test report refer only to the sample(s) tested and such sample(s) are retained for 90 days only.

除非另有說明，此報告結果僅對測試之樣品負責，同時此樣品僅保留90天。本報告未經本公司書面許可，不可部份複製。

This document is issued by the Company subject to its General Conditions of Service printed overleaf, available on request or accessible at <http://www.sgs.com.tw/Terms-and-Conditions> and for electronic format documents, subject to Terms and Conditions for Electronic Documents at <http://www.sgs.com.tw/Terms-and-Conditions>. Attention is drawn to the limitation of liability, indemnification and jurisdiction issues defined therein. Any holder of this document is advised that information contained hereon reflects the Company's findings at the time of its intervention only and within the limits of Client's instructions, if any. The Company's sole responsibility is to its Client and this document does not exonerate parties to a transaction from exercising all their rights and obligations under the transaction documents. This document cannot be reproduced except in full, without prior written approval of the Company. Any unauthorized alteration, forgery or falsification of the content or appearance of this document is unlawful and offenders may be prosecuted to the fullest extent of the law.

Report Number :TERF2403000759E2
 Operation Mode :802.11ac40
 Test Frequency :5230 MHz
 Test Mode :Tx
 EUT Pol :E2 Plane

Test Site :SAC G Chamber
 Test Date :2024-03-29
 Temp./Humi. :24.3°C/58%
 Antenna Pol. :Horizontal
 Engineer :Temo Chen

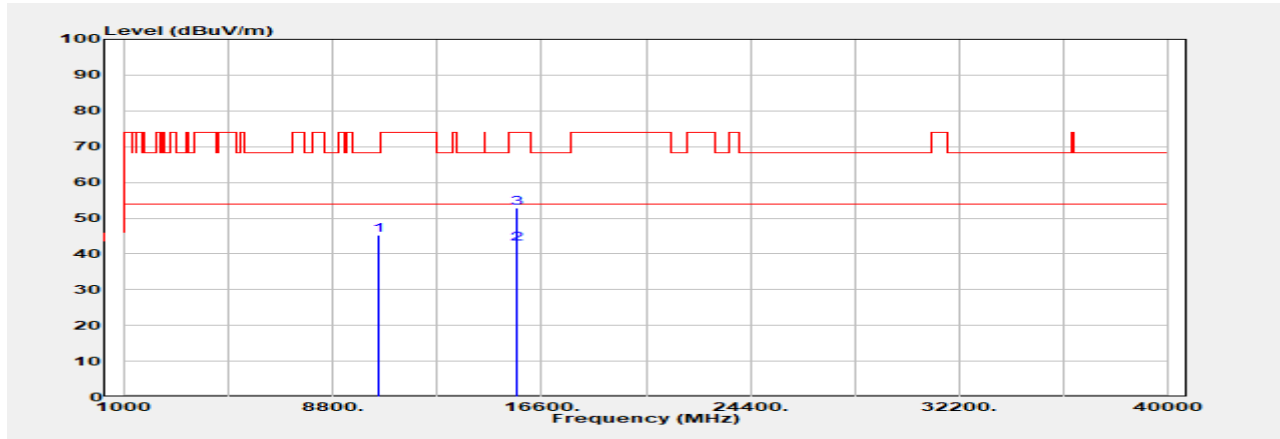

Freq. MHz	Detector Mode PK/QP/AVG	Spectrum Reading Level dBμV	Factor dB	Actual FS dBμV/m	Limit @3m dBμV/m	Margin dB
10460.000	Peak	35.51	9.76	45.27	68.20	-22.93
15690.000	Average	29.14	13.67	42.81	54.00	-11.19
15690.000	Peak	39.24	13.67	52.91	74.00	-21.09

Unless otherwise stated the results shown in this test report refer only to the sample(s) tested and such sample(s) are retained for 90 days only.

除非另有說明，此報告結果僅對測試之樣品負責，同時此樣品僅保留90天。本報告未經本公司書面許可，不可部份複製。

This document is issued by the Company subject to its General Conditions of Service printed overleaf, available on request or accessible at <http://www.sgs.com.tw/Terms-and-Conditions> and for electronic format documents, subject to Terms and Conditions for Electronic Documents at <http://www.sgs.com.tw/Terms-and-Conditions>. Attention is drawn to the limitation of liability, indemnification and jurisdiction issues defined therein. Any holder of this document is advised that information contained hereon reflects the Company's findings at the time of its intervention only and within the limits of Client's instructions, if any. The Company's sole responsibility is to its Client and this document does not exonerate parties to a transaction from exercising all their rights and obligations under the transaction documents. This document cannot be reproduced except in full, without prior written approval of the Company. Any unauthorized alteration, forgery or falsification of the content or appearance of this document is unlawful and offenders may be prosecuted to the fullest extent of the law.

Report Number :TERF2403000759E2
 Operation Mode :802.11ac40
 Test Frequency :5270 MHz
 Test Mode :Tx
 EUT Pol :E2 Plane

Test Site :SAC G Chamber
 Test Date :2024-03-29
 Temp./Humi. :24.3°C/58%
 Antenna Pol. :Vertical
 Engineer :Temo Chen

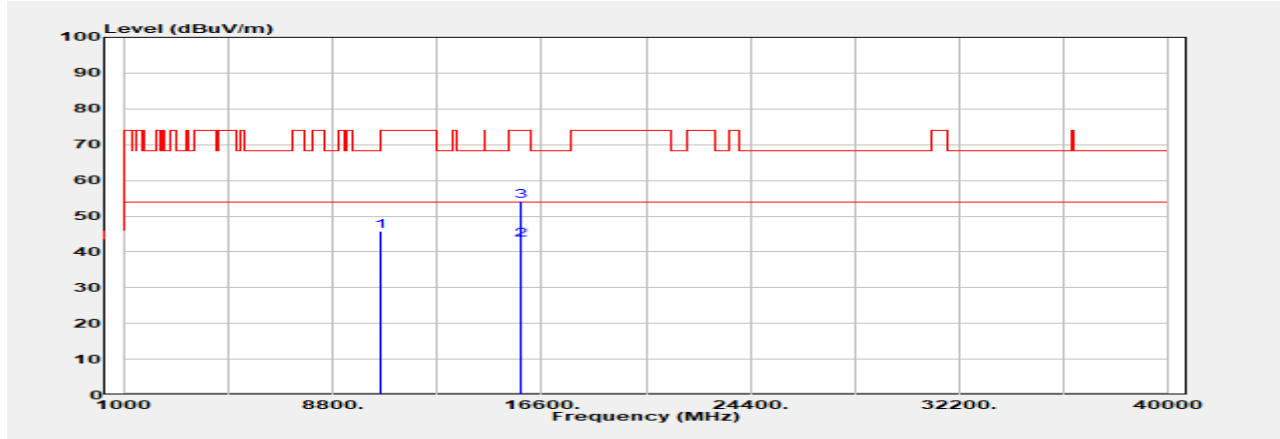

Freq. MHz	Detector Mode PK/QP/AVG	Spectrum Reading Level dBμV	Factor dB	Actual FS dBμV/m	Limit @3m dBμV/m	Margin dB
10540.000	Peak	36.13	9.63	45.76	68.20	-22.44
15810.000	Average	30.34	13.05	43.39	54.00	-10.61
15810.000	Peak	41.16	13.05	54.21	74.00	-19.79

Unless otherwise stated the results shown in this test report refer only to the sample(s) tested and such sample(s) are retained for 90 days only.

除非另有說明，此報告結果僅對測試之樣品負責，同時此樣品僅保留90天。本報告未經本公司書面許可，不可部份複製。

This document is issued by the Company subject to its General Conditions of Service printed overleaf, available on request or accessible at <http://www.sgs.com.tw/Terms-and-Conditions> and for electronic format documents, subject to Terms and Conditions for Electronic Documents at <http://www.sgs.com.tw/Terms-and-Conditions>. Attention is drawn to the limitation of liability, indemnification and jurisdiction issues defined therein. Any holder of this document is advised that information contained hereon reflects the Company's findings at the time of its intervention only and within the limits of Client's instructions, if any. The Company's sole responsibility is to its Client and this document does not exonerate parties to a transaction from exercising all their rights and obligations under the transaction documents. This document cannot be reproduced except in full, without prior written approval of the Company. Any unauthorized alteration, forgery or falsification of the content or appearance of this document is unlawful and offenders may be prosecuted to the fullest extent of the law.

Report Number :TERF2403000759E2
 Operation Mode :802.11ac40
 Test Frequency :5270 MHz
 Test Mode :Tx
 EUT Pol :E2 Plane

Test Site :SAC G Chamber
 Test Date :2024-03-29
 Temp./Humi. :24.3°C/58%
 Antenna Pol. :Horizontal
 Engineer :Temo Chen

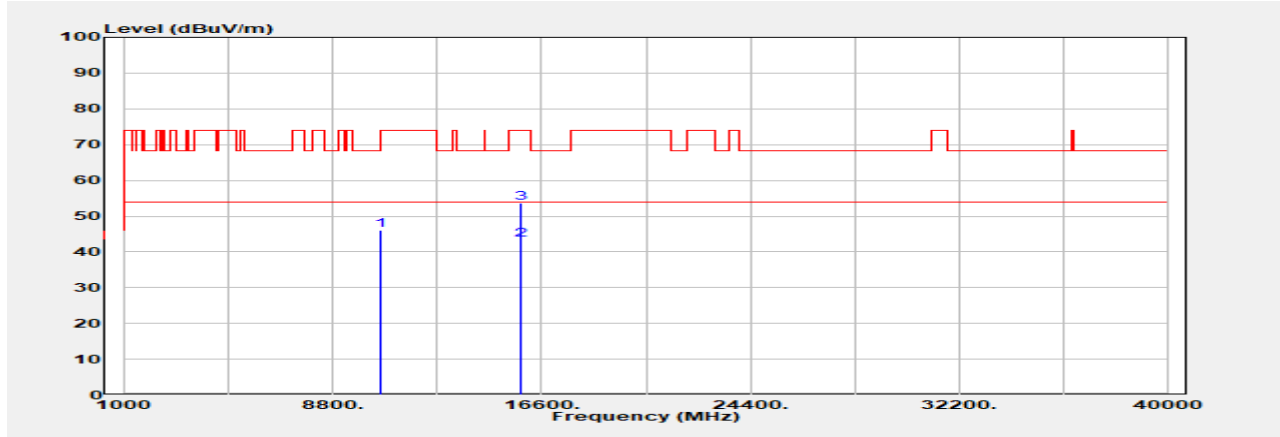

Freq. MHz	Detector Mode PK/QP/AVG	Spectrum Reading Level dB μ V	Factor dB	Actual FS dB μ V/m	Limit @3m dB μ V/m	Margin dB
10540.000	Peak	36.38	9.63	46.01	68.20	-22.19
15810.000	Average	30.31	13.05	43.36	54.00	-10.64
15810.000	Peak	40.57	13.05	53.62	74.00	-20.38

Unless otherwise stated the results shown in this test report refer only to the sample(s) tested and such sample(s) are retained for 90 days only.

除非另有說明，此報告結果僅對測試之樣品負責，同時此樣品僅保留90天。本報告未經本公司書面許可，不可部份複製。

This document is issued by the Company subject to its General Conditions of Service printed overleaf, available on request or accessible at <http://www.sgs.com.tw/Terms-and-Conditions> and for electronic format documents, subject to Terms and Conditions for Electronic Documents at <http://www.sgs.com.tw/Terms-and-Conditions>. Attention is drawn to the limitation of liability, indemnification and jurisdiction issues defined therein. Any holder of this document is advised that information contained hereon reflects the Company's findings at the time of its intervention only and within the limits of Client's instructions, if any. The Company's sole responsibility is to its Client and this document does not exonerate parties to a transaction from exercising all their rights and obligations under the transaction documents. This document cannot be reproduced except in full, without prior written approval of the Company. Any unauthorized alteration, forgery or falsification of the content or appearance of this document is unlawful and offenders may be prosecuted to the fullest extent of the law.

Report Number :TERF2403000759E2
 Operation Mode :802.11ac40
 Test Frequency :5310 MHz
 Test Mode :Tx
 EUT Pol :E2 Plane

Test Site :SAC G Chamber
 Test Date :2024-03-29
 Temp./Humi. :24.3°C/58%
 Antenna Pol. :Vertical
 Engineer :Temo Chen

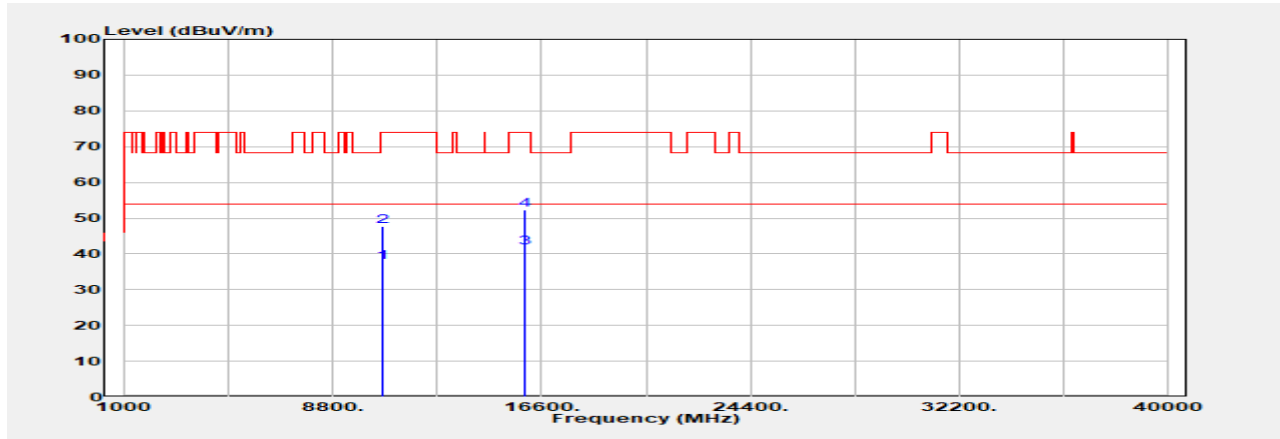

Freq. MHz	Detector Mode PK/QP/AVG	Spectrum Reading Level dB μ V	Factor dB	Actual FS dB μ V/m	Limit @3m dB μ V/m	Margin dB
10620.000	Average	27.69	9.96	37.65	54.00	-16.35
10620.000	Peak	37.76	9.96	47.72	74.00	-26.28
15930.000	Average	28.93	12.92	41.85	54.00	-12.15
15930.000	Peak	39.49	12.92	52.42	74.00	-21.58

Unless otherwise stated the results shown in this test report refer only to the sample(s) tested and such sample(s) are retained for 90 days only.

除非另有說明，此報告結果僅對測試之樣品負責，同時此樣品僅保留90天。本報告未經本公司書面許可，不可部份複製。

This document is issued by the Company subject to its General Conditions of Service printed overleaf, available on request or accessible at <http://www.sgs.com.tw/Terms-and-Conditions> and for electronic format documents, subject to Terms and Conditions for Electronic Documents at <http://www.sgs.com.tw/Terms-and-Conditions>. Attention is drawn to the limitation of liability, indemnification and jurisdiction issues defined therein. Any holder of this document is advised that information contained hereon reflects the Company's findings at the time of its intervention only and within the limits of Client's instructions, if any. The Company's sole responsibility is to its Client and this document does not exonerate parties to a transaction from exercising all their rights and obligations under the transaction documents. This document cannot be reproduced except in full, without prior written approval of the Company. Any unauthorized alteration, forgery or falsification of the content or appearance of this document is unlawful and offenders may be prosecuted to the fullest extent of the law.

Report Number :TERF2403000759E2
 Operation Mode :802.11ac40
 Test Frequency :5310 MHz
 Test Mode :Tx
 EUT Pol :E2 Plane

Test Site :SAC G Chamber
 Test Date :2024-03-29
 Temp./Humi. :24.3°C/58%
 Antenna Pol. :Horizontal
 Engineer :Temo Chen

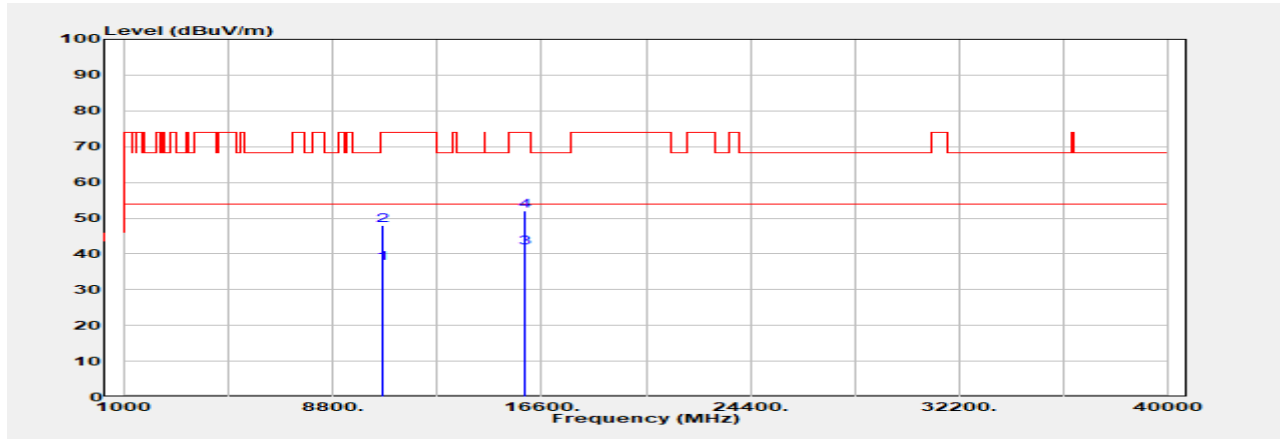

Freq. MHz	Detector Mode PK/QP/AVG	Spectrum Reading Level dBμV	Factor dB	Actual FS dBμV/m	Limit @3m dBμV/m	Margin dB
10620.000	Average	27.42	9.96	37.38	54.00	-16.62
10620.000	Peak	37.93	9.96	47.89	74.00	-26.11
15930.000	Average	28.89	12.92	41.82	54.00	-12.18
15930.000	Peak	39.13	12.92	52.05	74.00	-21.95

Unless otherwise stated the results shown in this test report refer only to the sample(s) tested and such sample(s) are retained for 90 days only.

除非另有說明，此報告結果僅對測試之樣品負責，同時此樣品僅保留90天。本報告未經本公司書面許可，不可部份複製。

This document is issued by the Company subject to its General Conditions of Service printed overleaf, available on request or accessible at <http://www.sgs.com.tw/Terms-and-Conditions> and for electronic format documents, subject to Terms and Conditions for Electronic Documents at <http://www.sgs.com.tw/Terms-and-Conditions>. Attention is drawn to the limitation of liability, indemnification and jurisdiction issues defined therein. Any holder of this document is advised that information contained hereon reflects the Company's findings at the time of its intervention only and within the limits of Client's instructions, if any. The Company's sole responsibility is to its Client and this document does not exonerate parties to a transaction from exercising all their rights and obligations under the transaction documents. This document cannot be reproduced except in full, without prior written approval of the Company. Any unauthorized alteration, forgery or falsification of the content or appearance of this document is unlawful and offenders may be prosecuted to the fullest extent of the law.

Report Number :TERF2403000759E2
 Operation Mode :802.11ac40
 Test Frequency :5510 MHz
 Test Mode :Tx
 EUT Pol :E2 Plane

Test Site :SAC G Chamber
 Test Date :2024-03-29
 Temp./Humi. :24.3°C/58%
 Antenna Pol. :Vertical
 Engineer :Temo Chen

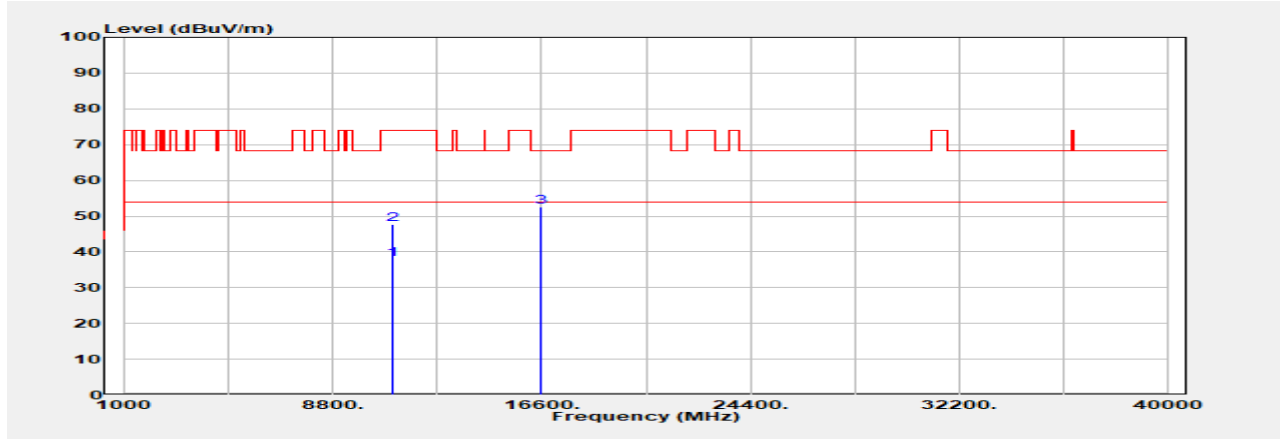

Freq. MHz	Detector Mode PK/QP/AVG	Spectrum Reading Level dB μ V	Factor dB	Actual FS dB μ V/m	Limit @3m dB μ V/m	Margin dB
11020.000	Average	27.55	10.30	37.86	54.00	-16.14
11020.000	Peak	37.42	10.30	47.73	74.00	-26.27
16530.000	Peak	39.74	12.96	52.69	68.20	-15.51

Unless otherwise stated the results shown in this test report refer only to the sample(s) tested and such sample(s) are retained for 90 days only.

除非另有說明，此報告結果僅對測試之樣品負責，同時此樣品僅保留90天。本報告未經本公司書面許可，不可部份複製。

This document is issued by the Company subject to its General Conditions of Service printed overleaf, available on request or accessible at <http://www.sgs.com.tw/Terms-and-Conditions> and for electronic format documents, subject to Terms and Conditions for Electronic Documents at <http://www.sgs.com.tw/Terms-and-Conditions>. Attention is drawn to the limitation of liability, indemnification and jurisdiction issues defined therein. Any holder of this document is advised that information contained hereon reflects the Company's findings at the time of its intervention only and within the limits of Client's instructions, if any. The Company's sole responsibility is to its Client and this document does not exonerate parties to a transaction from exercising all their rights and obligations under the transaction documents. This document cannot be reproduced except in full, without prior written approval of the Company. Any unauthorized alteration, forgery or falsification of the content or appearance of this document is unlawful and offenders may be prosecuted to the fullest extent of the law.

Report Number :TERF2403000759E2	Test Site :SAC G Chamber
Operation Mode :802.11ac40	Test Date :2024-03-29
Test Frequency :5510 MHz	Temp./Humi. :24.3°C/58%
Test Mode :Tx	Antenna Pol. :Horizontal
EUT Pol :E2 Plane	Engineer :Temo Chen

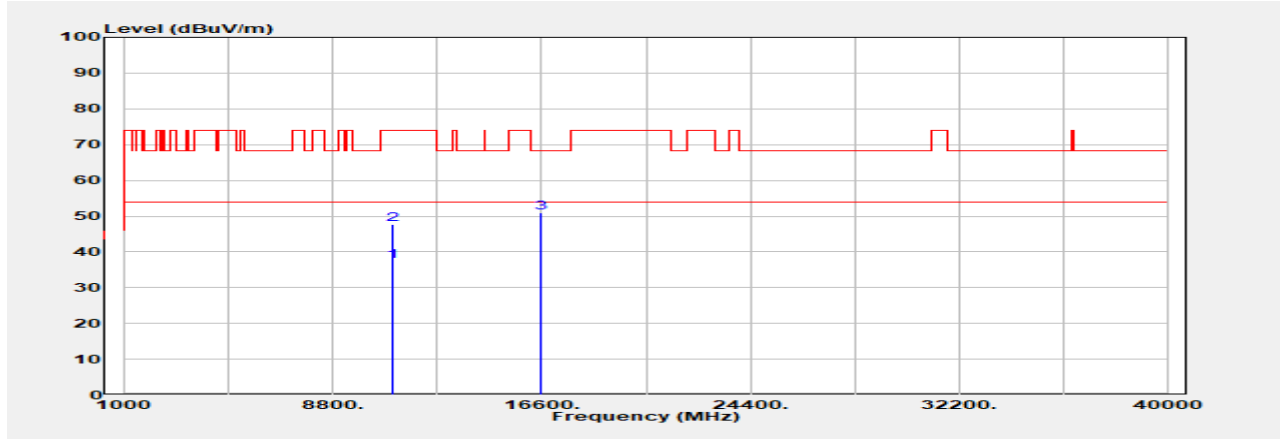

Freq. MHz	Detector Mode PK/QP/AVG	Spectrum Reading Level dBμV	Factor dB	Actual FS dBμV/m	Limit @3m dBμV/m	Margin dB
11020.000	Average	27.12	10.30	37.43	54.00	-16.57
11020.000	Peak	37.43	10.30	47.73	74.00	-26.27
16530.000	Peak	38.11	12.96	51.07	68.20	-17.13

Unless otherwise stated the results shown in this test report refer only to the sample(s) tested and such sample(s) are retained for 90 days only.

除非另有說明，此報告結果僅對測試之樣品負責，同時此樣品僅保留90天。本報告未經本公司書面許可，不可部份複製。

This document is issued by the Company subject to its General Conditions of Service printed overleaf, available on request or accessible at <http://www.sgs.com.tw/Terms-and-Conditions> and for electronic format documents, subject to Terms and Conditions for Electronic Documents at <http://www.sgs.com.tw/Terms-and-Conditions>. Attention is drawn to the limitation of liability, indemnification and jurisdiction issues defined therein. Any holder of this document is advised that information contained hereon reflects the Company's findings at the time of its intervention only and within the limits of Client's instructions, if any. The Company's sole responsibility is to its Client and this document does not exonerate parties to a transaction from exercising all their rights and obligations under the transaction documents. This document cannot be reproduced except in full, without prior written approval of the Company. Any unauthorized alteration, forgery or falsification of the content or appearance of this document is unlawful and offenders may be prosecuted to the fullest extent of the law.

Report Number :TERF2403000759E2
 Operation Mode :802.11ac40
 Test Frequency :5590 MHz
 Test Mode :Tx
 EUT Pol :E2 Plane

Test Site :SAC G Chamber
 Test Date :2024-03-29
 Temp./Humi. :24.3°C/58%
 Antenna Pol. :Vertical
 Engineer :Temo Chen

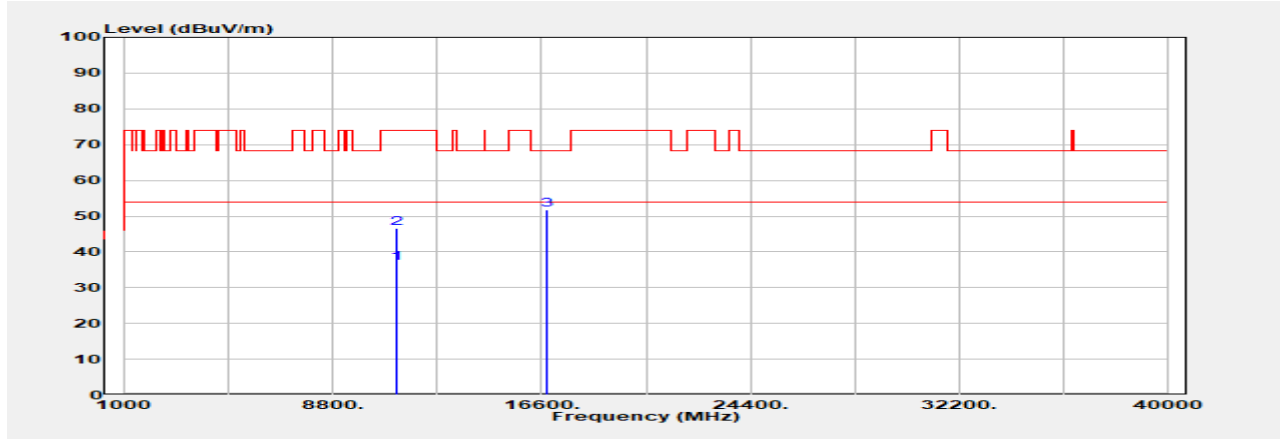

Freq. MHz	Detector Mode PK/QP/AVG	Spectrum Reading Level dBμV	Factor dB	Actual FS dBμV/m	Limit @3m dBμV/m	Margin dB
11180.000	Average	26.76	9.98	36.75	54.00	-17.25
11180.000	Peak	36.70	9.98	46.68	74.00	-27.32
16770.000	Peak	39.19	12.56	51.75	68.20	-16.45

Unless otherwise stated the results shown in this test report refer only to the sample(s) tested and such sample(s) are retained for 90 days only.

除非另有說明，此報告結果僅對測試之樣品負責，同時此樣品僅保留90天。本報告未經本公司書面許可，不可部份複製。

This document is issued by the Company subject to its General Conditions of Service printed overleaf, available on request or accessible at <http://www.sgs.com.tw/Terms-and-Conditions> and for electronic format documents, subject to Terms and Conditions for Electronic Documents at <http://www.sgs.com.tw/Terms-and-Conditions>. Attention is drawn to the limitation of liability, indemnification and jurisdiction issues defined therein. Any holder of this document is advised that information contained hereon reflects the Company's findings at the time of its intervention only and within the limits of Client's instructions, if any. The Company's sole responsibility is to its Client and this document does not exonerate parties to a transaction from exercising all their rights and obligations under the transaction documents. This document cannot be reproduced except in full, without prior written approval of the Company. Any unauthorized alteration, forgery or falsification of the content or appearance of this document is unlawful and offenders may be prosecuted to the fullest extent of the law.

Report Number :TERF2403000759E2
 Operation Mode :802.11ac40
 Test Frequency :5590 MHz
 Test Mode :Tx
 EUT Pol :E2 Plane

Test Site :SAC G Chamber
 Test Date :2024-03-29
 Temp./Humi. :24.3°C/58%
 Antenna Pol. :Horizontal
 Engineer :Temo Chen

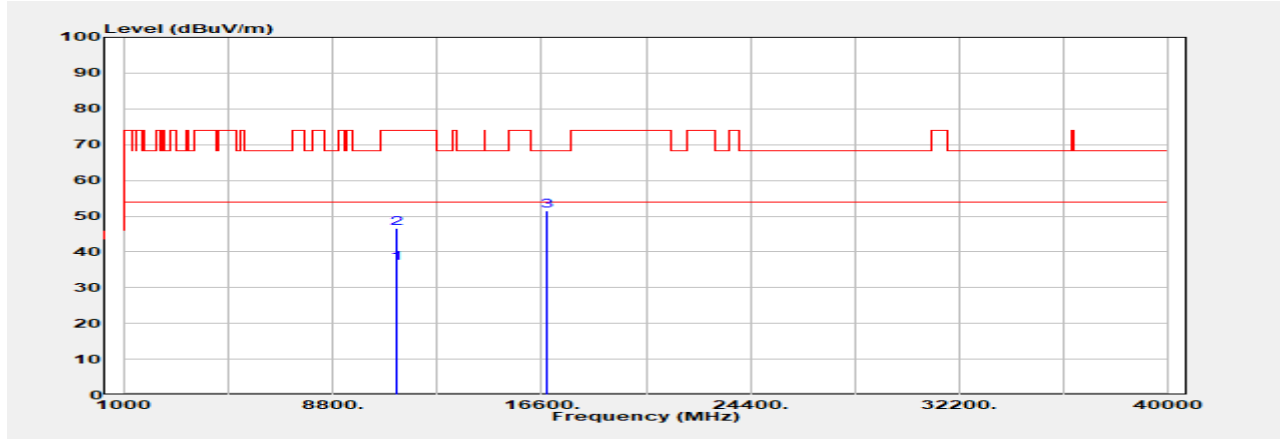

Freq. MHz	Detector Mode PK/QP/AVG	Spectrum Reading Level dB μ V	Factor dB	Actual FS dB μ V/m	Limit @3m dB μ V/m	Margin dB
11180.000	Average	26.92	9.98	36.90	54.00	-17.10
11180.000	Peak	36.67	9.98	46.65	74.00	-27.35
16770.000	Peak	39.00	12.56	51.56	68.20	-16.64

Unless otherwise stated the results shown in this test report refer only to the sample(s) tested and such sample(s) are retained for 90 days only.

除非另有說明，此報告結果僅對測試之樣品負責，同時此樣品僅保留90天。本報告未經本公司書面許可，不可部份複製。

This document is issued by the Company subject to its General Conditions of Service printed overleaf, available on request or accessible at <http://www.sgs.com.tw/Terms-and-Conditions> and for electronic format documents, subject to Terms and Conditions for Electronic Documents at <http://www.sgs.com.tw/Terms-and-Conditions>. Attention is drawn to the limitation of liability, indemnification and jurisdiction issues defined therein. Any holder of this document is advised that information contained hereon reflects the Company's findings at the time of its intervention only and within the limits of Client's instructions, if any. The Company's sole responsibility is to its Client and this document does not exonerate parties to a transaction from exercising all their rights and obligations under the transaction documents. This document cannot be reproduced except in full, without prior written approval of the Company. Any unauthorized alteration, forgery or falsification of the content or appearance of this document is unlawful and offenders may be prosecuted to the fullest extent of the law.

Report Number :TERF2403000759E2

Test Site :SAC G Chamber

Operation Mode :802.11ac40

Test Date :2024-03-29

Test Frequency :5670 MHz

Temp./Humi. :24.3°C/58%

Test Mode :Tx

Antenna Pol. :Vertical

EUT Pol :E2 Plane

Engineer :Temo Chen

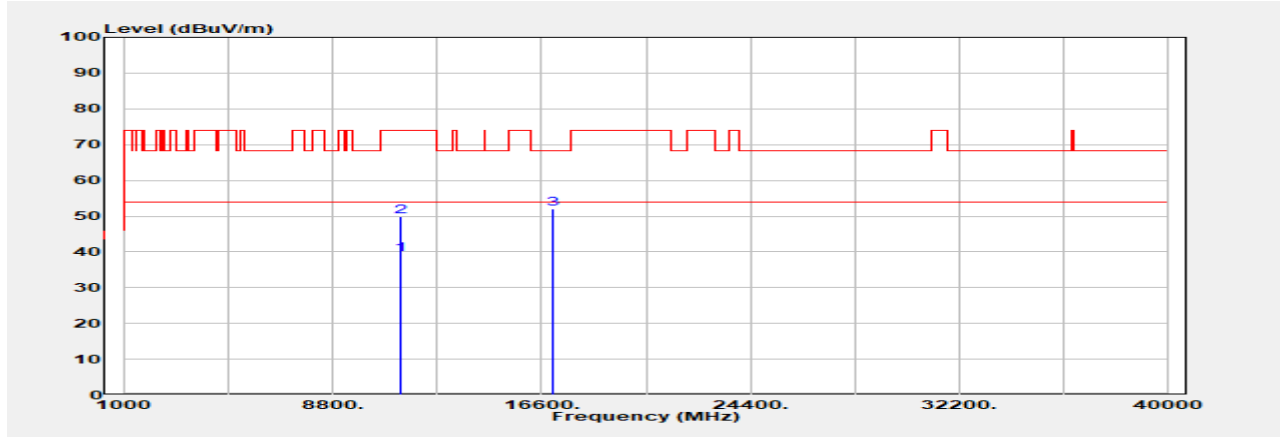

Freq. MHz	Detector Mode PK/QP/AVG	Spectrum Reading Level dB μ V	Factor dB	Actual FS dB μ V/m	Limit @3m dB μ V/m	Margin dB
11340.000	Average	28.20	11.13	39.33	54.00	-14.67
11340.000	Peak	38.69	11.13	49.83	74.00	-24.17
17010.000	Peak	38.39	13.67	52.06	68.20	-16.14

Unless otherwise stated the results shown in this test report refer only to the sample(s) tested and such sample(s) are retained for 90 days only.

除非另有說明，此報告結果僅對測試之樣品負責，同時此樣品僅保留90天。本報告未經本公司書面許可，不可部份複製。

This document is issued by the Company subject to its General Conditions of Service printed overleaf, available on request or accessible at <http://www.sgs.com.tw/Terms-and-Conditions> and for electronic format documents, subject to Terms and Conditions for Electronic Documents at <http://www.sgs.com.tw/Terms-and-Conditions>. Attention is drawn to the limitation of liability, indemnification and jurisdiction issues defined therein. Any holder of this document is advised that information contained hereon reflects the Company's findings at the time of its intervention only and within the limits of Client's instructions, if any. The Company's sole responsibility is to its Client and this document does not exonerate parties to a transaction from exercising all their rights and obligations under the transaction documents. This document cannot be reproduced except in full, without prior written approval of the Company. Any unauthorized alteration, forgery or falsification of the content or appearance of this document is unlawful and offenders may be prosecuted to the fullest extent of the law.

Report Number :TERF2403000759E2
 Operation Mode :802.11ac40
 Test Frequency :5670 MHz
 Test Mode :Tx
 EUT Pol :E2 Plane

Test Site :SAC G Chamber
 Test Date :2024-03-29
 Temp./Humi. :24.3°C/58%
 Antenna Pol. :Horizontal
 Engineer :Temo Chen

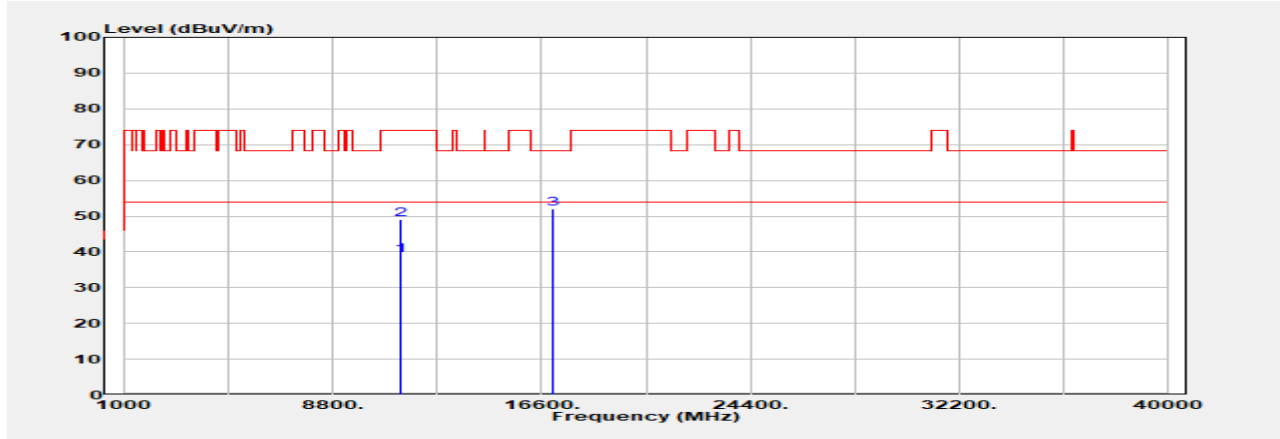

Freq. MHz	Detector Mode PK/QP/AVG	Spectrum Reading Level dB μ V	Factor dB	Actual FS dB μ V/m	Limit @3m dB μ V/m	Margin dB
11340.000	Average	27.89	11.13	39.03	54.00	-14.97
11340.000	Peak	37.85	11.13	48.98	74.00	-25.02
17010.000	Peak	38.35	13.67	52.02	68.20	-16.18

Unless otherwise stated the results shown in this test report refer only to the sample(s) tested and such sample(s) are retained for 90 days only.

除非另有說明，此報告結果僅對測試之樣品負責，同時此樣品僅保留90天。本報告未經本公司書面許可，不可部份複製。

This document is issued by the Company subject to its General Conditions of Service printed overleaf, available on request or accessible at <http://www.sgs.com.tw/Terms-and-Conditions> and for electronic format documents, subject to Terms and Conditions for Electronic Documents at <http://www.sgs.com.tw/Terms-and-Conditions>. Attention is drawn to the limitation of liability, indemnification and jurisdiction issues defined therein. Any holder of this document is advised that information contained hereon reflects the Company's findings at the time of its intervention only and within the limits of Client's instructions, if any. The Company's sole responsibility is to its Client and this document does not exonerate parties to a transaction from exercising all their rights and obligations under the transaction documents. This document cannot be reproduced except in full, without prior written approval of the Company. Any unauthorized alteration, forgery or falsification of the content or appearance of this document is unlawful and offenders may be prosecuted to the fullest extent of the law.

Report Number :TERF2403000759E2
 Operation Mode :802.11ac40
 Test Frequency :5710 MHz
 Test Mode :Tx
 EUT Pol :E2 Plane

Test Site :SAC G Chamber
 Test Date :2024-03-29
 Temp./Humi. :24.3°C/58%
 Antenna Pol. :Vertical
 Engineer :Temo Chen

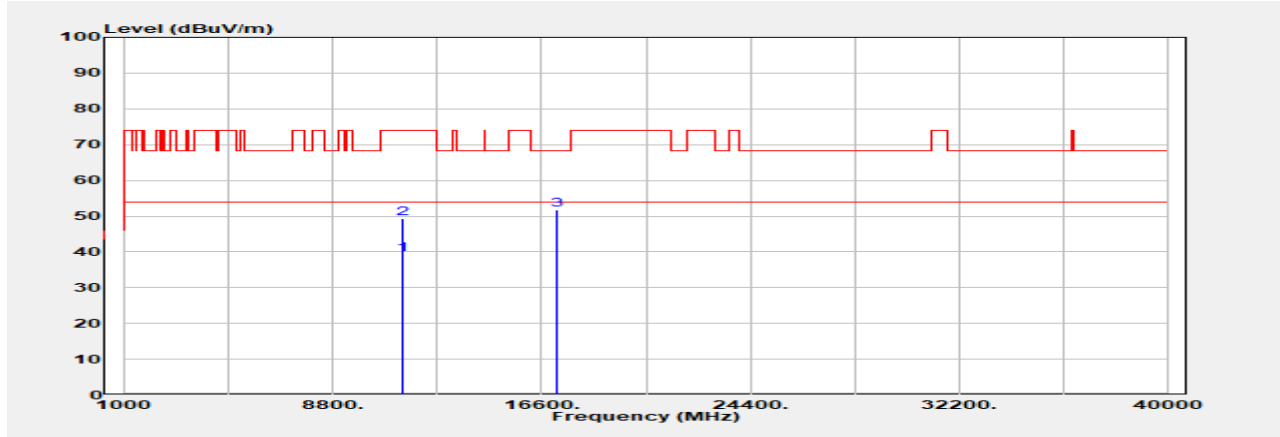

Freq. MHz	Detector Mode PK/QP/AVG	Spectrum Reading Level dB μ V	Factor dB	Actual FS dB μ V/m	Limit @3m dB μ V/m	Margin dB
11420.000	Average	27.47	11.92	39.39	54.00	-14.61
11420.000	Peak	37.29	11.92	49.22	74.00	-24.78
17130.000	Peak	39.36	12.43	51.79	68.20	-16.41

Unless otherwise stated the results shown in this test report refer only to the sample(s) tested and such sample(s) are retained for 90 days only.

除非另有說明，此報告結果僅對測試之樣品負責，同時此樣品僅保留90天。本報告未經本公司書面許可，不可部份複製。

This document is issued by the Company subject to its General Conditions of Service printed overleaf, available on request or accessible at <http://www.sgs.com.tw/Terms-and-Conditions> and for electronic format documents, subject to Terms and Conditions for Electronic Documents at <http://www.sgs.com.tw/Terms-and-Conditions>. Attention is drawn to the limitation of liability, indemnification and jurisdiction issues defined therein. Any holder of this document is advised that information contained hereon reflects the Company's findings at the time of its intervention only and within the limits of Client's instructions, if any. The Company's sole responsibility is to its Client and this document does not exonerate parties to a transaction from exercising all their rights and obligations under the transaction documents. This document cannot be reproduced except in full, without prior written approval of the Company. Any unauthorized alteration, forgery or falsification of the content or appearance of this document is unlawful and offenders may be prosecuted to the fullest extent of the law.

Report Number :TERF2403000759E2

Test Site :SAC G Chamber

Operation Mode :802.11ac40

Test Date :2024-03-29

Test Frequency :5710 MHz

Temp./Humi. :24.3°C/58%

Test Mode :Tx

Antenna Pol. :Horizontal

EUT Pol :E2 Plane

Engineer :Temo Chen

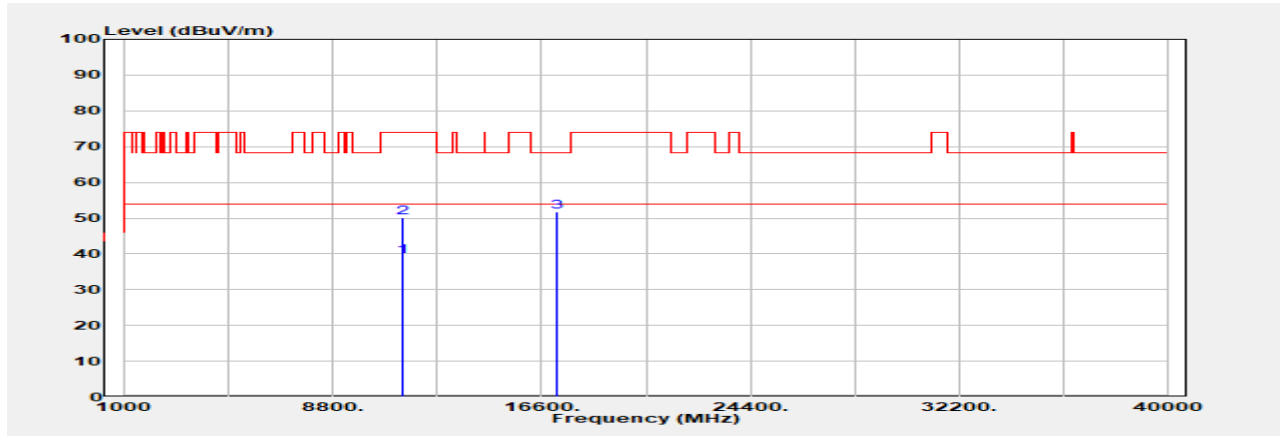

Freq. MHz	Detector Mode PK/QP/AVG	Spectrum Reading Level dBμV	Factor dB	Actual FS dBμV/m	Limit @3m dBμV/m	Margin dB
11420.000	Average	27.24	11.92	39.17	54.00	-14.83
11420.000	Peak	38.32	11.92	50.24	74.00	-23.76
17130.000	Peak	39.37	12.43	51.80	68.20	-16.40

Unless otherwise stated the results shown in this test report refer only to the sample(s) tested and such sample(s) are retained for 90 days only.

除非另有說明，此報告結果僅對測試之樣品負責，同時此樣品僅保留90天。本報告未經本公司書面許可，不可部份複製。

This document is issued by the Company subject to its General Conditions of Service printed overleaf, available on request or accessible at <http://www.sgs.com.tw/Terms-and-Conditions> and for electronic format documents, subject to Terms and Conditions for Electronic Documents at <http://www.sgs.com.tw/Terms-and-Conditions>. Attention is drawn to the limitation of liability, indemnification and jurisdiction issues defined therein. Any holder of this document is advised that information contained hereon reflects the Company's findings at the time of its intervention only and within the limits of Client's instructions, if any. The Company's sole responsibility is to its Client and this document does not exonerate parties to a transaction from exercising all their rights and obligations under the transaction documents. This document cannot be reproduced except in full, without prior written approval of the Company. Any unauthorized alteration, forgery or falsification of the content or appearance of this document is unlawful and offenders may be prosecuted to the fullest extent of the law.

Report Number :TERF2403000759E2

Test Site :SAC G Chamber

Operation Mode :802.11ac40

Test Date :2024-03-29

Test Frequency :5755 MHz

Temp./Humi. :24.3°C/58%

Test Mode :Tx

Antenna Pol. :Vertical

EUT Pol :E2 Plane

Engineer :Temo Chen



Freq. MHz	Detector Mode PK/QP/AVG	Spectrum Reading Level dBμV	Factor dB	Actual FS dBμV/m	Limit @3m dBμV/m	Margin dB
11510.000	Average	27.99	10.35	38.34	54.00	-15.66
11510.000	Peak	38.02	10.35	48.37	74.00	-25.63
17265.000	Peak	39.18	12.93	52.11	68.20	-16.09

Unless otherwise stated the results shown in this test report refer only to the sample(s) tested and such sample(s) are retained for 90 days only.

除非另有說明，此報告結果僅對測試之樣品負責，同時此樣品僅保留90天。本報告未經本公司書面許可，不可部份複製。

This document is issued by the Company subject to its General Conditions of Service printed overleaf, available on request or accessible at <http://www.sgs.com.tw/Terms-and-Conditions> and for electronic format documents, subject to Terms and Conditions for Electronic Documents at <http://www.sgs.com.tw/Terms-and-Conditions>. Attention is drawn to the limitation of liability, indemnification and jurisdiction issues defined therein. Any holder of this document is advised that information contained hereon reflects the Company's findings at the time of its intervention only and within the limits of Client's instructions, if any. The Company's sole responsibility is to its Client and this document does not exonerate parties to a transaction from exercising all their rights and obligations under the transaction documents. This document cannot be reproduced except in full, without prior written approval of the Company. Any unauthorized alteration, forgery or falsification of the content or appearance of this document is unlawful and offenders may be prosecuted to the fullest extent of the law.

Report Number :TERF2403000759E2

Test Site :SAC G Chamber

Operation Mode :802.11ac40

Test Date :2024-03-29

Test Frequency :5755 MHz

Temp./Humi. :24.3°C/58%

Test Mode :Tx

Antenna Pol. :Horizontal

EUT Pol :E2 Plane

Engineer :Temo Chen

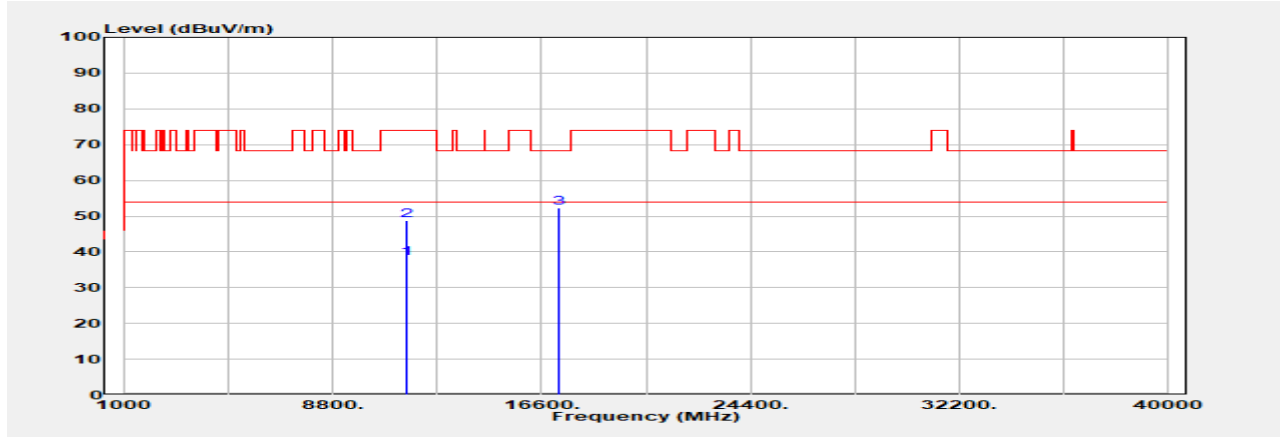

Freq. MHz	Detector Mode PK/QP/AVG	Spectrum Reading Level dB μ V	Factor dB	Actual FS dB μ V/m	Limit @3m dB μ V/m	Margin dB
11510.000	Average	27.98	10.35	38.33	54.00	-15.67
11510.000	Peak	38.38	10.35	48.73	74.00	-25.27
17265.000	Peak	39.39	12.93	52.32	68.20	-15.88

Unless otherwise stated the results shown in this test report refer only to the sample(s) tested and such sample(s) are retained for 90 days only.

除非另有說明，此報告結果僅對測試之樣品負責，同時此樣品僅保留90天。本報告未經本公司書面許可，不可部份複製。

This document is issued by the Company subject to its General Conditions of Service printed overleaf, available on request or accessible at <http://www.sgs.com.tw/Terms-and-Conditions> and for electronic format documents, subject to Terms and Conditions for Electronic Documents at <http://www.sgs.com.tw/Terms-and-Conditions>. Attention is drawn to the limitation of liability, indemnification and jurisdiction issues defined therein. Any holder of this document is advised that information contained hereon reflects the Company's findings at the time of its intervention only and within the limits of Client's instructions, if any. The Company's sole responsibility is to its Client and this document does not exonerate parties to a transaction from exercising all their rights and obligations under the transaction documents. This document cannot be reproduced except in full, without prior written approval of the Company. Any unauthorized alteration, forgery or falsification of the content or appearance of this document is unlawful and offenders may be prosecuted to the fullest extent of the law.

Report Number :TERF2403000759E2
 Operation Mode :802.11ac40
 Test Frequency :5795 MHz
 Test Mode :Tx
 EUT Pol :E2 Plane

Test Site :SAC G Chamber
 Test Date :2024-03-29
 Temp./Humi. :24.3°C/58%
 Antenna Pol. :Vertical
 Engineer :Temo Chen



Freq. MHz	Detector Mode PK/QP/AVG	Spectrum Reading Level dBμV	Factor dB	Actual FS dBμV/m	Limit @3m dBμV/m	Margin dB
11590.000	Average	27.42	10.44	37.86	54.00	-16.14
11590.000	Peak	37.34	10.44	47.78	74.00	-26.22
17385.000	Peak	38.33	12.52	50.85	68.20	-17.35

Unless otherwise stated the results shown in this test report refer only to the sample(s) tested and such sample(s) are retained for 90 days only.

除非另有說明，此報告結果僅對測試之樣品負責，同時此樣品僅保留90天。本報告未經本公司書面許可，不可部份複製。

This document is issued by the Company subject to its General Conditions of Service printed overleaf, available on request or accessible at <http://www.sgs.com.tw/Terms-and-Conditions> and for electronic format documents, subject to Terms and Conditions for Electronic Documents at <http://www.sgs.com.tw/Terms-and-Conditions>. Attention is drawn to the limitation of liability, indemnification and jurisdiction issues defined therein. Any holder of this document is advised that information contained hereon reflects the Company's findings at the time of its intervention only and within the limits of Client's instructions, if any. The Company's sole responsibility is to its Client and this document does not exonerate parties to a transaction from exercising all their rights and obligations under the transaction documents. This document cannot be reproduced except in full, without prior written approval of the Company. Any unauthorized alteration, forgery or falsification of the content or appearance of this document is unlawful and offenders may be prosecuted to the fullest extent of the law.

Report Number :TERF2403000759E2
 Operation Mode :802.11ac40
 Test Frequency :5795 MHz
 Test Mode :Tx
 EUT Pol :E2 Plane

Test Site :SAC G Chamber
 Test Date :2024-03-29
 Temp./Humi. :24.3°C/58%
 Antenna Pol. :Horizontal
 Engineer :Temo Chen



Freq. MHz	Detector Mode PK/QP/AVG	Spectrum Reading Level dBμV	Factor dB	Actual FS dBμV/m	Limit @3m dBμV/m	Margin dB
11590.000	Average	27.35	10.44	37.79	54.00	-16.21
11590.000	Peak	38.17	10.44	48.61	74.00	-25.39
17385.000	Peak	39.51	12.52	52.03	68.20	-16.17

Unless otherwise stated the results shown in this test report refer only to the sample(s) tested and such sample(s) are retained for 90 days only.

除非另有說明，此報告結果僅對測試之樣品負責，同時此樣品僅保留90天。本報告未經本公司書面許可，不可部份複製。

This document is issued by the Company subject to its General Conditions of Service printed overleaf, available on request or accessible at <http://www.sgs.com.tw/Terms-and-Conditions> and for electronic format documents, subject to Terms and Conditions for Electronic Documents at <http://www.sgs.com.tw/Terms-and-Conditions>. Attention is drawn to the limitation of liability, indemnification and jurisdiction issues defined therein. Any holder of this document is advised that information contained hereon reflects the Company's findings at the time of its intervention only and within the limits of Client's instructions, if any. The Company's sole responsibility is to its Client and this document does not exonerate parties to a transaction from exercising all their rights and obligations under the transaction documents. This document cannot be reproduced except in full, without prior written approval of the Company. Any unauthorized alteration, forgery or falsification of the content or appearance of this document is unlawful and offenders may be prosecuted to the fullest extent of the law.

Report Number :TERF2403000759E2
 Operation Mode :802.11ac80
 Test Frequency :5210 MHz
 Test Mode :Tx
 EUT Pol :E2 Plane

Test Site :SAC G Chamber
 Test Date :2024-03-29
 Temp./Humi. :24.3°C/58%
 Antenna Pol. :Vertical
 Engineer :Temo Chen

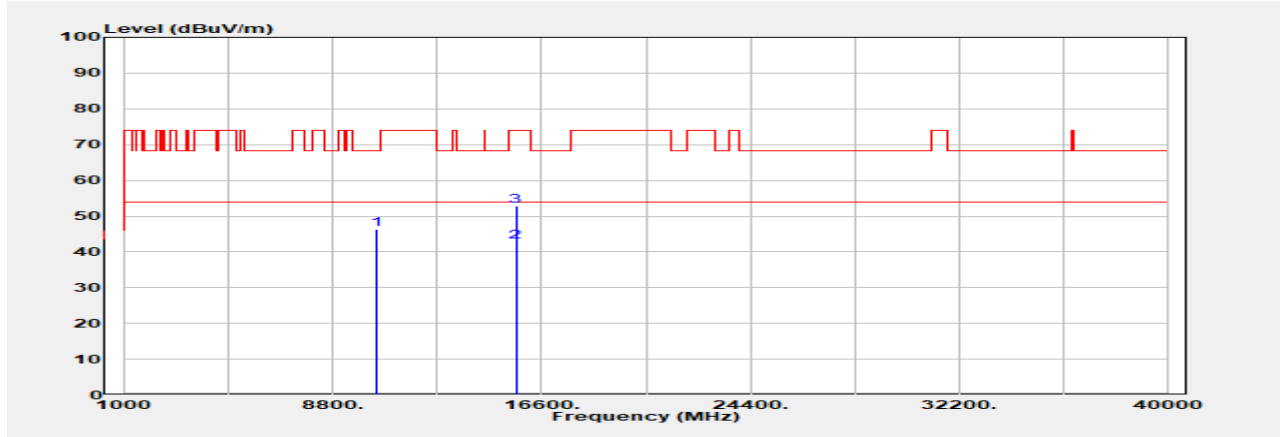

Freq. MHz	Detector Mode PK/QP/AVG	Spectrum Reading Level dB μ V	Factor dB	Actual FS dB μ V/m	Limit @3m dB μ V/m	Margin dB
10420.000	Peak	36.17	10.09	46.25	68.20	-21.95
15630.000	Average	30.12	12.73	42.85	54.00	-11.15
15630.000	Peak	40.22	12.73	52.94	74.00	-21.06

Unless otherwise stated the results shown in this test report refer only to the sample(s) tested and such sample(s) are retained for 90 days only.

除非另有說明，此報告結果僅對測試之樣品負責，同時此樣品僅保留90天。本報告未經本公司書面許可，不可部份複製。

This document is issued by the Company subject to its General Conditions of Service printed overleaf, available on request or accessible at <http://www.sgs.com.tw/Terms-and-Conditions> and for electronic format documents, subject to Terms and Conditions for Electronic Documents at <http://www.sgs.com.tw/Terms-and-Conditions>. Attention is drawn to the limitation of liability, indemnification and jurisdiction issues defined therein. Any holder of this document is advised that information contained hereon reflects the Company's findings at the time of its intervention only and within the limits of Client's instructions, if any. The Company's sole responsibility is to its Client and this document does not exonerate parties to a transaction from exercising all their rights and obligations under the transaction documents. This document cannot be reproduced except in full, without prior written approval of the Company. Any unauthorized alteration, forgery or falsification of the content or appearance of this document is unlawful and offenders may be prosecuted to the fullest extent of the law.

Report Number :TERF2403000759E2
 Operation Mode :802.11ac80
 Test Frequency :5210 MHz
 Test Mode :Tx
 EUT Pol :E2 Plane

Test Site :SAC G Chamber
 Test Date :2024-03-29
 Temp./Humi. :24.3°C/58%
 Antenna Pol. :Horizontal
 Engineer :Temo Chen

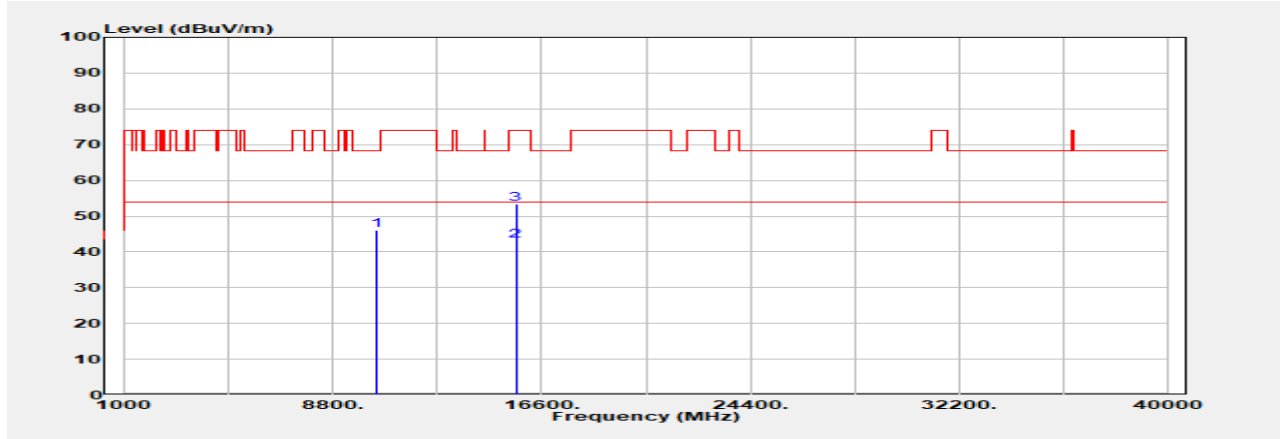

Freq. MHz	Detector Mode PK/QP/AVG	Spectrum Reading Level dB μ V	Factor dB	Actual FS dB μ V/m	Limit @3m dB μ V/m	Margin dB
10420.000	Peak	35.92	10.09	46.01	68.20	-22.19
15630.000	Average	30.25	12.73	42.97	54.00	-11.03
15630.000	Peak	40.56	12.73	53.28	74.00	-20.72

Unless otherwise stated the results shown in this test report refer only to the sample(s) tested and such sample(s) are retained for 90 days only.

除非另有說明，此報告結果僅對測試之樣品負責，同時此樣品僅保留90天。本報告未經本公司書面許可，不可部份複製。

This document is issued by the Company subject to its General Conditions of Service printed overleaf, available on request or accessible at <http://www.sgs.com.tw/Terms-and-Conditions> and for electronic format documents, subject to Terms and Conditions for Electronic Documents at <http://www.sgs.com.tw/Terms-and-Conditions>. Attention is drawn to the limitation of liability, indemnification and jurisdiction issues defined therein. Any holder of this document is advised that information contained hereon reflects the Company's findings at the time of its intervention only and within the limits of Client's instructions, if any. The Company's sole responsibility is to its Client and this document does not exonerate parties to a transaction from exercising all their rights and obligations under the transaction documents. This document cannot be reproduced except in full, without prior written approval of the Company. Any unauthorized alteration, forgery or falsification of the content or appearance of this document is unlawful and offenders may be prosecuted to the fullest extent of the law.

Report Number :TERF2403000759E2
 Operation Mode :802.11ac80
 Test Frequency :5290 MHz
 Test Mode :Tx
 EUT Pol :E2 Plane

Test Site :SAC G Chamber
 Test Date :2024-03-29
 Temp./Humi. :24.3°C/58%
 Antenna Pol. :Vertical
 Engineer :Temo Chen

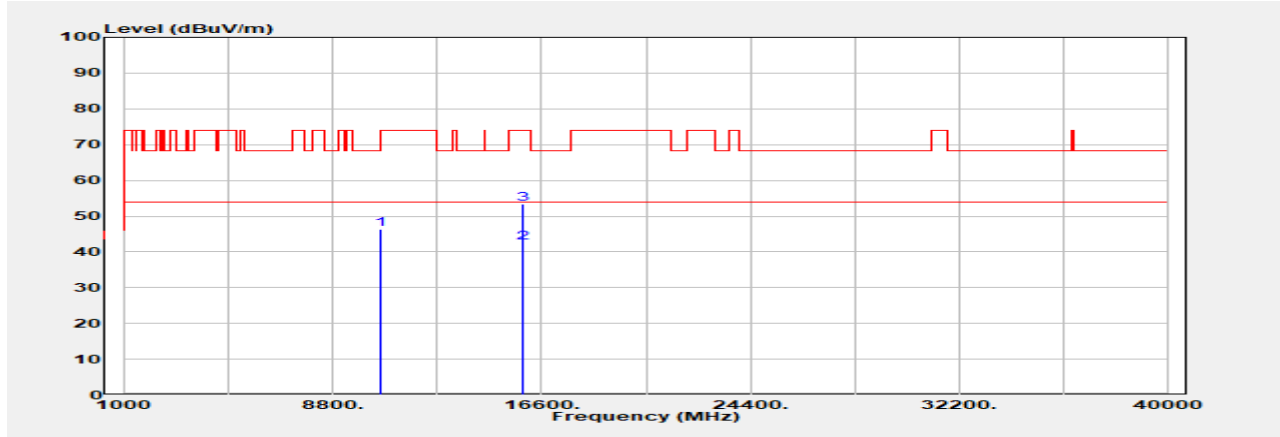

Freq. MHz	Detector Mode PK/QP/AVG	Spectrum Reading Level dBμV	Factor dB	Actual FS dBμV/m	Limit @3m dBμV/m	Margin dB
10580.000	Peak	36.47	9.84	46.31	68.20	-21.89
15870.000	Average	29.48	13.12	42.60	54.00	-11.40
15870.000	Peak	40.17	13.12	53.29	74.00	-20.71

Unless otherwise stated the results shown in this test report refer only to the sample(s) tested and such sample(s) are retained for 90 days only.

除非另有說明，此報告結果僅對測試之樣品負責，同時此樣品僅保留90天。本報告未經本公司書面許可，不可部份複製。

This document is issued by the Company subject to its General Conditions of Service printed overleaf, available on request or accessible at <http://www.sgs.com.tw/Terms-and-Conditions> and for electronic format documents, subject to Terms and Conditions for Electronic Documents at <http://www.sgs.com.tw/Terms-and-Conditions>. Attention is drawn to the limitation of liability, indemnification and jurisdiction issues defined therein. Any holder of this document is advised that information contained hereon reflects the Company's findings at the time of its intervention only and within the limits of Client's instructions, if any. The Company's sole responsibility is to its Client and this document does not exonerate parties to a transaction from exercising all their rights and obligations under the transaction documents. This document cannot be reproduced except in full, without prior written approval of the Company. Any unauthorized alteration, forgery or falsification of the content or appearance of this document is unlawful and offenders may be prosecuted to the fullest extent of the law.

Report Number :TERF2403000759E2
 Operation Mode :802.11ac80
 Test Frequency :5290 MHz
 Test Mode :Tx
 EUT Pol :E2 Plane

Test Site :SAC G Chamber
 Test Date :2024-03-29
 Temp./Humi. :24.3°C/58%
 Antenna Pol. :Horizontal
 Engineer :Temo Chen

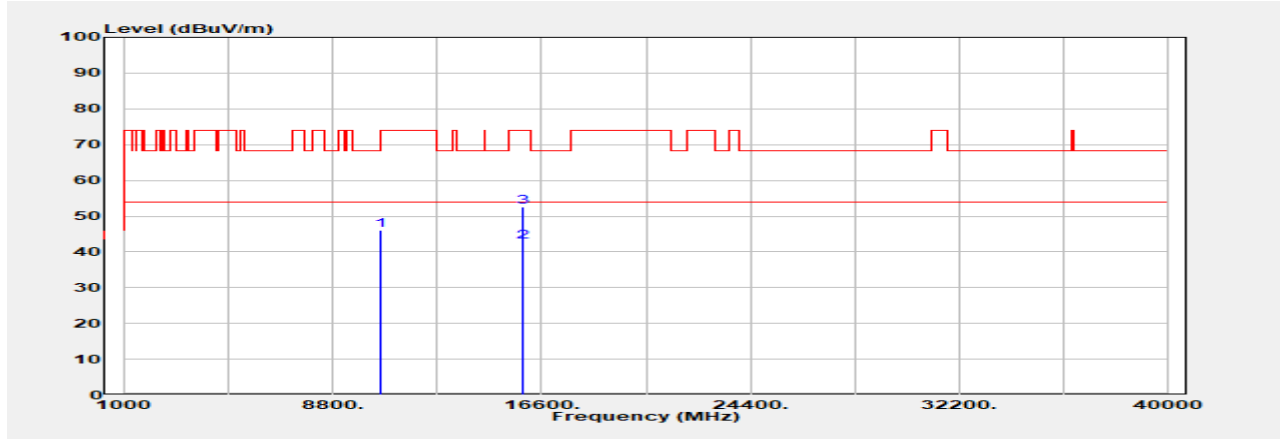

Freq. MHz	Detector Mode PK/QP/AVG	Spectrum Reading Level dB μ V	Factor dB	Actual FS dB μ V/m	Limit @3m dB μ V/m	Margin dB
10580.000	Peak	36.18	9.84	46.01	68.20	-22.19
15870.000	Average	29.65	13.12	42.77	54.00	-11.23
15870.000	Peak	39.47	13.12	52.59	74.00	-21.41

Unless otherwise stated the results shown in this test report refer only to the sample(s) tested and such sample(s) are retained for 90 days only.

除非另有說明，此報告結果僅對測試之樣品負責，同時此樣品僅保留90天。本報告未經本公司書面許可，不可部份複製。

This document is issued by the Company subject to its General Conditions of Service printed overleaf, available on request or accessible at <http://www.sgs.com.tw/Terms-and-Conditions> and for electronic format documents, subject to Terms and Conditions for Electronic Documents at <http://www.sgs.com.tw/Terms-and-Conditions>. Attention is drawn to the limitation of liability, indemnification and jurisdiction issues defined therein. Any holder of this document is advised that information contained hereon reflects the Company's findings at the time of its intervention only and within the limits of Client's instructions, if any. The Company's sole responsibility is to its Client and this document does not exonerate parties to a transaction from exercising all their rights and obligations under the transaction documents. This document cannot be reproduced except in full, without prior written approval of the Company. Any unauthorized alteration, forgery or falsification of the content or appearance of this document is unlawful and offenders may be prosecuted to the fullest extent of the law.

Report Number :TERF2403000759E2
 Operation Mode :802.11ac80
 Test Frequency :5530 MHz
 Test Mode :Tx
 EUT Pol :E2 Plane

Test Site :SAC G Chamber
 Test Date :2024-03-29
 Temp./Humi. :24.3°C/58%
 Antenna Pol. :Vertical
 Engineer :Temo Chen

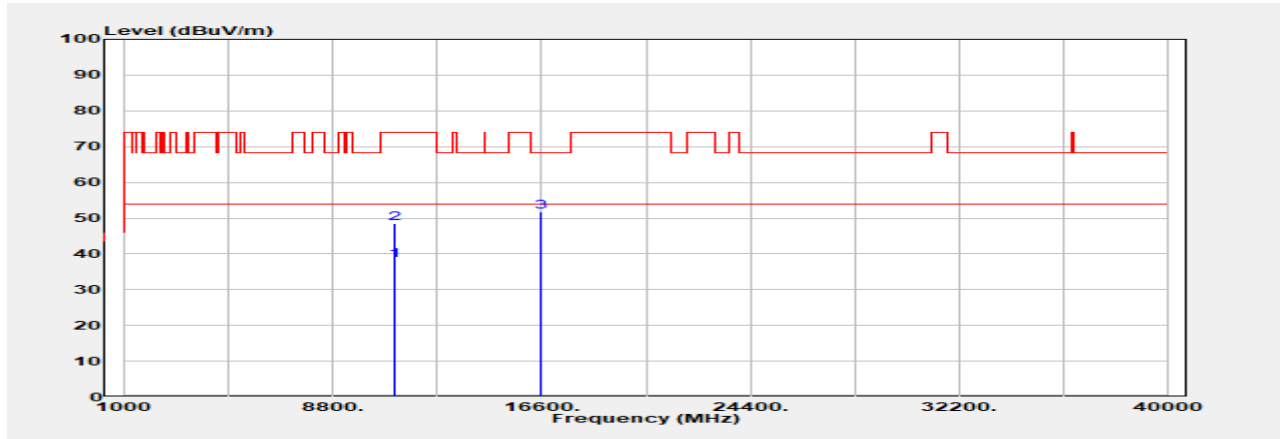

Freq. MHz	Detector Mode PK/QP/AVG	Spectrum Reading Level dB μ V	Factor dB	Actual FS dB μ V/m	Limit @3m dB μ V/m	Margin dB
11060.000	Average	27.92	10.37	38.29	54.00	-15.71
11060.000	Peak	38.08	10.37	48.45	74.00	-25.55
16590.000	Peak	38.52	13.17	51.69	68.20	-16.51

Unless otherwise stated the results shown in this test report refer only to the sample(s) tested and such sample(s) are retained for 90 days only.

除非另有說明，此報告結果僅對測試之樣品負責，同時此樣品僅保留90天。本報告未經本公司書面許可，不可部份複製。

This document is issued by the Company subject to its General Conditions of Service printed overleaf, available on request or accessible at <http://www.sgs.com.tw/Terms-and-Conditions> and for electronic format documents, subject to Terms and Conditions for Electronic Documents at <http://www.sgs.com.tw/Terms-and-Conditions>. Attention is drawn to the limitation of liability, indemnification and jurisdiction issues defined therein. Any holder of this document is advised that information contained hereon reflects the Company's findings at the time of its intervention only and within the limits of Client's instructions, if any. The Company's sole responsibility is to its Client and this document does not exonerate parties to a transaction from exercising all their rights and obligations under the transaction documents. This document cannot be reproduced except in full, without prior written approval of the Company. Any unauthorized alteration, forgery or falsification of the content or appearance of this document is unlawful and offenders may be prosecuted to the fullest extent of the law.

Report Number :TERF2403000759E2
 Operation Mode :802.11ac80
 Test Frequency :5530 MHz
 Test Mode :Tx
 EUT Pol :E2 Plane

Test Site :SAC G Chamber
 Test Date :2024-03-29
 Temp./Humi. :24.3°C/58%
 Antenna Pol. :Horizontal
 Engineer :Temo Chen

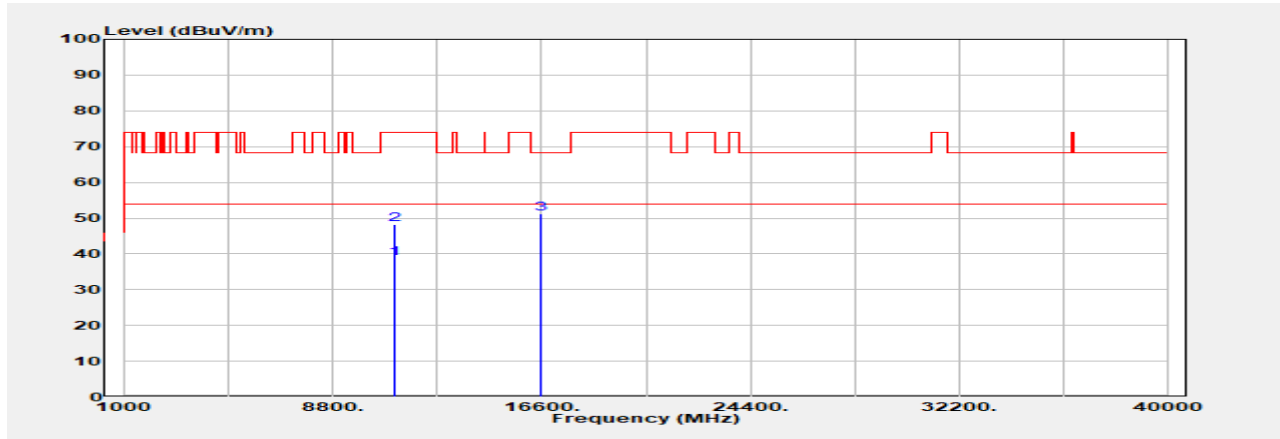

Freq. MHz	Detector Mode PK/QP/AVG	Spectrum Reading Level dB μ V	Factor dB	Actual FS dB μ V/m	Limit @3m dB μ V/m	Margin dB
11060.000	Average	28.26	10.37	38.64	54.00	-15.36
11060.000	Peak	37.85	10.37	48.22	74.00	-25.78
16590.000	Peak	37.97	13.17	51.14	68.20	-17.06

Unless otherwise stated the results shown in this test report refer only to the sample(s) tested and such sample(s) are retained for 90 days only.

除非另有說明，此報告結果僅對測試之樣品負責，同時此樣品僅保留90天。本報告未經本公司書面許可，不可部份複製。

This document is issued by the Company subject to its General Conditions of Service printed overleaf, available on request or accessible at <http://www.sgs.com.tw/Terms-and-Conditions> and for electronic format documents, subject to Terms and Conditions for Electronic Documents at <http://www.sgs.com.tw/Terms-and-Conditions>. Attention is drawn to the limitation of liability, indemnification and jurisdiction issues defined therein. Any holder of this document is advised that information contained hereon reflects the Company's findings at the time of its intervention only and within the limits of Client's instructions, if any. The Company's sole responsibility is to its Client and this document does not exonerate parties to a transaction from exercising all their rights and obligations under the transaction documents. This document cannot be reproduced except in full, without prior written approval of the Company. Any unauthorized alteration, forgery or falsification of the content or appearance of this document is unlawful and offenders may be prosecuted to the fullest extent of the law.

Report Number :TERF2403000759E2
 Operation Mode :802.11ac80
 Test Frequency :5610 MHz
 Test Mode :Tx
 EUT Pol :E2 Plane

Test Site :SAC G Chamber
 Test Date :2024-03-29
 Temp./Humi. :24.3°C/58%
 Antenna Pol. :Vertical
 Engineer :Temo Chen

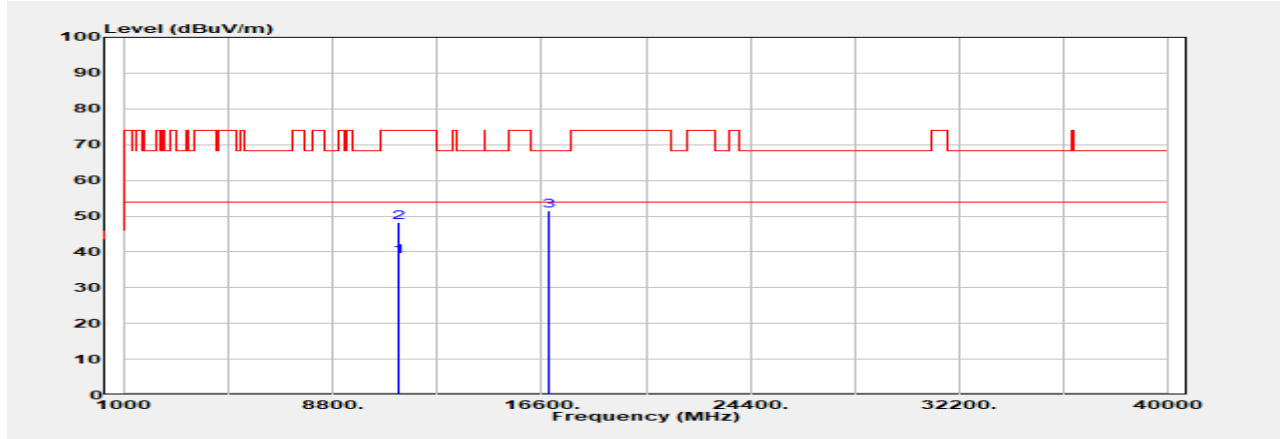

Freq. MHz	Detector Mode PK/QP/AVG	Spectrum Reading Level dB μ V	Factor dB	Actual FS dB μ V/m	Limit @3m dB μ V/m	Margin dB
11220.000	Average	28.74	9.96	38.70	54.00	-15.30
11220.000	Peak	38.31	9.96	48.27	74.00	-25.73
16830.000	Peak	39.19	12.25	51.44	68.20	-16.76

Unless otherwise stated the results shown in this test report refer only to the sample(s) tested and such sample(s) are retained for 90 days only.

除非另有說明，此報告結果僅對測試之樣品負責，同時此樣品僅保留90天。本報告未經本公司書面許可，不可部份複製。

This document is issued by the Company subject to its General Conditions of Service printed overleaf, available on request or accessible at <http://www.sgs.com.tw/Terms-and-Conditions> and for electronic format documents, subject to Terms and Conditions for Electronic Documents at <http://www.sgs.com.tw/Terms-and-Conditions>. Attention is drawn to the limitation of liability, indemnification and jurisdiction issues defined therein. Any holder of this document is advised that information contained hereon reflects the Company's findings at the time of its intervention only and within the limits of Client's instructions, if any. The Company's sole responsibility is to its Client and this document does not exonerate parties to a transaction from exercising all their rights and obligations under the transaction documents. This document cannot be reproduced except in full, without prior written approval of the Company. Any unauthorized alteration, forgery or falsification of the content or appearance of this document is unlawful and offenders may be prosecuted to the fullest extent of the law.

Report Number :TERF2403000759E2
 Operation Mode :802.11ac80
 Test Frequency :5610 MHz
 Test Mode :Tx
 EUT Pol :E2 Plane

Test Site :SAC G Chamber
 Test Date :2024-03-29
 Temp./Humi. :24.3°C/58%
 Antenna Pol. :Horizontal
 Engineer :Temo Chen

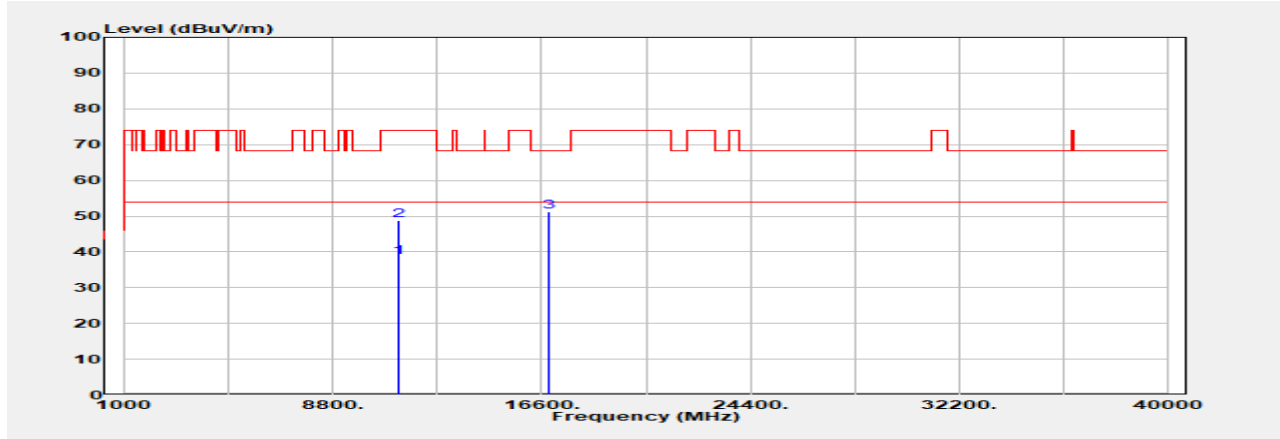

Freq. MHz	Detector Mode PK/QP/AVG	Spectrum Reading Level dBμV	Factor dB	Actual FS dBμV/m	Limit @3m dBμV/m	Margin dB
11220.000	Average	28.44	9.96	38.41	54.00	-15.59
11220.000	Peak	38.76	9.96	48.72	74.00	-25.28
16830.000	Peak	38.97	12.25	51.22	68.20	-16.98

Unless otherwise stated the results shown in this test report refer only to the sample(s) tested and such sample(s) are retained for 90 days only.

除非另有說明，此報告結果僅對測試之樣品負責，同時此樣品僅保留90天。本報告未經本公司書面許可，不可部份複製。

This document is issued by the Company subject to its General Conditions of Service printed overleaf, available on request or accessible at <http://www.sgs.com.tw/Terms-and-Conditions> and for electronic format documents, subject to Terms and Conditions for Electronic Documents at <http://www.sgs.com.tw/Terms-and-Conditions>. Attention is drawn to the limitation of liability, indemnification and jurisdiction issues defined therein. Any holder of this document is advised that information contained hereon reflects the Company's findings at the time of its intervention only and within the limits of Client's instructions, if any. The Company's sole responsibility is to its Client and this document does not exonerate parties to a transaction from exercising all their rights and obligations under the transaction documents. This document cannot be reproduced except in full, without prior written approval of the Company. Any unauthorized alteration, forgery or falsification of the content or appearance of this document is unlawful and offenders may be prosecuted to the fullest extent of the law.

Report Number :TERF2403000759E2
 Operation Mode :802.11ac80
 Test Frequency :5690 MHz
 Test Mode :Tx
 EUT Pol :E2 Plane

Test Site :SAC G Chamber
 Test Date :2024-03-29
 Temp./Humi. :24.3°C/58%
 Antenna Pol. :Vertical
 Engineer :Temo Chen

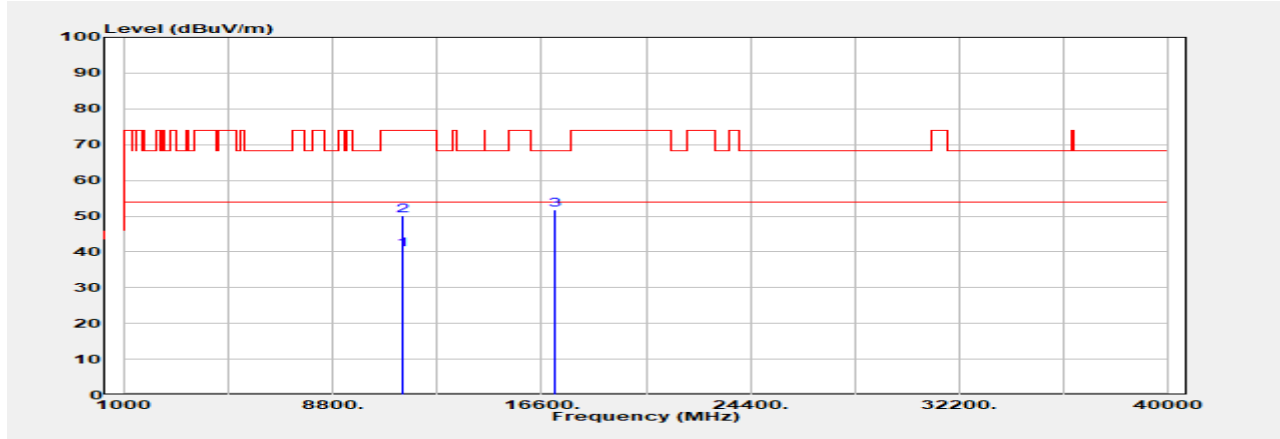

Freq. MHz	Detector Mode PK/QP/AVG	Spectrum Reading Level dB μ V	Factor dB	Actual FS dB μ V/m	Limit @3m dB μ V/m	Margin dB
11380.000	Average	28.63	11.93	40.56	54.00	-13.44
11380.000	Peak	38.24	11.93	50.16	74.00	-23.84
17070.000	Peak	38.76	12.97	51.73	68.20	-16.47

Unless otherwise stated the results shown in this test report refer only to the sample(s) tested and such sample(s) are retained for 90 days only.

除非另有說明，此報告結果僅對測試之樣品負責，同時此樣品僅保留90天。本報告未經本公司書面許可，不可部份複製。

This document is issued by the Company subject to its General Conditions of Service printed overleaf, available on request or accessible at <http://www.sgs.com.tw/Terms-and-Conditions> and for electronic format documents, subject to Terms and Conditions for Electronic Documents at <http://www.sgs.com.tw/Terms-and-Conditions>. Attention is drawn to the limitation of liability, indemnification and jurisdiction issues defined therein. Any holder of this document is advised that information contained hereon reflects the Company's findings at the time of its intervention only and within the limits of Client's instructions, if any. The Company's sole responsibility is to its Client and this document does not exonerate parties to a transaction from exercising all their rights and obligations under the transaction documents. This document cannot be reproduced except in full, without prior written approval of the Company. Any unauthorized alteration, forgery or falsification of the content or appearance of this document is unlawful and offenders may be prosecuted to the fullest extent of the law.

Report Number :TERF2403000759E2

Test Site :SAC G Chamber

Operation Mode :802.11ac80

Test Date :2024-03-29

Test Frequency :5690 MHz

Temp./Humi. :24.3°C/58%

Test Mode :Tx

Antenna Pol. :Horizontal

EUT Pol :E2 Plane

Engineer :Temo Chen

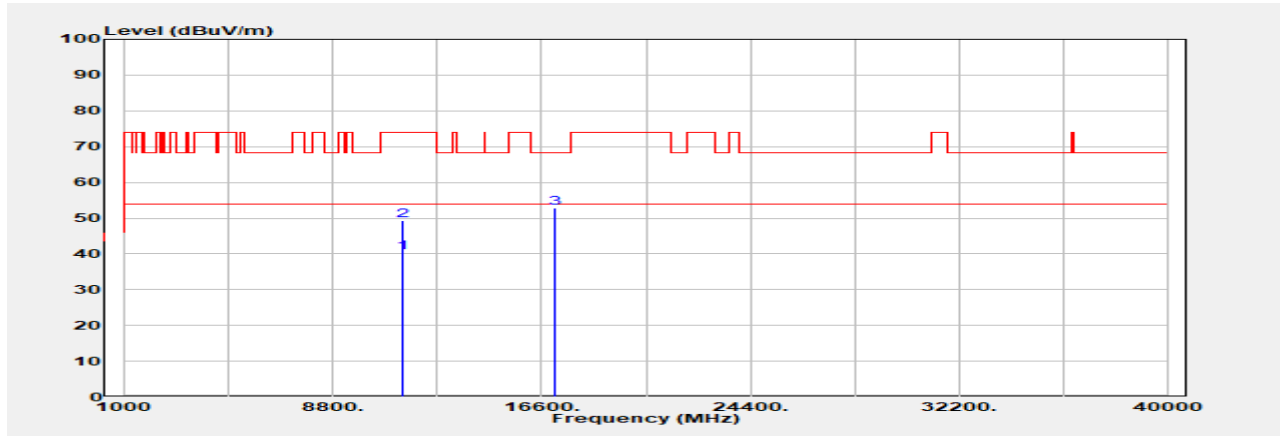

Freq. MHz	Detector Mode PK/QP/AVG	Spectrum Reading Level dB μ V	Factor dB	Actual FS dB μ V/m	Limit @3m dB μ V/m	Margin dB
11380.000	Average	28.57	11.93	40.50	54.00	-13.50
11380.000	Peak	37.47	11.93	49.39	74.00	-24.61
17070.000	Peak	39.81	12.97	52.78	68.20	-15.42

Unless otherwise stated the results shown in this test report refer only to the sample(s) tested and such sample(s) are retained for 90 days only.

除非另有說明，此報告結果僅對測試之樣品負責，同時此樣品僅保留90天。本報告未經本公司書面許可，不可部份複製。

This document is issued by the Company subject to its General Conditions of Service printed overleaf, available on request or accessible at <http://www.sgs.com.tw/Terms-and-Conditions> and for electronic format documents, subject to Terms and Conditions for Electronic Documents at <http://www.sgs.com.tw/Terms-and-Conditions>. Attention is drawn to the limitation of liability, indemnification and jurisdiction issues defined therein. Any holder of this document is advised that information contained hereon reflects the Company's findings at the time of its intervention only and within the limits of Client's instructions, if any. The Company's sole responsibility is to its Client and this document does not exonerate parties to a transaction from exercising all their rights and obligations under the transaction documents. This document cannot be reproduced except in full, without prior written approval of the Company. Any unauthorized alteration, forgery or falsification of the content or appearance of this document is unlawful and offenders may be prosecuted to the fullest extent of the law.

Report Number :TERF2403000759E2

Test Site :SAC G Chamber

Operation Mode :802.11ac80

Test Date :2024-03-29

Test Frequency :5775 MHz

Temp./Humi. :24.3°C/58%

Test Mode :Tx

Antenna Pol. :Vertical

EUT Pol :E2 Plane

Engineer :Temo Chen

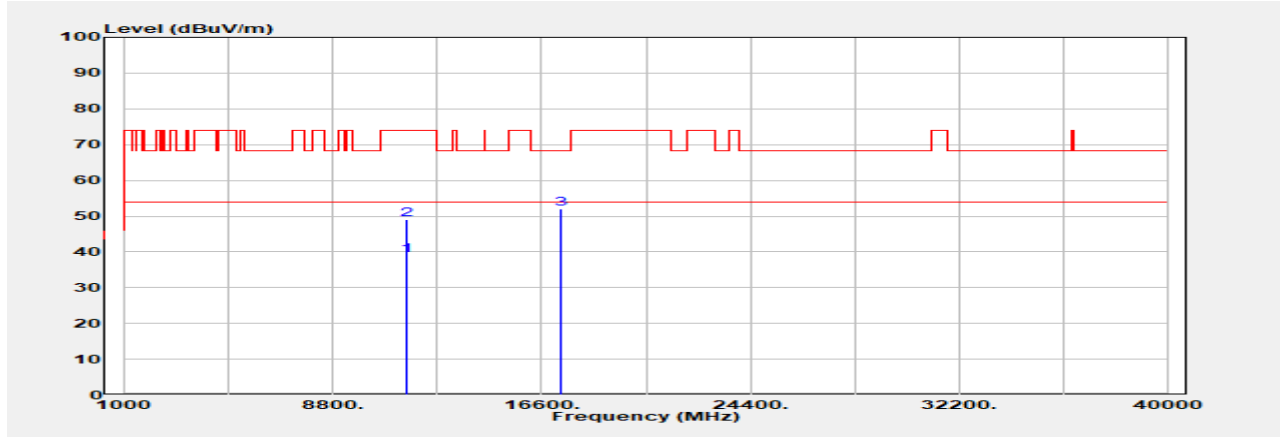

Freq. MHz	Detector Mode PK/QP/AVG	Spectrum Reading Level dBμV	Factor dB	Actual FS dBμV/m	Limit @3m dBμV/m	Margin dB
11550.000	Average	28.55	10.40	38.94	54.00	-15.06
11550.000	Peak	38.72	10.40	49.12	74.00	-24.88
17325.000	Peak	38.91	13.16	52.07	68.20	-16.13

Unless otherwise stated the results shown in this test report refer only to the sample(s) tested and such sample(s) are retained for 90 days only.

除非另有說明，此報告結果僅對測試之樣品負責，同時此樣品僅保留90天。本報告未經本公司書面許可，不可部份複製。

This document is issued by the Company subject to its General Conditions of Service printed overleaf, available on request or accessible at <http://www.sgs.com.tw/Terms-and-Conditions> and for electronic format documents, subject to Terms and Conditions for Electronic Documents at <http://www.sgs.com.tw/Terms-and-Conditions>. Attention is drawn to the limitation of liability, indemnification and jurisdiction issues defined therein. Any holder of this document is advised that information contained hereon reflects the Company's findings at the time of its intervention only and within the limits of Client's instructions, if any. The Company's sole responsibility is to its Client and this document does not exonerate parties to a transaction from exercising all their rights and obligations under the transaction documents. This document cannot be reproduced except in full, without prior written approval of the Company. Any unauthorized alteration, forgery or falsification of the content or appearance of this document is unlawful and offenders may be prosecuted to the fullest extent of the law.

Report Number :TERF2403000759E2
 Operation Mode :802.11ac80
 Test Frequency :5775 MHz
 Test Mode :Tx
 EUT Pol :E2 Plane

Test Site :SAC G Chamber
 Test Date :2024-03-29
 Temp./Humi. :24.3°C/58%
 Antenna Pol. :Horizontal
 Engineer :Temo Chen

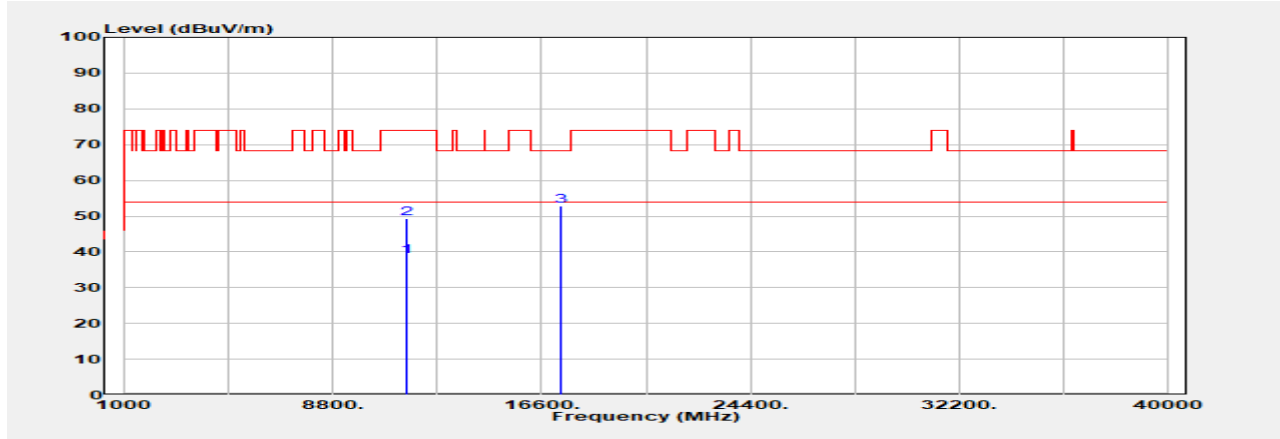

Freq. MHz	Detector Mode PK/QP/AVG	Spectrum Reading Level dB μ V	Factor dB	Actual FS dB μ V/m	Limit @3m dB μ V/m	Margin dB
11550.000	Average	28.44	10.40	38.83	54.00	-15.17
11550.000	Peak	38.85	10.40	49.24	74.00	-24.76
17325.000	Peak	39.64	13.16	52.81	68.20	-15.39

Unless otherwise stated the results shown in this test report refer only to the sample(s) tested and such sample(s) are retained for 90 days only.

除非另有說明，此報告結果僅對測試之樣品負責，同時此樣品僅保留90天。本報告未經本公司書面許可，不可部份複製。

This document is issued by the Company subject to its General Conditions of Service printed overleaf, available on request or accessible at <http://www.sgs.com.tw/Terms-and-Conditions> and for electronic format documents, subject to Terms and Conditions for Electronic Documents at <http://www.sgs.com.tw/Terms-and-Conditions>. Attention is drawn to the limitation of liability, indemnification and jurisdiction issues defined therein. Any holder of this document is advised that information contained hereon reflects the Company's findings at the time of its intervention only and within the limits of Client's instructions, if any. The Company's sole responsibility is to its Client and this document does not exonerate parties to a transaction from exercising all their rights and obligations under the transaction documents. This document cannot be reproduced except in full, without prior written approval of the Company. Any unauthorized alteration, forgery or falsification of the content or appearance of this document is unlawful and offenders may be prosecuted to the fullest extent of the law.

8.6.2 Band edge falling to restricted band

Report Number	:TERF2403000759E2	Test Site	:SAC G Chamber
Operation Mode	:802.11a	Test Date	:2024-03-28
Test Frequency	:5180 MHz	Temp./Humi.	:24.8°C/60%
Test Mode	:Bandedge	Antenna Pol.	:Vertical
EUT Pol	:E2 Plane	Engineer	:Temo Chen

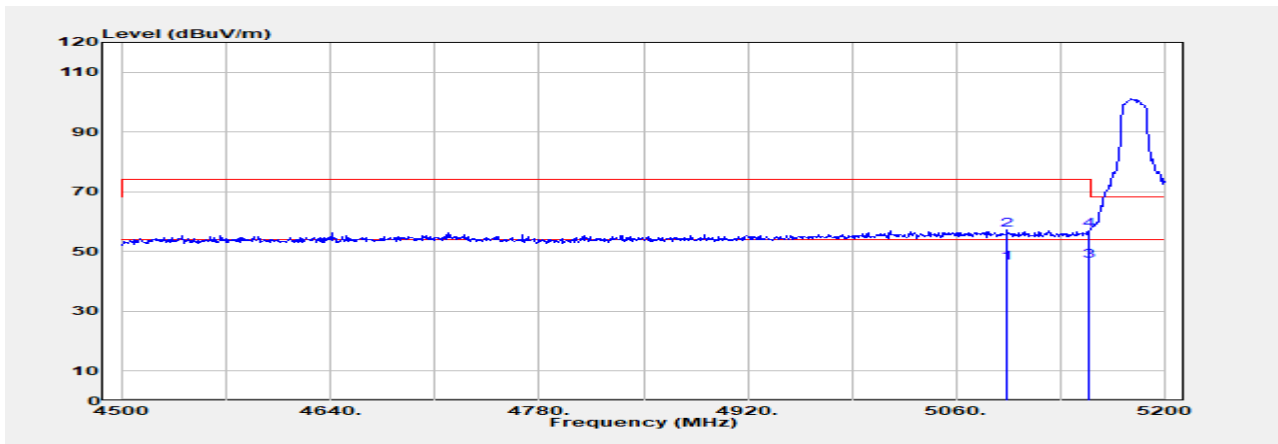

Freq. MHz	Detector Mode PK/QP/AVG	Spectrum Reading Level dB μ V	Factor dB	Actual FS dB μ V/m	Limit @3m dB μ V/m	Margin dB
5094.300	Average	40.27	6.02	46.29	54.00	-7.71
5094.300	Peak	51.15	6.02	57.17	74.00	-16.83
5150.000	Average	41.06	5.72	46.78	54.00	-7.22
5150.000	Peak	51.65	5.72	57.37	74.00	-16.63

Unless otherwise stated the results shown in this test report refer only to the sample(s) tested and such sample(s) are retained for 90 days only.

除非另有說明，此報告結果僅對測試之樣品負責，同時此樣品僅保留90天。本報告未經本公司書面許可，不可部份複製。

This document is issued by the Company subject to its General Conditions of Service printed overleaf, available on request or accessible at <http://www.sgs.com.tw/Terms-and-Conditions> and for electronic format documents, subject to Terms and Conditions for Electronic Documents at <http://www.sgs.com.tw/Terms-and-Conditions>. Attention is drawn to the limitation of liability, indemnification and jurisdiction issues defined therein. Any holder of this document is advised that information contained hereon reflects the Company's findings at the time of its intervention only and within the limits of Client's instructions, if any. The Company's sole responsibility is to its Client and this document does not exonerate parties to a transaction from exercising all their rights and obligations under the transaction documents. This document cannot be reproduced except in full, without prior written approval of the Company. Any unauthorized alteration, forgery or falsification of the content or appearance of this document is unlawful and offenders may be prosecuted to the fullest extent of the law.

Report Number :TERF2403000759E2
 Operation Mode :802.11a
 Test Frequency :5180 MHz
 Test Mode :Bandedge
 EUT Pol :E2 Plane

Test Site :SAC G Chamber
 Test Date :2024-03-28
 Temp./Humi. :24.8°C/60%
 Antenna Pol. :Horizontal
 Engineer :Temo Chen

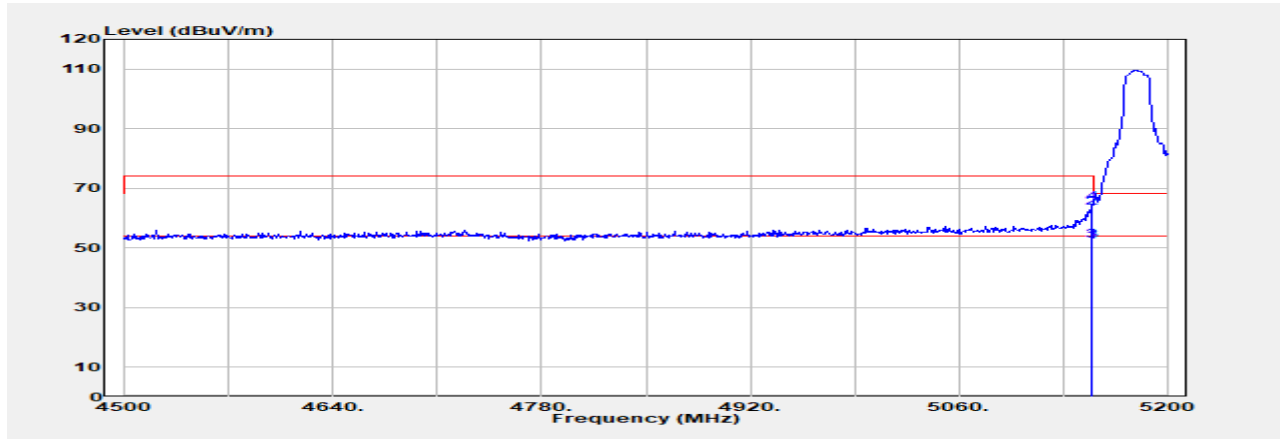

Freq. MHz	Detector Mode PK/QP/AVG	Spectrum Reading Level dB μ V	Factor dB	Actual FS dB μ V/m	Limit @3m dB μ V/m	Margin dB
5149.600	Average	46.37	5.73	52.10	54.00	-1.90
5149.600	Peak	57.75	5.73	63.48	74.00	-10.52
5150.000	Average	46.58	5.72	52.31	54.00	-1.69
5150.000	Peak	59.46	5.72	65.19	74.00	-8.81

Unless otherwise stated the results shown in this test report refer only to the sample(s) tested and such sample(s) are retained for 90 days only.

除非另有說明，此報告結果僅對測試之樣品負責，同時此樣品僅保留90天。本報告未經本公司書面許可，不可部份複製。

This document is issued by the Company subject to its General Conditions of Service printed overleaf, available on request or accessible at <http://www.sgs.com.tw/Terms-and-Conditions> and for electronic format documents, subject to Terms and Conditions for Electronic Documents at <http://www.sgs.com.tw/Terms-and-Conditions>. Attention is drawn to the limitation of liability, indemnification and jurisdiction issues defined therein. Any holder of this document is advised that information contained hereon reflects the Company's findings at the time of its intervention only and within the limits of Client's instructions, if any. The Company's sole responsibility is to its Client and this document does not exonerate parties to a transaction from exercising all their rights and obligations under the transaction documents. This document cannot be reproduced except in full, without prior written approval of the Company. Any unauthorized alteration, forgery or falsification of the content or appearance of this document is unlawful and offenders may be prosecuted to the fullest extent of the law.

Report Number :TERF2403000759E2
 Operation Mode :802.11a
 Test Frequency :5320 MHz
 Test Mode :Bandedge
 EUT Pol :E2 Plane

Test Site :SAC G Chamber
 Test Date :2024-03-28
 Temp./Humi. :24.8°C/60%
 Antenna Pol. :Vertical
 Engineer :Temo Chen

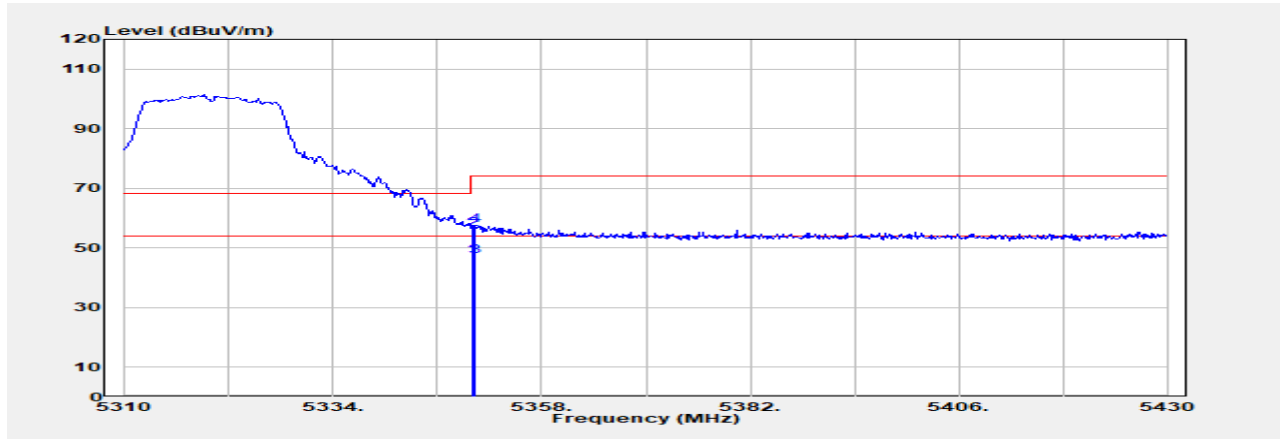

Freq. MHz	Detector Mode PK/QP/AVG	Spectrum Reading Level dB μ V	Factor dB	Actual FS dB μ V/m	Limit @3m dB μ V/m	Margin dB
5350.000	Average	41.92	5.34	47.26	54.00	-6.74
5350.000	Peak	51.07	5.34	56.41	74.00	-17.59
5350.320	Average	41.79	5.34	47.14	54.00	-6.86
5350.320	Peak	52.28	5.34	57.63	74.00	-16.37

Unless otherwise stated the results shown in this test report refer only to the sample(s) tested and such sample(s) are retained for 90 days only.

除非另有說明，此報告結果僅對測試之樣品負責，同時此樣品僅保留90天。本報告未經本公司書面許可，不可部份複製。

This document is issued by the Company subject to its General Conditions of Service printed overleaf, available on request or accessible at <http://www.sgs.com.tw/Terms-and-Conditions> and for electronic format documents, subject to Terms and Conditions for Electronic Documents at <http://www.sgs.com.tw/Terms-and-Conditions>. Attention is drawn to the limitation of liability, indemnification and jurisdiction issues defined therein. Any holder of this document is advised that information contained hereon reflects the Company's findings at the time of its intervention only and within the limits of Client's instructions, if any. The Company's sole responsibility is to its Client and this document does not exonerate parties to a transaction from exercising all their rights and obligations under the transaction documents. This document cannot be reproduced except in full, without prior written approval of the Company. Any unauthorized alteration, forgery or falsification of the content or appearance of this document is unlawful and offenders may be prosecuted to the fullest extent of the law.

Report Number :TERF2403000759E2
 Operation Mode :802.11a
 Test Frequency :5320 MHz
 Test Mode :Bandedge
 EUT Pol :E2 Plane

Test Site :SAC G Chamber
 Test Date :2024-03-28
 Temp./Humi. :24.8°C/60%
 Antenna Pol. :Horizontal
 Engineer :Temo Chen

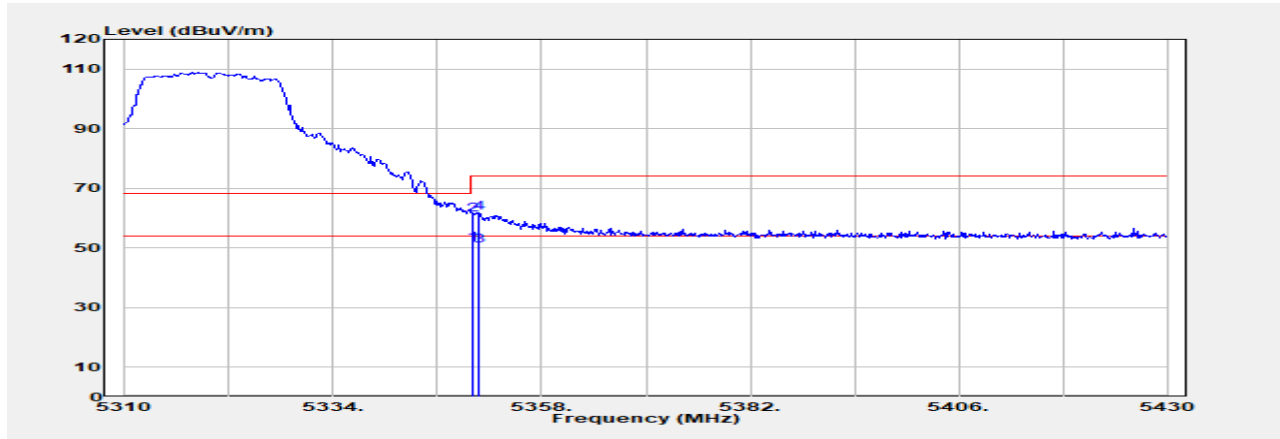

Freq. MHz	Detector Mode PK/QP/AVG	Spectrum Reading Level dBμV	Factor dB	Actual FS dBμV/m	Limit @3m dBμV/m	Margin dB
5350.000	Average	46.07	5.34	51.41	54.00	-2.59
5350.000	Peak	55.96	5.34	61.30	74.00	-12.70
5350.680	Average	45.30	5.34	50.64	54.00	-3.36
5350.680	Peak	56.47	5.34	61.81	74.00	-12.19

Unless otherwise stated the results shown in this test report refer only to the sample(s) tested and such sample(s) are retained for 90 days only.

除非另有說明，此報告結果僅對測試之樣品負責，同時此樣品僅保留90天。本報告未經本公司書面許可，不可部份複製。

This document is issued by the Company subject to its General Conditions of Service printed overleaf, available on request or accessible at <http://www.sgs.com.tw/Terms-and-Conditions> and for electronic format documents, subject to Terms and Conditions for Electronic Documents at <http://www.sgs.com.tw/Terms-and-Conditions>. Attention is drawn to the limitation of liability, indemnification and jurisdiction issues defined therein. Any holder of this document is advised that information contained hereon reflects the Company's findings at the time of its intervention only and within the limits of Client's instructions, if any. The Company's sole responsibility is to its Client and this document does not exonerate parties to a transaction from exercising all their rights and obligations under the transaction documents. This document cannot be reproduced except in full, without prior written approval of the Company. Any unauthorized alteration, forgery or falsification of the content or appearance of this document is unlawful and offenders may be prosecuted to the fullest extent of the law.

Report Number :TERF2403000759E2
 Operation Mode :802.11a
 Test Frequency :5500 MHz
 Test Mode :Bandedge
 EUT Pol :E2 Plane

Test Site :SAC G Chamber
 Test Date :2024-03-28
 Temp./Humi. :24.8°C/60%
 Antenna Pol. :Vertical
 Engineer :Temo Chen

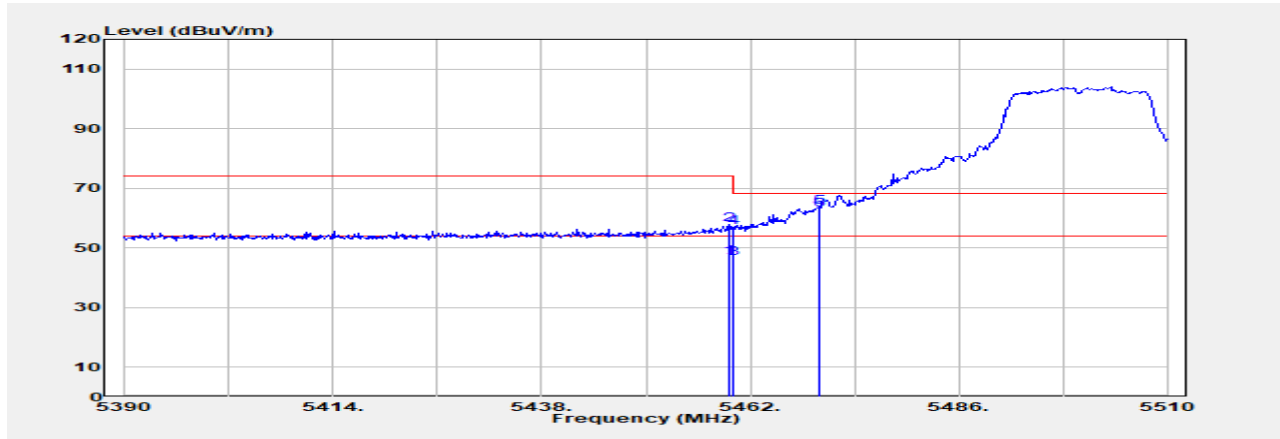

Freq. MHz	Detector Mode PK/QP/AVG	Spectrum Reading Level dBμV	Factor dB	Actual FS dBμV/m	Limit @3m dBμV/m	Margin dB
5459.600	Average	40.57	6.11	46.68	54.00	-7.32
5459.600	Peak	51.61	6.11	57.72	74.00	-16.28
5460.000	Average	40.43	6.11	46.54	54.00	-7.46
5460.000	Peak	50.68	6.11	56.79	74.00	-17.21
5469.920	Peak	57.55	6.20	63.76	68.20	-4.44
5470.000	Peak	56.62	6.21	62.82	68.20	-5.38

Unless otherwise stated the results shown in this test report refer only to the sample(s) tested and such sample(s) are retained for 90 days only.

除非另有說明，此報告結果僅對測試之樣品負責，同時此樣品僅保留90天。本報告未經本公司書面許可，不可部份複製。

This document is issued by the Company subject to its General Conditions of Service printed overleaf, available on request or accessible at <http://www.sgs.com.tw/Terms-and-Conditions> and for electronic format documents, subject to Terms and Conditions for Electronic Documents at <http://www.sgs.com.tw/Terms-and-Conditions>. Attention is drawn to the limitation of liability, indemnification and jurisdiction issues defined therein. Any holder of this document is advised that information contained hereon reflects the Company's findings at the time of its intervention only and within the limits of Client's instructions, if any. The Company's sole responsibility is to its Client and this document does not exonerate parties to a transaction from exercising all their rights and obligations under the transaction documents. This document cannot be reproduced except in full, without prior written approval of the Company. Any unauthorized alteration, forgery or falsification of the content or appearance of this document is unlawful and offenders may be prosecuted to the fullest extent of the law.

Report Number :TERF2403000759E2
 Operation Mode :802.11a
 Test Frequency :5500 MHz
 Test Mode :Bandedge
 EUT Pol :E2 Plane

Test Site :SAC G Chamber
 Test Date :2024-03-28
 Temp./Humi. :24.8°C/60%
 Antenna Pol. :Horizontal
 Engineer :Temo Chen

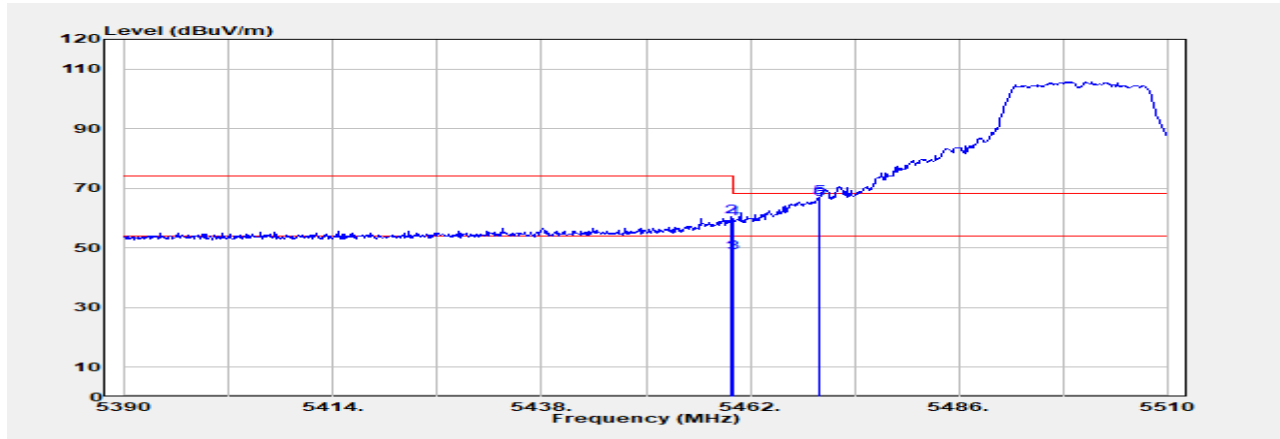

Freq. MHz	Detector Mode PK/QP/AVG	Spectrum Reading Level dBμV	Factor dB	Actual FS dBμV/m	Limit @3m dBμV/m	Margin dB
5459.840	Average	42.20	6.11	48.31	54.00	-5.69
5459.840	Peak	54.25	6.11	60.36	74.00	-13.64
5460.000	Average	42.32	6.11	48.43	54.00	-5.57
5460.000	Peak	53.75	6.11	59.86	74.00	-14.14
5469.920	Peak	60.77	6.20	66.97	68.20	-1.23
5470.000	Peak	60.16	6.21	66.37	68.20	-1.83

Unless otherwise stated the results shown in this test report refer only to the sample(s) tested and such sample(s) are retained for 90 days only.

除非另有說明，此報告結果僅對測試之樣品負責，同時此樣品僅保留90天。本報告未經本公司書面許可，不可部份複製。

This document is issued by the Company subject to its General Conditions of Service printed overleaf, available on request or accessible at <http://www.sgs.com.tw/Terms-and-Conditions> and for electronic format documents, subject to Terms and Conditions for Electronic Documents at <http://www.sgs.com.tw/Terms-and-Conditions>. Attention is drawn to the limitation of liability, indemnification and jurisdiction issues defined therein. Any holder of this document is advised that information contained hereon reflects the Company's findings at the time of its intervention only and within the limits of Client's instructions, if any. The Company's sole responsibility is to its Client and this document does not exonerate parties to a transaction from exercising all their rights and obligations under the transaction documents. This document cannot be reproduced except in full, without prior written approval of the Company. Any unauthorized alteration, forgery or falsification of the content or appearance of this document is unlawful and offenders may be prosecuted to the fullest extent of the law.

Report Number :TERF2403000759E2
 Operation Mode :802.11a
 Test Frequency :5700 MHz
 Test Mode :Bandedge
 EUT Pol :E2 Plane

Test Site :SAC G Chamber
 Test Date :2024-03-28
 Temp./Humi. :24.8°C/60%
 Antenna Pol. :Vertical
 Engineer :Temo Chen

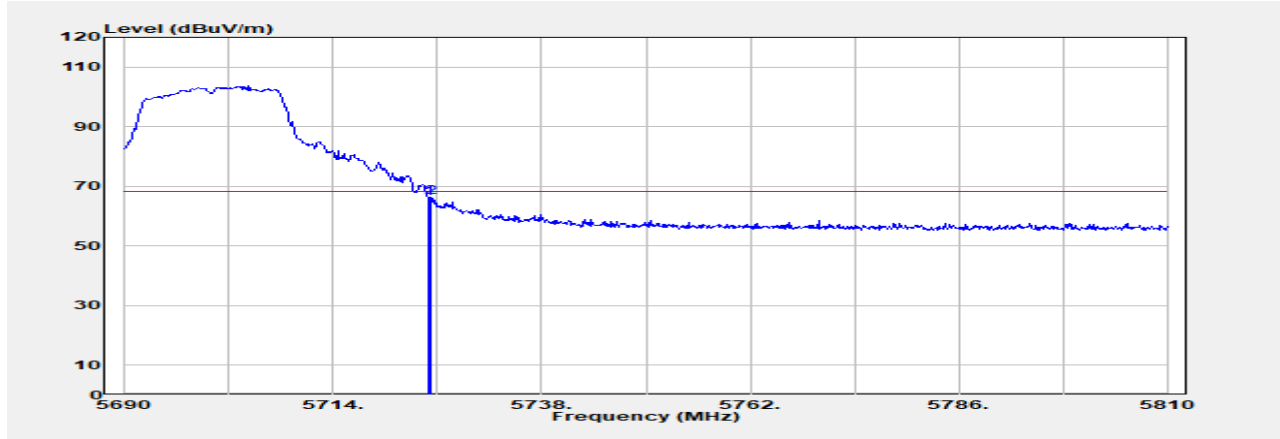

Freq. MHz	Detector Mode PK/QP/AVG	Spectrum Reading Level dB μ V	Factor dB	Actual FS dB μ V/m	Limit @3m dB μ V/m	Margin dB
5725.000	Peak	58.80	7.12	65.92	68.20	-2.28
5725.280	Peak	59.19	7.12	66.31	68.20	-1.89

Unless otherwise stated the results shown in this test report refer only to the sample(s) tested and such sample(s) are retained for 90 days only.

除非另有說明，此報告結果僅對測試之樣品負責，同時此樣品僅保留90天。本報告未經本公司書面許可，不可部份複製。

This document is issued by the Company subject to its General Conditions of Service printed overleaf, available on request or accessible at <http://www.sgs.com.tw/Terms-and-Conditions> and for electronic format documents, subject to Terms and Conditions for Electronic Documents at <http://www.sgs.com.tw/Terms-and-Conditions>. Attention is drawn to the limitation of liability, indemnification and jurisdiction issues defined therein. Any holder of this document is advised that information contained hereon reflects the Company's findings at the time of its intervention only and within the limits of Client's instructions, if any. The Company's sole responsibility is to its Client and this document does not exonerate parties to a transaction from exercising all their rights and obligations under the transaction documents. This document cannot be reproduced except in full, without prior written approval of the Company. Any unauthorized alteration, forgery or falsification of the content or appearance of this document is unlawful and offenders may be prosecuted to the fullest extent of the law.

Report Number :TERF2403000759E2
 Operation Mode :802.11a
 Test Frequency :5700 MHz
 Test Mode :Bandedge
 EUT Pol :E2 Plane

Test Site :SAC G Chamber
 Test Date :2024-03-28
 Temp./Humi. :24.8°C/60%
 Antenna Pol. :Horizontal
 Engineer :Temo Chen

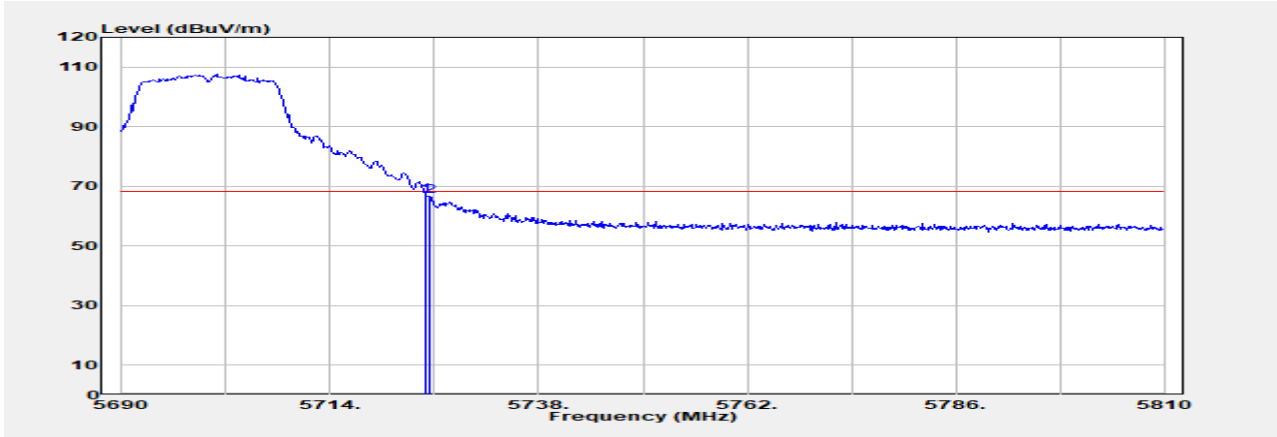

Freq. MHz	Detector Mode PK/QP/AVG	Spectrum Reading Level dB μ V	Factor dB	Actual FS dB μ V/m	Limit @3m dB μ V/m	Margin dB
5725.000	Peak	59.95	7.12	67.07	68.20	-1.13
5725.400	Peak	59.53	7.12	66.65	68.20	-1.55

Unless otherwise stated the results shown in this test report refer only to the sample(s) tested and such sample(s) are retained for 90 days only.

除非另有說明，此報告結果僅對測試之樣品負責，同時此樣品僅保留90天。本報告未經本公司書面許可，不可部份複製。

This document is issued by the Company subject to its General Conditions of Service printed overleaf, available on request or accessible at <http://www.sgs.com.tw/Terms-and-Conditions> and for electronic format documents, subject to Terms and Conditions for Electronic Documents at <http://www.sgs.com.tw/Terms-and-Conditions>. Attention is drawn to the limitation of liability, indemnification and jurisdiction issues defined therein. Any holder of this document is advised that information contained hereon reflects the Company's findings at the time of its intervention only and within the limits of Client's instructions, if any. The Company's sole responsibility is to its Client and this document does not exonerate parties to a transaction from exercising all their rights and obligations under the transaction documents. This document cannot be reproduced except in full, without prior written approval of the Company. Any unauthorized alteration, forgery or falsification of the content or appearance of this document is unlawful and offenders may be prosecuted to the fullest extent of the law.

Report Number :TERF2403000759E2
 Operation Mode :802.11a
 Test Frequency :5720 MHz
 Test Mode :Bandedge
 EUT Pol :E2 Plane

Test Site :SAC G Chamber
 Test Date :2024-03-28
 Temp./Humi. :24.8°C/60%
 Antenna Pol. :Vertical
 Engineer :Temo Chen

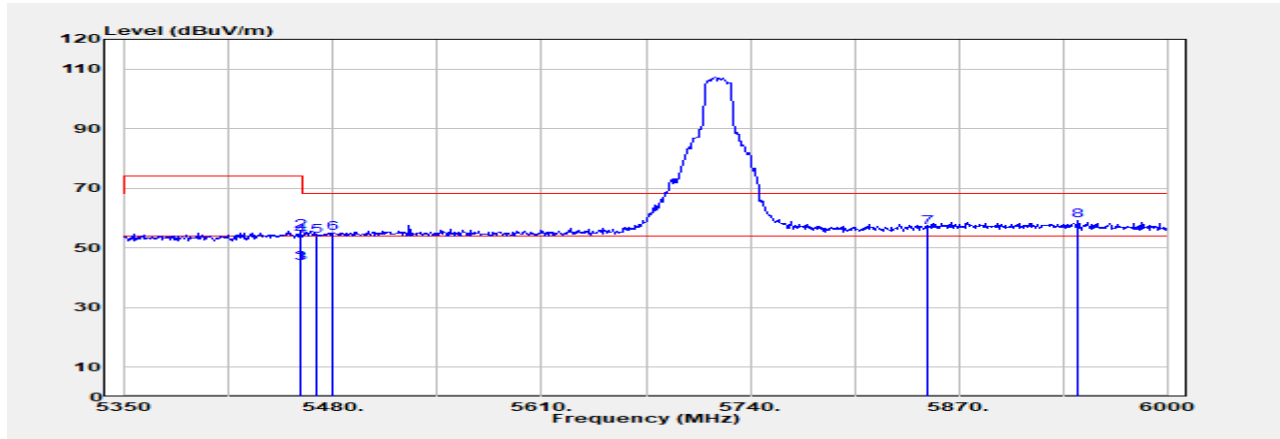

Freq. MHz	Detector Mode PK/QP/AVG	Spectrum Reading Level dBμV	Factor dB	Actual FS dBμV/m	Limit @3m dBμV/m	Margin dB
5459.200	Average	38.64	6.11	44.75	54.00	-9.25
5459.200	Peak	49.53	6.11	55.64	74.00	-18.36
5460.000	Average	38.83	6.11	44.94	54.00	-9.06
5460.000	Peak	47.78	6.11	53.90	74.00	-20.10
5470.000	Peak	47.71	6.21	53.91	68.20	-14.29
5480.000	Peak	48.63	6.30	54.92	68.20	-13.28
5850.000	Peak	48.98	8.01	56.99	68.20	-11.21
5944.750	Peak	50.69	8.64	59.34	68.20	-8.86

Unless otherwise stated the results shown in this test report refer only to the sample(s) tested and such sample(s) are retained for 90 days only.

除非另有說明，此報告結果僅對測試之樣品負責，同時此樣品僅保留90天。本報告未經本公司書面許可，不可部份複製。

This document is issued by the Company subject to its General Conditions of Service printed overleaf, available on request or accessible at <http://www.sgs.com.tw/Terms-and-Conditions> and for electronic format documents, subject to Terms and Conditions for Electronic Documents at <http://www.sgs.com.tw/Terms-and-Conditions>. Attention is drawn to the limitation of liability, indemnification and jurisdiction issues defined therein. Any holder of this document is advised that information contained hereon reflects the Company's findings at the time of its intervention only and within the limits of Client's instructions, if any. The Company's sole responsibility is to its Client and this document does not exonerate parties to a transaction from exercising all their rights and obligations under the transaction documents. This document cannot be reproduced except in full, without prior written approval of the Company. Any unauthorized alteration, forgery or falsification of the content or appearance of this document is unlawful and offenders may be prosecuted to the fullest extent of the law.

Report Number :TERF2403000759E2
 Operation Mode :802.11a
 Test Frequency :5720 MHz
 Test Mode :Bandedge
 EUT Pol :E2 Plane

Test Site :SAC G Chamber
 Test Date :2024-03-28
 Temp./Humi. :24.8°C/60%
 Antenna Pol. :Horizontal
 Engineer :Temo Chen

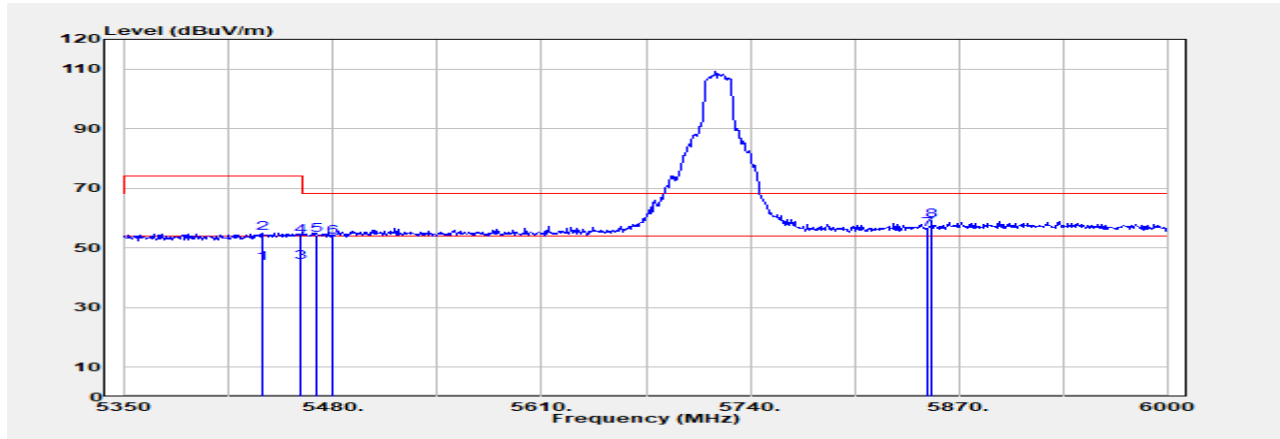

Freq. MHz	Detector Mode PK/QP/AVG	Spectrum Reading Level dBμV	Factor dB	Actual FS dBμV/m	Limit @3m dBμV/m	Margin dB
5435.150	Average	38.84	5.88	44.73	54.00	-9.27
5435.150	Peak	49.18	5.88	55.06	74.00	-18.94
5460.000	Average	38.97	6.11	45.08	54.00	-8.92
5460.000	Peak	47.87	6.11	53.98	74.00	-20.02
5470.000	Peak	48.20	6.21	54.40	68.20	-13.80
5480.000	Peak	47.28	6.30	53.57	68.20	-14.63
5850.000	Peak	48.40	8.01	56.40	68.20	-11.80
5853.100	Peak	51.26	8.06	59.32	68.20	-8.88

Unless otherwise stated the results shown in this test report refer only to the sample(s) tested and such sample(s) are retained for 90 days only.

除非另有說明，此報告結果僅對測試之樣品負責，同時此樣品僅保留90天。本報告未經本公司書面許可，不可部份複製。

This document is issued by the Company subject to its General Conditions of Service printed overleaf, available on request or accessible at <http://www.sgs.com.tw/Terms-and-Conditions> and for electronic format documents, subject to Terms and Conditions for Electronic Documents at <http://www.sgs.com.tw/Terms-and-Conditions>. Attention is drawn to the limitation of liability, indemnification and jurisdiction issues defined therein. Any holder of this document is advised that information contained hereon reflects the Company's findings at the time of its intervention only and within the limits of Client's instructions, if any. The Company's sole responsibility is to its Client and this document does not exonerate parties to a transaction from exercising all their rights and obligations under the transaction documents. This document cannot be reproduced except in full, without prior written approval of the Company. Any unauthorized alteration, forgery or falsification of the content or appearance of this document is unlawful and offenders may be prosecuted to the fullest extent of the law.

Report Number :TERF2403000759E2
 Operation Mode :802.11a
 Test Frequency :5745 MHz
 Test Mode :Bandedge
 EUT Pol :E2 Plane

Test Site :SAC G Chamber
 Test Date :2024-03-28
 Temp./Humi. :24.8°C/60%
 Antenna Pol. :Vertical
 Engineer :Temo Chen

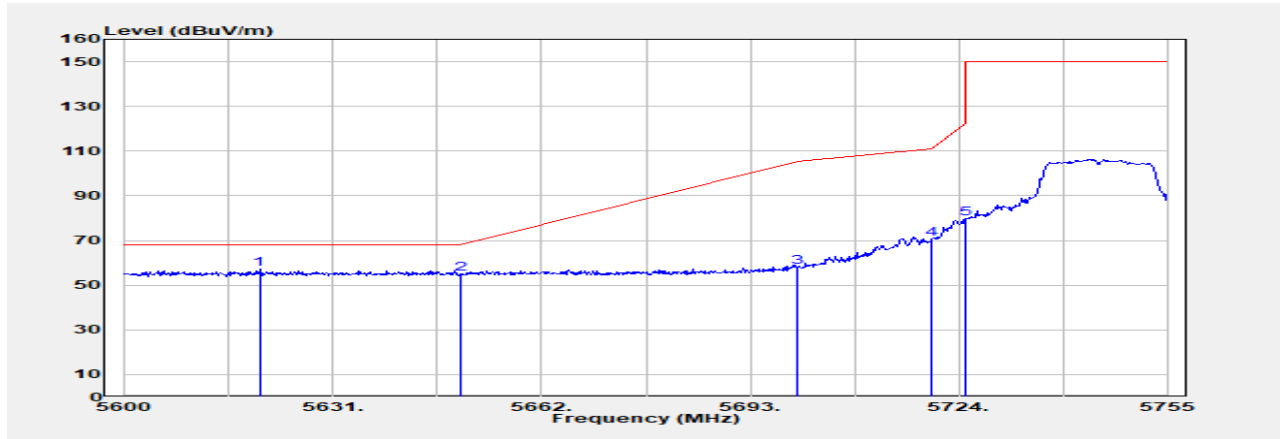

Freq. MHz	Detector Mode PK/QP/AVG	Spectrum Reading Level dBμV	Factor dB	Actual FS dBμV/m	Limit @3m dBμV/m	Margin dB
5619.995	Peak	50.83	6.21	57.04	68.20	-11.16
5650.000	Peak	48.54	6.43	54.97	68.20	-13.23
5700.000	Peak	50.96	6.99	57.95	105.20	-47.25
5720.000	Peak	63.43	7.09	70.53	110.80	-40.27
5725.000	Peak	72.76	7.12	79.88	122.20	-42.32

Unless otherwise stated the results shown in this test report refer only to the sample(s) tested and such sample(s) are retained for 90 days only.

除非另有說明，此報告結果僅對測試之樣品負責，同時此樣品僅保留90天。本報告未經本公司書面許可，不可部份複製。

This document is issued by the Company subject to its General Conditions of Service printed overleaf, available on request or accessible at <http://www.sgs.com.tw/Terms-and-Conditions> and for electronic format documents, subject to Terms and Conditions for Electronic Documents at <http://www.sgs.com.tw/Terms-and-Conditions>. Attention is drawn to the limitation of liability, indemnification and jurisdiction issues defined therein. Any holder of this document is advised that information contained hereon reflects the Company's findings at the time of its intervention only and within the limits of Client's instructions, if any. The Company's sole responsibility is to its Client and this document does not exonerate parties to a transaction from exercising all their rights and obligations under the transaction documents. This document cannot be reproduced except in full, without prior written approval of the Company. Any unauthorized alteration, forgery or falsification of the content or appearance of this document is unlawful and offenders may be prosecuted to the fullest extent of the law.

Report Number :TERF2403000759E2
 Operation Mode :802.11a
 Test Frequency :5745 MHz
 Test Mode :Bandedge
 EUT Pol :E2 Plane

Test Site :SAC G Chamber
 Test Date :2024-03-28
 Temp./Humi. :24.8°C/60%
 Antenna Pol. :Horizontal
 Engineer :Temo Chen

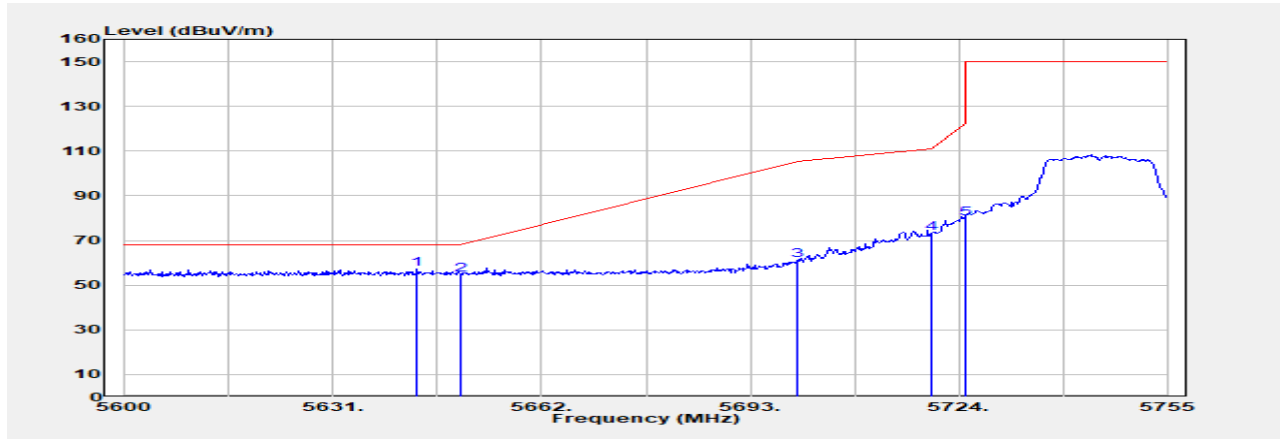

Freq. MHz	Detector Mode PK/QP/AVG	Spectrum Reading Level dB μ V	Factor dB	Actual FS dB μ V/m	Limit @3m dB μ V/m	Margin dB
5643.400	Peak	50.70	6.38	57.07	68.20	-11.13
5650.000	Peak	48.39	6.43	54.82	68.20	-13.38
5700.000	Peak	54.00	6.99	60.99	105.20	-44.21
5720.000	Peak	66.25	7.09	73.34	110.80	-37.46
5725.000	Peak	72.45	7.12	79.57	122.20	-42.63

Unless otherwise stated the results shown in this test report refer only to the sample(s) tested and such sample(s) are retained for 90 days only.

除非另有說明，此報告結果僅對測試之樣品負責，同時此樣品僅保留90天。本報告未經本公司書面許可，不可部份複製。

This document is issued by the Company subject to its General Conditions of Service printed overleaf, available on request or accessible at <http://www.sgs.com.tw/Terms-and-Conditions> and for electronic format documents, subject to Terms and Conditions for Electronic Documents at <http://www.sgs.com.tw/Terms-and-Conditions>. Attention is drawn to the limitation of liability, indemnification and jurisdiction issues defined therein. Any holder of this document is advised that information contained hereon reflects the Company's findings at the time of its intervention only and within the limits of Client's instructions, if any. The Company's sole responsibility is to its Client and this document does not exonerate parties to a transaction from exercising all their rights and obligations under the transaction documents. This document cannot be reproduced except in full, without prior written approval of the Company. Any unauthorized alteration, forgery or falsification of the content or appearance of this document is unlawful and offenders may be prosecuted to the fullest extent of the law.

Report Number :TERF2403000759E2
 Operation Mode :802.11a
 Test Frequency :5825 MHz
 Test Mode :Bandedge
 EUT Pol :E2 Plane

Test Site :SAC G Chamber
 Test Date :2024-03-28
 Temp./Humi. :24.8°C/60%
 Antenna Pol. :Vertical
 Engineer :Temo Chen

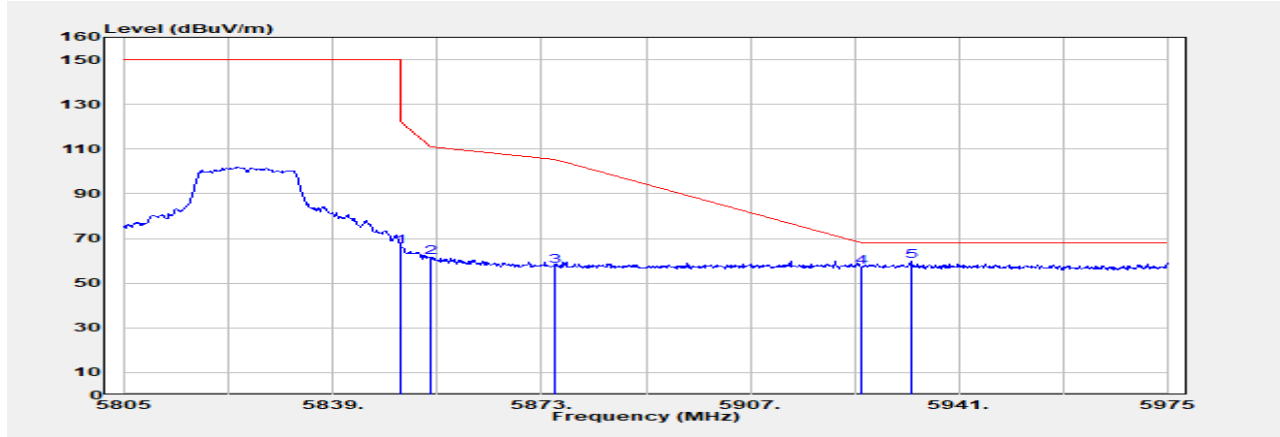

Freq. MHz	Detector Mode PK/QP/AVG	Spectrum Reading Level dBμV	Factor dB	Actual FS dBμV/m	Limit @3m dBμV/m	Margin dB
5850.000	Peak	58.15	8.01	66.16	122.20	-56.04
5855.000	Peak	53.66	8.09	61.75	110.80	-49.05
5875.000	Peak	49.29	8.41	57.70	105.20	-47.50
5925.000	Peak	48.60	8.72	57.31	68.20	-10.89
5933.180	Peak	51.10	8.69	59.79	68.20	-8.41

Unless otherwise stated the results shown in this test report refer only to the sample(s) tested and such sample(s) are retained for 90 days only.

除非另有說明，此報告結果僅對測試之樣品負責，同時此樣品僅保留90天。本報告未經本公司書面許可，不可部份複製。

This document is issued by the Company subject to its General Conditions of Service printed overleaf, available on request or accessible at <http://www.sgs.com.tw/Terms-and-Conditions> and for electronic format documents, subject to Terms and Conditions for Electronic Documents at <http://www.sgs.com.tw/Terms-and-Conditions>. Attention is drawn to the limitation of liability, indemnification and jurisdiction issues defined therein. Any holder of this document is advised that information contained hereon reflects the Company's findings at the time of its intervention only and within the limits of Client's instructions, if any. The Company's sole responsibility is to its Client and this document does not exonerate parties to a transaction from exercising all their rights and obligations under the transaction documents. This document cannot be reproduced except in full, without prior written approval of the Company. Any unauthorized alteration, forgery or falsification of the content or appearance of this document is unlawful and offenders may be prosecuted to the fullest extent of the law.

Report Number :TERF2403000759E2
 Operation Mode :802.11a
 Test Frequency :5825 MHz
 Test Mode :Bandedge
 EUT Pol :E2 Plane

Test Site :SAC G Chamber
 Test Date :2024-03-28
 Temp./Humi. :24.8°C/60%
 Antenna Pol. :Horizontal
 Engineer :Temo Chen

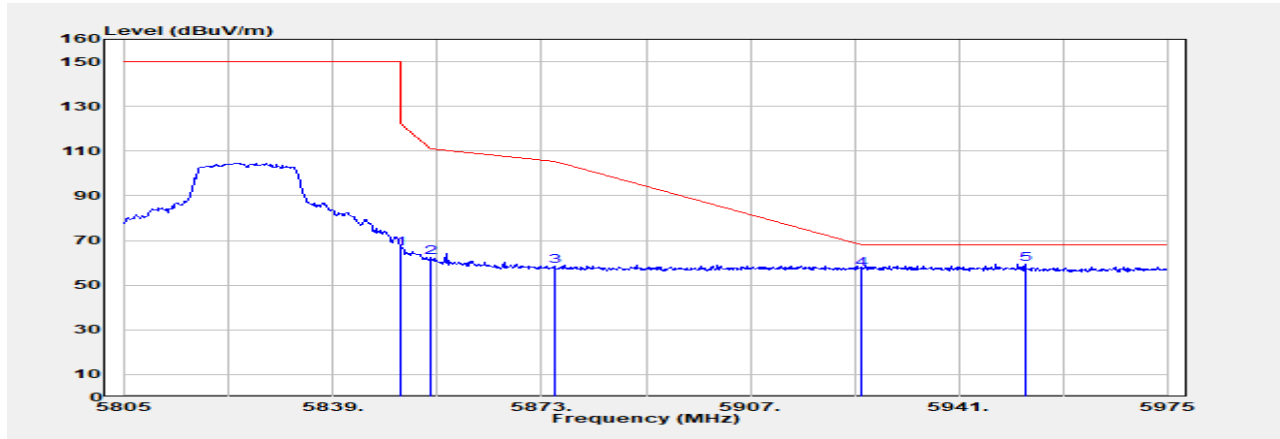

Freq. MHz	Detector Mode PK/QP/AVG	Spectrum Reading Level dBμV	Factor dB	Actual FS dBμV/m	Limit @3m dBμV/m	Margin dB
5850.000	Peak	58.48	8.01	66.49	122.20	-55.71
5855.000	Peak	54.17	8.09	62.26	110.80	-48.54
5875.000	Peak	49.98	8.41	58.39	105.20	-46.81
5925.000	Peak	48.63	8.72	57.35	68.20	-10.85
5951.880	Peak	50.91	8.61	59.52	68.20	-8.68

Unless otherwise stated the results shown in this test report refer only to the sample(s) tested and such sample(s) are retained for 90 days only.

除非另有說明，此報告結果僅對測試之樣品負責，同時此樣品僅保留90天。本報告未經本公司書面許可，不可部份複製。

This document is issued by the Company subject to its General Conditions of Service printed overleaf, available on request or accessible at <http://www.sgs.com.tw/Terms-and-Conditions> and for electronic format documents, subject to Terms and Conditions for Electronic Documents at <http://www.sgs.com.tw/Terms-and-Conditions>. Attention is drawn to the limitation of liability, indemnification and jurisdiction issues defined therein. Any holder of this document is advised that information contained hereon reflects the Company's findings at the time of its intervention only and within the limits of Client's instructions, if any. The Company's sole responsibility is to its Client and this document does not exonerate parties to a transaction from exercising all their rights and obligations under the transaction documents. This document cannot be reproduced except in full, without prior written approval of the Company. Any unauthorized alteration, forgery or falsification of the content or appearance of this document is unlawful and offenders may be prosecuted to the fullest extent of the law.

Report Number :TERF2403000759E2
 Operation Mode :802.11ac20
 Test Frequency :5180 MHz
 Test Mode :Bandedge
 EUT Pol :E2 Plane

Test Site :SAC G Chamber
 Test Date :2024-03-28
 Temp./Humi. :24.8°C/60%
 Antenna Pol. :Vertical
 Engineer :Temo Chen

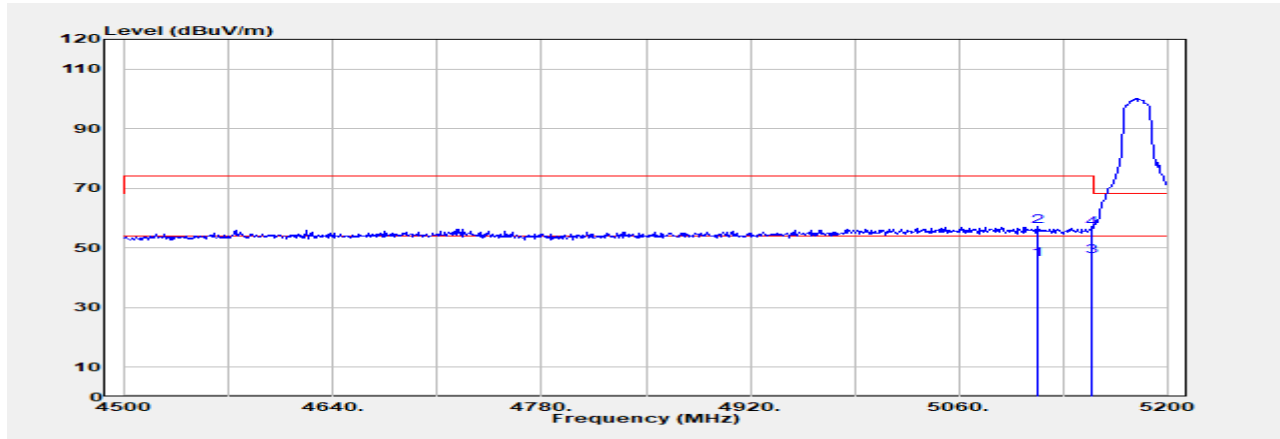

Freq. MHz	Detector Mode PK/QP/AVG	Spectrum Reading Level dBμV	Factor dB	Actual FS dBμV/m	Limit @3m dBμV/m	Margin dB
5113.200	Average	40.15	5.95	46.09	54.00	-7.91
5113.200	Peak	51.35	5.95	57.30	74.00	-16.70
5150.000	Average	41.39	5.72	47.12	54.00	-6.88
5150.000	Peak	50.76	5.72	56.49	74.00	-17.51

Unless otherwise stated the results shown in this test report refer only to the sample(s) tested and such sample(s) are retained for 90 days only.

除非另有說明，此報告結果僅對測試之樣品負責，同時此樣品僅保留90天。本報告未經本公司書面許可，不可部份複製。

This document is issued by the Company subject to its General Conditions of Service printed overleaf, available on request or accessible at <http://www.sgs.com.tw/Terms-and-Conditions> and for electronic format documents, subject to Terms and Conditions for Electronic Documents at <http://www.sgs.com.tw/Terms-and-Conditions>. Attention is drawn to the limitation of liability, indemnification and jurisdiction issues defined therein. Any holder of this document is advised that information contained hereon reflects the Company's findings at the time of its intervention only and within the limits of Client's instructions, if any. The Company's sole responsibility is to its Client and this document does not exonerate parties to a transaction from exercising all their rights and obligations under the transaction documents. This document cannot be reproduced except in full, without prior written approval of the Company. Any unauthorized alteration, forgery or falsification of the content or appearance of this document is unlawful and offenders may be prosecuted to the fullest extent of the law.

Report Number :TERF2403000759E2
 Operation Mode :802.11ac20
 Test Frequency :5180 MHz
 Test Mode :Bandedge
 EUT Pol :E2 Plane

Test Site :SAC G Chamber
 Test Date :2024-03-28
 Temp./Humi. :24.8°C/60%
 Antenna Pol. :Horizontal
 Engineer :Temo Chen

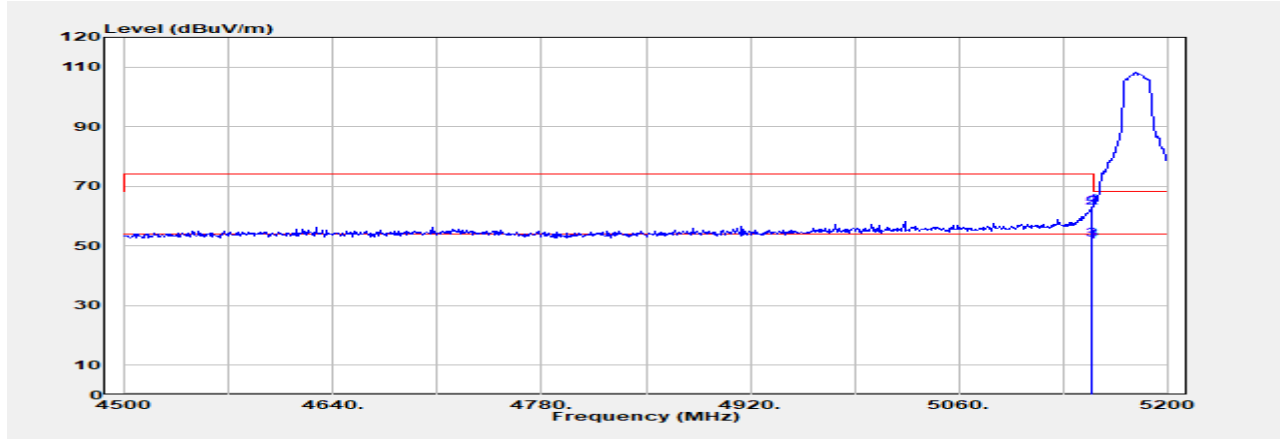

Freq. MHz	Detector Mode PK/QP/AVG	Spectrum Reading Level dB μ V	Factor dB	Actual FS dB μ V/m	Limit @3m dB μ V/m	Margin dB
5148.900	Average	45.59	5.73	51.32	54.00	-2.68
5148.900	Peak	57.13	5.73	62.86	74.00	-11.14
5150.000	Average	46.40	5.72	52.13	54.00	-1.87
5150.000	Peak	57.68	5.72	63.41	74.00	-10.59

Unless otherwise stated the results shown in this test report refer only to the sample(s) tested and such sample(s) are retained for 90 days only.

除非另有說明，此報告結果僅對測試之樣品負責，同時此樣品僅保留90天。本報告未經本公司書面許可，不可部份複製。

This document is issued by the Company subject to its General Conditions of Service printed overleaf, available on request or accessible at <http://www.sgs.com.tw/Terms-and-Conditions> and for electronic format documents, subject to Terms and Conditions for Electronic Documents at <http://www.sgs.com.tw/Terms-and-Conditions>. Attention is drawn to the limitation of liability, indemnification and jurisdiction issues defined therein. Any holder of this document is advised that information contained hereon reflects the Company's findings at the time of its intervention only and within the limits of Client's instructions, if any. The Company's sole responsibility is to its Client and this document does not exonerate parties to a transaction from exercising all their rights and obligations under the transaction documents. This document cannot be reproduced except in full, without prior written approval of the Company. Any unauthorized alteration, forgery or falsification of the content or appearance of this document is unlawful and offenders may be prosecuted to the fullest extent of the law.

Report Number :TERF2403000759E2
 Operation Mode :802.11ac20
 Test Frequency :5320 MHz
 Test Mode :Bandedge
 EUT Pol :E2 Plane

Test Site :SAC G Chamber
 Test Date :2024-03-28
 Temp./Humi. :24.8°C/60%
 Antenna Pol. :Vertical
 Engineer :Temo Chen

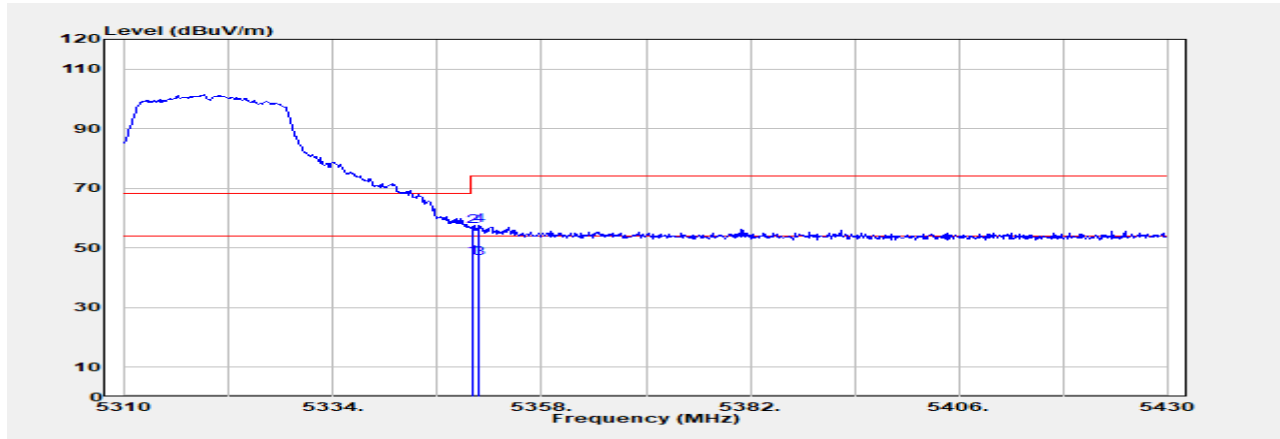

Freq. MHz	Detector Mode PK/QP/AVG	Spectrum Reading Level dBμV	Factor dB	Actual FS dBμV/m	Limit @3m dBμV/m	Margin dB
5350.000	Average	41.48	5.34	46.82	54.00	-7.18
5350.000	Peak	51.74	5.34	57.08	74.00	-16.92
5350.800	Average	41.24	5.34	46.58	54.00	-7.42
5350.800	Peak	52.32	5.34	57.66	74.00	-16.34

Unless otherwise stated the results shown in this test report refer only to the sample(s) tested and such sample(s) are retained for 90 days only.

除非另有說明，此報告結果僅對測試之樣品負責，同時此樣品僅保留90天。本報告未經本公司書面許可，不可部份複製。

This document is issued by the Company subject to its General Conditions of Service printed overleaf, available on request or accessible at <http://www.sgs.com.tw/Terms-and-Conditions> and for electronic format documents, subject to Terms and Conditions for Electronic Documents at <http://www.sgs.com.tw/Terms-and-Conditions>. Attention is drawn to the limitation of liability, indemnification and jurisdiction issues defined therein. Any holder of this document is advised that information contained hereon reflects the Company's findings at the time of its intervention only and within the limits of Client's instructions, if any. The Company's sole responsibility is to its Client and this document does not exonerate parties to a transaction from exercising all their rights and obligations under the transaction documents. This document cannot be reproduced except in full, without prior written approval of the Company. Any unauthorized alteration, forgery or falsification of the content or appearance of this document is unlawful and offenders may be prosecuted to the fullest extent of the law.

Report Number :TERF2403000759E2
 Operation Mode :802.11ac20
 Test Frequency :5320 MHz
 Test Mode :Bandedge
 EUT Pol :E2 Plane

Test Site :SAC G Chamber
 Test Date :2024-03-28
 Temp./Humi. :24.8°C/60%
 Antenna Pol. :Horizontal
 Engineer :Temo Chen

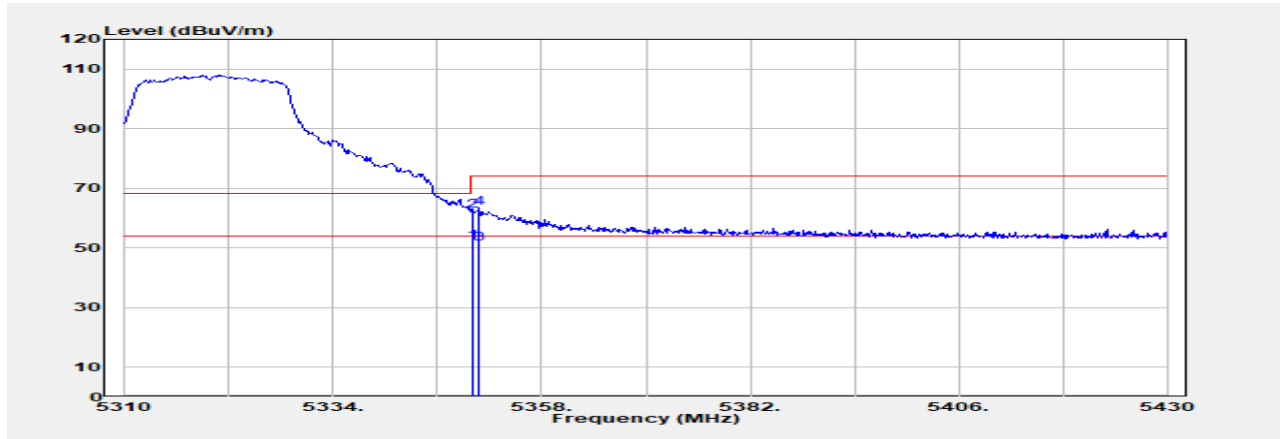

Freq. MHz	Detector Mode PK/QP/AVG	Spectrum Reading Level dB μ V	Factor dB	Actual FS dB μ V/m	Limit @3m dB μ V/m	Margin dB
5350.000	Average	46.81	5.34	52.15	54.00	-1.85
5350.000	Peak	57.14	5.34	62.48	74.00	-11.52
5350.800	Average	46.12	5.34	51.46	54.00	-2.54
5350.800	Peak	57.96	5.34	63.31	74.00	-10.69

Unless otherwise stated the results shown in this test report refer only to the sample(s) tested and such sample(s) are retained for 90 days only.

除非另有說明，此報告結果僅對測試之樣品負責，同時此樣品僅保留90天。本報告未經本公司書面許可，不可部份複製。

This document is issued by the Company subject to its General Conditions of Service printed overleaf, available on request or accessible at <http://www.sgs.com.tw/Terms-and-Conditions> and for electronic format documents, subject to Terms and Conditions for Electronic Documents at <http://www.sgs.com.tw/Terms-and-Conditions>. Attention is drawn to the limitation of liability, indemnification and jurisdiction issues defined therein. Any holder of this document is advised that information contained hereon reflects the Company's findings at the time of its intervention only and within the limits of Client's instructions, if any. The Company's sole responsibility is to its Client and this document does not exonerate parties to a transaction from exercising all their rights and obligations under the transaction documents. This document cannot be reproduced except in full, without prior written approval of the Company. Any unauthorized alteration, forgery or falsification of the content or appearance of this document is unlawful and offenders may be prosecuted to the fullest extent of the law.

Report Number :TERF2403000759E2
 Operation Mode :802.11ac20
 Test Frequency :5500 MHz
 Test Mode :Bandedge
 EUT Pol :E2 Plane

Test Site :SAC G Chamber
 Test Date :2024-03-28
 Temp./Humi. :24.8°C/60%
 Antenna Pol. :Vertical
 Engineer :Temo Chen

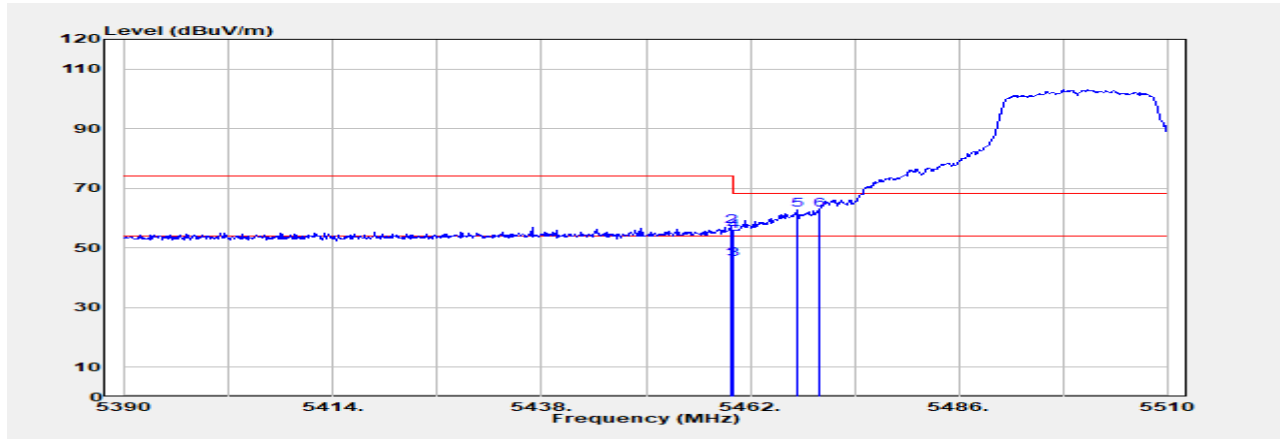

Freq. MHz	Detector Mode PK/QP/AVG	Spectrum Reading Level dBμV	Factor dB	Actual FS dBμV/m	Limit @3m dBμV/m	Margin dB
5459.720	Average	40.08	6.11	46.19	54.00	-7.81
5459.720	Peak	51.05	6.11	57.16	74.00	-16.84
5460.000	Average	40.17	6.11	46.29	54.00	-7.71
5460.000	Peak	49.34	6.11	55.45	74.00	-18.55
5467.520	Peak	56.55	6.18	62.74	68.20	-5.46
5470.000	Peak	56.52	6.21	62.72	68.20	-5.48

Unless otherwise stated the results shown in this test report refer only to the sample(s) tested and such sample(s) are retained for 90 days only.

除非另有說明，此報告結果僅對測試之樣品負責，同時此樣品僅保留90天。本報告未經本公司書面許可，不可部份複製。

This document is issued by the Company subject to its General Conditions of Service printed overleaf, available on request or accessible at <http://www.sgs.com.tw/Terms-and-Conditions> and for electronic format documents, subject to Terms and Conditions for Electronic Documents at <http://www.sgs.com.tw/Terms-and-Conditions>. Attention is drawn to the limitation of liability, indemnification and jurisdiction issues defined therein. Any holder of this document is advised that information contained hereon reflects the Company's findings at the time of its intervention only and within the limits of Client's instructions, if any. The Company's sole responsibility is to its Client and this document does not exonerate parties to a transaction from exercising all their rights and obligations under the transaction documents. This document cannot be reproduced except in full, without prior written approval of the Company. Any unauthorized alteration, forgery or falsification of the content or appearance of this document is unlawful and offenders may be prosecuted to the fullest extent of the law.

Report Number :TERF2403000759E2
 Operation Mode :802.11ac20
 Test Frequency :5500 MHz
 Test Mode :Bandedge
 EUT Pol :E2 Plane

Test Site :SAC G Chamber
 Test Date :2024-03-28
 Temp./Humi. :24.8°C/60%
 Antenna Pol. :Horizontal
 Engineer :Temo Chen

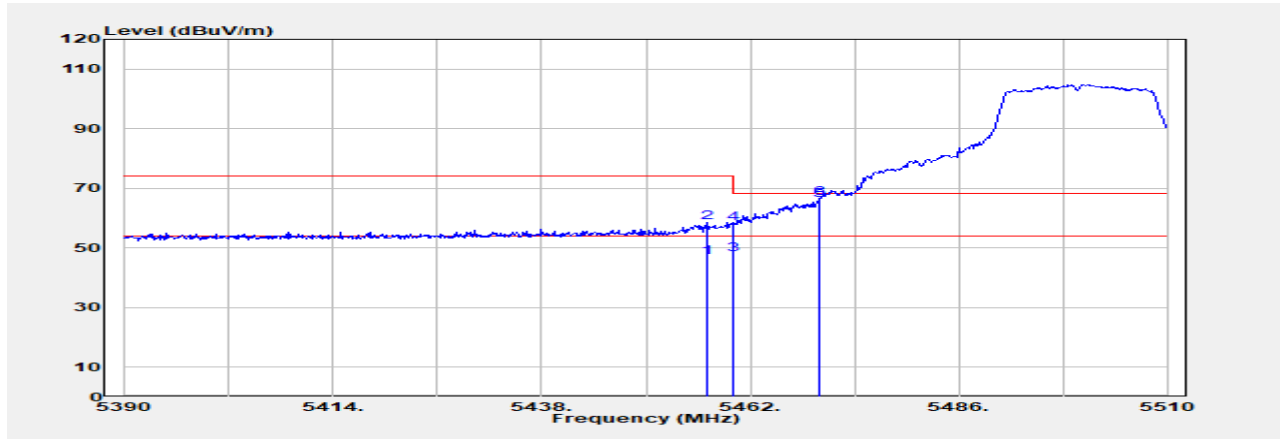

Freq. MHz	Detector Mode PK/QP/AVG	Spectrum Reading Level dB μ V	Factor dB	Actual FS dB μ V/m	Limit @3m dB μ V/m	Margin dB
5457.080	Average	40.67	6.09	46.75	54.00	-7.25
5457.080	Peak	52.39	6.09	58.48	74.00	-15.52
5460.000	Average	41.71	6.11	47.83	54.00	-6.17
5460.000	Peak	51.99	6.11	58.10	74.00	-15.90
5469.920	Peak	59.86	6.20	66.06	68.20	-2.14
5470.000	Peak	60.57	6.21	66.78	68.20	-1.42

Unless otherwise stated the results shown in this test report refer only to the sample(s) tested and such sample(s) are retained for 90 days only.

除非另有說明，此報告結果僅對測試之樣品負責，同時此樣品僅保留90天。本報告未經本公司書面許可，不可部份複製。

This document is issued by the Company subject to its General Conditions of Service printed overleaf, available on request or accessible at <http://www.sgs.com.tw/Terms-and-Conditions> and for electronic format documents, subject to Terms and Conditions for Electronic Documents at <http://www.sgs.com.tw/Terms-and-Conditions>. Attention is drawn to the limitation of liability, indemnification and jurisdiction issues defined therein. Any holder of this document is advised that information contained hereon reflects the Company's findings at the time of its intervention only and within the limits of Client's instructions, if any. The Company's sole responsibility is to its Client and this document does not exonerate parties to a transaction from exercising all their rights and obligations under the transaction documents. This document cannot be reproduced except in full, without prior written approval of the Company. Any unauthorized alteration, forgery or falsification of the content or appearance of this document is unlawful and offenders may be prosecuted to the fullest extent of the law.

Report Number :TERF2403000759E2
 Operation Mode :802.11ac20
 Test Frequency :5700 MHz
 Test Mode :Bandedge
 EUT Pol :E2 Plane

Test Site :SAC G Chamber
 Test Date :2024-03-28
 Temp./Humi. :24.8°C/60%
 Antenna Pol. :Vertical
 Engineer :Temo Chen

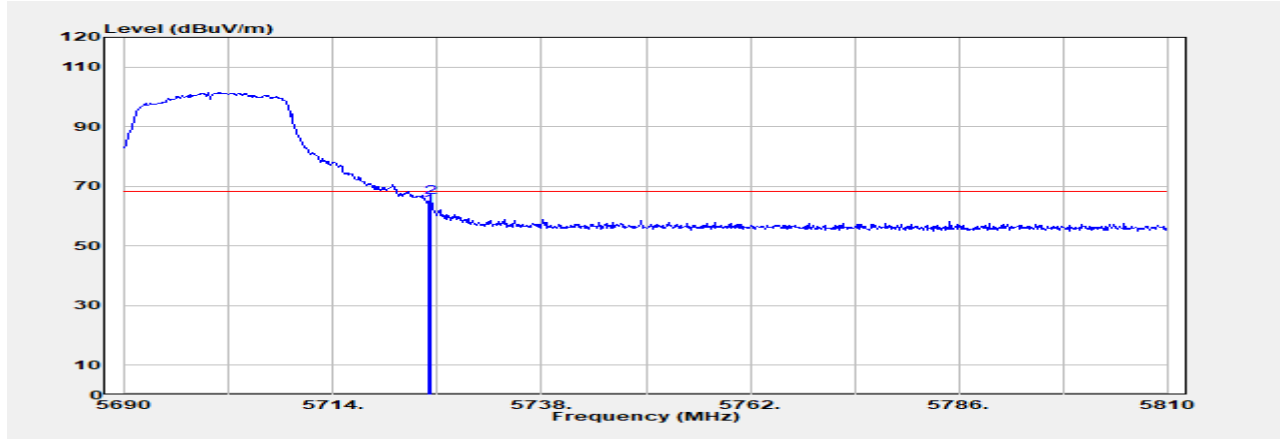

Freq. MHz	Detector Mode PK/QP/AVG	Spectrum Reading Level dB μ V	Factor dB	Actual FS dB μ V/m	Limit @3m dB μ V/m	Margin dB
5725.000	Peak	56.30	7.12	63.42	68.20	-4.78
5725.160	Peak	59.09	7.12	66.21	68.20	-1.99

Unless otherwise stated the results shown in this test report refer only to the sample(s) tested and such sample(s) are retained for 90 days only.

除非另有說明，此報告結果僅對測試之樣品負責，同時此樣品僅保留90天。本報告未經本公司書面許可，不可部份複製。

This document is issued by the Company subject to its General Conditions of Service printed overleaf, available on request or accessible at <http://www.sgs.com.tw/Terms-and-Conditions> and for electronic format documents, subject to Terms and Conditions for Electronic Documents at <http://www.sgs.com.tw/Terms-and-Conditions>. Attention is drawn to the limitation of liability, indemnification and jurisdiction issues defined therein. Any holder of this document is advised that information contained hereon reflects the Company's findings at the time of its intervention only and within the limits of Client's instructions, if any. The Company's sole responsibility is to its Client and this document does not exonerate parties to a transaction from exercising all their rights and obligations under the transaction documents. This document cannot be reproduced except in full, without prior written approval of the Company. Any unauthorized alteration, forgery or falsification of the content or appearance of this document is unlawful and offenders may be prosecuted to the fullest extent of the law.

Report Number :TERF2403000759E2
 Operation Mode :802.11ac20
 Test Frequency :5700 MHz
 Test Mode :Bandedge
 EUT Pol :E2 Plane

Test Site :SAC G Chamber
 Test Date :2024-03-28
 Temp./Humi. :24.8°C/60%
 Antenna Pol. :Horizontal
 Engineer :Temo Chen

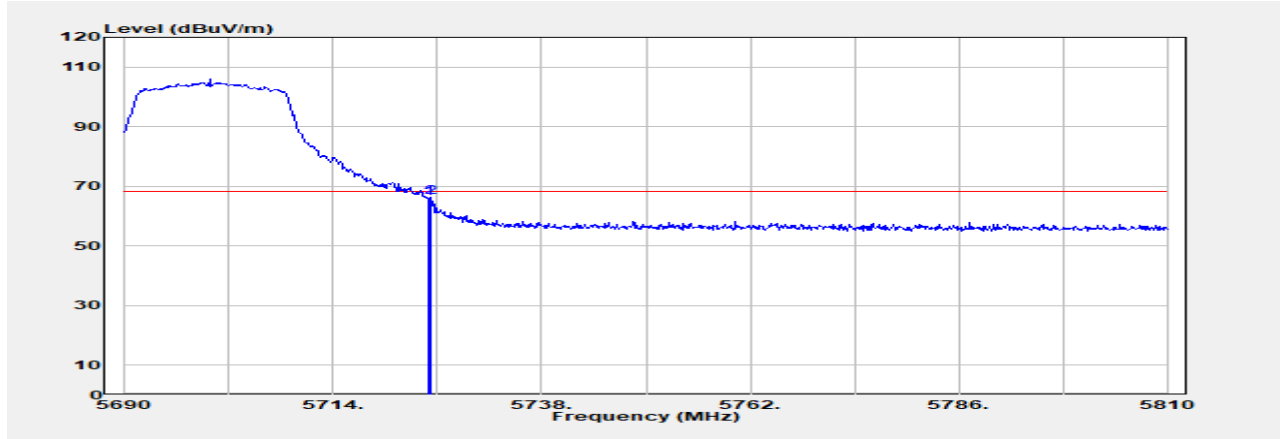

Freq. MHz	Detector Mode PK/QP/AVG	Spectrum Reading Level dB μ V	Factor dB	Actual FS dB μ V/m	Limit @3m dB μ V/m	Margin dB
5725.000	Peak	58.93	7.12	66.05	68.20	-2.15
5725.280	Peak	59.18	7.12	66.30	68.20	-1.90

Unless otherwise stated the results shown in this test report refer only to the sample(s) tested and such sample(s) are retained for 90 days only.

除非另有說明，此報告結果僅對測試之樣品負責，同時此樣品僅保留90天。本報告未經本公司書面許可，不可部份複製。

This document is issued by the Company subject to its General Conditions of Service printed overleaf, available on request or accessible at <http://www.sgs.com.tw/Terms-and-Conditions> and for electronic format documents, subject to Terms and Conditions for Electronic Documents at <http://www.sgs.com.tw/Terms-and-Conditions>. Attention is drawn to the limitation of liability, indemnification and jurisdiction issues defined therein. Any holder of this document is advised that information contained hereon reflects the Company's findings at the time of its intervention only and within the limits of Client's instructions, if any. The Company's sole responsibility is to its Client and this document does not exonerate parties to a transaction from exercising all their rights and obligations under the transaction documents. This document cannot be reproduced except in full, without prior written approval of the Company. Any unauthorized alteration, forgery or falsification of the content or appearance of this document is unlawful and offenders may be prosecuted to the fullest extent of the law.

Report Number :TERF2403000759E2
 Operation Mode :802.11ac20
 Test Frequency :5720 MHz
 Test Mode :Bandedge
 EUT Pol :E2 Plane

Test Site :SAC G Chamber
 Test Date :2024-03-28
 Temp./Humi. :24.8°C/60%
 Antenna Pol. :Vertical
 Engineer :Temo Chen

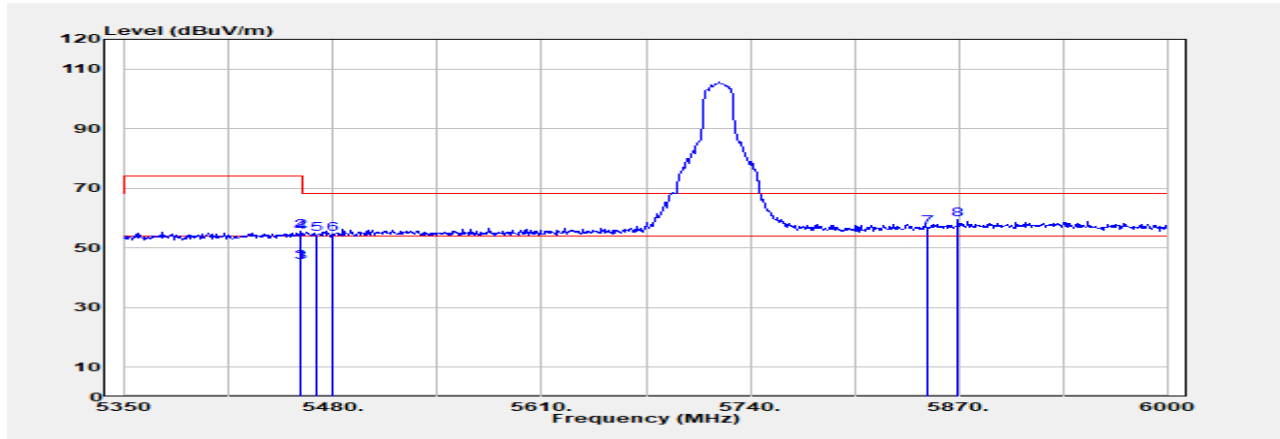

Freq. MHz	Detector Mode PK/QP/AVG	Spectrum Reading Level dBμV	Factor dB	Actual FS dBμV/m	Limit @3m dBμV/m	Margin dB
5459.200	Average	39.08	6.11	45.18	54.00	-8.82
5459.200	Peak	49.65	6.11	55.76	74.00	-18.24
5460.000	Average	39.03	6.11	45.14	54.00	-8.86
5460.000	Peak	49.09	6.11	55.20	74.00	-18.80
5470.000	Peak	48.49	6.21	54.69	68.20	-13.51
5480.000	Peak	48.37	6.30	54.67	68.20	-13.53
5850.000	Peak	49.02	8.01	57.02	68.20	-11.18
5869.350	Peak	51.25	8.32	59.57	68.20	-8.63

Unless otherwise stated the results shown in this test report refer only to the sample(s) tested and such sample(s) are retained for 90 days only.

除非另有說明，此報告結果僅對測試之樣品負責，同時此樣品僅保留90天。本報告未經本公司書面許可，不可部份複製。

This document is issued by the Company subject to its General Conditions of Service printed overleaf, available on request or accessible at <http://www.sgs.com.tw/Terms-and-Conditions> and for electronic format documents, subject to Terms and Conditions for Electronic Documents at <http://www.sgs.com.tw/Terms-and-Conditions>. Attention is drawn to the limitation of liability, indemnification and jurisdiction issues defined therein. Any holder of this document is advised that information contained hereon reflects the Company's findings at the time of its intervention only and within the limits of Client's instructions, if any. The Company's sole responsibility is to its Client and this document does not exonerate parties to a transaction from exercising all their rights and obligations under the transaction documents. This document cannot be reproduced except in full, without prior written approval of the Company. Any unauthorized alteration, forgery or falsification of the content or appearance of this document is unlawful and offenders may be prosecuted to the fullest extent of the law.

Report Number :TERF2403000759E2
 Operation Mode :802.11ac20
 Test Frequency :5720 MHz
 Test Mode :Bandedge
 EUT Pol :E2 Plane

Test Site :SAC G Chamber
 Test Date :2024-03-28
 Temp./Humi. :24.8°C/60%
 Antenna Pol. :Horizontal
 Engineer :Temo Chen

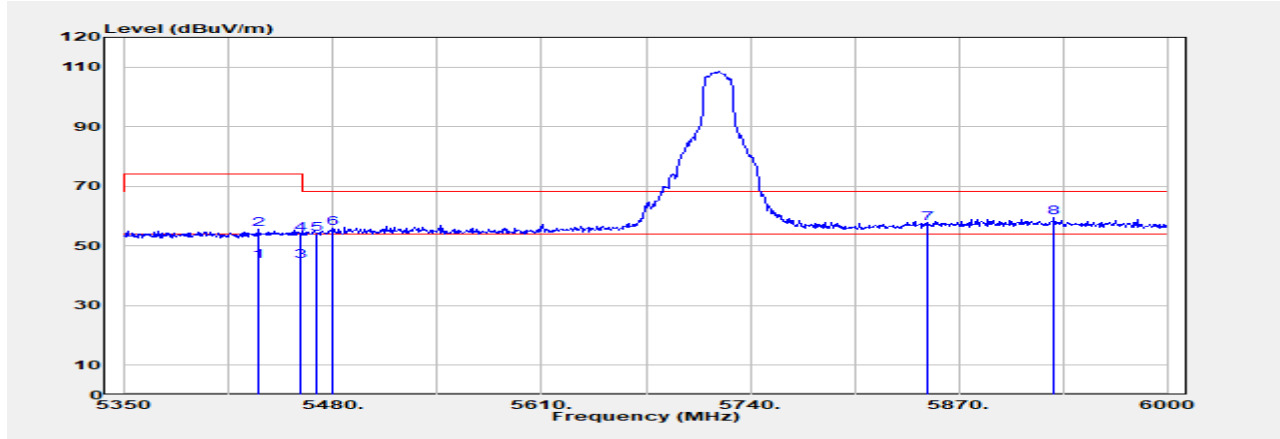

Freq. MHz	Detector Mode PK/QP/AVG	Spectrum Reading Level dBμV	Factor dB	Actual FS dBUV/m	Limit @3m dBUV/m	Margin dB
5433.200	Average	39.02	5.87	44.89	54.00	-9.11
5433.200	Peak	49.76	5.87	55.62	74.00	-18.38
5460.000	Average	38.92	6.11	45.04	54.00	-8.96
5460.000	Peak	47.96	6.11	54.07	74.00	-19.93
5470.000	Peak	47.94	6.21	54.14	68.20	-14.06
5480.000	Peak	49.49	6.30	55.79	68.20	-12.41
5850.000	Peak	49.52	8.01	57.53	68.20	-10.67
5929.800	Peak	50.81	8.70	59.51	68.20	-8.69

Unless otherwise stated the results shown in this test report refer only to the sample(s) tested and such sample(s) are retained for 90 days only.

除非另有說明，此報告結果僅對測試之樣品負責，同時此樣品僅保留90天。本報告未經本公司書面許可，不可部份複製。

This document is issued by the Company subject to its General Conditions of Service printed overleaf, available on request or accessible at <http://www.sgs.com.tw/Terms-and-Conditions> and for electronic format documents, subject to Terms and Conditions for Electronic Documents at <http://www.sgs.com.tw/Terms-and-Conditions>. Attention is drawn to the limitation of liability, indemnification and jurisdiction issues defined therein. Any holder of this document is advised that information contained hereon reflects the Company's findings at the time of its intervention only and within the limits of Client's instructions, if any. The Company's sole responsibility is to its Client and this document does not exonerate parties to a transaction from exercising all their rights and obligations under the transaction documents. This document cannot be reproduced except in full, without prior written approval of the Company. Any unauthorized alteration, forgery or falsification of the content or appearance of this document is unlawful and offenders may be prosecuted to the fullest extent of the law.

Report Number :TERF2403000759E2
 Operation Mode :802.11ac20
 Test Frequency :5745 MHz
 Test Mode :Bandedge
 EUT Pol :E2 Plane

Test Site :SAC G Chamber
 Test Date :2024-03-28
 Temp./Humi. :24.8°C/60%
 Antenna Pol. :Vertical
 Engineer :Temo Chen

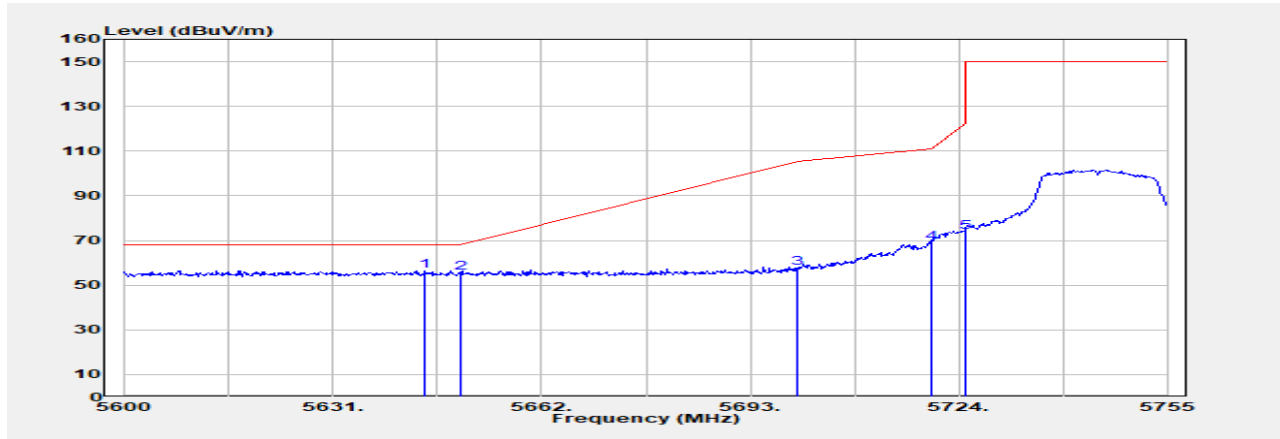

Freq. MHz	Detector Mode PK/QP/AVG	Spectrum Reading Level dB μ V	Factor dB	Actual FS dB μ V/m	Limit @3m dB μ V/m	Margin dB
5644.640	Peak	50.17	6.39	56.56	68.20	-11.64
5650.000	Peak	48.99	6.43	55.42	68.20	-12.78
5700.000	Peak	50.48	6.99	57.47	105.20	-47.73
5720.000	Peak	61.99	7.09	69.08	110.80	-41.72
5725.000	Peak	66.61	7.12	73.73	122.20	-48.47

Unless otherwise stated the results shown in this test report refer only to the sample(s) tested and such sample(s) are retained for 90 days only.

除非另有說明，此報告結果僅對測試之樣品負責，同時此樣品僅保留90天。本報告未經本公司書面許可，不可部份複製。

This document is issued by the Company subject to its General Conditions of Service printed overleaf, available on request or accessible at <http://www.sgs.com.tw/Terms-and-Conditions> and for electronic format documents, subject to Terms and Conditions for Electronic Documents at <http://www.sgs.com.tw/Terms-and-Conditions>. Attention is drawn to the limitation of liability, indemnification and jurisdiction issues defined therein. Any holder of this document is advised that information contained hereon reflects the Company's findings at the time of its intervention only and within the limits of Client's instructions, if any. The Company's sole responsibility is to its Client and this document does not exonerate parties to a transaction from exercising all their rights and obligations under the transaction documents. This document cannot be reproduced except in full, without prior written approval of the Company. Any unauthorized alteration, forgery or falsification of the content or appearance of this document is unlawful and offenders may be prosecuted to the fullest extent of the law.

Report Number :TERF2403000759E2
 Operation Mode :802.11ac20
 Test Frequency :5745 MHz
 Test Mode :Bandedge
 EUT Pol :E2 Plane

Test Site :SAC G Chamber
 Test Date :2024-03-28
 Temp./Humi. :24.8°C/60%
 Antenna Pol. :Horizontal
 Engineer :Temo Chen

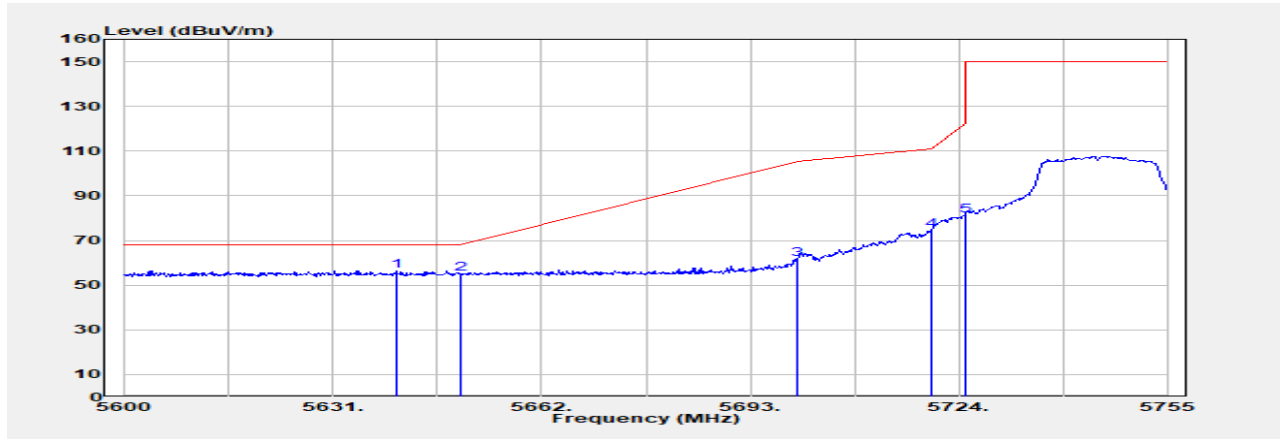

Freq. MHz	Detector Mode PK/QP/AVG	Spectrum Reading Level dBμV	Factor dB	Actual FS dBμV/m	Limit @3m dBμV/m	Margin dB
5640.300	Peak	50.15	6.36	56.51	68.20	-11.69
5650.000	Peak	48.81	6.43	55.24	68.20	-12.96
5700.000	Peak	54.79	6.99	61.78	105.20	-43.42
5720.000	Peak	67.48	7.09	74.57	110.80	-36.23
5725.000	Peak	73.89	7.12	81.01	122.20	-41.19

Unless otherwise stated the results shown in this test report refer only to the sample(s) tested and such sample(s) are retained for 90 days only.

除非另有說明，此報告結果僅對測試之樣品負責，同時此樣品僅保留90天。本報告未經本公司書面許可，不可部份複製。

This document is issued by the Company subject to its General Conditions of Service printed overleaf, available on request or accessible at <http://www.sgs.com.tw/Terms-and-Conditions> and for electronic format documents, subject to Terms and Conditions for Electronic Documents at <http://www.sgs.com.tw/Terms-and-Conditions>. Attention is drawn to the limitation of liability, indemnification and jurisdiction issues defined therein. Any holder of this document is advised that information contained hereon reflects the Company's findings at the time of its intervention only and within the limits of Client's instructions, if any. The Company's sole responsibility is to its Client and this document does not exonerate parties to a transaction from exercising all their rights and obligations under the transaction documents. This document cannot be reproduced except in full, without prior written approval of the Company. Any unauthorized alteration, forgery or falsification of the content or appearance of this document is unlawful and offenders may be prosecuted to the fullest extent of the law.

Report Number :TERF2403000759E2

Test Site :SAC G Chamber

Operation Mode :802.11ac20

Test Date :2024-03-28

Test Frequency :5825 MHz

Temp./Humi. :24.8°C/60%

Test Mode :Bandedge

Antenna Pol. :Vertical

EUT Pol :E2 Plane

Engineer :Temo Chen

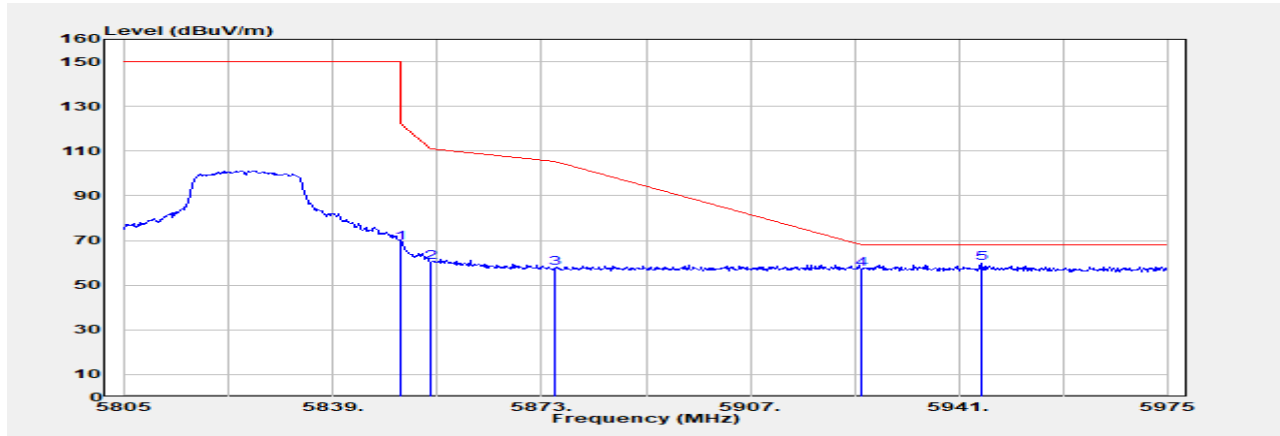

Freq. MHz	Detector Mode PK/QP/AVG	Spectrum Reading Level dB μ V	Factor dB	Actual FS dB μ V/m	Limit @3m dB μ V/m	Margin dB
5850.000	Peak	61.00	8.01	69.01	122.20	-53.19
5855.000	Peak	52.32	8.09	60.41	110.80	-50.39
5875.000	Peak	49.29	8.41	57.70	105.20	-47.50
5925.000	Peak	48.69	8.72	57.41	68.20	-10.79
5944.740	Peak	51.00	8.64	59.65	68.20	-8.55

Unless otherwise stated the results shown in this test report refer only to the sample(s) tested and such sample(s) are retained for 90 days only.

除非另有說明，此報告結果僅對測試之樣品負責，同時此樣品僅保留90天。本報告未經本公司書面許可，不可部份複製。

This document is issued by the Company subject to its General Conditions of Service printed overleaf, available on request or accessible at <http://www.sgs.com.tw/Terms-and-Conditions> and for electronic format documents, subject to Terms and Conditions for Electronic Documents at <http://www.sgs.com.tw/Terms-and-Conditions>. Attention is drawn to the limitation of liability, indemnification and jurisdiction issues defined therein. Any holder of this document is advised that information contained hereon reflects the Company's findings at the time of its intervention only and within the limits of Client's instructions, if any. The Company's sole responsibility is to its Client and this document does not exonerate parties to a transaction from exercising all their rights and obligations under the transaction documents. This document cannot be reproduced except in full, without prior written approval of the Company. Any unauthorized alteration, forgery or falsification of the content or appearance of this document is unlawful and offenders may be prosecuted to the fullest extent of the law.

Report Number :TERF2403000759E2
 Operation Mode :802.11ac20
 Test Frequency :5825 MHz
 Test Mode :Bandedge
 EUT Pol :E2 Plane

Test Site :SAC G Chamber
 Test Date :2024-03-28
 Temp./Humi. :24.8°C/60%
 Antenna Pol. :Horizontal
 Engineer :Temo Chen

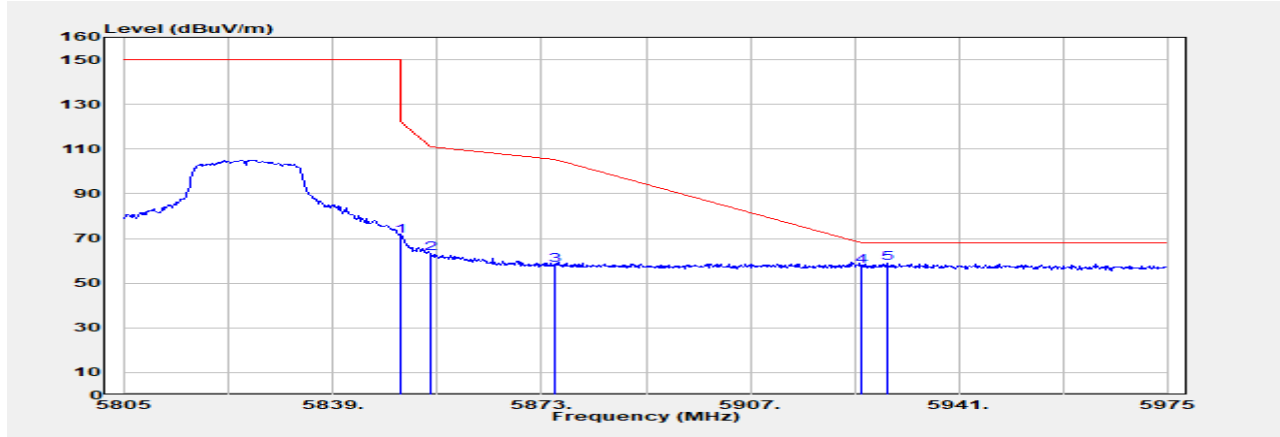

Freq. MHz	Detector Mode PK/QP/AVG	Spectrum Reading Level dB μ V	Factor dB	Actual FS dB μ V/m	Limit @3m dB μ V/m	Margin dB
5850.000	Peak	63.25	8.01	71.26	122.20	-50.94
5855.000	Peak	55.11	8.09	63.20	110.80	-47.60
5875.000	Peak	49.48	8.41	57.89	105.20	-47.31
5925.000	Peak	48.97	8.72	57.69	68.20	-10.51
5929.440	Peak	50.10	8.70	58.80	68.20	-9.40

Unless otherwise stated the results shown in this test report refer only to the sample(s) tested and such sample(s) are retained for 90 days only.

除非另有說明，此報告結果僅對測試之樣品負責，同時此樣品僅保留90天。本報告未經本公司書面許可，不可部份複製。

This document is issued by the Company subject to its General Conditions of Service printed overleaf, available on request or accessible at <http://www.sgs.com.tw/Terms-and-Conditions> and for electronic format documents, subject to Terms and Conditions for Electronic Documents at <http://www.sgs.com.tw/Terms-and-Conditions>. Attention is drawn to the limitation of liability, indemnification and jurisdiction issues defined therein. Any holder of this document is advised that information contained hereon reflects the Company's findings at the time of its intervention only and within the limits of Client's instructions, if any. The Company's sole responsibility is to its Client and this document does not exonerate parties to a transaction from exercising all their rights and obligations under the transaction documents. This document cannot be reproduced except in full, without prior written approval of the Company. Any unauthorized alteration, forgery or falsification of the content or appearance of this document is unlawful and offenders may be prosecuted to the fullest extent of the law.

Report Number :TERF2403000759E2
 Operation Mode :802.11ac40
 Test Frequency :5190 MHz
 Test Mode :Bandedge
 EUT Pol :E2 Plane

Test Site :SAC G Chamber
 Test Date :2024-03-28
 Temp./Humi. :24.8°C/60%
 Antenna Pol. :Vertical
 Engineer :Temo Chen

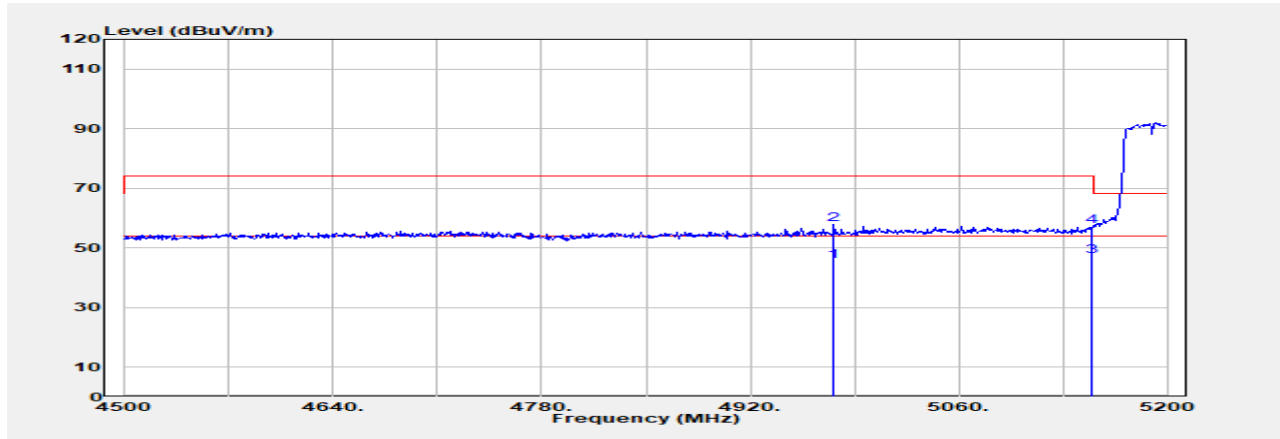

Freq. MHz	Detector Mode PK/QP/AVG	Spectrum Reading Level dBμV	Factor dB	Actual FS dBμV/m	Limit @3m dBμV/m	Margin dB
4976.000	Average	39.84	5.68	45.52	54.00	-8.48
4976.000	Peak	52.24	5.68	57.92	74.00	-16.08
5150.000	Average	41.38	5.72	47.11	54.00	-6.89
5150.000	Peak	51.47	5.72	57.19	74.00	-16.81

Unless otherwise stated the results shown in this test report refer only to the sample(s) tested and such sample(s) are retained for 90 days only.

除非另有說明，此報告結果僅對測試之樣品負責，同時此樣品僅保留90天。本報告未經本公司書面許可，不可部份複製。

This document is issued by the Company subject to its General Conditions of Service printed overleaf, available on request or accessible at <http://www.sgs.com.tw/Terms-and-Conditions> and for electronic format documents, subject to Terms and Conditions for Electronic Documents at <http://www.sgs.com.tw/Terms-and-Conditions>. Attention is drawn to the limitation of liability, indemnification and jurisdiction issues defined therein. Any holder of this document is advised that information contained hereon reflects the Company's findings at the time of its intervention only and within the limits of Client's instructions, if any. The Company's sole responsibility is to its Client and this document does not exonerate parties to a transaction from exercising all their rights and obligations under the transaction documents. This document cannot be reproduced except in full, without prior written approval of the Company. Any unauthorized alteration, forgery or falsification of the content or appearance of this document is unlawful and offenders may be prosecuted to the fullest extent of the law.

Report Number :TERF2403000759E2
 Operation Mode :802.11ac40
 Test Frequency :5190 MHz
 Test Mode :Bandedge
 EUT Pol :E2 Plane

Test Site :SAC G Chamber
 Test Date :2024-03-28
 Temp./Humi. :24.8°C/60%
 Antenna Pol. :Horizontal
 Engineer :Temo Chen

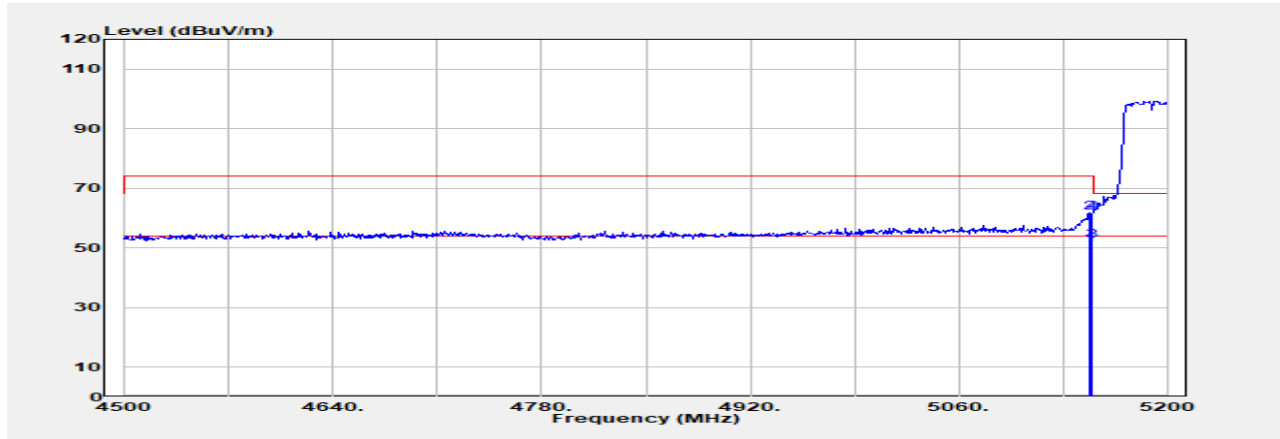

Freq. MHz	Detector Mode PK/QP/AVG	Spectrum Reading Level dB μ V	Factor dB	Actual FS dB μ V/m	Limit @3m dB μ V/m	Margin dB
5147.500	Average	45.21	5.74	50.95	54.00	-3.05
5147.500	Peak	56.08	5.74	61.82	74.00	-12.18
5150.000	Average	46.66	5.72	52.38	54.00	-1.62
5150.000	Peak	56.21	5.72	61.93	74.00	-12.07

Unless otherwise stated the results shown in this test report refer only to the sample(s) tested and such sample(s) are retained for 90 days only.

除非另有說明，此報告結果僅對測試之樣品負責，同時此樣品僅保留90天。本報告未經本公司書面許可，不可部份複製。

This document is issued by the Company subject to its General Conditions of Service printed overleaf, available on request or accessible at <http://www.sgs.com.tw/Terms-and-Conditions> and for electronic format documents, subject to Terms and Conditions for Electronic Documents at <http://www.sgs.com.tw/Terms-and-Conditions>. Attention is drawn to the limitation of liability, indemnification and jurisdiction issues defined therein. Any holder of this document is advised that information contained hereon reflects the Company's findings at the time of its intervention only and within the limits of Client's instructions, if any. The Company's sole responsibility is to its Client and this document does not exonerate parties to a transaction from exercising all their rights and obligations under the transaction documents. This document cannot be reproduced except in full, without prior written approval of the Company. Any unauthorized alteration, forgery or falsification of the content or appearance of this document is unlawful and offenders may be prosecuted to the fullest extent of the law.

Report Number :TERF2403000759E2
 Operation Mode :802.11ac40
 Test Frequency :5310 MHz
 Test Mode :Bandedge
 EUT Pol :E2 Plane

Test Site :SAC G Chamber
 Test Date :2024-03-29
 Temp./Humi. :24.3°C/58%
 Antenna Pol. :Vertical
 Engineer :Temo Chen

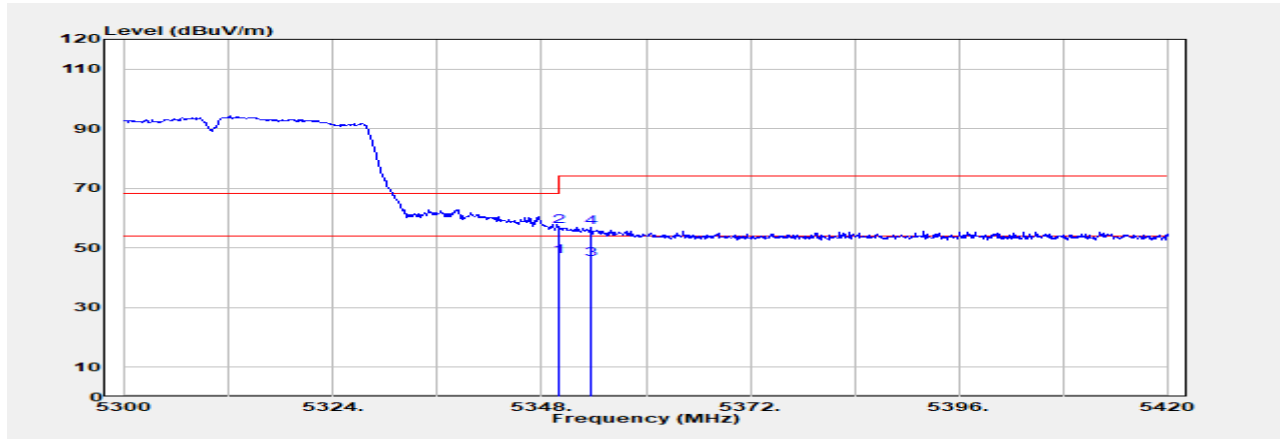

Freq. MHz	Detector Mode PK/QP/AVG	Spectrum Reading Level dBμV	Factor dB	Actual FS dBμV/m	Limit @3m dBμV/m	Margin dB
5350.000	Average	41.96	5.34	47.30	54.00	-6.70
5350.000	Peak	51.79	5.34	57.13	74.00	-16.87
5353.640	Average	40.67	5.36	46.02	54.00	-7.98
5353.640	Peak	51.48	5.36	56.84	74.00	-17.16

Unless otherwise stated the results shown in this test report refer only to the sample(s) tested and such sample(s) are retained for 90 days only.

除非另有說明，此報告結果僅對測試之樣品負責，同時此樣品僅保留90天。本報告未經本公司書面許可，不可部份複製。

This document is issued by the Company subject to its General Conditions of Service printed overleaf, available on request or accessible at <http://www.sgs.com.tw/Terms-and-Conditions> and for electronic format documents, subject to Terms and Conditions for Electronic Documents at <http://www.sgs.com.tw/Terms-and-Conditions>. Attention is drawn to the limitation of liability, indemnification and jurisdiction issues defined therein. Any holder of this document is advised that information contained hereon reflects the Company's findings at the time of its intervention only and within the limits of Client's instructions, if any. The Company's sole responsibility is to its Client and this document does not exonerate parties to a transaction from exercising all their rights and obligations under the transaction documents. This document cannot be reproduced except in full, without prior written approval of the Company. Any unauthorized alteration, forgery or falsification of the content or appearance of this document is unlawful and offenders may be prosecuted to the fullest extent of the law.

Report Number	:TERF2403000759E2	Test Site	:SAC G Chamber
Operation Mode	:802.11ac40	Test Date	:2024-03-29
Test Frequency	:5310 MHz	Temp./Humi.	:24.3°C/58%
Test Mode	:Bandedge	Antenna Pol.	:Horizontal
EUT Pol	:E2 Plane	Engineer	:Temo Chen

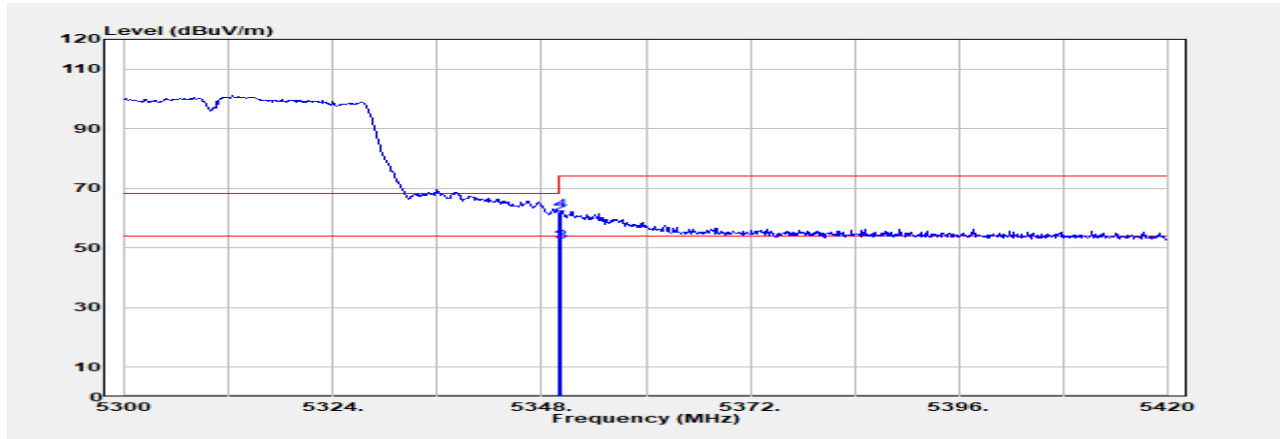

Freq. MHz	Detector Mode PK/QP/AVG	Spectrum Reading Level dBμV	Factor dB	Actual FS dBμV/m	Limit @3m dBμV/m	Margin dB
5350.000	Average	46.85	5.34	52.19	54.00	-1.81
5350.000	Peak	55.96	5.34	61.30	74.00	-12.70
5350.280	Average	46.59	5.34	51.93	54.00	-2.07
5350.280	Peak	56.95	5.34	62.30	74.00	-11.70

Unless otherwise stated the results shown in this test report refer only to the sample(s) tested and such sample(s) are retained for 90 days only.

除非另有說明，此報告結果僅對測試之樣品負責，同時此樣品僅保留90天。本報告未經本公司書面許可，不可部份複製。

This document is issued by the Company subject to its General Conditions of Service printed overleaf, available on request or accessible at <http://www.sgs.com.tw/Terms-and-Conditions> and for electronic format documents, subject to Terms and Conditions for Electronic Documents at <http://www.sgs.com.tw/Terms-and-Conditions>. Attention is drawn to the limitation of liability, indemnification and jurisdiction issues defined therein. Any holder of this document is advised that information contained hereon reflects the Company's findings at the time of its intervention only and within the limits of Client's instructions, if any. The Company's sole responsibility is to its Client and this document does not exonerate parties to a transaction from exercising all their rights and obligations under the transaction documents. This document cannot be reproduced except in full, without prior written approval of the Company. Any unauthorized alteration, forgery or falsification of the content or appearance of this document is unlawful and offenders may be prosecuted to the fullest extent of the law.

Report Number :TERF2403000759E2
 Operation Mode :802.11ac40
 Test Frequency :5510 MHz
 Test Mode :Bandedge
 EUT Pol :E2 Plane

Test Site :SAC G Chamber
 Test Date :2024-03-29
 Temp./Humi. :24.3°C/58%
 Antenna Pol. :Vertical
 Engineer :Temo Chen

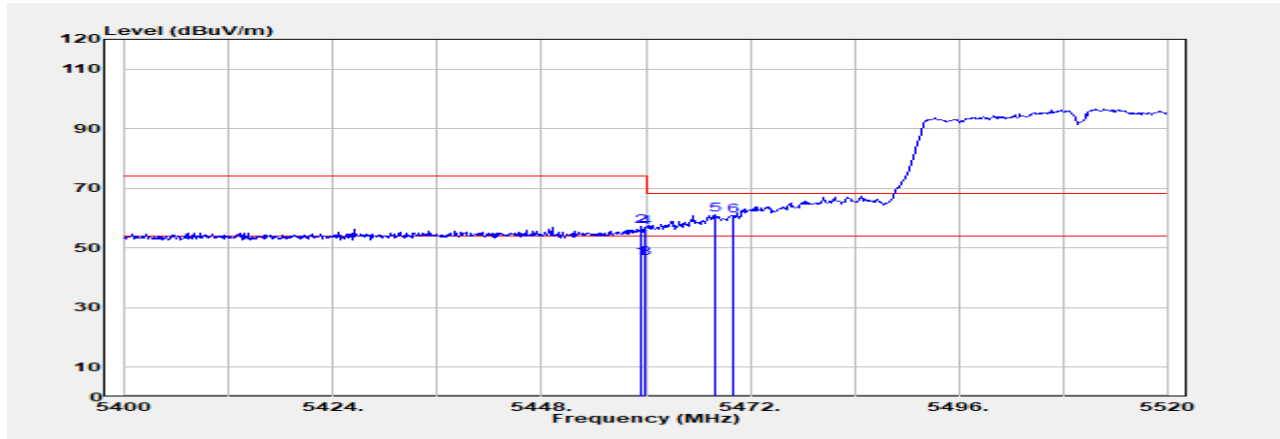

Freq. MHz	Detector Mode PK/QP/AVG	Spectrum Reading Level dB μ V	Factor dB	Actual FS dB μ V/m	Limit @3m dB μ V/m	Margin dB
5459.520	Average	40.26	6.11	46.36	54.00	-7.64
5459.520	Peak	51.12	6.11	57.23	74.00	-16.77
5460.000	Average	40.31	6.11	46.43	54.00	-7.57
5460.000	Peak	50.69	6.11	56.80	74.00	-17.20
5468.040	Peak	54.81	6.19	61.00	68.20	-7.20
5470.000	Peak	54.75	6.21	60.96	68.20	-7.24

Unless otherwise stated the results shown in this test report refer only to the sample(s) tested and such sample(s) are retained for 90 days only.

除非另有說明，此報告結果僅對測試之樣品負責，同時此樣品僅保留90天。本報告未經本公司書面許可，不可部份複製。

This document is issued by the Company subject to its General Conditions of Service printed overleaf, available on request or accessible at <http://www.sgs.com.tw/Terms-and-Conditions> and for electronic format documents, subject to Terms and Conditions for Electronic Documents at <http://www.sgs.com.tw/Terms-and-Conditions>. Attention is drawn to the limitation of liability, indemnification and jurisdiction issues defined therein. Any holder of this document is advised that information contained hereon reflects the Company's findings at the time of its intervention only and within the limits of Client's instructions, if any. The Company's sole responsibility is to its Client and this document does not exonerate parties to a transaction from exercising all their rights and obligations under the transaction documents. This document cannot be reproduced except in full, without prior written approval of the Company. Any unauthorized alteration, forgery or falsification of the content or appearance of this document is unlawful and offenders may be prosecuted to the fullest extent of the law.

Report Number :TERF2403000759E2
 Operation Mode :802.11ac40
 Test Frequency :5510 MHz
 Test Mode :Bandedge
 EUT Pol :E2 Plane

Test Site :SAC G Chamber
 Test Date :2024-03-29
 Temp./Humi. :24.3°C/58%
 Antenna Pol. :Horizontal
 Engineer :Temo Chen

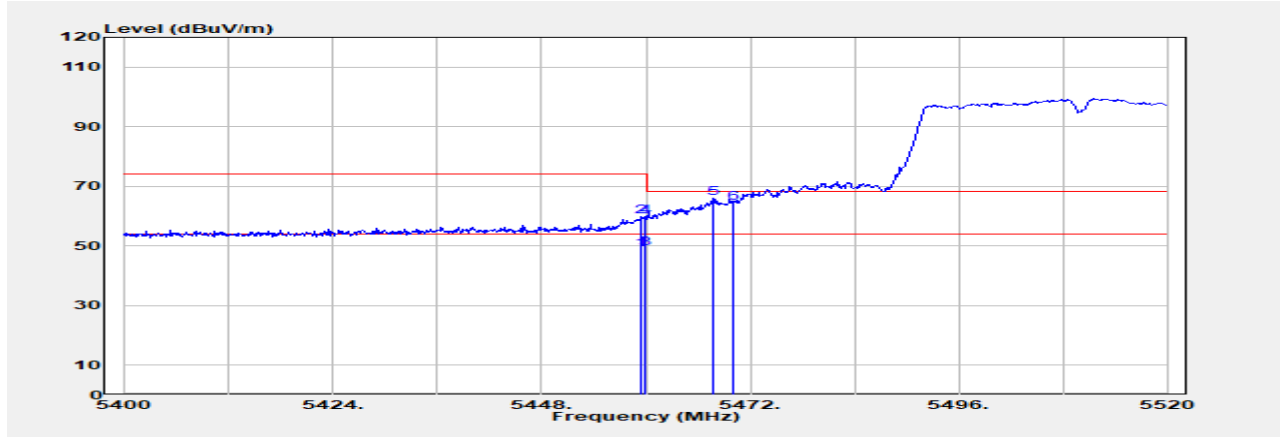

Freq. MHz	Detector Mode PK/QP/AVG	Spectrum Reading Level dB μ V	Factor dB	Actual FS dB μ V/m	Limit @3m dB μ V/m	Margin dB
5459.520	Average	42.64	6.11	48.75	54.00	-5.25
5459.520	Peak	53.75	6.11	59.86	74.00	-14.14
5460.000	Average	42.94	6.11	49.05	54.00	-4.95
5460.000	Peak	53.60	6.11	59.71	74.00	-14.29
5467.680	Peak	59.85	6.18	66.03	68.20	-2.17
5470.000	Peak	58.25	6.21	64.45	68.20	-3.75

Unless otherwise stated the results shown in this test report refer only to the sample(s) tested and such sample(s) are retained for 90 days only.

除非另有說明，此報告結果僅對測試之樣品負責，同時此樣品僅保留90天。本報告未經本公司書面許可，不可部份複製。

This document is issued by the Company subject to its General Conditions of Service printed overleaf, available on request or accessible at <http://www.sgs.com.tw/Terms-and-Conditions> and for electronic format documents, subject to Terms and Conditions for Electronic Documents at <http://www.sgs.com.tw/Terms-and-Conditions>. Attention is drawn to the limitation of liability, indemnification and jurisdiction issues defined therein. Any holder of this document is advised that information contained hereon reflects the Company's findings at the time of its intervention only and within the limits of Client's instructions, if any. The Company's sole responsibility is to its Client and this document does not exonerate parties to a transaction from exercising all their rights and obligations under the transaction documents. This document cannot be reproduced except in full, without prior written approval of the Company. Any unauthorized alteration, forgery or falsification of the content or appearance of this document is unlawful and offenders may be prosecuted to the fullest extent of the law.

Report Number :TERF2403000759E2
 Operation Mode :802.11ac40
 Test Frequency :5670 MHz
 Test Mode :Bandedge
 EUT Pol :E2 Plane

Test Site :SAC G Chamber
 Test Date :2024-03-29
 Temp./Humi. :24.3°C/58%
 Antenna Pol. :Vertical
 Engineer :Temo Chen

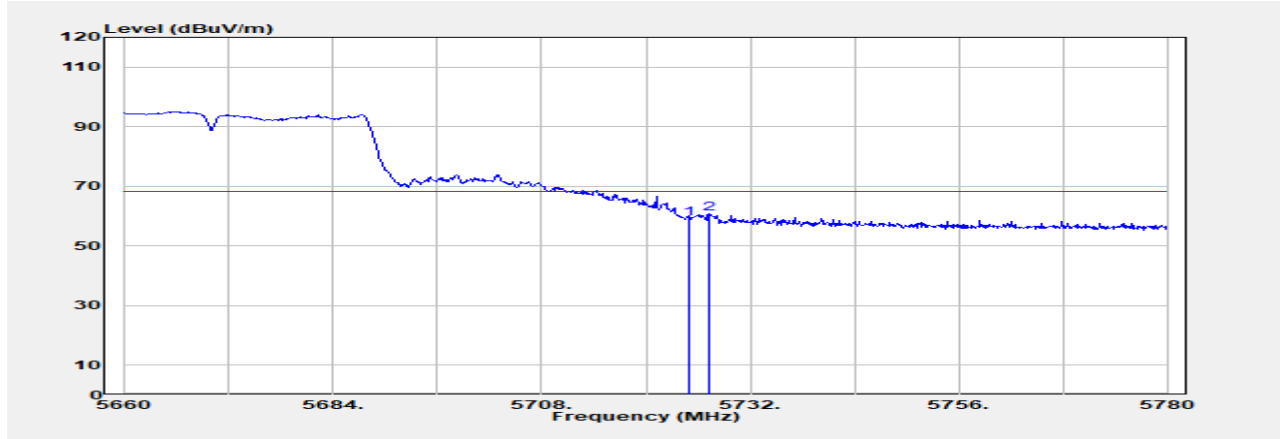

Freq. MHz	Detector Mode PK/QP/AVG	Spectrum Reading Level dBμV	Factor dB	Actual FS dBμV/m	Limit @3m dBμV/m	Margin dB
5725.000	Peak	52.10	7.12	59.22	68.20	-8.98
5727.200	Peak	53.53	7.13	60.65	68.20	-7.55

Unless otherwise stated the results shown in this test report refer only to the sample(s) tested and such sample(s) are retained for 90 days only.

除非另有說明，此報告結果僅對測試之樣品負責，同時此樣品僅保留90天。本報告未經本公司書面許可，不可部份複製。

This document is issued by the Company subject to its General Conditions of Service printed overleaf, available on request or accessible at <http://www.sgs.com.tw/Terms-and-Conditions> and for electronic format documents, subject to Terms and Conditions for Electronic Documents at <http://www.sgs.com.tw/Terms-and-Conditions>. Attention is drawn to the limitation of liability, indemnification and jurisdiction issues defined therein. Any holder of this document is advised that information contained hereon reflects the Company's findings at the time of its intervention only and within the limits of Client's instructions, if any. The Company's sole responsibility is to its Client and this document does not exonerate parties to a transaction from exercising all their rights and obligations under the transaction documents. This document cannot be reproduced except in full, without prior written approval of the Company. Any unauthorized alteration, forgery or falsification of the content or appearance of this document is unlawful and offenders may be prosecuted to the fullest extent of the law.

Report Number :TERF2403000759E2
 Operation Mode :802.11ac40
 Test Frequency :5670 MHz
 Test Mode :Bandedge
 EUT Pol :E2 Plane

Test Site :SAC G Chamber
 Test Date :2024-03-29
 Temp./Humi. :24.3°C/58%
 Antenna Pol. :Horizontal
 Engineer :Temo Chen

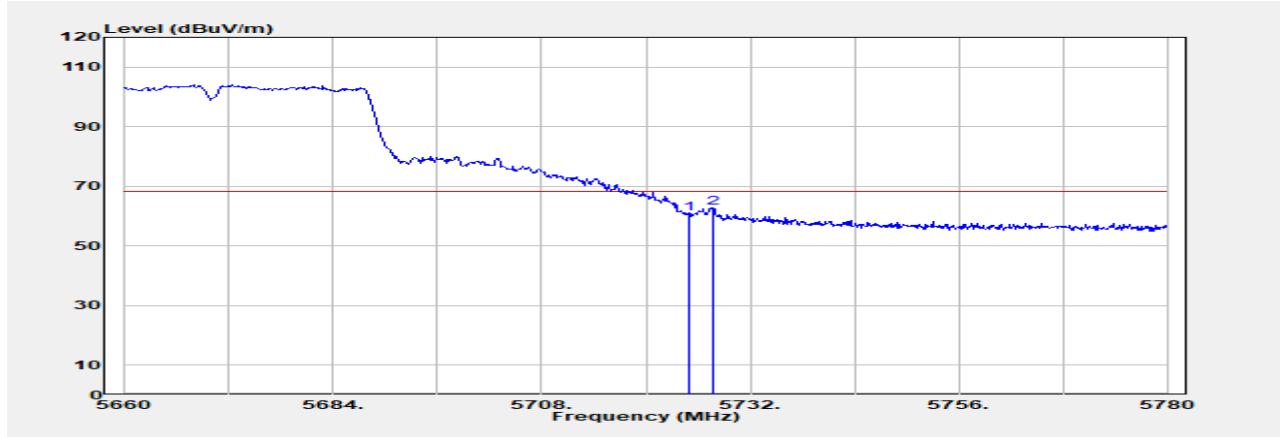

Freq. MHz	Detector Mode PK/QP/AVG	Spectrum Reading Level dBμV	Factor dB	Actual FS dBμV/m	Limit @3m dBμV/m	Margin dB
5725.000	Peak	53.75	7.12	60.87	68.20	-7.33
5727.800	Peak	55.56	7.13	62.69	68.20	-5.51

Unless otherwise stated the results shown in this test report refer only to the sample(s) tested and such sample(s) are retained for 90 days only.

除非另有說明，此報告結果僅對測試之樣品負責，同時此樣品僅保留90天。本報告未經本公司書面許可，不可部份複製。

This document is issued by the Company subject to its General Conditions of Service printed overleaf, available on request or accessible at <http://www.sgs.com.tw/Terms-and-Conditions> and for electronic format documents, subject to Terms and Conditions for Electronic Documents at <http://www.sgs.com.tw/Terms-and-Conditions>. Attention is drawn to the limitation of liability, indemnification and jurisdiction issues defined therein. Any holder of this document is advised that information contained hereon reflects the Company's findings at the time of its intervention only and within the limits of Client's instructions, if any. The Company's sole responsibility is to its Client and this document does not exonerate parties to a transaction from exercising all their rights and obligations under the transaction documents. This document cannot be reproduced except in full, without prior written approval of the Company. Any unauthorized alteration, forgery or falsification of the content or appearance of this document is unlawful and offenders may be prosecuted to the fullest extent of the law.

Report Number :TERF2403000759E2
 Operation Mode :802.11ac40
 Test Frequency :5710 MHz
 Test Mode :Bandedge
 EUT Pol :E2 Plane

Test Site :SAC G Chamber
 Test Date :2024-03-29
 Temp./Humi. :24.3°C/58%
 Antenna Pol. :Vertical
 Engineer :Temo Chen

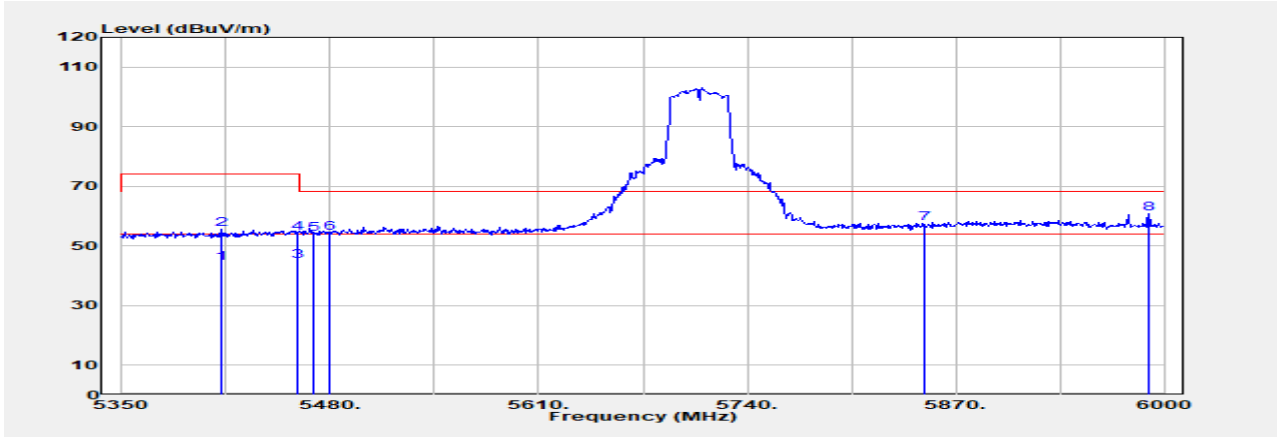

Freq. MHz	Detector Mode PK/QP/AVG	Spectrum Reading Level dBμV	Factor dB	Actual FS dBμV/m	Limit @3m dBμV/m	Margin dB
5411.750	Average	38.45	5.67	44.12	54.00	-9.88
5411.750	Peak	49.98	5.67	55.65	74.00	-18.35
5460.000	Average	38.89	6.11	45.00	54.00	-9.00
5460.000	Peak	48.34	6.11	54.45	74.00	-19.55
5470.000	Peak	47.91	6.21	54.11	68.20	-14.09
5480.000	Peak	48.11	6.30	54.41	68.20	-13.79
5850.000	Peak	49.40	8.01	57.41	68.20	-10.79
5990.900	Peak	52.46	8.31	60.77	68.20	-7.43

Unless otherwise stated the results shown in this test report refer only to the sample(s) tested and such sample(s) are retained for 90 days only.

除非另有說明，此報告結果僅對測試之樣品負責，同時此樣品僅保留90天。本報告未經本公司書面許可，不可部份複製。

This document is issued by the Company subject to its General Conditions of Service printed overleaf, available on request or accessible at <http://www.sgs.com.tw/Terms-and-Conditions> and for electronic format documents, subject to Terms and Conditions for Electronic Documents at <http://www.sgs.com.tw/Terms-and-Conditions>. Attention is drawn to the limitation of liability, indemnification and jurisdiction issues defined therein. Any holder of this document is advised that information contained hereon reflects the Company's findings at the time of its intervention only and within the limits of Client's instructions, if any. The Company's sole responsibility is to its Client and this document does not exonerate parties to a transaction from exercising all their rights and obligations under the transaction documents. This document cannot be reproduced except in full, without prior written approval of the Company. Any unauthorized alteration, forgery or falsification of the content or appearance of this document is unlawful and offenders may be prosecuted to the fullest extent of the law.

Report Number :TERF2403000759E2
 Operation Mode :802.11ac40
 Test Frequency :5710 MHz
 Test Mode :Bandedge
 EUT Pol :E2 Plane

Test Site :SAC G Chamber
 Test Date :2024-03-29
 Temp./Humi. :24.3°C/58%
 Antenna Pol. :Horizontal
 Engineer :Temo Chen

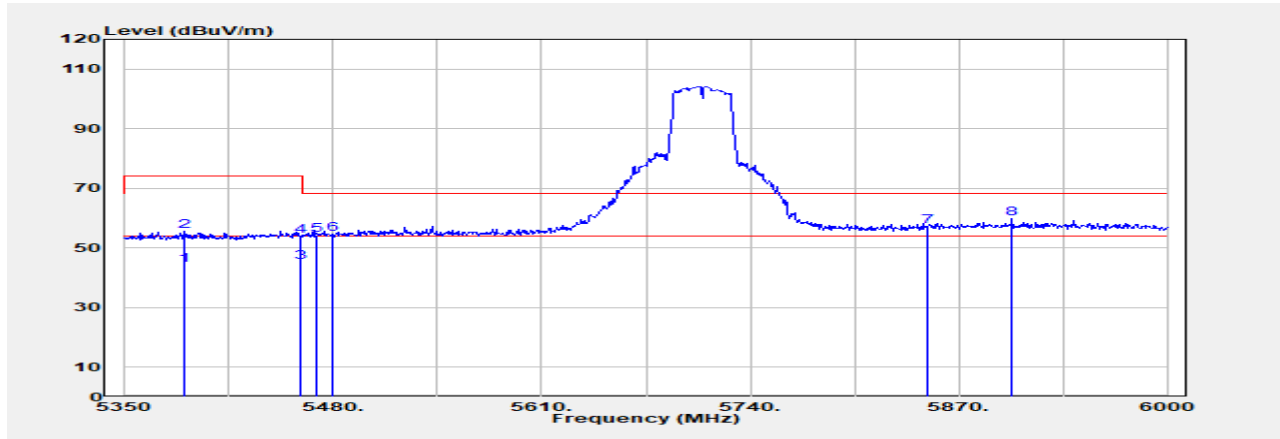

Freq. MHz	Detector Mode PK/QP/AVG	Spectrum Reading Level dB μ V	Factor dB	Actual FS dB μ V/m	Limit @3m dB μ V/m	Margin dB
5387.050	Average	38.70	5.50	44.21	54.00	-9.79
5387.050	Peak	50.20	5.50	55.70	74.00	-18.30
5460.000	Average	38.95	6.11	45.06	54.00	-8.94
5460.000	Peak	47.77	6.11	53.88	74.00	-20.12
5470.000	Peak	47.99	6.21	54.20	68.20	-14.00
5480.000	Peak	48.43	6.30	54.72	68.20	-13.48
5850.000	Peak	49.19	8.01	57.20	68.20	-11.00
5903.150	Peak	51.00	8.80	59.80	68.20	-8.40

Unless otherwise stated the results shown in this test report refer only to the sample(s) tested and such sample(s) are retained for 90 days only.

除非另有說明，此報告結果僅對測試之樣品負責，同時此樣品僅保留90天。本報告未經本公司書面許可，不可部份複製。

This document is issued by the Company subject to its General Conditions of Service printed overleaf, available on request or accessible at <http://www.sgs.com.tw/Terms-and-Conditions> and for electronic format documents, subject to Terms and Conditions for Electronic Documents at <http://www.sgs.com.tw/Terms-and-Conditions>. Attention is drawn to the limitation of liability, indemnification and jurisdiction issues defined therein. Any holder of this document is advised that information contained hereon reflects the Company's findings at the time of its intervention only and within the limits of Client's instructions, if any. The Company's sole responsibility is to its Client and this document does not exonerate parties to a transaction from exercising all their rights and obligations under the transaction documents. This document cannot be reproduced except in full, without prior written approval of the Company. Any unauthorized alteration, forgery or falsification of the content or appearance of this document is unlawful and offenders may be prosecuted to the fullest extent of the law.

Report Number :TERF2403000759E2
 Operation Mode :802.11ac40
 Test Frequency :5755 MHz
 Test Mode :Bandedge
 EUT Pol :E2 Plane

Test Site :SAC G Chamber
 Test Date :2024-03-29
 Temp./Humi. :24.3°C/58%
 Antenna Pol. :Vertical
 Engineer :Temo Chen

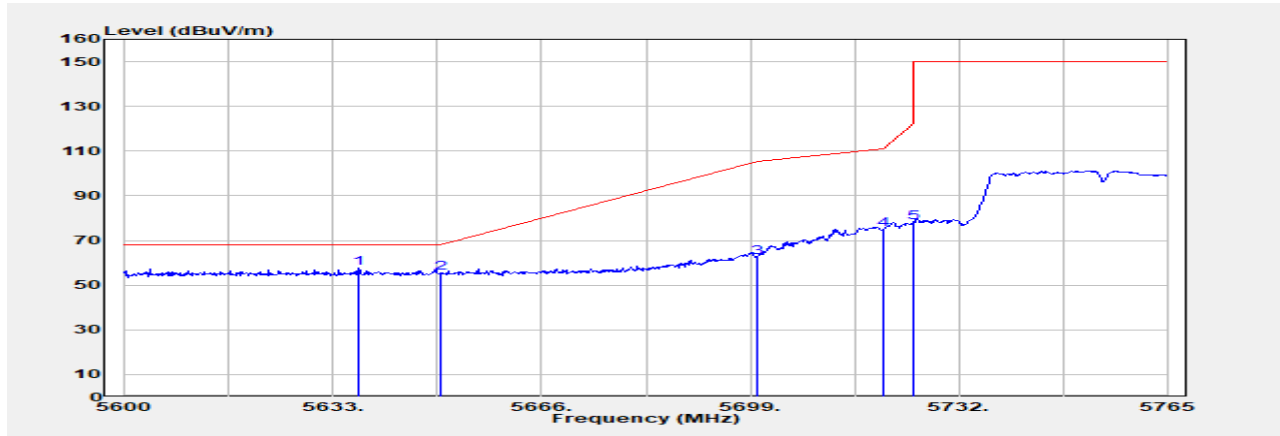

Freq. MHz	Detector Mode PK/QP/AVG	Spectrum Reading Level dB μ V	Factor dB	Actual FS dB μ V/m	Limit @3m dB μ V/m	Margin dB
5636.960	Peak	51.14	6.33	57.47	68.20	-10.73
5650.000	Peak	49.13	6.43	55.56	68.20	-12.64
5700.000	Peak	55.35	6.99	62.34	105.20	-42.86
5720.000	Peak	68.14	7.09	75.23	110.80	-35.57
5725.000	Peak	71.04	7.12	78.16	122.20	-44.04

Unless otherwise stated the results shown in this test report refer only to the sample(s) tested and such sample(s) are retained for 90 days only.

除非另有說明，此報告結果僅對測試之樣品負責，同時此樣品僅保留90天。本報告未經本公司書面許可，不可部份複製。

This document is issued by the Company subject to its General Conditions of Service printed overleaf, available on request or accessible at <http://www.sgs.com.tw/Terms-and-Conditions> and for electronic format documents, subject to Terms and Conditions for Electronic Documents at <http://www.sgs.com.tw/Terms-and-Conditions>. Attention is drawn to the limitation of liability, indemnification and jurisdiction issues defined therein. Any holder of this document is advised that information contained hereon reflects the Company's findings at the time of its intervention only and within the limits of Client's instructions, if any. The Company's sole responsibility is to its Client and this document does not exonerate parties to a transaction from exercising all their rights and obligations under the transaction documents. This document cannot be reproduced except in full, without prior written approval of the Company. Any unauthorized alteration, forgery or falsification of the content or appearance of this document is unlawful and offenders may be prosecuted to the fullest extent of the law.

Report Number :TERF2403000759E2
 Operation Mode :802.11ac40
 Test Frequency :5755 MHz
 Test Mode :Bandedge
 EUT Pol :E2 Plane

Test Site :SAC G Chamber
 Test Date :2024-03-29
 Temp./Humi. :24.3°C/58%
 Antenna Pol. :Horizontal
 Engineer :Temo Chen

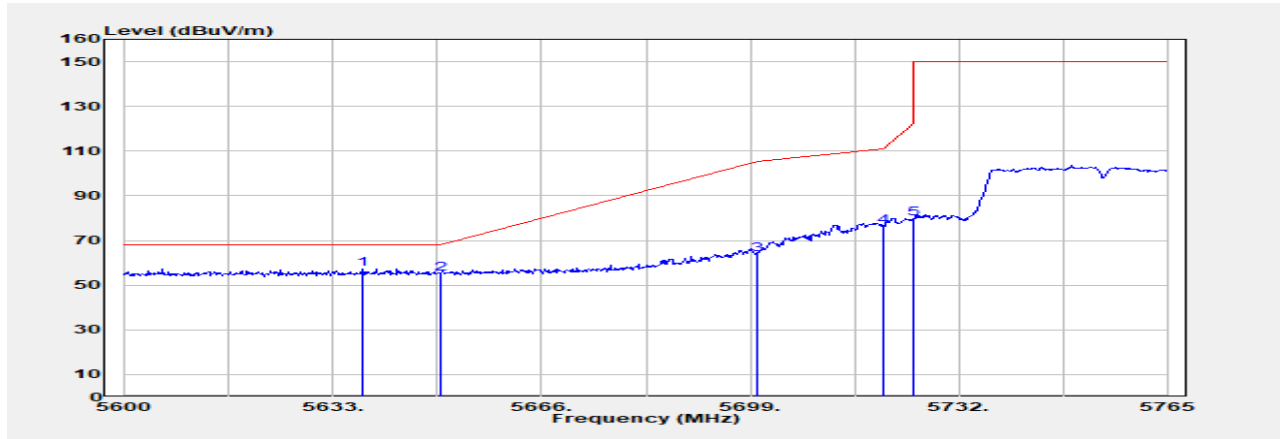

Freq. MHz	Detector Mode PK/QP/AVG	Spectrum Reading Level dBμV	Factor dB	Actual FS dBμV/m	Limit @3m dBμV/m	Margin dB
5637.620	Peak	50.94	6.34	57.28	68.20	-10.92
5650.000	Peak	48.82	6.43	55.25	68.20	-12.95
5700.000	Peak	56.66	6.99	63.65	105.20	-41.55
5720.000	Peak	69.39	7.09	76.48	110.80	-34.32
5725.000	Peak	72.82	7.12	79.94	122.20	-42.26

Unless otherwise stated the results shown in this test report refer only to the sample(s) tested and such sample(s) are retained for 90 days only.

除非另有說明，此報告結果僅對測試之樣品負責，同時此樣品僅保留90天。本報告未經本公司書面許可，不可部份複製。

This document is issued by the Company subject to its General Conditions of Service printed overleaf, available on request or accessible at <http://www.sgs.com.tw/Terms-and-Conditions> and for electronic format documents, subject to Terms and Conditions for Electronic Documents at <http://www.sgs.com.tw/Terms-and-Conditions>. Attention is drawn to the limitation of liability, indemnification and jurisdiction issues defined therein. Any holder of this document is advised that information contained hereon reflects the Company's findings at the time of its intervention only and within the limits of Client's instructions, if any. The Company's sole responsibility is to its Client and this document does not exonerate parties to a transaction from exercising all their rights and obligations under the transaction documents. This document cannot be reproduced except in full, without prior written approval of the Company. Any unauthorized alteration, forgery or falsification of the content or appearance of this document is unlawful and offenders may be prosecuted to the fullest extent of the law.

Report Number :TERF2403000759E2
 Operation Mode :802.11ac40
 Test Frequency :5795 MHz
 Test Mode :Bandedge
 EUT Pol :E2 Plane

Test Site :SAC G Chamber
 Test Date :2024-03-29
 Temp./Humi. :24.3°C/58%
 Antenna Pol. :Vertical
 Engineer :Temo Chen

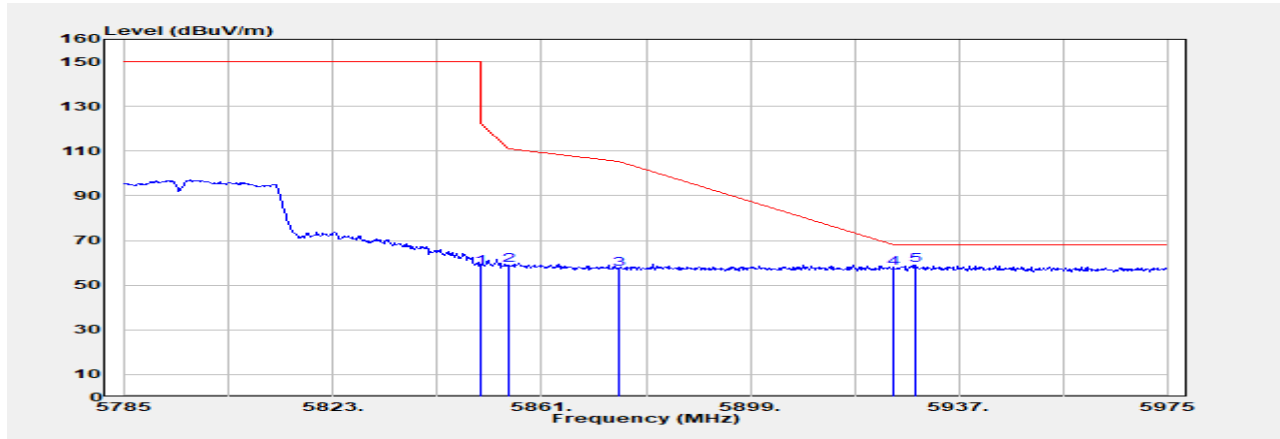

Freq. MHz	Detector Mode PK/QP/AVG	Spectrum Reading Level dBμV	Factor dB	Actual FS dBμV/m	Limit @3m dBμV/m	Margin dB
5850.000	Peak	50.30	8.01	58.31	122.20	-63.89
5855.000	Peak	50.80	8.09	58.89	110.80	-51.91
5875.000	Peak	49.02	8.41	57.43	105.20	-47.77
5925.000	Peak	49.06	8.72	57.77	68.20	-10.43
5929.020	Peak	50.18	8.70	58.88	68.20	-9.32

Unless otherwise stated the results shown in this test report refer only to the sample(s) tested and such sample(s) are retained for 90 days only.

除非另有說明，此報告結果僅對測試之樣品負責，同時此樣品僅保留90天。本報告未經本公司書面許可，不可部份複製。

This document is issued by the Company subject to its General Conditions of Service printed overleaf, available on request or accessible at <http://www.sgs.com.tw/Terms-and-Conditions> and for electronic format documents, subject to Terms and Conditions for Electronic Documents at <http://www.sgs.com.tw/Terms-and-Conditions>. Attention is drawn to the limitation of liability, indemnification and jurisdiction issues defined therein. Any holder of this document is advised that information contained hereon reflects the Company's findings at the time of its intervention only and within the limits of Client's instructions, if any. The Company's sole responsibility is to its Client and this document does not exonerate parties to a transaction from exercising all their rights and obligations under the transaction documents. This document cannot be reproduced except in full, without prior written approval of the Company. Any unauthorized alteration, forgery or falsification of the content or appearance of this document is unlawful and offenders may be prosecuted to the fullest extent of the law.

Report Number :TERF2403000759E2
 Operation Mode :802.11ac40
 Test Frequency :5795 MHz
 Test Mode :Bandedge
 EUT Pol :E2 Plane

Test Site :SAC G Chamber
 Test Date :2024-03-29
 Temp./Humi. :24.3°C/58%
 Antenna Pol. :Horizontal
 Engineer :Temo Chen

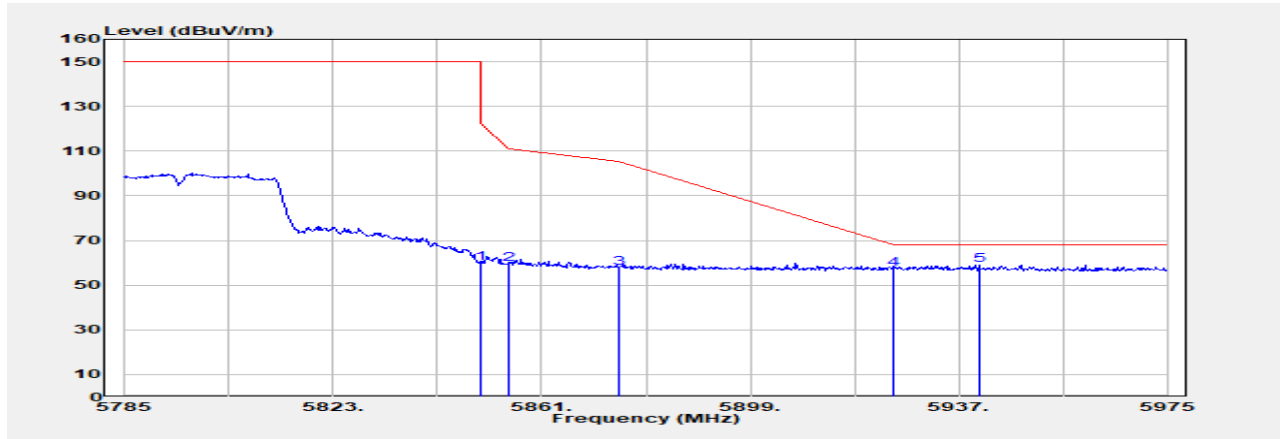

Freq. MHz	Detector Mode PK/QP/AVG	Spectrum Reading Level dBμV	Factor dB	Actual FS dBμV/m	Limit @3m dBμV/m	Margin dB
5850.000	Peak	51.82	8.01	59.83	122.20	-62.37
5855.000	Peak	51.14	8.09	59.23	110.80	-51.57
5875.000	Peak	49.42	8.41	57.83	105.20	-47.37
5925.000	Peak	48.39	8.72	57.10	68.20	-11.10
5940.800	Peak	50.47	8.66	59.13	68.20	-9.07

Unless otherwise stated the results shown in this test report refer only to the sample(s) tested and such sample(s) are retained for 90 days only.

除非另有說明，此報告結果僅對測試之樣品負責，同時此樣品僅保留90天。本報告未經本公司書面許可，不可部份複製。
 This document is issued by the Company subject to its General Conditions of Service printed overleaf, available on request or accessible at <http://www.sgs.com.tw/Terms-and-Conditions> and for electronic format documents, subject to Terms and Conditions for Electronic Documents at <http://www.sgs.com.tw/Terms-and-Conditions>. Attention is drawn to the limitation of liability, indemnification and jurisdiction issues defined therein. Any holder of this document is advised that information contained hereon reflects the Company's findings at the time of its intervention only and within the limits of Client's instructions, if any. The Company's sole responsibility is to its Client and this document does not exonerate parties to a transaction from exercising all their rights and obligations under the transaction documents. This document cannot be reproduced except in full, without prior written approval of the Company. Any unauthorized alteration, forgery or falsification of the content or appearance of this document is unlawful and offenders may be prosecuted to the fullest extent of the law.

Report Number :TERF2403000759E2
 Operation Mode :802.11ac80
 Test Frequency :5210 MHz
 Test Mode :Bandedge
 EUT Pol :E2 Plane

Test Site :SAC G Chamber
 Test Date :2024-03-29
 Temp./Humi. :24.3°C/58%
 Antenna Pol. :Vertical
 Engineer :Temo Chen

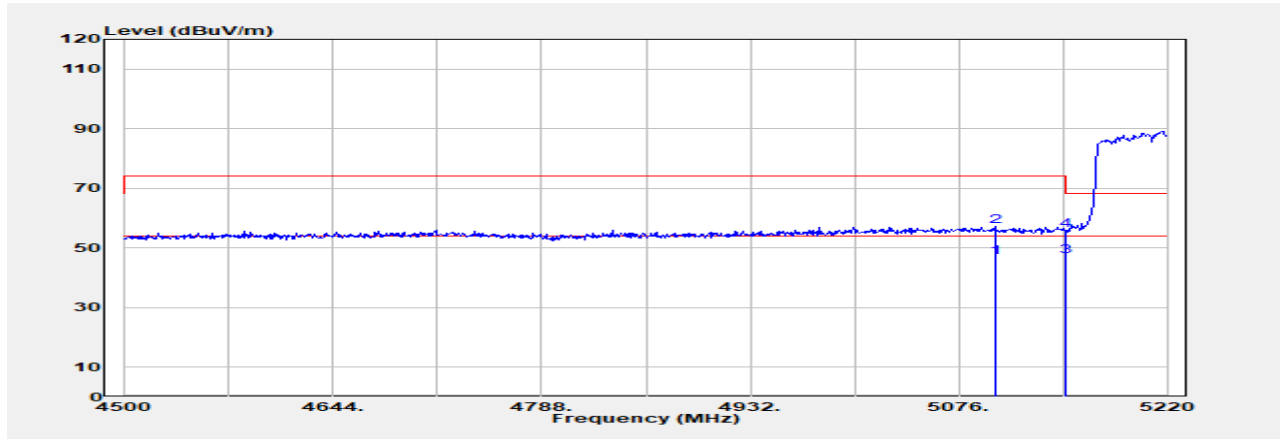

Freq. MHz	Detector Mode PK/QP/AVG	Spectrum Reading Level dBμV	Factor dB	Actual FS dBμV/m	Limit @3m dBμV/m	Margin dB
5101.200	Average	40.86	6.02	46.88	54.00	-7.12
5101.200	Peak	51.36	6.02	57.38	74.00	-16.62
5150.000	Average	41.45	5.72	47.18	54.00	-6.82
5150.000	Peak	50.30	5.72	56.03	74.00	-17.97

Unless otherwise stated the results shown in this test report refer only to the sample(s) tested and such sample(s) are retained for 90 days only.

除非另有說明，此報告結果僅對測試之樣品負責，同時此樣品僅保留90天。本報告未經本公司書面許可，不可部份複製。

This document is issued by the Company subject to its General Conditions of Service printed overleaf, available on request or accessible at <http://www.sgs.com.tw/Terms-and-Conditions> and for electronic format documents, subject to Terms and Conditions for Electronic Documents at <http://www.sgs.com.tw/Terms-and-Conditions>. Attention is drawn to the limitation of liability, indemnification and jurisdiction issues defined therein. Any holder of this document is advised that information contained hereon reflects the Company's findings at the time of its intervention only and within the limits of Client's instructions, if any. The Company's sole responsibility is to its Client and this document does not exonerate parties to a transaction from exercising all their rights and obligations under the transaction documents. This document cannot be reproduced except in full, without prior written approval of the Company. Any unauthorized alteration, forgery or falsification of the content or appearance of this document is unlawful and offenders may be prosecuted to the fullest extent of the law.

Report Number :TERF2403000759E2
 Operation Mode :802.11ac80
 Test Frequency :5210 MHz
 Test Mode :Bandedge
 EUT Pol :E2 Plane

Test Site :SAC G Chamber
 Test Date :2024-03-29
 Temp./Humi. :24.3°C/58%
 Antenna Pol. :Horizontal
 Engineer :Temo Chen

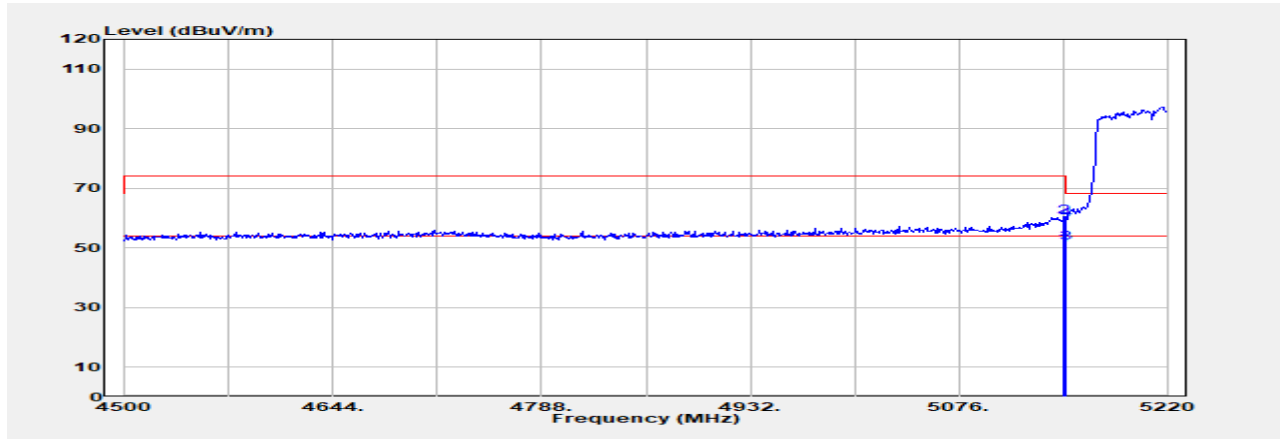

Freq. MHz	Detector Mode PK/QP/AVG	Spectrum Reading Level dB μ V	Factor dB	Actual FS dB μ V/m	Limit @3m dB μ V/m	Margin dB
5148.720	Average	45.36	5.73	51.10	54.00	-2.90
5148.720	Peak	54.79	5.73	60.52	74.00	-13.48
5150.000	Average	45.93	5.72	51.66	54.00	-2.34
5150.000	Peak	53.91	5.72	59.64	74.00	-14.36

Unless otherwise stated the results shown in this test report refer only to the sample(s) tested and such sample(s) are retained for 90 days only.

除非另有說明，此報告結果僅對測試之樣品負責，同時此樣品僅保留90天。本報告未經本公司書面許可，不可部份複製。

This document is issued by the Company subject to its General Conditions of Service printed overleaf, available on request or accessible at <http://www.sgs.com.tw/Terms-and-Conditions> and for electronic format documents, subject to Terms and Conditions for Electronic Documents at <http://www.sgs.com.tw/Terms-and-Conditions>. Attention is drawn to the limitation of liability, indemnification and jurisdiction issues defined therein. Any holder of this document is advised that information contained hereon reflects the Company's findings at the time of its intervention only and within the limits of Client's instructions, if any. The Company's sole responsibility is to its Client and this document does not exonerate parties to a transaction from exercising all their rights and obligations under the transaction documents. This document cannot be reproduced except in full, without prior written approval of the Company. Any unauthorized alteration, forgery or falsification of the content or appearance of this document is unlawful and offenders may be prosecuted to the fullest extent of the law.

Report Number :TERF2403000759E2
 Operation Mode :802.11ac80
 Test Frequency :5290 MHz
 Test Mode :Bandedge
 EUT Pol :E2 Plane

Test Site :SAC G Chamber
 Test Date :2024-03-29
 Temp./Humi. :24.3°C/58%
 Antenna Pol. :Vertical
 Engineer :Temo Chen

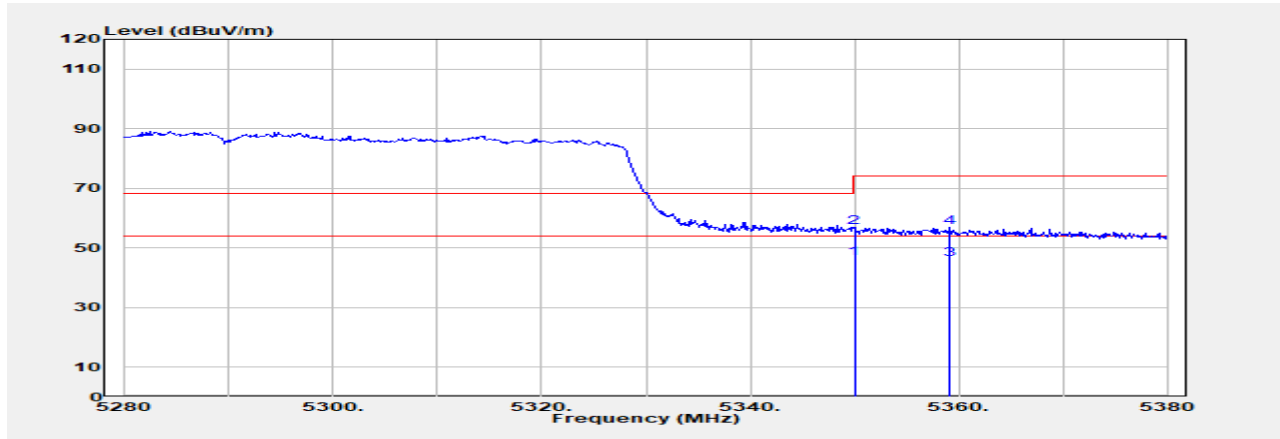

Freq. MHz	Detector Mode PK/QP/AVG	Spectrum Reading Level dB μ V	Factor dB	Actual FS dB μ V/m	Limit @3m dB μ V/m	Margin dB
5350.000	Average	41.25	5.34	46.59	54.00	-7.41
5350.000	Peak	51.60	5.34	56.94	74.00	-17.06
5359.200	Average	40.72	5.38	46.10	54.00	-7.90
5359.200	Peak	51.53	5.38	56.91	74.00	-17.09

Unless otherwise stated the results shown in this test report refer only to the sample(s) tested and such sample(s) are retained for 90 days only.

除非另有說明，此報告結果僅對測試之樣品負責，同時此樣品僅保留90天。本報告未經本公司書面許可，不可部份複製。

This document is issued by the Company subject to its General Conditions of Service printed overleaf, available on request or accessible at <http://www.sgs.com.tw/Terms-and-Conditions> and for electronic format documents, subject to Terms and Conditions for Electronic Documents at <http://www.sgs.com.tw/Terms-and-Conditions>. Attention is drawn to the limitation of liability, indemnification and jurisdiction issues defined therein. Any holder of this document is advised that information contained hereon reflects the Company's findings at the time of its intervention only and within the limits of Client's instructions, if any. The Company's sole responsibility is to its Client and this document does not exonerate parties to a transaction from exercising all their rights and obligations under the transaction documents. This document cannot be reproduced except in full, without prior written approval of the Company. Any unauthorized alteration, forgery or falsification of the content or appearance of this document is unlawful and offenders may be prosecuted to the fullest extent of the law.

Report Number :TERF2403000759E2

Test Site :SAC G Chamber

Operation Mode :802.11ac80

Test Date :2024-03-29

Test Frequency :5290 MHz

Temp./Humi. :24.3°C/58%

Test Mode :Bandedge

Antenna Pol. :Horizontal

EUT Pol :E2 Plane

Engineer :Temo Chen

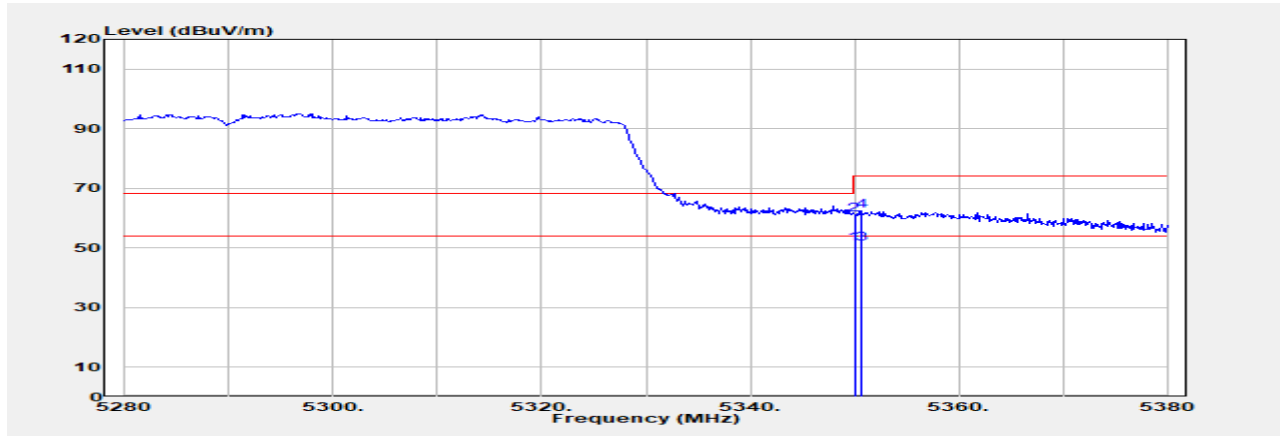

Freq. MHz	Detector Mode PK/QP/AVG	Spectrum Reading Level dBμV	Factor dB	Actual FS dBμV/m	Limit @3m dBμV/m	Margin dB
5350.000	Average	46.17	5.34	51.51	54.00	-2.49
5350.000	Peak	55.77	5.34	61.11	74.00	-12.89
5350.700	Average	45.91	5.34	51.25	54.00	-2.75
5350.700	Peak	57.02	5.34	62.36	74.00	-11.64

Unless otherwise stated the results shown in this test report refer only to the sample(s) tested and such sample(s) are retained for 90 days only.

除非另有說明，此報告結果僅對測試之樣品負責，同時此樣品僅保留90天。本報告未經本公司書面許可，不可部份複製。

This document is issued by the Company subject to its General Conditions of Service printed overleaf, available on request or accessible at <http://www.sgs.com.tw/Terms-and-Conditions> and for electronic format documents, subject to Terms and Conditions for Electronic Documents at <http://www.sgs.com.tw/Terms-and-Conditions>. Attention is drawn to the limitation of liability, indemnification and jurisdiction issues defined therein. Any holder of this document is advised that information contained hereon reflects the Company's findings at the time of its intervention only and within the limits of Client's instructions, if any. The Company's sole responsibility is to its Client and this document does not exonerate parties to a transaction from exercising all their rights and obligations under the transaction documents. This document cannot be reproduced except in full, without prior written approval of the Company. Any unauthorized alteration, forgery or falsification of the content or appearance of this document is unlawful and offenders may be prosecuted to the fullest extent of the law.

Report Number :TERF2403000759E2
 Operation Mode :802.11ac80
 Test Frequency :5530 MHz
 Test Mode :Bandedge
 EUT Pol :E2 Plane

Test Site :SAC G Chamber
 Test Date :2024-03-29
 Temp./Humi. :24.3°C/58%
 Antenna Pol. :Vertical
 Engineer :Temo Chen

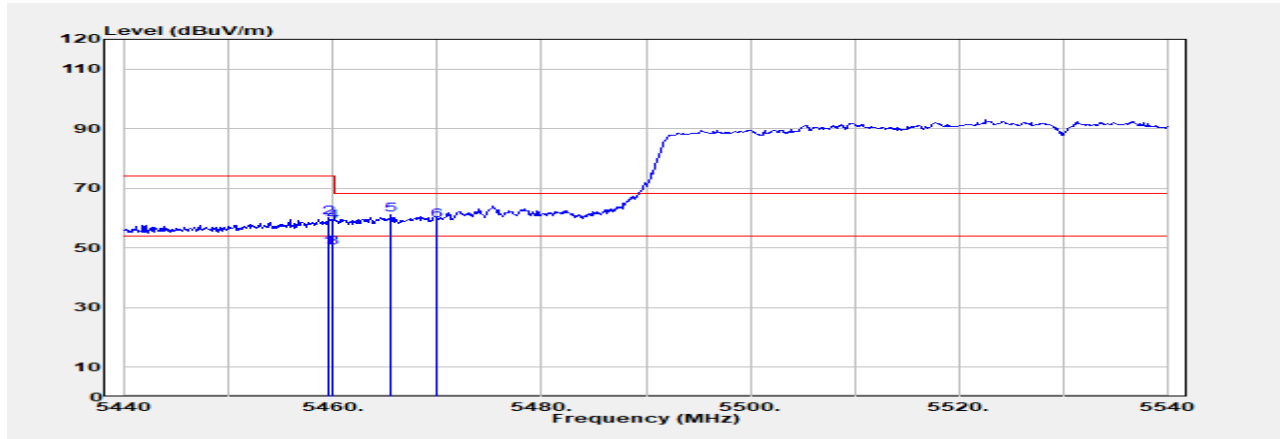

Freq. MHz	Detector Mode PK/QP/AVG	Spectrum Reading Level dBμV	Factor dB	Actual FS dBμV/m	Limit @3m dBμV/m	Margin dB
5459.600	Average	43.87	6.11	49.98	54.00	-4.02
5459.600	Peak	54.12	6.11	60.23	74.00	-13.77
5460.000	Average	44.01	6.11	50.13	54.00	-3.87
5460.000	Peak	52.87	6.11	58.99	74.00	-15.01
5465.500	Peak	55.06	6.16	61.23	68.20	-6.97
5470.000	Peak	53.04	6.21	59.25	68.20	-8.95

Unless otherwise stated the results shown in this test report refer only to the sample(s) tested and such sample(s) are retained for 90 days only.

除非另有說明，此報告結果僅對測試之樣品負責，同時此樣品僅保留90天。本報告未經本公司書面許可，不可部份複製。

This document is issued by the Company subject to its General Conditions of Service printed overleaf, available on request or accessible at <http://www.sgs.com.tw/Terms-and-Conditions> and for electronic format documents, subject to Terms and Conditions for Electronic Documents at <http://www.sgs.com.tw/Terms-and-Conditions>. Attention is drawn to the limitation of liability, indemnification and jurisdiction issues defined therein. Any holder of this document is advised that information contained hereon reflects the Company's findings at the time of its intervention only and within the limits of Client's instructions, if any. The Company's sole responsibility is to its Client and this document does not exonerate parties to a transaction from exercising all their rights and obligations under the transaction documents. This document cannot be reproduced except in full, without prior written approval of the Company. Any unauthorized alteration, forgery or falsification of the content or appearance of this document is unlawful and offenders may be prosecuted to the fullest extent of the law.

Report Number :TERF2403000759E2
 Operation Mode :802.11ac80
 Test Frequency :5530 MHz
 Test Mode :Bandedge
 EUT Pol :E2 Plane

Test Site :SAC G Chamber
 Test Date :2024-03-29
 Temp./Humi. :24.3°C/58%
 Antenna Pol. :Horizontal
 Engineer :Temo Chen

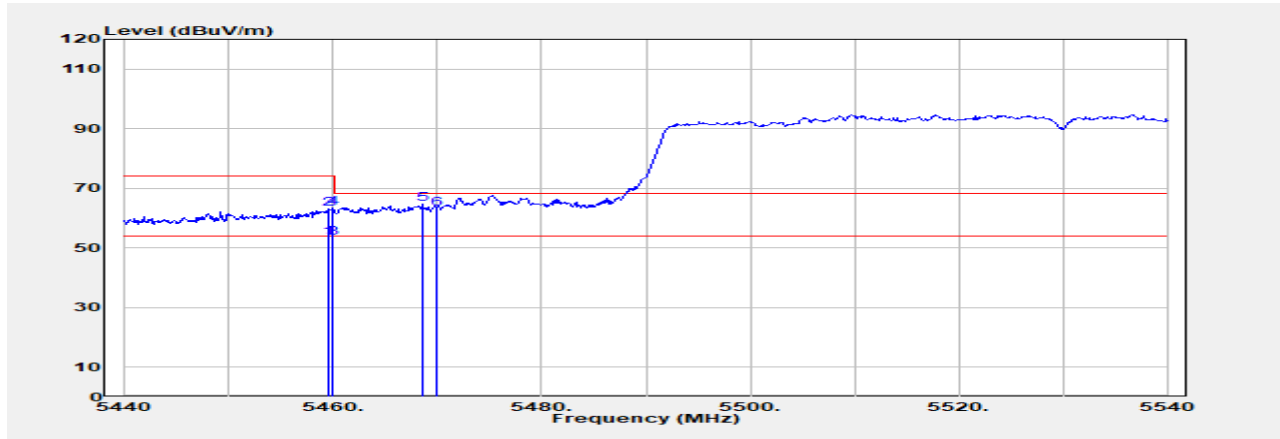

Freq. MHz	Detector Mode PK/QP/AVG	Spectrum Reading Level dB μ V	Factor dB	Actual FS dB μ V/m	Limit @3m dB μ V/m	Margin dB
5459.600	Average	47.28	6.11	53.39	54.00	-0.61
5459.600	Peak	56.98	6.11	63.09	74.00	-10.91
5460.000	Average	47.11	6.11	53.22	54.00	-0.78
5460.000	Peak	57.15	6.11	63.26	74.00	-10.74
5468.500	Peak	58.59	6.19	64.78	68.20	-3.42
5470.000	Peak	56.92	6.21	63.12	68.20	-5.08

Unless otherwise stated the results shown in this test report refer only to the sample(s) tested and such sample(s) are retained for 90 days only.

除非另有說明，此報告結果僅對測試之樣品負責，同時此樣品僅保留90天。本報告未經本公司書面許可，不可部份複製。

This document is issued by the Company subject to its General Conditions of Service printed overleaf, available on request or accessible at <http://www.sgs.com.tw/Terms-and-Conditions> and for electronic format documents, subject to Terms and Conditions for Electronic Documents at <http://www.sgs.com.tw/Terms-and-Conditions>. Attention is drawn to the limitation of liability, indemnification and jurisdiction issues defined therein. Any holder of this document is advised that information contained hereon reflects the Company's findings at the time of its intervention only and within the limits of Client's instructions, if any. The Company's sole responsibility is to its Client and this document does not exonerate parties to a transaction from exercising all their rights and obligations under the transaction documents. This document cannot be reproduced except in full, without prior written approval of the Company. Any unauthorized alteration, forgery or falsification of the content or appearance of this document is unlawful and offenders may be prosecuted to the fullest extent of the law.

Report Number :TERF2403000759E2
 Operation Mode :802.11ac80
 Test Frequency :5610 MHz
 Test Mode :Bandedge
 EUT Pol :E2 Plane

Test Site :SAC G Chamber
 Test Date :2024-03-29
 Temp./Humi. :24.3°C/58%
 Antenna Pol. :Vertical
 Engineer :Temo Chen

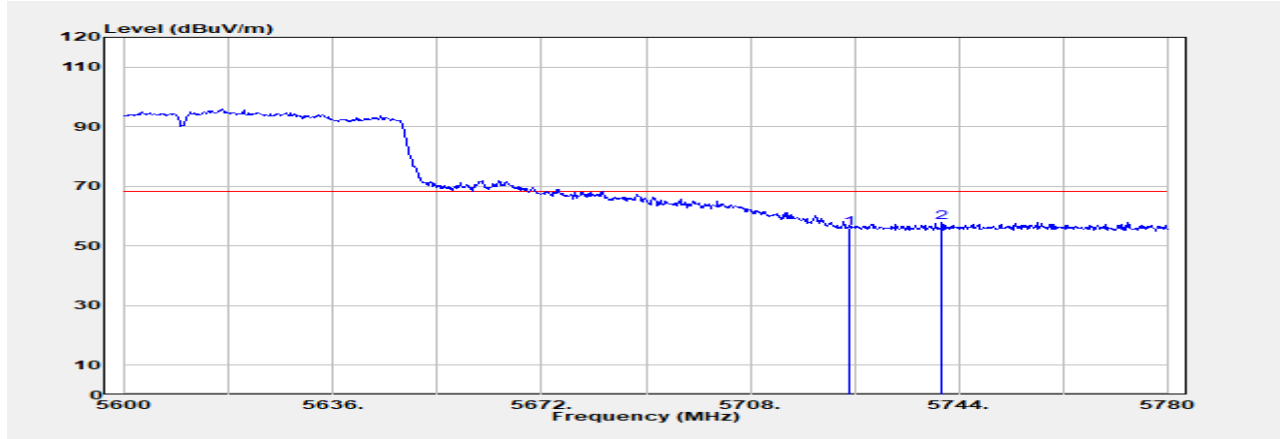

Freq. MHz	Detector Mode PK/QP/AVG	Spectrum Reading Level dB μ V	Factor dB	Actual FS dB μ V/m	Limit @3m dB μ V/m	Margin dB
5725.000	Peak	48.82	7.12	55.94	68.20	-12.26
5741.120	Peak	50.71	7.20	57.91	68.20	-10.29

Unless otherwise stated the results shown in this test report refer only to the sample(s) tested and such sample(s) are retained for 90 days only.

除非另有說明，此報告結果僅對測試之樣品負責，同時此樣品僅保留90天。本報告未經本公司書面許可，不可部份複製。

This document is issued by the Company subject to its General Conditions of Service printed overleaf, available on request or accessible at <http://www.sgs.com.tw/Terms-and-Conditions> and for electronic format documents, subject to Terms and Conditions for Electronic Documents at <http://www.sgs.com.tw/Terms-and-Conditions>. Attention is drawn to the limitation of liability, indemnification and jurisdiction issues defined therein. Any holder of this document is advised that information contained hereon reflects the Company's findings at the time of its intervention only and within the limits of Client's instructions, if any. The Company's sole responsibility is to its Client and this document does not exonerate parties to a transaction from exercising all their rights and obligations under the transaction documents. This document cannot be reproduced except in full, without prior written approval of the Company. Any unauthorized alteration, forgery or falsification of the content or appearance of this document is unlawful and offenders may be prosecuted to the fullest extent of the law.

Report Number :TERF2403000759E2
 Operation Mode :802.11ac80
 Test Frequency :5610 MHz
 Test Mode :Bandedge
 EUT Pol :E2 Plane

Test Site :SAC G Chamber
 Test Date :2024-03-29
 Temp./Humi. :24.3°C/58%
 Antenna Pol. :Horizontal
 Engineer :Temo Chen

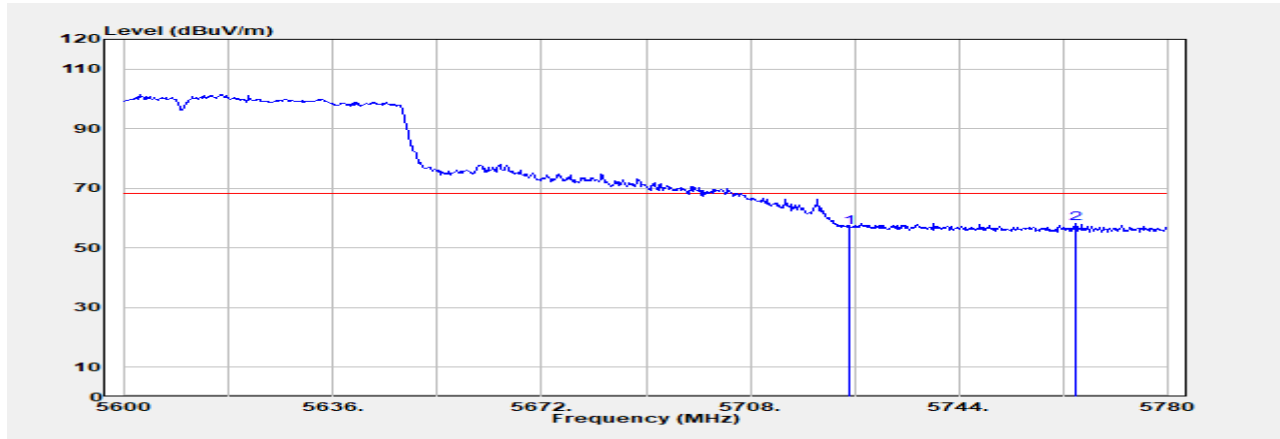

Freq. MHz	Detector Mode PK/QP/AVG	Spectrum Reading Level dB μ V	Factor dB	Actual FS dB μ V/m	Limit @3m dB μ V/m	Margin dB
5725.000	Peak	49.82	7.12	56.94	68.20	-11.26
5764.160	Peak	50.98	7.26	58.24	68.20	-9.96

Unless otherwise stated the results shown in this test report refer only to the sample(s) tested and such sample(s) are retained for 90 days only.

除非另有說明，此報告結果僅對測試之樣品負責，同時此樣品僅保留90天。本報告未經本公司書面許可，不可部份複製。

This document is issued by the Company subject to its General Conditions of Service printed overleaf, available on request or accessible at <http://www.sgs.com.tw/Terms-and-Conditions> and for electronic format documents, subject to Terms and Conditions for Electronic Documents at <http://www.sgs.com.tw/Terms-and-Conditions>. Attention is drawn to the limitation of liability, indemnification and jurisdiction issues defined therein. Any holder of this document is advised that information contained hereon reflects the Company's findings at the time of its intervention only and within the limits of Client's instructions, if any. The Company's sole responsibility is to its Client and this document does not exonerate parties to a transaction from exercising all their rights and obligations under the transaction documents. This document cannot be reproduced except in full, without prior written approval of the Company. Any unauthorized alteration, forgery or falsification of the content or appearance of this document is unlawful and offenders may be prosecuted to the fullest extent of the law.

Report Number :TERF2403000759E2
 Operation Mode :802.11ac80
 Test Frequency :5690 MHz
 Test Mode :Bandedge
 EUT Pol :E2 Plane

Test Site :SAC G Chamber
 Test Date :2024-03-29
 Temp./Humi. :24.3°C/58%
 Antenna Pol. :Vertical
 Engineer :Temo Chen

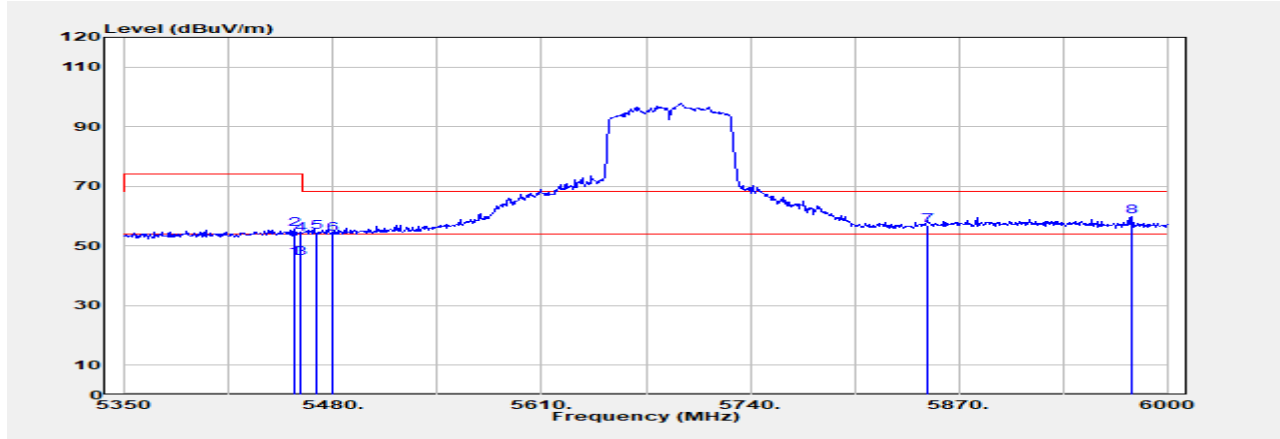

Freq. MHz	Detector Mode PK/QP/AVG	Spectrum Reading Level dBμV	Factor dB	Actual FS dBμV/m	Limit @3m dBμV/m	Margin dB
5455.950	Average	39.90	6.08	45.97	54.00	-8.03
5455.950	Peak	49.70	6.08	55.77	74.00	-18.23
5460.000	Average	39.69	6.11	45.81	54.00	-8.19
5460.000	Peak	47.98	6.11	54.10	74.00	-19.90
5470.000	Peak	48.55	6.21	54.76	68.20	-13.44
5480.000	Peak	47.73	6.30	54.03	68.20	-14.17
5850.000	Peak	48.83	8.01	56.84	68.20	-11.36
5978.550	Peak	51.55	8.40	59.95	68.20	-8.25

Unless otherwise stated the results shown in this test report refer only to the sample(s) tested and such sample(s) are retained for 90 days only.

除非另有說明，此報告結果僅對測試之樣品負責，同時此樣品僅保留90天。本報告未經本公司書面許可，不可部份複製。

This document is issued by the Company subject to its General Conditions of Service printed overleaf, available on request or accessible at <http://www.sgs.com.tw/Terms-and-Conditions> and for electronic format documents, subject to Terms and Conditions for Electronic Documents at <http://www.sgs.com.tw/Terms-and-Conditions>. Attention is drawn to the limitation of liability, indemnification and jurisdiction issues defined therein. Any holder of this document is advised that information contained hereon reflects the Company's findings at the time of its intervention only and within the limits of Client's instructions, if any. The Company's sole responsibility is to its Client and this document does not exonerate parties to a transaction from exercising all their rights and obligations under the transaction documents. This document cannot be reproduced except in full, without prior written approval of the Company. Any unauthorized alteration, forgery or falsification of the content or appearance of this document is unlawful and offenders may be prosecuted to the fullest extent of the law.

Report Number :TERF2403000759E2
 Operation Mode :802.11ac80
 Test Frequency :5690 MHz
 Test Mode :Bandedge
 EUT Pol :E2 Plane

Test Site :SAC G Chamber
 Test Date :2024-03-29
 Temp./Humi. :24.3°C/58%
 Antenna Pol. :Horizontal
 Engineer :Temo Chen

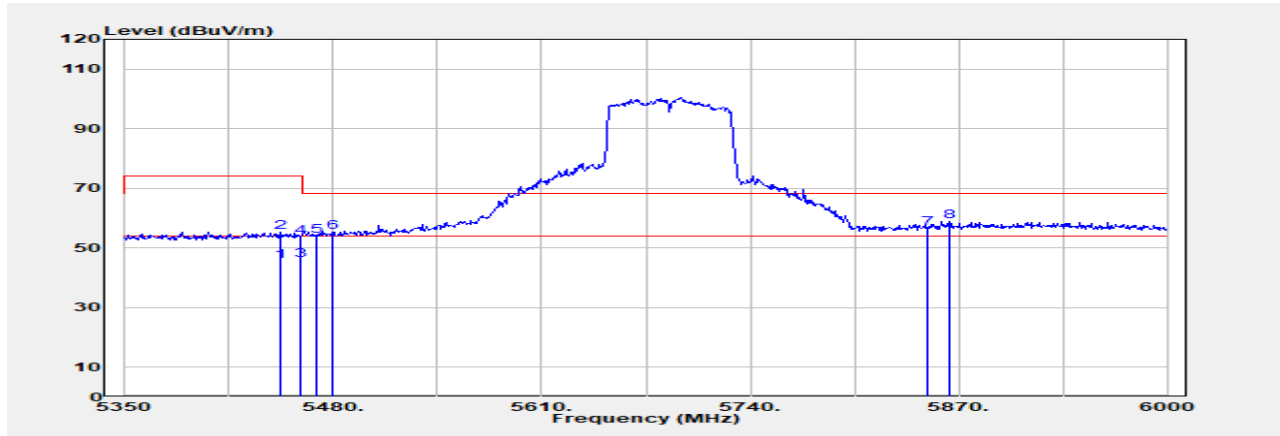

Freq. MHz	Detector Mode PK/QP/AVG	Spectrum Reading Level dBμV	Factor dB	Actual FS dBμV/m	Limit @3m dBμV/m	Margin dB
5447.500	Average	39.47	6.00	45.47	54.00	-8.53
5447.500	Peak	49.36	6.00	55.36	74.00	-18.64
5460.000	Average	39.59	6.11	45.71	54.00	-8.29
5460.000	Peak	47.61	6.11	53.72	74.00	-20.28
5470.000	Peak	47.73	6.21	53.93	68.20	-14.27
5480.000	Peak	49.13	6.30	55.42	68.20	-12.78
5850.000	Peak	48.61	8.01	56.62	68.20	-11.58
5864.800	Peak	50.56	8.25	58.81	68.20	-9.39

Unless otherwise stated the results shown in this test report refer only to the sample(s) tested and such sample(s) are retained for 90 days only.

除非另有說明，此報告結果僅對測試之樣品負責，同時此樣品僅保留90天。本報告未經本公司書面許可，不可部份複製。

This document is issued by the Company subject to its General Conditions of Service printed overleaf, available on request or accessible at <http://www.sgs.com.tw/Terms-and-Conditions> and for electronic format documents, subject to Terms and Conditions for Electronic Documents at <http://www.sgs.com.tw/Terms-and-Conditions>. Attention is drawn to the limitation of liability, indemnification and jurisdiction issues defined therein. Any holder of this document is advised that information contained hereon reflects the Company's findings at the time of its intervention only and within the limits of Client's instructions, if any. The Company's sole responsibility is to its Client and this document does not exonerate parties to a transaction from exercising all their rights and obligations under the transaction documents. This document cannot be reproduced except in full, without prior written approval of the Company. Any unauthorized alteration, forgery or falsification of the content or appearance of this document is unlawful and offenders may be prosecuted to the fullest extent of the law.

Report Number :TERF2403000759E2
 Operation Mode :802.11ac80
 Test Frequency :5775 MHz
 Test Mode :Bandedge
 EUT Pol :E2 Plane

Test Site :SAC G Chamber
 Test Date :2024-03-29
 Temp./Humi. :24.3°C/58%
 Antenna Pol. :Vertical
 Engineer :Temo Chen

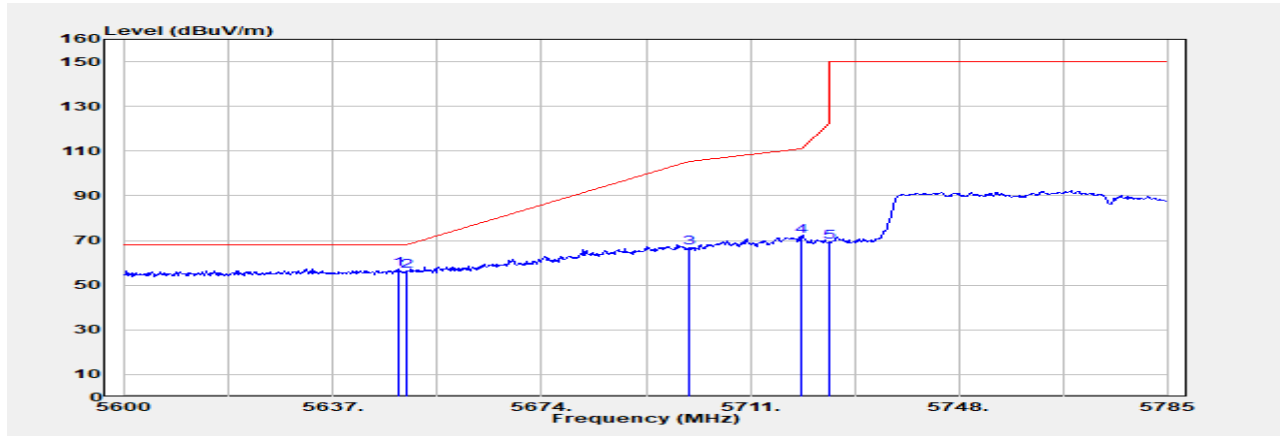

Freq. MHz	Detector Mode PK/QP/AVG	Spectrum Reading Level dB μ V	Factor dB	Actual FS dB μ V/m	Limit @3m dB μ V/m	Margin dB
5648.470	Peak	50.98	6.41	57.39	68.20	-10.81
5650.000	Peak	49.81	6.43	56.24	68.20	-11.96
5700.000	Peak	60.00	6.99	66.99	105.20	-38.21
5720.000	Peak	64.94	7.09	72.03	110.80	-38.77
5725.000	Peak	62.36	7.12	69.48	122.20	-52.72

Unless otherwise stated the results shown in this test report refer only to the sample(s) tested and such sample(s) are retained for 90 days only.

除非另有說明，此報告結果僅對測試之樣品負責，同時此樣品僅保留90天。本報告未經本公司書面許可，不可部份複製。

This document is issued by the Company subject to its General Conditions of Service printed overleaf, available on request or accessible at <http://www.sgs.com.tw/Terms-and-Conditions> and for electronic format documents, subject to Terms and Conditions for Electronic Documents at <http://www.sgs.com.tw/Terms-and-Conditions>. Attention is drawn to the limitation of liability, indemnification and jurisdiction issues defined therein. Any holder of this document is advised that information contained hereon reflects the Company's findings at the time of its intervention only and within the limits of Client's instructions, if any. The Company's sole responsibility is to its Client and this document does not exonerate parties to a transaction from exercising all their rights and obligations under the transaction documents. This document cannot be reproduced except in full, without prior written approval of the Company. Any unauthorized alteration, forgery or falsification of the content or appearance of this document is unlawful and offenders may be prosecuted to the fullest extent of the law.

Report Number :TERF2403000759E2
 Operation Mode :802.11ac80
 Test Frequency :5775 MHz
 Test Mode :Bandedge
 EUT Pol :E2 Plane

Test Site :SAC G Chamber
 Test Date :2024-03-29
 Temp./Humi. :24.3°C/58%
 Antenna Pol. :Horizontal
 Engineer :Temo Chen

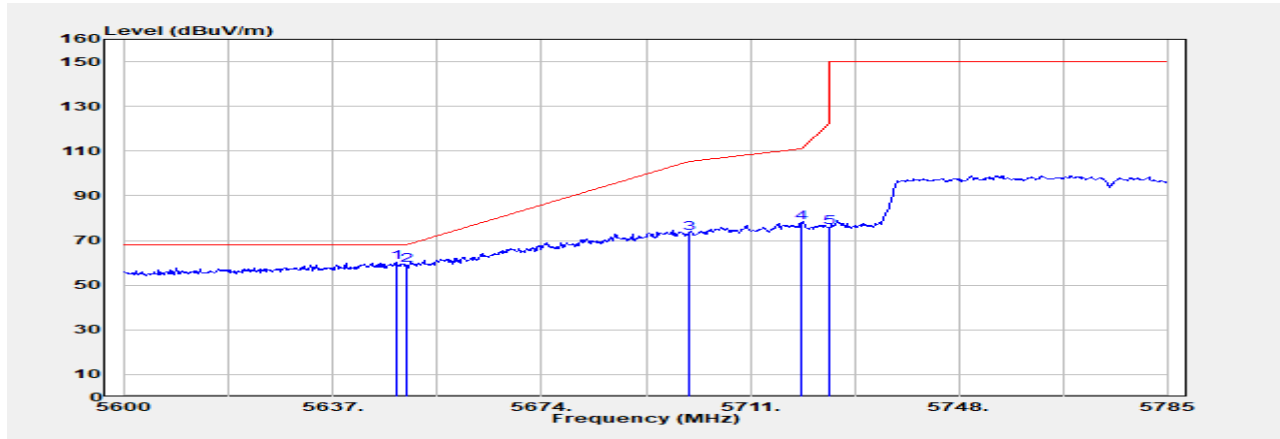

Freq. MHz	Detector Mode PK/QP/AVG	Spectrum Reading Level dBμV	Factor dB	Actual FS dBμV/m	Limit @3m dBμV/m	Margin dB
5648.100	Peak	53.77	6.41	60.19	68.20	-8.01
5650.000	Peak	52.58	6.43	59.00	68.20	-9.20
5700.000	Peak	66.22	6.99	73.21	105.20	-31.99
5720.000	Peak	71.04	7.09	78.14	110.80	-32.66
5725.000	Peak	68.86	7.12	75.98	122.20	-46.22

Unless otherwise stated the results shown in this test report refer only to the sample(s) tested and such sample(s) are retained for 90 days only.

除非另有說明，此報告結果僅對測試之樣品負責，同時此樣品僅保留90天。本報告未經本公司書面許可，不可部份複製。

This document is issued by the Company subject to its General Conditions of Service printed overleaf, available on request or accessible at <http://www.sgs.com.tw/Terms-and-Conditions> and for electronic format documents, subject to Terms and Conditions for Electronic Documents at <http://www.sgs.com.tw/Terms-and-Conditions>. Attention is drawn to the limitation of liability, indemnification and jurisdiction issues defined therein. Any holder of this document is advised that information contained hereon reflects the Company's findings at the time of its intervention only and within the limits of Client's instructions, if any. The Company's sole responsibility is to its Client and this document does not exonerate parties to a transaction from exercising all their rights and obligations under the transaction documents. This document cannot be reproduced except in full, without prior written approval of the Company. Any unauthorized alteration, forgery or falsification of the content or appearance of this document is unlawful and offenders may be prosecuted to the fullest extent of the law.

Report Number :TERF2403000759E2
 Operation Mode :802.11ac80
 Test Frequency :5775 MHz
 Test Mode :Bandedge
 EUT Pol :E2 Plane

Test Site :SAC G Chamber
 Test Date :2024-03-29
 Temp./Humi. :24.3°C/58%
 Antenna Pol. :Vertical
 Engineer :Temo Chen

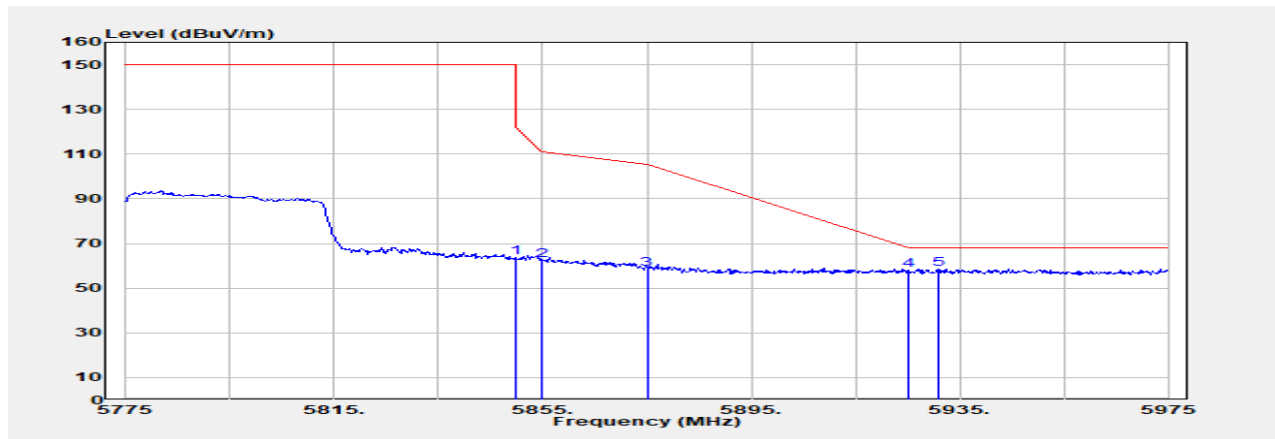

Freq. MHz	Detector Mode PK/QP/AVG	Spectrum Reading Level dB μ V	Factor dB	Actual FS dB μ V/m	Limit @3m dB μ V/m	Margin dB
5850.000	Peak	55.55	8.01	63.55	122.20	-58.65
5855.000	Peak	54.35	8.09	62.44	110.80	-48.36
5875.000	Peak	50.25	8.41	58.66	105.20	-46.54
5925.000	Peak	49.53	8.72	58.24	68.20	-9.96
5930.800	Peak	49.87	8.70	58.57	68.20	-9.63

Unless otherwise stated the results shown in this test report refer only to the sample(s) tested and such sample(s) are retained for 90 days only.

除非另有說明，此報告結果僅對測試之樣品負責，同時此樣品僅保留90天。本報告未經本公司書面許可，不可部份複製。

This document is issued by the Company subject to its General Conditions of Service printed overleaf, available on request or accessible at <http://www.sgs.com.tw/Terms-and-Conditions> and for electronic format documents, subject to Terms and Conditions for Electronic Documents at <http://www.sgs.com.tw/Terms-and-Conditions>. Attention is drawn to the limitation of liability, indemnification and jurisdiction issues defined therein. Any holder of this document is advised that information contained hereon reflects the Company's findings at the time of its intervention only and within the limits of Client's instructions, if any. The Company's sole responsibility is to its Client and this document does not exonerate parties to a transaction from exercising all their rights and obligations under the transaction documents. This document cannot be reproduced except in full, without prior written approval of the Company. Any unauthorized alteration, forgery or falsification of the content or appearance of this document is unlawful and offenders may be prosecuted to the fullest extent of the law.

Report Number :TERF2403000759E2
 Operation Mode :802.11ac80
 Test Frequency :5775 MHz
 Test Mode :Bandedge
 EUT Pol :E2 Plane

Test Site :SAC G Chamber
 Test Date :2024-03-29
 Temp./Humi. :24.3°C/58%
 Antenna Pol. :Horizontal
 Engineer :Temo Chen

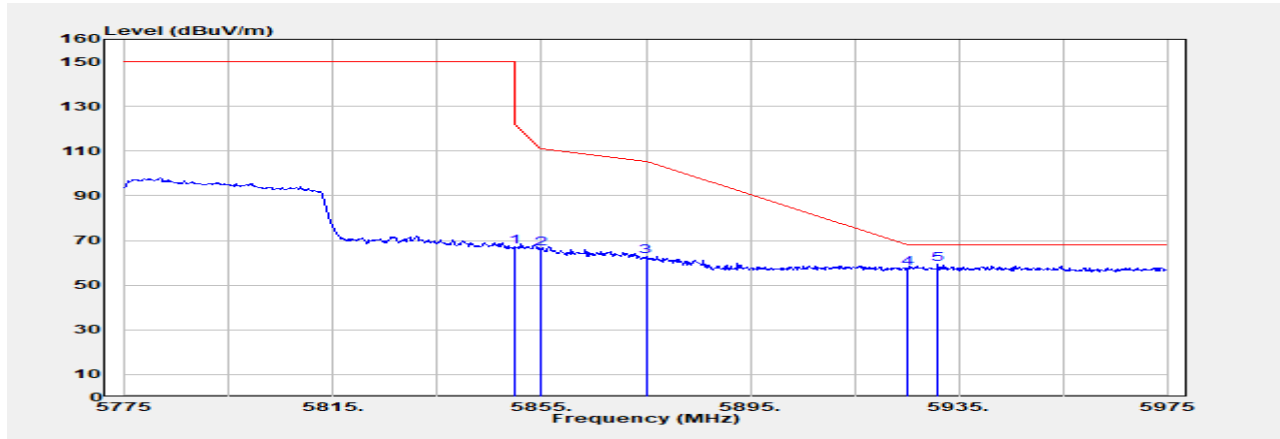

Freq. MHz	Detector Mode PK/QP/AVG	Spectrum Reading Level dB μ V	Factor dB	Actual FS dB μ V/m	Limit @3m dB μ V/m	Margin dB
5850.000	Peak	59.02	8.01	67.03	122.20	-55.17
5855.000	Peak	58.23	8.09	66.32	110.80	-44.48
5875.000	Peak	54.52	8.41	62.93	105.20	-42.27
5925.000	Peak	48.96	8.72	57.68	68.20	-10.52
5931.000	Peak	50.65	8.69	59.35	68.20	-8.85

~ End of Report ~

Unless otherwise stated the results shown in this test report refer only to the sample(s) tested and such sample(s) are retained for 90 days only.

除非另有說明，此報告結果僅對測試之樣品負責，同時此樣品僅保留90天。本報告未經本公司書面許可，不可部份複製。
 This document is issued by the Company subject to its General Conditions of Service printed overleaf, available on request or accessible at <http://www.sgs.com.tw/Terms-and-Conditions> and for electronic format documents, subject to Terms and Conditions for Electronic Documents at <http://www.sgs.com.tw/Terms-and-Conditions>. Attention is drawn to the limitation of liability, indemnification and jurisdiction issues defined therein. Any holder of this document is advised that information contained hereon reflects the Company's findings at the time of its intervention only and within the limits of Client's instructions, if any. The Company's sole responsibility is to its Client and this document does not exonerate parties to a transaction from exercising all their rights and obligations under the transaction documents. This document cannot be reproduced except in full, without prior written approval of the Company. Any unauthorized alteration, forgery or falsification of the content or appearance of this document is unlawful and offenders may be prosecuted to the fullest extent of the law.