

**ELECTROMAGNETIC EMISSIONS  
COMPLIANCE REPORT**

**Applicant:** Quanta Computer Inc.  
No. 188, Wenhua 2nd Road, Guishan District, Taoyuan City  
33377, Taiwan

**Manufacturer:** Quanta Computer Inc.  
No. 188, Wenhua 2nd Road, Guishan District, Taoyuan City  
33377, Taiwan

**Product Name:** Clover Companion

**Brand Name:** Clover

**Model No.:** C800

**Report Number:** TERF2404000848E2

**FCC ID** HFS-C800

**Date of EUT Received:** Mar. 29, 2024

**Date of Test:** Apr. 01, 2024~Apr. 11, 2024

**Issue Date:** May 03, 2024

*Arno Hsieh*  
**Approved By** \_\_\_\_\_  
**Arno Hsieh**

**We hereby certify that:**

The above equipment was tested by SGS Taiwan Ltd. Central RF Lab The test data, data evaluation, test procedures, and equipment configurations shown in this report were made in accordance with the procedures given in ANSI C63.10:2013 and the energy emitted by the sample EUT comply with FCC rule part §15.247.

The results of this report relate only to the sample identified in this report.

Unless otherwise stated the results shown in this test report refer only to the sample(s) tested and such sample(s) are retained for 90 days only.

除非另有說明，此報告結果僅對測試之樣品負責，同時此樣品僅保留90天。本報告未經本公司書面許可，不可部份複製。

This document is issued by the Company subject to its General Conditions of Service printed overleaf, available on request or accessible at <http://www.sgs.com.tw/Terms-and-Conditions> and for electronic format documents, subject to Terms and Conditions for Electronic Documents at <http://www.sgs.com.tw/Terms-and-Conditions>. Attention is drawn to the limitation of liability, indemnification and jurisdiction issues defined therein. Any holder of this document is advised that information contained hereon reflects the Company's findings at the time of its intervention only and within the limits of Client's instructions, if any. The Company's sole responsibility is to its Client and this document does not exonerate parties to a transaction from exercising all their rights and obligations under the transaction documents. This document cannot be reproduced except in full, without prior written approval of the Company. Any unauthorized alteration, forgery or falsification of the content or appearance of this document is unlawful and offenders may be prosecuted to the fullest extent of the law.

Revision History					
Report Number	Revision	Description	Issue Date	Revised By	Remark
TERF2404000848E2	00	Original	Apr. 26, 2024	Yami Kuo	
TERF2404000848E2	01	Revised chapter 1.2	May 03, 2024	Yami Kuo	*

**Note:**

- 1、The remark "\*" indicates modification of the report upon requests from certification body.

Unless otherwise stated the results shown in this test report refer only to the sample(s) tested and such sample(s) are retained for 90 days only.

除非另有說明，此報告結果僅對測試之樣品負責，同時此樣品僅保留90天。本報告未經本公司書面許可，不可部份複製。

This document is issued by the Company subject to its General Conditions of Service printed overleaf, available on request or accessible at <http://www.sgs.com.tw/Terms-and-Conditions> and for electronic format documents, subject to Terms and Conditions for Electronic Documents at <http://www.sgs.com.tw/Terms-and-Conditions>. Attention is drawn to the limitation of liability, indemnification and jurisdiction issues defined therein. Any holder of this document is advised that information contained hereon reflects the Company's findings at the time of its intervention only and within the limits of Client's instructions, if any. The Company's sole responsibility is to its Client and this document does not exonerate parties to a transaction from exercising all their rights and obligations under the transaction documents. This document cannot be reproduced except in full, without prior written approval of the Company. Any unauthorized alteration, forgery or falsification of the content or appearance of this document is unlawful and offenders may be prosecuted to the fullest extent of the law.

SGS Taiwan Ltd.

No.134,Wu Kung Road, New Taipei Industrial Park, Wuku District, New Taipei City, Taiwan/新北市五股區新北產業園區五工路 134 號

台灣檢驗科技股份有限公司

t (886-2) 2299-3279

f (886-2) 2298-0488

[www.sgs.com.tw](http://www.sgs.com.tw)

Member of SGS Group

## Table of Contents

1	GENERAL INFORMATION.....	4
2	SYSTEM TEST CONFIGURATION.....	7
3	SUMMARY OF TEST RESULTS .....	9
4	DESCRIPTION OF TEST MODES .....	10
5	MEASUREMENT UNCERTAINTY .....	12
6	MEASUREMENT EQUIPMENT USED .....	13
7	PEAK OUTPUT POWER MEASUREMENT .....	14
8	RADIATED BANDEDGE AND SPURIOUS EMISSION MEASUREMENT.....	19

Unless otherwise stated the results shown in this test report refer only to the sample(s) tested and such sample(s) are retained for 90 days only.

除非另有說明，此報告結果僅對測試之樣品負責，同時此樣品僅保留90天。本報告未經本公司書面許可，不可部份複製。

This document is issued by the Company subject to its General Conditions of Service printed overleaf, available on request or accessible at <http://www.sgs.com.tw/Terms-and-Conditions> and for electronic format documents, subject to Terms and Conditions for Electronic Documents at <http://www.sgs.com.tw/Terms-and-Conditions>. Attention is drawn to the limitation of liability, indemnification and jurisdiction issues defined therein. Any holder of this document is advised that information contained hereon reflects the Company's findings at the time of its intervention only and within the limits of Client's instructions, if any. The Company's sole responsibility is to its Client and this document does not exonerate parties to a transaction from exercising all their rights and obligations under the transaction documents. This document cannot be reproduced except in full, without prior written approval of the Company. Any unauthorized alteration, forgery or falsification of the content or appearance of this document is unlawful and offenders may be prosecuted to the fullest extent of the law.

SGS Taiwan Ltd.

No.134,Wu Kung Road, New Taipei Industrial Park, Wuku District, New Taipei City, Taiwan/新北市五股區新北產業園區五工路 134 號

台灣檢驗科技股份有限公司

t (886-2) 2299-3279

f (886-2) 2298-0488

[www.sgs.com.tw](http://www.sgs.com.tw)

Member of SGS Group

## 1 GENERAL INFORMATION

### 1.1 Product Description

Product Name:	Clover Companion
Brand Name:	Clover
Model No.:	C800
Hardware Version:	N/A
Firmware Version:	N/A
EUT Series No.:	C080UG40940094
Power Supply:	12Vdc
Test Software (Name/Version)	QRCT4.0.00206.0

### 1.2 RF Specification

#### WLAN 2.4GHz

Wi-Fi	Frequency Range	Channels	Rated Power (dBm)		Modulation Technology
			Peak	Avg.	
802.11b	2412~2462	11	11.23	8.99	DSSS
802.11g	2412~2462	11	15.68	11.26	OFDM
802.11n_HT20	2412~2462	11	15.63	11.05	OFDM
802.11n_HT40	2422~2452	7	18.39	13.28	OFDM
Modulation type:		CCK, DQPSK, DBPSK for DSSS in 802.11b			
		64QAM, 16QAM, QPSK, BPSK for OFDM in 802.11g, 11n			
Data Rate:		802.11b: 1/2/5.5/11 Mbps			
		802.11g: 6/9/12/18/24/36/48/54 Mbps			
		802.11n_HT20: up to 72.2Mbps			
		802.11n_HT40: up to 150Mbps			

Unless otherwise stated the results shown in this test report refer only to the sample(s) tested and such sample(s) are retained for 90 days only.

除非另有說明，此報告結果僅對測試之樣品負責，同時此樣品僅保留90天。本報告未經本公司書面許可，不可部份複製。

This document is issued by the Company subject to its General Conditions of Service printed overleaf, available on request or accessible at <http://www.sgs.com.tw/Terms-and-Conditions>, and for electronic format documents, subject to Terms and Conditions for Electronic Documents at <http://www.sgs.com.tw/Terms-and-Conditions>. Attention is drawn to the limitation of liability, indemnification and jurisdiction issues defined therein. Any holder of this document is advised that information contained hereon reflects the Company's findings at the time of its intervention only and within the limits of Client's instructions, if any. The Company's sole responsibility is to its Client and this document does not exonerate parties to a transaction from exercising all their rights and obligations under the transaction documents. This document cannot be reproduced except in full, without prior written approval of the Company. Any unauthorized alteration, forgery or falsification of the content or appearance of this document is unlawful and offenders may be prosecuted to the fullest extent of the law.

### 1.3 Antenna Designation

Antenna Type	Supplier	Antenna Part No.	Freq. (MHz)	Peak Antenna Gain (dBi)
PIFA	Advanced Wireless & Antenna INC.	ALF6Y-100004	2412-2462	0.78

**Note:**

1. Antenna information is provided by the applicant.

Unless otherwise stated the results shown in this test report refer only to the sample(s) tested and such sample(s) are retained for 90 days only.

除非另有說明，此報告結果僅對測試之樣品負責，同時此樣品僅保留90天。本報告未經本公司書面許可，不可部份複製。

This document is issued by the Company subject to its General Conditions of Service printed overleaf, available on request or accessible at <http://www.sgs.com.tw/Terms-and-Conditions> and for electronic format documents, subject to Terms and Conditions for Electronic Documents at <http://www.sgs.com.tw/Terms-and-Conditions>. Attention is drawn to the limitation of liability, indemnification and jurisdiction issues defined therein. Any holder of this document is advised that information contained hereon reflects the Company's findings at the time of its intervention only and within the limits of Client's instructions, if any. The Company's sole responsibility is to its Client and this document does not exonerate parties to a transaction from exercising all their rights and obligations under the transaction documents. This document cannot be reproduced except in full, without prior written approval of the Company. Any unauthorized alteration, forgery or falsification of the content or appearance of this document is unlawful and offenders may be prosecuted to the fullest extent of the law.

### 1.4 Test Methodology of Applied Standards

FCC Part 15, Subpart C §15.247  
 FCC KDB 558074 D01 15.247 Meas Guidance v05r02  
 ANSI C63.10:2013

### 1.5 Test Facility

Laboratory	Test Site Address	Test Site Name	FCC Designation number	IC CAB identifier
SGS Taiwan Ltd. Central RF Lab. (TAF code 3702)	No.134, Wu Kung Road, New Taipei Industrial Park, Wuku District, New Taipei City, Taiwan.	SAC 1	TW0027	TW3702
		SAC 2		
		SAC 3		
		Conduction 1		
		Conducted 1		
		Conducted 2		
		Conducted 3		
		Conducted 4		
		Conducted 5		
	Conducted 6			
	No.2, Keji 1st Rd., Guishan District, Taoyuan City, Taiwan 333	Conduction C	TW0028	
		SAC C		
		SAC D		
		SAC G		
		Conducted A		
		Conducted B		
		Conducted C		
		Conducted D		
		Conducted E		
Conducted F				
Conducted G				

**Note:** Test site name is remarked on the equipment list in each section of this report as an indication where measurements occurred in specific test site and address.

### 1.6 Special Accessories

There are no special accessories used while test was conducted.

### 1.7 Equipment Modifications

There was no modification incorporated into the EUT.

Unless otherwise stated the results shown in this test report refer only to the sample(s) tested and such sample(s) are retained for 90 days only.

除非另有說明，此報告結果僅對測試之樣品負責，同時此樣品僅保留90天。本報告未經本公司書面許可，不可部份複製。

This document is issued by the Company subject to its General Conditions of Service printed overleaf, available on request or accessible at <http://www.sgs.com.tw/Terms-and-Conditions>, and for electronic format documents, subject to Terms and Conditions for Electronic Documents at <http://www.sgs.com.tw/Terms-and-Conditions>. Attention is drawn to the limitation of liability, indemnification and jurisdiction issues defined therein. Any holder of this document is advised that information contained hereon reflects the Company's findings at the time of its intervention only and within the limits of Client's instructions, if any. The Company's sole responsibility is to its Client and this document does not exonerate parties to a transaction from exercising all their rights and obligations under the transaction documents. This document cannot be reproduced except in full, without prior written approval of the Company. Any unauthorized alteration, forgery or falsification of the content or appearance of this document is unlawful and offenders may be prosecuted to the fullest extent of the law.

## 2 SYSTEM TEST CONFIGURATION

### 2.1 EUT Configuration

The EUT configuration for testing is installed on RF field strength measurement to meet the Commissions requirement and operating in a manner which intends to maximize its emission characteristics in a continuous normal application.

### 2.2 EUT Exercise

An engineering test mode (software/firmware) that applicant provided was utilized to manipulate the EUT into transmit, selection of the test channel, and modulation scheme.

### 2.3 Test Procedure

#### 2.3.1 Conducted Emissions

The EUT is a placed on a table which is 0.8 m above ground plane. Conducted emissions from the EUT measured in the frequency range between 0.15 MHz and 30MHz. The CISPR Quasi-Peak and Average detector mode is employed. The two LISNs provide 50uH/50 ohm of coupling impedance for the measuring instrument. Both lines of the power mains connected to the EUT were checked for maximum conducted interference.

#### 2.3.2 Conducted Test (RF)

The active antenna port of the unlicensed wireless device is connected to the spectrum analyzer with attenuator to protect the instrumentation. If a second antenna port is available, it is tested at one operating frequency, with other port(s) appropriately terminated, to verify it has similar output characteristics as the fully tested port.

#### 2.3.3 Radiated Emissions

The EUT is a placed on a turn table. For emissions testing at or below 1 GHz, the table height shall be 0.8 m above the reference ground plane. For emission measurements above 1 GHz, the table height shall be 1.5 m. The turn table shall rotate 360 degrees to determine the position of maximum emission level. EUT is set 3m away from the receiving antenna which varied from 1m to 4m to find out the highest emission. And also, each emission was to be maximized by changing the polarization of receiving antenna both horizontal and vertical. In order to find out the max. emission, the relative positions of this transmitter (EUT) was rotated through three orthogonal axes and measurement procedures for electric field radiated emissions above 1 GHz the EUT measurement is to be made "while keeping the antenna in the 'cone of radiation' from that area and pointed at the area both in azimuth and elevation, with polarization oriented for maximum response." is still within the 3dB illumination BW of the measurement antenna.

Unless otherwise stated the results shown in this test report refer only to the sample(s) tested and such sample(s) are retained for 90 days only.

除非另有說明，此報告結果僅對測試之樣品負責，同時此樣品僅保留90天。本報告未經本公司書面許可，不可部份複製。

This document is issued by the Company subject to its General Conditions of Service printed overleaf, available on request or accessible at <http://www.sgs.com.tw/Terms-and-Conditions>, and for electronic format documents, subject to Terms and Conditions for Electronic Documents at <http://www.sgs.com.tw/Terms-and-Conditions>. Attention is drawn to the limitation of liability, indemnification and jurisdiction issues defined therein. Any holder of this document is advised that information contained hereon reflects the Company's findings at the time of its intervention only and within the limits of Client's instructions, if any. The Company's sole responsibility is to its Client and this document does not exonerate parties to a transaction from exercising all their rights and obligations under the transaction documents. This document cannot be reproduced except in full, without prior written approval of the Company. Any unauthorized alteration, forgery or falsification of the content or appearance of this document is unlawful and offenders may be prosecuted to the fullest extent of the law.

## 2.4 Measurement Results Explanation Example

### 2.4.1 Radiated Emission Test Sites For Measurements From 9 kHz To 30 MHz

Radiated emission below 30MHz is measured in a 9m\*6m\*6m semi-anechoic chamber, the measurements correspond to those obtained at an open-field test site.

There is a comparison data of both open-field test site and semi-Anechoic chamber, and the result came out very similar.

### 2.4.2 For all conducted test items:

The offset level is set in the spectrum analyzer to compensate the RF cable loss and attenuation factor between EUT conducted port and spectrum analyzer. With the offset compensation, the spectrum analyzer reading level is exactly EUT RF output level.

## 2.5 Test Configuration

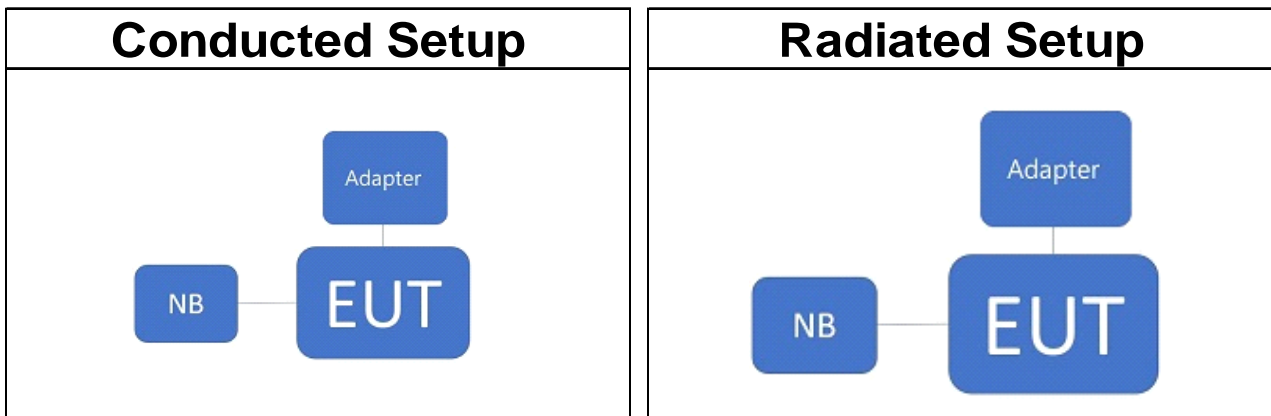

## 2.6 Control Unit(s)

Conducted Emission Test Site: Conducted C					
EQUIPMENT TYPE	MFR	MODEL NUMBER	SERIAL NUMBER	LAST CAL.	CAL DUE.
Adapter	clover	S024CEU1200200	N/A	N/A	N/A
Notebook	Lenovo	T14	P0003332	N/A	N/A

Radiated Emission Test Site: SAC G					
EQUIPMENT TYPE	MFR	MODEL NUMBER	SERIAL NUMBER	LAST CAL.	CAL DUE.
Adapter	clover	S024CEU1200200	N/A	N/A	N/A
Notebook	Lenovo	L480	P0002332	N/A	N/A

Unless otherwise stated the results shown in this test report refer only to the sample(s) tested and such sample(s) are retained for 90 days only.

除非另有說明，此報告結果僅對測試之樣品負責，同時此樣品僅保留90天。本報告未經本公司書面許可，不可部份複製。

This document is issued by the Company subject to its General Conditions of Service printed overleaf, available on request or accessible at <http://www.sgs.com.tw/Terms-and-Conditions>, and for electronic format documents, subject to Terms and Conditions for Electronic Documents at <http://www.sgs.com.tw/Terms-and-Conditions>. Attention is drawn to the limitation of liability, indemnification and jurisdiction issues defined therein. Any holder of this document is advised that information contained herein reflects the Company's findings at the time of its intervention only and within the limits of Client's instructions, if any. The Company's sole responsibility is to its Client and this document does not exonerate parties to a transaction from exercising all their rights and obligations under the transaction documents. This document cannot be reproduced except in full, without prior written approval of the Company. Any unauthorized alteration, forgery or falsification of the content or appearance of this document is unlawful and offenders may be prosecuted to the fullest extent of the law.



### 3 SUMMARY OF TEST RESULTS

FCC Rules	Description Of Test	Result
§15.247(b) (3)	Peak Output Power	Compliant
§15.209 §15.247(d)	Radiated Band Edge and Spurious Emission	Compliant

Unless otherwise stated the results shown in this test report refer only to the sample(s) tested and such sample(s) are retained for 90 days only.

除非另有說明，此報告結果僅對測試之樣品負責，同時此樣品僅保留90天。本報告未經本公司書面許可，不可部份複製。

This document is issued by the Company subject to its General Conditions of Service printed overleaf, available on request or accessible at <http://www.sgs.com.tw/Terms-and-Conditions> and for electronic format documents, subject to Terms and Conditions for Electronic Documents at <http://www.sgs.com.tw/Terms-and-Conditions>. Attention is drawn to the limitation of liability, indemnification and jurisdiction issues defined therein. Any holder of this document is advised that information contained hereon reflects the Company's findings at the time of its intervention only and within the limits of Client's instructions, if any. The Company's sole responsibility is to its Client and this document does not exonerate parties to a transaction from exercising all their rights and obligations under the transaction documents. This document cannot be reproduced except in full, without prior written approval of the Company. Any unauthorized alteration, forgery or falsification of the content or appearance of this document is unlawful and offenders may be prosecuted to the fullest extent of the law.

SGS Taiwan Ltd.

No.134,Wu Kung Road, New Taipei Industrial Park, Wuku District, New Taipei City, Taiwan/新北市五股區新北產業園區五工路 134 號

台灣檢驗科技股份有限公司

t (886-2) 2299-3279

f (886-2) 2298-0488

[www.sgs.com.tw](http://www.sgs.com.tw)

Member of SGS Group

## 4 DESCRIPTION OF TEST MODES

### 4.1 Operating Frequencies

2400~2483.5 MHz			
20MHz		40MHz	
CH	Freq. (MHz)	CH	Freq. (MHz)
1	2412	3	2422
2	2417	4	2427
3	2422	5	2432
4	2427	6	2437
5	2432	7	2442
6	2437	8	2447
7	2442	9	2452
8	2447		
9	2452		
10	2457		
11	2462		

Unless otherwise stated the results shown in this test report refer only to the sample(s) tested and such sample(s) are retained for 90 days only.

除非另有說明，此報告結果僅對測試之樣品負責，同時此樣品僅保留90天。本報告未經本公司書面許可，不可部份複製。

This document is issued by the Company subject to its General Conditions of Service printed overleaf, available on request or accessible at <http://www.sgs.com.tw/Terms-and-Conditions> and for electronic format documents, subject to Terms and Conditions for Electronic Documents at <http://www.sgs.com.tw/Terms-and-Conditions>. Attention is drawn to the limitation of liability, indemnification and jurisdiction issues defined therein. Any holder of this document is advised that information contained hereon reflects the Company's findings at the time of its intervention only and within the limits of Client's instructions, if any. The Company's sole responsibility is to its Client and this document does not exonerate parties to a transaction from exercising all their rights and obligations under the transaction documents. This document cannot be reproduced except in full, without prior written approval of the Company. Any unauthorized alteration, forgery or falsification of the content or appearance of this document is unlawful and offenders may be prosecuted to the fullest extent of the law.

#### 4.2 The Worst Test Modes and Channel Details

1. The EUT has been tested under operating condition.
2. Test program used to control the EUT for staying in continuous transmitting and receiving mode is programmed.
3. Investigation has been done on all the possible configurations for searching the worst case.

The gevin UE is pre-scanned among below modes.

Modulation	Transmission Chain				Single Transmission Spatial	Multiple Transmission Spatial
<input checked="" type="checkbox"/> 802.11 b	<input checked="" type="checkbox"/> Ch0	<input type="checkbox"/> Ch1	<input type="checkbox"/> Ch2	<input type="checkbox"/> Ch3	<input checked="" type="checkbox"/> 1TX	<input type="checkbox"/> MIMO
<input checked="" type="checkbox"/> 802.11 g	<input checked="" type="checkbox"/> Ch0	<input type="checkbox"/> Ch1	<input type="checkbox"/> Ch2	<input type="checkbox"/> Ch3	<input checked="" type="checkbox"/> 1TX	<input type="checkbox"/> MIMO
<input checked="" type="checkbox"/> 802.11 n	<input checked="" type="checkbox"/> Ch0	<input type="checkbox"/> Ch1	<input type="checkbox"/> Ch2	<input type="checkbox"/> Ch3	<input checked="" type="checkbox"/> 1TX	<input type="checkbox"/> MIMO
<input type="checkbox"/> 802.11 ax	<input type="checkbox"/> Ch0	<input type="checkbox"/> Ch1	<input type="checkbox"/> Ch2	<input type="checkbox"/> Ch3	<input type="checkbox"/> 1TX	<input type="checkbox"/> MIMO

4. Therefore, below summary is the modes of test configuration that yield the highest reading and generate the highest emission chosen to carry out the relevantly mandatory test items.

CONDUCTED TEST					
MODE	AVAILABLE CHANNEL	TESTED CHANNEL	MODULATION	DATA RATE (Mbps)	ANTENNA PORT
802.11b	1 to 11	1,6,11	DSSS	1	ch0
802.11g	1 to 11	1,6,11	OFDM	6	ch0
802.11n_HT20	1 to 11	1,6,11	OFDM	MCS0	ch0
802.11n_HT40	3 to 9	3,6,9	OFDM	MCS0	ch0

TRANSMIT RADIATED EMISSION TEST (BELOW 1 GHz)					
MODE	AVAILABLE CHANNEL	TESTED CHANNEL	MODULATION	DATA RATE (Mbps)	ANTENNA PORT
802.11g	1 to 11	6	OFDM	6	ch0

TRANSMIT RADIATED EMISSION TEST (ABOVE 1 GHz)					
MODE	AVAILABLE CHANNEL	TESTED CHANNEL	MODULATION	DATA RATE (Mbps)	ANTENNA PORT
802.11b	1 to 11	1,6,11	DSSS	1	ch0
802.11g	1 to 11	1,6,11	OFDM	6	ch0
802.11n_HT20	1 to 11	1,6,11	OFDM	MCS0	ch0
802.11n_HT40	3 to 9	3,6,9	OFDM	MCS0	ch0

**Note:**

The field strength of radiated emission was measured as the EUT positioned in different orthogonal planes (E1/E2/H) based on actual usage of the EUT to pre-scan the emissions for determining the worst case scenario.

Unless otherwise stated the results shown in this test report refer only to the sample(s) tested and such sample(s) are retained for 90 days only.  
 除非另有說明，此報告結果僅對測試之樣品負責，同時此樣品僅保留90天。本報告未經本公司書面許可，不可部份複製。

This document is issued by the Company subject to its General Conditions of Service printed overleaf, available on request or accessible at <http://www.sgs.com.tw/Terms-and-Conditions>, and for electronic format documents, subject to Terms and Conditions for Electronic Documents at <http://www.sgs.com.tw/Terms-and-Conditions>. Attention is drawn to the limitation of liability, indemnification and jurisdiction issues defined therein. Any holder of this document is advised that information contained hereon reflects the Company's findings at the time of its intervention only and within the limits of Client's instructions, if any. The Company's sole responsibility is to its Client and this document does not exonerate parties to a transaction from exercising all their rights and obligations under the transaction documents. This document cannot be reproduced except in full, without prior written approval of the Company. Any unauthorized alteration, forgery or falsification of the content or appearance of this document is unlawful and offenders may be prosecuted to the fullest extent of the law.

## 5 MEASUREMENT UNCERTAINTY

Test Items	Uncertainty
AC Power Line Conducted Emission	+/- 1.54 dB
Output Power measurement	+/- 0.97 dB
Emission Bandwidth	+/- 1.38 Hz
Conducted emission measurement	+/- 0.77 dB
Peak Power Density	+/- 0.61 dB
Temperature	+/- 0.6 °C
Humidity	+/- 3 %
DC / AC Power Source	+/- 1 %

Radiated Spurious Emission Measurement Uncertainty			
Polarization: Vertical	+/-	1.89 dB	9kHz~30MHz
	+/-	4.15 dB	30MHz - 1000MHz
	+/-	3.43 dB	1GHz - 18GHz
	+/-	3.86 dB	18GHz - 40GHz
Polarization: Horizontal	+/-	1.89 dB	9kHz~30MHz
	+/-	4.02 dB	30MHz - 1000MHz
	+/-	3.43 dB	1GHz - 18GHz
	+/-	3.86 dB	18GHz - 40GHz
Radiated Spurious Emission	+/-	2 dB	33GHz-50GHz
	+/-	1.59 dB	50GHz-60GHz
	+/-	1.7 dB	60GHz-90GHz
	+/-	1.64 dB	90GHz-140GHz
	+/-	3.83 dB	140GHz-220GHz

### Note:

1. This uncertainty represents an expanded uncertainty expressed at approximately the 95% confidence level using a coverage factor of k=2.
2. The conformity assessment statement in this report is based solely on the test results, measurement uncertainty is excluded.

Unless otherwise stated the results shown in this test report refer only to the sample(s) tested and such sample(s) are retained for 90 days only.

除非另有說明，此報告結果僅對測試之樣品負責，同時此樣品僅保留90天。本報告未經本公司書面許可，不可部份複製。

This document is issued by the Company subject to its General Conditions of Service printed overleaf, available on request or accessible at <http://www.sgs.com.tw/Terms-and-Conditions> and for electronic format documents, subject to Terms and Conditions for Electronic Documents at <http://www.sgs.com.tw/Terms-and-Conditions>. Attention is drawn to the limitation of liability, indemnification and jurisdiction issues defined therein. Any holder of this document is advised that information contained hereon reflects the Company's findings at the time of its intervention only and within the limits of Client's instructions, if any. The Company's sole responsibility is to its Client and this document does not exonerate parties to a transaction from exercising all their rights and obligations under the transaction documents. This document cannot be reproduced except in full, without prior written approval of the Company. Any unauthorized alteration, forgery or falsification of the content or appearance of this document is unlawful and offenders may be prosecuted to the fullest extent of the law.

## 6 MEASUREMENT EQUIPMENT USED

### 6.1 Condcuted Measurement

Conducted Emission Test Site: Conducted C					
EQUIPMENT TYPE	MFR	MODEL NUMBER	SERIAL NUMBER	LAST CAL.	CAL DUE.
Spectrum Analyzer	KEYSIGHT	N9010B	MY59071573	05/23/2023	05/22/2024
Power Meter	Anritsu	ML2496A	2138002	08/31/2023	08/30/2024
Power Sensor	Anritsu	MA2411B	1911390	08/31/2023	08/30/2024
Power Sensor	Anritsu	MA2411B	1911398	08/31/2023	08/30/2024
Test Software	SGS Taiwan	Radio Test Software	Ver.21	N.C.R	N.C.R
Attenuator	Woken	WATT-218FS-10	RF18	11/15/2023	11/14/2024
Attenuator	Woken	WATT-218FS-10	RF19	11/15/2023	11/14/2024
DC Block	PASTERNAK	PE8210	RF155	11/15/2023	11/14/2024

### 6.2 Radiated Measurement

Radiated Emission Test Site: SAC G					
EQUIPMENT TYPE	MFR	MODEL NUMBER	SERIAL NUMBER	LAST CAL.	CAL DUE.
Broadband Antenna	SCHWARZBECK	VULB 9168	1208	07/21/2023	07/20/2024
Horn Antenna	Schwarzbeck	BBHA9170	185	08/21/2023	08/20/2024
Horn Antenna	RF SPIN	DRH18-E	210105A18E	04/18/2023	04/17/2024
Loop Antenna	ETS.LINDGREN	6502	143303	05/23/2023	05/22/2024
3m Site NSA	SGS	966 chamber G	N/A	03/30/2024	03/29/2025
Spectrum Analyzer	KEYSIGHT	N9010A	MY51440113	07/17/2023	07/16/2024
Test Software	audix	e3	E3 20923 SGS Ver.9 (C)	N.C.R	N.C.R
Pre-Amplifier	EMC Instruments	EMC330N	980781	03/15/2024	03/14/2025
Pre-Amplifier	EMC Instruments	EMC118A45SE	980815	03/15/2024	03/14/2025
Pre-Amplifier	EMC Instruments	EMC184945SEE	980938	11/15/2023	11/14/2024
Coaxial Cable	EMC Instruments	EMCCFD400-NM-NM-8000-5000-2000	210216、210217、210218	03/15/2024	03/14/2025
Coaxial Cable	EMC Instruments	EMC104-SM-SM-8000-5000-5000	210219、210220、210221	03/15/2024	03/14/2025

**NOTE:** N.C.R refers to Not Calibrated Required.

Unless otherwise stated the results shown in this test report refer only to the sample(s) tested and such sample(s) are retained for 90 days only.

除非另有說明，此報告結果僅對測試之樣品負責，同時此樣品僅保留90天。本報告未經本公司書面許可，不可部份複製。

This document is issued by the Company subject to its General Conditions of Service printed overleaf, available on request or accessible at <http://www.sgs.com.tw/Terms-and-Conditions>, and for electronic format documents, subject to Terms and Conditions for Electronic Documents at <http://www.sgs.com.tw/Terms-and-Conditions>. Attention is drawn to the limitation of liability, indemnification and jurisdiction issues defined therein. Any holder of this document is advised that information contained hereon reflects the Company's findings at the time of its intervention only and within the limits of Client's instructions, if any. The Company's sole responsibility is to its Client and this document does not exonerate parties to a transaction from exercising all their rights and obligations under the transaction documents. This document cannot be reproduced except in full, without prior written approval of the Company. Any unauthorized alteration, forgery or falsification of the content or appearance of this document is unlawful and offenders may be prosecuted to the fullest extent of the law.

## 7 PEAK OUTPUT POWER MEASUREMENT

### 7.1 Standard Applicable

#### 7.1.1 Duty Cycle

Pre-analysis Check: While conducting average power measurement, duty cycle of each mode shall be checked to ensure its duty cycle in order to compensate for the loss due to insufficient ratio of duty cycle.

All duty cycle is pre-scanned, and result as obtained below shows only the most representative ones where duty cycle is conducted as the given transmission with given virtual operation that expresses the percentage.

#### 7.1.2 FCC

For systems using digital modulation in the 2400-2483.5 MHz bands, the limit for peak output power is 1Watt.

If the transmitting antenna of directional gain greater than 6dBi are used the peak output power from the intentional radiator shall be reduced below the above stated value by the amount in dB that the directional gain of the Antenna exceeds 6dBi.

In case of point-to-point operation, the limit has to be reduced by 1dB for every 3dB that the directional gain of Antenna exceeds 6dBi.

The antenna gain is not greater than 6 dBi. Therefore, reduction of power is not required.

### 7.2 Test Setup

#### 7.2.1 Duty Cycle

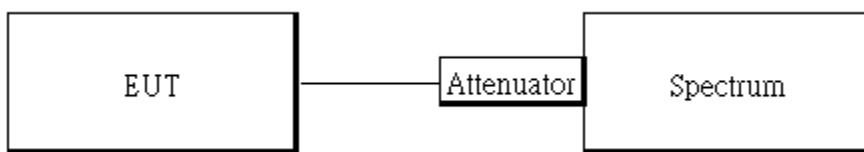

#### 7.2.2 Output Power:

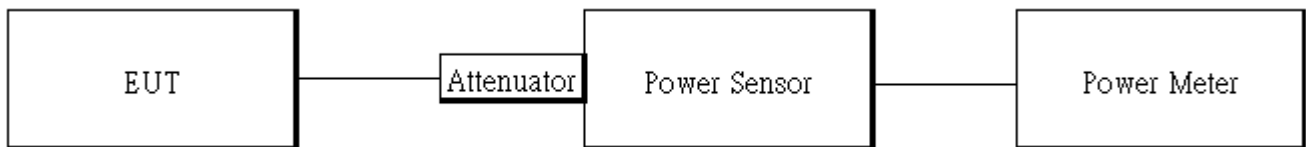

Unless otherwise stated the results shown in this test report refer only to the sample(s) tested and such sample(s) are retained for 90 days only.

除非另有說明，此報告結果僅對測試之樣品負責，同時此樣品僅保留90天。本報告未經本公司書面許可，不可部份複製。  
 This document is issued by the Company subject to its General Conditions of Service printed overleaf, available on request or accessible at <http://www.sgs.com.tw/Terms-and-Conditions> and for electronic format documents, subject to Terms and Conditions for Electronic Documents at <http://www.sgs.com.tw/Terms-and-Conditions>. Attention is drawn to the limitation of liability, indemnification and jurisdiction issues defined therein. Any holder of this document is advised that information contained herein reflects the Company's findings at the time of its intervention only and within the limits of Client's instructions, if any. The Company's sole responsibility is to its Client and this document does not exonerate parties to a transaction from exercising all their rights and obligations under the transaction documents. This document cannot be reproduced except in full, without prior written approval of the Company. Any unauthorized alteration, forgery or falsification of the content or appearance of this document is unlawful and offenders may be prosecuted to the fullest extent of the law.

### 7.3 Measurement Procedure

#### 7.3.1 Duty Cycle:

1. Set span = Zero
2. RBW = 8MHz
3. VBW = 8MHz,
4. Detector = Peak

#### 7.3.2 Output Power

1. Place the EUT on the table and set it in transmitting mode.
2. The testing follows the Measurement Procedure of FCC KDB 558074 D01 DTS Meas. Guidance .
3. Remove the antenna from the EUT and then connect a low loss RF cable from the antenna port to the power meter.

##### **Power Meter:**

It is used as the auxiliary test equipment to conduct the output power measurement.

4. Record the max. Reading as observed from Spectrum or Power Meter.

**\* Note: The duty cycle factor and below is compensated to obtain the maximum value of measurement in average.**

Unless otherwise stated the results shown in this test report refer only to the sample(s) tested and such sample(s) are retained for 90 days only.  
除非另有說明，此報告結果僅對測試之樣品負責，同時此樣品僅保留90天。本報告未經本公司書面許可，不可部份複製。

This document is issued by the Company subject to its General Conditions of Service printed overleaf, available on request or accessible at <http://www.sgs.com.tw/Terms-and-Conditions> and for electronic format documents, subject to Terms and Conditions for Electronic Documents at <http://www.sgs.com.tw/Terms-and-Conditions>. Attention is drawn to the limitation of liability, indemnification and jurisdiction issues defined therein. Any holder of this document is advised that information contained hereon reflects the Company's findings at the time of its intervention only and within the limits of Client's instructions, if any. The Company's sole responsibility is to its Client and this document does not exonerate parties to a transaction from exercising all their rights and obligations under the transaction documents. This document cannot be reproduced except in full, without prior written approval of the Company. Any unauthorized alteration, forgery or falsification of the content or appearance of this document is unlawful and offenders may be prosecuted to the fullest extent of the law.

## 7.4 Measurement Result

### 7.4.1 Duty Cycle:

Mode	Duty Cycle (%) = Ton / (Ton+Toff)	Duty Factor (dB) =10*log ( 1/Duty Cycle )	1/T (kHz)	VBW setting (kHz)
802.11b	99.00	0.04	0.08	0.01
802.11g	98.24	0.08	0.48	0.01
802.11n_20	98.11	0.08	0.52	0.01
802.11n_40	94.79	0.23	1.06	2.00

### 7.4.2 Duty Cycle test plots

802.11b\_20MHz\_Chain0\_2412MHz

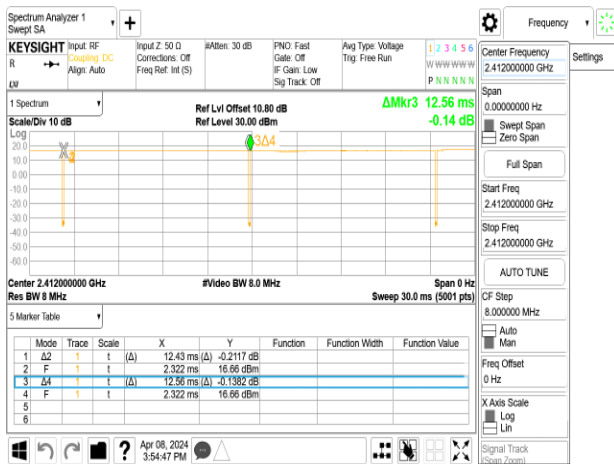

802.11n\_20MHz\_Chain0\_2412MHz

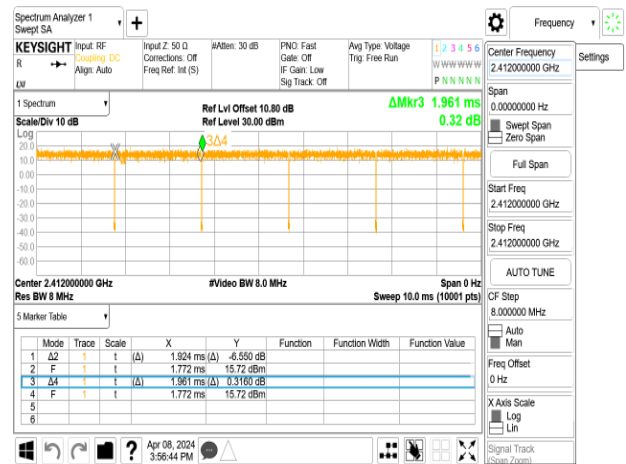

802.11g\_20MHz\_Chain0\_2412MHz

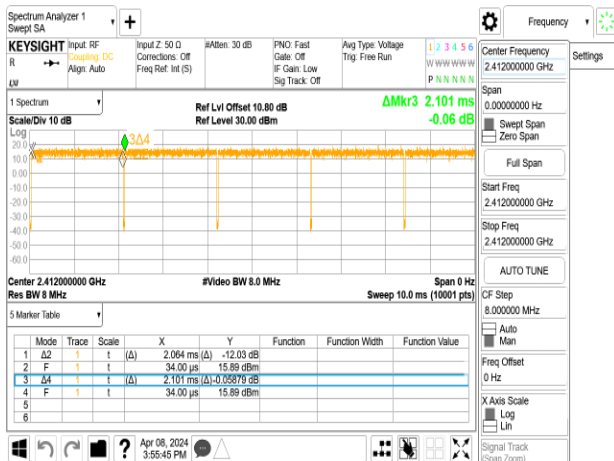

802.11n\_40MHz\_Chain0\_2422MHz

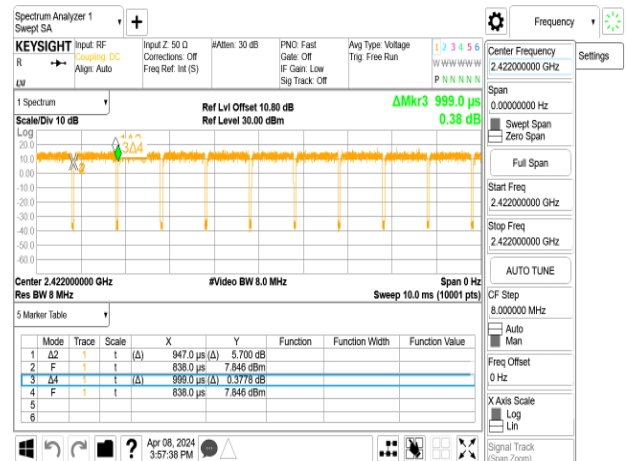

Unless otherwise stated the results shown in this test report refer only to the sample(s) tested and such sample(s) are retained for 90 days only.

除非另有說明，此報告結果僅對測試之樣品負責，同時此樣品僅保留90天。本報告未經本公司書面許可，不可部份複製。

This document is issued by the Company subject to its General Conditions of Service printed overleaf, available on request or accessible at <http://www.sgs.com.tw/Terms-and-Conditions>, and for electronic format documents, subject to Terms and Conditions for Electronic Documents at <http://www.sgs.com.tw/Terms-and-Conditions>. Attention is drawn to the limitation of liability, indemnification and jurisdiction issues defined therein. Any holder of this document is advised that information contained hereon reflects the Company's findings at the time of its intervention only and within the limits of Client's instructions, if any. The Company's sole responsibility is to its Client and this document does not exonerate parties to a transaction from exercising all their rights and obligations under the transaction documents. This document cannot be reproduced except in full, without prior written approval of the Company. Any unauthorized alteration, forgery or falsification of the content or appearance of this document is unlawful and offenders may be prosecuted to the fullest extent of the law.



## 7.4.3 Output Power

802.11b Ch0						
CH	Freq. (MHz)	Data Rate	Power Setting	Peak Output Power (dBm)	Limit (dBm)	RESULT
1	2412	1	8	9.82	30.00	PASS
6	2437	1	6.5	8.12	30.00	PASS
11	2462	1	9	<b>11.23</b>	30.00	PASS
802.11b Ch0						
CH	Freq. (MHz)	Data Rate	Power Setting	Avg. Output Power (dBm)	Limit (dBm)	RESULT
1	2412	1	8	7.51	30.00	PASS
6	2437	1	6.5	5.92	30.00	PASS
11	2462	1	9	<b>8.99</b>	30.00	PASS

802.11g Ch0						
CH	Freq. (MHz)	Data Rate	Power Setting	Peak Output Power (dBm)	Limit (dBm)	RESULT
1	2412	6	10.5	14.51	30.00	PASS
6	2437	6	11	14.95	30.00	PASS
11	2462	6	11.5	<b>15.68</b>	30.00	PASS
802.11g Ch0						
CH	Freq. (MHz)	Data Rate	Power Setting	Avg. Output Power (dBm)	Limit (dBm)	RESULT
1	2412	6	10.5	10.03	30.00	PASS
6	2437	6	11	10.37	30.00	PASS
11	2462	6	11.5	<b>11.26</b>	30.00	PASS

Unless otherwise stated the results shown in this test report refer only to the sample(s) tested and such sample(s) are retained for 90 days only.

除非另有說明，此報告結果僅對測試之樣品負責，同時此樣品僅保留90天。本報告未經本公司書面許可，不可部份複製。

This document is issued by the Company subject to its General Conditions of Service printed overleaf, available on request or accessible at <http://www.sgs.com.tw/Terms-and-Conditions> and for electronic format documents, subject to Terms and Conditions for Electronic Documents at <http://www.sgs.com.tw/Terms-and-Conditions>. Attention is drawn to the limitation of liability, indemnification and jurisdiction issues defined therein. Any holder of this document is advised that information contained hereon reflects the Company's findings at the time of its intervention only and within the limits of Client's instructions, if any. The Company's sole responsibility is to its Client and this document does not exonerate parties to a transaction from exercising all their rights and obligations under the transaction documents. This document cannot be reproduced except in full, without prior written approval of the Company. Any unauthorized alteration, forgery or falsification of the content or appearance of this document is unlawful and offenders may be prosecuted to the fullest extent of the law.

802.11n_HT_20M Ch0						
CH	Freq. (MHz)	Data Rate	Power Setting	Peak Output Power (dBm)	Limit (dBm)	RESULT
1	2412	MCS0	11	14.83	30.00	PASS
6	2437	MCS0	11	14.98	30.00	PASS
11	2462	MCS0	11.5	<b>15.63</b>	30.00	PASS
802.11n_HT_20M Ch0						
CH	Freq. (MHz)	Data Rate	Power Setting	Avg. Output Power (dBm)	Limit (dBm)	RESULT
1	2412	MCS0	11	10.25	30.00	PASS
6	2437	MCS0	11	10.20	30.00	PASS
11	2462	MCS0	11.5	<b>11.05</b>	30.00	PASS

802.11n_HT_40M Ch0						
CH	Freq. (MHz)	Data Rate	Power Setting	Peak Output Power (dBm)	Limit (dBm)	RESULT
3	2422	MCS0	10.5	17.05	30.00	PASS
6	2437	MCS0	13.5	<b>18.39</b>	30.00	PASS
9	2452	MCS0	12	18.34	30.00	PASS
802.11n_HT_40M Ch0						
CH	Freq. (MHz)	Data Rate	Power Setting	Avg. Output Power (dBm)	Limit (dBm)	RESULT
3	2422	MCS0	10.5	10.53	30.00	PASS
6	2437	MCS0	13.5	<b>13.28</b>	30.00	PASS
9	2452	MCS0	12	12.52	30.00	PASS

Unless otherwise stated the results shown in this test report refer only to the sample(s) tested and such sample(s) are retained for 90 days only.

除非另有說明，此報告結果僅對測試之樣品負責，同時此樣品僅保留90天。本報告未經本公司書面許可，不可部份複製。

This document is issued by the Company subject to its General Conditions of Service printed overleaf, available on request or accessible at <http://www.sgs.com.tw/Terms-and-Conditions>, and for electronic format documents, subject to Terms and Conditions for Electronic Documents at <http://www.sgs.com.tw/Terms-and-Conditions>. Attention is drawn to the limitation of liability, indemnification and jurisdiction issues defined therein. Any holder of this document is advised that information contained hereon reflects the Company's findings at the time of its intervention only and within the limits of Client's instructions, if any. The Company's sole responsibility is to its Client and this document does not exonerate parties to a transaction from exercising all their rights and obligations under the transaction documents. This document cannot be reproduced except in full, without prior written approval of the Company. Any unauthorized alteration, forgery or falsification of the content or appearance of this document is unlawful and offenders may be prosecuted to the fullest extent of the law.

## 8 RADIATED BANDEDGE AND SPURIOUS EMISSION MEASUREMENT

### 8.1 Standard Applicable

In any 100 kHz bandwidth outside the frequency band in which the spread spectrum or digitally modulated intentional radiator is operating, the radio frequency power that is produced by the intentional radiator shall be at least 20 dB below that in the 100 kHz bandwidth within the band that contains the highest level of the desired power, based on either an RF conducted or a radiated measurement, provided the transmitter demonstrates compliance with the peak conducted power limits. In addition, radiated emissions which fall in the restricted bands must also comply with the §15.209 limit as below.

And according to §15.33(a) (1), for an intentional radiator operates below 10GHz, the frequency range of measurements: to the tenth harmonic of the highest fundamental frequency or to 40GHz, whichever is lower.

Frequency (MHz)	Field strength (microvolts/meter)	Distance (meters)
0.009-0.490	2400/F(kHz)	300
0.490-1.705	24000/F(kHz)	30
1.705-30	30	30
30-88	100	3
88-216	150	3
216-960	200	3
Above 960	500	3

**Note:**

1. The lower limit shall apply at the transition frequencies.

Unless otherwise stated the results shown in this test report refer only to the sample(s) tested and such sample(s) are retained for 90 days only.

除非另有說明，此報告結果僅對測試之樣品負責，同時此樣品僅保留90天。本報告未經本公司書面許可，不可部份複製。

This document is issued by the Company subject to its General Conditions of Service printed overleaf, available on request or accessible at <http://www.sgs.com.tw/Terms-and-Conditions> and for electronic format documents, subject to Terms and Conditions for Electronic Documents at <http://www.sgs.com.tw/Terms-and-Conditions>. Attention is drawn to the limitation of liability, indemnification and jurisdiction issues defined therein. Any holder of this document is advised that information contained hereon reflects the Company's findings at the time of its intervention only and within the limits of Client's instructions, if any. The Company's sole responsibility is to its Client and this document does not exonerate parties to a transaction from exercising all their rights and obligations under the transaction documents. This document cannot be reproduced except in full, without prior written approval of the Company. Any unauthorized alteration, forgery or falsification of the content or appearance of this document is unlawful and offenders may be prosecuted to the fullest extent of the law.

## 8.2 Test Setup

(A) Radiated Emission Test Set-Up, Frequency Below 30MHz.

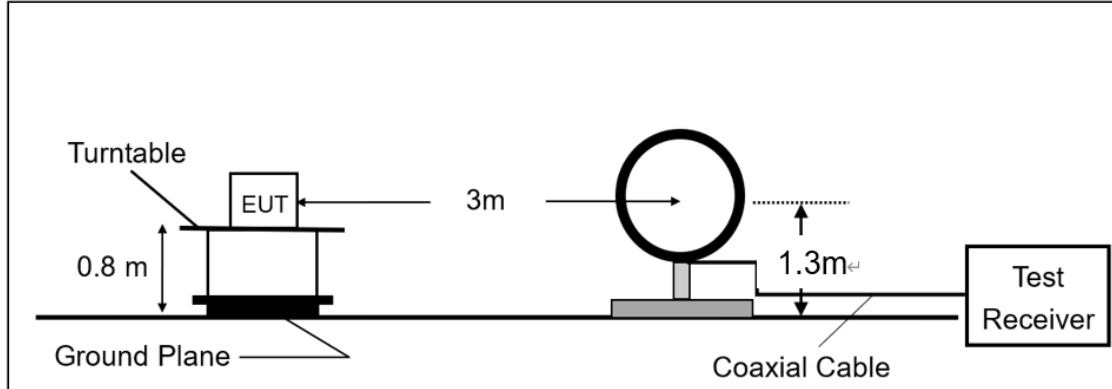

(B) Radiated Emission Test Set-Up, Frequency From 30MHz to 1000MHz.

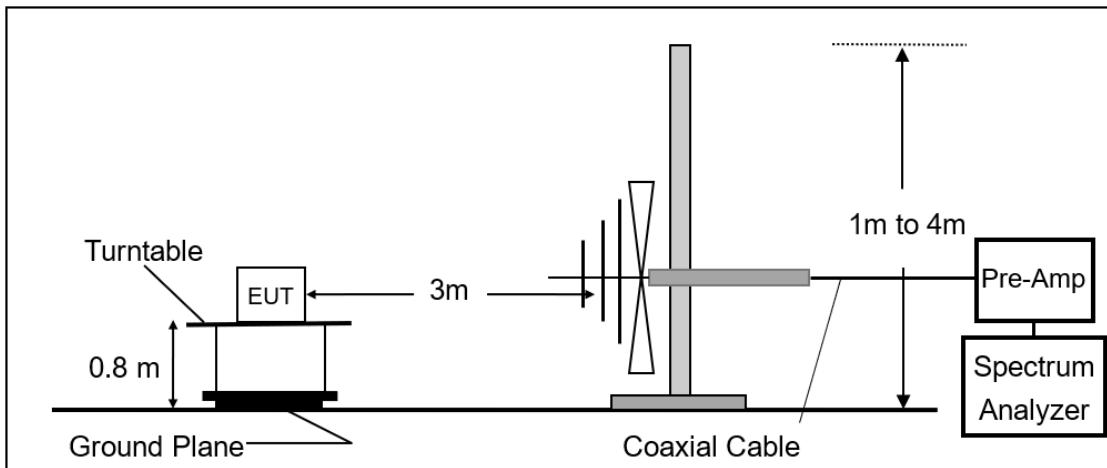

(C) Radiated Emission Test Set-Up, Frequency Above 1GHz.

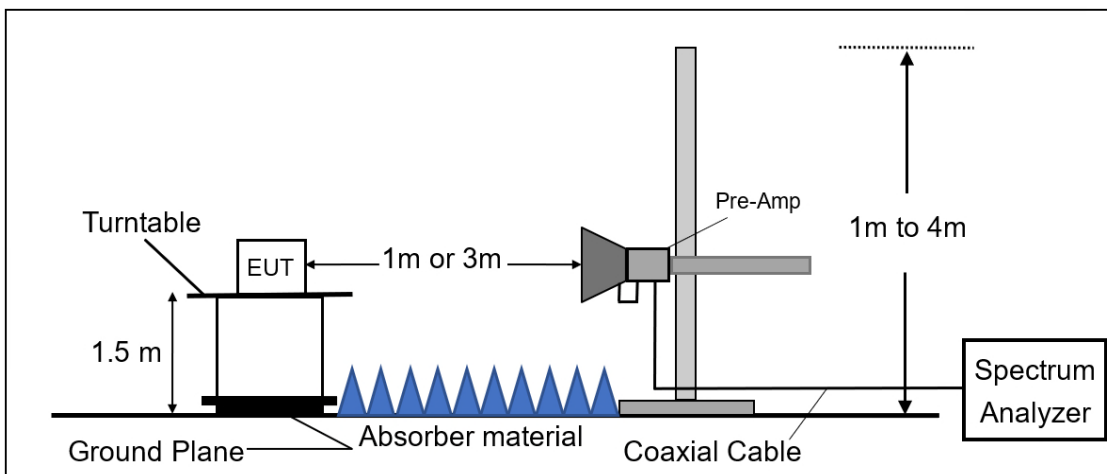

Unless otherwise stated the results shown in this test report refer only to the sample(s) tested and such sample(s) are retained for 90 days only.

除非另有說明，此報告結果僅對測試之樣品負責，同時此樣品僅保留90天。本報告未經本公司書面許可，不可部份複製。

This document is issued by the Company subject to its General Conditions of Service printed overleaf, available on request or accessible at <http://www.sgs.com.tw/Terms-and-Conditions>, and for electronic format documents, subject to Terms and Conditions for Electronic Documents at <http://www.sgs.com.tw/Terms-and-Conditions>. Attention is drawn to the limitation of liability, indemnification and jurisdiction issues defined therein. Any holder of this document is advised that information contained herein reflects the Company's findings at the time of its intervention only and within the limits of Client's instructions, if any. The Company's sole responsibility is to its Client and this document does not exonerate parties to a transaction from exercising all their rights and obligations under the transaction documents. This document cannot be reproduced except in full, without prior written approval of the Company. Any unauthorized alteration, forgery or falsification of the content or appearance of this document is unlawful and offenders may be prosecuted to the fullest extent of the law.

### 8.3 Measurement Procedure

1. The testing follows the Measurement Procedure of FCC KDB 558074 D01 DTS Meas. Guidance .
2. The EUT was placed on a turn table with 0.8m for frequency< 1GHz and 1.5m for frequency> 1GHz above ground plane.
3. The turn table shall rotate 360 degrees to determine the position of maximum emission level.
4. EUT is set 3m away from the receiving antenna which varied from 1m to 4m to find out the highest emissions.
5. Set the spectrum analyzer as RBW=100 kHz and VBW=300 kHz for Peak Detector (PK) at frequency between 30MHz and 1 GHz.
6. Use receiver mode as RBW=120 kHz for Quasi-peak (QP) at frequency between 30MHz and 1 GHz.
7. Set the spectrum analyzer as RBW=1 MHz, VBW=3 MHz for Maximum Emission Measurements at frequency above 1 GHz.
8. Set the spectrum analyzer as RBW=1 MHz, VBW=10 Hz (Duty cycle > 98%) or VBW ≥ 1/T (Duty cycle < 98%) for Average Emission Measurements at frequency above 1 GHz.
9. When measurement procedures for electric field radiated emissions above 1 GHz the EUT measurement is to be made “while keeping the antenna in the ‘cone of radiation’ from that area and pointed at the area both in azimuth and elevation, with polarization oriented for maximum response.” is still within the 3dB illumination BW of the measurement antenna.
10. Maximum procedure was performed on the six highest emissions to ensure EUT compliance.
11. And also, each emission was to be maximized by changing the polarization of receiving antenna both horizontal and vertical.
12. Repeat above procedures until all default test channel measured were complete.

Unless otherwise stated the results shown in this test report refer only to the sample(s) tested and such sample(s) are retained for 90 days only.

除非另有說明，此報告結果僅對測試之樣品負責，同時此樣品僅保留90天。本報告未經本公司書面許可，不可部份複製。

This document is issued by the Company subject to its General Conditions of Service printed overleaf, available on request or accessible at <http://www.sgs.com.tw/Terms-and-Conditions> and for electronic format documents, subject to Terms and Conditions for Electronic Documents at <http://www.sgs.com.tw/Terms-and-Conditions>. Attention is drawn to the limitation of liability, indemnification and jurisdiction issues defined therein. Any holder of this document is advised that information contained hereon reflects the Company's findings at the time of its intervention only and within the limits of Client's instructions, if any. The Company's sole responsibility is to its Client and this document does not exonerate parties to a transaction from exercising all their rights and obligations under the transaction documents. This document cannot be reproduced except in full, without prior written approval of the Company. Any unauthorized alteration, forgery or falsification of the content or appearance of this document is unlawful and offenders may be prosecuted to the fullest extent of the law.

### 8.4 Field Strength Calculation

The field strength is calculated by adding the Antenna Factor and Cable Factor and subtracting the Amplifier Gain and Duty Cycle Correction Factor (if any) from the measured reading. The basic equation with a sample calculation is as follows:

$$FS = RA + AF + CL - AG$$

**Where** *FS = Field Strength*

*CL = Cable Attenuation Factor (Cable Loss)*

*RA = Reading Amplitude*

*AG = Amplifier Gain*

*AF = Antenna Factor*

*The limit of the emission level is expressed in dBuV/m, which converts  $20 \cdot \log(uV/m)$*

*Actual FS(dBμV/m) = SPA. Reading level(dBμV) + Factor(dB)*

*Factor(dB) = Antenna Factor(dBμV/m) + Cable Loss(dB) – Pre\_Amplifier Gain(dB)*

### 8.5 Test Results of Radiated Spurious Emissions from 9 kHz to 30 MHz

The low frequency, which started from 9 kHz to 30MHz, was pre-scanned and the result which was 20dB lower than the limit per 15.31(o) was not reported.

### 8.6 Measurement Result

**Note:**

1. Refer to next page spectrum analyzer data chart and tabular data sheets.
2. Measurements are completed at peak and average level, the mark of average is the highest emission in restricted bands

Unless otherwise stated the results shown in this test report refer only to the sample(s) tested and such sample(s) are retained for 90 days only.  
 除非另有說明，此報告結果僅對測試之樣品負責，同時此樣品僅保留90天。本報告未經本公司書面許可，不可部份複製。

This document is issued by the Company subject to its General Conditions of Service printed overleaf, available on request or accessible at <http://www.sgs.com.tw/Terms-and-Conditions> and for electronic format documents, subject to Terms and Conditions for Electronic Documents at <http://www.sgs.com.tw/Terms-and-Conditions>. Attention is drawn to the limitation of liability, indemnification and jurisdiction issues defined therein. Any holder of this document is advised that information contained hereon reflects the Company's findings at the time of its intervention only and within the limits of Client's instructions, if any. The Company's sole responsibility is to its Client and this document does not exonerate parties to a transaction from exercising all their rights and obligations under the transaction documents. This document cannot be reproduced except in full, without prior written approval of the Company. Any unauthorized alteration, forgery or falsification of the content or appearance of this document is unlawful and offenders may be prosecuted to the fullest extent of the law.

8.6.1 Radiated Band Edge Measurement Result

Report Number	:TERF2404000848E2	Test Site	:SAC G Chamber
Operation Mode	:802.11b	Test Date	:2024-04-09
Test Frequency	:2412 MHz	Temp./Humi.	:24.9°C/59%
Test Mode	:Bandedge	Antenna Pol.	:Vertical
EUT Pol	:E2 Plane	Engineer	:Temo Chen

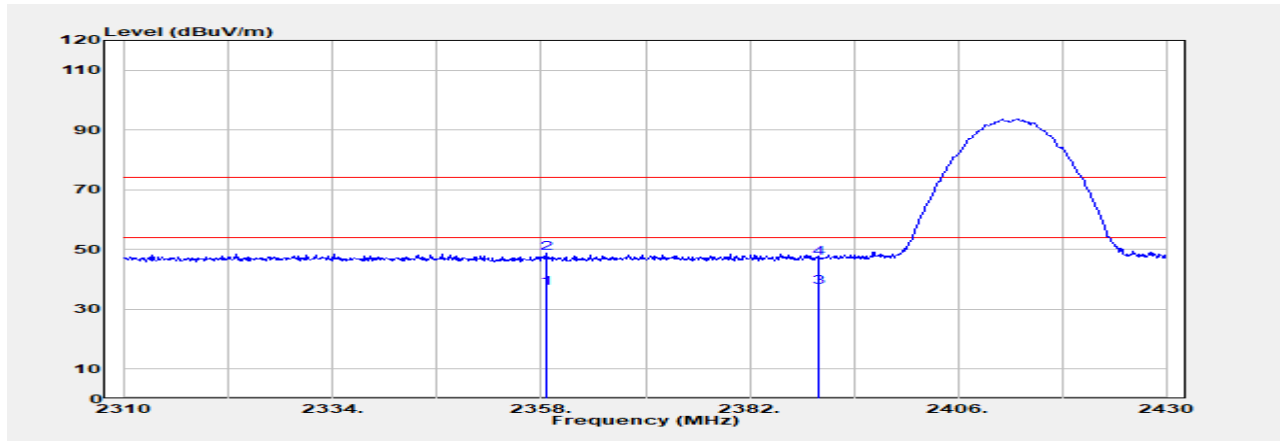

Freq.	Detector	Spectrum	Factor	Actual	Limit	Margin
MHz	Mode	Reading Level	dB	FS	@3m	dB
	PK/QP/AVG	dBμV		dBμV/m	dBμV/m	
2358.480	Average	39.30	-2.24	37.06	54.00	-16.94
2358.480	Peak	50.98	-2.24	48.74	74.00	-25.26
2390.000	Average	39.77	-2.34	37.43	54.00	-16.57
2390.000	Peak	49.40	-2.34	47.06	74.00	-26.94

Unless otherwise stated the results shown in this test report refer only to the sample(s) tested and such sample(s) are retained for 90 days only.

除非另有說明，此報告結果僅對測試之樣品負責，同時此樣品僅保留90天。本報告未經本公司書面許可，不可部份複製。

This document is issued by the Company subject to its General Conditions of Service printed overleaf, available on request or accessible at <http://www.sgs.com.tw/Terms-and-Conditions> and for electronic format documents, subject to Terms and Conditions for Electronic Documents at <http://www.sgs.com.tw/Terms-and-Conditions>. Attention is drawn to the limitation of liability, indemnification and jurisdiction issues defined therein. Any holder of this document is advised that information contained hereon reflects the Company's findings at the time of its intervention only and within the limits of Client's instructions, if any. The Company's sole responsibility is to its Client and this document does not exonerate parties to a transaction from exercising all their rights and obligations under the transaction documents. This document cannot be reproduced except in full, without prior written approval of the Company. Any unauthorized alteration, forgery or falsification of the content or appearance of this document is unlawful and offenders may be prosecuted to the fullest extent of the law.

Report Number :TERF2404000848E2  
 Operation Mode :802.11b  
 Test Frequency :2412 MHz  
 Test Mode :Bandedge  
 EUT Pol :E2 Plane

Test Site :SAC G Chamber  
 Test Date :2024-04-09  
 Temp./Humi. :24.9°C/59%  
 Antenna Pol. :Horizontal  
 Engineer :Temo Chen

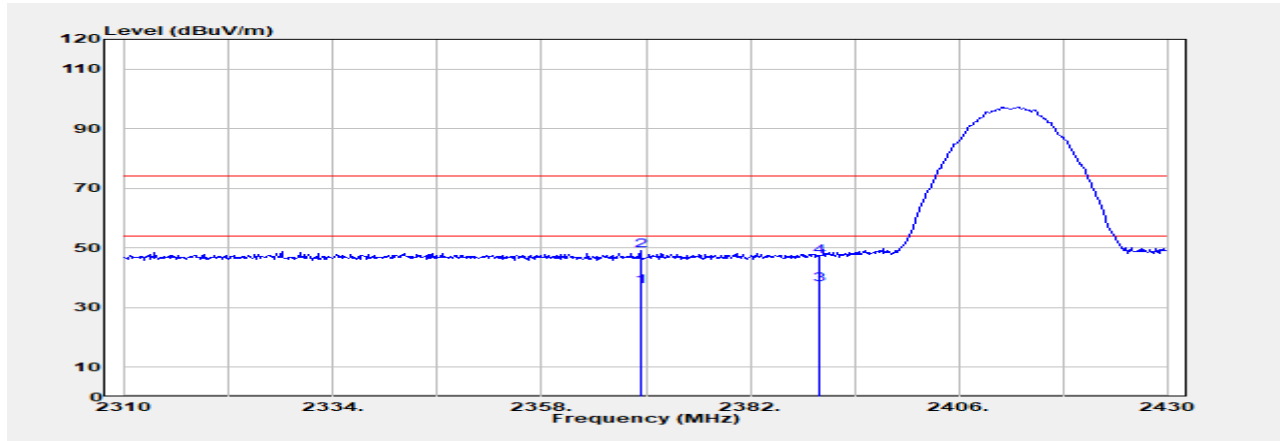

Freq. MHz	Detector Mode PK/QP/AVG	Spectrum Reading Level dB $\mu$ V	Factor dB	Actual FS dB $\mu$ V/m	Limit @3m dB $\mu$ V/m	Margin dB
2369.400	Average	39.42	-2.28	37.15	54.00	-16.85
2369.400	Peak	51.33	-2.28	49.06	74.00	-24.94
2390.000	Average	40.07	-2.34	37.73	54.00	-16.27
2390.000	Peak	49.47	-2.34	47.13	74.00	-26.87

Unless otherwise stated the results shown in this test report refer only to the sample(s) tested and such sample(s) are retained for 90 days only.

除非另有說明，此報告結果僅對測試之樣品負責，同時此樣品僅保留90天。本報告未經本公司書面許可，不可部份複製。

This document is issued by the Company subject to its General Conditions of Service printed overleaf, available on request or accessible at <http://www.sgs.com.tw/Terms-and-Conditions> and for electronic format documents, subject to Terms and Conditions for Electronic Documents at <http://www.sgs.com.tw/Terms-and-Conditions>. Attention is drawn to the limitation of liability, indemnification and jurisdiction issues defined therein. Any holder of this document is advised that information contained hereon reflects the Company's findings at the time of its intervention only and within the limits of Client's instructions, if any. The Company's sole responsibility is to its Client and this document does not exonerate parties to a transaction from exercising all their rights and obligations under the transaction documents. This document cannot be reproduced except in full, without prior written approval of the Company. Any unauthorized alteration, forgery or falsification of the content or appearance of this document is unlawful and offenders may be prosecuted to the fullest extent of the law.



Report Number :TERF2404000848E2  
 Operation Mode :802.11b  
 Test Frequency :2462 MHz  
 Test Mode :Bandedge  
 EUT Pol :E2 Plane

Test Site :SAC G Chamber  
 Test Date :2024-04-09  
 Temp./Humi. :24.9°C/59%  
 Antenna Pol. :Vertical  
 Engineer :Temo Chen

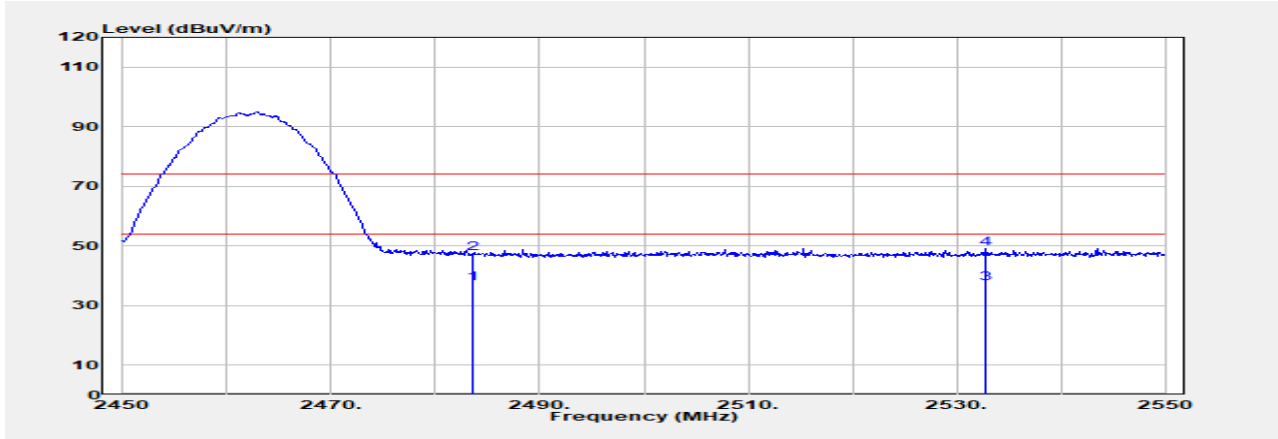

Freq. MHz	Detector Mode PK/QP/AVG	Spectrum Reading Level dB $\mu$ V	Factor dB	Actual FS dB $\mu$ V/m	Limit @3m dB $\mu$ V/m	Margin dB
2483.500	Average	39.92	-2.38	37.54	54.00	-16.46
2483.500	Peak	49.74	-2.38	47.36	74.00	-26.64
2532.800	Average	39.61	-2.24	37.38	54.00	-16.62
2532.800	Peak	51.25	-2.24	49.01	74.00	-24.99

Unless otherwise stated the results shown in this test report refer only to the sample(s) tested and such sample(s) are retained for 90 days only.

除非另有說明，此報告結果僅對測試之樣品負責，同時此樣品僅保留90天。本報告未經本公司書面許可，不可部份複製。

This document is issued by the Company subject to its General Conditions of Service printed overleaf, available on request or accessible at <http://www.sgs.com.tw/Terms-and-Conditions> and for electronic format documents, subject to Terms and Conditions for Electronic Documents at <http://www.sgs.com.tw/Terms-and-Conditions>. Attention is drawn to the limitation of liability, indemnification and jurisdiction issues defined therein. Any holder of this document is advised that information contained hereon reflects the Company's findings at the time of its intervention only and within the limits of Client's instructions, if any. The Company's sole responsibility is to its Client and this document does not exonerate parties to a transaction from exercising all their rights and obligations under the transaction documents. This document cannot be reproduced except in full, without prior written approval of the Company. Any unauthorized alteration, forgery or falsification of the content or appearance of this document is unlawful and offenders may be prosecuted to the fullest extent of the law.

Report Number :TERF2404000848E2  
 Operation Mode :802.11b  
 Test Frequency :2462 MHz  
 Test Mode :Bandedge  
 EUT Pol :E2 Plane

Test Site :SAC G Chamber  
 Test Date :2024-04-09  
 Temp./Humi. :24.9°C/59%  
 Antenna Pol. :Horizontal  
 Engineer :Temo Chen

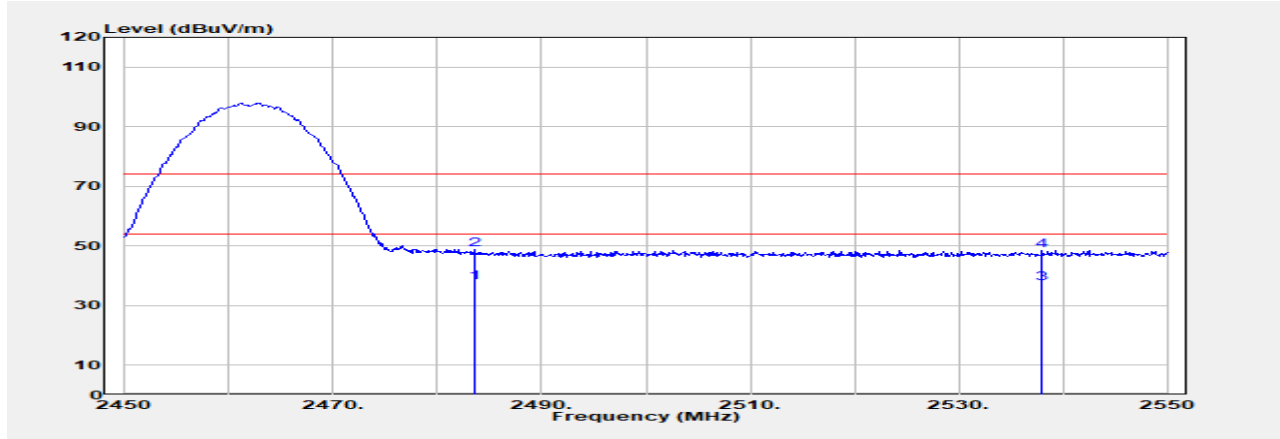

Freq. MHz	Detector Mode PK/QP/AVG	Spectrum Reading Level dBμV	Factor dB	Actual FS dBμV/m	Limit @3m dBμV/m	Margin dB
2483.500	Average	40.13	-2.38	37.76	54.00	-16.24
2483.500	Peak	51.01	-2.38	48.63	74.00	-25.37
2538.000	Average	39.61	-2.22	37.39	54.00	-16.61
2538.000	Peak	50.83	-2.22	48.61	74.00	-25.39

Unless otherwise stated the results shown in this test report refer only to the sample(s) tested and such sample(s) are retained for 90 days only.

除非另有說明，此報告結果僅對測試之樣品負責，同時此樣品僅保留90天。本報告未經本公司書面許可，不可部份複製。

This document is issued by the Company subject to its General Conditions of Service printed overleaf, available on request or accessible at <http://www.sgs.com.tw/Terms-and-Conditions> and for electronic format documents, subject to Terms and Conditions for Electronic Documents at <http://www.sgs.com.tw/Terms-and-Conditions>. Attention is drawn to the limitation of liability, indemnification and jurisdiction issues defined therein. Any holder of this document is advised that information contained hereon reflects the Company's findings at the time of its intervention only and within the limits of Client's instructions, if any. The Company's sole responsibility is to its Client and this document does not exonerate parties to a transaction from exercising all their rights and obligations under the transaction documents. This document cannot be reproduced except in full, without prior written approval of the Company. Any unauthorized alteration, forgery or falsification of the content or appearance of this document is unlawful and offenders may be prosecuted to the fullest extent of the law.

Report Number :TERF2404000848E2  
 Operation Mode :802.11g  
 Test Frequency :2412 MHz  
 Test Mode :Bandedge  
 EUT Pol :E2 Plane

Test Site :SAC G Chamber  
 Test Date :2024-04-09  
 Temp./Humi. :24.9°C/59%  
 Antenna Pol. :Vertical  
 Engineer :Temo Chen

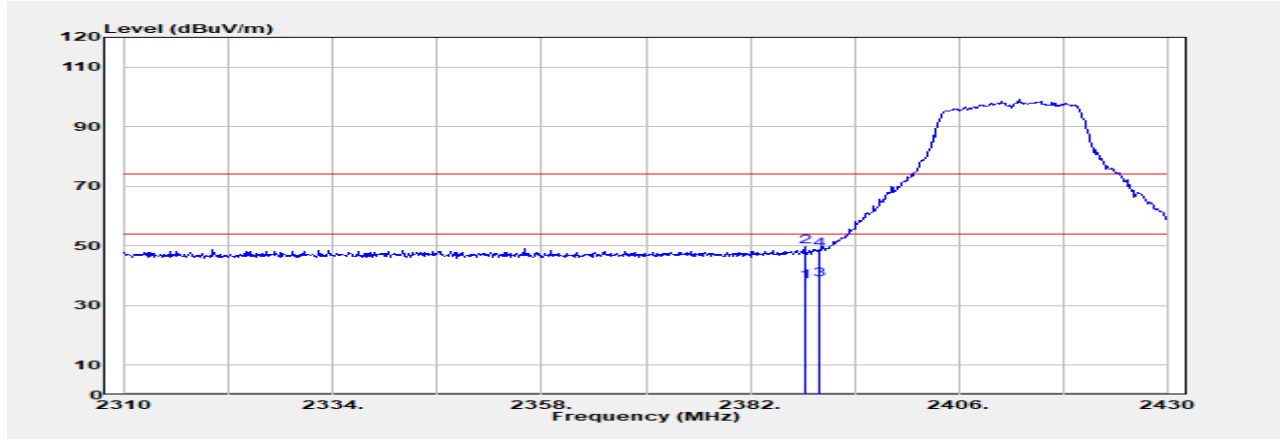

Freq. MHz	Detector Mode PK/QP/AVG	Spectrum Reading Level dB $\mu$ V	Factor dB	Actual FS dB $\mu$ V/m	Limit @3m dB $\mu$ V/m	Margin dB
2388.240	Average	40.44	-2.33	38.11	54.00	-15.89
2388.240	Peak	52.03	-2.33	49.70	74.00	-24.30
2390.000	Average	41.11	-2.34	38.77	54.00	-15.23
2390.000	Peak	50.98	-2.34	48.64	74.00	-25.36

Unless otherwise stated the results shown in this test report refer only to the sample(s) tested and such sample(s) are retained for 90 days only.

除非另有說明，此報告結果僅對測試之樣品負責，同時此樣品僅保留90天。本報告未經本公司書面許可，不可部份複製。

This document is issued by the Company subject to its General Conditions of Service printed overleaf, available on request or accessible at <http://www.sgs.com.tw/Terms-and-Conditions> and for electronic format documents, subject to Terms and Conditions for Electronic Documents at <http://www.sgs.com.tw/Terms-and-Conditions>. Attention is drawn to the limitation of liability, indemnification and jurisdiction issues defined therein. Any holder of this document is advised that information contained hereon reflects the Company's findings at the time of its intervention only and within the limits of Client's instructions, if any. The Company's sole responsibility is to its Client and this document does not exonerate parties to a transaction from exercising all their rights and obligations under the transaction documents. This document cannot be reproduced except in full, without prior written approval of the Company. Any unauthorized alteration, forgery or falsification of the content or appearance of this document is unlawful and offenders may be prosecuted to the fullest extent of the law.

Report Number :TERF2404000848E2  
 Operation Mode :802.11g  
 Test Frequency :2412 MHz  
 Test Mode :Bandedge  
 EUT Pol :E2 Plane

Test Site :SAC G Chamber  
 Test Date :2024-04-09  
 Temp./Humi. :24.9°C/59%  
 Antenna Pol. :Horizontal  
 Engineer :Temo Chen

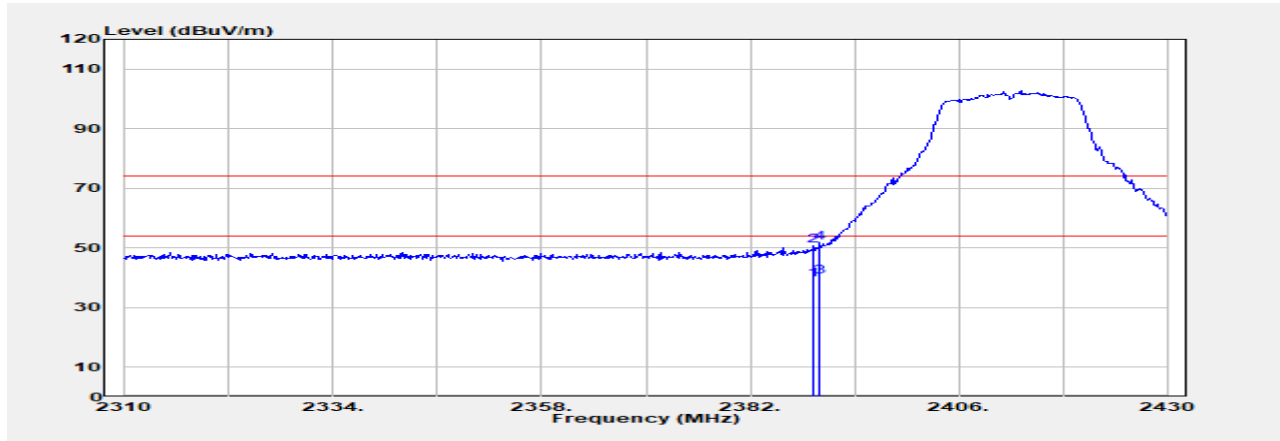

Freq. MHz	Detector Mode PK/QP/AVG	Spectrum Reading Level dBμV	Factor dB	Actual FS dBμV/m	Limit @3m dBμV/m	Margin dB
2389.320	Average	41.81	-2.34	39.47	54.00	-14.53
2389.320	Peak	52.95	-2.34	50.61	74.00	-23.39
2390.000	Average	42.54	-2.34	40.20	54.00	-13.80
2390.000	Peak	54.00	-2.34	51.67	74.00	-22.33

Unless otherwise stated the results shown in this test report refer only to the sample(s) tested and such sample(s) are retained for 90 days only.

除非另有說明，此報告結果僅對測試之樣品負責，同時此樣品僅保留90天。本報告未經本公司書面許可，不可部份複製。

This document is issued by the Company subject to its General Conditions of Service printed overleaf, available on request or accessible at <http://www.sgs.com.tw/Terms-and-Conditions> and for electronic format documents, subject to Terms and Conditions for Electronic Documents at <http://www.sgs.com.tw/Terms-and-Conditions>. Attention is drawn to the limitation of liability, indemnification and jurisdiction issues defined therein. Any holder of this document is advised that information contained hereon reflects the Company's findings at the time of its intervention only and within the limits of Client's instructions, if any. The Company's sole responsibility is to its Client and this document does not exonerate parties to a transaction from exercising all their rights and obligations under the transaction documents. This document cannot be reproduced except in full, without prior written approval of the Company. Any unauthorized alteration, forgery or falsification of the content or appearance of this document is unlawful and offenders may be prosecuted to the fullest extent of the law.

Report Number :TERF2404000848E2  
 Operation Mode :802.11g  
 Test Frequency :2462 MHz  
 Test Mode :Bandedge  
 EUT Pol :E2 Plane

Test Site :SAC G Chamber  
 Test Date :2024-04-09  
 Temp./Humi. :24.9°C/59%  
 Antenna Pol. :Vertical  
 Engineer :Temo Chen

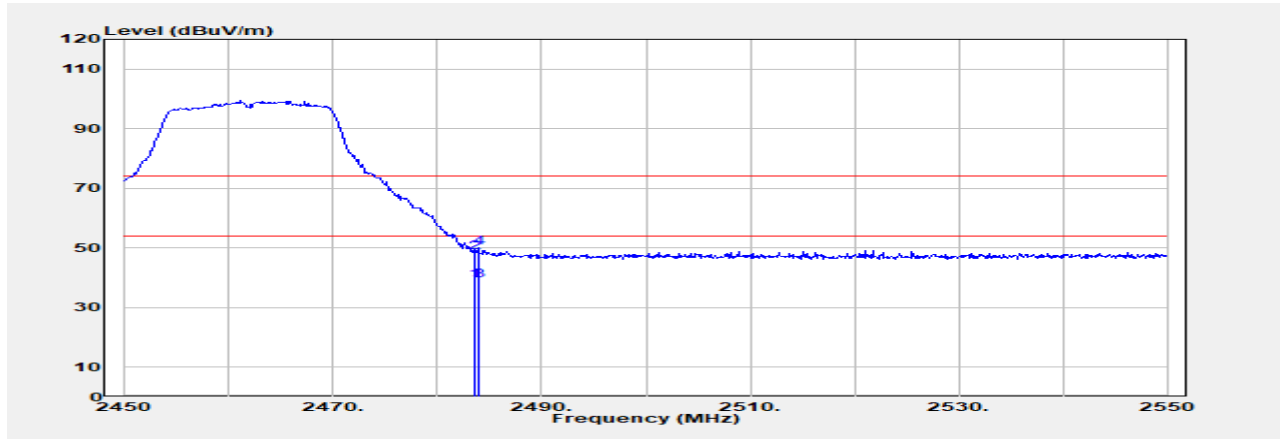

Freq. MHz	Detector Mode PK/QP/AVG	Spectrum Reading Level dBμV	Factor dB	Actual FS dBμV/m	Limit @3m dBμV/m	Margin dB
2483.500	Average	41.38	-2.38	39.00	54.00	-15.00
2483.500	Peak	50.83	-2.38	48.46	74.00	-25.54
2483.900	Average	41.28	-2.38	38.90	54.00	-15.10
2483.900	Peak	52.37	-2.38	50.00	74.00	-24.00

Unless otherwise stated the results shown in this test report refer only to the sample(s) tested and such sample(s) are retained for 90 days only.

除非另有說明，此報告結果僅對測試之樣品負責，同時此樣品僅保留90天。本報告未經本公司書面許可，不可部份複製。

This document is issued by the Company subject to its General Conditions of Service printed overleaf, available on request or accessible at <http://www.sgs.com.tw/Terms-and-Conditions> and for electronic format documents, subject to Terms and Conditions for Electronic Documents at <http://www.sgs.com.tw/Terms-and-Conditions>. Attention is drawn to the limitation of liability, indemnification and jurisdiction issues defined therein. Any holder of this document is advised that information contained hereon reflects the Company's findings at the time of its intervention only and within the limits of Client's instructions, if any. The Company's sole responsibility is to its Client and this document does not exonerate parties to a transaction from exercising all their rights and obligations under the transaction documents. This document cannot be reproduced except in full, without prior written approval of the Company. Any unauthorized alteration, forgery or falsification of the content or appearance of this document is unlawful and offenders may be prosecuted to the fullest extent of the law.

Report Number :TERF2404000848E2  
 Operation Mode :802.11g  
 Test Frequency :2462 MHz  
 Test Mode :Bandedge  
 EUT Pol :E2 Plane

Test Site :SAC G Chamber  
 Test Date :2024-04-09  
 Temp./Humi. :24.9°C/59%  
 Antenna Pol. :Horizontal  
 Engineer :Temo Chen

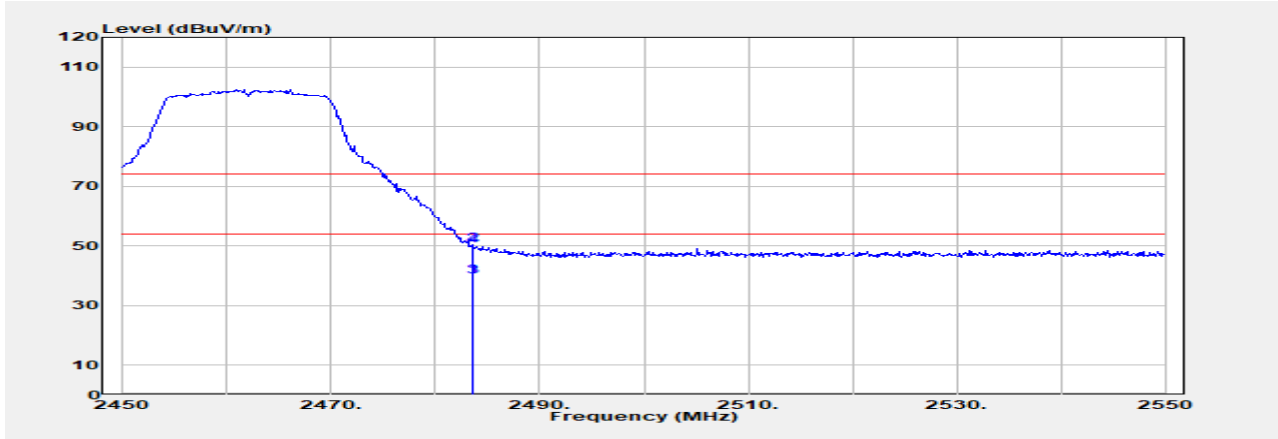

Freq. MHz	Detector Mode PK/QP/AVG	Spectrum Reading Level dBμV	Factor dB	Actual FS dBμV/m	Limit @3m dBμV/m	Margin dB
2483.500	Average	42.21	-2.38	39.84	54.00	-14.16
2483.500	Peak	52.69	-2.38	50.31	74.00	-23.69
2483.600	Average	42.08	-2.38	39.70	54.00	-14.30
2483.600	Peak	52.51	-2.38	50.13	74.00	-23.87

Unless otherwise stated the results shown in this test report refer only to the sample(s) tested and such sample(s) are retained for 90 days only.

除非另有說明，此報告結果僅對測試之樣品負責，同時此樣品僅保留90天。本報告未經本公司書面許可，不可部份複製。

This document is issued by the Company subject to its General Conditions of Service printed overleaf, available on request or accessible at <http://www.sgs.com.tw/Terms-and-Conditions> and for electronic format documents, subject to Terms and Conditions for Electronic Documents at <http://www.sgs.com.tw/Terms-and-Conditions>. Attention is drawn to the limitation of liability, indemnification and jurisdiction issues defined therein. Any holder of this document is advised that information contained hereon reflects the Company's findings at the time of its intervention only and within the limits of Client's instructions, if any. The Company's sole responsibility is to its Client and this document does not exonerate parties to a transaction from exercising all their rights and obligations under the transaction documents. This document cannot be reproduced except in full, without prior written approval of the Company. Any unauthorized alteration, forgery or falsification of the content or appearance of this document is unlawful and offenders may be prosecuted to the fullest extent of the law.

Report Number :TERF2404000848E2  
 Operation Mode :802.11n20  
 Test Frequency :2412 MHz  
 Test Mode :Bandedge  
 EUT Pol :E2 Plane

Test Site :SAC G Chamber  
 Test Date :2024-04-09  
 Temp./Humi. :24.9°C/59%  
 Antenna Pol. :Vertical  
 Engineer :Temo Chen

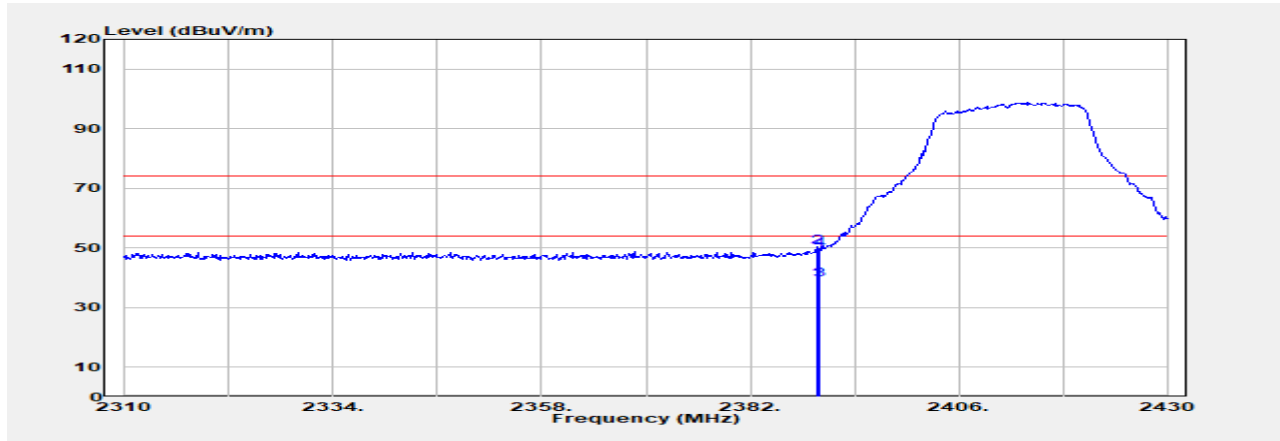

Freq. MHz	Detector Mode PK/QP/AVG	Spectrum Reading Level dBμV	Factor dB	Actual FS dBμV/m	Limit @3m dBμV/m	Margin dB
2389.680	Average	41.55	-2.34	39.21	54.00	-14.79
2389.680	Peak	52.84	-2.34	50.51	74.00	-23.49
2390.000	Average	41.61	-2.34	39.27	54.00	-14.73
2390.000	Peak	51.85	-2.34	49.51	74.00	-24.49

Unless otherwise stated the results shown in this test report refer only to the sample(s) tested and such sample(s) are retained for 90 days only.

除非另有說明，此報告結果僅對測試之樣品負責，同時此樣品僅保留90天。本報告未經本公司書面許可，不可部份複製。

This document is issued by the Company subject to its General Conditions of Service printed overleaf, available on request or accessible at <http://www.sgs.com.tw/Terms-and-Conditions> and for electronic format documents, subject to Terms and Conditions for Electronic Documents at <http://www.sgs.com.tw/Terms-and-Conditions>. Attention is drawn to the limitation of liability, indemnification and jurisdiction issues defined therein. Any holder of this document is advised that information contained hereon reflects the Company's findings at the time of its intervention only and within the limits of Client's instructions, if any. The Company's sole responsibility is to its Client and this document does not exonerate parties to a transaction from exercising all their rights and obligations under the transaction documents. This document cannot be reproduced except in full, without prior written approval of the Company. Any unauthorized alteration, forgery or falsification of the content or appearance of this document is unlawful and offenders may be prosecuted to the fullest extent of the law.

Report Number :TERF2404000848E2  
 Operation Mode :802.11n20  
 Test Frequency :2412 MHz  
 Test Mode :Bandedge  
 EUT Pol :E2 Plane

Test Site :SAC G Chamber  
 Test Date :2024-04-09  
 Temp./Humi. :24.9°C/59%  
 Antenna Pol. :Horizontal  
 Engineer :Temo Chen

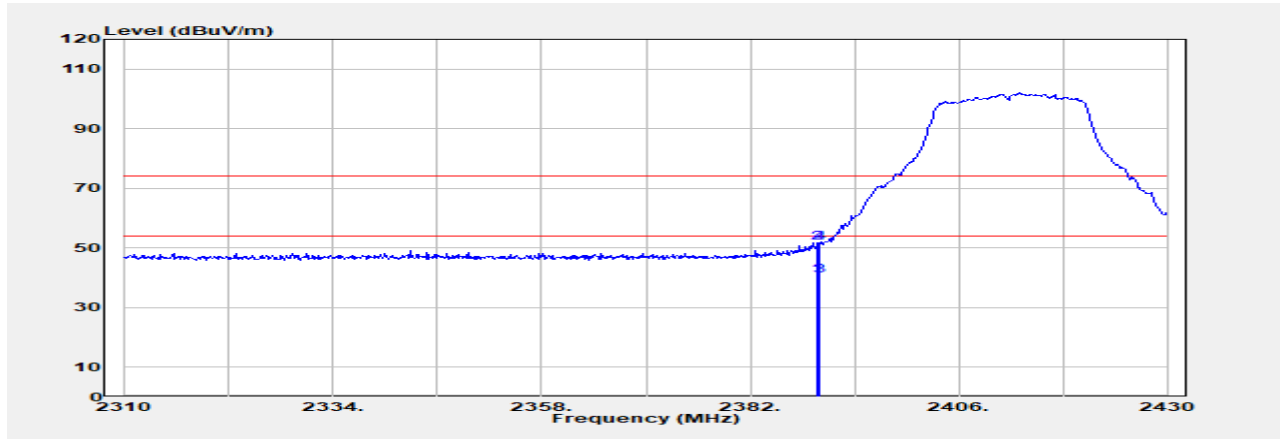

Freq. MHz	Detector Mode	Spectrum Reading Level dB $\mu$ V	Factor dB	Actual FS dB $\mu$ V/m	Limit @3m dB $\mu$ V/m	Margin dB
2389.800	Average	42.91	-2.34	40.57	54.00	-13.43
2389.800	Peak	54.17	-2.34	51.83	74.00	-22.17
2390.000	Average	43.03	-2.34	40.69	54.00	-13.31
2390.000	Peak	54.00	-2.34	51.66	74.00	-22.34

Unless otherwise stated the results shown in this test report refer only to the sample(s) tested and such sample(s) are retained for 90 days only.

除非另有說明，此報告結果僅對測試之樣品負責，同時此樣品僅保留90天。本報告未經本公司書面許可，不可部份複製。

This document is issued by the Company subject to its General Conditions of Service printed overleaf, available on request or accessible at <http://www.sgs.com.tw/Terms-and-Conditions> and for electronic format documents, subject to Terms and Conditions for Electronic Documents at <http://www.sgs.com.tw/Terms-and-Conditions>. Attention is drawn to the limitation of liability, indemnification and jurisdiction issues defined therein. Any holder of this document is advised that information contained hereon reflects the Company's findings at the time of its intervention only and within the limits of Client's instructions, if any. The Company's sole responsibility is to its Client and this document does not exonerate parties to a transaction from exercising all their rights and obligations under the transaction documents. This document cannot be reproduced except in full, without prior written approval of the Company. Any unauthorized alteration, forgery or falsification of the content or appearance of this document is unlawful and offenders may be prosecuted to the fullest extent of the law.



Report Number :TERF2404000848E2  
 Operation Mode :802.11n20  
 Test Frequency :2462 MHz  
 Test Mode :Bandedge  
 EUT Pol :E2 Plane

Test Site :SAC G Chamber  
 Test Date :2024-04-09  
 Temp./Humi. :24.9°C/59%  
 Antenna Pol. :Vertical  
 Engineer :Temo Chen

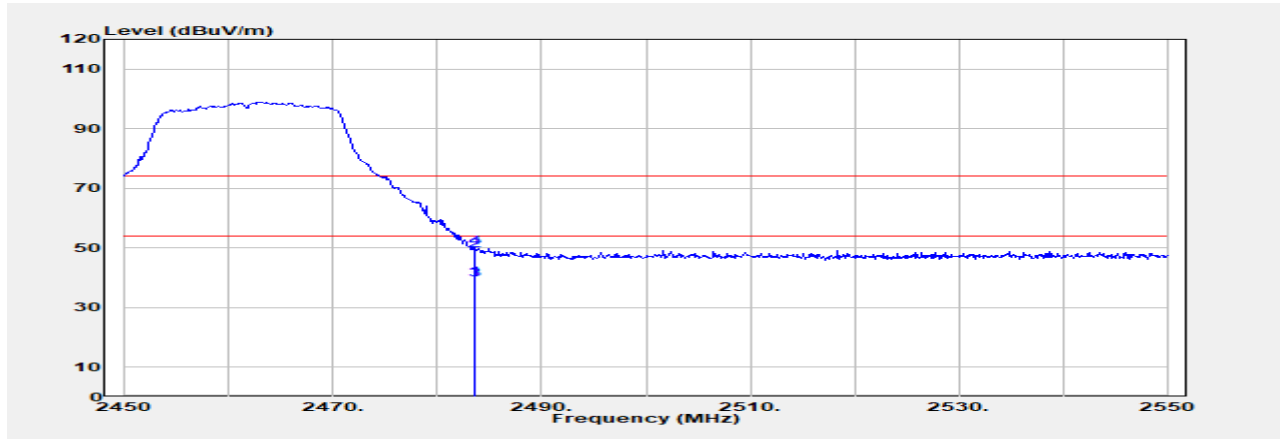

Freq. MHz	Detector Mode PK/QP/AVG	Spectrum Reading Level dBμV	Factor dB	Actual FS dBμV/m	Limit @3m dBμV/m	Margin dB
2483.500	Average	41.90	-2.38	39.53	54.00	-14.47
2483.500	Peak	51.58	-2.38	49.20	74.00	-24.80
2483.600	Average	41.70	-2.38	39.32	54.00	-14.68
2483.600	Peak	52.50	-2.38	50.13	74.00	-23.87

Unless otherwise stated the results shown in this test report refer only to the sample(s) tested and such sample(s) are retained for 90 days only.

除非另有說明，此報告結果僅對測試之樣品負責，同時此樣品僅保留90天。本報告未經本公司書面許可，不可部份複製。

This document is issued by the Company subject to its General Conditions of Service printed overleaf, available on request or accessible at <http://www.sgs.com.tw/Terms-and-Conditions> and for electronic format documents, subject to Terms and Conditions for Electronic Documents at <http://www.sgs.com.tw/Terms-and-Conditions>. Attention is drawn to the limitation of liability, indemnification and jurisdiction issues defined therein. Any holder of this document is advised that information contained hereon reflects the Company's findings at the time of its intervention only and within the limits of Client's instructions, if any. The Company's sole responsibility is to its Client and this document does not exonerate parties to a transaction from exercising all their rights and obligations under the transaction documents. This document cannot be reproduced except in full, without prior written approval of the Company. Any unauthorized alteration, forgery or falsification of the content or appearance of this document is unlawful and offenders may be prosecuted to the fullest extent of the law.

Report Number :TERF2404000848E2  
 Operation Mode :802.11n20  
 Test Frequency :2462 MHz  
 Test Mode :Bandedge  
 EUT Pol :E2 Plane

Test Site :SAC G Chamber  
 Test Date :2024-04-09  
 Temp./Humi. :24.9°C/59%  
 Antenna Pol. :Horizontal  
 Engineer :Temo Chen

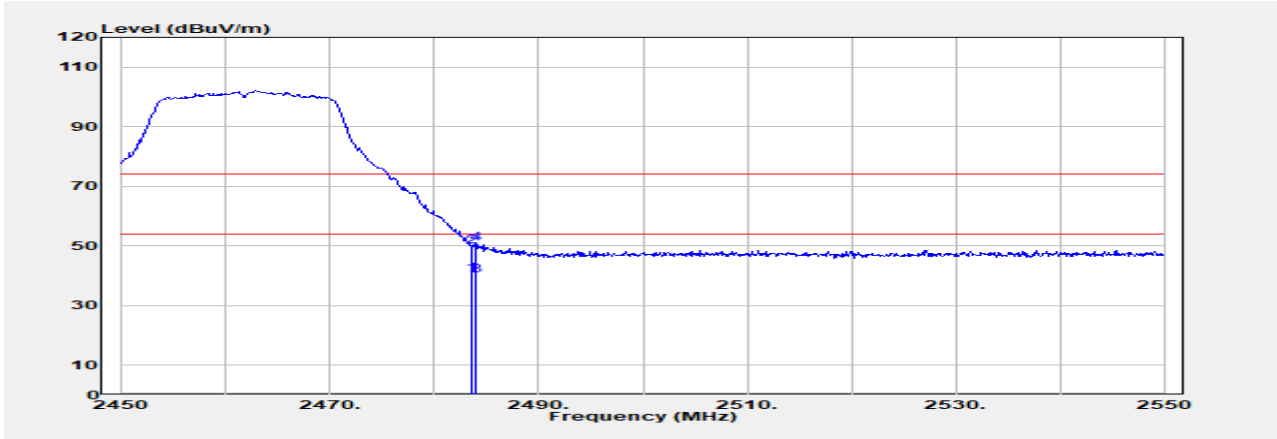

Freq. MHz	Detector Mode PK/QP/AVG	Spectrum Reading Level dBμV	Factor dB	Actual FS dBμV/m	Limit @3m dBμV/m	Margin dB
2483.500	Average	42.61	-2.38	40.24	54.00	-13.76
2483.500	Peak	52.17	-2.38	49.79	74.00	-24.21
2484.000	Average	42.24	-2.38	39.87	54.00	-14.13
2484.000	Peak	52.97	-2.38	50.60	74.00	-23.40

Unless otherwise stated the results shown in this test report refer only to the sample(s) tested and such sample(s) are retained for 90 days only.

除非另有說明，此報告結果僅對測試之樣品負責，同時此樣品僅保留90天。本報告未經本公司書面許可，不可部份複製。

This document is issued by the Company subject to its General Conditions of Service printed overleaf, available on request or accessible at <http://www.sgs.com.tw/Terms-and-Conditions> and for electronic format documents, subject to Terms and Conditions for Electronic Documents at <http://www.sgs.com.tw/Terms-and-Conditions>. Attention is drawn to the limitation of liability, indemnification and jurisdiction issues defined therein. Any holder of this document is advised that information contained hereon reflects the Company's findings at the time of its intervention only and within the limits of Client's instructions, if any. The Company's sole responsibility is to its Client and this document does not exonerate parties to a transaction from exercising all their rights and obligations under the transaction documents. This document cannot be reproduced except in full, without prior written approval of the Company. Any unauthorized alteration, forgery or falsification of the content or appearance of this document is unlawful and offenders may be prosecuted to the fullest extent of the law.

Report Number :TERF2404000848E2  
 Operation Mode :802.11n40  
 Test Frequency :2422 MHz  
 Test Mode :Bandedge  
 EUT Pol :E2 Plane

Test Site :SAC G Chamber  
 Test Date :2024-04-09  
 Temp./Humi. :24.9°C/59%  
 Antenna Pol. :Vertical  
 Engineer :Temo Chen

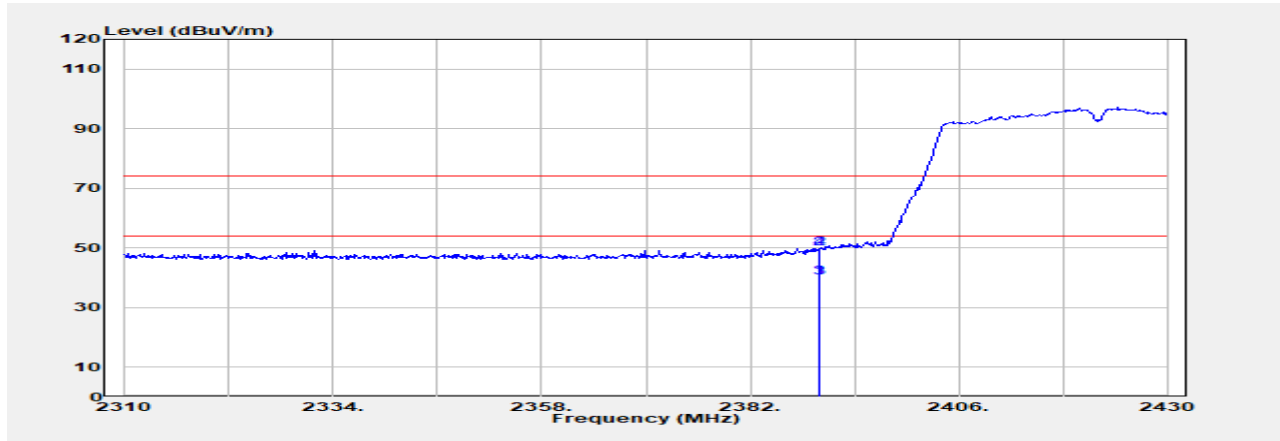

Freq. MHz	Detector Mode PK/QP/AVG	Spectrum Reading Level dB $\mu$ V	Factor dB	Actual FS dB $\mu$ V/m	Limit @3m dB $\mu$ V/m	Margin dB
2389.920	Average	42.20	-2.34	39.86	54.00	-14.14
2389.920	Peak	52.11	-2.34	49.77	74.00	-24.23
2390.000	Average	42.31	-2.34	39.97	54.00	-14.03
2390.000	Peak	52.03	-2.34	49.69	74.00	-24.31

Unless otherwise stated the results shown in this test report refer only to the sample(s) tested and such sample(s) are retained for 90 days only.

除非另有說明，此報告結果僅對測試之樣品負責，同時此樣品僅保留90天。本報告未經本公司書面許可，不可部份複製。

This document is issued by the Company subject to its General Conditions of Service printed overleaf, available on request or accessible at <http://www.sgs.com.tw/Terms-and-Conditions> and for electronic format documents, subject to Terms and Conditions for Electronic Documents at <http://www.sgs.com.tw/Terms-and-Conditions>. Attention is drawn to the limitation of liability, indemnification and jurisdiction issues defined therein. Any holder of this document is advised that information contained hereon reflects the Company's findings at the time of its intervention only and within the limits of Client's instructions, if any. The Company's sole responsibility is to its Client and this document does not exonerate parties to a transaction from exercising all their rights and obligations under the transaction documents. This document cannot be reproduced except in full, without prior written approval of the Company. Any unauthorized alteration, forgery or falsification of the content or appearance of this document is unlawful and offenders may be prosecuted to the fullest extent of the law.

Report Number :TERF2404000848E2  
 Operation Mode :802.11n40  
 Test Frequency :2422 MHz  
 Test Mode :Bandedge  
 EUT Pol :E2 Plane

Test Site :SAC G Chamber  
 Test Date :2024-04-09  
 Temp./Humi. :24.9°C/59%  
 Antenna Pol. :Horizontal  
 Engineer :Temo Chen

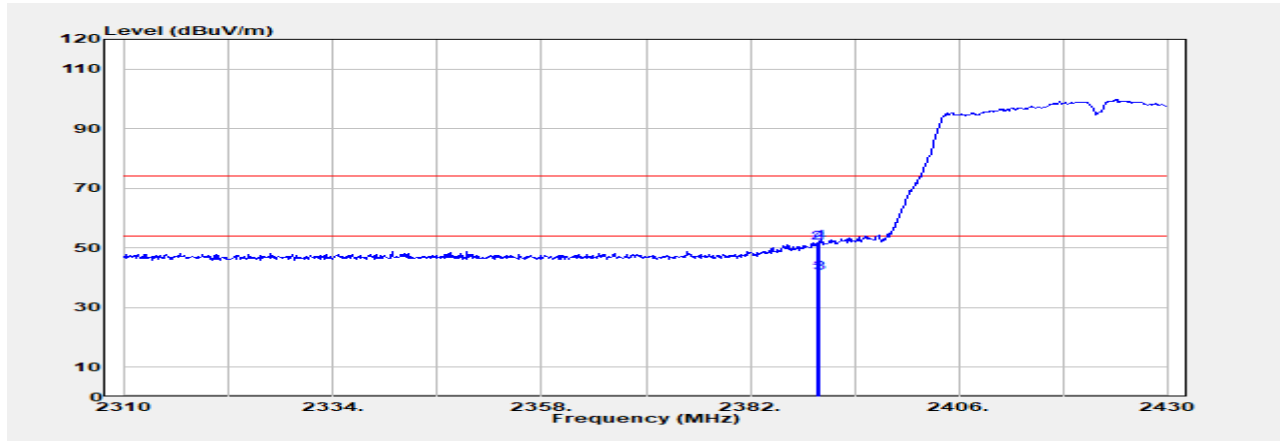

Freq. MHz	Detector Mode PK/QP/AVG	Spectrum Reading Level dBμV	Factor dB	Actual FS dBμV/m	Limit @3m dBμV/m	Margin dB
2389.800	Average	43.74	-2.34	41.40	54.00	-12.60
2389.800	Peak	54.10	-2.34	51.76	74.00	-22.24
2390.000	Average	43.88	-2.34	41.54	54.00	-12.46
2390.000	Peak	54.30	-2.34	51.96	74.00	-22.04

Unless otherwise stated the results shown in this test report refer only to the sample(s) tested and such sample(s) are retained for 90 days only.

除非另有說明，此報告結果僅對測試之樣品負責，同時此樣品僅保留90天。本報告未經本公司書面許可，不可部份複製。

This document is issued by the Company subject to its General Conditions of Service printed overleaf, available on request or accessible at <http://www.sgs.com.tw/Terms-and-Conditions> and for electronic format documents, subject to Terms and Conditions for Electronic Documents at <http://www.sgs.com.tw/Terms-and-Conditions>. Attention is drawn to the limitation of liability, indemnification and jurisdiction issues defined therein. Any holder of this document is advised that information contained hereon reflects the Company's findings at the time of its intervention only and within the limits of Client's instructions, if any. The Company's sole responsibility is to its Client and this document does not exonerate parties to a transaction from exercising all their rights and obligations under the transaction documents. This document cannot be reproduced except in full, without prior written approval of the Company. Any unauthorized alteration, forgery or falsification of the content or appearance of this document is unlawful and offenders may be prosecuted to the fullest extent of the law.

Report Number :TERF2404000848E2  
 Operation Mode :802.11n40  
 Test Frequency :2452 MHz  
 Test Mode :Bandedge  
 EUT Pol :E2 Plane

Test Site :SAC G Chamber  
 Test Date :2024-04-09  
 Temp./Humi. :24.9°C/59%  
 Antenna Pol. :Vertical  
 Engineer :Temo Chen

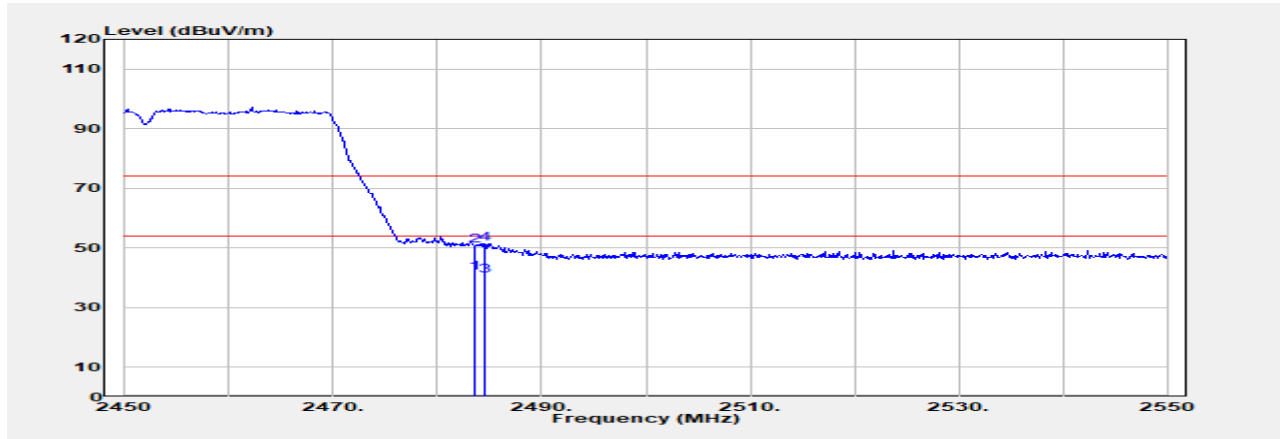

Freq. MHz	Detector Mode PK/QP/AVG	Spectrum Reading Level dBμV	Factor dB	Actual FS dBμV/m	Limit @3m dBμV/m	Margin dB
2483.500	Average	43.98	-2.38	41.60	54.00	-12.40
2483.500	Peak	52.96	-2.38	50.58	74.00	-23.42
2484.500	Average	43.19	-2.37	40.81	54.00	-13.19
2484.500	Peak	53.89	-2.37	51.52	74.00	-22.48

Unless otherwise stated the results shown in this test report refer only to the sample(s) tested and such sample(s) are retained for 90 days only.

除非另有說明，此報告結果僅對測試之樣品負責，同時此樣品僅保留90天。本報告未經本公司書面許可，不可部份複製。

This document is issued by the Company subject to its General Conditions of Service printed overleaf, available on request or accessible at <http://www.sgs.com.tw/Terms-and-Conditions> and for electronic format documents, subject to Terms and Conditions for Electronic Documents at <http://www.sgs.com.tw/Terms-and-Conditions>. Attention is drawn to the limitation of liability, indemnification and jurisdiction issues defined therein. Any holder of this document is advised that information contained hereon reflects the Company's findings at the time of its intervention only and within the limits of Client's instructions, if any. The Company's sole responsibility is to its Client and this document does not exonerate parties to a transaction from exercising all their rights and obligations under the transaction documents. This document cannot be reproduced except in full, without prior written approval of the Company. Any unauthorized alteration, forgery or falsification of the content or appearance of this document is unlawful and offenders may be prosecuted to the fullest extent of the law.

Report Number :TERF2404000848E2  
 Operation Mode :802.11n40  
 Test Frequency :2452 MHz  
 Test Mode :Bandedge  
 EUT Pol :E2 Plane

Test Site :SAC G Chamber  
 Test Date :2024-04-09  
 Temp./Humi. :24.9°C/59%  
 Antenna Pol. :Horizontal  
 Engineer :Temo Chen

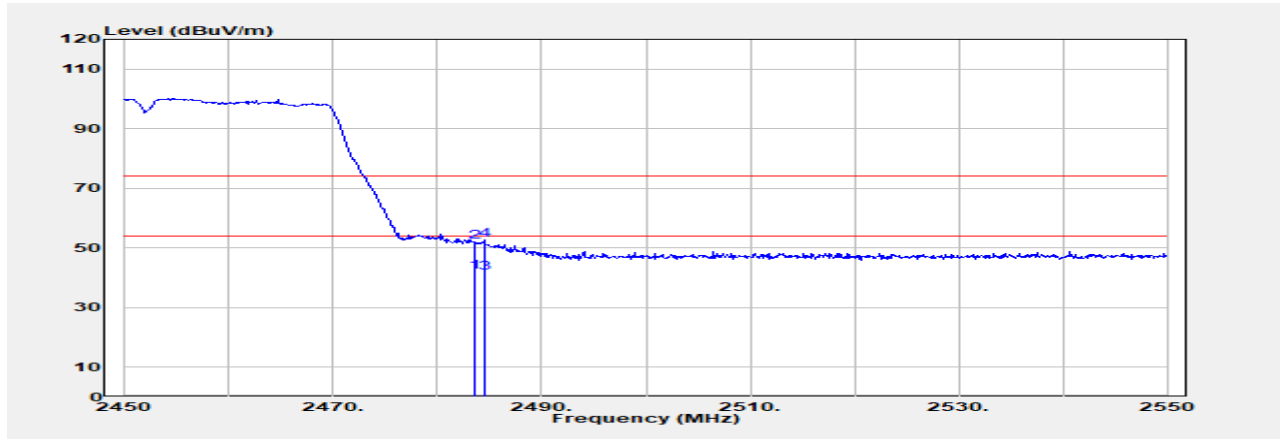

Freq. MHz	Detector Mode PK/QP/AVG	Spectrum Reading Level dBμV	Factor dB	Actual FS dBμV/m	Limit @3m dBμV/m	Margin dB
2483.500	Average	44.34	-2.38	41.96	54.00	-12.04
2483.500	Peak	54.43	-2.38	52.05	74.00	-21.95
2484.500	Average	44.06	-2.37	41.69	54.00	-12.31
2484.500	Peak	55.07	-2.37	52.69	74.00	-21.31

Unless otherwise stated the results shown in this test report refer only to the sample(s) tested and such sample(s) are retained for 90 days only.

除非另有說明，此報告結果僅對測試之樣品負責，同時此樣品僅保留90天。本報告未經本公司書面許可，不可部份複製。  
 This document is issued by the Company subject to its General Conditions of Service printed overleaf, available on request or accessible at <http://www.sgs.com.tw/Terms-and-Conditions> and for electronic format documents, subject to Terms and Conditions for Electronic Documents at <http://www.sgs.com.tw/Terms-and-Conditions>. Attention is drawn to the limitation of liability, indemnification and jurisdiction issues defined therein. Any holder of this document is advised that information contained hereon reflects the Company's findings at the time of its intervention only and within the limits of Client's instructions, if any. The Company's sole responsibility is to its Client and this document does not exonerate parties to a transaction from exercising all their rights and obligations under the transaction documents. This document cannot be reproduced except in full, without prior written approval of the Company. Any unauthorized alteration, forgery or falsification of the content or appearance of this document is unlawful and offenders may be prosecuted to the fullest extent of the law.

**8.6.2 Spurious Emission:**

Report Number :TERF2404000848E2	Test Site :SAC G Chamber
Operation Mode :802.11g	Test Date :2024-04-11
Test Frequency :2437 MHz	Temp./Humi. :23.0°C/50%
Test Mode :Tx	Antenna Pol. :Vertical
EUT Pol :E2 Plane	Engineer :Temo Chen

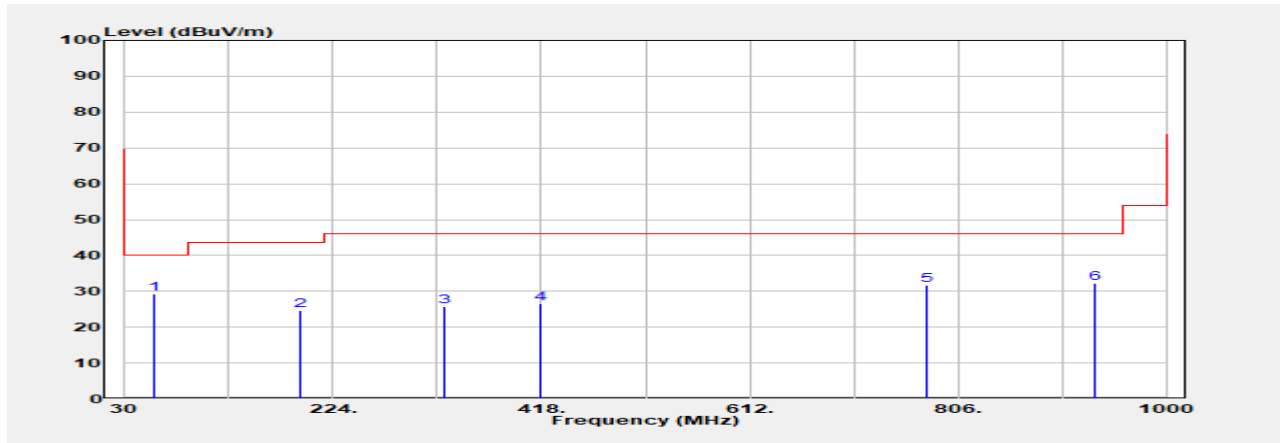

Freq. MHz	Detector Mode	Spectrum Reading Level dBμV	Factor dB	Actual FS dBμV/m	Limit @3m dBμV/m	Margin dB
58.130	Peak	42.29	-12.95	29.34	40.00	-10.66
193.930	Peak	40.13	-15.55	24.58	43.50	-18.92
327.790	Peak	36.78	-11.16	25.62	46.00	-20.38
418.000	Peak	35.95	-9.42	26.53	46.00	-19.47
776.900	Peak	33.24	-1.51	31.74	46.00	-14.26
933.070	Peak	32.36	-0.24	32.12	46.00	-13.88

Unless otherwise stated the results shown in this test report refer only to the sample(s) tested and such sample(s) are retained for 90 days only.

除非另有說明，此報告結果僅對測試之樣品負責，同時此樣品僅保留90天。本報告未經本公司書面許可，不可部份複製。

This document is issued by the Company subject to its General Conditions of Service printed overleaf, available on request or accessible at <http://www.sgs.com.tw/Terms-and-Conditions> and for electronic format documents, subject to Terms and Conditions for Electronic Documents at <http://www.sgs.com.tw/Terms-and-Conditions>. Attention is drawn to the limitation of liability, indemnification and jurisdiction issues defined therein. Any holder of this document is advised that information contained hereon reflects the Company's findings at the time of its intervention only and within the limits of Client's instructions, if any. The Company's sole responsibility is to its Client and this document does not exonerate parties to a transaction from exercising all their rights and obligations under the transaction documents. This document cannot be reproduced except in full, without prior written approval of the Company. Any unauthorized alteration, forgery or falsification of the content or appearance of this document is unlawful and offenders may be prosecuted to the fullest extent of the law.

Report Number :TERF2404000848E2  
 Operation Mode :802.11g  
 Test Frequency :2437 MHz  
 Test Mode :Tx  
 EUT Pol :E2 Plane

Test Site :SAC G Chamber  
 Test Date :2024-04-11  
 Temp./Humi. :23.0°C/50%  
 Antenna Pol. :Horizontal  
 Engineer :Temo Chen

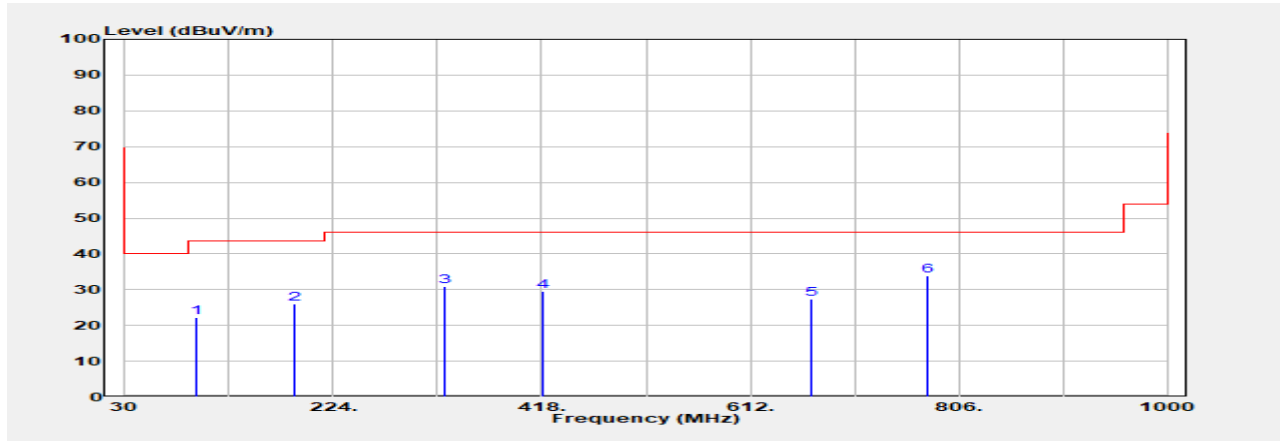

Freq. MHz	Detector Mode PK/QP/AVG	Spectrum Reading Level dBμV	Factor dB	Actual FS dBμV/m	Limit @3m dBμV/m	Margin dB
96.930	Peak	40.08	-17.85	22.23	43.50	-21.27
188.110	Peak	41.16	-15.06	26.10	43.50	-17.40
326.820	Peak	41.97	-11.17	30.80	46.00	-15.20
418.970	Peak	39.02	-9.42	29.59	46.00	-16.41
668.260	Peak	30.76	-3.47	27.30	46.00	-18.70
776.900	Peak	35.28	-1.51	33.77	46.00	-12.23

Unless otherwise stated the results shown in this test report refer only to the sample(s) tested and such sample(s) are retained for 90 days only.

除非另有說明，此報告結果僅對測試之樣品負責，同時此樣品僅保留90天。本報告未經本公司書面許可，不可部份複製。

This document is issued by the Company subject to its General Conditions of Service printed overleaf, available on request or accessible at <http://www.sgs.com.tw/Terms-and-Conditions> and for electronic format documents, subject to Terms and Conditions for Electronic Documents at <http://www.sgs.com.tw/Terms-and-Conditions>. Attention is drawn to the limitation of liability, indemnification and jurisdiction issues defined therein. Any holder of this document is advised that information contained hereon reflects the Company's findings at the time of its intervention only and within the limits of Client's instructions, if any. The Company's sole responsibility is to its Client and this document does not exonerate parties to a transaction from exercising all their rights and obligations under the transaction documents. This document cannot be reproduced except in full, without prior written approval of the Company. Any unauthorized alteration, forgery or falsification of the content or appearance of this document is unlawful and offenders may be prosecuted to the fullest extent of the law.



Report Number :TERF2404000848E2  
 Operation Mode :802.11b  
 Test Frequency :2412 MHz  
 Test Mode :Tx  
 EUT Pol :E2 Plane

Test Site :SAC G Chamber  
 Test Date :2024-04-09  
 Temp./Humi. :24.9°C/59%  
 Antenna Pol. :Vertical  
 Engineer :Temo Chen

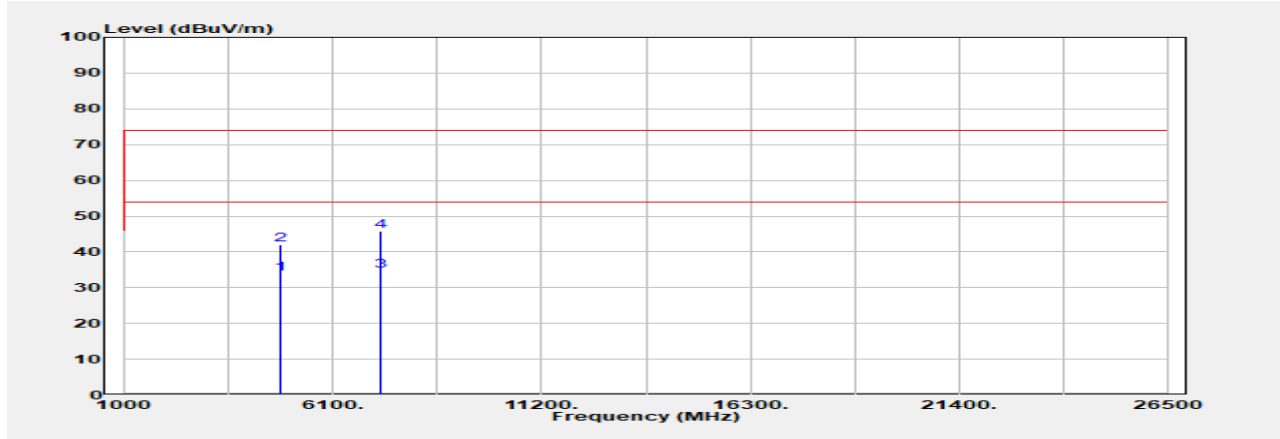

Freq. MHz	Detector Mode PK/QP/AVG	Spectrum Reading Level dB $\mu$ V	Factor dB	Actual FS dB $\mu$ V/m	Limit @3m dB $\mu$ V/m	Margin dB
4824.000	Average	28.89	5.10	34.00	54.00	-20.00
4824.000	Peak	37.03	5.10	42.13	74.00	-31.87
7236.000	Average	25.06	9.60	34.66	54.00	-19.34
7236.000	Peak	36.14	9.60	45.74	74.00	-28.26

Unless otherwise stated the results shown in this test report refer only to the sample(s) tested and such sample(s) are retained for 90 days only.

除非另有說明，此報告結果僅對測試之樣品負責，同時此樣品僅保留90天。本報告未經本公司書面許可，不可部份複製。

This document is issued by the Company subject to its General Conditions of Service printed overleaf, available on request or accessible at <http://www.sgs.com.tw/Terms-and-Conditions> and for electronic format documents, subject to Terms and Conditions for Electronic Documents at <http://www.sgs.com.tw/Terms-and-Conditions>. Attention is drawn to the limitation of liability, indemnification and jurisdiction issues defined therein. Any holder of this document is advised that information contained hereon reflects the Company's findings at the time of its intervention only and within the limits of Client's instructions, if any. The Company's sole responsibility is to its Client and this document does not exonerate parties to a transaction from exercising all their rights and obligations under the transaction documents. This document cannot be reproduced except in full, without prior written approval of the Company. Any unauthorized alteration, forgery or falsification of the content or appearance of this document is unlawful and offenders may be prosecuted to the fullest extent of the law.

Report Number :TERF2404000848E2  
 Operation Mode :802.11b  
 Test Frequency :2412 MHz  
 Test Mode :Tx  
 EUT Pol :E2 Plane

Test Site :SAC G Chamber  
 Test Date :2024-04-09  
 Temp./Humi. :24.9°C/59%  
 Antenna Pol. :Horizontal  
 Engineer :Temo Chen

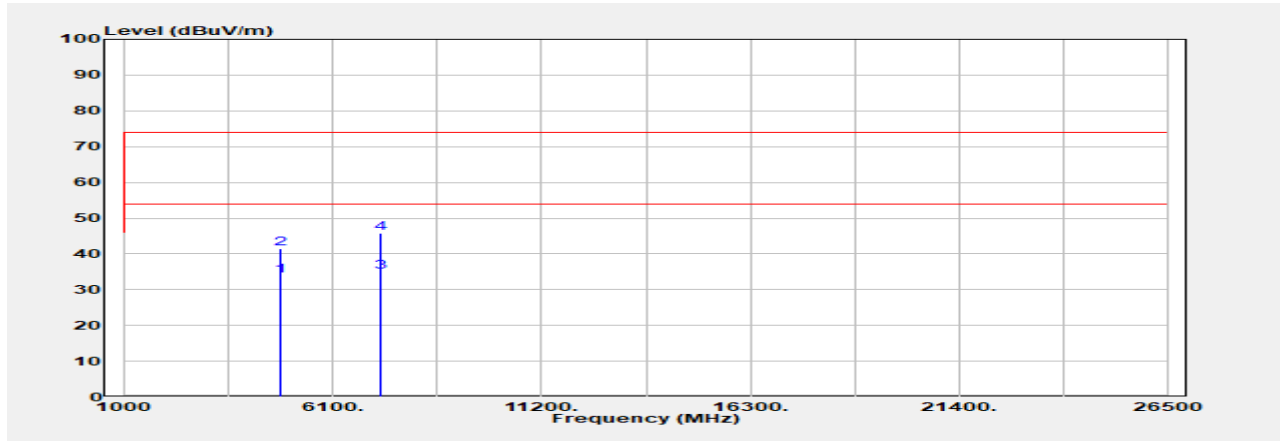

Freq. MHz	Detector Mode PK/QP/AVG	Spectrum Reading Level dBμV	Factor dB	Actual FS dBμV/m	Limit @3m dBμV/m	Margin dB
4824.000	Average	28.70	5.10	33.80	54.00	-20.20
4824.000	Peak	36.32	5.10	41.43	74.00	-32.57
7236.000	Average	25.40	9.60	35.00	54.00	-19.00
7236.000	Peak	36.08	9.60	45.69	74.00	-28.31

Unless otherwise stated the results shown in this test report refer only to the sample(s) tested and such sample(s) are retained for 90 days only.

除非另有說明，此報告結果僅對測試之樣品負責，同時此樣品僅保留90天。本報告未經本公司書面許可，不可部份複製。

This document is issued by the Company subject to its General Conditions of Service printed overleaf, available on request or accessible at <http://www.sgs.com.tw/Terms-and-Conditions> and for electronic format documents, subject to Terms and Conditions for Electronic Documents at <http://www.sgs.com.tw/Terms-and-Conditions>. Attention is drawn to the limitation of liability, indemnification and jurisdiction issues defined therein. Any holder of this document is advised that information contained hereon reflects the Company's findings at the time of its intervention only and within the limits of Client's instructions, if any. The Company's sole responsibility is to its Client and this document does not exonerate parties to a transaction from exercising all their rights and obligations under the transaction documents. This document cannot be reproduced except in full, without prior written approval of the Company. Any unauthorized alteration, forgery or falsification of the content or appearance of this document is unlawful and offenders may be prosecuted to the fullest extent of the law.

Report Number :TERF2404000848E2  
 Operation Mode :802.11b  
 Test Frequency :2437 MHz  
 Test Mode :Tx  
 EUT Pol :E2 Plane

Test Site :SAC G Chamber  
 Test Date :2024-04-09  
 Temp./Humi. :24.9°C/59%  
 Antenna Pol. :Vertical  
 Engineer :Temo Chen

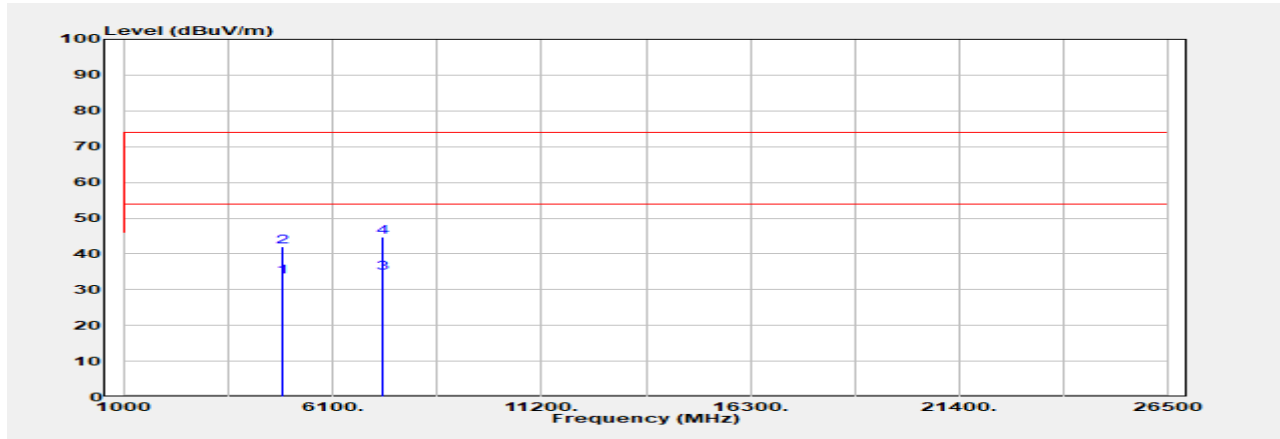

Freq. MHz	Detector Mode PK/QP/AVG	Spectrum Reading Level dBμV	Factor dB	Actual FS dBμV/m	Limit @3m dBμV/m	Margin dB
4874.000	Average	28.35	5.35	33.70	54.00	-20.30
4874.000	Peak	36.71	5.35	42.06	74.00	-31.94
7311.000	Average	25.43	9.16	34.59	54.00	-19.41
7311.000	Peak	35.43	9.16	44.59	74.00	-29.41

Unless otherwise stated the results shown in this test report refer only to the sample(s) tested and such sample(s) are retained for 90 days only.

除非另有說明，此報告結果僅對測試之樣品負責，同時此樣品僅保留90天。本報告未經本公司書面許可，不可部份複製。

This document is issued by the Company subject to its General Conditions of Service printed overleaf, available on request or accessible at <http://www.sgs.com.tw/Terms-and-Conditions> and for electronic format documents, subject to Terms and Conditions for Electronic Documents at <http://www.sgs.com.tw/Terms-and-Conditions>. Attention is drawn to the limitation of liability, indemnification and jurisdiction issues defined therein. Any holder of this document is advised that information contained hereon reflects the Company's findings at the time of its intervention only and within the limits of Client's instructions, if any. The Company's sole responsibility is to its Client and this document does not exonerate parties to a transaction from exercising all their rights and obligations under the transaction documents. This document cannot be reproduced except in full, without prior written approval of the Company. Any unauthorized alteration, forgery or falsification of the content or appearance of this document is unlawful and offenders may be prosecuted to the fullest extent of the law.

Report Number :TERF2404000848E2  
 Operation Mode :802.11b  
 Test Frequency :2437 MHz  
 Test Mode :Tx  
 EUT Pol :E2 Plane

Test Site :SAC G Chamber  
 Test Date :2024-04-09  
 Temp./Humi. :24.9°C/59%  
 Antenna Pol. :Horizontal  
 Engineer :Temo Chen

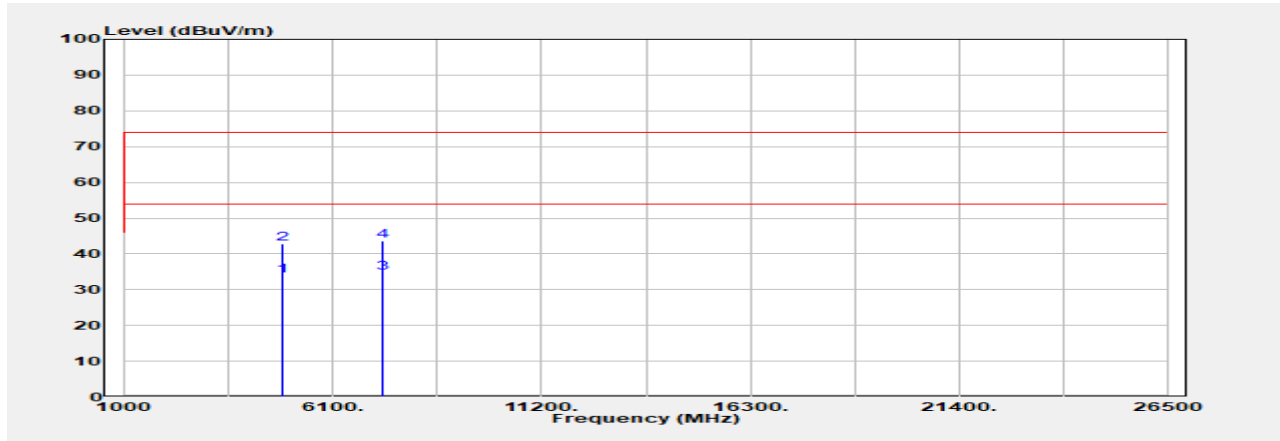

Freq. MHz	Detector Mode PK/QP/AVG	Spectrum Reading Level dBμV	Factor dB	Actual FS dBμV/m	Limit @3m dBμV/m	Margin dB
4874.000	Average	28.42	5.35	33.77	54.00	-20.23
4874.000	Peak	37.39	5.35	42.74	74.00	-31.26
7311.000	Average	25.66	9.16	34.82	54.00	-19.18
7311.000	Peak	34.57	9.16	43.73	74.00	-30.27

Unless otherwise stated the results shown in this test report refer only to the sample(s) tested and such sample(s) are retained for 90 days only.

除非另有說明，此報告結果僅對測試之樣品負責，同時此樣品僅保留90天。本報告未經本公司書面許可，不可部份複製。  
 This document is issued by the Company subject to its General Conditions of Service printed overleaf, available on request or accessible at <http://www.sgs.com.tw/Terms-and-Conditions> and for electronic format documents, subject to Terms and Conditions for Electronic Documents at <http://www.sgs.com.tw/Terms-and-Conditions>. Attention is drawn to the limitation of liability, indemnification and jurisdiction issues defined therein. Any holder of this document is advised that information contained hereon reflects the Company's findings at the time of its intervention only and within the limits of Client's instructions, if any. The Company's sole responsibility is to its Client and this document does not exonerate parties to a transaction from exercising all their rights and obligations under the transaction documents. This document cannot be reproduced except in full, without prior written approval of the Company. Any unauthorized alteration, forgery or falsification of the content or appearance of this document is unlawful and offenders may be prosecuted to the fullest extent of the law.

Report Number :TERF2404000848E2  
 Operation Mode :802.11b  
 Test Frequency :2462 MHz  
 Test Mode :Tx  
 EUT Pol :E2 Plane

Test Site :SAC G Chamber  
 Test Date :2024-04-09  
 Temp./Humi. :24.9°C/59%  
 Antenna Pol. :Vertical  
 Engineer :Temo Chen

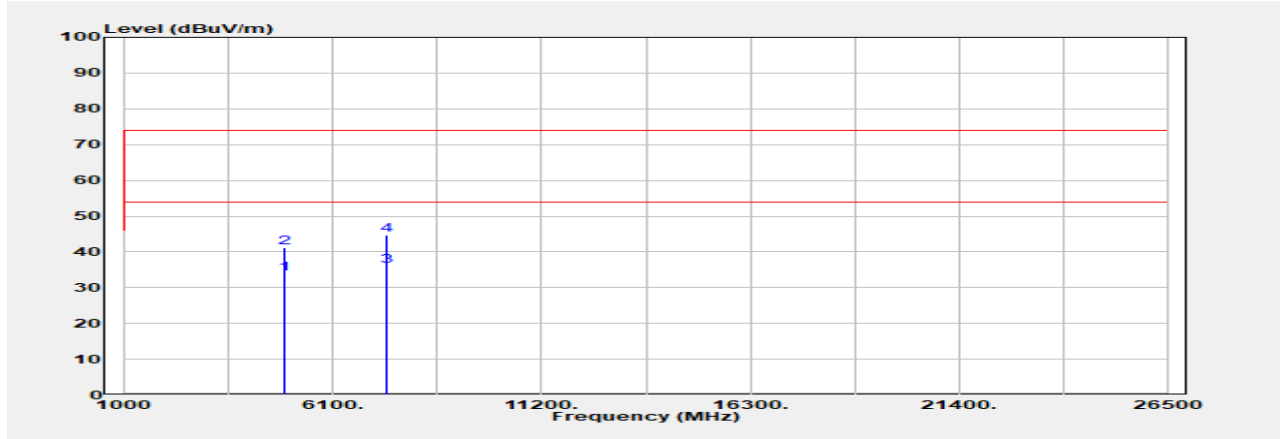

Freq. MHz	Detector Mode PK/QP/AVG	Spectrum Reading Level dBμV	Factor dB	Actual FS dBμV/m	Limit @3m dBμV/m	Margin dB
4924.000	Average	28.40	5.56	33.96	54.00	-20.04
4924.000	Peak	35.52	5.56	41.07	74.00	-32.93
7386.000	Average	25.70	10.29	35.99	54.00	-18.01
7386.000	Peak	34.33	10.29	44.62	74.00	-29.38

Unless otherwise stated the results shown in this test report refer only to the sample(s) tested and such sample(s) are retained for 90 days only.

除非另有說明，此報告結果僅對測試之樣品負責，同時此樣品僅保留90天。本報告未經本公司書面許可，不可部份複製。

This document is issued by the Company subject to its General Conditions of Service printed overleaf, available on request or accessible at <http://www.sgs.com.tw/Terms-and-Conditions> and for electronic format documents, subject to Terms and Conditions for Electronic Documents at <http://www.sgs.com.tw/Terms-and-Conditions>. Attention is drawn to the limitation of liability, indemnification and jurisdiction issues defined therein. Any holder of this document is advised that information contained hereon reflects the Company's findings at the time of its intervention only and within the limits of Client's instructions, if any. The Company's sole responsibility is to its Client and this document does not exonerate parties to a transaction from exercising all their rights and obligations under the transaction documents. This document cannot be reproduced except in full, without prior written approval of the Company. Any unauthorized alteration, forgery or falsification of the content or appearance of this document is unlawful and offenders may be prosecuted to the fullest extent of the law.

Report Number :TERF2404000848E2  
 Operation Mode :802.11b  
 Test Frequency :2462 MHz  
 Test Mode :Tx  
 EUT Pol :E2 Plane

Test Site :SAC G Chamber  
 Test Date :2024-04-09  
 Temp./Humi. :24.9°C/59%  
 Antenna Pol. :Horizontal  
 Engineer :Temo Chen

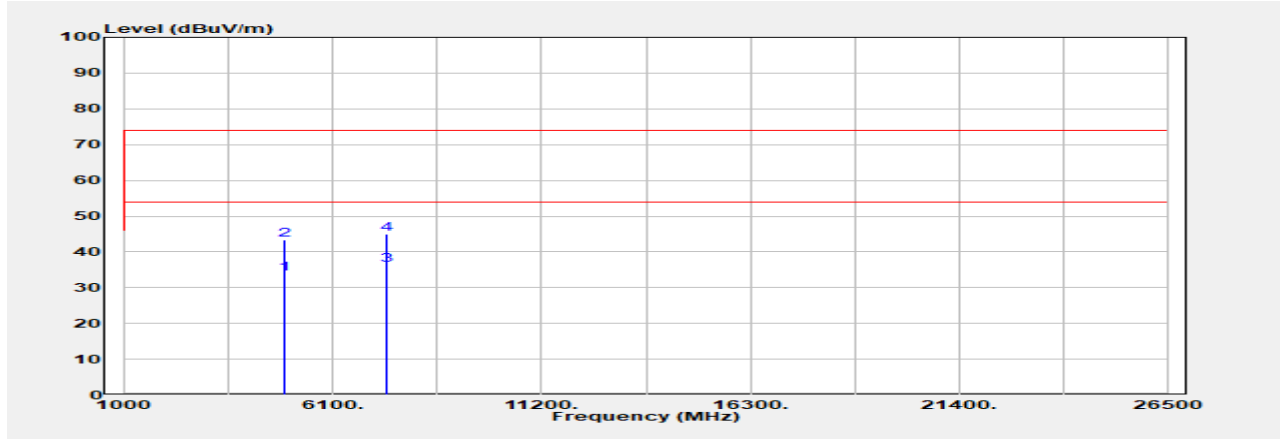

Freq. MHz	Detector Mode PK/QP/AVG	Spectrum Reading Level dBμV	Factor dB	Actual FS dBμV/m	Limit @3m dBμV/m	Margin dB
4924.000	Average	28.30	5.56	33.86	54.00	-20.14
4924.000	Peak	37.84	5.56	43.39	74.00	-30.61
7386.000	Average	25.90	10.29	36.19	54.00	-17.81
7386.000	Peak	34.81	10.29	45.10	74.00	-28.90

Unless otherwise stated the results shown in this test report refer only to the sample(s) tested and such sample(s) are retained for 90 days only.

除非另有說明，此報告結果僅對測試之樣品負責，同時此樣品僅保留90天。本報告未經本公司書面許可，不可部份複製。

This document is issued by the Company subject to its General Conditions of Service printed overleaf, available on request or accessible at <http://www.sgs.com.tw/Terms-and-Conditions> and for electronic format documents, subject to Terms and Conditions for Electronic Documents at <http://www.sgs.com.tw/Terms-and-Conditions>. Attention is drawn to the limitation of liability, indemnification and jurisdiction issues defined therein. Any holder of this document is advised that information contained hereon reflects the Company's findings at the time of its intervention only and within the limits of Client's instructions, if any. The Company's sole responsibility is to its Client and this document does not exonerate parties to a transaction from exercising all their rights and obligations under the transaction documents. This document cannot be reproduced except in full, without prior written approval of the Company. Any unauthorized alteration, forgery or falsification of the content or appearance of this document is unlawful and offenders may be prosecuted to the fullest extent of the law.

Report Number :TERF2404000848E2  
 Operation Mode :802.11g  
 Test Frequency :2412 MHz  
 Test Mode :Tx  
 EUT Pol :E2 Plane

Test Site :SAC G Chamber  
 Test Date :2024-04-09  
 Temp./Humi. :24.9°C/59%  
 Antenna Pol. :Vertical  
 Engineer :Temo Chen

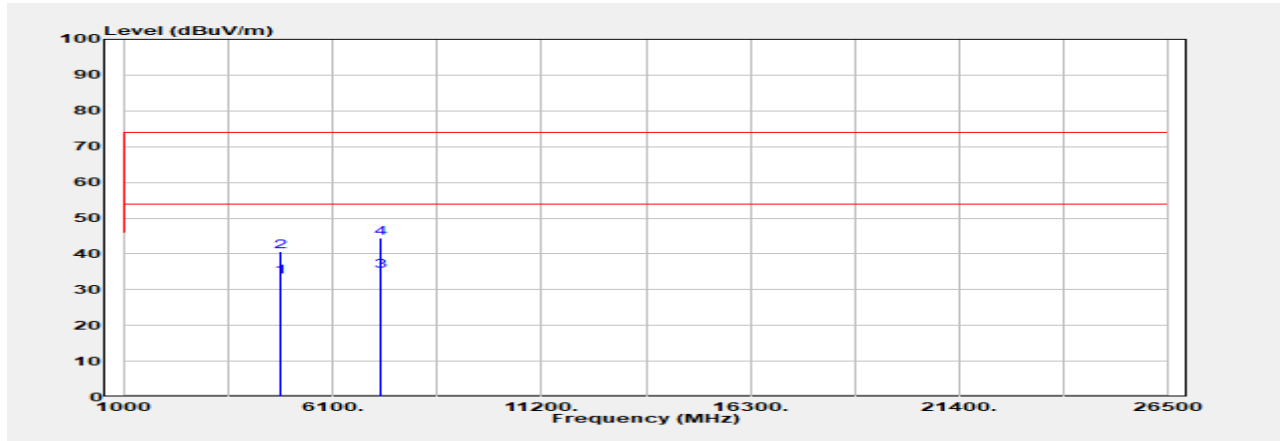

Freq. MHz	Detector Mode PK/QP/AVG	Spectrum Reading Level dBμV	Factor dB	Actual FS dBμV/m	Limit @3m dBμV/m	Margin dB
4824.000	Average	28.43	5.10	33.53	54.00	-20.47
4824.000	Peak	35.68	5.10	40.78	74.00	-33.22
7236.000	Average	25.67	9.60	35.27	54.00	-18.73
7236.000	Peak	34.98	9.60	44.58	74.00	-29.42

Unless otherwise stated the results shown in this test report refer only to the sample(s) tested and such sample(s) are retained for 90 days only.

除非另有說明，此報告結果僅對測試之樣品負責，同時此樣品僅保留90天。本報告未經本公司書面許可，不可部份複製。

This document is issued by the Company subject to its General Conditions of Service printed overleaf, available on request or accessible at <http://www.sgs.com.tw/Terms-and-Conditions> and for electronic format documents, subject to Terms and Conditions for Electronic Documents at <http://www.sgs.com.tw/Terms-and-Conditions>. Attention is drawn to the limitation of liability, indemnification and jurisdiction issues defined therein. Any holder of this document is advised that information contained hereon reflects the Company's findings at the time of its intervention only and within the limits of Client's instructions, if any. The Company's sole responsibility is to its Client and this document does not exonerate parties to a transaction from exercising all their rights and obligations under the transaction documents. This document cannot be reproduced except in full, without prior written approval of the Company. Any unauthorized alteration, forgery or falsification of the content or appearance of this document is unlawful and offenders may be prosecuted to the fullest extent of the law.

Report Number :TERF2404000848E2  
 Operation Mode :802.11g  
 Test Frequency :2412 MHz  
 Test Mode :Tx  
 EUT Pol :E2 Plane

Test Site :SAC G Chamber  
 Test Date :2024-04-09  
 Temp./Humi. :24.9°C/59%  
 Antenna Pol. :Horizontal  
 Engineer :Temo Chen

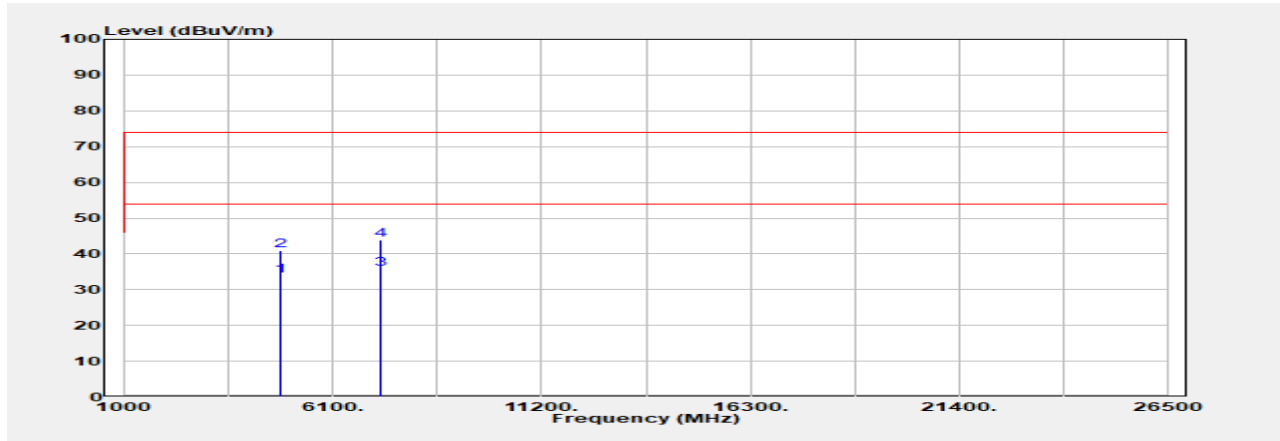

Freq. MHz	Detector Mode PK/QP/AVG	Spectrum Reading Level dBμV	Factor dB	Actual FS dBμV/m	Limit @3m dBμV/m	Margin dB
4824.000	Average	28.75	5.10	33.85	54.00	-20.15
4824.000	Peak	35.72	5.10	40.83	74.00	-33.17
7236.000	Average	26.12	9.60	35.72	54.00	-18.28
7236.000	Peak	34.38	9.60	43.99	74.00	-30.01

Unless otherwise stated the results shown in this test report refer only to the sample(s) tested and such sample(s) are retained for 90 days only.

除非另有說明，此報告結果僅對測試之樣品負責，同時此樣品僅保留90天。本報告未經本公司書面許可，不可部份複製。

This document is issued by the Company subject to its General Conditions of Service printed overleaf, available on request or accessible at <http://www.sgs.com.tw/Terms-and-Conditions> and for electronic format documents, subject to Terms and Conditions for Electronic Documents at <http://www.sgs.com.tw/Terms-and-Conditions>. Attention is drawn to the limitation of liability, indemnification and jurisdiction issues defined therein. Any holder of this document is advised that information contained hereon reflects the Company's findings at the time of its intervention only and within the limits of Client's instructions, if any. The Company's sole responsibility is to its Client and this document does not exonerate parties to a transaction from exercising all their rights and obligations under the transaction documents. This document cannot be reproduced except in full, without prior written approval of the Company. Any unauthorized alteration, forgery or falsification of the content or appearance of this document is unlawful and offenders may be prosecuted to the fullest extent of the law.



Report Number :TERF2404000848E2  
 Operation Mode :802.11g  
 Test Frequency :2437 MHz  
 Test Mode :Tx  
 EUT Pol :E2 Plane

Test Site :SAC G Chamber  
 Test Date :2024-04-09  
 Temp./Humi. :24.9°C/59%  
 Antenna Pol. :Vertical  
 Engineer :Temo Chen

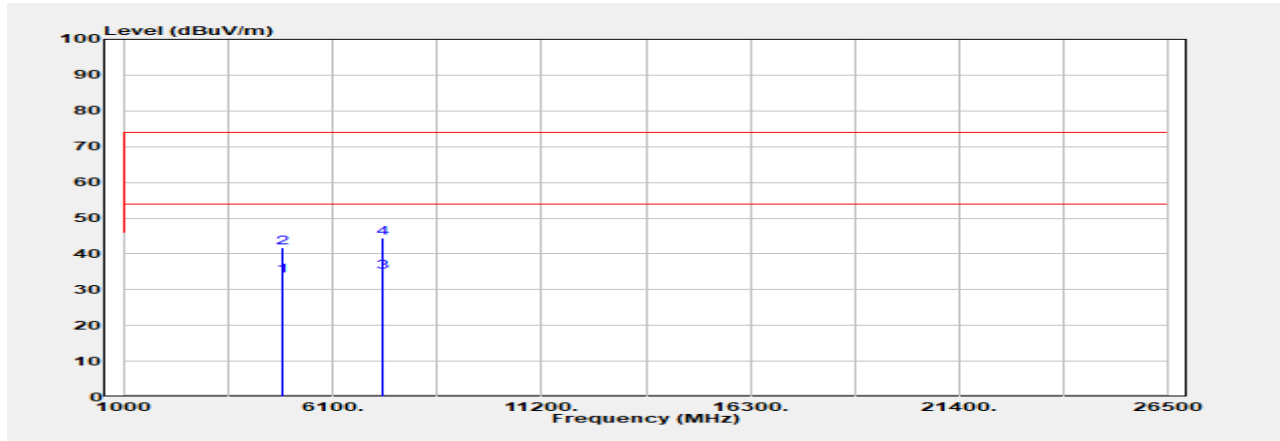

Freq. MHz	Detector Mode PK/QP/AVG	Spectrum Reading Level dB $\mu$ V	Factor dB	Actual FS dB $\mu$ V/m	Limit @3m dB $\mu$ V/m	Margin dB
4874.000	Average	28.49	5.35	33.84	54.00	-20.16
4874.000	Peak	36.26	5.35	41.61	74.00	-32.39
7311.000	Average	25.69	9.16	34.84	54.00	-19.16
7311.000	Peak	35.35	9.16	44.51	74.00	-29.49

Unless otherwise stated the results shown in this test report refer only to the sample(s) tested and such sample(s) are retained for 90 days only.

除非另有說明，此報告結果僅對測試之樣品負責，同時此樣品僅保留90天。本報告未經本公司書面許可，不可部份複製。

This document is issued by the Company subject to its General Conditions of Service printed overleaf, available on request or accessible at <http://www.sgs.com.tw/Terms-and-Conditions> and for electronic format documents, subject to Terms and Conditions for Electronic Documents at <http://www.sgs.com.tw/Terms-and-Conditions>. Attention is drawn to the limitation of liability, indemnification and jurisdiction issues defined therein. Any holder of this document is advised that information contained hereon reflects the Company's findings at the time of its intervention only and within the limits of Client's instructions, if any. The Company's sole responsibility is to its Client and this document does not exonerate parties to a transaction from exercising all their rights and obligations under the transaction documents. This document cannot be reproduced except in full, without prior written approval of the Company. Any unauthorized alteration, forgery or falsification of the content or appearance of this document is unlawful and offenders may be prosecuted to the fullest extent of the law.

Report Number :TERF2404000848E2  
 Operation Mode :802.11g  
 Test Frequency :2437 MHz  
 Test Mode :Tx  
 EUT Pol :E2 Plane

Test Site :SAC G Chamber  
 Test Date :2024-04-09  
 Temp./Humi. :24.9°C/59%  
 Antenna Pol. :Horizontal  
 Engineer :Temo Chen

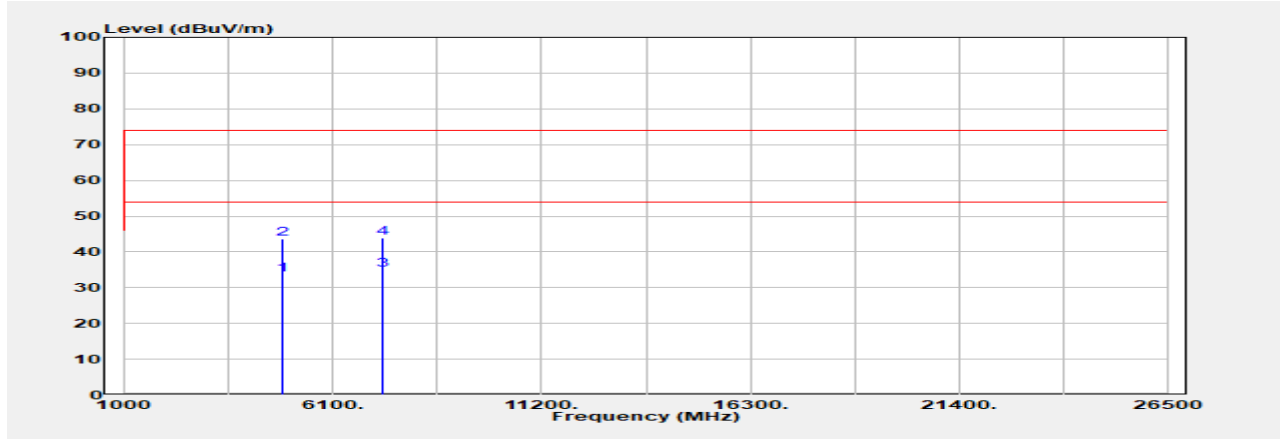

Freq. MHz	Detector Mode PK/QP/AVG	Spectrum Reading Level dBμV	Factor dB	Actual FS dBμV/m	Limit @3m dBμV/m	Margin dB
4874.000	Average	28.33	5.35	33.68	54.00	-20.32
4874.000	Peak	38.28	5.35	43.63	74.00	-30.37
7311.000	Average	25.88	9.16	35.03	54.00	-18.97
7311.000	Peak	34.68	9.16	43.83	74.00	-30.17

Unless otherwise stated the results shown in this test report refer only to the sample(s) tested and such sample(s) are retained for 90 days only.

除非另有說明，此報告結果僅對測試之樣品負責，同時此樣品僅保留90天。本報告未經本公司書面許可，不可部份複製。

This document is issued by the Company subject to its General Conditions of Service printed overleaf, available on request or accessible at <http://www.sgs.com.tw/Terms-and-Conditions> and for electronic format documents, subject to Terms and Conditions for Electronic Documents at <http://www.sgs.com.tw/Terms-and-Conditions>. Attention is drawn to the limitation of liability, indemnification and jurisdiction issues defined therein. Any holder of this document is advised that information contained hereon reflects the Company's findings at the time of its intervention only and within the limits of Client's instructions, if any. The Company's sole responsibility is to its Client and this document does not exonerate parties to a transaction from exercising all their rights and obligations under the transaction documents. This document cannot be reproduced except in full, without prior written approval of the Company. Any unauthorized alteration, forgery or falsification of the content or appearance of this document is unlawful and offenders may be prosecuted to the fullest extent of the law.

Report Number :TERF2404000848E2  
 Operation Mode :802.11g  
 Test Frequency :2462 MHz  
 Test Mode :Tx  
 EUT Pol :E2 Plane

Test Site :SAC G Chamber  
 Test Date :2024-04-09  
 Temp./Humi. :24.9°C/59%  
 Antenna Pol. :Vertical  
 Engineer :Temo Chen

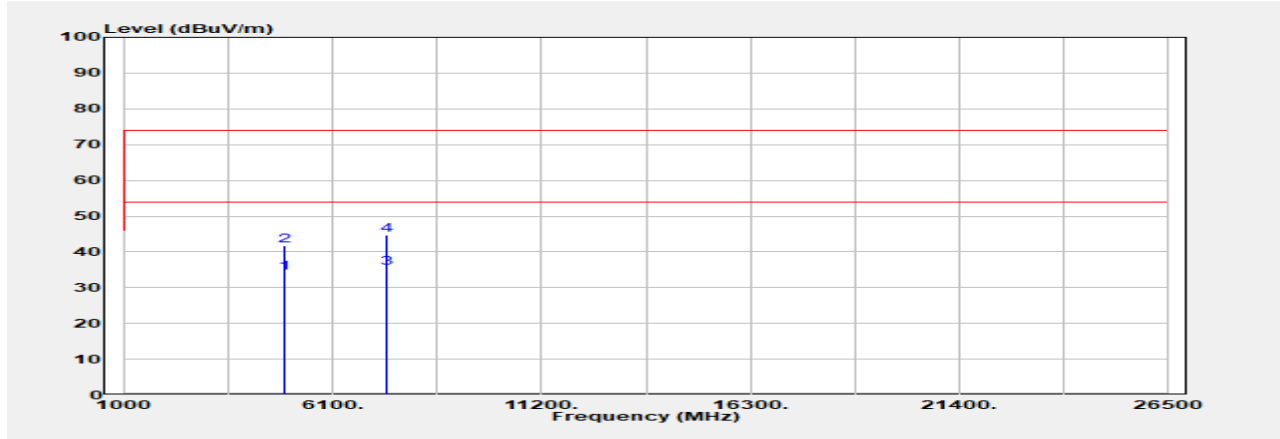

Freq. MHz	Detector Mode PK/QP/AVG	Spectrum Reading Level dB $\mu$ V	Factor dB	Actual FS dB $\mu$ V/m	Limit @3m dB $\mu$ V/m	Margin dB
4924.000	Average	28.57	5.56	34.13	54.00	-19.87
4924.000	Peak	36.16	5.56	41.72	74.00	-32.28
7386.000	Average	25.32	10.29	35.61	54.00	-18.39
7386.000	Peak	34.47	10.29	44.76	74.00	-29.24

Unless otherwise stated the results shown in this test report refer only to the sample(s) tested and such sample(s) are retained for 90 days only.

除非另有說明，此報告結果僅對測試之樣品負責，同時此樣品僅保留90天。本報告未經本公司書面許可，不可部份複製。  
 This document is issued by the Company subject to its General Conditions of Service printed overleaf, available on request or accessible at <http://www.sgs.com.tw/Terms-and-Conditions> and for electronic format documents, subject to Terms and Conditions for Electronic Documents at <http://www.sgs.com.tw/Terms-and-Conditions>. Attention is drawn to the limitation of liability, indemnification and jurisdiction issues defined therein. Any holder of this document is advised that information contained hereon reflects the Company's findings at the time of its intervention only and within the limits of Client's instructions, if any. The Company's sole responsibility is to its Client and this document does not exonerate parties to a transaction from exercising all their rights and obligations under the transaction documents. This document cannot be reproduced except in full, without prior written approval of the Company. Any unauthorized alteration, forgery or falsification of the content or appearance of this document is unlawful and offenders may be prosecuted to the fullest extent of the law.

Report Number :TERF2404000848E2  
 Operation Mode :802.11g  
 Test Frequency :2462 MHz  
 Test Mode :Tx  
 EUT Pol :E2 Plane

Test Site :SAC G Chamber  
 Test Date :2024-04-09  
 Temp./Humi. :24.9°C/59%  
 Antenna Pol. :Horizontal  
 Engineer :Temo Chen

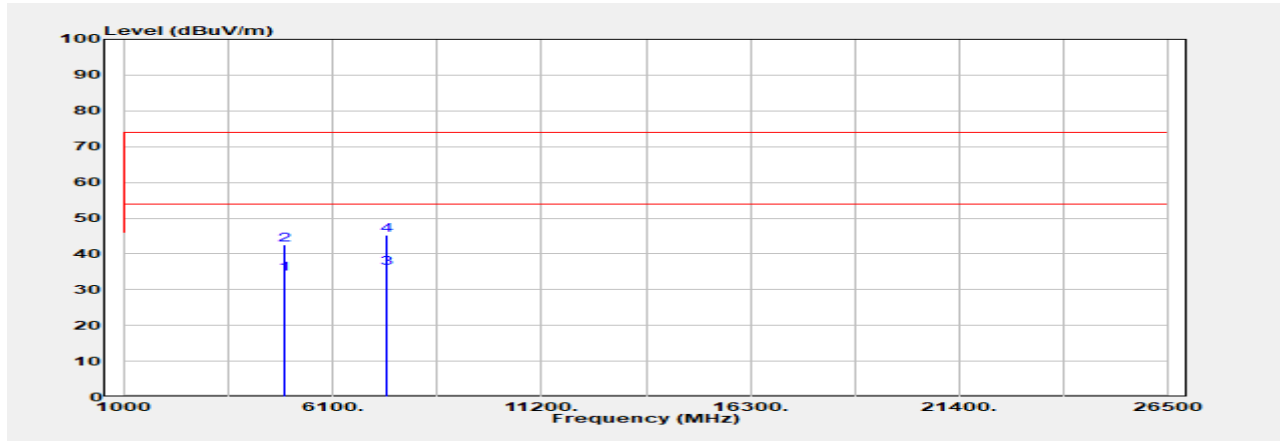

Freq. MHz	Detector Mode PK/QP/AVG	Spectrum Reading Level dBμV	Factor dB	Actual FS dBμV/m	Limit @3m dBμV/m	Margin dB
4924.000	Average	28.75	5.56	34.31	54.00	-19.69
4924.000	Peak	36.97	5.56	42.53	74.00	-31.47
7386.000	Average	25.69	10.29	35.98	54.00	-18.02
7386.000	Peak	34.97	10.29	45.26	74.00	-28.74

Unless otherwise stated the results shown in this test report refer only to the sample(s) tested and such sample(s) are retained for 90 days only.

除非另有說明，此報告結果僅對測試之樣品負責，同時此樣品僅保留90天。本報告未經本公司書面許可，不可部份複製。

This document is issued by the Company subject to its General Conditions of Service printed overleaf, available on request or accessible at <http://www.sgs.com.tw/Terms-and-Conditions> and for electronic format documents, subject to Terms and Conditions for Electronic Documents at <http://www.sgs.com.tw/Terms-and-Conditions>. Attention is drawn to the limitation of liability, indemnification and jurisdiction issues defined therein. Any holder of this document is advised that information contained hereon reflects the Company's findings at the time of its intervention only and within the limits of Client's instructions, if any. The Company's sole responsibility is to its Client and this document does not exonerate parties to a transaction from exercising all their rights and obligations under the transaction documents. This document cannot be reproduced except in full, without prior written approval of the Company. Any unauthorized alteration, forgery or falsification of the content or appearance of this document is unlawful and offenders may be prosecuted to the fullest extent of the law.

Report Number :TERF2404000848E2  
 Operation Mode :802.11n20  
 Test Frequency :2412 MHz  
 Test Mode :Tx  
 EUT Pol :E2 Plane

Test Site :SAC G Chamber  
 Test Date :2024-04-09  
 Temp./Humi. :24.9°C/59%  
 Antenna Pol. :Vertical  
 Engineer :Temo Chen

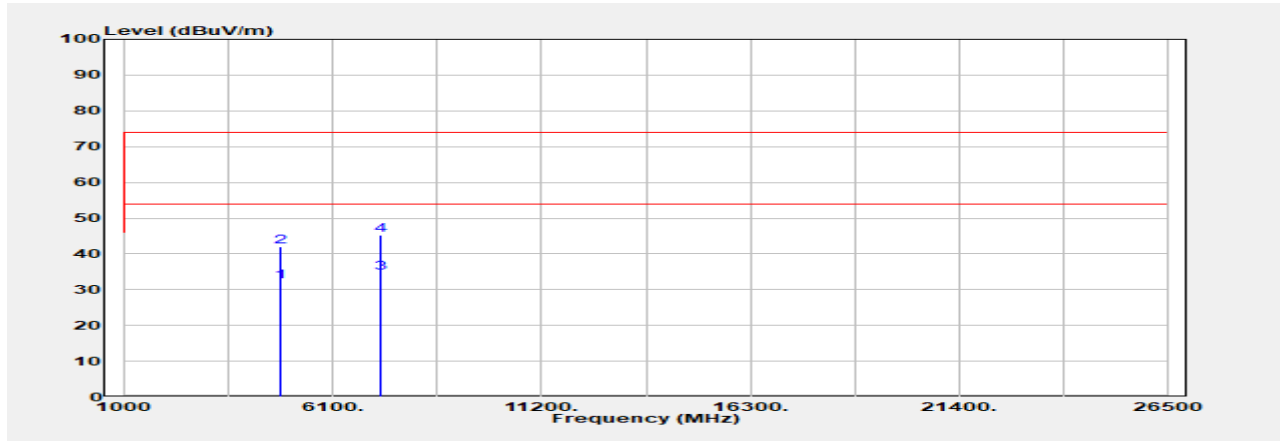

Freq. MHz	Detector Mode PK/QP/AVG	Spectrum Reading Level dBμV	Factor dB	Actual FS dBμV/m	Limit @3m dBμV/m	Margin dB
4824.000	Average	27.18	5.10	32.28	54.00	-21.72
4824.000	Peak	36.91	5.10	42.01	74.00	-31.99
7236.000	Average	25.08	9.60	34.68	54.00	-19.32
7236.000	Peak	35.65	9.60	45.26	74.00	-28.74

Unless otherwise stated the results shown in this test report refer only to the sample(s) tested and such sample(s) are retained for 90 days only.

除非另有說明，此報告結果僅對測試之樣品負責，同時此樣品僅保留90天。本報告未經本公司書面許可，不可部份複製。

This document is issued by the Company subject to its General Conditions of Service printed overleaf, available on request or accessible at <http://www.sgs.com.tw/Terms-and-Conditions> and for electronic format documents, subject to Terms and Conditions for Electronic Documents at <http://www.sgs.com.tw/Terms-and-Conditions>. Attention is drawn to the limitation of liability, indemnification and jurisdiction issues defined therein. Any holder of this document is advised that information contained hereon reflects the Company's findings at the time of its intervention only and within the limits of Client's instructions, if any. The Company's sole responsibility is to its Client and this document does not exonerate parties to a transaction from exercising all their rights and obligations under the transaction documents. This document cannot be reproduced except in full, without prior written approval of the Company. Any unauthorized alteration, forgery or falsification of the content or appearance of this document is unlawful and offenders may be prosecuted to the fullest extent of the law.

Report Number :TERF2404000848E2  
 Operation Mode :802.11n20  
 Test Frequency :2412 MHz  
 Test Mode :Tx  
 EUT Pol :E2 Plane

Test Site :SAC G Chamber  
 Test Date :2024-04-09  
 Temp./Humi. :24.9°C/59%  
 Antenna Pol. :Horizontal  
 Engineer :Temo Chen

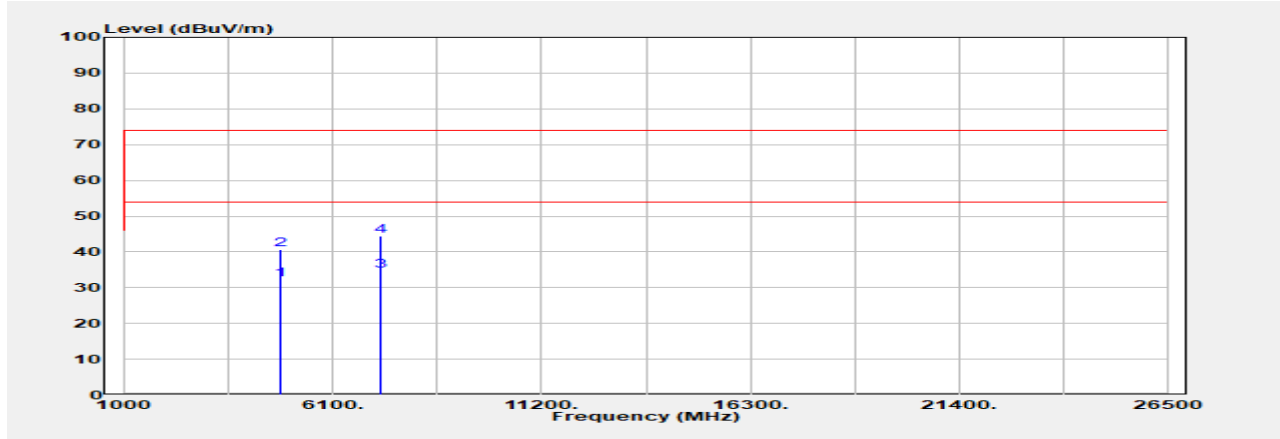

Freq. MHz	Detector Mode PK/QP/AVG	Spectrum Reading Level dBμV	Factor dB	Actual FS dBμV/m	Limit @3m dBμV/m	Margin dB
4824.000	Average	27.24	5.10	32.34	54.00	-21.66
4824.000	Peak	35.45	5.10	40.55	74.00	-33.45
7236.000	Average	25.19	9.60	34.79	54.00	-19.21
7236.000	Peak	34.90	9.60	44.51	74.00	-29.49

Unless otherwise stated the results shown in this test report refer only to the sample(s) tested and such sample(s) are retained for 90 days only.

除非另有說明，此報告結果僅對測試之樣品負責，同時此樣品僅保留90天。本報告未經本公司書面許可，不可部份複製。

This document is issued by the Company subject to its General Conditions of Service printed overleaf, available on request or accessible at <http://www.sgs.com.tw/Terms-and-Conditions> and for electronic format documents, subject to Terms and Conditions for Electronic Documents at <http://www.sgs.com.tw/Terms-and-Conditions>. Attention is drawn to the limitation of liability, indemnification and jurisdiction issues defined therein. Any holder of this document is advised that information contained hereon reflects the Company's findings at the time of its intervention only and within the limits of Client's instructions, if any. The Company's sole responsibility is to its Client and this document does not exonerate parties to a transaction from exercising all their rights and obligations under the transaction documents. This document cannot be reproduced except in full, without prior written approval of the Company. Any unauthorized alteration, forgery or falsification of the content or appearance of this document is unlawful and offenders may be prosecuted to the fullest extent of the law.

Report Number :TERF2404000848E2  
 Operation Mode :802.11n20  
 Test Frequency :2437 MHz  
 Test Mode :Tx  
 EUT Pol :E2 Plane

Test Site :SAC G Chamber  
 Test Date :2024-04-09  
 Temp./Humi. :24.9°C/59%  
 Antenna Pol. :Vertical  
 Engineer :Temo Chen

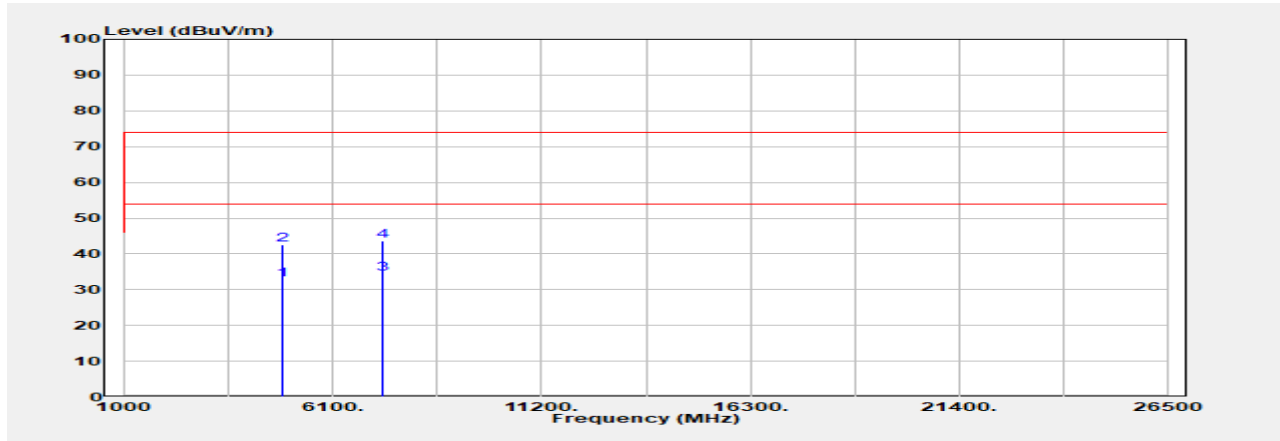

Freq. MHz	Detector Mode PK/QP/AVG	Spectrum Reading Level dB $\mu$ V	Factor dB	Actual FS dB $\mu$ V/m	Limit @3m dB $\mu$ V/m	Margin dB
4874.000	Average	27.34	5.35	32.69	54.00	-21.31
4874.000	Peak	37.09	5.35	42.44	74.00	-31.56
7311.000	Average	25.39	9.16	34.55	54.00	-19.45
7311.000	Peak	34.43	9.16	43.59	74.00	-30.41

Unless otherwise stated the results shown in this test report refer only to the sample(s) tested and such sample(s) are retained for 90 days only.

除非另有說明，此報告結果僅對測試之樣品負責，同時此樣品僅保留90天。本報告未經本公司書面許可，不可部份複製。

This document is issued by the Company subject to its General Conditions of Service printed overleaf, available on request or accessible at <http://www.sgs.com.tw/Terms-and-Conditions> and for electronic format documents, subject to Terms and Conditions for Electronic Documents at <http://www.sgs.com.tw/Terms-and-Conditions>. Attention is drawn to the limitation of liability, indemnification and jurisdiction issues defined therein. Any holder of this document is advised that information contained hereon reflects the Company's findings at the time of its intervention only and within the limits of Client's instructions, if any. The Company's sole responsibility is to its Client and this document does not exonerate parties to a transaction from exercising all their rights and obligations under the transaction documents. This document cannot be reproduced except in full, without prior written approval of the Company. Any unauthorized alteration, forgery or falsification of the content or appearance of this document is unlawful and offenders may be prosecuted to the fullest extent of the law.

Report Number :TERF2404000848E2  
 Operation Mode :802.11n20  
 Test Frequency :2437 MHz  
 Test Mode :Tx  
 EUT Pol :E2 Plane

Test Site :SAC G Chamber  
 Test Date :2024-04-09  
 Temp./Humi. :24.9°C/59%  
 Antenna Pol. :Horizontal  
 Engineer :Temo Chen

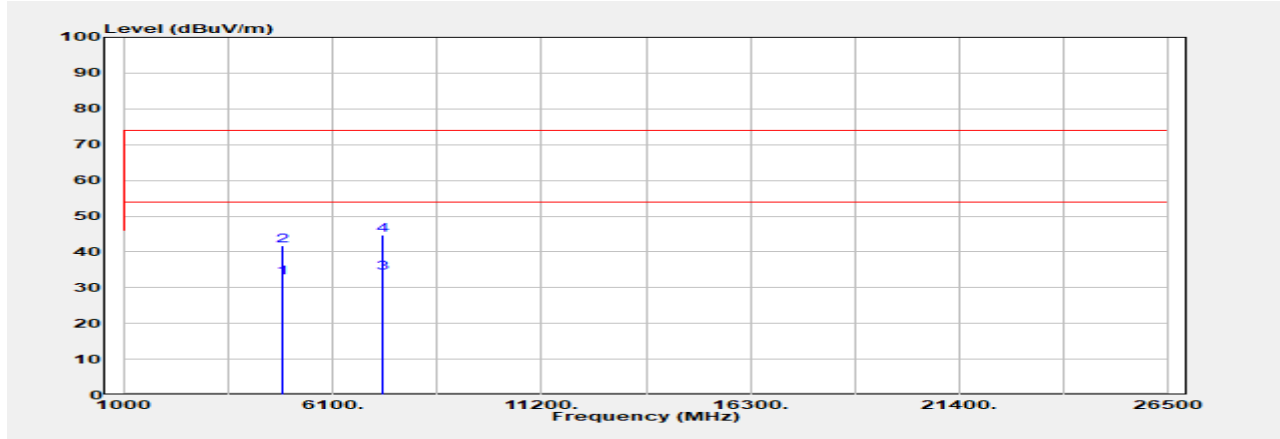

Freq. MHz	Detector Mode PK/QP/AVG	Spectrum Reading Level dBμV	Factor dB	Actual FS dBμV/m	Limit @3m dBμV/m	Margin dB
4874.000	Average	27.49	5.35	32.84	54.00	-21.16
4874.000	Peak	36.43	5.35	41.78	74.00	-32.22
7311.000	Average	25.09	9.16	34.25	54.00	-19.75
7311.000	Peak	35.57	9.16	44.72	74.00	-29.28

Unless otherwise stated the results shown in this test report refer only to the sample(s) tested and such sample(s) are retained for 90 days only.

除非另有說明，此報告結果僅對測試之樣品負責，同時此樣品僅保留90天。本報告未經本公司書面許可，不可部份複製。

This document is issued by the Company subject to its General Conditions of Service printed overleaf, available on request or accessible at <http://www.sgs.com.tw/Terms-and-Conditions> and for electronic format documents, subject to Terms and Conditions for Electronic Documents at <http://www.sgs.com.tw/Terms-and-Conditions>. Attention is drawn to the limitation of liability, indemnification and jurisdiction issues defined therein. Any holder of this document is advised that information contained hereon reflects the Company's findings at the time of its intervention only and within the limits of Client's instructions, if any. The Company's sole responsibility is to its Client and this document does not exonerate parties to a transaction from exercising all their rights and obligations under the transaction documents. This document cannot be reproduced except in full, without prior written approval of the Company. Any unauthorized alteration, forgery or falsification of the content or appearance of this document is unlawful and offenders may be prosecuted to the fullest extent of the law.



Report Number :TERF2404000848E2  
 Operation Mode :802.11n20  
 Test Frequency :2462 MHz  
 Test Mode :Tx  
 EUT Pol :E2 Plane

Test Site :SAC G Chamber  
 Test Date :2024-04-09  
 Temp./Humi. :24.9°C/59%  
 Antenna Pol. :Vertical  
 Engineer :Temo Chen

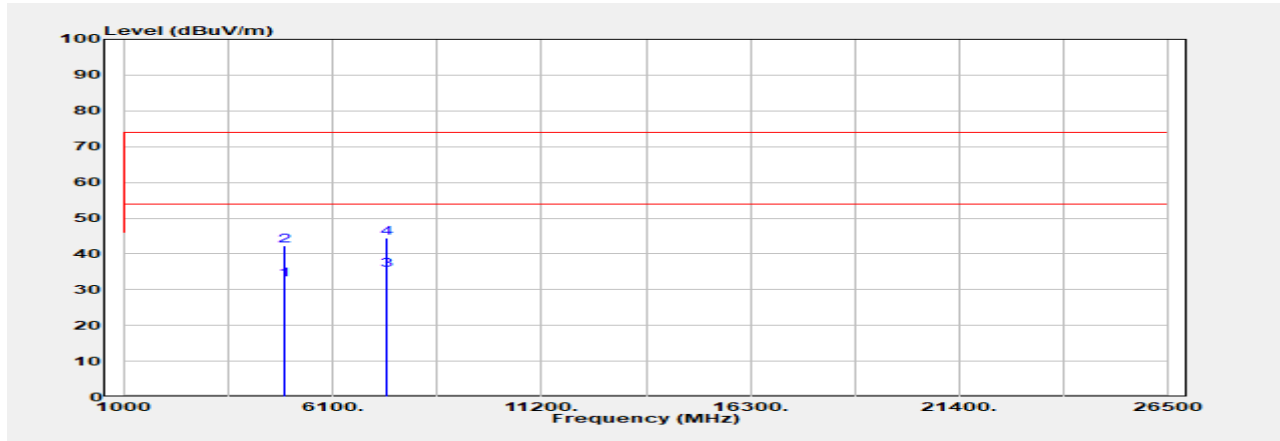

Freq. MHz	Detector Mode PK/QP/AVG	Spectrum Reading Level dBμV	Factor dB	Actual FS dBμV/m	Limit @3m dBμV/m	Margin dB
4924.000	Average	27.33	5.56	32.89	54.00	-21.11
4924.000	Peak	36.79	5.56	42.34	74.00	-31.66
7386.000	Average	25.22	10.29	35.51	54.00	-18.49
7386.000	Peak	34.28	10.29	44.57	74.00	-29.43

Unless otherwise stated the results shown in this test report refer only to the sample(s) tested and such sample(s) are retained for 90 days only.

除非另有說明，此報告結果僅對測試之樣品負責，同時此樣品僅保留90天。本報告未經本公司書面許可，不可部份複製。

This document is issued by the Company subject to its General Conditions of Service printed overleaf, available on request or accessible at <http://www.sgs.com.tw/Terms-and-Conditions> and for electronic format documents, subject to Terms and Conditions for Electronic Documents at <http://www.sgs.com.tw/Terms-and-Conditions>. Attention is drawn to the limitation of liability, indemnification and jurisdiction issues defined therein. Any holder of this document is advised that information contained hereon reflects the Company's findings at the time of its intervention only and within the limits of Client's instructions, if any. The Company's sole responsibility is to its Client and this document does not exonerate parties to a transaction from exercising all their rights and obligations under the transaction documents. This document cannot be reproduced except in full, without prior written approval of the Company. Any unauthorized alteration, forgery or falsification of the content or appearance of this document is unlawful and offenders may be prosecuted to the fullest extent of the law.

Report Number :TERF2404000848E2  
 Operation Mode :802.11n20  
 Test Frequency :2462 MHz  
 Test Mode :Tx  
 EUT Pol :E2 Plane

Test Site :SAC G Chamber  
 Test Date :2024-04-09  
 Temp./Humi. :24.9°C/59%  
 Antenna Pol. :Horizontal  
 Engineer :Temo Chen

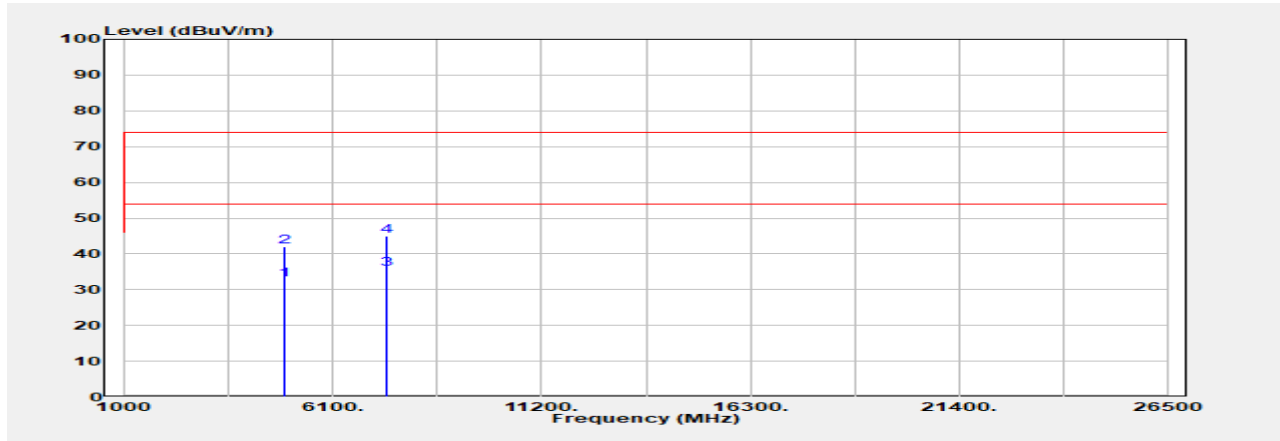

Freq. MHz	Detector Mode PK/QP/AVG	Spectrum Reading Level dB $\mu$ V	Factor dB	Actual FS dB $\mu$ V/m	Limit @3m dB $\mu$ V/m	Margin dB
4924.000	Average	27.36	5.56	32.92	54.00	-21.08
4924.000	Peak	36.33	5.56	41.89	74.00	-32.11
7386.000	Average	25.44	10.29	35.73	54.00	-18.27
7386.000	Peak	34.69	10.29	44.98	74.00	-29.02

Unless otherwise stated the results shown in this test report refer only to the sample(s) tested and such sample(s) are retained for 90 days only.

除非另有說明，此報告結果僅對測試之樣品負責，同時此樣品僅保留90天。本報告未經本公司書面許可，不可部份複製。

This document is issued by the Company subject to its General Conditions of Service printed overleaf, available on request or accessible at <http://www.sgs.com.tw/Terms-and-Conditions> and for electronic format documents, subject to Terms and Conditions for Electronic Documents at <http://www.sgs.com.tw/Terms-and-Conditions>. Attention is drawn to the limitation of liability, indemnification and jurisdiction issues defined therein. Any holder of this document is advised that information contained hereon reflects the Company's findings at the time of its intervention only and within the limits of Client's instructions, if any. The Company's sole responsibility is to its Client and this document does not exonerate parties to a transaction from exercising all their rights and obligations under the transaction documents. This document cannot be reproduced except in full, without prior written approval of the Company. Any unauthorized alteration, forgery or falsification of the content or appearance of this document is unlawful and offenders may be prosecuted to the fullest extent of the law.

Report Number :TERF2404000848E2  
 Operation Mode :802.11n40  
 Test Frequency :2422 MHz  
 Test Mode :Tx  
 EUT Pol :E2 Plane

Test Site :SAC G Chamber  
 Test Date :2024-04-09  
 Temp./Humi. :24.9°C/59%  
 Antenna Pol. :Vertical  
 Engineer :Temo Chen

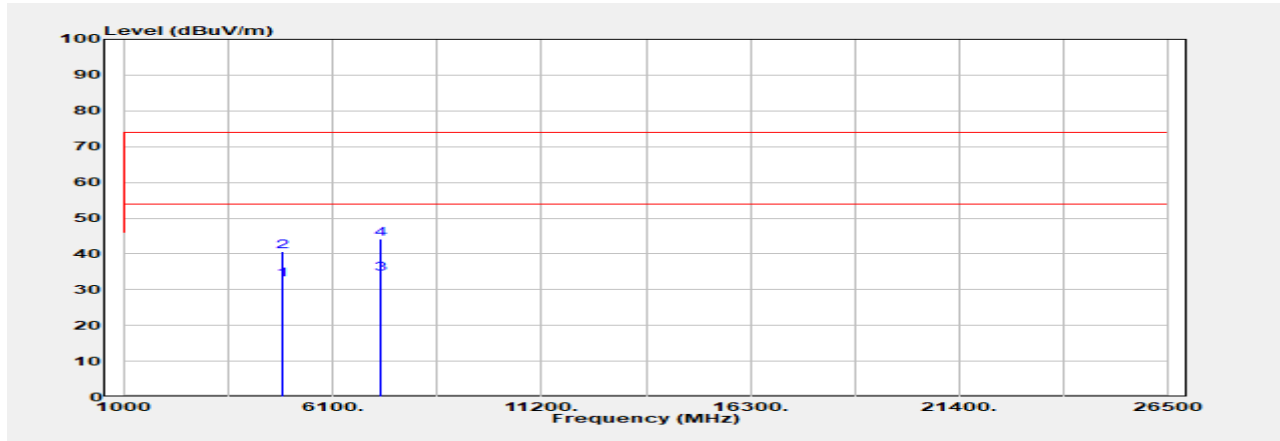

Freq. MHz	Detector Mode PK/QP/AVG	Spectrum Reading Level dBμV	Factor dB	Actual FS dBμV/m	Limit @3m dBμV/m	Margin dB
4844.000	Average	27.47	5.22	32.69	54.00	-21.31
4844.000	Peak	35.47	5.22	40.69	74.00	-33.31
7266.000	Average	25.12	9.35	34.47	54.00	-19.53
7266.000	Peak	34.88	9.35	44.22	74.00	-29.78

Unless otherwise stated the results shown in this test report refer only to the sample(s) tested and such sample(s) are retained for 90 days only.

除非另有說明，此報告結果僅對測試之樣品負責，同時此樣品僅保留90天。本報告未經本公司書面許可，不可部份複製。

This document is issued by the Company subject to its General Conditions of Service printed overleaf, available on request or accessible at <http://www.sgs.com.tw/Terms-and-Conditions> and for electronic format documents, subject to Terms and Conditions for Electronic Documents at <http://www.sgs.com.tw/Terms-and-Conditions>. Attention is drawn to the limitation of liability, indemnification and jurisdiction issues defined therein. Any holder of this document is advised that information contained hereon reflects the Company's findings at the time of its intervention only and within the limits of Client's instructions, if any. The Company's sole responsibility is to its Client and this document does not exonerate parties to a transaction from exercising all their rights and obligations under the transaction documents. This document cannot be reproduced except in full, without prior written approval of the Company. Any unauthorized alteration, forgery or falsification of the content or appearance of this document is unlawful and offenders may be prosecuted to the fullest extent of the law.

Report Number :TERF2404000848E2  
 Operation Mode :802.11n40  
 Test Frequency :2422 MHz  
 Test Mode :Tx  
 EUT Pol :E2 Plane

Test Site :SAC G Chamber  
 Test Date :2024-04-09  
 Temp./Humi. :24.9°C/59%  
 Antenna Pol. :Horizontal  
 Engineer :Temo Chen

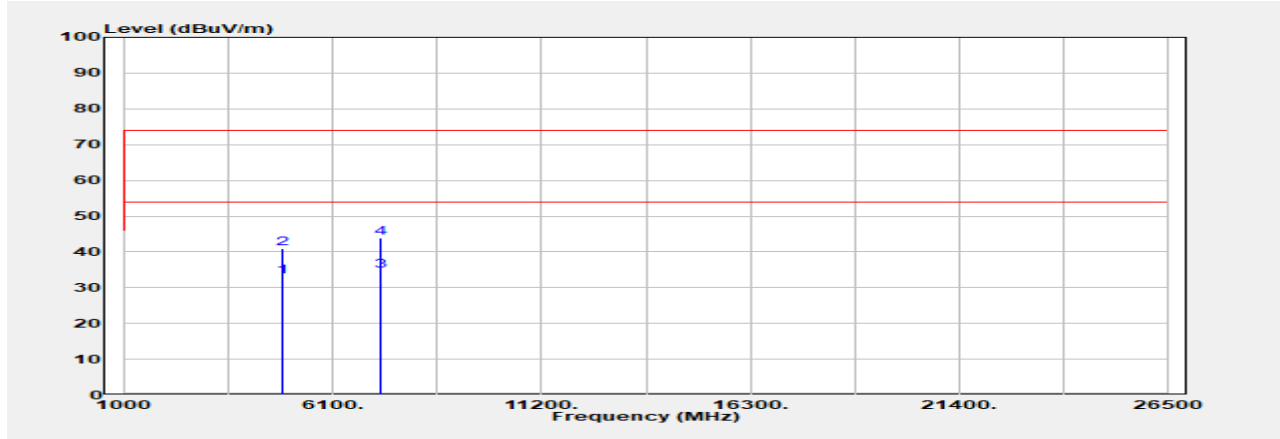

Freq. MHz	Detector Mode PK/QP/AVG	Spectrum Reading Level dBμV	Factor dB	Actual FS dBμV/m	Limit @3m dBμV/m	Margin dB
4844.000	Average	27.84	5.22	33.06	54.00	-20.94
4844.000	Peak	35.67	5.22	40.89	74.00	-33.11
7266.000	Average	25.33	9.35	34.68	54.00	-19.32
7266.000	Peak	34.64	9.35	43.98	74.00	-30.02

Unless otherwise stated the results shown in this test report refer only to the sample(s) tested and such sample(s) are retained for 90 days only.

除非另有說明，此報告結果僅對測試之樣品負責，同時此樣品僅保留90天。本報告未經本公司書面許可，不可部份複製。

This document is issued by the Company subject to its General Conditions of Service printed overleaf, available on request or accessible at <http://www.sgs.com.tw/Terms-and-Conditions> and for electronic format documents, subject to Terms and Conditions for Electronic Documents at <http://www.sgs.com.tw/Terms-and-Conditions>. Attention is drawn to the limitation of liability, indemnification and jurisdiction issues defined therein. Any holder of this document is advised that information contained hereon reflects the Company's findings at the time of its intervention only and within the limits of Client's instructions, if any. The Company's sole responsibility is to its Client and this document does not exonerate parties to a transaction from exercising all their rights and obligations under the transaction documents. This document cannot be reproduced except in full, without prior written approval of the Company. Any unauthorized alteration, forgery or falsification of the content or appearance of this document is unlawful and offenders may be prosecuted to the fullest extent of the law.

Report Number :TERF2404000848E2  
 Operation Mode :802.11n40  
 Test Frequency :2437 MHz  
 Test Mode :Tx  
 EUT Pol :E2 Plane

Test Site :SAC G Chamber  
 Test Date :2024-04-09  
 Temp./Humi. :24.9°C/59%  
 Antenna Pol. :Vertical  
 Engineer :Temo Chen

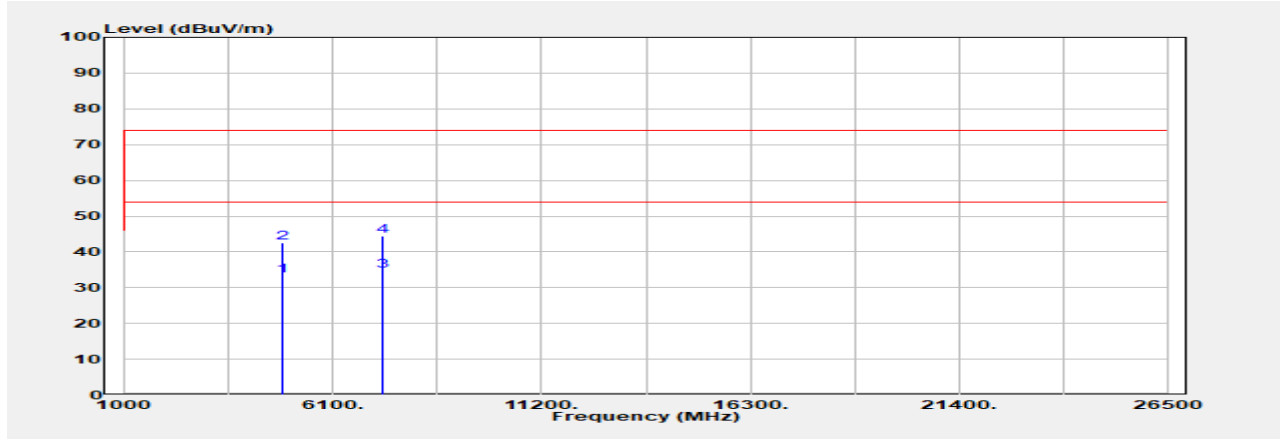

Freq. MHz	Detector Mode PK/QP/AVG	Spectrum Reading Level dBμV	Factor dB	Actual FS dBμV/m	Limit @3m dBμV/m	Margin dB
4874.000	Average	28.03	5.35	33.38	54.00	-20.62
4874.000	Peak	37.26	5.35	42.61	74.00	-31.39
7311.000	Average	25.47	9.16	34.63	54.00	-19.37
7311.000	Peak	35.25	9.16	44.41	74.00	-29.59

Unless otherwise stated the results shown in this test report refer only to the sample(s) tested and such sample(s) are retained for 90 days only.

除非另有說明，此報告結果僅對測試之樣品負責，同時此樣品僅保留90天。本報告未經本公司書面許可，不可部份複製。

This document is issued by the Company subject to its General Conditions of Service printed overleaf, available on request or accessible at <http://www.sgs.com.tw/Terms-and-Conditions> and for electronic format documents, subject to Terms and Conditions for Electronic Documents at <http://www.sgs.com.tw/Terms-and-Conditions>. Attention is drawn to the limitation of liability, indemnification and jurisdiction issues defined therein. Any holder of this document is advised that information contained hereon reflects the Company's findings at the time of its intervention only and within the limits of Client's instructions, if any. The Company's sole responsibility is to its Client and this document does not exonerate parties to a transaction from exercising all their rights and obligations under the transaction documents. This document cannot be reproduced except in full, without prior written approval of the Company. Any unauthorized alteration, forgery or falsification of the content or appearance of this document is unlawful and offenders may be prosecuted to the fullest extent of the law.

Report Number :TERF2404000848E2  
 Operation Mode :802.11n40  
 Test Frequency :2437 MHz  
 Test Mode :Tx  
 EUT Pol :E2 Plane

Test Site :SAC G Chamber  
 Test Date :2024-04-09  
 Temp./Humi. :24.9°C/59%  
 Antenna Pol. :Horizontal  
 Engineer :Temo Chen

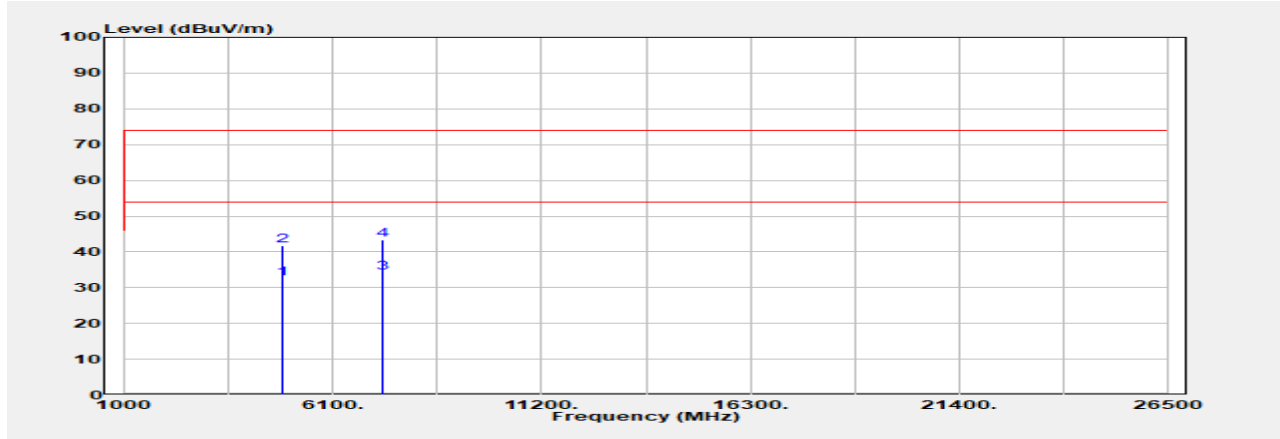

Freq. MHz	Detector Mode PK/QP/AVG	Spectrum Reading Level dBμV	Factor dB	Actual FS dBμV/m	Limit @3m dBμV/m	Margin dB
4874.000	Average	27.23	5.35	32.58	54.00	-21.42
4874.000	Peak	36.33	5.35	41.68	74.00	-32.32
7311.000	Average	25.06	9.16	34.22	54.00	-19.78
7311.000	Peak	34.21	9.16	43.36	74.00	-30.64

Unless otherwise stated the results shown in this test report refer only to the sample(s) tested and such sample(s) are retained for 90 days only.

除非另有說明，此報告結果僅對測試之樣品負責，同時此樣品僅保留90天。本報告未經本公司書面許可，不可部份複製。

This document is issued by the Company subject to its General Conditions of Service printed overleaf, available on request or accessible at <http://www.sgs.com.tw/Terms-and-Conditions> and for electronic format documents, subject to Terms and Conditions for Electronic Documents at <http://www.sgs.com.tw/Terms-and-Conditions>. Attention is drawn to the limitation of liability, indemnification and jurisdiction issues defined therein. Any holder of this document is advised that information contained hereon reflects the Company's findings at the time of its intervention only and within the limits of Client's instructions, if any. The Company's sole responsibility is to its Client and this document does not exonerate parties to a transaction from exercising all their rights and obligations under the transaction documents. This document cannot be reproduced except in full, without prior written approval of the Company. Any unauthorized alteration, forgery or falsification of the content or appearance of this document is unlawful and offenders may be prosecuted to the fullest extent of the law.

Report Number :TERF2404000848E2  
 Operation Mode :802.11n40  
 Test Frequency :2452 MHz  
 Test Mode :Tx  
 EUT Pol :E2 Plane

Test Site :SAC G Chamber  
 Test Date :2024-04-09  
 Temp./Humi. :24.9°C/59%  
 Antenna Pol. :Vertical  
 Engineer :Temo Chen

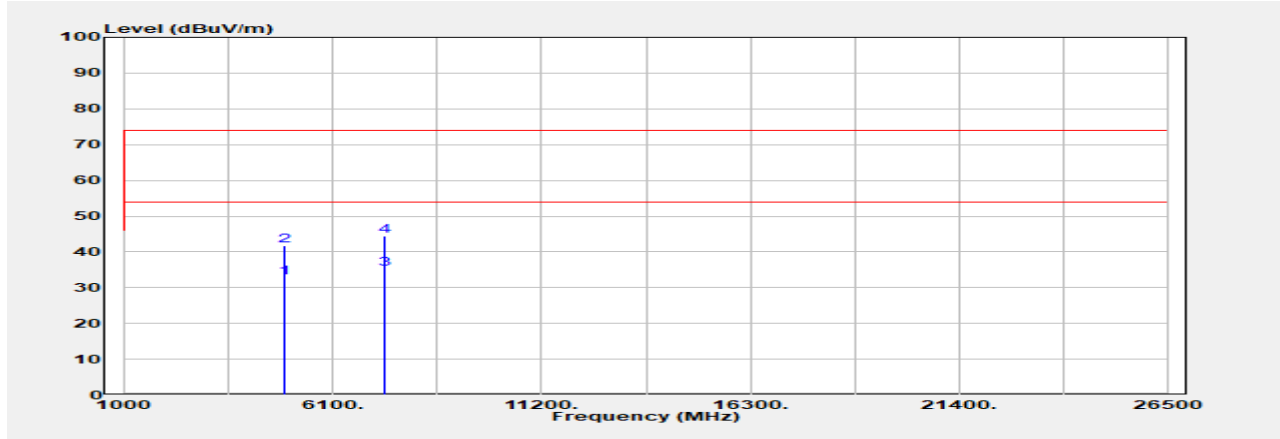

Freq. MHz	Detector Mode PK/QP/AVG	Spectrum Reading Level dBμV	Factor dB	Actual FS dBμV/m	Limit @3m dBμV/m	Margin dB
4904.000	Average	27.32	5.47	32.79	54.00	-21.21
4904.000	Peak	36.32	5.47	41.78	74.00	-32.22
7356.000	Average	25.42	9.84	35.26	54.00	-18.74
7356.000	Peak	34.71	9.84	44.55	74.00	-29.45

Unless otherwise stated the results shown in this test report refer only to the sample(s) tested and such sample(s) are retained for 90 days only.

除非另有說明，此報告結果僅對測試之樣品負責，同時此樣品僅保留90天。本報告未經本公司書面許可，不可部份複製。

This document is issued by the Company subject to its General Conditions of Service printed overleaf, available on request or accessible at <http://www.sgs.com.tw/Terms-and-Conditions> and for electronic format documents, subject to Terms and Conditions for Electronic Documents at <http://www.sgs.com.tw/Terms-and-Conditions>. Attention is drawn to the limitation of liability, indemnification and jurisdiction issues defined therein. Any holder of this document is advised that information contained hereon reflects the Company's findings at the time of its intervention only and within the limits of Client's instructions, if any. The Company's sole responsibility is to its Client and this document does not exonerate parties to a transaction from exercising all their rights and obligations under the transaction documents. This document cannot be reproduced except in full, without prior written approval of the Company. Any unauthorized alteration, forgery or falsification of the content or appearance of this document is unlawful and offenders may be prosecuted to the fullest extent of the law.

Report Number :TERF2404000848E2  
 Operation Mode :802.11n40  
 Test Frequency :2452 MHz  
 Test Mode :Tx  
 EUT Pol :E2 Plane

Test Site :SAC G Chamber  
 Test Date :2024-04-09  
 Temp./Humi. :24.9°C/59%  
 Antenna Pol. :Horizontal  
 Engineer :Temo Chen

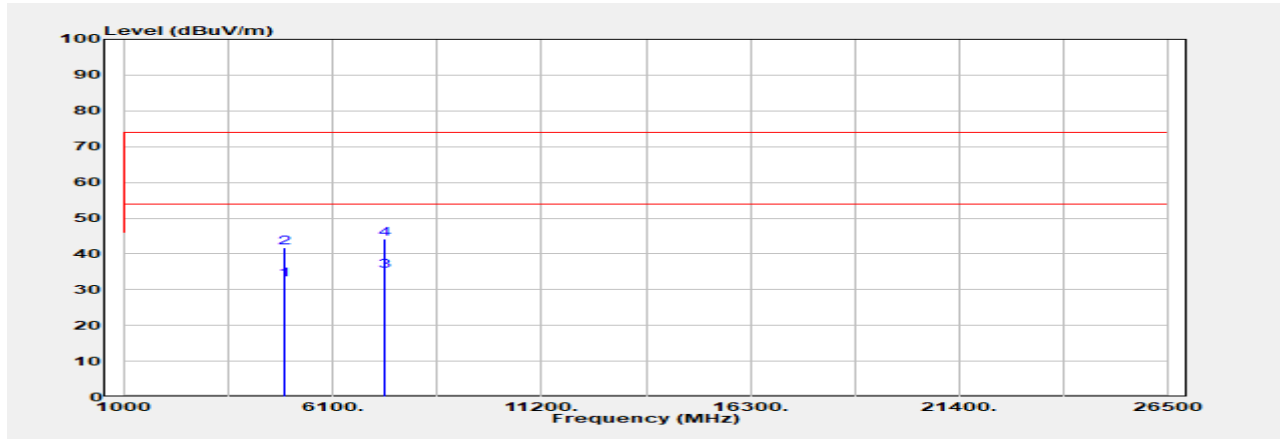

Freq. MHz	Detector Mode PK/QP/AVG	Spectrum Reading Level dBμV	Factor dB	Actual FS dBμV/m	Limit @3m dBμV/m	Margin dB
4904.000	Average	27.44	5.47	32.91	54.00	-21.09
4904.000	Peak	36.31	5.47	41.78	74.00	-32.22
7356.000	Average	25.30	9.84	35.14	54.00	-18.86
7356.000	Peak	34.46	9.84	44.30	74.00	-29.70

~ End of Report ~

Unless otherwise stated the results shown in this test report refer only to the sample(s) tested and such sample(s) are retained for 90 days only.

除非另有說明，此報告結果僅對測試之樣品負責，同時此樣品僅保留90天。本報告未經本公司書面許可，不可部份複製。

This document is issued by the Company subject to its General Conditions of Service printed overleaf, available on request or accessible at <http://www.sgs.com.tw/Terms-and-Conditions> and for electronic format documents, subject to Terms and Conditions for Electronic Documents at <http://www.sgs.com.tw/Terms-and-Conditions>. Attention is drawn to the limitation of liability, indemnification and jurisdiction issues defined therein. Any holder of this document is advised that information contained hereon reflects the Company's findings at the time of its intervention only and within the limits of Client's instructions, if any. The Company's sole responsibility is to its Client and this document does not exonerate parties to a transaction from exercising all their rights and obligations under the transaction documents. This document cannot be reproduced except in full, without prior written approval of the Company. Any unauthorized alteration, forgery or falsification of the content or appearance of this document is unlawful and offenders may be prosecuted to the fullest extent of the law.