

Report Number :E2/2021/70039
 Operation Mode :LTE B66
 Test Mode :TX CH HIGH
 EUT Pol :H Plane
 Test Frequency :1772.5 MHz

Test Site :SAC D
 Test Date :2021-08-05
 Temp./Humi. :21.3/65
 Antenna Pol. :Vertical
 Engineer :Jack Tseng

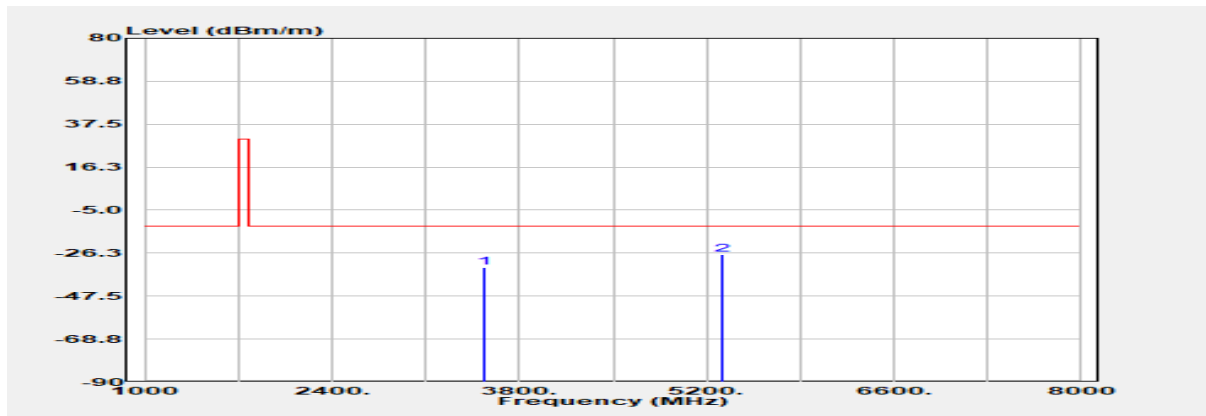

Freq. MHz	EIRP/ERP dBm	SG Output Level dBm	Antenna Gain dBi/dBd	Cable Loss dB	Limit dBm	Margin dB
3545.000	-33.23	-41.91	12.40	-3.72	-13.00	-20.23
5317.500	-27.10	-35.57	13.00	-4.54	-13.00	-14.10

Unless otherwise stated the results shown in this test report refer only to the sample(s) tested and such sample(s) are retained for 90 days only.

除非另有說明，此報告結果僅對測試之樣品負責，同時此樣品僅保留90天。本報告未經本公司書面許可，不可部份複製。

This document is issued by the Company subject to its General Conditions of Service printed overleaf, available on request or accessible at <http://www.sgs.com.tw/Terms-and-Conditions> and for electronic format documents, subject to Terms and Conditions for Electronic Documents at <http://www.sgs.com.tw/Terms-and-Conditions>. Attention is drawn to the limitation of liability, indemnification and jurisdiction issues defined therein. Any holder of this document is advised that information contained hereon reflects the Company's findings at the time of its intervention only and within the limits of Client's instructions, if any. The Company's sole responsibility is to its Client and this document does not exonerate parties to a transaction from exercising all their rights and obligations under the transaction documents. This document cannot be reproduced except in full, without prior written approval of the Company. Any unauthorized alteration, forgery or falsification of the content or appearance of this document is unlawful and offenders may be prosecuted to the fullest extent of the law.

Report Number :E2/2021/70039
 Operation Mode :LTE B66
 Test Mode :TX CH HIGH
 EUT Pol :H Plane
 Test Frequency :1772.5 MHz

Test Site :SAC D
 Test Date :2021-08-05
 Temp./Humi. :21.3/65
 Antenna Pol. :Horizontal
 Engineer :Jack Tseng

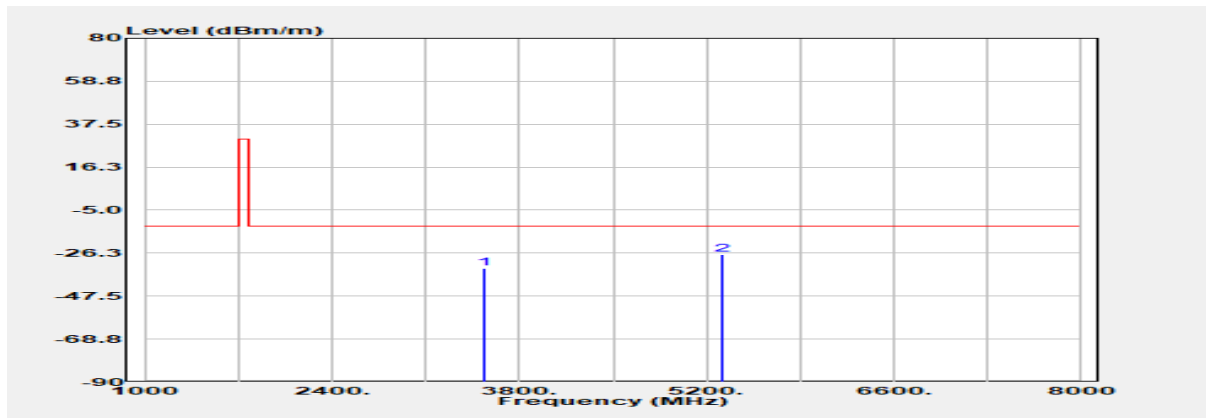

Freq. MHz	EIRP/ERP dBm	SG Output Level dBm	Antenna Gain dBi/dBd	Cable Loss dB	Limit dBm	Margin dB
3545.000	-33.60	-42.28	12.40	-3.72	-13.00	-20.60
5317.500	-27.03	-35.50	13.00	-4.54	-13.00	-14.03

Unless otherwise stated the results shown in this test report refer only to the sample(s) tested and such sample(s) are retained for 90 days only.

除非另有說明，此報告結果僅對測試之樣品負責，同時此樣品僅保留90天。本報告未經本公司書面許可，不可部份複製。

This document is issued by the Company subject to its General Conditions of Service printed overleaf, available on request or accessible at <http://www.sgs.com.tw/Terms-and-Conditions> and for electronic format documents, subject to Terms and Conditions for Electronic Documents at <http://www.sgs.com.tw/Terms-and-Conditions>. Attention is drawn to the limitation of liability, indemnification and jurisdiction issues defined therein. Any holder of this document is advised that information contained hereon reflects the Company's findings at the time of its intervention only and within the limits of Client's instructions, if any. The Company's sole responsibility is to its Client and this document does not exonerate parties to a transaction from exercising all their rights and obligations under the transaction documents. This document cannot be reproduced except in full, without prior written approval of the Company. Any unauthorized alteration, forgery or falsification of the content or appearance of this document is unlawful and offenders may be prosecuted to the fullest extent of the law.

10 FREQUENCY STABILITY MEASUREMENT

10.1 Standard Applicabl

The frequency stability shall be sufficient to ensure that the fundamental emission stays within the authorized frequency block.

10.2 Test Set-up

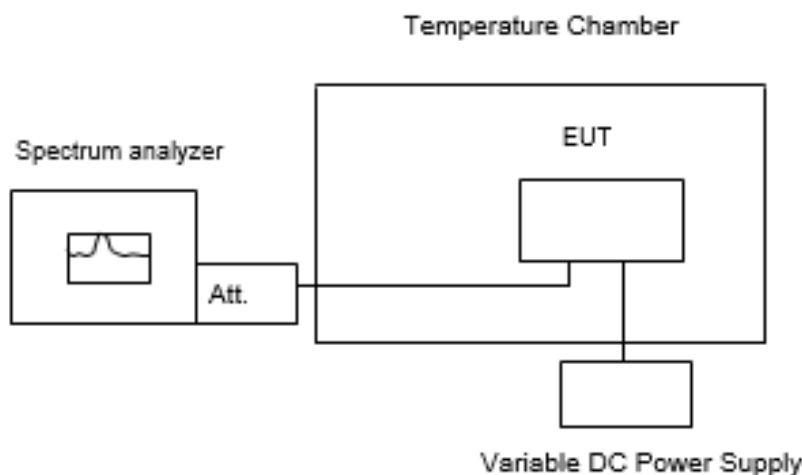

Note: Measurement setup for testing on Antenna connector

10.3 Measurement Procedure

The equipment under test was connected to an external AC or DC power supply and input rated voltage. RF output was connected to a frequency counter or spectrum analyzer via feed through attenuators. The EUT was placed inside the temperature chamber. Set the spectrum analyzer RBW low enough to obtain the desired frequency resolution and measure EUT 25°C operating frequency as reference frequency. Turn EUT off and set the chamber temperature to -30°C. After the temperature stabilized for approximately 30 minutes recorded the frequency. Repeat step measure with 10°C increased per stage until the highest temperature of +50°C reached.

Set chamber temperature to 25°C. Use a variable AC power supply / DC power source to power the EUT and set the voltage to rated voltage. Set the spectrum analyzer RBW low enough to obtain the desired frequency resolution and recorded the frequency.

Reduce the input voltage to specify extreme voltage variation (+/- 15%) and endpoint as declared by the manufacturer, record the maximum frequency change.

Unless otherwise stated the results shown in this test report refer only to the sample(s) tested and such sample(s) are retained for 90 days only.

除非另有說明，此報告結果僅對測試之樣品負責，同時此樣品僅保留90天。本報告未經本公司書面許可，不可部份複製。

This document is issued by the Company subject to its General Conditions of Service printed overleaf, available on request or accessible at <http://www.sgs.com.tw/Terms-and-Conditions> and for electronic format documents, subject to Terms and Conditions for Electronic Documents at <http://www.sgs.com.tw/Terms-and-Conditions>. Attention is drawn to the limitation of liability, indemnification and jurisdiction issues defined therein. Any holder of this document is advised that information contained hereon reflects the Company's findings at the time of its intervention only and within the limits of Client's instructions, if any. The Company's sole responsibility is to its Client and this document does not exonerate parties to a transaction from exercising all their rights and obligations under the transaction documents. This document cannot be reproduced except in full, without prior written approval of the Company. Any unauthorized alteration, forgery or falsification of the content or appearance of this document is unlawful and offenders may be prosecuted to the fullest extent of the law.

10.4 Measurement Equipment Used

Conducted Emission Test Site: Conducted B					
EQUIPMENT TYPE	MFR	MODEL NUMBER	SERIAL NUMBER	LAST CAL.	CAL DUE.
Spectrum Analyzer	KEYSIGHT	N9010A	MY51440113	07/13/2021	07/12/2022
Radio Communication Analyzer	Anritsu	MT8820C	6201107337	07/28/2021	07/27/2022
Attenuator	Marvelous	MVE2213-10	RF05	11/19/2020	11/18/2021
DC Block	PASTER-NACK	PE8210	RF157	11/19/2020	11/18/2021
Splitter	Woken	DOM35LW1A2	RF255	11/19/2020	11/18/2021
Coaxial Cables	Woken	00100A1F1A185C	RF54	11/19/2020	11/18/2021
Coaxial Cables	Woken	00100A1F1A185C	RF55	11/19/2020	11/18/2021
Coaxial Cables	Woken	00100A1F1A185C	RF71	11/19/2020	11/18/2021
Coaxial Cables	Woken	00100A1F1A185C	RF72	11/19/2020	11/18/2021
DC Power Supply	Agilent	E3640A	MY53140006	05/28/2021	05/27/2022
Temperature Chamber	TERCHY	MHK-120LK	1020582	07/01/2021	06/30/2022
Test Software	SGS	Radio Test Software	Ver.21	N.C.R	N.C.R

Unless otherwise stated the results shown in this test report refer only to the sample(s) tested and such sample(s) are retained for 90 days only.

除非另有說明，此報告結果僅對測試之樣品負責，同時此樣品僅保留90天。本報告未經本公司書面許可，不可部份複製。

This document is issued by the Company subject to its General Conditions of Service printed overleaf, available on request or accessible at <http://www.sgs.com.tw/Terms-and-Conditions> and for electronic format documents, subject to Terms and Conditions for Electronic Documents at <http://www.sgs.com.tw/Terms-and-Conditions>. Attention is drawn to the limitation of liability, indemnification and jurisdiction issues defined therein. Any holder of this document is advised that information contained hereon reflects the Company's findings at the time of its intervention only and within the limits of Client's instructions, if any. The Company's sole responsibility is to its Client and this document does not exonerate parties to a transaction from exercising all their rights and obligations under the transaction documents. This document cannot be reproduced except in full, without prior written approval of the Company. Any unauthorized alteration, forgery or falsification of the content or appearance of this document is unlawful and offenders may be prosecuted to the fullest extent of the law.

10.5 Measurement Result

Note: The battery is rated 24 Vdc.

Reference Freq.:		LTE B2 Mid Channel		1880	MHz 10M QPSK CH 18900
Power Supply Vdc	Temp. (°C)	Freq. (MHz)	Delta (Hz)	Limit = +/- 2.5 ppm (Hz)	
Freq. ERROR vs. VOLTAGE					
27.6	25	1880.000007	7	4700	
24	25	1879.999997	-3	4700	
20.4	25	1880.000008	8	4700	
19.1 (End Point)	25	1879.999996	-4	4700	
Freq. ERROR vs. Temp.					
24	-30	1879.999997	-3	4700	
24	-20	1880.000008	8	4700	
24	-10	1880.000007	7	4700	
24	0	1879.999998	-2	4700	
24	10	1880.000005	5	4700	
24	20	1880.000001	1	4700	
24	30	1880.000001	1	4700	
24	40	1880.000007	7	4700	
24	50	1880.000002	2	4700	

Reference Freq.:		LTE B4 Mid Channel		1732.5	MHz 10M QPSK CH 20175
Power Supply Vdc	Temp. (°C)	Freq. (MHz)	Delta (Hz)	Limit = +/- 2.5 ppm (Hz)	
Freq. ERROR vs. VOLTAGE					
27.6	25	1732.499995	-5	4331	
24	25	1732.500001	1	4331	
20.4	25	1732.499996	-4	4331	
19.1 (End Point)	25	1732.500007	7	4331	
Freq. ERROR vs. Temp.					
24	-30	1732.500000	0	4331	
24	-20	1732.499999	-1	4331	
24	-10	1732.500009	9	4331	
24	0	1732.500002	2	4331	
24	10	1732.500009	9	4331	
24	20	1732.500000	0	4331	
24	30	1732.499998	-2	4331	
24	40	1732.499996	-4	4331	
24	50	1732.500009	9	4331	

Unless otherwise stated the results shown in this test report refer only to the sample(s) tested and such sample(s) are retained for 90 days only.

除非另有說明，此報告結果僅對測試之樣品負責，同時此樣品僅保留90天。本報告未經本公司書面許可，不可部份複製。

This document is issued by the Company subject to its General Conditions of Service printed overleaf, available on request or accessible at <http://www.sgs.com.tw/Terms-and-Conditions> and for electronic format documents, subject to Terms and Conditions for Electronic Documents at <http://www.sgs.com.tw/Terms-and-Conditions>. Attention is drawn to the limitation of liability, indemnification and jurisdiction issues defined therein. Any holder of this document is advised that information contained hereon reflects the Company's findings at the time of its intervention only and within the limits of Client's instructions, if any. The Company's sole responsibility is to its Client and this document does not exonerate parties to a transaction from exercising all their rights and obligations under the transaction documents. This document cannot be reproduced except in full, without prior written approval of the Company. Any unauthorized alteration, forgery or falsification of the content or appearance of this document is unlawful and offenders may be prosecuted to the fullest extent of the law.

Reference Freq.:		LTE B12 Mid Channel		707.5	MHz 10M QPSK CH 23095
Power Supply Vdc	Temp. (°C)	Freq. (MHz)	Delta (Hz)	Limit = +/- 2.5 ppm (Hz)	
Freq. ERROR vs. VOLTAGE					
27.6	25	707.500005	5	1769	
24	25	707.500004	4	1769	
20.4	25	707.500004	4	1769	
19.1 (End Point)	25	707.500005	5	1769	
Freq. ERROR vs. Temp.					
24	-30	707.500000	0	1769	
24	-20	707.499998	-2	1769	
24	-10	707.500000	0	1769	
24	0	707.499998	-2	1769	
24	10	707.499996	-4	1769	
24	20	707.500008	8	1769	
24	30	707.499995	-5	1769	
24	40	707.499995	-5	1769	
24	50	707.499995	-5	1769	

Reference Freq.:		LTE B17 Mid Channel		710	MHz 10M QPSK CH 23790
Power Supply Vdc	Temp. (°C)	Freq. (MHz)	Delta (Hz)	Limit = +/- 2.5 ppm (Hz)	
Freq. ERROR vs. VOLTAGE					
27.6	25	710.000000	0	1775	
24	25	709.999996	-4	1775	
20.4	25	710.000006	6	1775	
19.1 (End Point)	25	710.000003	3	1775	
Freq. ERROR vs. Temp.					
24	-30	709.999998	-2	1775	
24	-20	710.000006	6	1775	
24	-10	710.000008	8	1775	
24	0	710.000009	9	1775	
24	10	709.999995	-5	1775	
24	20	709.999999	-1	1775	
24	30	710.000005	5	1775	
24	40	710.000004	4	1775	
24	50	710.000004	4	1775	

Unless otherwise stated the results shown in this test report refer only to the sample(s) tested and such sample(s) are retained for 90 days only.

除非另有說明，此報告結果僅對測試之樣品負責，同時此樣品僅保留90天。本報告未經本公司書面許可，不可部份複製。

This document is issued by the Company subject to its General Conditions of Service printed overleaf, available on request or accessible at <http://www.sgs.com.tw/Terms-and-Conditions> and for electronic format documents, subject to Terms and Conditions for Electronic Documents at <http://www.sgs.com.tw/Terms-and-Conditions>. Attention is drawn to the limitation of liability, indemnification and jurisdiction issues defined therein. Any holder of this document is advised that information contained hereon reflects the Company's findings at the time of its intervention only and within the limits of Client's instructions, if any. The Company's sole responsibility is to its Client and this document does not exonerate parties to a transaction from exercising all their rights and obligations under the transaction documents. This document cannot be reproduced except in full, without prior written approval of the Company. Any unauthorized alteration, forgery or falsification of the content or appearance of this document is unlawful and offenders may be prosecuted to the fullest extent of the law.

Reference Freq.:		LTE B66 Mid Channel		1745	MHz 10M QPSK CH 132322
Power Supply Vdc	Temp. (°C)	Freq. (MHz)	Delta (Hz)	Limit = +/- 2.5 ppm (Hz)	
Freq. ERROR vs. VOLTAGE					
27.6	25	1745.000006	6	4363	
24	25	1744.999996	-4	4363	
20.4	25	1745.000006	6	4363	
19.1 (End Point)	25	1745.000004	4	4363	
Freq. ERROR vs. Temp.					
24	-30	1744.999998	-2	4363	
24	-20	1744.999998	-2	4363	
24	-10	1745.000007	7	4363	
24	0	1745.000003	3	4363	
24	10	1745.000003	3	4363	
24	20	1744.999995	-5	4363	
24	30	1745.000008	8	4363	
24	40	1745.000005	5	4363	
24	50	1744.999996	-4	4363	

Unless otherwise stated the results shown in this test report refer only to the sample(s) tested and such sample(s) are retained for 90 days only.

除非另有說明，此報告結果僅對測試之樣品負責，同時此樣品僅保留90天。本報告未經本公司書面許可，不可部份複製。

This document is issued by the Company subject to its General Conditions of Service printed overleaf, available on request or accessible at <http://www.sgs.com.tw/Terms-and-Conditions> and for electronic format documents, subject to Terms and Conditions for Electronic Documents at <http://www.sgs.com.tw/Terms-and-Conditions>. Attention is drawn to the limitation of liability, indemnification and jurisdiction issues defined therein. Any holder of this document is advised that information contained hereon reflects the Company's findings at the time of its intervention only and within the limits of Client's instructions, if any. The Company's sole responsibility is to its Client and this document does not exonerate parties to a transaction from exercising all their rights and obligations under the transaction documents. This document cannot be reproduced except in full, without prior written approval of the Company. Any unauthorized alteration, forgery or falsification of the content or appearance of this document is unlawful and offenders may be prosecuted to the fullest extent of the law.

11 PEAK TO AVERAGE RATIO

11.1 Standard Applicable

The peak-to-average ratio (PAR) of the transmission may not exceed 13dB.

11.2 Test SET-UP

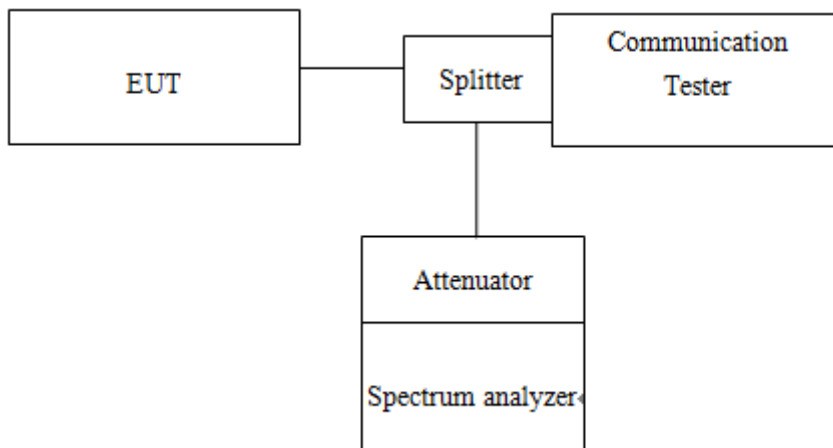

11.3 Measurement Procedure

1. KDB 971168 D01 is employed as the following procedure is proper adjusted accordingly:
2. Set resolution/measurement bandwidth \geq signal's occupied bandwidth; & internal =1ms
3. Set the number of counts to a value that stabilizes the measured CCDF curve.

Unless otherwise stated the results shown in this test report refer only to the sample(s) tested and such sample(s) are retained for 90 days only.

除非另有說明，此報告結果僅對測試之樣品負責，同時此樣品僅保留90天。本報告未經本公司書面許可，不可部份複製。

This document is issued by the Company subject to its General Conditions of Service printed overleaf, available on request or accessible at <http://www.sgs.com.tw/Terms-and-Conditions> and for electronic format documents, subject to Terms and Conditions for Electronic Documents at <http://www.sgs.com.tw/Terms-and-Conditions>. Attention is drawn to the limitation of liability, indemnification and jurisdiction issues defined therein. Any holder of this document is advised that information contained hereon reflects the Company's findings at the time of its intervention only and within the limits of Client's instructions, if any. The Company's sole responsibility is to its Client and this document does not exonerate parties to a transaction from exercising all their rights and obligations under the transaction documents. This document cannot be reproduced except in full, without prior written approval of the Company. Any unauthorized alteration, forgery or falsification of the content or appearance of this document is unlawful and offenders may be prosecuted to the fullest extent of the law.

11.4 Measurement Equipment Used

Conducted Emission Test Site: Conducted B					
EQUIPMENT TYPE	MFR	MODEL NUMBER	SERIAL NUMBER	LAST CAL.	CAL DUE.
Spectrum Analyzer	KEYSIGHT	N9010A	MY51440113	07/13/2021	07/12/2022
Radio Communication Analyser	Anritsu	MT8820C	6201107337	07/28/2021	07/27/2022
Attenuator	Marvelous	MVE2213-10	RF05	11/19/2020	11/18/2021
DC Block	PASTER-NACK	PE8210	RF157	11/19/2020	11/18/2021
Splitter	Woken	DOM35LW1A2	RF255	11/19/2020	11/18/2021
Coaxial Cables	Woken	00100A1F1A185C	RF54	11/19/2020	11/18/2021
Coaxial Cables	Woken	00100A1F1A185C	RF55	11/19/2020	11/18/2021
Coaxial Cables	Woken	00100A1F1A185C	RF71	11/19/2020	11/18/2021
Coaxial Cables	Woken	00100A1F1A185C	RF72	11/19/2020	11/18/2021
DC Power Supply	Agilent	E3640A	MY53140006	05/28/2021	05/27/2022
Temperature Chamber	TERCHY	MHK-120LK	1020582	07/01/2021	06/30/2022
Test Software	SGS	Radio Test Software	Ver.21	N.C.R	N.C.R

Unless otherwise stated the results shown in this test report refer only to the sample(s) tested and such sample(s) are retained for 90 days only.

除非另有說明，此報告結果僅對測試之樣品負責，同時此樣品僅保留90天。本報告未經本公司書面許可，不可部份複製。

This document is issued by the Company subject to its General Conditions of Service printed overleaf, available on request or accessible at <http://www.sgs.com.tw/Terms-and-Conditions> and for electronic format documents, subject to Terms and Conditions for Electronic Documents at <http://www.sgs.com.tw/Terms-and-Conditions>. Attention is drawn to the limitation of liability, indemnification and jurisdiction issues defined therein. Any holder of this document is advised that information contained hereon reflects the Company's findings at the time of its intervention only and within the limits of Client's instructions, if any. The Company's sole responsibility is to its Client and this document does not exonerate parties to a transaction from exercising all their rights and obligations under the transaction documents. This document cannot be reproduced except in full, without prior written approval of the Company. Any unauthorized alteration, forgery or falsification of the content or appearance of this document is unlawful and offenders may be prosecuted to the fullest extent of the law.

11.5 Measurement Result

LTE BAND 2							
Channel bandwidth: 1.4MHz				Channel bandwidth: 3MHz			
Freq. (MHz)	CH	PAPR (dB)		Freq. (MHz)	CH	PAPR (dB)	
		16QAM	Limit			16QAM	Limit
1850.7	18607	5.08	13	1851.5	18615	5.37	13
1880.0	18900	5.18	13	1880.0	18900	5.33	13
1909.3	19193	5.20	13	1908.5	19185	5.38	13

LTE BAND 2							
Channel bandwidth: 5MHz				Channel bandwidth: 10MHz			
Freq. (MHz)	CH	PAPR (dB)		Freq. (MHz)	CH	PAPR (dB)	
		16QAM	Limit			16QAM	Limit
1852.5	18625	5.29	13	1855.0	18650	4.39	13
1880.0	18900	5.56	13	1880.0	18900	4.53	13
1907.5	19175	5.20	13	1905.0	19150	4.14	13

LTE BAND 2							
Channel bandwidth: 15MHz				Channel bandwidth: 20MHz			
Freq. (MHz)	CH	PAPR (dB)		Freq. (MHz)	CH	PAPR (dB)	
		16QAM	Limit			16QAM	Limit
1857.5	18675	4.31	13	1860.0	18700	4.42	13
1880.0	18900	4.50	13	1880.0	18900	4.48	13
1902.5	19125	3.86	13	1900.0	19100	4.25	13

LTE BAND 4							
Channel bandwidth: 1.4MHz				Channel bandwidth: 3MHz			
Freq. (MHz)	CH	PAPR (dB)		Freq. (MHz)	CH	PAPR (dB)	
		16QAM	Limit			16QAM	Limit
1710.7	19957	5.49	13	1711.5	19965	5.51	13
1732.5	20175	5.36	13	1732.5	20175	5.32	13
1754.3	20393	5.37	13	1753.5	20385	5.55	13

LTE BAND 4							
Channel bandwidth: 5MHz				Channel bandwidth: 10MHz			
Freq. (MHz)	CH	PAPR (dB)		Freq. (MHz)	CH	PAPR (dB)	
		16QAM	Limit			16QAM	Limit
1712.5	19957	5.34	13	1715.0	20000	4.61	13
1732.5	20175	5.24	13	1732.5	20175	4.44	13
1752.5	20375	5.37	13	1750.0	20350	4.71	13

LTE BAND 4							
Channel bandwidth: 15MHz				Channel bandwidth: 20MHz			
Freq. (MHz)	CH	PAPR (dB)		Freq. (MHz)	CH	PAPR (dB)	
		16QAM	Limit			16QAM	Limit
1717.5	20025	4.58	13	1720.0	20050	4.57	13
1732.5	20175	4.13	13	1732.5	20175	4.72	13
1747.5	20325	4.39	13	1745.0	20300	4.29	13

LTE BAND 12							
Channel bandwidth: 1.4MHz				Channel bandwidth: 3MHz			
Freq. (MHz)	CH	PAPR (dB)		Freq. (MHz)	CH	PAPR (dB)	
		16QAM	Limit			16QAM	Limit
699.7	23017	5.92	13	700.5	23025	6.04	13
707.5	23095	6.05	13	707.5	23095	6.21	13
715.3	23173	6.20	13	714.5	23165	6.19	13

LTE BAND 12							
Channel bandwidth: 5MHz				Channel bandwidth: 10MHz			
Freq. (MHz)	CH	PAPR (dB)		Freq. (MHz)	CH	PAPR (dB)	
		16QAM	Limit			16QAM	Limit
701.5	23035	5.96	13	704.0	23060	5.81	13
707.5	23095	6.02	13	707.5	23095	5.67	13
713.5	23155	5.98	13	711.0	23130	5.78	13

LTE BAND 17							
Channel bandwidth: 5MHz				Channel bandwidth: 10MHz			
Freq. (MHz)	CH	PAPR (dB)		Freq. (MHz)	CH	PAPR (dB)	
		16QAM	Limit			16QAM	Limit
706.5	23755	6.04	13	709.0	23780	5.74	13
710.0	23790	6.11	13	710.0	23790	5.82	13
713.5	23825	6.13	13	711.0	23800	5.74	13

LTE BAND 66							
Channel bandwidth: 1.4MHz				Channel bandwidth: 3MHz			
Freq. (MHz)	CH	PAPR (dB)		Freq. (MHz)	CH	PAPR (dB)	
		16QAM	Limit			16QAM	Limit
1710.7	131979	6.57	13	1711.5	131987	6.47	13
1745.0	132322	6.38	13	1745.0	132322	6.28	13
1779.3	132665	6.16	13	1778.5	132657	6.08	13

LTE BAND 66							
Channel bandwidth: 5MHz				Channel bandwidth: 10MHz			
Freq. (MHz)	CH	PAPR (dB)		Freq. (MHz)	CH	PAPR (dB)	
		16QAM	Limit			16QAM	Limit
1712.5	131997	6.57	13	1715.0	132022	6.20	13
1745.0	132322	6.04	13	1745.0	132322	5.95	13
1777.5	132647	6.05	13	1775.0	132622	5.79	13

LTE BAND 66							
Channel bandwidth: 15MHz				Channel bandwidth: 20MHz			
Freq. (MHz)	CH	PAPR (dB)		Freq. (MHz)	CH	PAPR (dB)	
		16QAM	Limit			16QAM	Limit
1717.5	132047	6.07	13	1720.0	132072	5.85	13
1745.0	132322	5.19	13	1745.0	132322	4.97	13
1772.5	132597	5.77	13	1770.0	132572	6.02	13

Unless otherwise stated the results shown in this test report refer only to the sample(s) tested and such sample(s) are retained for 90 days only.

除非另有說明，此報告結果僅對測試之樣品負責，同時此樣品僅保留90天。本報告未經本公司書面許可，不可部份複製。

This document is issued by the subject to its General Conditions of Service printed overleaf, available on request or accessible at <http://www.sgs.com.tw/Terms-and-Conditions> and for electronic format documents, subject to Terms and Conditions for Electronic Documents at <http://www.sgs.com.tw/Terms-and-Conditions>. Attention is drawn to the limitation of liability, indemnification and jurisdiction issues defined therein. Any holder of this document is advised that information contained herein reflects the Company's findings at the time of its intervention only and within the limits of Client's instructions, if any. The Company's sole responsibility is to its Client and this document does not exonerate parties to a transaction from exercising all their rights and obligations under the transaction documents. This document cannot be reproduced except in full, without prior written approval of the Company. Any unauthorized alteration, forgery or falsification of the content or appearance of this document is unlawful and offenders may be prosecuted to the fullest extent of the law.

Band2_1.4MHz_16QAM_RB6_0_CH18607

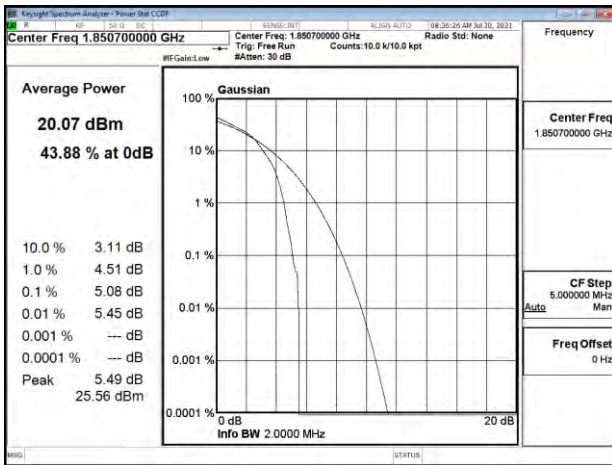

Band2_3MHz_16QAM_RB15_0_CH18615

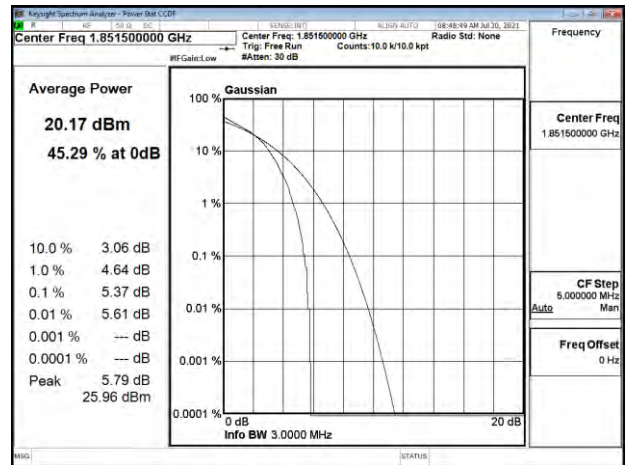

Band2_1.4MHz_16QAM_RB6_0_CH18900

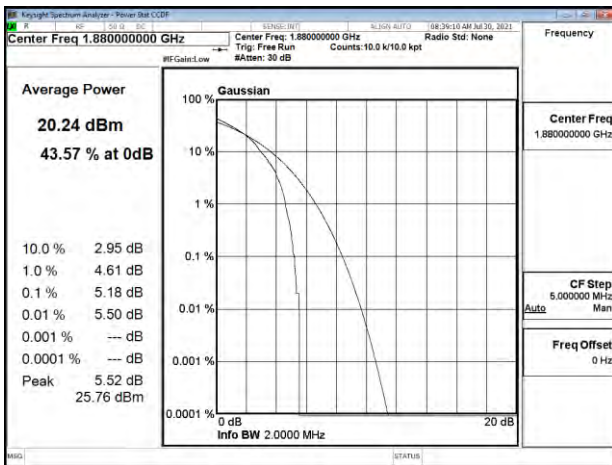

Band2_3MHz_16QAM_RB15_0_CH18900

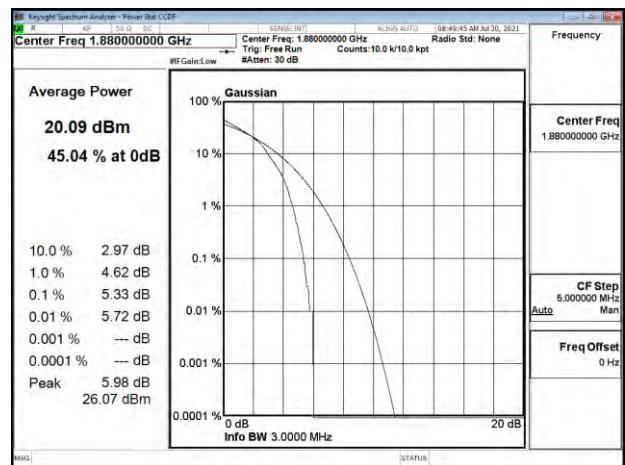

Band2_1.4MHz_16QAM_RB6_0_CH19193

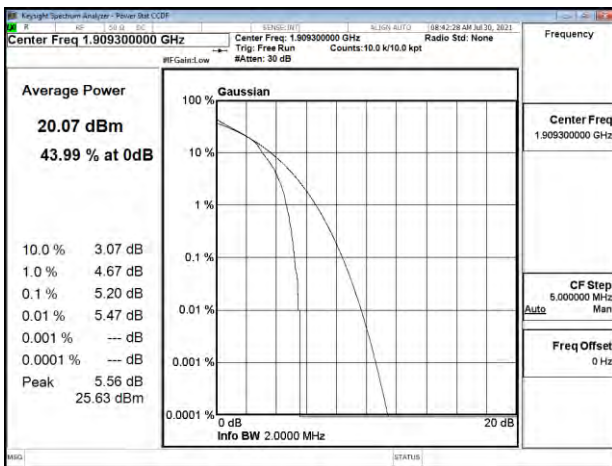

Band2_3MHz_16QAM_RB15_0_CH19185

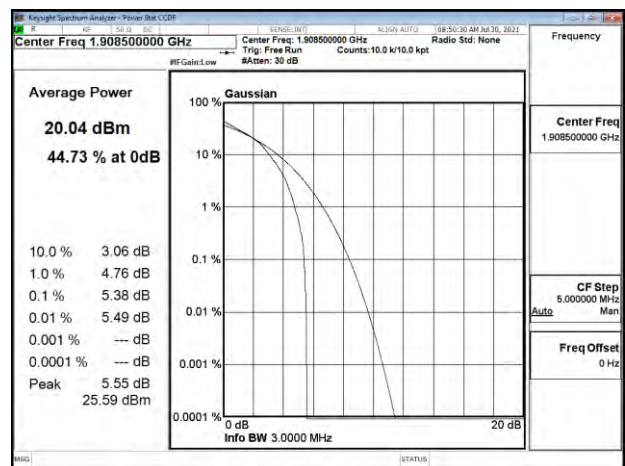

Unless otherwise stated the results shown in this test report refer only to the sample(s) tested and such sample(s) are retained for 90 days only.

除非另有說明，此報告結果僅對測試之樣品負責，同時此樣品僅保留90天。本報告未經本公司書面許可，不可部份複製。

This document is issued by the Company subject to its General Conditions of Service printed overleaf, available on request or accessible at <http://www.sgs.com.tw/Terms-and-Conditions> and for electronic format documents, subject to Terms and Conditions for Electronic Documents at <http://www.sgs.com.tw/Terms-and-Conditions>. Attention is drawn to the limitation of liability, indemnification and jurisdiction issues defined therein. Any holder of this document is advised that information contained herein reflects the Company's findings at the time of its intervention only and within the limits of Client's instructions, if any. The Company's sole responsibility is to its Client and this document does not exonerate parties to a transaction from exercising all their rights and obligations under the transaction documents. This document cannot be reproduced except in full, without prior written approval of the Company. Any unauthorized alteration, forgery or falsification of the content or appearance of this document is unlawful and offenders may be prosecuted to the fullest extent of the law.

Band2_5MHz_16QAM_RB25_0_CH18625

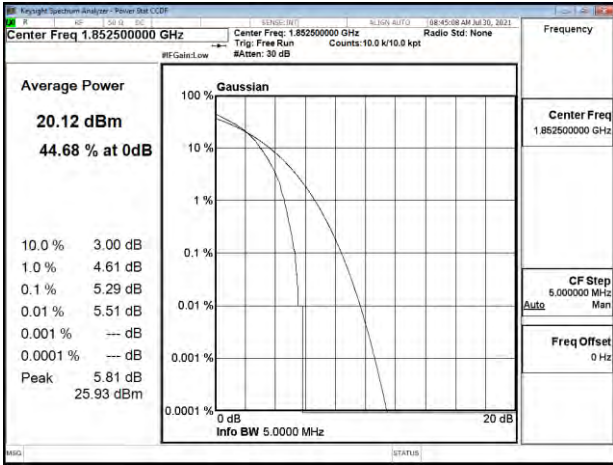

Band2_10MHz_16QAM_RB16_0_CH18650

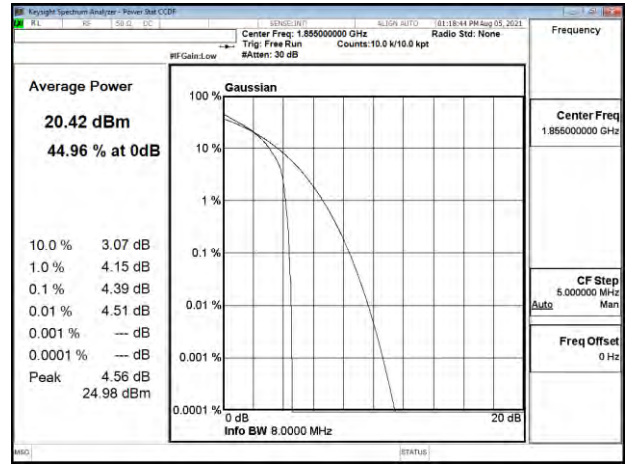

Band2_5MHz_16QAM_RB25_0_CH18900

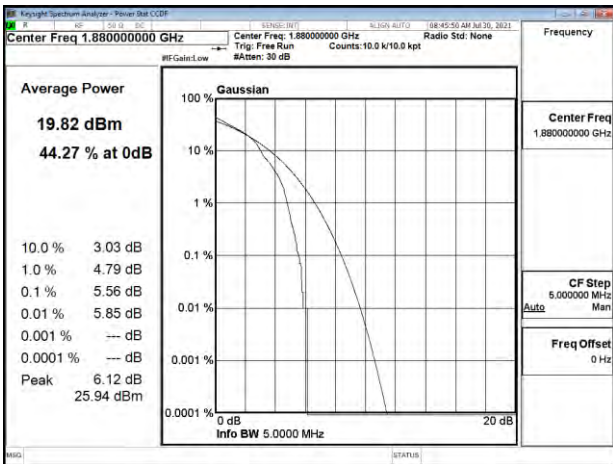

Band2_10MHz_16QAM_RB16_0_CH18900

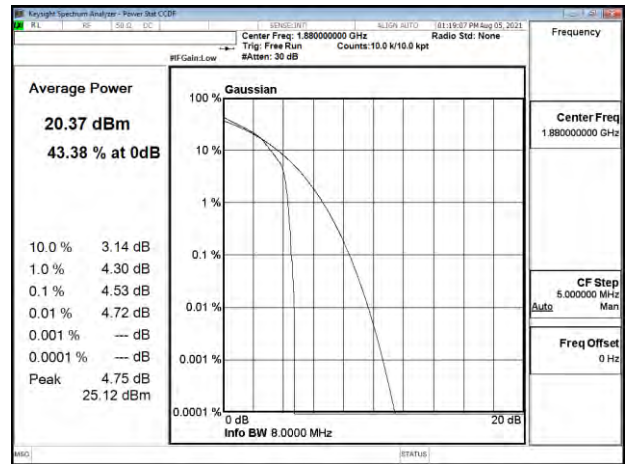

Band2_5MHz_16QAM_RB25_0_CH19175

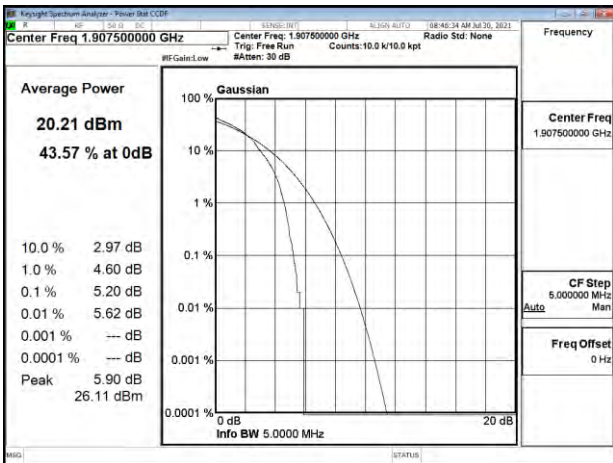

Band2_10MHz_16QAM_RB16_0_CH19150

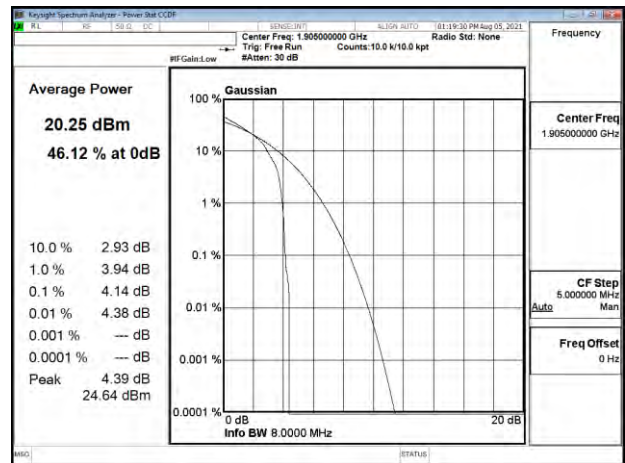

Unless otherwise stated the results shown in this test report refer only to the sample(s) tested and such sample(s) are retained for 90 days only.

除非另有說明，此報告結果僅對測試之樣品負責，同時此樣品僅保留90天。本報告未經本公司書面許可，不可部份複製。

This document is issued by the Company subject to its General Conditions of Service printed overleaf, available on request or accessible at <http://www.sgs.com.tw/Terms-and-Conditions> and for electronic format documents, subject to Terms and Conditions for Electronic Documents at <http://www.sgs.com.tw/Terms-and-Conditions>. Attention is drawn to the limitation of liability, indemnification and jurisdiction issues defined therein. Any holder of this document is advised that information contained hereon reflects the Company's findings at the time of its intervention only and within the limits of Client's instructions, if any. The Company's sole responsibility is to its Client and this document does not exonerate parties to a transaction from exercising all their rights and obligations under the transaction documents. This document cannot be reproduced except in full, without prior written approval of the Company. Any unauthorized alteration, forgery or falsification of the content or appearance of this document is unlawful and offenders may be prosecuted to the fullest extent of the law.

Band2_15MHz_16QAM_RB16_0_CH18675

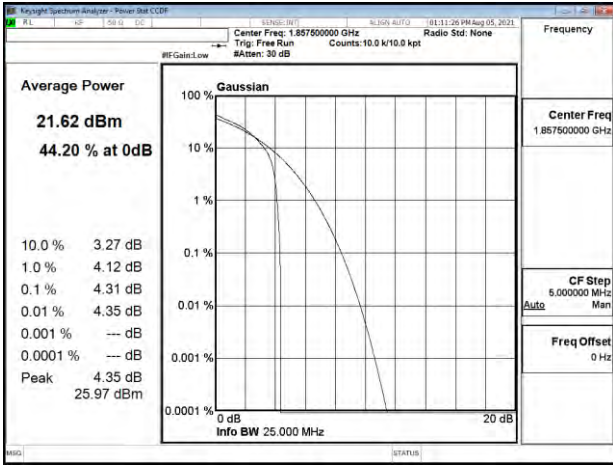

Band2_20MHz_16QAM_RB18_0_CH18700

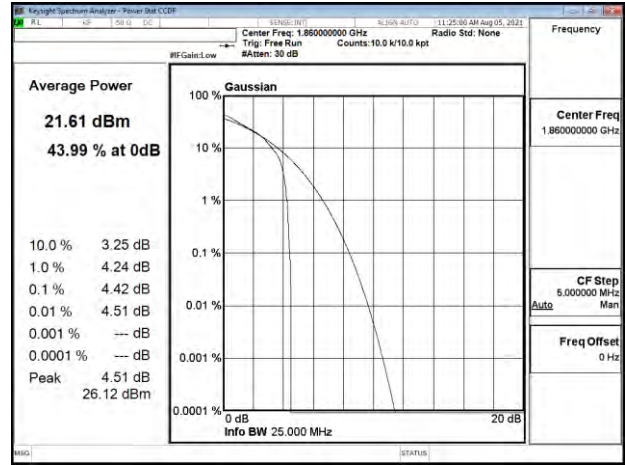

Band2_15MHz_16QAM_RB16_0_CH18900

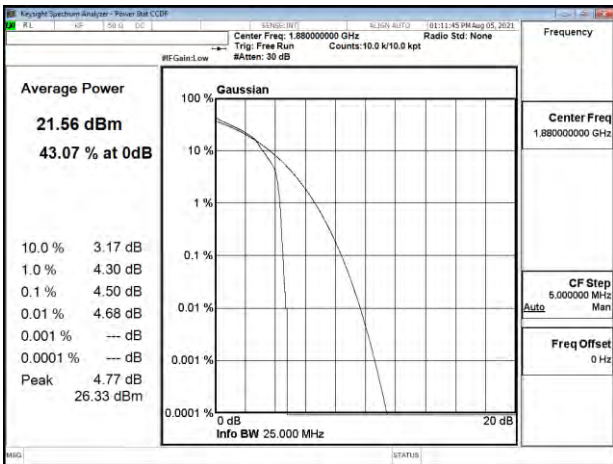

Band2_20MHz_16QAM_RB18_0_CH18900

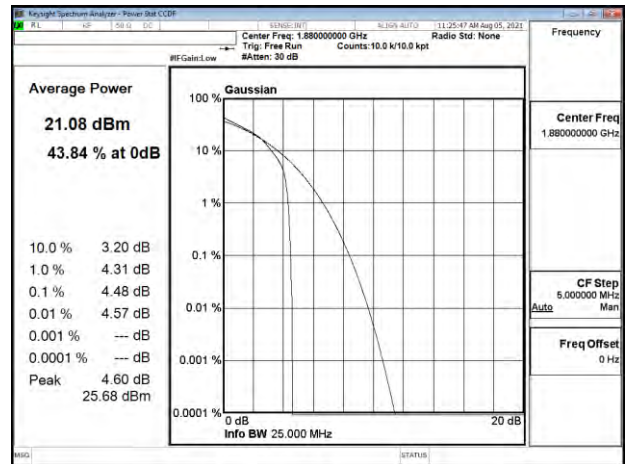

Band2_15MHz_16QAM_RB16_0_CH19125

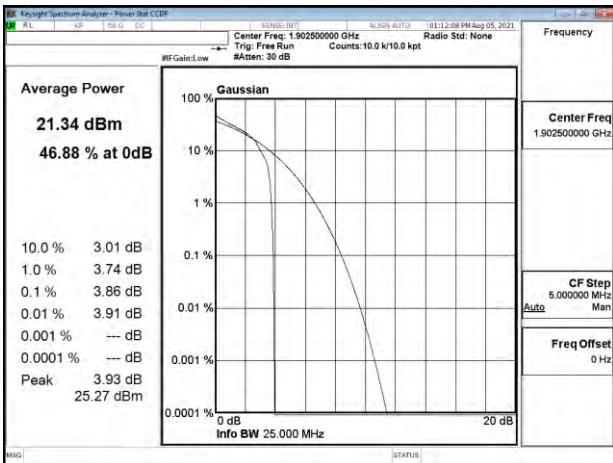

Band2_20MHz_16QAM_RB18_0_CH19100

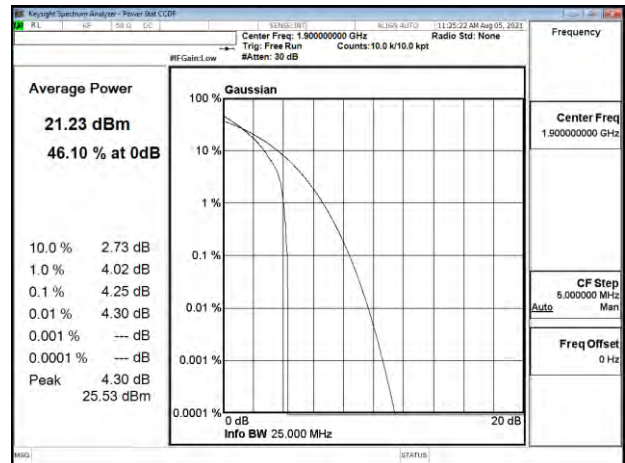

Unless otherwise stated the results shown in this test report refer only to the sample(s) tested and such sample(s) are retained for 90 days only.

除非另有說明，此報告結果僅對測試之樣品負責，同時此樣品僅保留90天。本報告未經本公司書面許可，不可部份複製。

This document is issued by the Company subject to its General Conditions of Service printed overleaf, available on request or accessible at <http://www.sgs.com.tw/Terms-and-Conditions> and for electronic format documents, subject to Terms and Conditions for Electronic Documents at <http://www.sgs.com.tw/Terms-and-Conditions>. Attention is drawn to the limitation of liability, indemnification and jurisdiction issues defined therein. Any holder of this document is advised that information contained herein reflects the Company's findings at the time of its intervention only and within the limits of Client's instructions, if any. The Company's sole responsibility is to its Client and this document does not exonerate parties to a transaction from exercising all their rights and obligations under the transaction documents. This document cannot be reproduced except in full, without prior written approval of the Company. Any unauthorized alteration, forgery or falsification of the content or appearance of this document is unlawful and offenders may be prosecuted to the fullest extent of the law.

Band4_1.4MHz_16QAM_RB6_0_CH19957

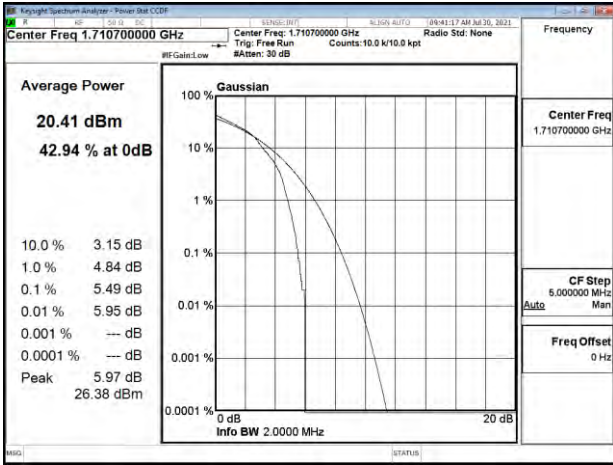

Band4_3MHz_16QAM_RB15_0_CH19965

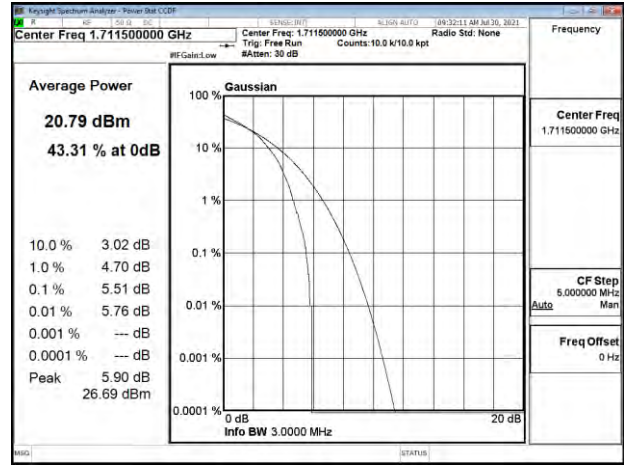

Band4_1.4MHz_16QAM_RB6_0_CH20175

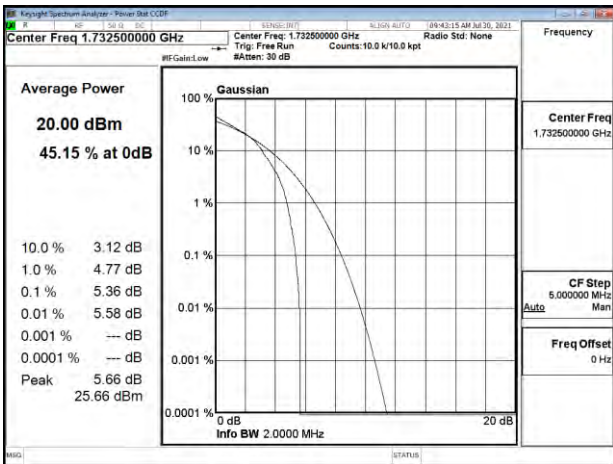

Band4_3MHz_16QAM_RB15_0_CH20175

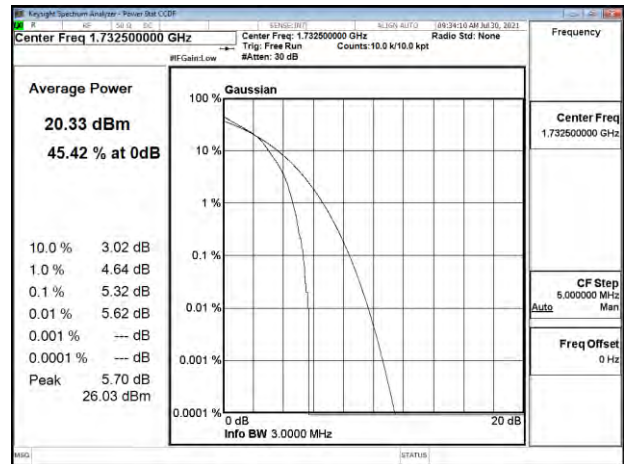

Band4_1.4MHz_16QAM_RB6_0_CH20393

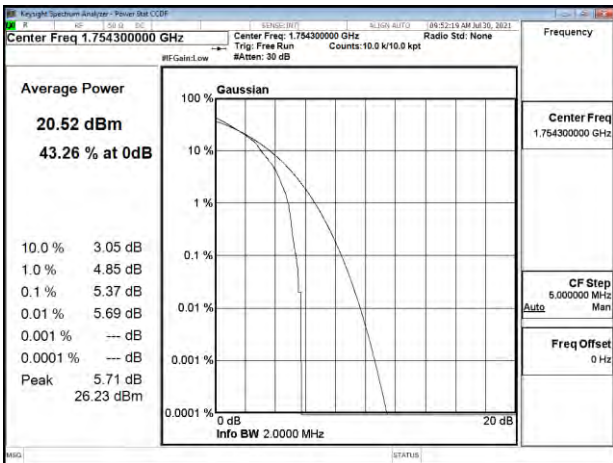

Band4_3MHz_16QAM_RB15_0_CH20385

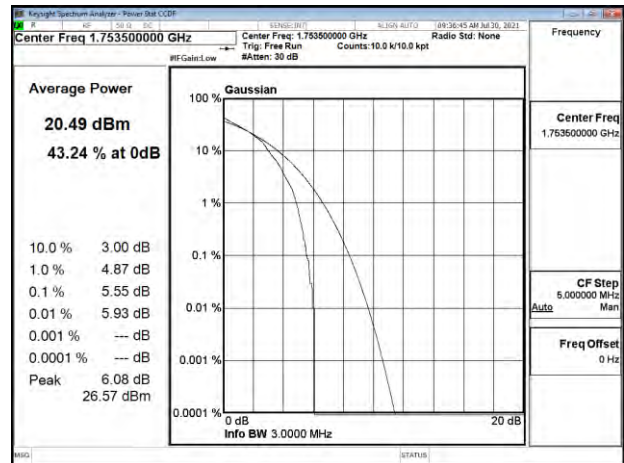

Unless otherwise stated the results shown in this test report refer only to the sample(s) tested and such sample(s) are retained for 90 days only.

除非另有說明，此報告結果僅對測試之樣品負責，同時此樣品僅保留90天。本報告未經本公司書面許可，不可部份複製。

This document is issued by the Company subject to its General Conditions of Service printed overleaf, available on request or accessible at <http://www.sgs.com.tw/Terms-and-Conditions> and for electronic format documents, subject to Terms and Conditions for Electronic Documents at <http://www.sgs.com.tw/Terms-and-Conditions>. Attention is drawn to the limitation of liability, indemnification and jurisdiction issues defined therein. Any holder of this document is advised that information contained herein reflects the Company's findings at the time of its intervention only and within the limits of Client's instructions, if any. The Company's sole responsibility is to its Client and this document does not exonerate parties to a transaction from exercising all their rights and obligations under the transaction documents. This document cannot be reproduced except in full, without prior written approval of the Company. Any unauthorized alteration, forgery or falsification of the content or appearance of this document is unlawful and offenders may be prosecuted to the fullest extent of the law.

Band4_5MHz_16QAM_RB25_0_CH19975

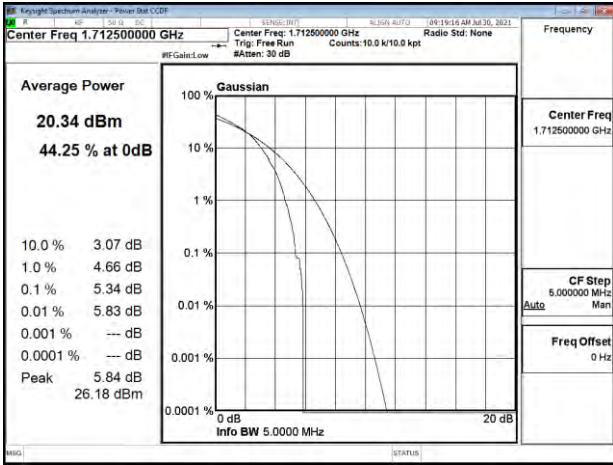

Band4_10MHz_16QAM_RB16_0_CH20000

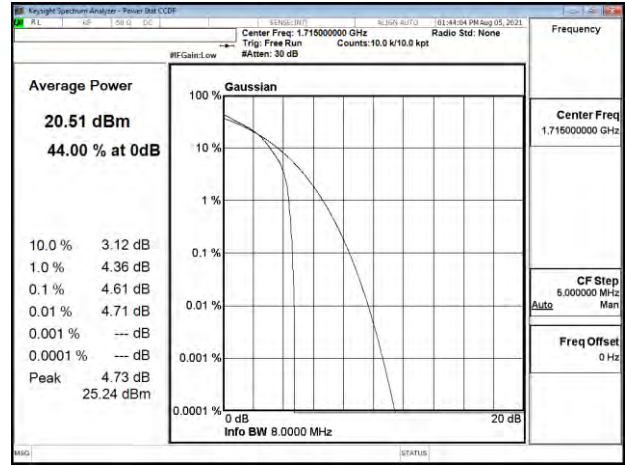

Band4_5MHz_16QAM_RB25_0_CH20175

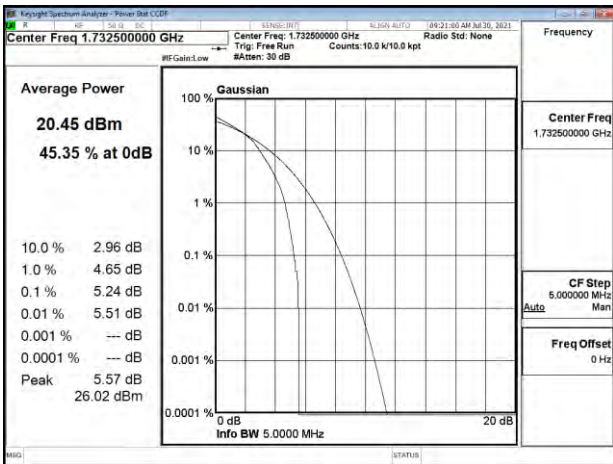

Band4_10MHz_16QAM_RB16_0_CH20175

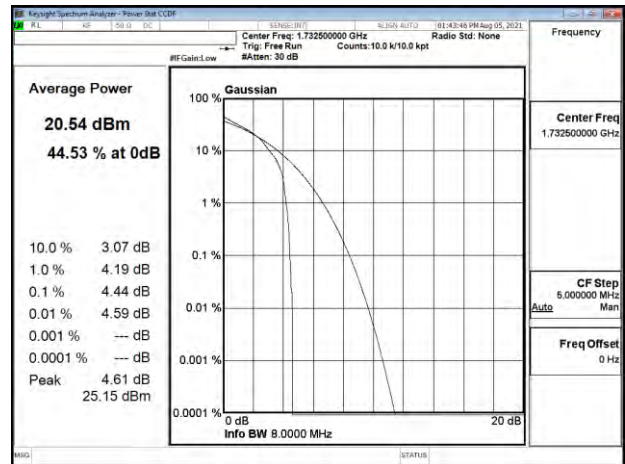

Band4_5MHz_16QAM_RB25_0_CH20375

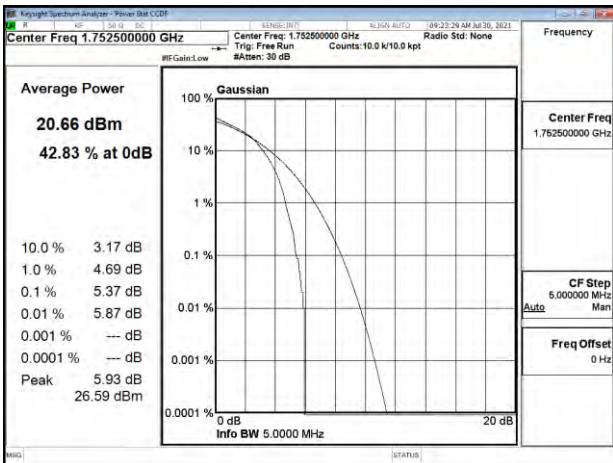

Band4_10MHz_16QAM_RB16_0_CH20350

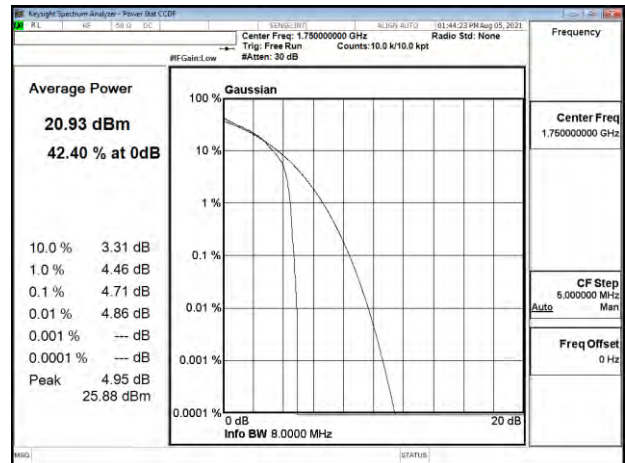

Unless otherwise stated the results shown in this test report refer only to the sample(s) tested and such sample(s) are retained for 90 days only.

除非另有說明，此報告結果僅對測試之樣品負責，同時此樣品僅保留90天。本報告未經本公司書面許可，不可部份複製。

This document is issued by the Company subject to its General Conditions of Service printed overleaf, available on request or accessible at <http://www.sgs.com.tw/Terms-and-Conditions> and for electronic format documents, subject to Terms and Conditions for Electronic Documents at <http://www.sgs.com.tw/Terms-and-Conditions>. Attention is drawn to the limitation of liability, indemnification and jurisdiction issues defined therein. Any holder of this document is advised that information contained herein reflects the Company's findings at the time of its intervention only and within the limits of Client's instructions, if any. The Company's sole responsibility is to its Client and this document does not exonerate parties to a transaction from exercising all their rights and obligations under the transaction documents. This document cannot be reproduced except in full, without prior written approval of the Company. Any unauthorized alteration, forgery or falsification of the content or appearance of this document is unlawful and offenders may be prosecuted to the fullest extent of the law.

Band4_15MHz_16QAM_RB16_0_CH20025

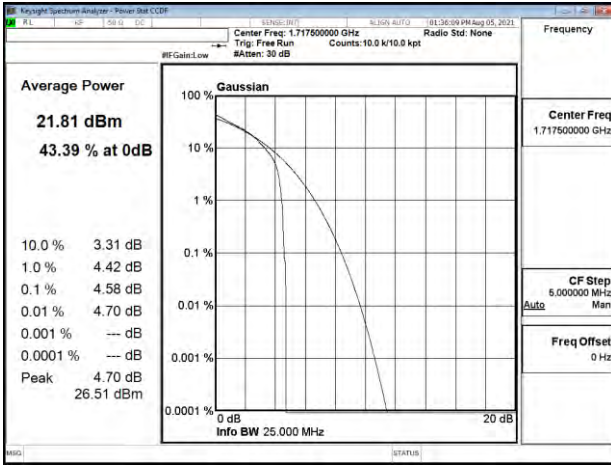

Band4_20MHz_16QAM_RB18_0_CH20050

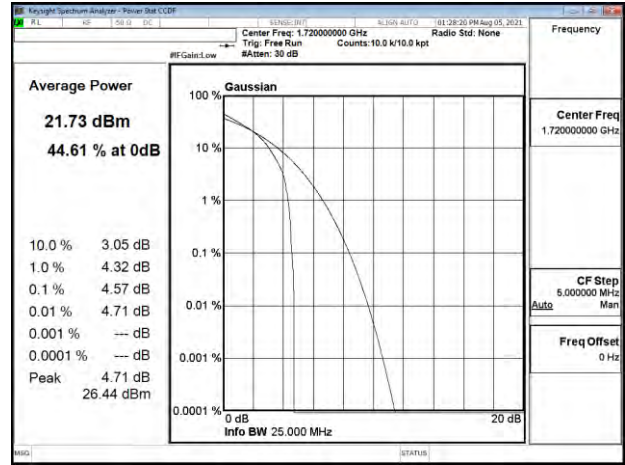

Band4_15MHz_16QAM_RB16_0_CH20175

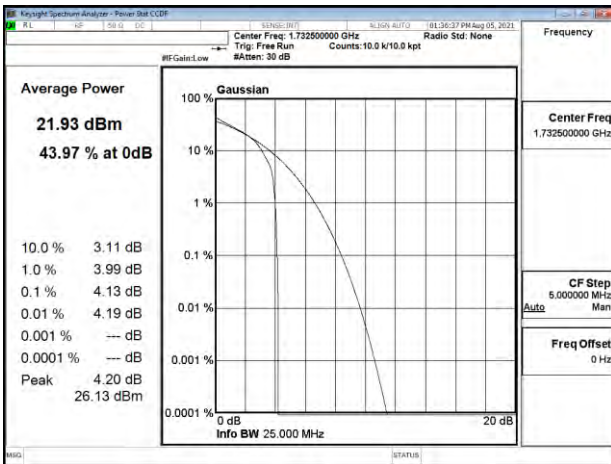

Band4_20MHz_16QAM_RB18_0_CH20175

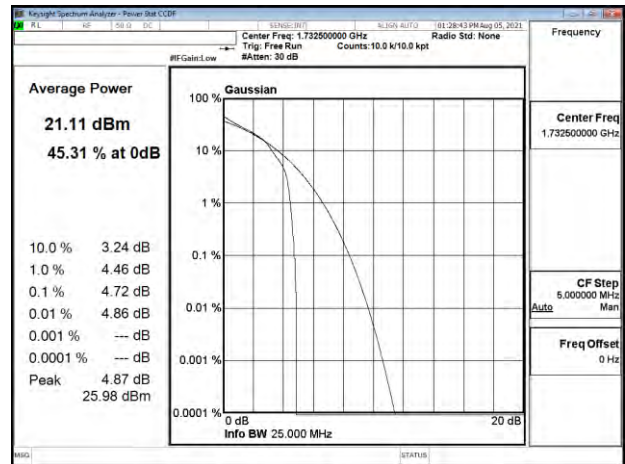

Band4_15MHz_16QAM_RB16_0_CH20325

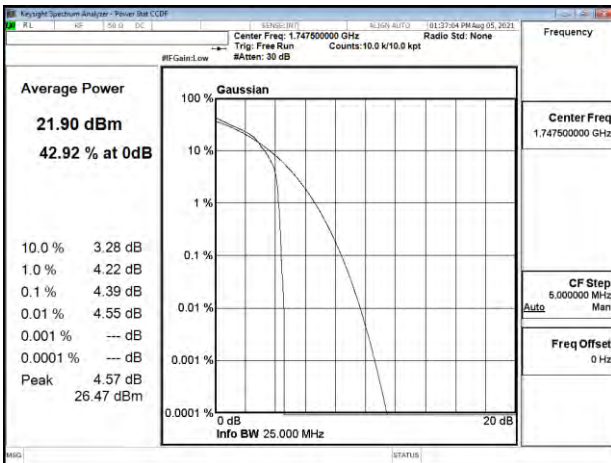

Band4_20MHz_16QAM_RB18_0_CH20300

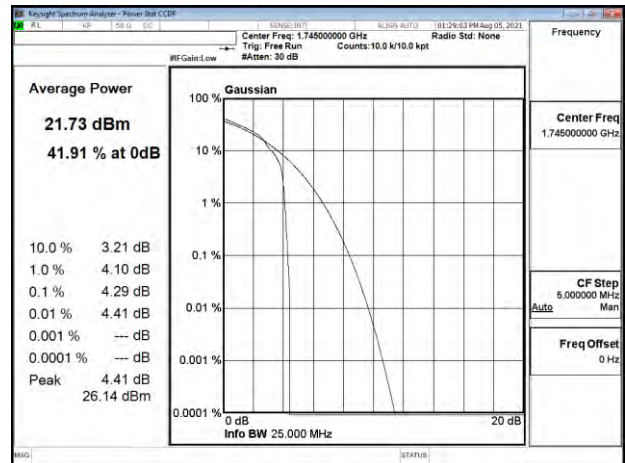

Unless otherwise stated the results shown in this test report refer only to the sample(s) tested and such sample(s) are retained for 90 days only.

除非另有說明，此報告結果僅對測試之樣品負責，同時此樣品僅保留90天。本報告未經本公司書面許可，不可部份複製。

This document is issued by the Company subject to its General Conditions of Service printed overleaf, available on request or accessible at <http://www.sgs.com.tw/Terms-and-Conditions> and for electronic format documents, subject to Terms and Conditions for Electronic Documents at <http://www.sgs.com.tw/Terms-and-Conditions>. Attention is drawn to the limitation of liability, indemnification and jurisdiction issues defined therein. Any holder of this document is advised that information contained hereon reflects the Company's findings at the time of its intervention only and within the limits of Client's instructions, if any. The Company's sole responsibility is to its Client and this document does not exonerate parties to a transaction from exercising all their rights and obligations under the transaction documents. This document cannot be reproduced except in full, without prior written approval of the Company. Any unauthorized alteration, forgery or falsification of the content or appearance of this document is unlawful and offenders may be prosecuted to the fullest extent of the law.

Band12_1.4MHz_16QAM_RB6_0_CH23017

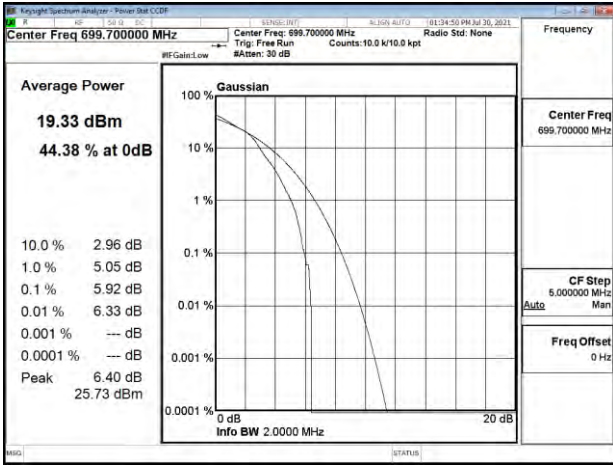

Band12_3MHz_16QAM_RB15_0_CH23025

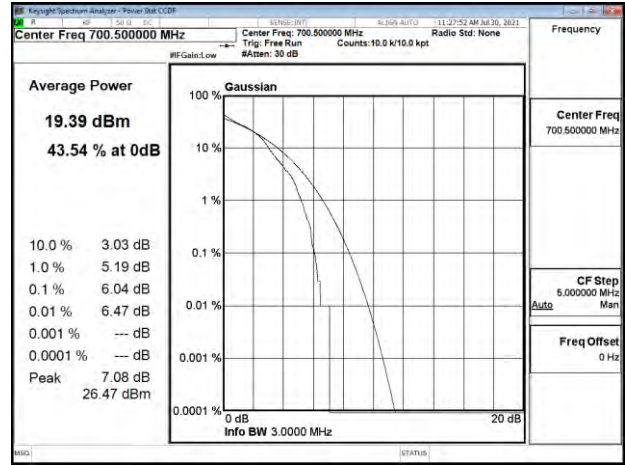

Band12_1.4MHz_16QAM_RB6_0_CH23095

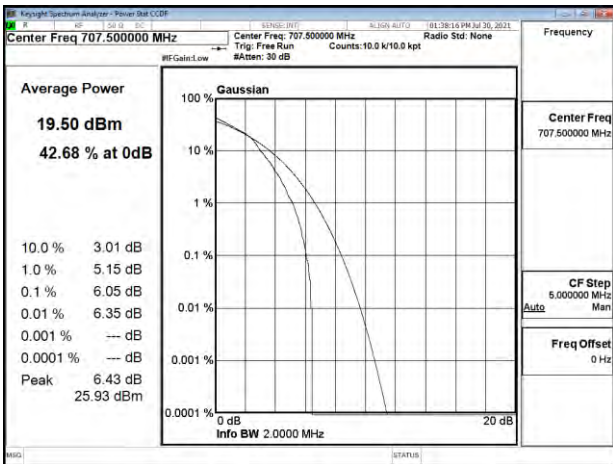

Band12_3MHz_16QAM_RB15_0_CH23095

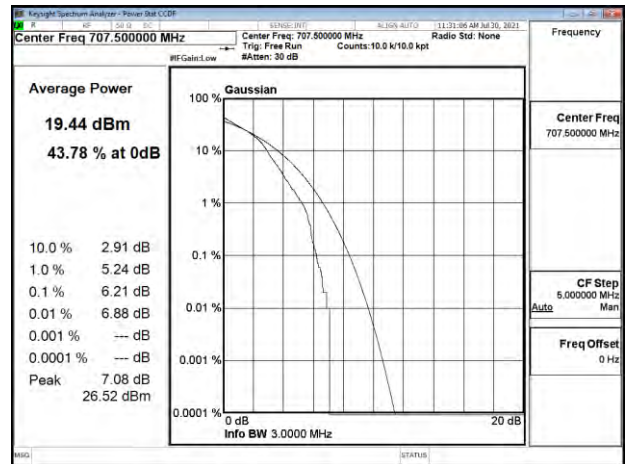

Band12_1.4MHz_16QAM_RB6_0_CH23173

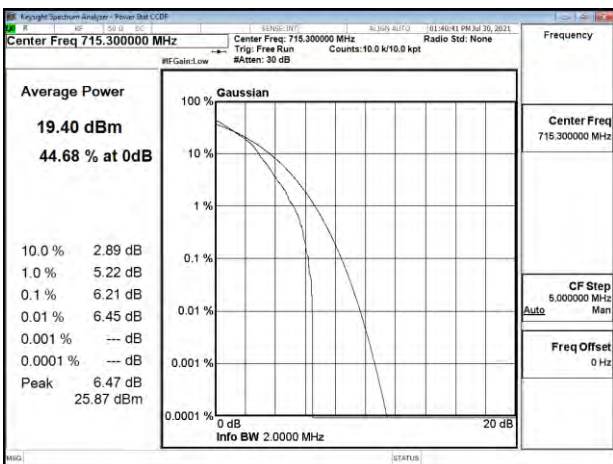

Band12_3MHz_16QAM_RB15_0_CH23165

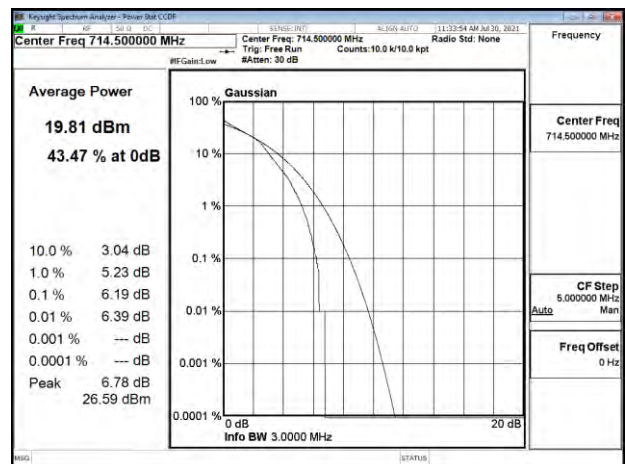

Unless otherwise stated the results shown in this test report refer only to the sample(s) tested and such sample(s) are retained for 90 days only.

除非另有說明，此報告結果僅對測試之樣品負責，同時此樣品僅保留90天。本報告未經本公司書面許可，不可部份複製。

This document is issued by the Company subject to its General Conditions of Service printed overleaf, available on request or accessible at <http://www.sgs.com.tw/Terms-and-Conditions> and for electronic format documents, subject to Terms and Conditions for Electronic Documents at <http://www.sgs.com.tw/Terms-and-Conditions>. Attention is drawn to the limitation of liability, indemnification and jurisdiction issues defined therein. Any holder of this document is advised that information contained hereon reflects the Company's findings at the time of its intervention only and within the limits of Client's instructions, if any. The Company's sole responsibility is to its Client and this document does not exonerate parties to a transaction from exercising all their rights and obligations under the transaction documents. This document cannot be reproduced except in full, without prior written approval of the Company. Any unauthorized alteration, forgery or falsification of the content or appearance of this document is unlawful and offenders may be prosecuted to the fullest extent of the law.

Band12_5MHz_16QAM_RB25_0_CH23035

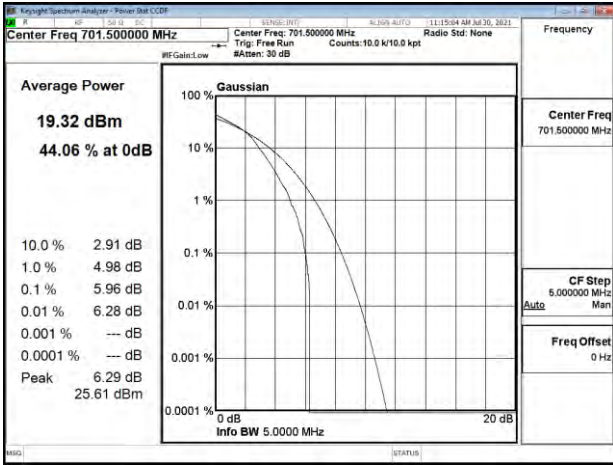

Band12_10MHz_16QAM_RB16_0_CH23060

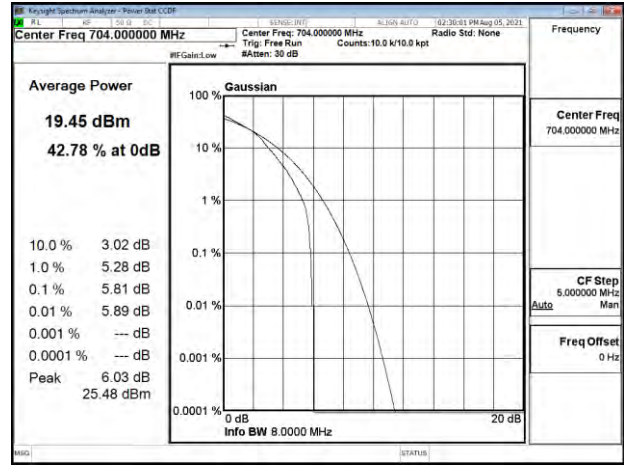

Band12_5MHz_16QAM_RB25_0_CH23095

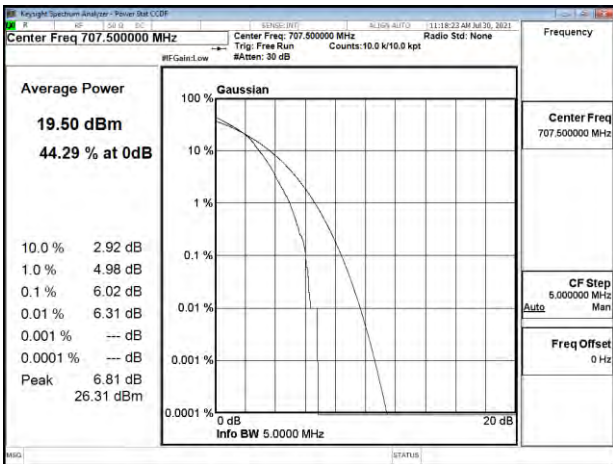

Band12_10MHz_16QAM_RB16_0_CH23095

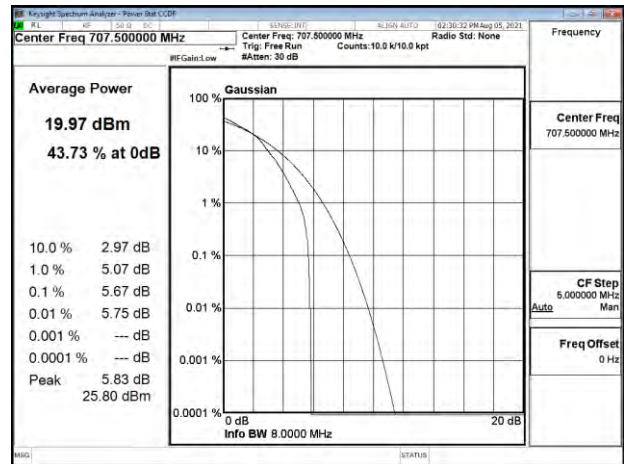

Band12_5MHz_16QAM_RB25_0_CH23155

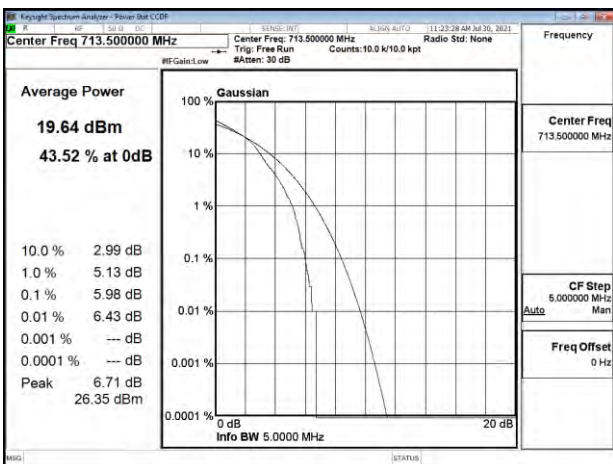

Band12_10MHz_16QAM_RB16_0_CH23130

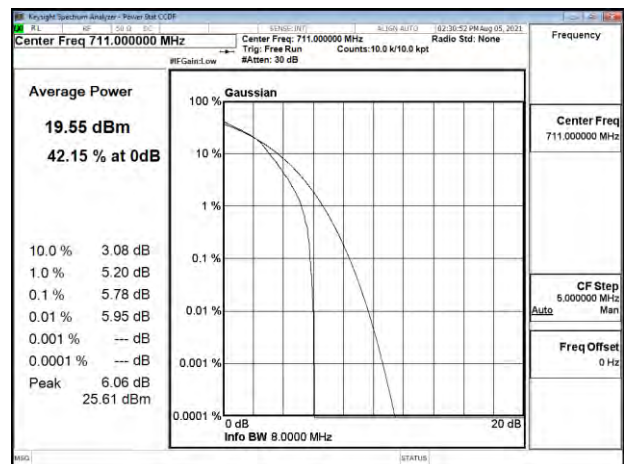

Unless otherwise stated the results shown in this test report refer only to the sample(s) tested and such sample(s) are retained for 90 days only.

除非另有說明，此報告結果僅對測試之樣品負責，同時此樣品僅保留90天。本報告未經本公司書面許可，不可部份複製。

This document is issued by the Company subject to its General Conditions of Service printed overleaf, available on request or accessible at <http://www.sgs.com.tw/Terms-and-Conditions> and for electronic format documents, subject to Terms and Conditions for Electronic Documents at <http://www.sgs.com.tw/Terms-and-Conditions>. Attention is drawn to the limitation of liability, indemnification and jurisdiction issues defined therein. Any holder of this document is advised that information contained hereon reflects the Company's findings at the time of its intervention only and within the limits of Client's instructions, if any. The Company's sole responsibility is to its Client and this document does not exonerate parties to a transaction from exercising all their rights and obligations under the transaction documents. This document cannot be reproduced except in full, without prior written approval of the Company. Any unauthorized alteration, forgery or falsification of the content or appearance of this document is unlawful and offenders may be prosecuted to the fullest extent of the law.

Band17_5MHz_16QAM_RB25_0_CH23755

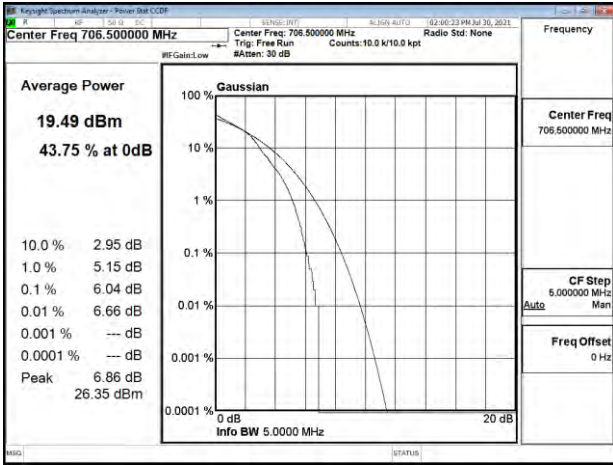

Band17_10MHz_16QAM_RB16_0_CH23780

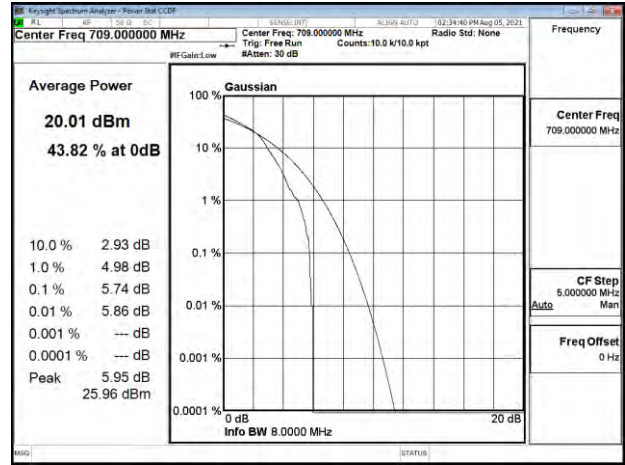

Band17_5MHz_16QAM_RB25_0_CH23790

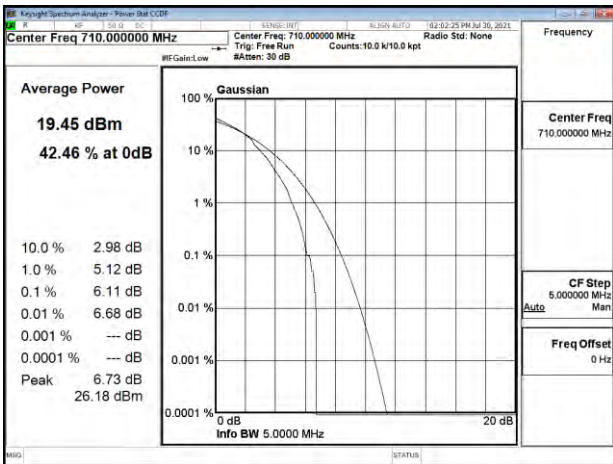

Band17_10MHz_16QAM_RB16_0_CH23790

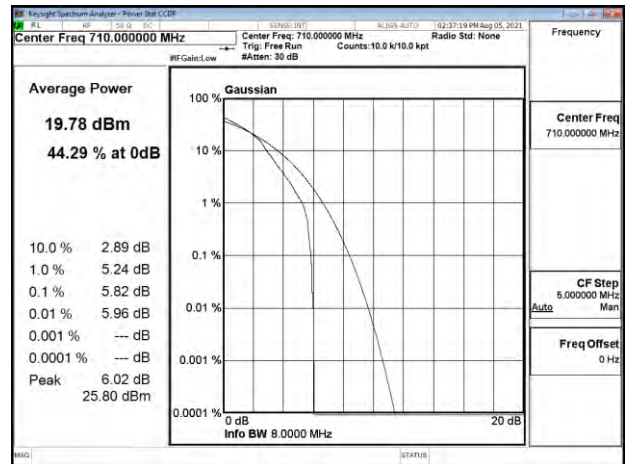

Band17_5MHz_16QAM_RB25_0_CH23825

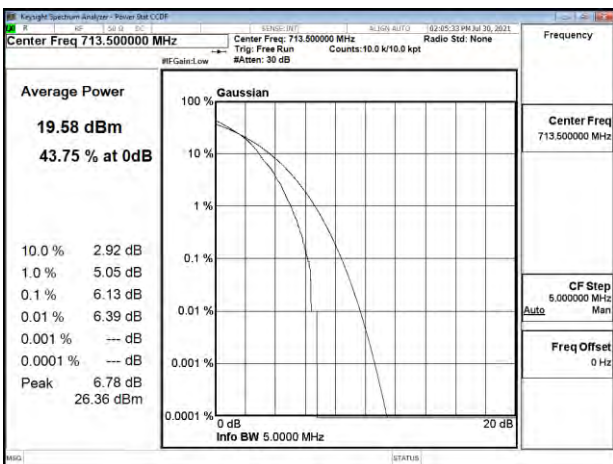

Band17_10MHz_16QAM_RB16_0_CH23800

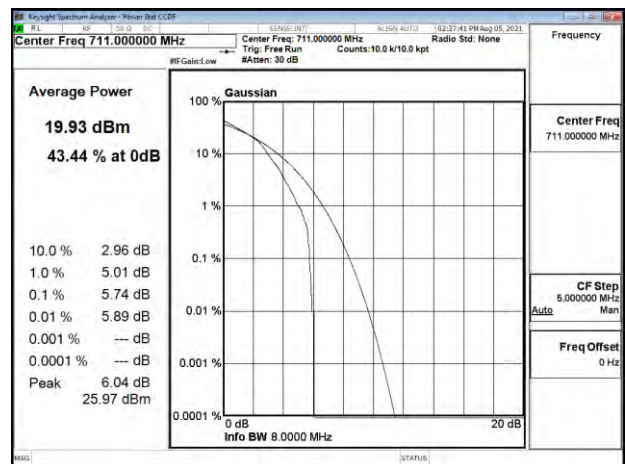

Unless otherwise stated the results shown in this test report refer only to the sample(s) tested and such sample(s) are retained for 90 days only.

除非另有說明，此報告結果僅對測試之樣品負責，同時此樣品僅保留90天。本報告未經本公司書面許可，不可部份複製。

This document is issued by the Company subject to its General Conditions of Service printed overleaf, available on request or accessible at <http://www.sgs.com.tw/Terms-and-Conditions> and for electronic format documents, subject to Terms and Conditions for Electronic Documents at <http://www.sgs.com.tw/Terms-and-Conditions>. Attention is drawn to the limitation of liability, indemnification and jurisdiction issues defined therein. Any holder of this document is advised that information contained herein reflects the Company's findings at the time of its intervention only and within the limits of Client's instructions, if any. The Company's sole responsibility is to its Client and this document does not exonerate parties to a transaction from exercising all their rights and obligations under the transaction documents. This document cannot be reproduced except in full, without prior written approval of the Company. Any unauthorized alteration, forgery or falsification of the content or appearance of this document is unlawful and offenders may be prosecuted to the fullest extent of the law.

Band66_1.4MHz_16QAM_RB6_0_CH131979

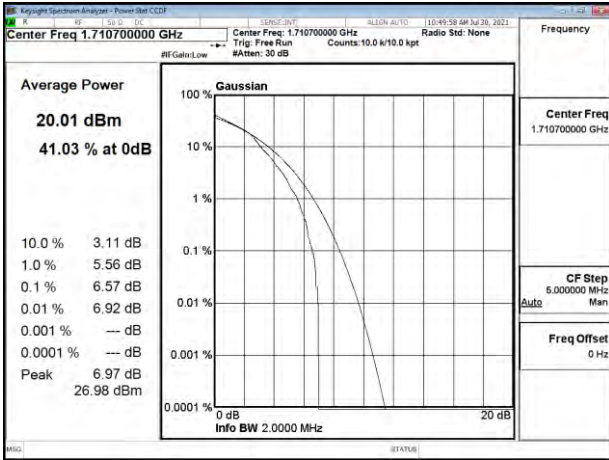

Band66_3MHz_16QAM_RB15_0_CH131987

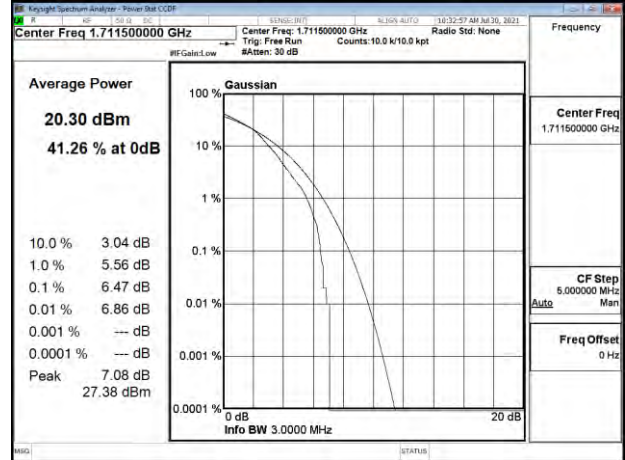

Band66_1.4MHz_16QAM_RB6_0_CH132322

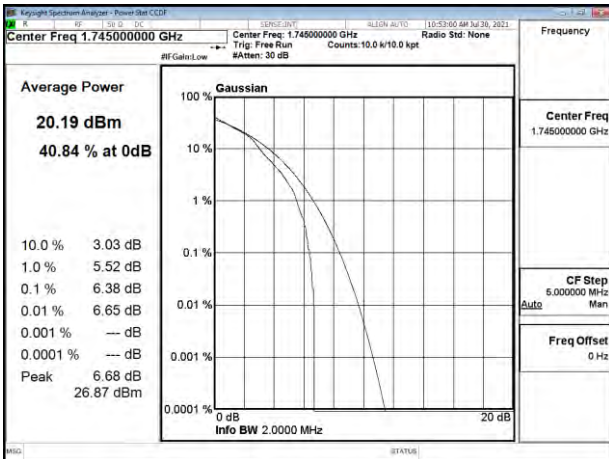

Band66_3MHz_16QAM_RB15_0_CH132322

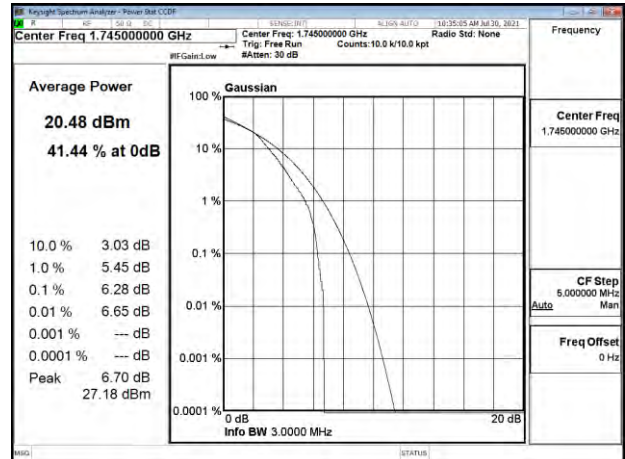

Band66_1.4MHz_16QAM_RB6_0_CH132665

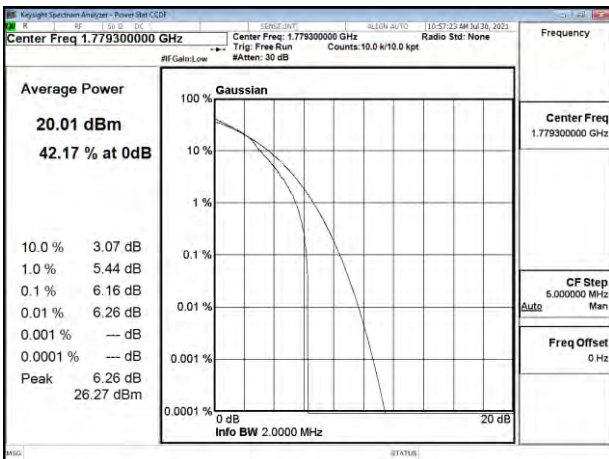

Band66_3MHz_16QAM_RB15_0_CH132657

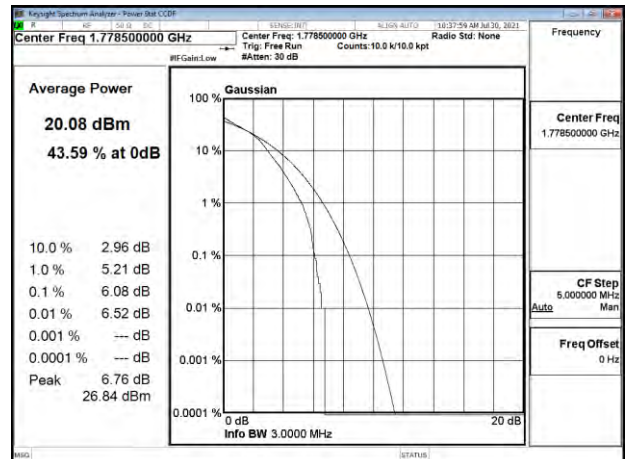

Unless otherwise stated the results shown in this test report refer only to the sample(s) tested and such sample(s) are retained for 90 days only.

除非另有說明，此報告結果僅對測試之樣品負責，同時此樣品僅保留90天。本報告未經本公司書面許可，不可部份複製。

This document is issued by the subject to its General Conditions of Service printed overleaf, available on request or accessible at <http://www.sgs.com.tw/Terms-and-Conditions> and for electronic format documents, subject to Terms and Conditions for Electronic Documents at <http://www.sgs.com.tw/Terms-and-Conditions>. Attention is drawn to the limitation of liability, indemnification and jurisdiction issues defined therein. Any holder of this document is advised that information contained herein reflects the Company's findings at the time of its intervention only and within the limits of Client's instructions, if any. The Company's sole responsibility is to its Client and this document does not exonerate parties to a transaction from exercising all their rights and obligations under the transaction documents. This document cannot be reproduced except in full, without prior written approval of the Company. Any unauthorized alteration, forgery or falsification of the content or appearance of this document is unlawful and offenders may be prosecuted to the fullest extent of the law.

Band66_5MHz_16QAM_RB25_0_CH131997

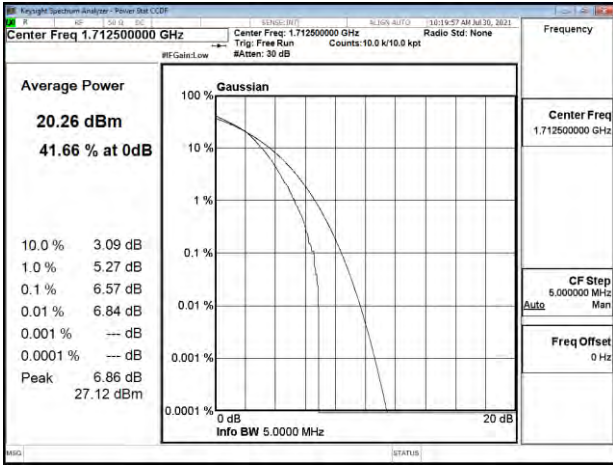

Band66_10MHz_16QAM_RB16_0_CH132022

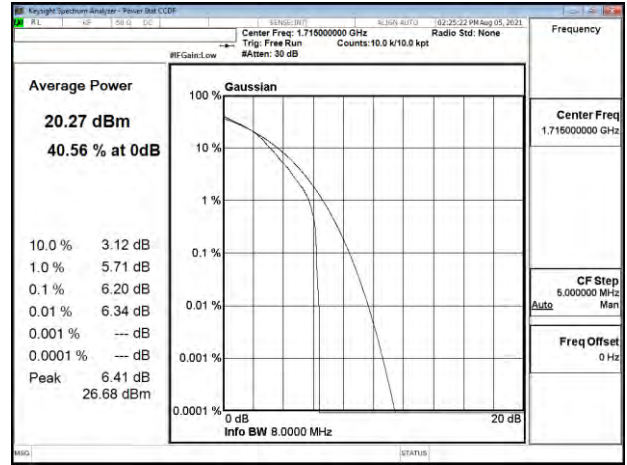

Band66_5MHz_16QAM_RB25_0_CH132322

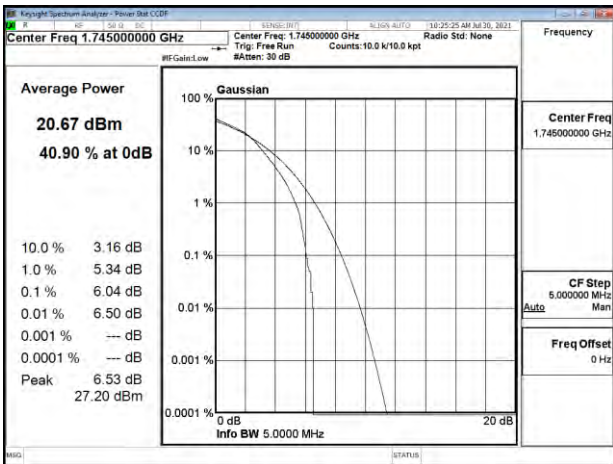

Band66_10MHz_16QAM_RB16_0_CH132322

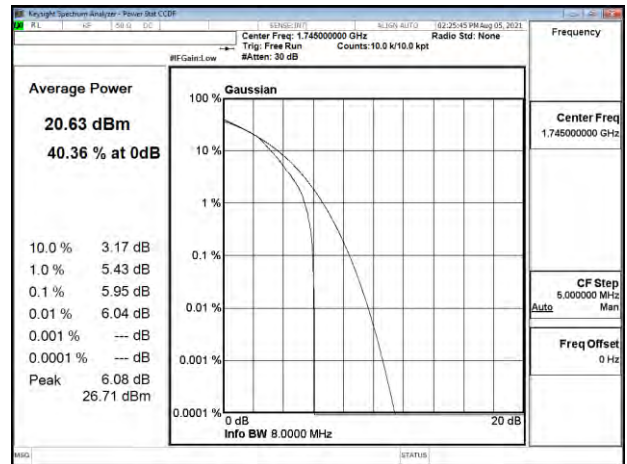

Band66_5MHz_16QAM_RB25_0_CH132647

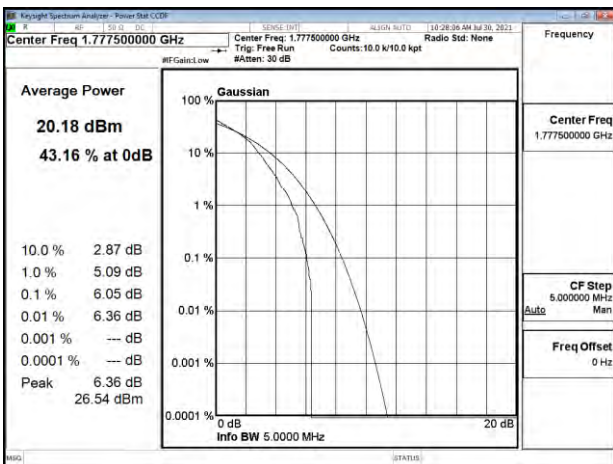

Band66_10MHz_16QAM_RB16_0_CH132622

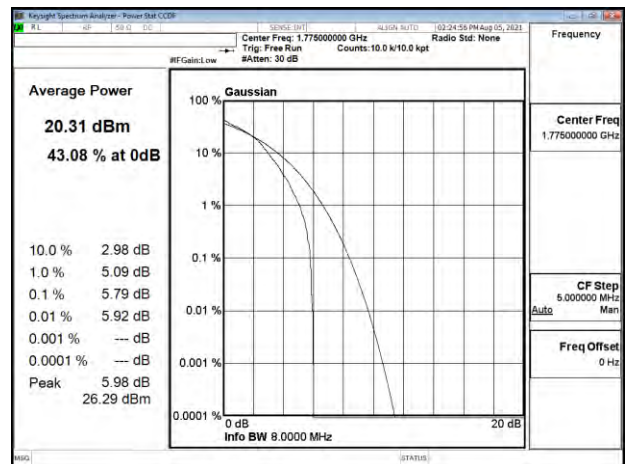

Unless otherwise stated the results shown in this test report refer only to the sample(s) tested and such sample(s) are retained for 90 days only.

除非另有說明，此報告結果僅對測試之樣品負責，同時此樣品僅保留90天。本報告未經本公司書面許可，不可部份複製。

This document is issued by the Company subject to its General Conditions of Service printed overleaf, available on request or accessible at <http://www.sgs.com.tw/Terms-and-Conditions> and for electronic format documents, subject to Terms and Conditions for Electronic Documents at <http://www.sgs.com.tw/Terms-and-Conditions>. Attention is drawn to the limitation of liability, indemnification and jurisdiction issues defined therein. Any holder of this document is advised that information contained herein reflects the Company's findings at the time of its intervention only and within the limits of Client's instructions, if any. The Company's sole responsibility is to its Client and this document does not exonerate parties to a transaction from exercising all their rights and obligations under the transaction documents. This document cannot be reproduced except in full, without prior written approval of the Company. Any unauthorized alteration, forgery or falsification of the content or appearance of this document is unlawful and offenders may be prosecuted to the fullest extent of the law.

Band66_15MHz_16QAM_RB16_0_CH132047

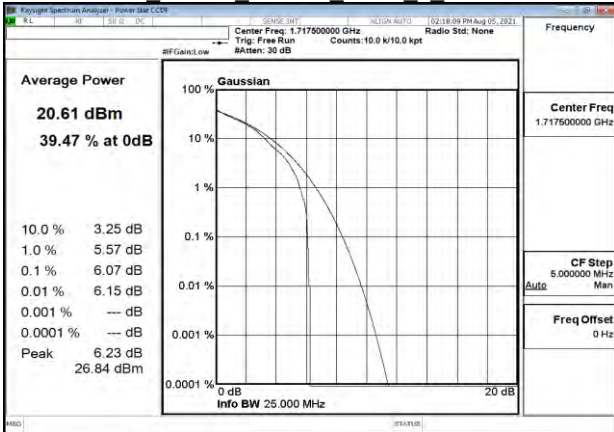

Band66_20MHz_16QAM_RB18_0_CH132072

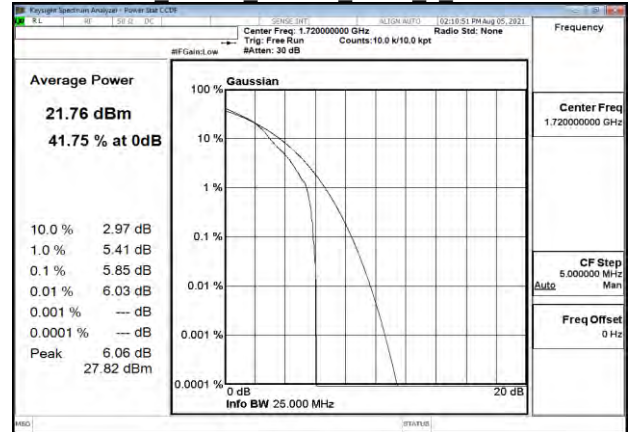

Band66_15MHz_16QAM_RB16_0_CH132322

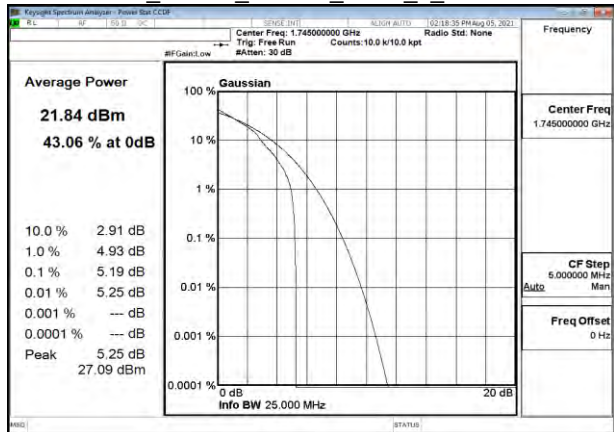

Band66_20MHz_16QAM_RB18_0_CH132322

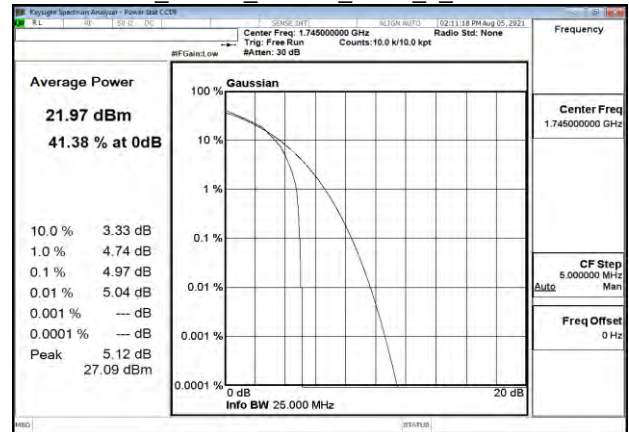

Band66_15MHz_16QAM_RB16_0_CH132597

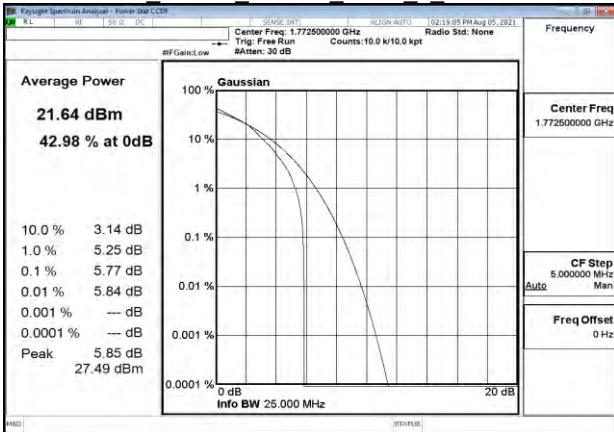

Band66_20MHz_16QAM_RB18_0_CH132572

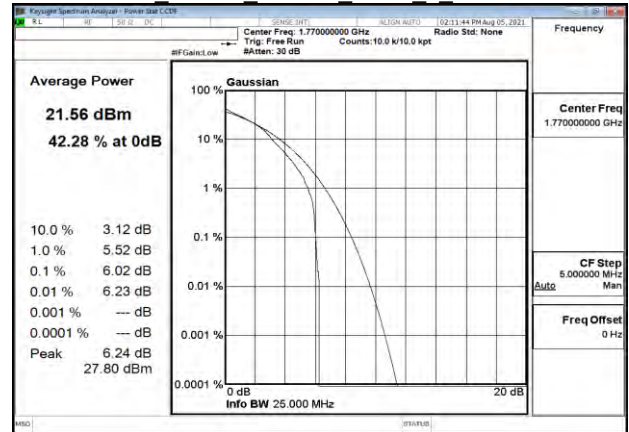

~ End of Report ~

Unless otherwise stated the results shown in this test report refer only to the sample(s) tested and such sample(s) are retained for 90 days only.

除非另有說明，此報告結果僅對測試之樣品負責，同時此樣品僅保留90天。本報告未經本公司書面許可，不可部份複製。

This document is issued by the Company subject to its General Conditions of Service printed overleaf, available on request or accessible at <http://www.sgs.com.tw/Terms-and-Conditions> and for electronic format documents, subject to Terms and Conditions for Electronic Documents at <http://www.sgs.com.tw/Terms-and-Conditions>. Attention is drawn to the limitation of liability, indemnification and jurisdiction issues defined therein. Any holder of this document is advised that information contained herein reflects the Company's findings at the time of its intervention only and within the limits of Client's instructions, if any. The Company's sole responsibility is to its Client and this document does not exonerate parties to a transaction from exercising all their rights and obligations under the transaction documents. This document cannot be reproduced except in full, without prior written approval of the Company. Any unauthorized alteration, forgery or falsification of the content or appearance of this document is unlawful and offenders may be prosecuted to the fullest extent of the law.