

**ELECTROMAGNETIC EMISSIONS
COMPLIANCE REPORT**

Applicant: Quanta Computer Inc.
No. 188, Wenhua 2nd Road, Guishan District, Taoyuan City
33377, Taiwan

Product Name: Clover Station Solo

Brand Name: clover

Model No.: C501

Model Difference: N/A

Report Number: E2/2021/70042

FCC ID HFS-C501F

Issue Date: August 24, 2021

Date of Test: July 16, 2021~August 6, 2021

Date of EUT Received: July 16, 2021

Approved By _____

Jay Lin

We hereby certify that:

The above equipment was tested by SGS Taiwan Ltd. Central RF Lab The test data, data evaluation, test procedures, and equipment configurations shown in this report were made in accordance with the procedures given in ANSI C63.10:2013 and the energy emitted by the sample EUT comply with FCC rule part §15.407.

The results of this report relate only to the sample identified in this report.

Unless otherwise stated the results shown in this test report refer only to the sample(s) tested and such sample(s) are retained for 90 days only.
除非另有說明，此報告結果僅對測試之樣品負責，同時此樣品僅保留90天。本報告未經本公司書面許可，不可部份複製。

This document is issued by the Company subject to its General Conditions of Service printed overleaf, available on request or accessible at <http://www.sgs.com.tw/Terms-and-Conditions> and for electronic format documents, subject to Terms and Conditions for Electronic Documents at <http://www.sgs.com.tw/Terms-and-Conditions>. Attention is drawn to the limitation of liability, indemnification and jurisdiction issues defined therein. Any holder of this document is advised that information contained hereon reflects the Company's findings at the time of its intervention only and within the limits of Client's instructions, if any. The Company's sole responsibility is to its Client and this document does not exonerate parties to a transaction from exercising all their rights and obligations under the transaction documents. This document cannot be reproduced except in full, without prior written approval of the Company. Any unauthorized alteration, forgery or falsification of the content or appearance of this document is unlawful and offenders may be prosecuted to the fullest extent of the law.

Revision History

Report Number	Revision	Description	Issue Date	Revised By
E2/2021/70042	00	Original	August 24, 2021	Susan Lin

Unless otherwise stated the results shown in this test report refer only to the sample(s) tested and such sample(s) are retained for 90 days only.

除非另有說明，此報告結果僅對測試之樣品負責，同時此樣品僅保留90天。本報告未經本公司書面許可，不可部份複製。

This document is issued by the Company subject to its General Conditions of Service printed overleaf, available on request or accessible at <http://www.sgs.com.tw/Terms-and-Conditions> and for electronic format documents, subject to Terms and Conditions for Electronic Documents at <http://www.sgs.com.tw/Terms-and-Conditions>. Attention is drawn to the limitation of liability, indemnification and jurisdiction issues defined therein. Any holder of this document is advised that information contained hereon reflects the Company's findings at the time of its intervention only and within the limits of Client's instructions, if any. The Company's sole responsibility is to its Client and this document does not exonerate parties to a transaction from exercising all their rights and obligations under the transaction documents. This document cannot be reproduced except in full, without prior written approval of the Company. Any unauthorized alteration, forgery or falsification of the content or appearance of this document is unlawful and offenders may be prosecuted to the fullest extent of the law.

Contents

1	GENERAL INFORMATION	4
2	SYSTEM TEST CONFIGURATION	9
3	SUMMARY OF TEST RESULT	12
4	DESCRIPTION OF TEST MODES	13
5	MEASUREMENT UNCERTAINTY	17
6	CONDUCTED EMISSION TEST	18
7	DUTY CYCLE TEST SIGNAL	22
8	EMISSION BANDWIDTH MEASUREMENT	24
9	MAXIMUM CONDUCTED OUTPUT POWER MEASUREMENT	42
10	MAXIMUM POWER SPECTRAL DENSITY	51
11	UNDESIRABLE RADIATED EMISSION MEASUREMENT	68
12	TRANSMISSION IN THE ABSENCE OF DATA.....	220
13	ANTENNA REQUIREMENT	221

Unless otherwise stated the results shown in this test report refer only to the sample(s) tested and such sample(s) are retained for 90 days only.
 除非另有說明，此報告結果僅對測試之樣品負責，同時此樣品僅保留90天。本報告未經本公司書面許可，不可部份複製。

This document is issued by the Company subject to its General Conditions of Service printed overleaf, available on request or accessible at <http://www.sgs.com.tw/Terms-and-Conditions> and for electronic format documents, subject to Terms and Conditions for Electronic Documents at <http://www.sgs.com.tw/Terms-and-Conditions>. Attention is drawn to the limitation of liability, indemnification and jurisdiction issues defined therein. Any holder of this document is advised that information contained hereon reflects the Company's findings at the time of its intervention only and within the limits of Client's instructions, if any. The Company's sole responsibility is to its Client and this document does not exonerate parties to a transaction from exercising all their rights and obligations under the transaction documents. This document cannot be reproduced except in full, without prior written approval of the Company. Any unauthorized alteration, forgery or falsification of the content or appearance of this document is unlawful and offenders may be prosecuted to the fullest extent of the law.

1 GENERAL INFORMATION

1.1 Product Description

Product Name:	Clover Station Solo
Brand Name:	clover
Model No.:	C501
Model Difference:	N/A
Hardware Version:	N/A
Firmware Version:	N/A
EUT Series No.:	C051UQ12450327
Power Supply:	24V from AC/DC Adapter or 3.8V from Rechargeable Li-ion Polymer Battery

1.2 Modulation & Data Rate

Modulation type:	64QAM, 16QAM, QPSK, BPSK for OFDM
	256QAM for OFDM in 802.11ac only
Transition Rate:	802.11 a: 6.5 - 54 Mbps
	802.11 n_20MHz: 6.5 - 144.4 Mbps
	802.11 n_40MHz: 13.5 - 300 Mbps
	802.11 ac_20MHz: 6.5 - 173.4 Mbps
	802.11 ac_40MHz: 13.5 - 400 Mbps
	802.11 ac_80MHz: 29.3 - 866.6 Mbps

Unless otherwise stated the results shown in this test report refer only to the sample(s) tested and such sample(s) are retained for 90 days only.

除非另有說明，此報告結果僅對測試之樣品負責，同時此樣品僅保留90天。本報告未經本公司書面許可，不可部份複製。

This document is issued by the Company subject to its General Conditions of Service printed overleaf, available on request or accessible at <http://www.sgs.com.tw/Terms-and-Conditions> and for electronic format documents, subject to Terms and Conditions for Electronic Documents at <http://www.sgs.com.tw/Terms-and-Conditions>. Attention is drawn to the limitation of liability, indemnification and jurisdiction issues defined therein. Any holder of this document is advised that information contained hereon reflects the Company's findings at the time of its intervention only and within the limits of Client's instructions, if any. The Company's sole responsibility is to its Client and this document does not exonerate parties to a transaction from exercising all their rights and obligations under the transaction documents. This document cannot be reproduced except in full, without prior written approval of the Company. Any unauthorized alteration, forgery or falsification of the content or appearance of this document is unlawful and offenders may be prosecuted to the fullest extent of the law.

1.3 Antenna Designation

Antenna Type	Supplier	Antenna Part No.	Freq. (MHz)	Peak Antenna Gain (dBi)	Worst Antenna Gain
PIFA	Quanta	WIFI-1 antenna	5150~5250	0.41	
			5250~5350	0.41	
			5470~5725	0.43	
			5725~5850	0.54	
	Quanta	WIFI-2 antenna	5150~5250	3.96	V
			5250~5350	3.96	V
			5470~5725	3.86	V
			5725~5850	3.95	V

Note:

1. Pre-scanned was done on the above antennas, measurements were demonstrated by using the antenna with the highest gain as the worst case scenarios.
2. Antenna information is provided by the applicant.

Unless otherwise stated the results shown in this test report refer only to the sample(s) tested and such sample(s) are retained for 90 days only.

除非另有說明，此報告結果僅對測試之樣品負責，同時此樣品僅保留90天。本報告未經本公司書面許可，不可部份複製。

This document is issued by the Company subject to its General Conditions of Service printed overleaf, available on request or accessible at <http://www.sgs.com.tw/Terms-and-Conditions> and for electronic format documents, subject to Terms and Conditions for Electronic Documents at <http://www.sgs.com.tw/Terms-and-Conditions>. Attention is drawn to the limitation of liability, indemnification and jurisdiction issues defined therein. Any holder of this document is advised that information contained hereon reflects the Company's findings at the time of its intervention only and within the limits of Client's instructions, if any. The Company's sole responsibility is to its Client and this document does not exonerate parties to a transaction from exercising all their rights and obligations under the transaction documents. This document cannot be reproduced except in full, without prior written approval of the Company. Any unauthorized alteration, forgery or falsification of the content or appearance of this document is unlawful and offenders may be prosecuted to the fullest extent of the law.

1.4 FCC

WLAN 5 GHz				
Wi-Fi	Frequency Range	Channels	Rated Power(Avg) (dBm) (Worst Case)	Modulation Technology
a n_HT ac_VHT 20M	5180~5240	4	19.91 dBm	OFDM
	5260~5320	4	19.96 dBm	OFDM
	5500~5720	12	19.99 dBm	OFDM
	5745~5825	5	19.68 dBm	OFDM
n_HT ac_VHT 40M	5190~5230	2	18.65 dBm	OFDM
	5270~5310	2	18.83 dBm	OFDM
	5510~5670	5	18.98 dBm	OFDM
	5755~5795	2	18.98 dBm	OFDM
ac_VHT 80M	5210	1	17.83 dBm	OFDM
	5290	1	17.99 dBm	OFDM
	5530~5610	2	17.92 dBm	OFDM
	5775	1	17.80 dBm	OFDM

Unless otherwise stated the results shown in this test report refer only to the sample(s) tested and such sample(s) are retained for 90 days only.

除非另有說明，此報告結果僅對測試之樣品負責，同時此樣品僅保留90天。本報告未經本公司書面許可，不可部份複製。

This document is issued by the Company subject to its General Conditions of Service printed overleaf, available on request or accessible at <http://www.sgs.com.tw/Terms-and-Conditions> and for electronic format documents, subject to Terms and Conditions for Electronic Documents at <http://www.sgs.com.tw/Terms-and-Conditions>. Attention is drawn to the limitation of liability, indemnification and jurisdiction issues defined therein. Any holder of this document is advised that information contained hereon reflects the Company's findings at the time of its intervention only and within the limits of Client's instructions, if any. The Company's sole responsibility is to its Client and this document does not exonerate parties to a transaction from exercising all their rights and obligations under the transaction documents. This document cannot be reproduced except in full, without prior written approval of the Company. Any unauthorized alteration, forgery or falsification of the content or appearance of this document is unlawful and offenders may be prosecuted to the fullest extent of the law.

1.5 Test Methodology of Applied Standards

FCC Part 15, Subpart E §15.407
 FCC KDB 789033 D02 General UNII Test Procedures New Rules v02r01
 FCC KDB 662911 D01 Multiple Transmitter Output v02r01
 ANSI C63.10:2013

1.6 Test Facility

Laboratory	Test Site Address	Test Site Name	FCC Designation number	IC CAB identifier
SGS Taiwan Ltd. Central RF Lab. (TAF code 3702)	No.134, Wu Kung Road, New Taipei Industrial Park, Wuku District, New Taipei City, Taiwan.	SAC 1	TW0027	TW3702
		SAC 3		
		Conduction 1		
		Conducted 1		
		Conducted 2		
		Conducted 3		
		Conducted 4		
		Conducted 5		
		Conducted 6		
		Conduction C		
	SAC C			
	SAC D			
	SAC G			
	Conducted A			
	Conducted B			
	Conducted C			
	Conducted D			
	Conducted E			
	Conducted F			
	Conducted G			
<p>Note: Test site name is remarked on the equipment list in each section of this report as an indication where measurements occurred in specific test site and address.</p>				

Unless otherwise stated the results shown in this test report refer only to the sample(s) tested and such sample(s) are retained for 90 days only.

除非另有說明，此報告結果僅對測試之樣品負責，同時此樣品僅保留90天。本報告未經本公司書面許可，不可部份複製。
 This document is issued by the Company subject to its General Conditions of Service printed overleaf, available on request or accessible at <http://www.sgs.com.tw/Terms-and-Conditions> and for electronic format documents, subject to Terms and Conditions for Electronic Documents at <http://www.sgs.com.tw/Terms-and-Conditions>. Attention is drawn to the limitation of liability, indemnification and jurisdiction issues defined therein. Any holder of this document is advised that information contained hereon reflects the Company's findings at the time of its intervention only and within the limits of Client's instructions, if any. The Company's sole responsibility is to its Client and this document does not exonerate parties to a transaction from exercising all their rights and obligations under the transaction documents. This document cannot be reproduced except in full, without prior written approval of the Company. Any unauthorized alteration, forgery or falsification of the content or appearance of this document is unlawful and offenders may be prosecuted to the fullest extent of the law.

1.7 Special Accessories

There are no special accessories used while test was conducted.

1.8 Equipment Modifications

There was no modification incorporated into the EUT.

Unless otherwise stated the results shown in this test report refer only to the sample(s) tested and such sample(s) are retained for 90 days only.

除非另有說明，此報告結果僅對測試之樣品負責，同時此樣品僅保留90天。本報告未經本公司書面許可，不可部份複製。

This document is issued by the Company subject to its General Conditions of Service printed overleaf, available on request or accessible at <http://www.sgs.com.tw/Terms-and-Conditions> and for electronic format documents, subject to Terms and Conditions for Electronic Documents at <http://www.sgs.com.tw/Terms-and-Conditions>. Attention is drawn to the limitation of liability, indemnification and jurisdiction issues defined therein. Any holder of this document is advised that information contained hereon reflects the Company's findings at the time of its intervention only and within the limits of Client's instructions, if any. The Company's sole responsibility is to its Client and this document does not exonerate parties to a transaction from exercising all their rights and obligations under the transaction documents. This document cannot be reproduced except in full, without prior written approval of the Company. Any unauthorized alteration, forgery or falsification of the content or appearance of this document is unlawful and offenders may be prosecuted to the fullest extent of the law.

2 SYSTEM TEST CONFIGURATION

2.1 EUT Configuration

The EUT configuration for testing is installed on RF field strength measurement to meet the Commissions requirement and operating in a manner which intends to maximize its emission characteristics in a continuous normal application.

2.2 EUT Exercise

An engineering test mode (software/firmware) that applicant provided was utilized to manipulate the EUT into transmit, selection of the test channel, and modulation scheme.

2.3 Test Procedure

2.3.1 Conducted Emissions

The EUT is a placed on a table which is 0.8 m above ground plane. Conducted emissions from the EUT measured in the frequency range between 0.15 MHz and 30MHz. The CISPR Quasi-Peak and Average detector mode is employed. The two LISNs provide 50uH/50 ohm of coupling impedance for the measuring instrument. Both lines of the power mains connected to the EUT were checked for maximum conducted interference.

2.3.2 Conducted Test (RF)

The active antenna port of the unlicensed wireless device is connected to the spectrum analyzer with attenuator to protect the instrumentation. If a second antenna port is available, it is tested at one operating frequency, with other port(s) appropriately terminated, to verify it has similar output characteristics as the fully tested port.

2.3.3 Radiated Emissions

The EUT is a placed on a turn table. For emissions testing at or below 1 GHz, the table height shall be 0.8 m above the reference ground plane. For emission measurements above 1 GHz, the table height shall be 1.5 m. The turn table shall rotate 360 degrees to determine the position of maximum emission level. EUT is set 3m away from the receiving antenna which varied from 1m to 4m to find out the highest emission. And also, each emission was to be maximized by changing the polarization of receiving antenna both horizontal and vertical. In order to find out the max. emission, the relative positions of this transmitter (EUT) was rotated through three orthogonal axes and measurement procedures for electric field radiated emissions above 1 GHz the EUT measurement is to be made "while keeping the antenna in the 'cone of radiation' from that area and pointed at the area both in azimuth and elevation, with polarization oriented for maximum response." is still within the 3dB illumination BW of the measurement antenna.

Unless otherwise stated the results shown in this test report refer only to the sample(s) tested and such sample(s) are retained for 90 days only.

除非另有說明，此報告結果僅對測試之樣品負責，同時此樣品僅保留90天。本報告未經本公司書面許可，不可部份複製。

This document is issued by the Company subject to its General Conditions of Service printed overleaf, available on request or accessible at <http://www.sgs.com.tw/Terms-and-Conditions> and for electronic format documents, subject to Terms and Conditions for Electronic Documents at <http://www.sgs.com.tw/Terms-and-Conditions>. Attention is drawn to the limitation of liability, indemnification and jurisdiction issues defined therein. Any holder of this document is advised that information contained hereon reflects the Company's findings at the time of its intervention only and within the limits of Client's instructions, if any. The Company's sole responsibility is to its Client and this document does not exonerate parties to a transaction from exercising all their rights and obligations under the transaction documents. This document cannot be reproduced except in full, without prior written approval of the Company. Any unauthorized alteration, forgery or falsification of the content or appearance of this document is unlawful and offenders may be prosecuted to the fullest extent of the law.

2.4 Measurement Results Explanation Example

2.4.1 Radiated Emission Test Sites For Measurements From 9 kHz To 30 MHz

Radiated emission below 30MHz is measured in a 9m*9m*6m semi-anechoic chamber, the measurements correspond to those obtained at an open-field test site.

There is a comparison data of both open-field test site and semi-Anechoic chamber, and the result came out very similar.

2.4.2 For all conducted test items:

The offset level is set in the spectrum analyzer to compensate the RF cable loss and attenuation factor between EUT conducted port and spectrum analyzer. With the offset compensation, the spectrum analyzer reading level is exactly EUT RF output level.

Unless otherwise stated the results shown in this test report refer only to the sample(s) tested and such sample(s) are retained for 90 days only.

除非另有說明，此報告結果僅對測試之樣品負責，同時此樣品僅保留90天。本報告未經本公司書面許可，不可部份複製。

This document is issued by the Company subject to its General Conditions of Service printed overleaf, available on request or accessible at <http://www.sgs.com.tw/Terms-and-Conditions> and for electronic format documents, subject to Terms and Conditions for Electronic Documents at <http://www.sgs.com.tw/Terms-and-Conditions>. Attention is drawn to the limitation of liability, indemnification and jurisdiction issues defined therein. Any holder of this document is advised that information contained hereon reflects the Company's findings at the time of its intervention only and within the limits of Client's instructions, if any. The Company's sole responsibility is to its Client and this document does not exonerate parties to a transaction from exercising all their rights and obligations under the transaction documents. This document cannot be reproduced except in full, without prior written approval of the Company. Any unauthorized alteration, forgery or falsification of the content or appearance of this document is unlawful and offenders may be prosecuted to the fullest extent of the law.

2.5 Test Configuration

Fig. 2-1 Conduction (AC Power Line) Emission

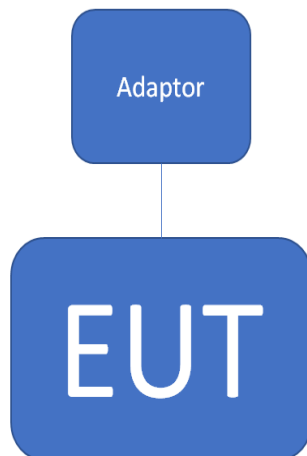

Fig. 2-2 Conducted (Antenna Port) & Radiated Emission

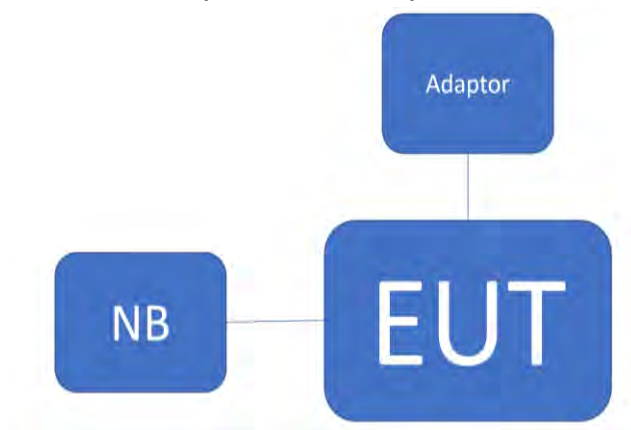

Table 2-1 Equipment Used in Tested System

Item	Equipment	Mfr/Brand	Model/Type No.	Series No.	Data Cable	Power Cord
1.	WLAN Test Software	N/A	N/A	N/A	N/A	N/A
2.	Notebook	Lenovo	L430	P0000195	N/A	N/A

Unless otherwise stated the results shown in this test report refer only to the sample(s) tested and such sample(s) are retained for 90 days only.

除非另有說明，此報告結果僅對測試之樣品負責，同時此樣品僅保留90天。本報告未經本公司書面許可，不可部份複製。

This document is issued by the Company subject to its General Conditions of Service printed overleaf, available on request or accessible at <http://www.sgs.com.tw/Terms-and-Conditions> and for electronic format documents, subject to Terms and Conditions for Electronic Documents at <http://www.sgs.com.tw/Terms-and-Conditions>. Attention is drawn to the limitation of liability, indemnification and jurisdiction issues defined therein. Any holder of this document is advised that information contained hereon reflects the Company's findings at the time of its intervention only and within the limits of Client's instructions, if any. The Company's sole responsibility is to its Client and this document does not exonerate parties to a transaction from exercising all their rights and obligations under the transaction documents. This document cannot be reproduced except in full, without prior written approval of the Company. Any unauthorized alteration, forgery or falsification of the content or appearance of this document is unlawful and offenders may be prosecuted to the fullest extent of the law.

3 SUMMARY OF TEST RESULT

FCC Rules	Description Of Test	Result
§15.207	AC Power Line Conducted Emission	Compliant
§15.407(e)	Emission Bandwidth	Compliant
§15.407(a)	Maximum Conducted Output Power	Compliant
§15.407(a)	Power Spectral Density	Compliant
§15.205 §15.209 §15.407(b)	Undesirable Radiated Emissions	Compliant
§15.407(c)	Transmission in case of Absence of Information	Compliant
§15.203 §15.407(a)	Antenna Requirement	Compliant

Unless otherwise stated the results shown in this test report refer only to the sample(s) tested and such sample(s) are retained for 90 days only.

除非另有說明，此報告結果僅對測試之樣品負責，同時此樣品僅保留90天。本報告未經本公司書面許可，不可部份複製。

This document is issued by the Company subject to its General Conditions of Service printed overleaf, available on request or accessible at <http://www.sgs.com.tw/Terms-and-Conditions> and for electronic format documents, subject to Terms and Conditions for Electronic Documents at <http://www.sgs.com.tw/Terms-and-Conditions>. Attention is drawn to the limitation of liability, indemnification and jurisdiction issues defined therein. Any holder of this document is advised that information contained hereon reflects the Company's findings at the time of its intervention only and within the limits of Client's instructions, if any. The Company's sole responsibility is to its Client and this document does not exonerate parties to a transaction from exercising all their rights and obligations under the transaction documents. This document cannot be reproduced except in full, without prior written approval of the Company. Any unauthorized alteration, forgery or falsification of the content or appearance of this document is unlawful and offenders may be prosecuted to the fullest extent of the law.

4 DESCRIPTION OF TEST MODES

4.1 Operating Frequencies

Operated band in 5150 MHz ~5250 MHz:

20 M	
CH	Freq (MHz)
36	5180
40	5200
44	5220
48	5240

40 M	
CH	Freq (MHz)
38	5190
46	5230

80 M	
CH	Freq (MHz)
42	5210

Operated band in 5250 MHz ~5350 MHz:

20 M	
CH	Freq (MHz)
52	5260
56	5280
60	5300
64	5320

40 M	
CH	Freq (MHz)
54	5270
62	5310

80 M	
CH	Freq (MHz)
58	5290

Operated band in 5470 MHz ~5725 MHz:

20 M	
CH	Freq (MHz)
100	5500
104	5520
108	5540
112	5560
116	5580
120	5600
124	5620
128	5640
132	5660
136	5680
140	5700
144	5720

40 M	
CH	Freq (MHz)
102	5510
110	5550
118	5590
126	5630
134	5670

80 M	
CH	Freq (MHz)
106	5530
122	5610

Operated band in 5745 MHz ~5850 MHz:

20 M	
CH	Freq (MHz)
149	5745
153	5765
157	5785
161	5805
165	5825

40 M	
CH	Freq (MHz)
151	5755
159	5795

80 M	
CH	Freq (MHz)
155	5775

Unless otherwise stated the results shown in this test report refer only to the sample(s) tested and such sample(s) are retained for 90 days only.

除非另有說明，此報告結果僅對測試之樣品負責，同時此樣品僅保留90天。本報告未經本公司書面許可，不可部份複製。
This document is issued by the Company subject to its General Conditions of Service printed overleaf, available on request or accessible at <http://www.sgs.com.tw/Terms-and-Conditions> and for electronic format documents, subject to Terms and Conditions for Electronic Documents at <http://www.sgs.com.tw/Terms-and-Conditions>. Attention is drawn to the limitation of liability, indemnification and jurisdiction issues defined therein. Any holder of this document is advised that information contained hereon reflects the Company's findings at the time of its intervention only and within the limits of Client's instructions, if any. The Company's sole responsibility is to its Client and this document does not exonerate parties to a transaction from exercising all their rights and obligations under the transaction documents. This document cannot be reproduced except in full, without prior written approval of the Company. Any unauthorized alteration, forgery or falsification of the content or appearance of this document is unlawful and offenders may be prosecuted to the fullest extent of the law.

4.2 The Worst Test Modes and Channel Details

1. The EUT has been tested under operating condition.
2. Test program used to control the EUT for staying in continuous transmitting mode is programmed.
3. Investigation has been done on all the possible configurations for searching the worst case. The given UE is pre-scanned among below modes.

Modulation	Transmission Chain				Single Transmission Spatial	Multiple Transmission Spatial
<input checked="" type="checkbox"/> 802.11 a	<input checked="" type="checkbox"/> Ch0	<input checked="" type="checkbox"/> Ch1	<input type="checkbox"/> Ch2	<input type="checkbox"/> Ch3	<input type="checkbox"/> 1TX	<input type="checkbox"/> 2TX
<input checked="" type="checkbox"/> 802.11 n	<input checked="" type="checkbox"/> Ch0	<input checked="" type="checkbox"/> Ch1	<input type="checkbox"/> Ch2	<input type="checkbox"/> Ch3	<input type="checkbox"/> SISO	<input checked="" type="checkbox"/> MIMO
<input checked="" type="checkbox"/> 802.11 ac	<input checked="" type="checkbox"/> Ch0	<input checked="" type="checkbox"/> Ch1	<input type="checkbox"/> Ch2	<input type="checkbox"/> Ch3	<input type="checkbox"/> SISO	<input checked="" type="checkbox"/> MIMO

4. Therefore, below summary is the modes of test configuration that yield the highest reading and generate the highest emission chosen to carry out the relevantly mandatory test items.

Unless otherwise stated the results shown in this test report refer only to the sample(s) tested and such sample(s) are retained for 90 days only.

除非另有說明，此報告結果僅對測試之樣品負責，同時此樣品僅保留90天。本報告未經本公司書面許可，不可部份複製。

This document is issued by the Company subject to its General Conditions of Service printed overleaf, available on request or accessible at <http://www.sgs.com.tw/Terms-and-Conditions> and for electronic format documents, subject to Terms and Conditions for Electronic Documents at <http://www.sgs.com.tw/Terms-and-Conditions>. Attention is drawn to the limitation of liability, indemnification and jurisdiction issues defined therein. Any holder of this document is advised that information contained hereon reflects the Company's findings at the time of its intervention only and within the limits of Client's instructions, if any. The Company's sole responsibility is to its Client and this document does not exonerate parties to a transaction from exercising all their rights and obligations under the transaction documents. This document cannot be reproduced except in full, without prior written approval of the Company. Any unauthorized alteration, forgery or falsification of the content or appearance of this document is unlawful and offenders may be prosecuted to the fullest extent of the law.

RADIATED EMISSION TEST (BELOW 1 GHz)						
MODE	FREQUENCY BAND (MHz)	AVAILABLE	TESTED	MODULATION	DATA RATE	ANTENNA
		CHANNEL	CHANNEL		(Mbps)	PORT
802.11a	5180~5240	36 to 48	44	OFDM	6	ch0
	5260~5320	52 to 64	60			
	5500~5720	100 to 144	116			
	5745~5825	149 to 165	157			
802.11ac_VHT80	5210	42	42	OFDM	VHT0	MIMO
	5290	58	58			
	5530~5610	106 to 122	106			
	5775	155	155			

RADIATED EMISSION TEST (ABOVE 1 GHz)						
MODE	FREQUENCY BAND (MHz)	AVAILABLE	TESTED	MODULATION	DATA RATE	ANTENNA
		CHANNEL	CHANNEL		(Mbps)	PORT
802.11a	5180~5240	36 to 48	36,44,48	OFDM	6	ch0
	5260~5320	52 to 64	52,60,64			
	5500~5720	100 to 144	100,116,140,144			
	5745~5825	149 to 165	149,157,165			
802.11ac_VHT20	5180~5240	36 to 48	36,44,48	OFDM	VHT0	MIMO
	5260~5320	52 to 64	52,60,64			
	5500~5720	100 to 144	100,116,140,144			
	5745~5825	149 to 165	149,157,165			
802.11ac_VHT40	5190~5230	38 to 46	38,46	OFDM	VHT0	MIMO
	5270~5310	54 to 62	54,62			
	5510~5670	102 to 134	102,110,134			
	5755~5795	151 to 159	151,159			
802.11ac_VHT80	5210	42	42	OFDM	VHT0	MIMO
	5290	58	58			
	5530~5610	106 to 122	106,122			
	5775	155	155			

Note:

The field strength of radiation emission was measured as EUT three orthogonal planes, E1 / E2 / H, are positioned to pre-scan the emission generating the highest one. The worst position is tested and recorded.

Unless otherwise stated the results shown in this test report refer only to the sample(s) tested and such sample(s) are retained for 90 days only.

除非另有說明，此報告結果僅對測試之樣品負責，同時此樣品僅保留90天。本報告未經本公司書面許可，不可部份複製。

This document is issued by the Company subject to its General Conditions of Service printed overleaf, available on request or accessible at <http://www.sgs.com.tw/Terms-and-Conditions> and for electronic format documents, subject to Terms and Conditions for Electronic Documents at <http://www.sgs.com.tw/Terms-and-Conditions>. Attention is drawn to the limitation of liability, indemnification and jurisdiction issues defined therein. Any holder of this document is advised that information contained hereon reflects the Company's findings at the time of its intervention only and within the limits of Client's instructions, if any. The Company's sole responsibility is to its Client and this document does not exonerate parties to a transaction from exercising all their rights and obligations under the transaction documents. This document cannot be reproduced except in full, without prior written approval of the Company. Any unauthorized alteration, forgery or falsification of the content or appearance of this document is unlawful and offenders may be prosecuted to the fullest extent of the law.

CONDUCTED TEST						
MODE	FREQUENCY BAND (MHz)	AVAILABLE CHANNEL	TESTED CHANNEL	MODULATION	DATA RATE	ANTENNA
					(Mbps)	PORT
802.11a	5180~5240	36 to 48	36,44,48	OFDM	6	ch0
	5260~5320	52 to 64	52,60,64			
	5500~5720	100 to 144	100,116,140,144			
	5745~5825	149 to 165	149,157,165			
802.11ac_VHT20	5180~5240	36 to 48	36,44,48	OFDM	VHT0	MIMO
	5260~5320	52 to 64	52,60,64			
	5500~5720	100 to 144	100,116,140,144			
	5745~5825	149 to 165	149,157,165			
802.11ac_VHT40	5190~5230	38 to 46	38,46	OFDM	VHT0	MIMO
	5270~5310	54 to 62	54,62			
	5510~5670	102 to 134	102,110,134			
	5755~5795	151 to 159	151,159			
802.11ac_VHT80	5210	42	42	OFDM	VHT0	MIMO
	5290	58	58			
	5530~5610	106 to 122	106,122			
	5775	155	155			

Unless otherwise stated the results shown in this test report refer only to the sample(s) tested and such sample(s) are retained for 90 days only.

除非另有說明，此報告結果僅對測試之樣品負責，同時此樣品僅保留90天。本報告未經本公司書面許可，不可部份複製。

This document is issued by the Company subject to its General Conditions of Service printed overleaf, available on request or accessible at <http://www.sgs.com.tw/Terms-and-Conditions> and for electronic format documents, subject to Terms and Conditions for Electronic Documents at <http://www.sgs.com.tw/Terms-and-Conditions>. Attention is drawn to the limitation of liability, indemnification and jurisdiction issues defined therein. Any holder of this document is advised that information contained hereon reflects the Company's findings at the time of its intervention only and within the limits of Client's instructions, if any. The Company's sole responsibility is to its Client and this document does not exonerate parties to a transaction from exercising all their rights and obligations under the transaction documents. This document cannot be reproduced except in full, without prior written approval of the Company. Any unauthorized alteration, forgery or falsification of the content or appearance of this document is unlawful and offenders may be prosecuted to the fullest extent of the law.

5 MEASUREMENT UNCERTAINTY

Test Items	Uncertainty
AC Power Line Conducted Emission	+/- 2.34 dB
Emission Bandwidth	+/- 1.53 Hz
The Maximum Output Power Measurement	+/- 1 dB
Peak Power Spectral Density Measurement	+/- 1.53 dB
Frequency Stability	+/- 1.53 Hz
Temperature	+/- 0.4 °C
Humidity	+/- 3.5 %
DC / AC Power Source	+/- 1 %

Radiated Spurious Emission Measurement Uncertainty			
Polarization: Vertical	+/-	2.64 dB	9kHz~30MHz
	+/-	4.93 dB	30MHz - 1000MHz
	+/-	4.81 dB	1GHz - 18GHz
	+/-	4.52 dB	18GHz - 40GHz
Polarization: Horizontal	+/-	2.64 dB	9kHz~30MHz
	+/-	4.45 dB	30MHz - 1000MHz
	+/-	4.81 dB	1GHz - 18GHz
	+/-	4.52 dB	18GHz - 40GHz

Note:

1. This uncertainty represents an expanded uncertainty expressed at approximately the 95% confidence level using a coverage factor of k=2.
2. The conformity assessment statement in this report is based solely on the test results, measurement uncertainty is excluded.

Unless otherwise stated the results shown in this test report refer only to the sample(s) tested and such sample(s) are retained for 90 days only.

除非另有說明，此報告結果僅對測試之樣品負責，同時此樣品僅保留90天。本報告未經本公司書面許可，不可部份複製。

This document is issued by the Company subject to its General Conditions of Service printed overleaf, available on request or accessible at <http://www.sgs.com.tw/Terms-and-Conditions> and for electronic format documents, subject to Terms and Conditions for Electronic Documents at <http://www.sgs.com.tw/Terms-and-Conditions>. Attention is drawn to the limitation of liability, indemnification and jurisdiction issues defined therein. Any holder of this document is advised that information contained hereon reflects the Company's findings at the time of its intervention only and within the limits of Client's instructions, if any. The Company's sole responsibility is to its Client and this document does not exonerate parties to a transaction from exercising all their rights and obligations under the transaction documents. This document cannot be reproduced except in full, without prior written approval of the Company. Any unauthorized alteration, forgery or falsification of the content or appearance of this document is unlawful and offenders may be prosecuted to the fullest extent of the law.

6 CONDUCTED EMISSION TEST

6.1 Standard Applicable

Frequency range within 150 kHz to 30 MHz shall not exceed the Limit table as below.

Frequency range MHz	Limits (dBuV)	
	Quasi-peak	Average
0.15 to 0.50	66 to 56	56 to 46
0.50 to 5	56	46
5 to 30	60	50

Note

- The lower limit shall apply at the transition frequencies
- The limit decreases linearly with the logarithm of the frequency in the range 0.15 MHz to 0.50 MHz.

6.2 Measurement Equipment Used

Radiated Emission Test Site: Conduction C					
EQUIPMENT TYPE	MFR	MODEL NUMBER	SERIAL NUMBER	LAST CAL.	CAL DUE.
Test Software	audix	e3	Ver. 6.11-20180419c	N.C.R	N.C.R
LISN	SCHWARZBECK Mess-Elektronik	NSLK8127	974	04/19/2021	04/18/2022
EMI Test Receiver	R&S	ESCI	101342	04/28/2021	04/27/2022
Coaxial Cable	EC Lab	RF-HY-CAB-250	RF-HY-CAB-250-01	03/27/2021	03/26/2022
Pulse Limiter	EC Lab	VTSD 9561F-N	485	03/27/2021	03/26/2022
Test Software	audix	e3	20923 sgs Ver.6	N.C.R	N.C.R

6.3 EUT Setup

- The conducted emission tests were performed in the test site, using the setup in accordance with the ANSI C63.10:2013.
- The AC/DC Power adaptor of EUT was plug-in LISN. The rear of the EUT and peripherals were placed flushed with the rear of the tabletop.
- The LISN was connected with 120Vac/60Hz power source.

Unless otherwise stated the results shown in this test report refer only to the sample(s) tested and such sample(s) are retained for 90 days only.

除非另有說明，此報告結果僅對測試之樣品負責，同時此樣品僅保留90天。本報告未經本公司書面許可，不可部份複製。

This document is issued by the Company subject to its General Conditions of Service printed overleaf, available on request or accessible at <http://www.sgs.com.tw/Terms-and-Conditions> and for electronic format documents, subject to Terms and Conditions for Electronic Documents at <http://www.sgs.com.tw/Terms-and-Conditions>. Attention is drawn to the limitation of liability, indemnification and jurisdiction issues defined therein. Any holder of this document is advised that information contained hereon reflects the Company's findings at the time of its intervention only and within the limits of Client's instructions, if any. The Company's sole responsibility is to its Client and this document does not exonerate parties to a transaction from exercising all their rights and obligations under the transaction documents. This document cannot be reproduced except in full, without prior written approval of the Company. Any unauthorized alteration, forgery or falsification of the content or appearance of this document is unlawful and offenders may be prosecuted to the fullest extent of the law.

6.4 Test SET-UP

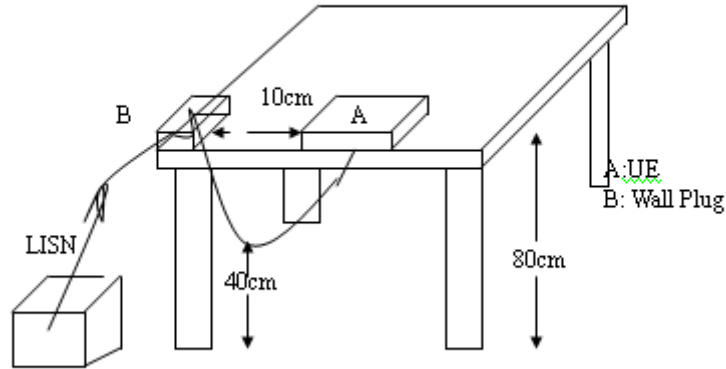

6.5 Measurement Procedure

1. The EUT was placed on a table which is 0.8m above ground plane.
2. Maximum procedure was performed on the six highest emissions to ensure EUT compliance.
3. Repeat above procedures until all phases of power being supplied by given UE are completed.

6.6 Measurement Result

Note: Refer to next page for measurement data and plots.

Note2: The * reveals the worst-case results that closet to the limit.

Unless otherwise stated the results shown in this test report refer only to the sample(s) tested and such sample(s) are retained for 90 days only.

除非另有說明，此報告結果僅對測試之樣品負責，同時此樣品僅保留90天。本報告未經本公司書面許可，不可部份複製。

This document is issued by the Company subject to its General Conditions of Service printed overleaf, available on request or accessible at <http://www.sgs.com.tw/Terms-and-Conditions> and for electronic format documents, subject to Terms and Conditions for Electronic Documents at <http://www.sgs.com.tw/Terms-and-Conditions>. Attention is drawn to the limitation of liability, indemnification and jurisdiction issues defined therein. Any holder of this document is advised that information contained hereon reflects the Company's findings at the time of its intervention only and within the limits of Client's instructions, if any. The Company's sole responsibility is to its Client and this document does not exonerate parties to a transaction from exercising all their rights and obligations under the transaction documents. This document cannot be reproduced except in full, without prior written approval of the Company. Any unauthorized alteration, forgery or falsification of the content or appearance of this document is unlawful and offenders may be prosecuted to the fullest extent of the law.

AC POWER LINE CONDUCTED EMISSION TEST DATA

Report Number	: E2/2021/70042	Test Site	: Conduction Room C
Test Mode	: 5G	Test Date	: 2021-07-27
Power	: 120V/60Hz	Temp./Humi.	: 24.4/55
Probe	: L1	Engineer	: Jack Tseng
Note:	: Adapter:FSP120-AABN3		

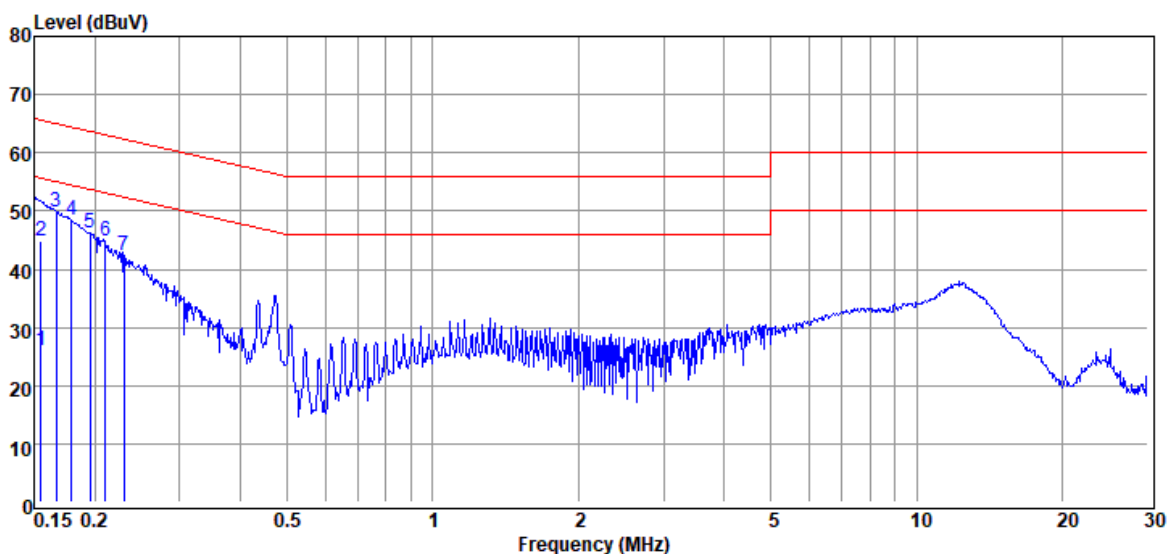

Freq. MHz	Detector Mode PK/QP/AV	Spectrum Reading Level dBuV	Factor dB	Actual FS dBuV	Limit dBuV	Margin dB
0.15	Average	15.70	10.30	26.00	55.74	-29.74
0.15	QP	34.60	10.30	44.90	65.74	-20.84
0.17	Peak	39.64	10.30	49.94	65.12	-15.18
0.18	Peak	38.08	10.30	48.38	64.50	-16.12
0.20	Peak	35.94	10.30	46.24	63.80	-17.56
0.21	Peak	34.47	10.30	44.77	63.18	-18.41
0.23	Peak	31.98	10.30	42.28	62.44	-20.16

Unless otherwise stated the results shown in this test report refer only to the sample(s) tested and such sample(s) are retained for 90 days only.

除非另有說明，此報告結果僅對測試之樣品負責，同時此樣品僅保留90天。本報告未經本公司書面許可，不可部份複製。

This document is issued by the Company subject to its General Conditions of Service printed overleaf, available on request or accessible at <http://www.sgs.com.tw/Terms-and-Conditions> and for electronic format documents, subject to Terms and Conditions for Electronic Documents at <http://www.sgs.com.tw/Terms-and-Conditions>. Attention is drawn to the limitation of liability, indemnification and jurisdiction issues defined therein. Any holder of this document is advised that information contained hereon reflects the Company's findings at the time of its intervention only and within the limits of Client's instructions, if any. The Company's sole responsibility is to its Client and this document does not exonerate parties to a transaction from exercising all their rights and obligations under the transaction documents. This document cannot be reproduced except in full, without prior written approval of the Company. Any unauthorized alteration, forgery or falsification of the content or appearance of this document is unlawful and offenders may be prosecuted to the fullest extent of the law.

Report Number	: E2/2021/70042	Test Site	: Conduction Room C
Test Mode	: 5G	Test Date	: 2021-07-27
Power	: 120V/60Hz	Temp./Humi.	: 24.4/55
Probe	: N	Engineer	: Jack Tseng
Note:	: Adapter:FSP120-AABN3		

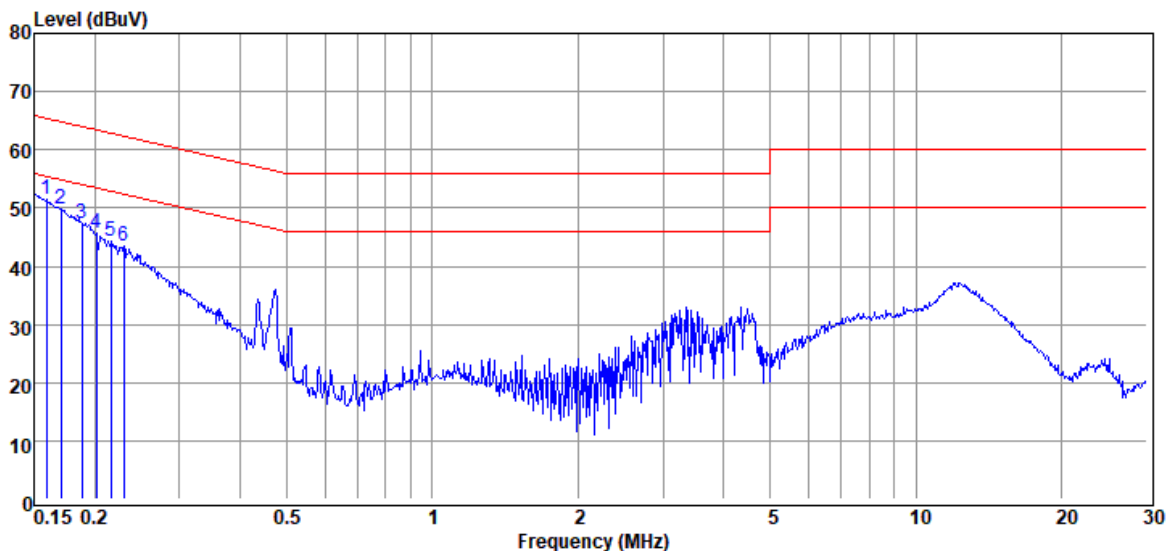

Freq. MHz	Detector Mode PK/QP/AV	Spectrum Reading Level dB μ V	Factor dB	Actual FS dB μ V	Limit dB μ V	Margin dB
0.16	Peak	41.09	10.31	51.40	65.52	-14.12
0.17	Peak	39.45	10.31	49.76	64.94	-15.18
0.19	Peak	37.06	10.30	47.36	64.11	-16.75
0.20	Peak	35.30	10.30	45.60	63.54	-17.94
0.22	Peak	34.08	10.30	44.38	62.96	-18.58
0.23	Peak	33.10	10.30	43.40	62.44	-19.04

Unless otherwise stated the results shown in this test report refer only to the sample(s) tested and such sample(s) are retained for 90 days only.

除非另有說明，此報告結果僅對測試之樣品負責，同時此樣品僅保留90天。本報告未經本公司書面許可，不可部份複製。

This document is issued by the Company subject to its General Conditions of Service printed overleaf, available on request or accessible at <http://www.sgs.com.tw/Terms-and-Conditions> and for electronic format documents, subject to Terms and Conditions for Electronic Documents at <http://www.sgs.com.tw/Terms-and-Conditions>. Attention is drawn to the limitation of liability, indemnification and jurisdiction issues defined therein. Any holder of this document is advised that information contained hereon reflects the Company's findings at the time of its intervention only and within the limits of Client's instructions, if any. The Company's sole responsibility is to its Client and this document does not exonerate parties to a transaction from exercising all their rights and obligations under the transaction documents. This document cannot be reproduced except in full, without prior written approval of the Company. Any unauthorized alteration, forgery or falsification of the content or appearance of this document is unlawful and offenders may be prosecuted to the fullest extent of the law.

7 DUTY CYCLE TEST SIGNAL

Pre-analysis Check: While conducting average power measurement, duty cycle of each mode shall be checked to ensure its duty cycle in order to compensate for the loss due to insufficient ratio of duty cycle.

All duty cycle is pre-scanned, and result as obtained below shows only the most representative ones where duty cycle is conducted as the given transmission with given virtual operation that expresses the percentage.

7.1 Measurement Procedure:

1. Set span = Zero
2. RBW = 8MHz
3. VBW = 8MHz,
4. Detector = Peak

Duty Cycle:

Mode	Duty Cycle (%) =Ton / (Ton+Toff)	Duty Factor (dB) =10*log (1/Duty Cycle)	1/T (kHz)	VBW setting (kHz)
802.11a	98.28	0.08	0.48	0.01
802.11n_20	98.06	0.09	0.52	0.01
802.11ac_20	98.14	0.08	0.52	0.01
802.11n_40	96.34	0.16	1.05	2.00
802.11ac_40	96.35	0.16	1.05	2.00
802.11ac_80	92.80	0.32	2.16	3.00

Unless otherwise stated the results shown in this test report refer only to the sample(s) tested and such sample(s) are retained for 90 days only.

除非另有說明，此報告結果僅對測試之樣品負責，同時此樣品僅保留90天。本報告未經本公司書面許可，不可部份複製。

This document is issued by the Company subject to its General Conditions of Service printed overleaf, available on request or accessible at <http://www.sgs.com.tw/Terms-and-Conditions> and for electronic format documents, subject to Terms and Conditions for Electronic Documents at <http://www.sgs.com.tw/Terms-and-Conditions>. Attention is drawn to the limitation of liability, indemnification and jurisdiction issues defined therein. Any holder of this document is advised that information contained hereon reflects the Company's findings at the time of its intervention only and within the limits of Client's instructions, if any. The Company's sole responsibility is to its Client and this document does not exonerate parties to a transaction from exercising all their rights and obligations under the transaction documents. This document cannot be reproduced except in full, without prior written approval of the Company. Any unauthorized alteration, forgery or falsification of the content or appearance of this document is unlawful and offenders may be prosecuted to the fullest extent of the law.

7.2 DUTY CYCLE TEST SIGNAL MEASUREMENT RESULT

802.11a_20MHz_Chain0_5180MHz

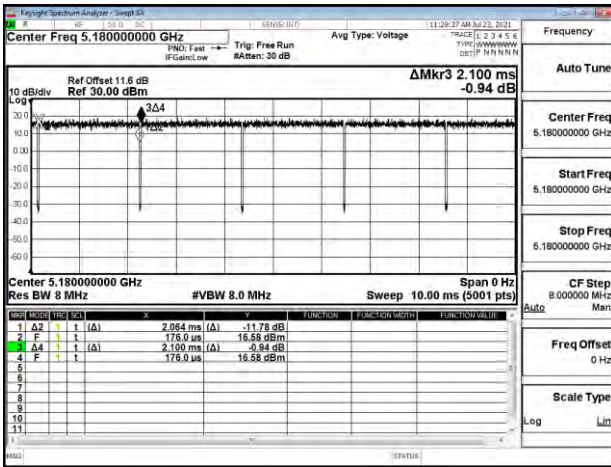

802.11ac_20MHz_Chain0_5180MHz

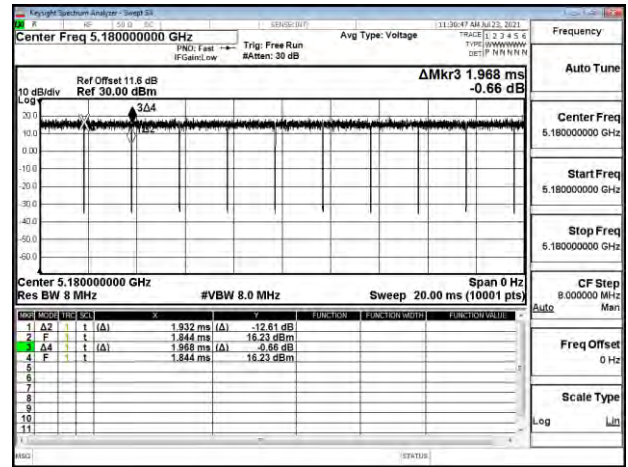

802.11n_20MHz_Chain0_5180MHz

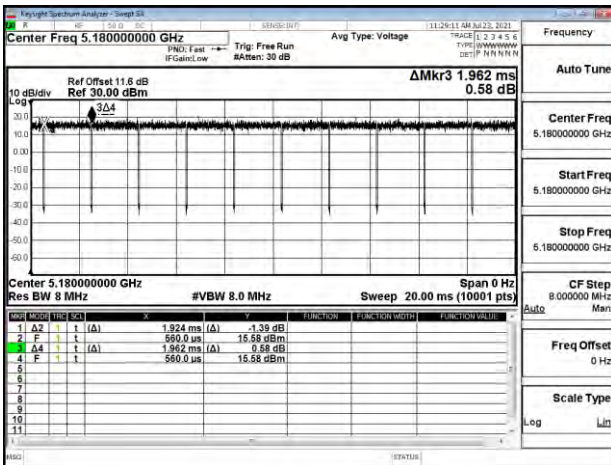

802.11ac_40MHz_Chain0_5190MHz

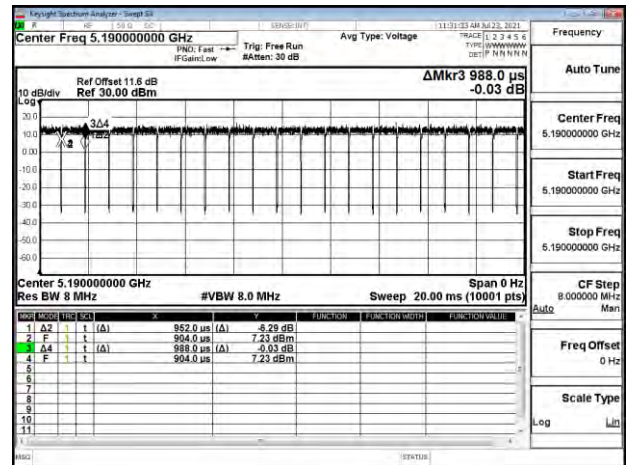

802.11n_40MHz_Chain0_5190MHz

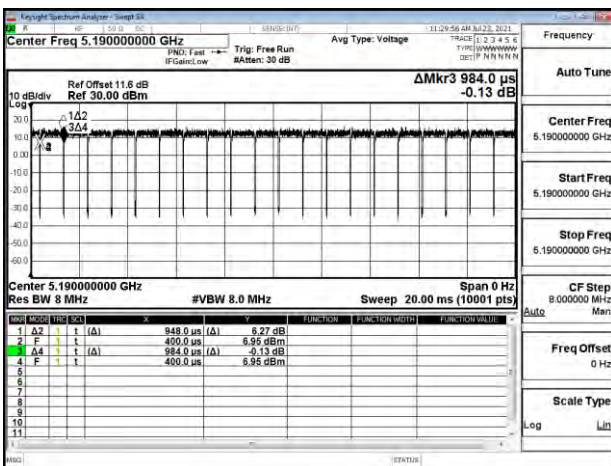

802.11ac_80MHz_Chain0_5210MHz

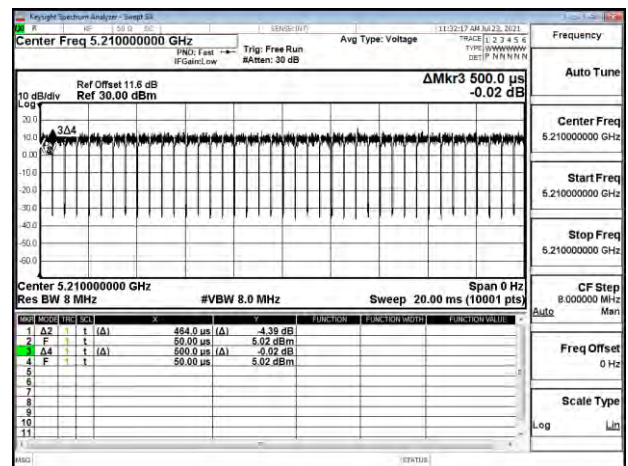

Unless otherwise stated the results shown in this test report refer only to the sample(s) tested and such sample(s) are retained for 90 days only.

除非另有說明，此報告結果僅對測試之樣品負責，同時此樣品僅保留90天。本報告未經本公司書面許可，不可部份複製。

This document is issued by the Company subject to its General Conditions of Service printed overleaf, available on request or accessible at <http://www.sgs.com.tw/Terms-and-Conditions> and for electronic format documents, subject to Terms and Conditions for Electronic Documents at <http://www.sgs.com.tw/Terms-and-Conditions>. Attention is drawn to the limitation of liability, indemnification and jurisdiction issues defined therein. Any holder of this document is advised that information contained herein reflects the Company's findings at the time of its intervention only and within the limits of Client's instructions, if any. The Company's sole responsibility is to its Client and this document does not exonerate parties to a transaction from exercising all their rights and obligations under the transaction documents. This document cannot be reproduced except in full, without prior written approval of the Company. Any unauthorized alteration, forgery or falsification of the content or appearance of this document is unlawful and offenders may be prosecuted to the fullest extent of the law.

8 EMISSION BANDWIDTH MEASUREMENT

8.1 Standard Applicable

There is no limit bandwidth for U-NII-1, U-NII-2-A and U-NII-2-C.
The minimum of 6dB Bandwidth measurement is 0.5 MHz for U-NII-3

8.2 Measurement Procedure

1. Place the EUT on the table and set it in transmitting mode.
2. The testing follows FCC KDB 789033 D02 General UNII Test Procedures New Rules.
3. Remove the antenna from the EUT and then connect a low loss RF cable from the Antenna port to the spectrum analyzer.
 - 3.a. 26dB Band width Measurement: Set the spectrum analyzer as 1% of emission BW
Sweep=auto,
Detector = Peak,
Trace Mode = Max Hold,
Manually readjust RBW until the RBW/EBW ratio is 1% based on EBW as observed on the result of pre-sequence measurement.
 - 3.b. Mark the peak frequency and -26dB (upper and lower) frequency.
4. Repeat the procedures as list above until all test default channels (low, middle, and high) are completed.
5. Minimum Emission Bandwidth for the band 5.725-5.850GHz.
 - a. Set the spectrum analyzer as
RBW = 100 kHz,
VBW = 3*RBW,
Span = large enough to capture all products of the modulation process,
Detector=Peak,
Sweep=auto
 - b. Mark the peak frequency and -6dB (upper and lower) frequency.
6. Repeat above procedures until all frequency of interest measured was complete.

Unless otherwise stated the results shown in this test report refer only to the sample(s) tested and such sample(s) are retained for 90 days only.
除非另有說明，此報告結果僅對測試之樣品負責，同時此樣品僅保留90天。本報告未經本公司書面許可，不可部份複製。

This document is issued by the Company subject to its General Conditions of Service printed overleaf, available on request or accessible at <http://www.sgs.com.tw/Terms-and-Conditions> and for electronic format documents, subject to Terms and Conditions for Electronic Documents at <http://www.sgs.com.tw/Terms-and-Conditions>. Attention is drawn to the limitation of liability, indemnification and jurisdiction issues defined therein. Any holder of this document is advised that information contained hereon reflects the Company's findings at the time of its intervention only and within the limits of Client's instructions, if any. The Company's sole responsibility is to its Client and this document does not exonerate parties to a transaction from exercising all their rights and obligations under the transaction documents. This document cannot be reproduced except in full, without prior written approval of the Company. Any unauthorized alteration, forgery or falsification of the content or appearance of this document is unlawful and offenders may be prosecuted to the fullest extent of the law.

8.3 Measurement Equipment Used

Conducted Emission Test Site: Conducted G					
EQUIPMENT TYPE	MFR	MODEL NUMBER	SERIAL NUMBER	LAST CAL.	CAL DUE.
Spectrum Analyzer	KEYSIGHT	N9010A	MY57120290	04/06/2021	04/05/2022
Attenuator	Marvelous	MVE2213-10	RF09	11/19/2020	11/18/2021
DC Block	PASTERNAK	PE8210	RF151	11/19/2020	11/18/2021
Coaxial Cables	Woken	00100A1F2A196C	RF59	11/19/2020	11/18/2021
Coaxial Cables	Woken	00100A1F2A196C	RF68	11/19/2020	11/18/2021
Test Software	SGS Taiwan	Radio Test Software	Ver.21	N/A	N/A

8.4 Test Set-up

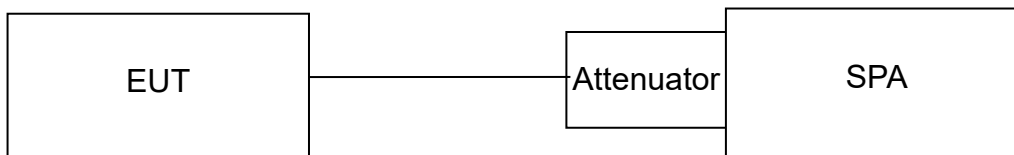

Unless otherwise stated the results shown in this test report refer only to the sample(s) tested and such sample(s) are retained for 90 days only.

除非另有說明，此報告結果僅對測試之樣品負責，同時此樣品僅保留90天。本報告未經本公司書面許可，不可部份複製。

This document is issued by the Company subject to its General Conditions of Service printed overleaf, available on request or accessible at <http://www.sgs.com.tw/Terms-and-Conditions> and for electronic format documents, subject to Terms and Conditions for Electronic Documents at <http://www.sgs.com.tw/Terms-and-Conditions>. Attention is drawn to the limitation of liability, indemnification and jurisdiction issues defined therein. Any holder of this document is advised that information contained hereon reflects the Company's findings at the time of its intervention only and within the limits of Client's instructions, if any. The Company's sole responsibility is to its Client and this document does not exonerate parties to a transaction from exercising all their rights and obligations under the transaction documents. This document cannot be reproduced except in full, without prior written approval of the Company. Any unauthorized alteration, forgery or falsification of the content or appearance of this document is unlawful and offenders may be prosecuted to the fullest extent of the law.

8.5 Measurement Result

8.5.1 FCC Occupied Bandwidth

802.11a_Ch0		
Freq. (MHz)	26dB BW (MHz)	10 Log (B) (dB)
5180	22.65	13.550
5220	23.23	13.660
5240	22.79	13.580
5260	23.75	13.760
5300	21.87	13.400
5320	21.69	13.360
5500	22.18	13.460
5580	21.81	13.390
5700	22.24	13.470
5720(U-NII 2C)	16.48	12.170
5720(U-NII 3)	6.48	8.110
802.11a_Ch0		
Freq. (MHz)	6dB BW (MHz)	10 Log (B) (dB)
5745	16.31	12.120
5785	15.49	11.900
5825	15.40	11.880
802.11a_Ch0		
Freq. (MHz)	Measured Freq. (MHz)	Limit (MHz)
5240	5248.37	< 5250
5745	5736.82	> 5725

Unless otherwise stated the results shown in this test report refer only to the sample(s) tested and such sample(s) are retained for 90 days only.

除非另有說明，此報告結果僅對測試之樣品負責，同時此樣品僅保留90天。本報告未經本公司書面許可，不可部份複製。

This document is issued by the Company subject to its General Conditions of Service printed overleaf, available on request or accessible at <http://www.sgs.com.tw/Terms-and-Conditions> and for electronic format documents, subject to Terms and Conditions for Electronic Documents at <http://www.sgs.com.tw/Terms-and-Conditions>. Attention is drawn to the limitation of liability, indemnification and jurisdiction issues defined therein. Any holder of this document is advised that information contained hereon reflects the Company's findings at the time of its intervention only and within the limits of Client's instructions, if any. The Company's sole responsibility is to its Client and this document does not exonerate parties to a transaction from exercising all their rights and obligations under the transaction documents. This document cannot be reproduced except in full, without prior written approval of the Company. Any unauthorized alteration, forgery or falsification of the content or appearance of this document is unlawful and offenders may be prosecuted to the fullest extent of the law.

802.11ac_VHT20_Ch0			802.11ac_VHT20_Ch1		
Freq. (MHz)	26dB BW (MHz)	10 Log (B) (dB)	Freq. (MHz)	26dB BW (MHz)	10 Log (B) (dB)
5180	22.89	13.600	5180	23.13	13.640
5220	23.56	13.720	5220	23.21	13.660
5240	22.97	13.610	5240	24.82	13.950
5260	23.03	13.620	5260	21.66	13.360
5300	22.34	13.490	5300	23.04	13.620
5320	22.00	13.420	5320	22.88	13.590
5500	23.08	13.630	5500	22.82	13.580
5580	23.31	13.680	5580	21.63	13.350
5700	24.15	13.830	5700	22.75	13.570
5720(U-NII 2C)	16.81	12.260	5720(U-NII 2C)	16.85	12.260
5720(U-NII 3)	6.81	8.330	5720(U-NII 3)	6.85	8.350
802.11ac_VHT20_Ch0			802.11ac_VHT20_Ch1		
Freq. (MHz)	6dB BW (MHz)	10 Log (B) (dB)	Freq. (MHz)	6dB BW (MHz)	10 Log (B) (dB)
5745	15.74	11.970	5745	17.62	12.460
5785	17.72	12.480	5785	17.18	12.350
5825	17.18	12.350	5825	17.59	12.450
802.11ac_VHT20_Ch0			802.11ac_VHT20_Ch1		
Freq. (MHz)	Measured Freq. (MHz)	Limit (MHz)	Freq. (MHz)	Measured Freq. (MHz)	Limit (MHz)
5240	5248.94	< 5250	5240	5248.96	< 5250
5745	5736.22	> 5725	5745	5736.20	> 5725

Unless otherwise stated the results shown in this test report refer only to the sample(s) tested and such sample(s) are retained for 90 days only.

除非另有說明，此報告結果僅對測試之樣品負責，同時此樣品僅保留90天。本報告未經本公司書面許可，不可部份複製。

This document is issued by the Company subject to its General Conditions of Service printed overleaf, available on request or accessible at <http://www.sgs.com.tw/Terms-and-Conditions> and for electronic format documents, subject to Terms and Conditions for Electronic Documents at <http://www.sgs.com.tw/Terms-and-Conditions>. Attention is drawn to the limitation of liability, indemnification and jurisdiction issues defined therein. Any holder of this document is advised that information contained hereon reflects the Company's findings at the time of its intervention only and within the limits of Client's instructions, if any. The Company's sole responsibility is to its Client and this document does not exonerate parties to a transaction from exercising all their rights and obligations under the transaction documents. This document cannot be reproduced except in full, without prior written approval of the Company. Any unauthorized alteration, forgery or falsification of the content or appearance of this document is unlawful and offenders may be prosecuted to the fullest extent of the law.

802.11ac_VHT40_Ch0			802.11ac_VHT40_Ch1		
Freq. (MHz)	26dB BW (MHz)	10 Log (B) (dB)	Freq. (MHz)	26dB BW (MHz)	10 Log (B) (dB)
5190	41.24	16.150	5190	40.99	16.130
5230	40.80	16.110	5230	40.79	16.110
5270	40.92	16.120	5270	40.79	16.110
5310	41.01	16.130	5310	40.36	16.060
5510	40.90	16.120	5510	40.92	16.120
5550	41.24	16.150	5550	41.00	16.130
5670	41.07	16.140	5670	40.68	16.090

802.11ac_VHT40_Ch0			802.11ac_VHT40_Ch1		
Freq. (MHz)	6dB BW (MHz)	10 Log (B) (dB)	Freq. (MHz)	6dB BW (MHz)	10 Log (B) (dB)
5755	34.55	15.380	5755	35.45	15.500
5795	36.05	15.570	5795	35.44	15.490

802.11ac_VHT40_Ch0			802.11ac_VHT40_Ch1		
Freq. (MHz)	Measured Freq. (MHz)	Limit (MHz)	Freq. (MHz)	Measured Freq. (MHz)	Limit (MHz)
5230	5248.18	< 5250	5230	5248.10	< 5250
5755	5737.00	> 5725	5755	5737.01	> 5725

Unless otherwise stated the results shown in this test report refer only to the sample(s) tested and such sample(s) are retained for 90 days only.

除非另有說明，此報告結果僅對測試之樣品負責，同時此樣品僅保留90天。本報告未經本公司書面許可，不可部份複製。

This document is issued by the Company subject to its General Conditions of Service printed overleaf, available on request or accessible at <http://www.sgs.com.tw/Terms-and-Conditions> and for electronic format documents, subject to Terms and Conditions for Electronic Documents at <http://www.sgs.com.tw/Terms-and-Conditions>. Attention is drawn to the limitation of liability, indemnification and jurisdiction issues defined therein. Any holder of this document is advised that information contained hereon reflects the Company's findings at the time of its intervention only and within the limits of Client's instructions, if any. The Company's sole responsibility is to its Client and this document does not exonerate parties to a transaction from exercising all their rights and obligations under the transaction documents. This document cannot be reproduced except in full, without prior written approval of the Company. Any unauthorized alteration, forgery or falsification of the content or appearance of this document is unlawful and offenders may be prosecuted to the fullest extent of the law.

802.11ac_VHT80_Ch0			802.11ac_VHT80_Ch1		
Freq. (MHz)	26dB BW (MHz)	10 Log (B) (dB)	Freq. (MHz)	26dB BW (MHz)	10 Log (B) (dB)
5210	82.19	19.150	5210	81.94	19.130
5290	83.24	19.200	5290	82.30	19.150
5530	81.37	19.100	5530	82.53	19.170
5610	82.07	19.140	5610	83.43	19.210

802.11ac_VHT80_Ch0			802.11ac_VHT80_Ch1		
Freq. (MHz)	6dB BW (MHz)	10 Log (B) (dB)	Freq. (MHz)	6dB BW (MHz)	10 Log (B) (dB)
5775	75.25	18.770	5775	74.12	18.700

802.11ac_VHT80_Ch0			802.11ac_VHT80_Ch1		
Freq. (MHz)	Measured Freq. (MHz)	Limit (MHz)	Freq. (MHz)	Measured Freq. (MHz)	Limit (MHz)
5210	5248.07	< 5250	5210	5248.08	< 5250
5775	5737.41	> 5725	5775	5737.37	> 5725

Unless otherwise stated the results shown in this test report refer only to the sample(s) tested and such sample(s) are retained for 90 days only.

除非另有說明，此報告結果僅對測試之樣品負責，同時此樣品僅保留90天。本報告未經本公司書面許可，不可部份複製。

This document is issued by the Company subject to its General Conditions of Service printed overleaf, available on request or accessible at <http://www.sgs.com.tw/Terms-and-Conditions> and for electronic format documents, subject to Terms and Conditions for Electronic Documents at <http://www.sgs.com.tw/Terms-and-Conditions>. Attention is drawn to the limitation of liability, indemnification and jurisdiction issues defined therein. Any holder of this document is advised that information contained hereon reflects the Company's findings at the time of its intervention only and within the limits of Client's instructions, if any. The Company's sole responsibility is to its Client and this document does not exonerate parties to a transaction from exercising all their rights and obligations under the transaction documents. This document cannot be reproduced except in full, without prior written approval of the Company. Any unauthorized alteration, forgery or falsification of the content or appearance of this document is unlawful and offenders may be prosecuted to the fullest extent of the law.

802.11a_20MHz_Chain0_5180MHz

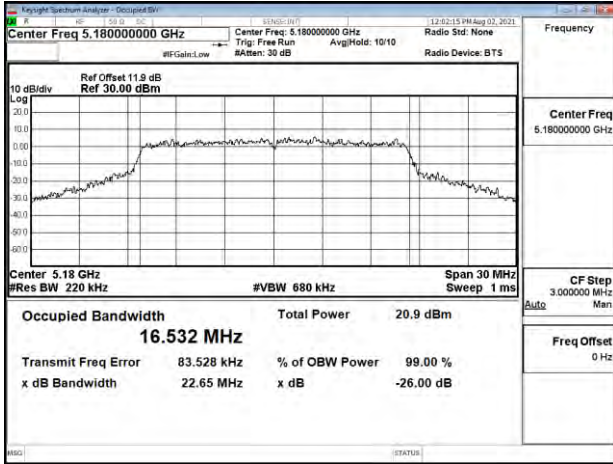

802.11a_20MHz_Chain0_5260MHz

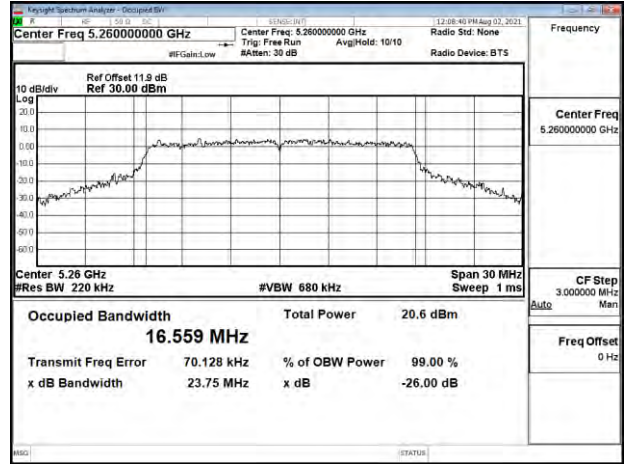

802.11a_20MHz_Chain0_5220MHz

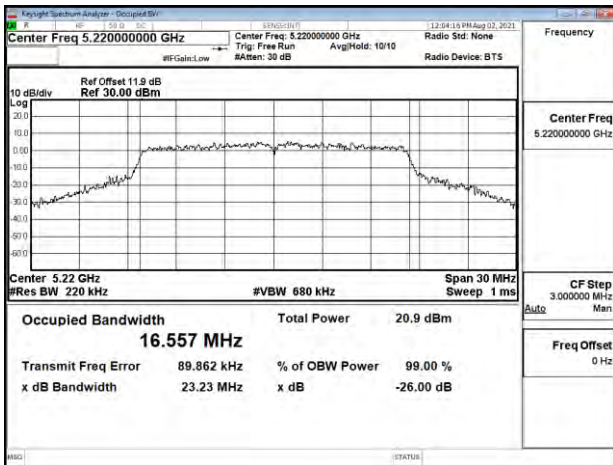

802.11a_20MHz_Chain0_5300MHz

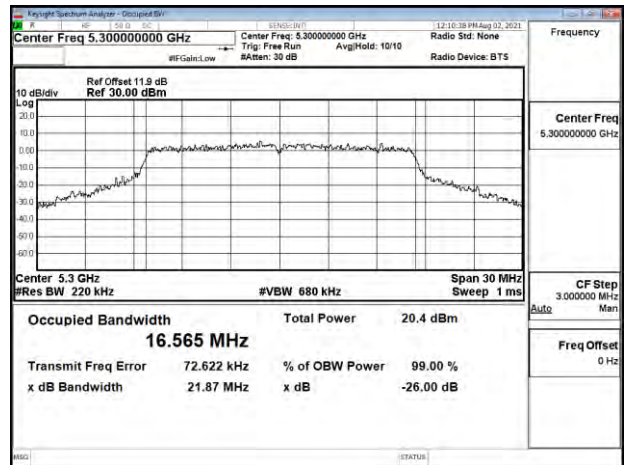

802.11a_20MHz_Chain0_5240MHz

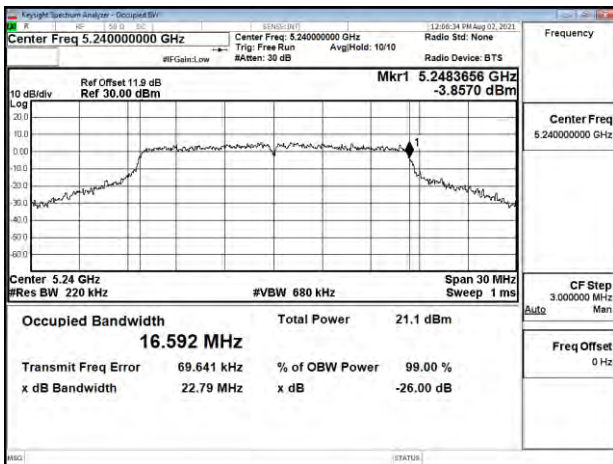

802.11a_20MHz_Chain0_5320MHz

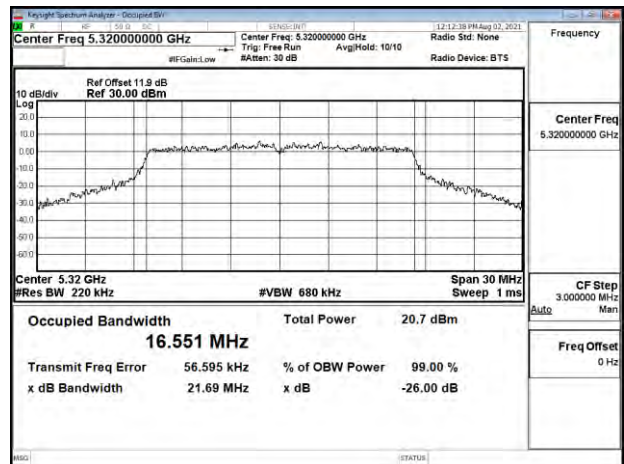

Unless otherwise stated the results shown in this test report refer only to the sample(s) tested and such sample(s) are retained for 90 days only.

除非另有說明，此報告結果僅對測試之樣品負責，同時此樣品僅保留90天。本報告未經本公司書面許可，不可部份複製。

This document is issued by the Company subject to its General Conditions of Service printed overleaf, available on request or accessible at <http://www.sgs.com.tw/Terms-and-Conditions> and for electronic format documents, subject to Terms and Conditions for Electronic Documents at <http://www.sgs.com.tw/Terms-and-Conditions>. Attention is drawn to the limitation of liability, indemnification and jurisdiction issues defined therein. Any holder of this document is advised that information contained herein reflects the Company's findings at the time of its intervention only and within the limits of Client's instructions, if any. The Company's sole responsibility is to its Client and this document does not exonerate parties to a transaction from exercising all their rights and obligations under the transaction documents. This document cannot be reproduced except in full, without prior written approval of the Company. Any unauthorized alteration, forgery or falsification of the content or appearance of this document is unlawful and offenders may be prosecuted to the fullest extent of the law.

802.11a_20MHz_Chain0_5500MHz

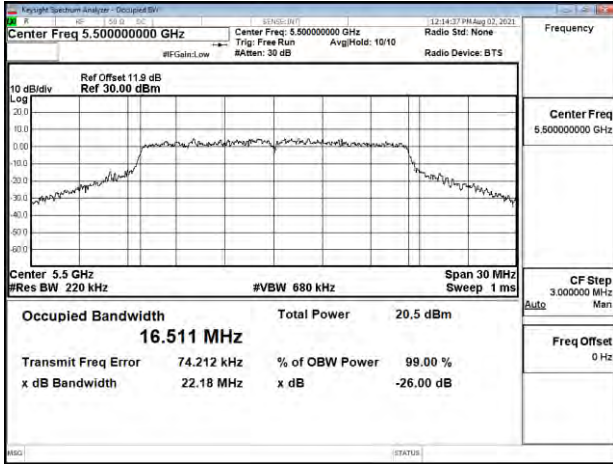

802.11a_20MHz_Chain0_5720MHz

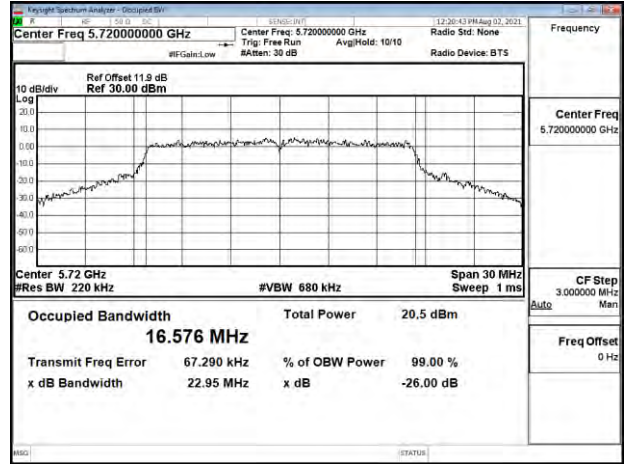

802.11a_20MHz_Chain0_5580MHz

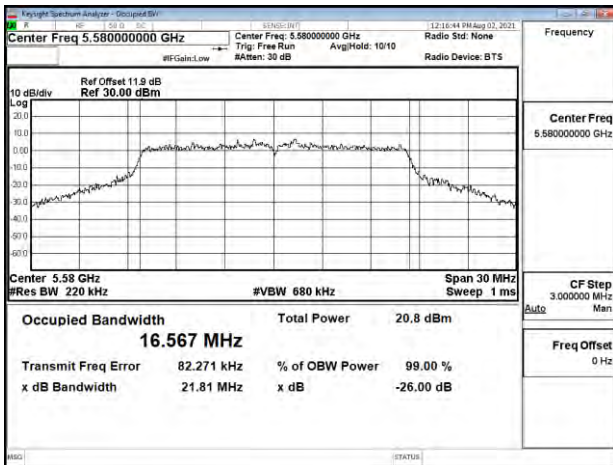

802.11a_20MHz_Chain0_5745MHz

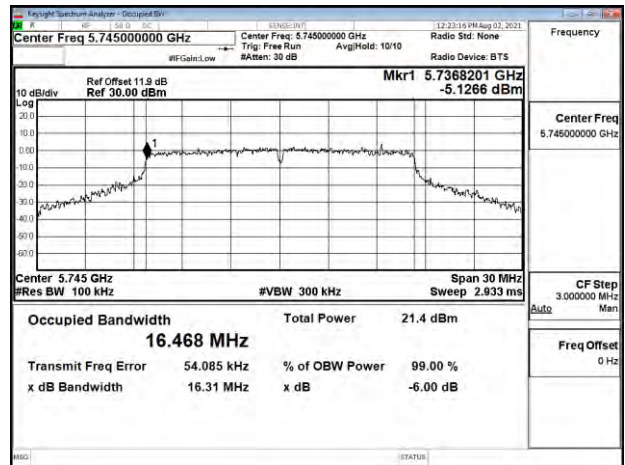

802.11a_20MHz_Chain0_5700MHz

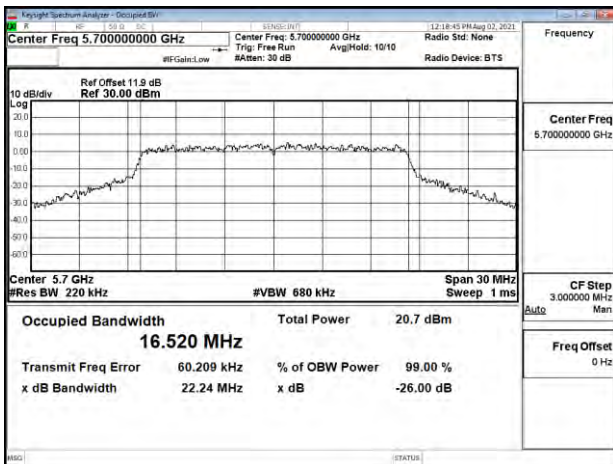

802.11a_20MHz_Chain0_5785MHz

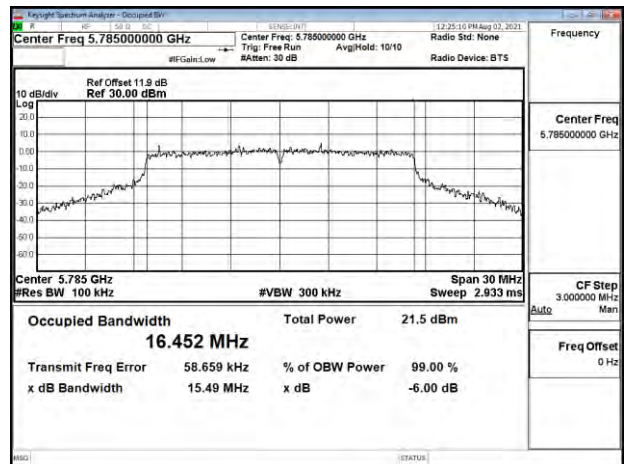

Unless otherwise stated the results shown in this test report refer only to the sample(s) tested and such sample(s) are retained for 90 days only.

除非另有說明，此報告結果僅對測試之樣品負責，同時此樣品僅保留90天。本報告未經本公司書面許可，不可部份複製。

This document is issued by the Company subject to its General Conditions of Service printed overleaf, available on request or accessible at <http://www.sgs.com.tw/Terms-and-Conditions> and for electronic format documents, subject to Terms and Conditions for Electronic Documents at <http://www.sgs.com.tw/Terms-and-Conditions>. Attention is drawn to the limitation of liability, indemnification and jurisdiction issues defined therein. Any holder of this document is advised that information contained hereon reflects the Company's findings at the time of its intervention only and within the limits of Client's instructions, if any. The Company's sole responsibility is to its Client and this document does not exonerate parties to a transaction from exercising all their rights and obligations under the transaction documents. This document cannot be reproduced except in full, without prior written approval of the Company. Any unauthorized alteration, forgery or falsification of the content or appearance of this document is unlawful and offenders may be prosecuted to the fullest extent of the law.

802.11a_20MHz_Chain0_5825MHz

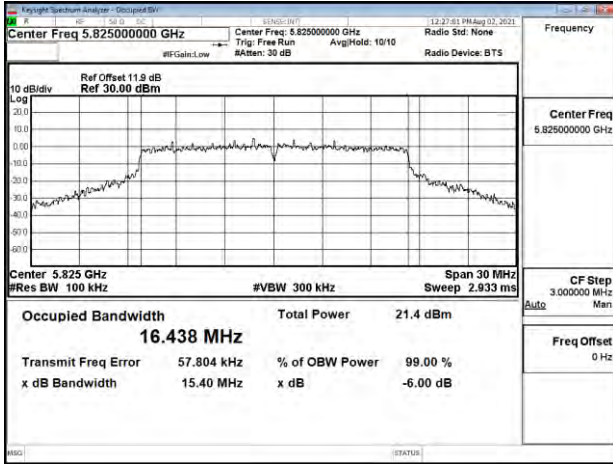

802.11ac_20MHz_Chain0_5240MHz

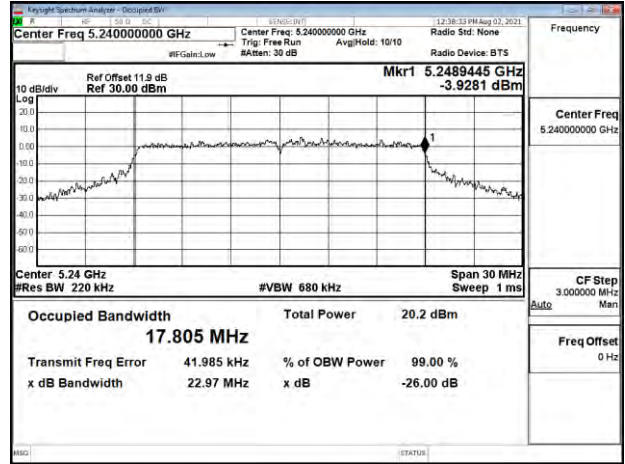

802.11ac_20MHz_Chain0_5180MHz

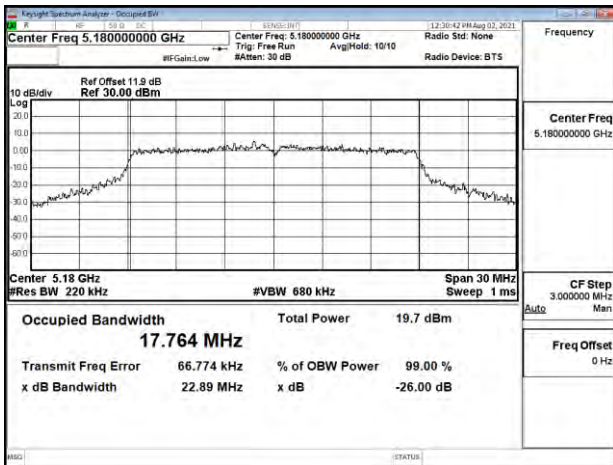

802.11ac_20MHz_Chain0_5260MHz

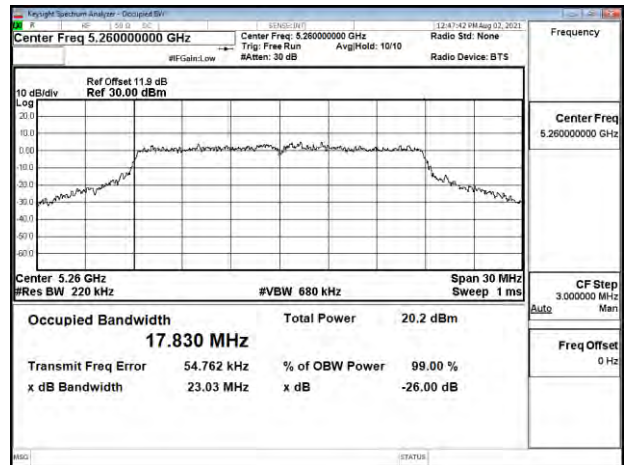

802.11ac_20MHz_Chain0_5220MHz

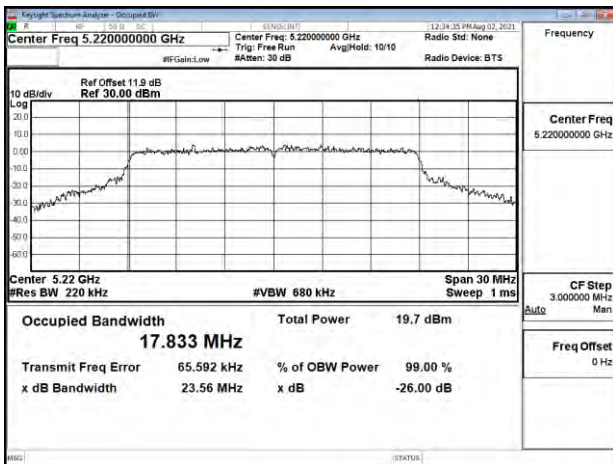

802.11ac_20MHz_Chain0_5300MHz

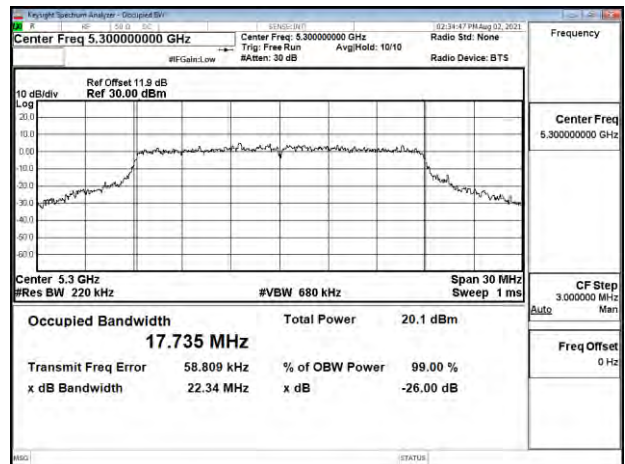

Unless otherwise stated the results shown in this test report refer only to the sample(s) tested and such sample(s) are retained for 90 days only.

除非另有說明，此報告結果僅對測試之樣品負責，同時此樣品僅保留90天。本報告未經本公司書面許可，不可部份複製。

This document is issued by the Company subject to its General Conditions of Service printed overleaf, available on request or accessible at <http://www.sgs.com.tw/Terms-and-Conditions> and for electronic format documents, subject to Terms and Conditions for Electronic Documents at <http://www.sgs.com.tw/Terms-and-Conditions>. Attention is drawn to the limitation of liability, indemnification and jurisdiction issues defined therein. Any holder of this document is advised that information contained herein reflects the Company's findings at the time of its intervention only and within the limits of Client's instructions, if any. The Company's sole responsibility is to its Client and this document does not exonerate parties to a transaction from exercising all their rights and obligations under the transaction documents. This document cannot be reproduced except in full, without prior written approval of the Company. Any unauthorized alteration, forgery or falsification of the content or appearance of this document is unlawful and offenders may be prosecuted to the fullest extent of the law.

802.11ac_20MHz_Chain0_5320MHz

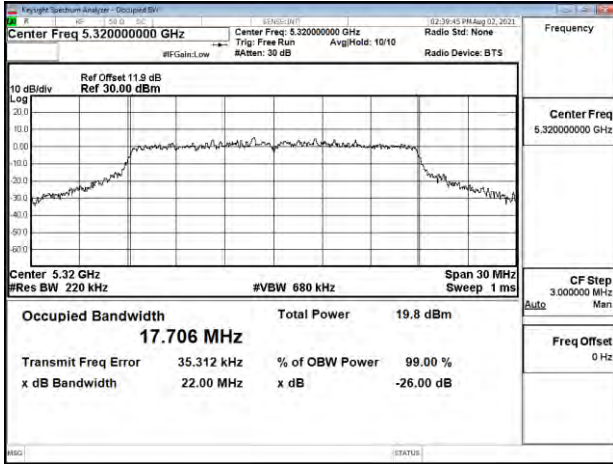

802.11ac_20MHz_Chain0_5700MHz

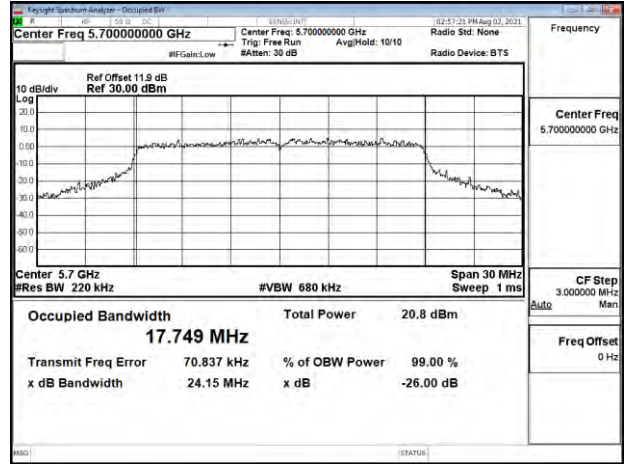

802.11ac_20MHz_Chain0_5500MHz

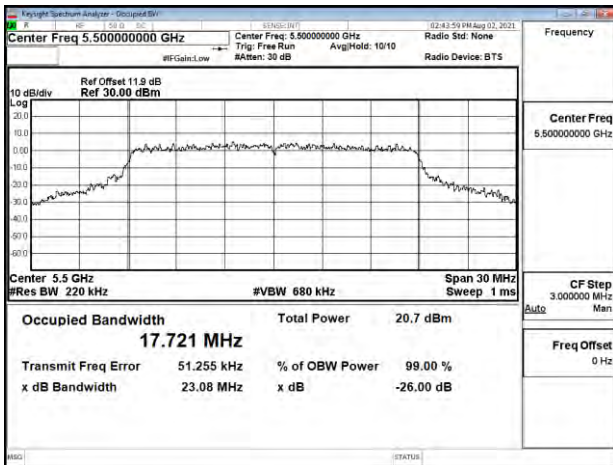

802.11ac_20MHz_Chain0_5720MHz

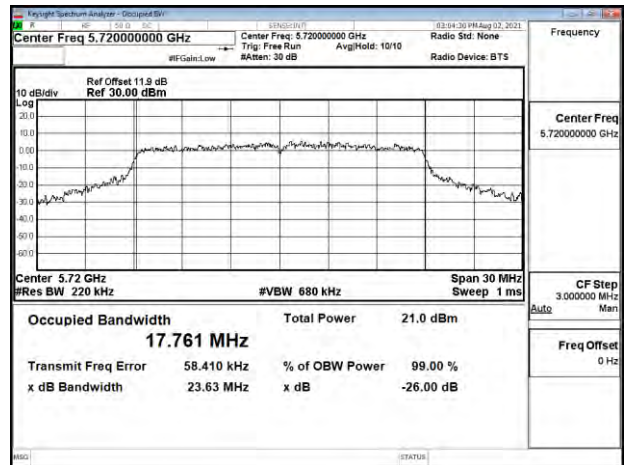

802.11ac_20MHz_Chain0_5580MHz

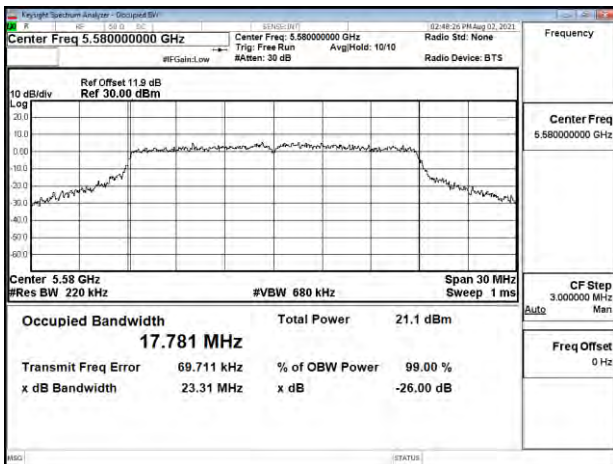

802.11ac_20MHz_Chain0_5745MHz

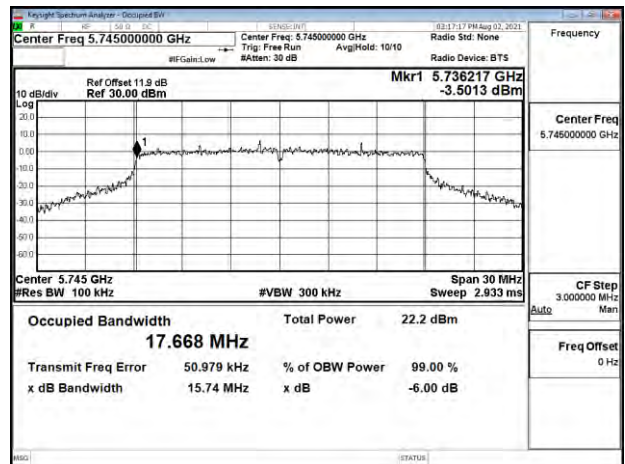

Unless otherwise stated the results shown in this test report refer only to the sample(s) tested and such sample(s) are retained for 90 days only.

除非另有說明，此報告結果僅對測試之樣品負責，同時此樣品僅保留90天。本報告未經本公司書面許可，不可部份複製。

This document is issued by the Company subject to its General Conditions of Service printed overleaf, available on request or accessible at <http://www.sgs.com.tw/Terms-and-Conditions> and for electronic format documents, subject to Terms and Conditions for Electronic Documents at <http://www.sgs.com.tw/Terms-and-Conditions>. Attention is drawn to the limitation of liability, indemnification and jurisdiction issues defined therein. Any holder of this document is advised that information contained herein reflects the Company's findings at the time of its intervention only and within the limits of Client's instructions, if any. The Company's sole responsibility is to its Client and this document does not exonerate parties to a transaction from exercising all their rights and obligations under the transaction documents. This document cannot be reproduced except in full, without prior written approval of the Company. Any unauthorized alteration, forgery or falsification of the content or appearance of this document is unlawful and offenders may be prosecuted to the fullest extent of the law.

802.11ac_20MHz_Chain0_5785MHz

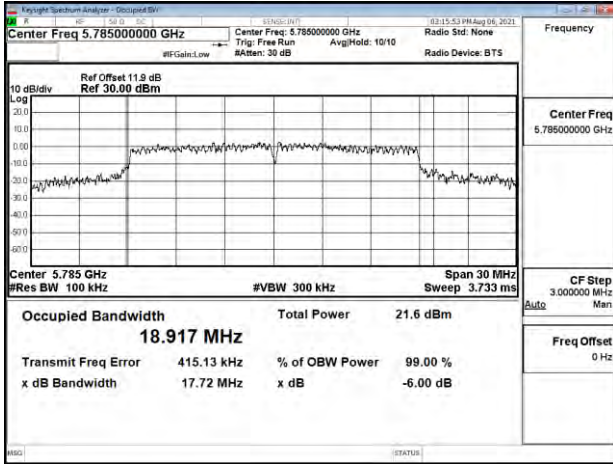

802.11ac_20MHz_Chain1_5220MHz

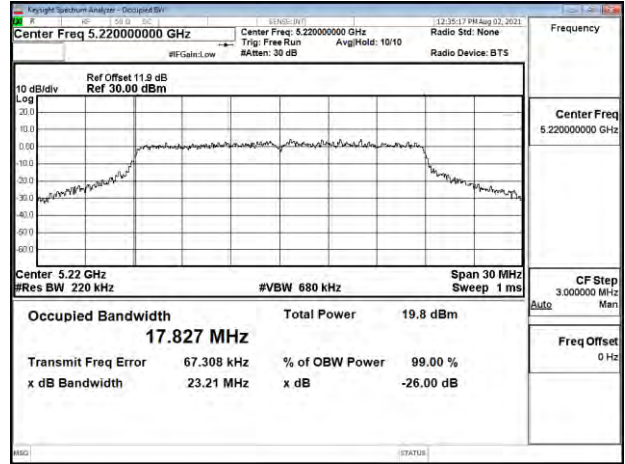

802.11ac_20MHz_Chain0_5825MHz

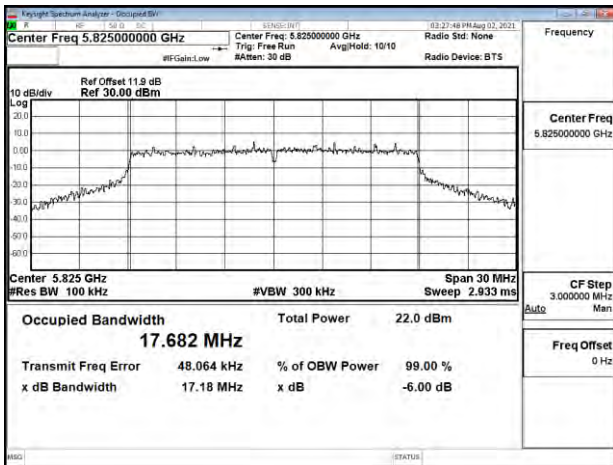

802.11ac_20MHz_Chain1_5240MHz

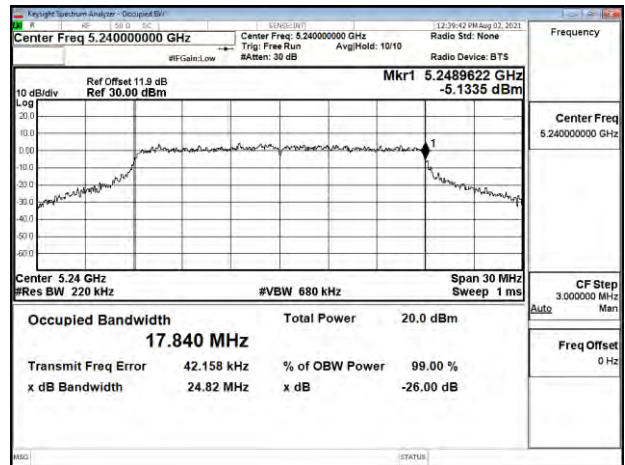

802.11ac_20MHz_Chain1_5180MHz

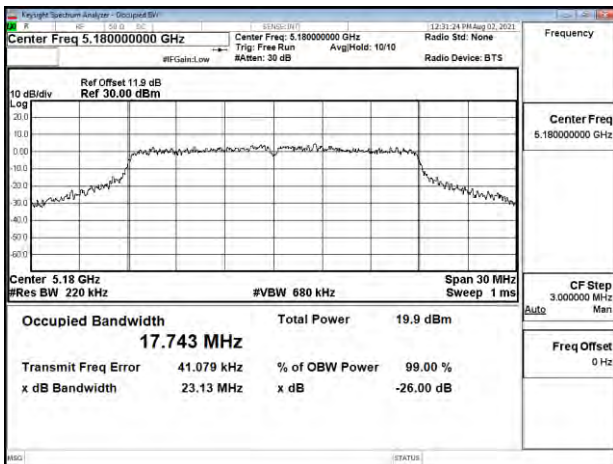

802.11ac_20MHz_Chain1_5260MHz

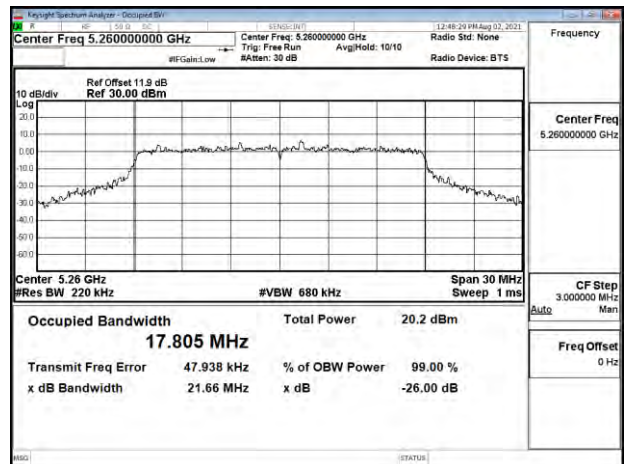

Unless otherwise stated the results shown in this test report refer only to the sample(s) tested and such sample(s) are retained for 90 days only.

除非另有說明，此報告結果僅對測試之樣品負責，同時此樣品僅保留90天。本報告未經本公司書面許可，不可部份複製。

This document is issued by the Company subject to its General Conditions of Service printed overleaf, available on request or accessible at <http://www.sgs.com.tw/Terms-and-Conditions> and for electronic format documents, subject to Terms and Conditions for Electronic Documents at <http://www.sgs.com.tw/Terms-and-Conditions>. Attention is drawn to the limitation of liability, indemnification and jurisdiction issues defined therein. Any holder of this document is advised that information contained hereon reflects the Company's findings at the time of its intervention only and within the limits of Client's instructions, if any. The Company's sole responsibility is to its Client and this document does not exonerate parties to a transaction from exercising all their rights and obligations under the transaction documents. This document cannot be reproduced except in full, without prior written approval of the Company. Any unauthorized alteration, forgery or falsification of the content or appearance of this document is unlawful and offenders may be prosecuted to the fullest extent of the law.

802.11ac_20MHz_Chain1_5300MHz

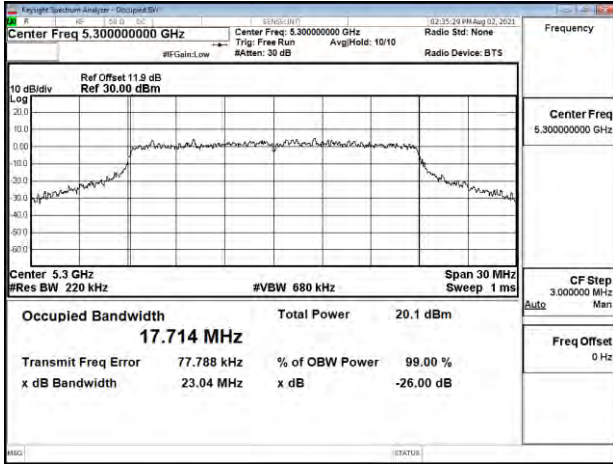

802.11ac_20MHz_Chain1_5580MHz

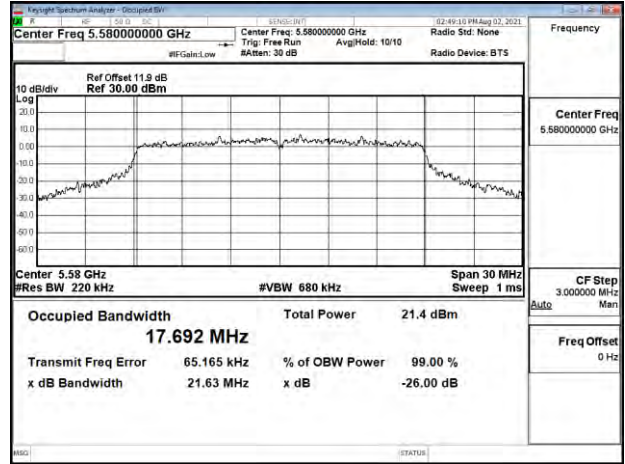

802.11ac_20MHz_Chain1_5320MHz

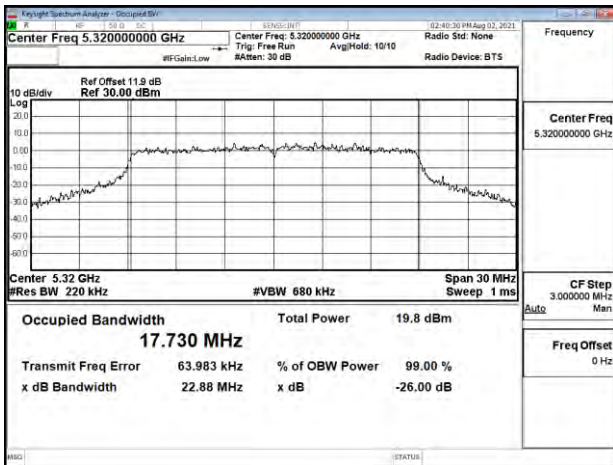

802.11ac_20MHz_Chain1_5700MHz

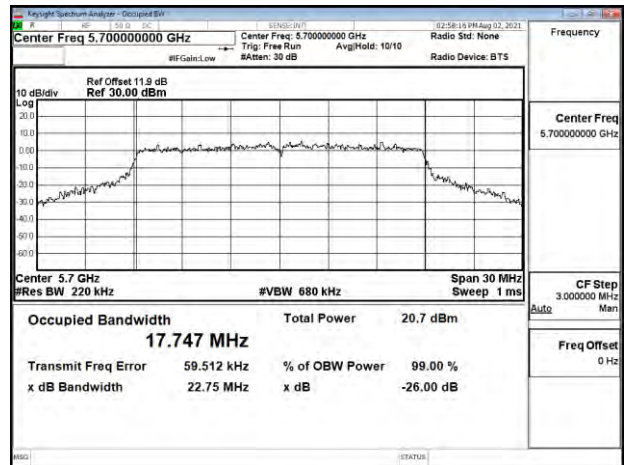

802.11ac_20MHz_Chain1_5500MHz

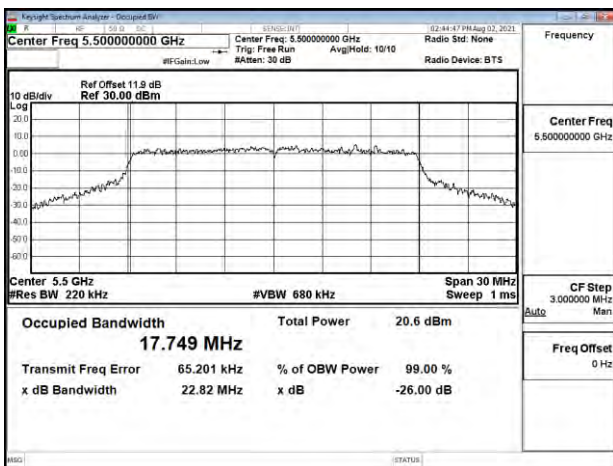

802.11ac_20MHz_Chain1_5720MHz

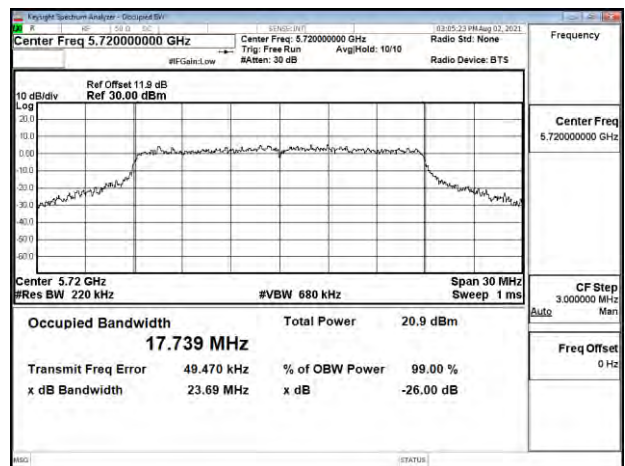

Unless otherwise stated the results shown in this test report refer only to the sample(s) tested and such sample(s) are retained for 90 days only.

除非另有說明，此報告結果僅對測試之樣品負責，同時此樣品僅保留90天。本報告未經本公司書面許可，不可部份複製。

This document is issued by the Company subject to its General Conditions of Service printed overleaf, available on request or accessible at <http://www.sgs.com.tw/Terms-and-Conditions> and for electronic format documents, subject to Terms and Conditions for Electronic Documents at <http://www.sgs.com.tw/Terms-and-Conditions>. Attention is drawn to the limitation of liability, indemnification and jurisdiction issues defined therein. Any holder of this document is advised that information contained herein reflects the Company's findings at the time of its intervention only and within the limits of Client's instructions, if any. The Company's sole responsibility is to its Client and this document does not exonerate parties to a transaction from exercising all their rights and obligations under the transaction documents. This document cannot be reproduced except in full, without prior written approval of the Company. Any unauthorized alteration, forgery or falsification of the content or appearance of this document is unlawful and offenders may be prosecuted to the fullest extent of the law.

802.11ac_20MHz_Chain1_5745MHz

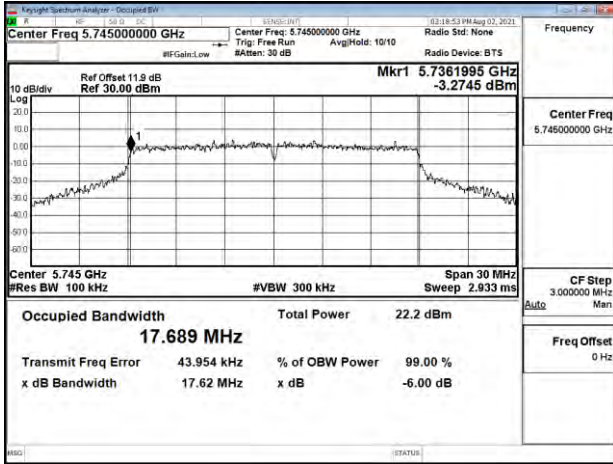

802.11ac_40MHz_Chain0_5190MHz

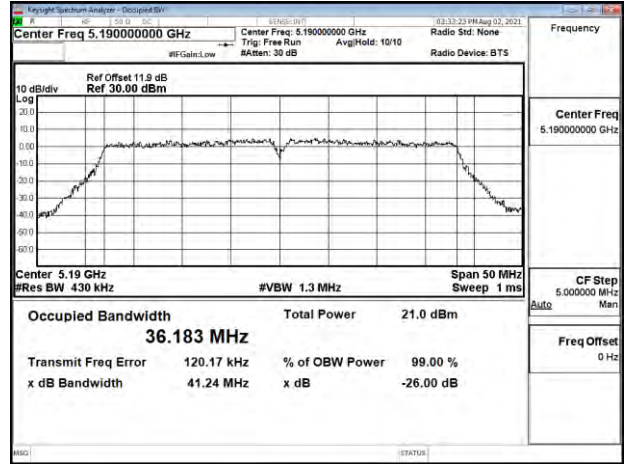

802.11ac_20MHz_Chain1_5785MHz

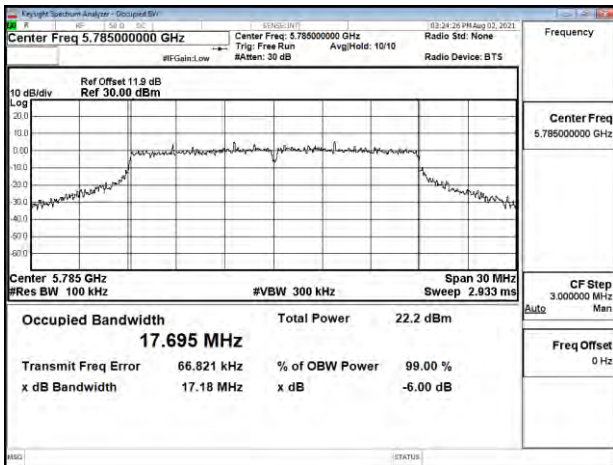

802.11ac_40MHz_Chain0_5230MHz

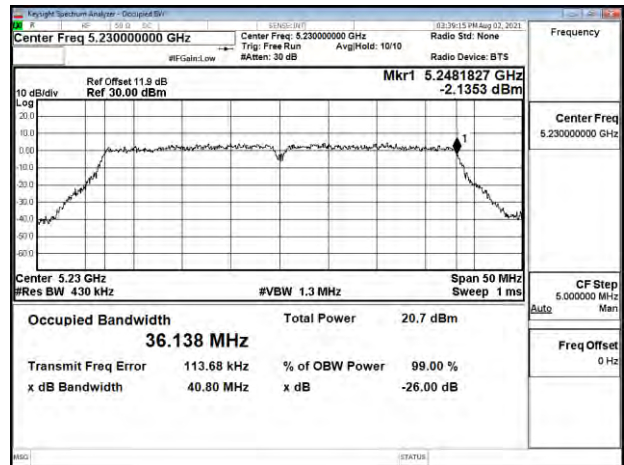

802.11ac_20MHz_Chain1_5825MHz

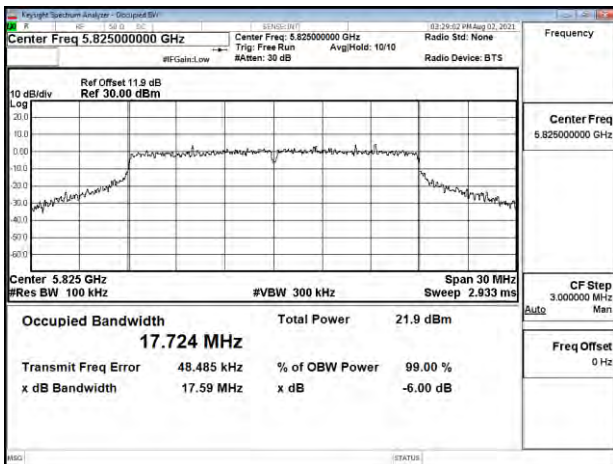

802.11ac_40MHz_Chain0_5270MHz

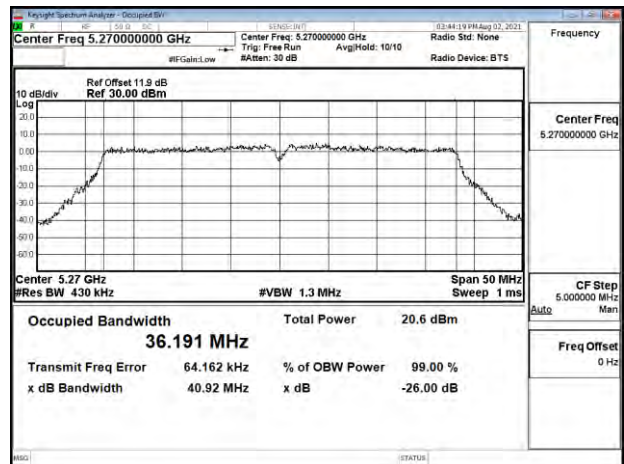

Unless otherwise stated the results shown in this test report refer only to the sample(s) tested and such sample(s) are retained for 90 days only.

除非另有說明，此報告結果僅對測試之樣品負責，同時此樣品僅保留90天。本報告未經本公司書面許可，不可部份複製。

This document is issued by the Company subject to its General Conditions of Service printed overleaf, available on request or accessible at <http://www.sgs.com.tw/Terms-and-Conditions> and for electronic format documents, subject to Terms and Conditions for Electronic Documents at <http://www.sgs.com.tw/Terms-and-Conditions>. Attention is drawn to the limitation of liability, indemnification and jurisdiction issues defined therein. Any holder of this document is advised that information contained herein reflects the Company's findings at the time of its intervention only and within the limits of Client's instructions, if any. The Company's sole responsibility is to its Client and this document does not exonerate parties to a transaction from exercising all their rights and obligations under the transaction documents. This document cannot be reproduced except in full, without prior written approval of the Company. Any unauthorized alteration, forgery or falsification of the content or appearance of this document is unlawful and offenders may be prosecuted to the fullest extent of the law.

802.11ac_40MHz_Chain0_5310MHz

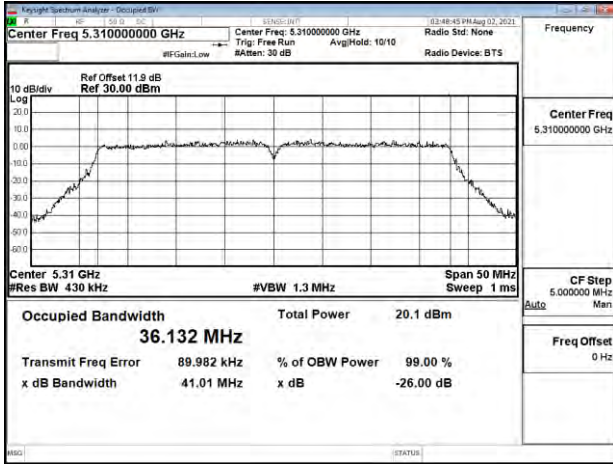

802.11ac_40MHz_Chain0_5670MHz

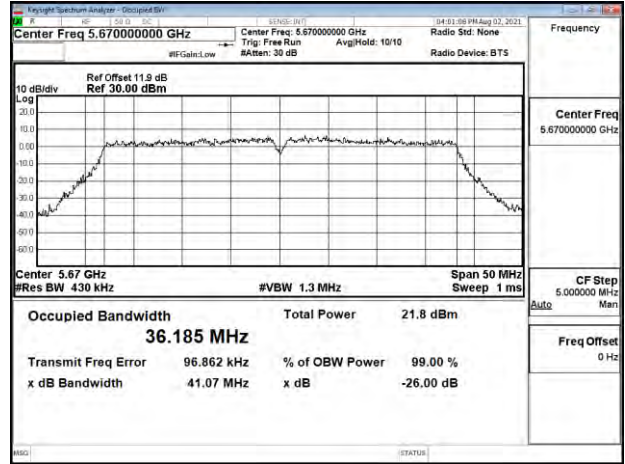

802.11ac_40MHz_Chain0_5510MHz

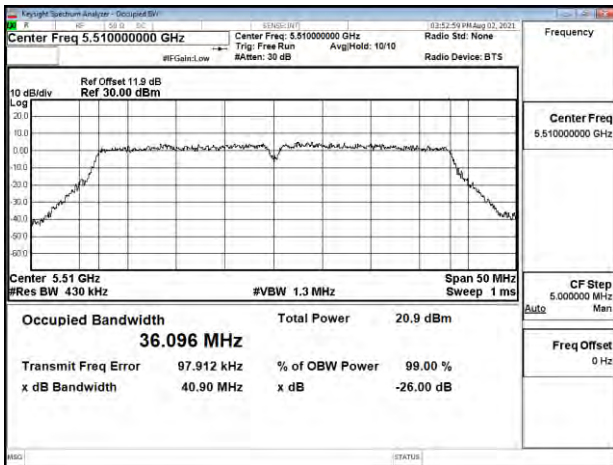

802.11ac_40MHz_Chain0_5755MHz

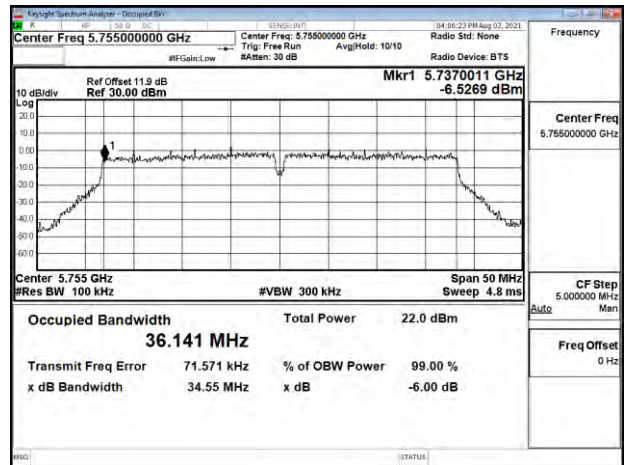

802.11ac_40MHz_Chain0_5550MHz

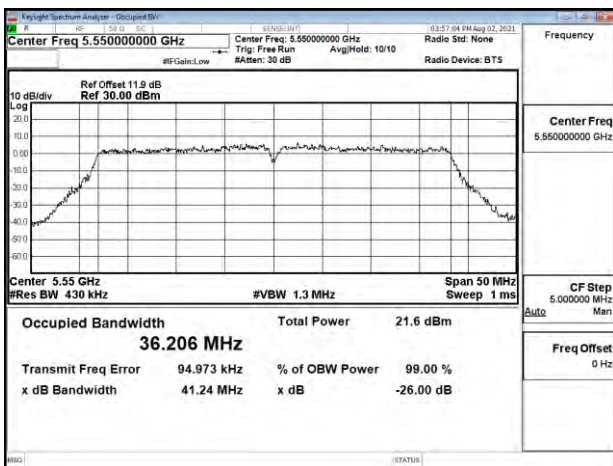

802.11ac_40MHz_Chain0_5795MHz

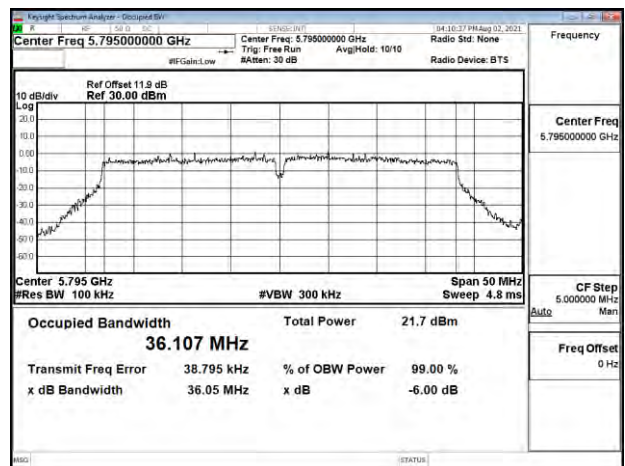

Unless otherwise stated the results shown in this test report refer only to the sample(s) tested and such sample(s) are retained for 90 days only.

除非另有說明，此報告結果僅對測試之樣品負責，同時此樣品僅保留90天。本報告未經本公司書面許可，不可部份複製。

This document is issued by the Company subject to its General Conditions of Service printed overleaf, available on request or accessible at <http://www.sgs.com.tw/Terms-and-Conditions> and for electronic format documents, subject to Terms and Conditions for Electronic Documents at <http://www.sgs.com.tw/Terms-and-Conditions>. Attention is drawn to the limitation of liability, indemnification and jurisdiction issues defined therein. Any holder of this document is advised that information contained herein reflects the Company's findings at the time of its intervention only and within the limits of Client's instructions, if any. The Company's sole responsibility is to its Client and this document does not exonerate parties to a transaction from exercising all their rights and obligations under the transaction documents. This document cannot be reproduced except in full, without prior written approval of the Company. Any unauthorized alteration, forgery or falsification of the content or appearance of this document is unlawful and offenders may be prosecuted to the fullest extent of the law.

802.11ac_40MHz_Chain1_5190MHz

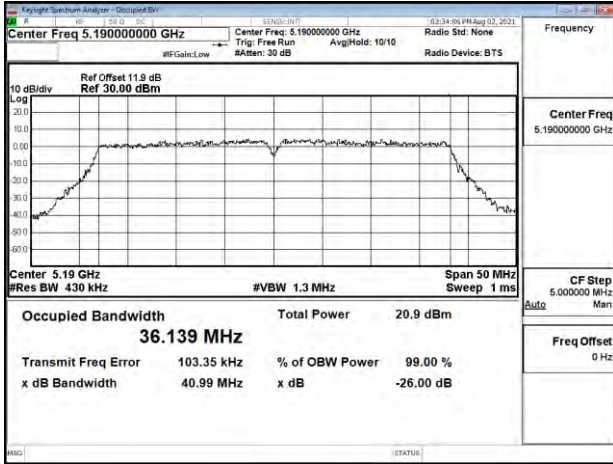

802.11ac_40MHz_Chain1_5310MHz

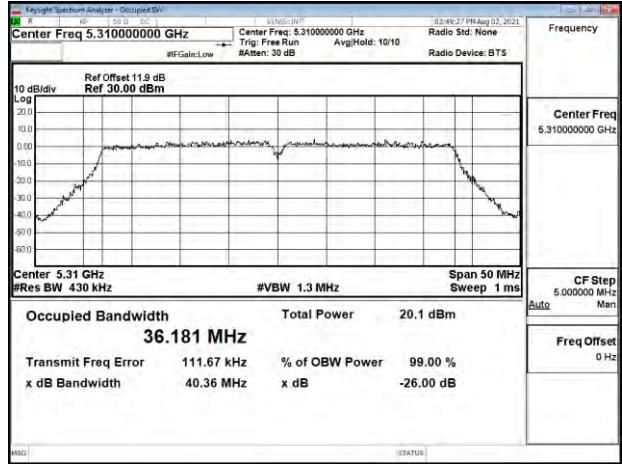

802.11ac_40MHz_Chain1_5230MHz

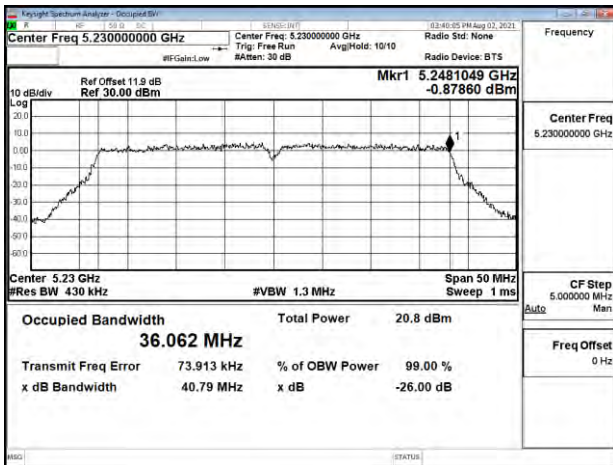

802.11ac_40MHz_Chain1_5510MHz

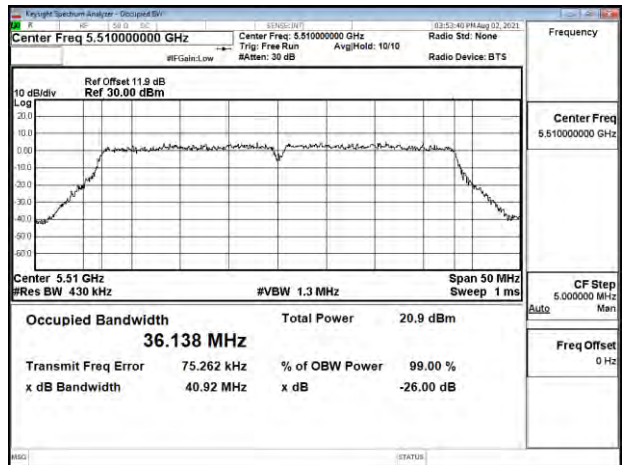

802.11ac_40MHz_Chain1_5270MHz

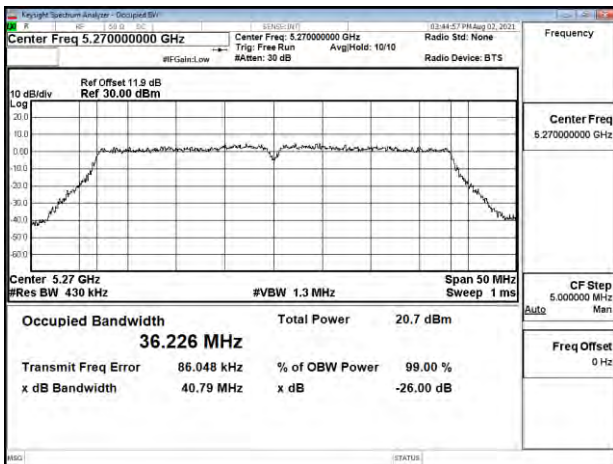

802.11ac_40MHz_Chain1_5550MHz

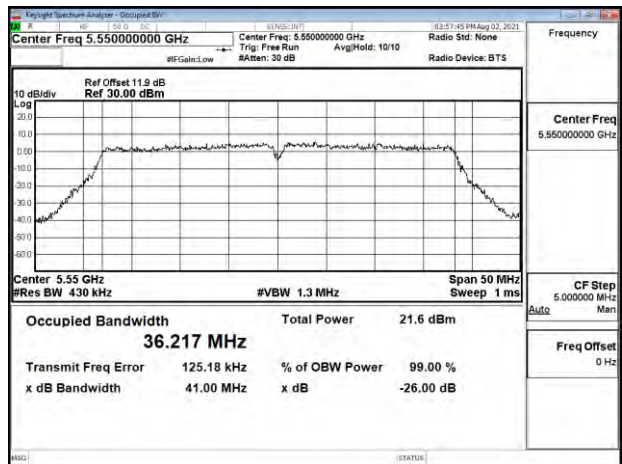

Unless otherwise stated the results shown in this test report refer only to the sample(s) tested and such sample(s) are retained for 90 days only.

除非另有說明，此報告結果僅對測試之樣品負責，同時此樣品僅保留90天。本報告未經本公司書面許可，不可部份複製。

This document is issued by the Company subject to its General Conditions of Service printed overleaf, available on request or accessible at <http://www.sgs.com.tw/Terms-and-Conditions> and for electronic format documents, subject to Terms and Conditions for Electronic Documents at <http://www.sgs.com.tw/Terms-and-Conditions>. Attention is drawn to the limitation of liability, indemnification and jurisdiction issues defined therein. Any holder of this document is advised that information contained herein reflects the Company's findings at the time of its intervention only and within the limits of Client's instructions, if any. The Company's sole responsibility is to its Client and this document does not exonerate parties to a transaction from exercising all their rights and obligations under the transaction documents. This document cannot be reproduced except in full, without prior written approval of the Company. Any unauthorized alteration, forgery or falsification of the content or appearance of this document is unlawful and offenders may be prosecuted to the fullest extent of the law.

802.11ac_40MHz_Chain1_5670MHz

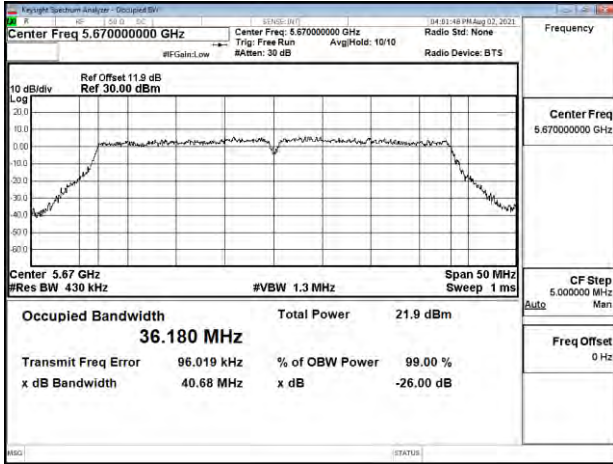

802.11ac_80MHz_Chain0_5210MHz

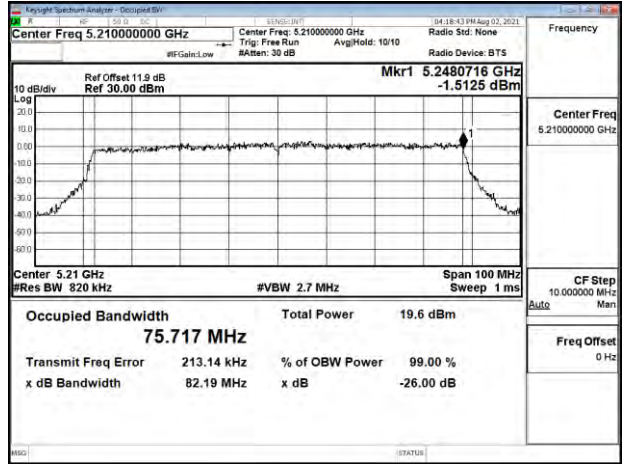

802.11ac_40MHz_Chain1_5755MHz

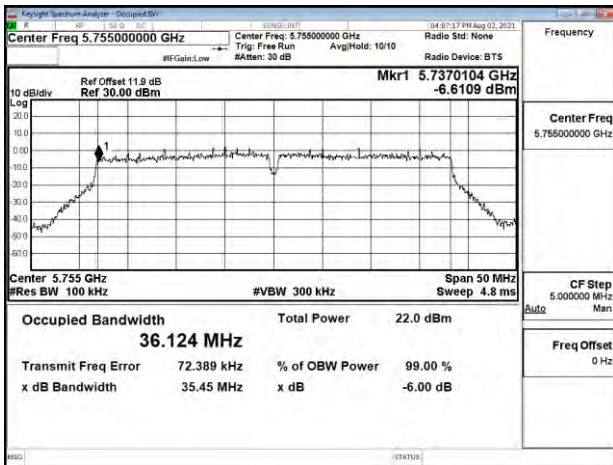

802.11ac_80MHz_Chain0_5290MHz

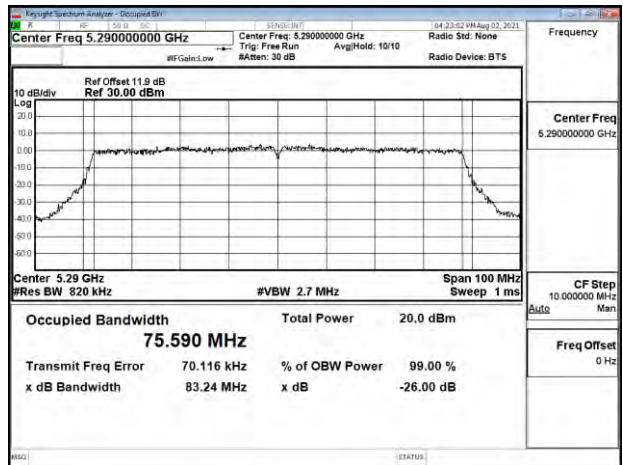

802.11ac_40MHz_Chain1_5795MHz

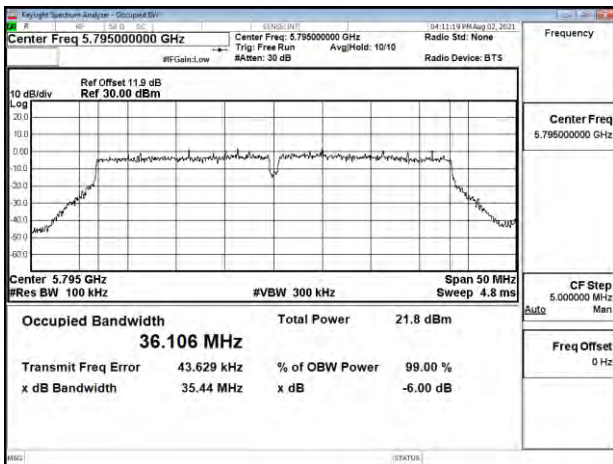

802.11ac_80MHz_Chain0_5530MHz

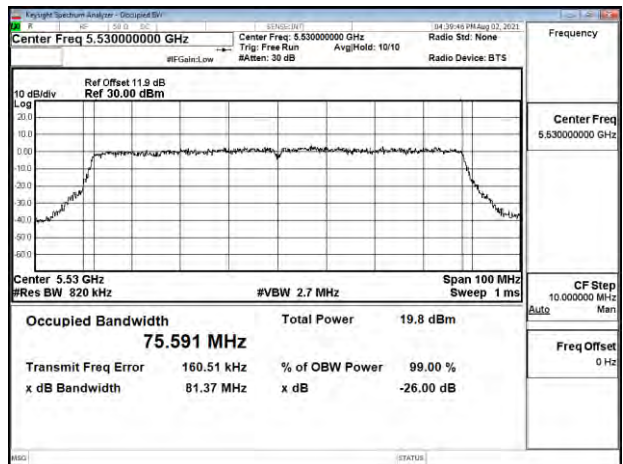

Unless otherwise stated the results shown in this test report refer only to the sample(s) tested and such sample(s) are retained for 90 days only.

除非另有說明，此報告結果僅對測試之樣品負責，同時此樣品僅保留90天。本報告未經本公司書面許可，不可部份複製。

This document is issued by the Company subject to its General Conditions of Service printed overleaf, available on request or accessible at <http://www.sgs.com.tw/Terms-and-Conditions> and for electronic format documents, subject to Terms and Conditions for Electronic Documents at <http://www.sgs.com.tw/Terms-and-Conditions>. Attention is drawn to the limitation of liability, indemnification and jurisdiction issues defined therein. Any holder of this document is advised that information contained hereon reflects the Company's findings at the time of its intervention only and within the limits of Client's instructions, if any. The Company's sole responsibility is to its Client and this document does not exonerate parties to a transaction from exercising all their rights and obligations under the transaction documents. This document cannot be reproduced except in full, without prior written approval of the Company. Any unauthorized alteration, forgery or falsification of the content or appearance of this document is unlawful and offenders may be prosecuted to the fullest extent of the law.

802.11ac_80MHz_Chain0_5610MHz

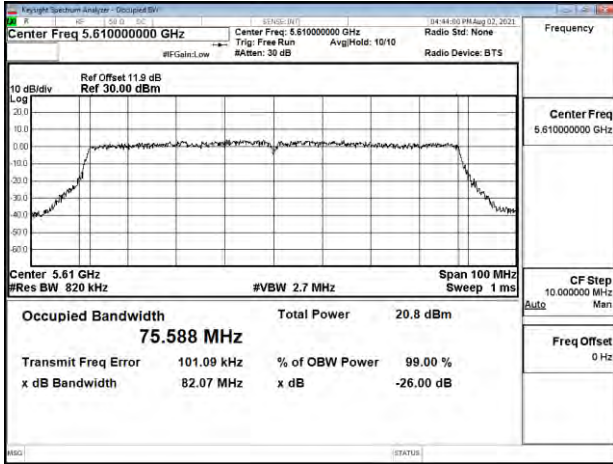

802.11ac_80MHz_Chain1_5290MHz

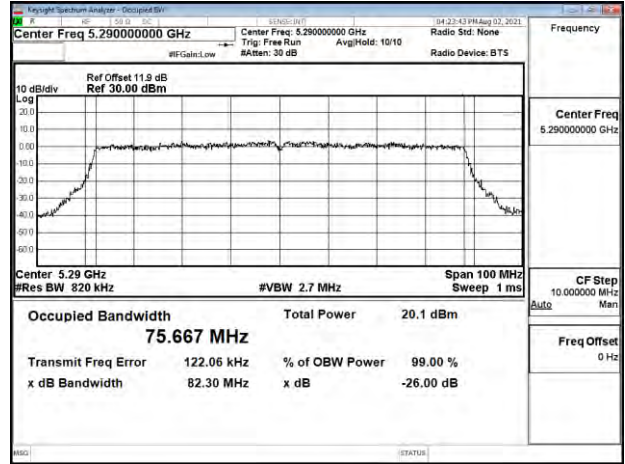

802.11ac_80MHz_Chain0_5775MHz

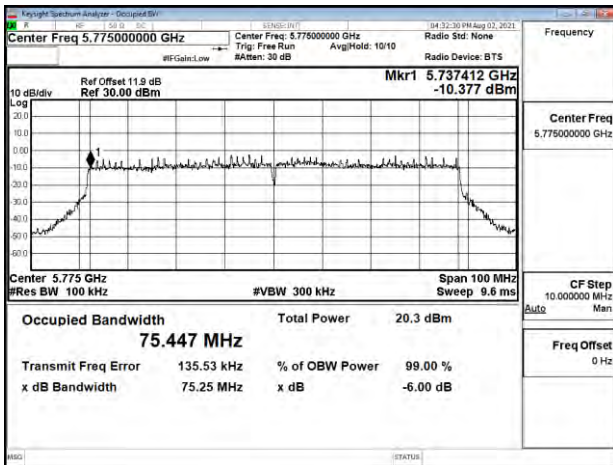

802.11ac_80MHz_Chain1_5530MHz

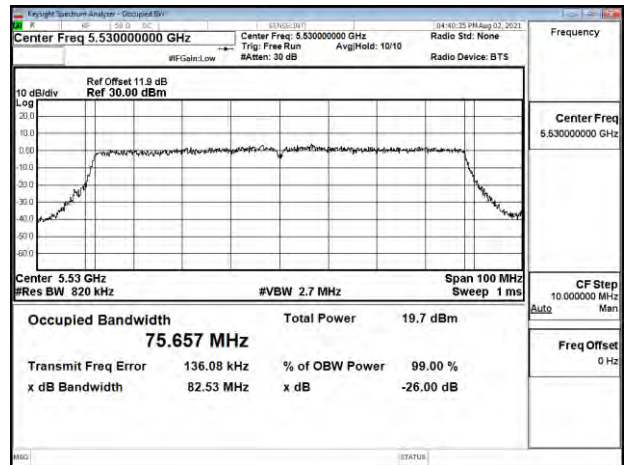

802.11ac_80MHz_Chain1_5210MHz

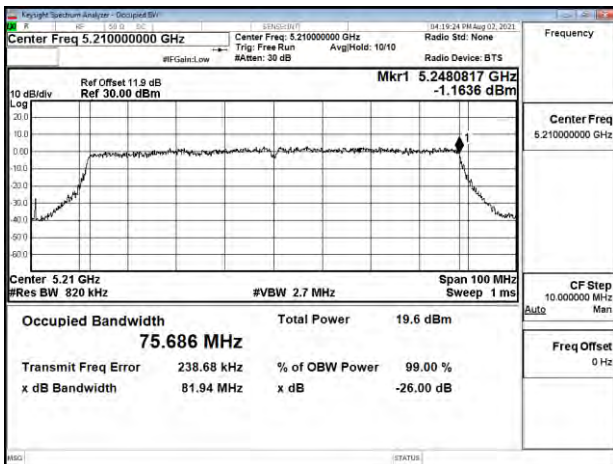

802.11ac_80MHz_Chain1_5610MHz

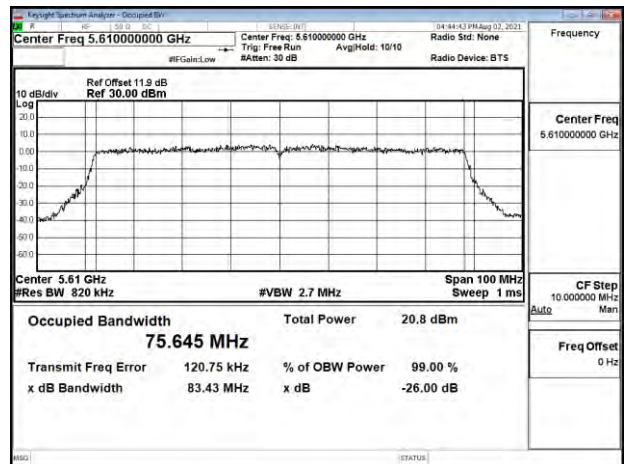

Unless otherwise stated the results shown in this test report refer only to the sample(s) tested and such sample(s) are retained for 90 days only.

除非另有說明，此報告結果僅對測試之樣品負責，同時此樣品僅保留90天。本報告未經本公司書面許可，不可部份複製。

This document is issued by the Company subject to its General Conditions of Service printed overleaf, available on request or accessible at <http://www.sgs.com.tw/Terms-and-Conditions> and for electronic format documents, subject to Terms and Conditions for Electronic Documents at <http://www.sgs.com.tw/Terms-and-Conditions>. Attention is drawn to the limitation of liability, indemnification and jurisdiction issues defined therein. Any holder of this document is advised that information contained herein reflects the Company's findings at the time of its intervention only and within the limits of Client's instructions, if any. The Company's sole responsibility is to its Client and this document does not exonerate parties to a transaction from exercising all their rights and obligations under the transaction documents. This document cannot be reproduced except in full, without prior written approval of the Company. Any unauthorized alteration, forgery or falsification of the content or appearance of this document is unlawful and offenders may be prosecuted to the fullest extent of the law.

802.11ac_80MHz_Chain1_5775MHz

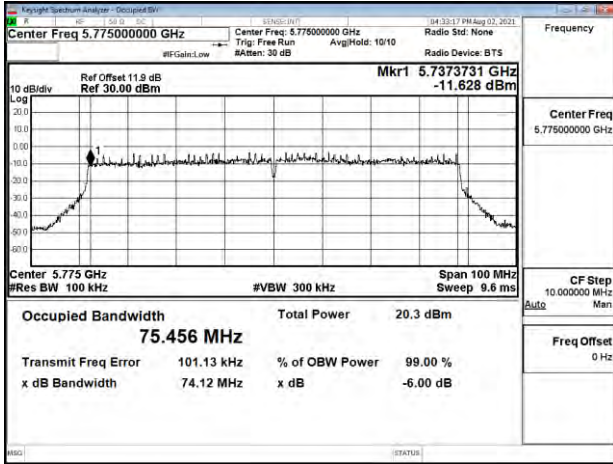

Unless otherwise stated the results shown in this test report refer only to the sample(s) tested and such sample(s) are retained for 90 days only.

除非另有說明，此報告結果僅對測試之樣品負責，同時此樣品僅保留90天。本報告未經本公司書面許可，不可部份複製。

This document is issued by the Company subject to its General Conditions of Service printed overleaf, available on request or accessible at <http://www.sgs.com.tw/Terms-and-Conditions> and for electronic format documents, subject to Terms and Conditions for Electronic Documents at <http://www.sgs.com.tw/Terms-and-Conditions>. Attention is drawn to the limitation of liability, indemnification and jurisdiction issues defined therein. Any holder of this document is advised that information contained hereon reflects the Company's findings at the time of its intervention only and within the limits of Client's instructions, if any. The Company's sole responsibility is to its Client and this document does not exonerate parties to a transaction from exercising all their rights and obligations under the transaction documents. This document cannot be reproduced except in full, without prior written approval of the Company. Any unauthorized alteration, forgery or falsification of the content or appearance of this document is unlawful and offenders may be prosecuted to the fullest extent of the law.

9 MAXIMUM CONDUCTED OUTPUT POWER MEASUREMENT

9.1 Standard Applicable

Band	EUT CATEGORY		LIMIT			
			Conducted Output Power	EIRP	TPC	Antenna Directional Gain Requirements
U-NII-1	<input type="checkbox"/>	Fixed point-to-point	1 Watt(30dBm)	Not required	Not required	23dBi
	<input type="checkbox"/>	Out door AP	1 Watt(30dBm)	Elevation angle above 30 degrees 125mW (21dBm)	Not required	6dBi
	<input checked="" type="checkbox"/>	Other	250mW(23.98dBm)	Not required	Not required	6dBi
U-NII-2A	<input checked="" type="checkbox"/>	Other	250mW(23.98dBm) or 11dBm+10 log B	Not required	When EIRP >500mW	6dBi
U-NII-2C	<input checked="" type="checkbox"/>	Other	250mW(23.98dBm) or 11dBm+10 log B	Not required	At least 6dB below EIRP 1W (30dBm)	6dBi
U-NII-3	<input checked="" type="checkbox"/>	Other	1 Watt(30dBm)	Not required	Not required	6dBi
	<input type="checkbox"/>	Fixed point-to-point	1 Watt(30dBm)	Not required	Not required	Not required

If transmitting antennas of directional gain greater than the Antenna Directional Gain Requirements column, the Maximum transmit power shall be reduced by the amount in dB that the direction-al gain of the antenna.

Note:

As per section F. 2). e). (ii) of FCC KDB 662911 D01

If antenna gains are not equal and each transmit antenna is driven by only one spatial stream, directional gain may be calculated by either of the following formulas.

$$DirectionalGain = 10 \cdot \log \left[\frac{\sum_{j=1}^{N_{SS}} \left\{ \sum_{k=1}^{N_{ANT}} g_{j,k} \right\}^2}{N_{ANT}} \right]$$

where

Each antenna is driven by no more than one spatial stream;

NSS = the number of independent spatial streams of data;

NANT = the total number of antennas

$g_{j,k} = 10^{G_k/20}$ if the kth antenna is being fed by spatial stream j, or zero if it is not;

G_k is the gain in dBi of the kth antenna.

The antenna gain is not greater than 6 dBi. Therefore, reduction of power is not required.

Unless otherwise stated the results shown in this test report refer only to the sample(s) tested and such sample(s) are retained for 90 days only.

除非另有說明，此報告結果僅對測試之樣品負責，同時此樣品僅保留90天。本報告未經本公司書面許可，不可部份複製。

This document is issued by the Company subject to its General Conditions of Service printed overleaf, available on request or accessible at <http://www.sgs.com.tw/Terms-and-Conditions> and for electronic format documents, subject to Terms and Conditions for Electronic Documents at <http://www.sgs.com.tw/Terms-and-Conditions>. Attention is drawn to the limitation of liability, indemnification and jurisdiction issues defined therein. Any holder of this document is advised that information contained herein reflects the Company's findings at the time of its intervention only and within the limits of Client's instructions, if any. The Company's sole responsibility is to its Client and this document does not exonerate parties to a transaction from exercising all their rights and obligations under the transaction documents. This document cannot be reproduced except in full, without prior written approval of the Company. Any unauthorized alteration, forgery or falsification of the content or appearance of this document is unlawful and offenders may be prosecuted to the fullest extent of the law.

9.2 Measurement Procedure

1. Place the EUT on the table and set it in transmitting mode.
2. The testing follows FCC KDB 789033 D02 General UNII Test Procedures New Rules .
3. Remove the antenna from the EUT and then connect a low loss RF cable from the antenna port to the power meter
4. Power Meter is used as the auxiliary test equipment to conduct the output power measurement.
5. Record the max. reading and add 10 log(1/duty cycle).
6. Repeat above procedures until all frequency (low, middle, and high channel) measured were complete.

9.3 Measurement Equipment Used

Conducted Emission Test Site: Conducted G					
EQUIPMENT TYPE	MFR	MODEL NUMBER	SERIAL NUMBER	LAST CAL.	CAL DUE.
Power Meter	Anritsu	ML2496A	1804002	04/14/2021	04/13/2022
Power Sensor	Anritsu	MA2411B	1726105	04/14/2021	04/13/2022
Power Sensor	Anritsu	MA2411B	1726106	04/14/2021	04/13/2022
Attenuator	Marvelous	MVE2213-10	RF09	11/19/2020	11/18/2021
Attenuator	Marvelous	MVE2213-10	RF10	11/19/2020	11/18/2021
Coaxial Cables	Woken	00100A1F2A196C	RF59	11/19/2020	11/18/2021
Coaxial Cables	Woken	00100A1F2A196C	RF68	11/19/2020	11/18/2021
Spectrum Analyzer	KEYSIGHT	N9010A	MY57120290	04/06/2021	04/05/2022

9.4 Test Set-up

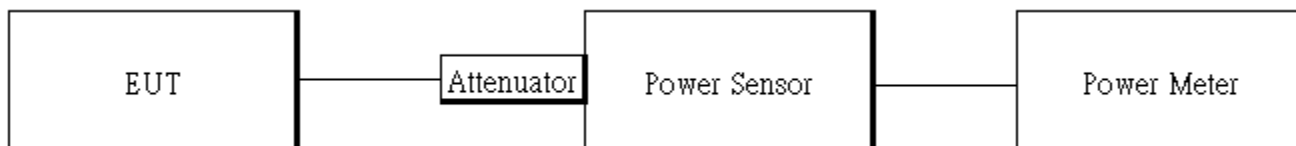

9.5 Measurement Result

For the 5.25-5.35 GHz and 5.47-5.725 GHz bands, the maximum conducted output power limits are the lesser of 250 mW (23.98dBm) or 11 dBm + 10 log B.

1. Where B is the 26 dB emission bandwidth in megahertz for FCC compliance.

Unless otherwise stated the results shown in this test report refer only to the sample(s) tested and such sample(s) are retained for 90 days only.
 除非另有說明，此報告結果僅對測試之樣品負責，同時此樣品僅保留90天。本報告未經本公司書面許可，不可部份複製。

This document is issued by the Company subject to its General Conditions of Service printed overleaf, available on request or accessible at <http://www.sgs.com.tw/Terms-and-Conditions> and for electronic format documents, subject to Terms and Conditions for Electronic Documents at <http://www.sgs.com.tw/Terms-and-Conditions>. Attention is drawn to the limitation of liability, indemnification and jurisdiction issues defined therein. Any holder of this document is advised that information contained hereon reflects the Company's findings at the time of its intervention only and within the limits of Client's instructions, if any. The Company's sole responsibility is to its Client and this document does not exonerate parties to a transaction from exercising all their rights and obligations under the transaction documents. This document cannot be reproduced except in full, without prior written approval of the Company. Any unauthorized alteration, forgery or falsification of the content or appearance of this document is unlawful and offenders may be prosecuted to the fullest extent of the law.

9.5.1 Conducted output power (FCC)

802.11a_Ch0

CH	Frequency (MHz)	Data Rate	Power set	TOTAL POWER (dBm)	TOTAL POWER (mW)	REQUIRED LIMIT (dBm)	RESULT
36	5180	6	16.5	15.92	39.042	23.98	PASS
44	5220	6	17	15.97	39.494	23.98	PASS
48	5240	6	17	15.99	39.677	23.98	PASS
52	5260	6	16.5	15.95	39.313	23.98	PASS
60	5300	6	16.5	15.91	38.952	23.98	PASS
64	5320	6	17	15.98	39.585	23.98	PASS
100	5500	6	17	15.99	39.677	23.98	PASS
116	5580	6	16.5	15.97	39.494	23.98	PASS
140	5700	6	16.5	15.82	38.154	23.98	PASS
144	5720(U-NII 2C)	6	16.5	14.39	27.45	23.17	PASS
144	5720 (U-NII 3)	6	16.5	10.33	10.79	30	PASS
149	5745	6	16.5	15.93	39.132	30	PASS
157	5785	6	16.5	15.98	39.585	30	PASS
165	5825	6	16.5	15.95	39.313	30	PASS

802.11a_Ch1

CH	Frequency (MHz)	Data Rate	Power set	TOTAL POWER (dBm)	TOTAL POWER (mW)	REQUIRED LIMIT (dBm)	RESULT
36	5180	6	16	15.61	36.353	23.98	PASS
44	5220	6	16	15.65	36.689	23.98	PASS
48	5240	6	16	15.55	35.854	23.98	PASS
52	5260	6	16	15.73	37.371	23.98	PASS
60	5300	6	16	15.76	37.630	23.98	PASS
64	5320	6	16	15.69	37.028	23.98	PASS
100	5500	6	16	15.79	37.891	23.98	PASS
116	5580	6	15.5	15.91	38.952	23.98	PASS
140	5700	6	15.5	15.69	37.028	23.98	PASS
144	5720(U-NII 2C)	6	15.5	14.22	26.40	23.17	PASS
144	5720 (U-NII 3)	6	15.5	10.16	10.38	30	PASS
149	5745	6	15.5	15.75	37.544	30	PASS
157	5785	6	16	15.79	37.891	30	PASS
165	5825	6	16	15.87	38.595	30	PASS

Unless otherwise stated the results shown in this test report refer only to the sample(s) tested and such sample(s) are retained for 90 days only.

除非另有說明，此報告結果僅對測試之樣品負責，同時此樣品僅保留90天。本報告未經本公司書面許可，不可部份複製。

This document is issued by the Company subject to its General Conditions of Service printed overleaf, available on request or accessible at <http://www.sgs.com.tw/Terms-and-Conditions> and for electronic format documents, subject to Terms and Conditions for Electronic Documents at <http://www.sgs.com.tw/Terms-and-Conditions>. Attention is drawn to the limitation of liability, indemnification and jurisdiction issues defined therein. Any holder of this document is advised that information contained herein reflects the Company's findings at the time of its intervention only and within the limits of Client's instructions, if any. The Company's sole responsibility is to its Client and this document does not exonerate parties to a transaction from exercising all their rights and obligations under the transaction documents. This document cannot be reproduced except in full, without prior written approval of the Company. Any unauthorized alteration, forgery or falsification of the content or appearance of this document is unlawful and offenders may be prosecuted to the fullest extent of the law.

802.11n_HT20_Ch0

CH	Frequency (MHz)	Data Rate	Power set	TOTAL POWER (dBm)	TOTAL POWER (mW)	REQUIRED LIMIT (dBm)	RESULT
36	5180	MCS0	18	16.89	48.810	23.98	PASS
44	5220	MCS0	18	16.78	47.589	23.98	PASS
48	5240	MCS0	18	16.87	48.586	23.98	PASS
52	5260	MCS0	18	16.83	48.140	23.98	PASS
60	5300	MCS0	18	16.81	47.919	23.98	PASS
64	5320	MCS0	18	16.82	48.030	23.98	PASS
100	5500	MCS0	18	16.86	48.474	23.98	PASS
116	5580	MCS0	18	16.90	48.922	23.98	PASS
140	5700	MCS0	18	16.83	48.140	23.98	PASS
144	5720(U-NII 2C)	MCS0	18	15.36	34.34	23.98	PASS
144	5720 (U-NII 3)	MCS0	18	11.44	13.92	30	PASS
149	5745	MCS0	18	16.88	48.698	30	PASS
157	5785	MCS0	18	16.90	48.922	30	PASS
165	5825	MCS0	18	16.81	47.919	30	PASS

802.11n_HT20_Ch1

CH	Frequency (MHz)	Data Rate	Power set	TOTAL POWER (dBm)	TOTAL POWER (mW)	REQUIRED LIMIT (dBm)	RESULT
36	5180	MCS0	17.5	16.83	48.140	23.98	PASS
44	5220	MCS0	17.5	16.76	47.371	23.98	PASS
48	5240	MCS0	17.5	16.84	48.251	23.98	PASS
52	5260	MCS0	17.5	16.79	47.699	23.98	PASS
60	5300	MCS0	17.5	16.77	47.480	23.98	PASS
64	5320	MCS0	17.5	16.79	47.699	23.98	PASS
100	5500	MCS0	17.5	16.81	47.919	23.98	PASS
116	5580	MCS0	16.5	16.74	47.153	23.98	PASS
140	5700	MCS0	17	16.78	47.589	23.98	PASS
144	5720(U-NII 2C)	MCS0	17	15.30	33.92	23.98	PASS
144	5720 (U-NII 3)	MCS0	17	11.39	13.78	30	PASS
149	5745	MCS0	17	16.75	47.262	30	PASS
157	5785	MCS0	17	16.61	45.762	30	PASS
165	5825	MCS0	17	16.66	46.292	30	PASS

Unless otherwise stated the results shown in this test report refer only to the sample(s) tested and such sample(s) are retained for 90 days only.

除非另有說明，此報告結果僅對測試之樣品負責，同時此樣品僅保留90天。本報告未經本公司書面許可，不可部份複製。

This document is issued by the Company subject to its General Conditions of Service printed overleaf, available on request or accessible at <http://www.sgs.com.tw/Terms-and-Conditions> and for electronic format documents, subject to Terms and Conditions for Electronic Documents at <http://www.sgs.com.tw/Terms-and-Conditions>. Attention is drawn to the limitation of liability, indemnification and jurisdiction issues defined therein. Any holder of this document is advised that information contained hereon reflects the Company's findings at the time of its intervention only and within the limits of Client's instructions, if any. The Company's sole responsibility is to its Client and this document does not exonerate parties to a transaction from exercising all their rights and obligations under the transaction documents. This document cannot be reproduced except in full, without prior written approval of the Company. Any unauthorized alteration, forgery or falsification of the content or appearance of this document is unlawful and offenders may be prosecuted to the fullest extent of the law.

802.11n_HT20_MIMO

CH	Frequency (MHz)	Data Rate	Power set	Avg. POWER (dBm)		TOTAL POWER (dBm)	TOTAL POWER (mW)	REQUIRED LIMIT (dBm)	RESULT
				CH 0	CH 1				
36	5180	MCS8	17.5	17.06	16.5	19.88	97.373	23.98	PASS
44	5220	MCS8	17.5	17.02	16.19	19.72	93.760	23.98	PASS
48	5240	MCS8	17.5	16.96	16.57	19.86	96.934	23.98	PASS
52	5260	MCS8	17.5	17.04	16.53	19.89	97.451	23.98	PASS
60	5300	MCS8	17.5	17.1	16.47	19.89	97.539	23.98	PASS
64	5320	MCS8	17.5	17.04	16.36	19.81	95.690	23.98	PASS
100	5500	MCS8	17	16.78	16.05	19.53	89.654	23.98	PASS
116	5580	MCS8	17	17.18	16.19	19.81	95.687	23.98	PASS
140	5700	MCS8	17	16.83	16.16	19.60	91.270	23.98	PASS
144	5720(U-NII 2C)	MCS8	17	15.36	14.62	18.11	64.668	23.26	PASS
144	5720 (U-NII 3)	MCS8	17	11.44	10.71	14.19	26.241	30	PASS
149	5745	MCS8	17	16.83	16.15	19.60	91.173	30	PASS
157	5785	MCS8	17	16.74	16.4	19.67	92.655	30	PASS
165	5825	MCS8	17	16.5	16.49	19.59	90.999	30	PASS

802.11ac_VHT20_Ch0

CH	Frequency (MHz)	Data Rate	Power set	TOTAL POWER (dBm)	TOTAL POWER (mW)	REQUIRED LIMIT (dBm)	RESULT
36	5180	VHT0	18	16.98	49.906	23.98	PASS
44	5220	VHT0	18	16.82	48.101	23.98	PASS
48	5240	VHT0	18	16.92	49.221	23.98	PASS
52	5260	VHT0	18	16.99	50.021	23.98	PASS
60	5300	VHT0	18	16.97	49.791	23.98	PASS
64	5320	VHT0	18	16.85	48.434	23.98	PASS
100	5500	VHT0	18	16.98	49.906	23.98	PASS
116	5580	VHT0	18	16.96	49.677	23.98	PASS
140	5700	VHT0	18	16.99	50.021	23.98	PASS
144	5720(U-NII 2C)	VHT0	18	15.47	35.27	23.98	PASS
144	5720 (U-NII 3)	VHT0	18	11.55	14.29	30	PASS
149	5745	VHT0	18	16.97	49.791	30	PASS
157	5785	VHT0	17.5	16.92	49.221	30	PASS
165	5825	VHT0	17.5	16.93	49.335	30	PASS

Unless otherwise stated the results shown in this test report refer only to the sample(s) tested and such sample(s) are retained for 90 days only.

除非另有說明，此報告結果僅對測試之樣品負責，同時此樣品僅保留90天。本報告未經本公司書面許可，不可部份複製。

This document is issued by the Company subject to its General Conditions of Service printed overleaf, available on request or accessible at <http://www.sgs.com.tw/Terms-and-Conditions> and for electronic format documents, subject to Terms and Conditions for Electronic Documents at <http://www.sgs.com.tw/Terms-and-Conditions>. Attention is drawn to the limitation of liability, indemnification and jurisdiction issues defined therein. Any holder of this document is advised that information contained hereon reflects the Company's findings at the time of its intervention only and within the limits of Client's instructions, if any. The Company's sole responsibility is to its Client and this document does not exonerate parties to a transaction from exercising all their rights and obligations under the transaction documents. This document cannot be reproduced except in full, without prior written approval of the Company. Any unauthorized alteration, forgery or falsification of the content or appearance of this document is unlawful and offenders may be prosecuted to the fullest extent of the law.

802.11ac_VHT20_Ch1

CH	Frequency (MHz)	Data Rate	Power set	TOTAL POWER (dBm)	TOTAL POWER (mW)	REQUIRED LIMIT (dBm)	RESULT
36	5180	VHT0	17.5	16.92	49.221	23.98	PASS
44	5220	VHT0	17.5	16.80	47.880	23.98	PASS
48	5240	VHT0	17.5	16.87	48.658	23.98	PASS
52	5260	VHT0	17.5	16.96	49.677	23.98	PASS
60	5300	VHT0	17.5	16.93	49.335	23.98	PASS
64	5320	VHT0	17.5	16.83	48.212	23.98	PASS
100	5500	VHT0	17.5	16.96	49.677	23.98	PASS
116	5580	VHT0	16.5	16.76	47.441	23.98	PASS
140	5700	VHT0	17	16.84	48.323	23.98	PASS
144	5720(U-NII 2C)	VHT0	17	15.34	34.20	23.98	PASS
144	5720 (U-NII 3)	VHT0	17	11.43	13.90	30	PASS
149	5745	VHT0	17	16.78	47.660	30	PASS
157	5785	VHT0	17	16.65	46.254	30	PASS
165	5825	VHT0	17	16.67	46.468	30	PASS

802.11ac_VHT20_MIMO

CH	Frequency (MHz)	Data Rate	Power set	Avg. POWER (dBm)		TOTAL POWER (dBm)	TOTAL POWER (mW)	REQUIRED LIMIT (dBm)	RESULT
				CH 0	CH 1				
36	5180	VHT0	17.5	16.96	16.67	19.91	97.932	23.98	PASS
44	5220	VHT0	17.5	16.98	16.47	19.82	96.036	23.98	PASS
48	5240	VHT0	17.5	17.01	16.54	19.87	97.122	23.98	PASS
52	5260	VHT0	17.5	17.1	16.49	19.90	97.668	23.98	PASS
60	5300	VHT0	17.5	17.14	16.57	19.96	98.996	23.98	PASS
64	5320	VHT0	17.5	17.16	16.26	19.83	96.053	23.98	PASS
100	5500	VHT0	17.5	17.14	16.64	19.99	99.748	23.98	PASS
116	5580	VHT0	17	17.28	16.2	19.87	96.947	23.98	PASS
140	5700	VHT0	17	16.88	16.18	19.64	91.959	23.98	PASS
144	5720(U-NII 2C)	VHT0	17	15.41	14.62	18.12	64.924	23.26	PASS
144	5720 (U-NII 3)	VHT0	17	11.49	10.71	14.21	26.345	30	PASS
149	5745	VHT0	17	16.91	16.11	19.62	91.627	30	PASS
157	5785	VHT0	17	16.73	16.44	19.68	92.881	30	PASS
165	5825	VHT0	17	16.57	16.46	19.61	91.352	30	PASS

Unless otherwise stated the results shown in this test report refer only to the sample(s) tested and such sample(s) are retained for 90 days only.

除非另有說明，此報告結果僅對測試之樣品負責，同時此樣品僅保留90天。本報告未經本公司書面許可，不可部份複製。

This document is issued by the Company subject to its General Conditions of Service printed overleaf, available on request or accessible at <http://www.sgs.com.tw/Terms-and-Conditions> and for electronic format documents, subject to Terms and Conditions for Electronic Documents at <http://www.sgs.com.tw/Terms-and-Conditions>. Attention is drawn to the limitation of liability, indemnification and jurisdiction issues defined therein. Any holder of this document is advised that information contained hereon reflects the Company's findings at the time of its intervention only and within the limits of Client's instructions, if any. The Company's sole responsibility is to its Client and this document does not exonerate parties to a transaction from exercising all their rights and obligations under the transaction documents. This document cannot be reproduced except in full, without prior written approval of the Company. Any unauthorized alteration, forgery or falsification of the content or appearance of this document is unlawful and offenders may be prosecuted to the fullest extent of the law.

802.11n_HT40_Ch0

CH	Frequency (MHz)	Data Rate	Power set	TOTAL POWER (dBm)	TOTAL POWER (mW)	REQUIRED LIMIT (dBm)	RESULT
38	5190	MCS0	16.5	15.86	38.565	23.98	PASS
46	5230	MCS0	16.5	15.84	38.388	23.98	PASS
54	5270	MCS0	16.5	15.88	38.743	23.98	PASS
62	5310	MCS0	16.5	15.80	38.036	23.98	PASS
102	5510	MCS0	16.5	15.84	38.388	23.98	PASS
110	5550	MCS0	16.5	15.89	38.832	23.98	PASS
134	5670	MCS0	16	15.80	38.036	23.98	PASS
151	5755	MCS0	16	15.69	37.085	30	PASS
159	5795	MCS0	16	15.82	38.211	30	PASS

802.11n_HT40_Ch1

CH	Frequency (MHz)	Data Rate	Power set	TOTAL POWER (dBm)	TOTAL POWER (mW)	REQUIRED LIMIT (dBm)	RESULT
38	5190	MCS0	16	15.79	37.948	23.98	PASS
46	5230	MCS0	16	15.67	36.914	23.98	PASS
54	5270	MCS0	16	15.85	38.476	23.98	PASS
62	5310	MCS0	16	15.77	37.774	23.98	PASS
102	5510	MCS0	16	15.79	37.948	23.98	PASS
110	5550	MCS0	16	15.86	38.565	23.98	PASS
134	5670	MCS0	15.5	15.69	37.085	23.98	PASS
151	5755	MCS0	15.5	15.65	36.745	30	PASS
159	5795	MCS0	15.5	15.55	35.908	30	PASS

802.11n_HT40_MIMO

CH	Frequency (MHz)	Data Rate	Power set	Avg. POWER (dBm)		TOTAL POWER (dBm)	TOTAL POWER (mW)	REQUIRED LIMIT (dBm)	RESULT
				CH 0	CH 1				
38	5190	MCS8	16	15.63	15.21	18.60	72.399	23.98	PASS
46	5230	MCS8	16	15.59	15.14	18.54	71.500	23.98	PASS
54	5270	MCS8	16	15.81	15.43	18.80	75.795	23.98	PASS
62	5310	MCS8	16	15.9	15.24	18.75	75.072	23.98	PASS
102	5510	MCS8	16	15.93	15.3	18.80	75.834	23.98	PASS
110	5550	MCS8	16	16.09	15.22	18.85	76.718	23.98	PASS
134	5670	MCS8	16	15.97	15.53	18.93	78.123	23.98	PASS
151	5755	MCS8	16	15.81	15.36	18.76	75.215	30	PASS
159	5795	MCS8	16	15.77	15.59	18.85	76.792	30	PASS

Unless otherwise stated the results shown in this test report refer only to the sample(s) tested and such sample(s) are retained for 90 days only.

除非另有說明，此報告結果僅對測試之樣品負責，同時此樣品僅保留90天。本報告未經本公司書面許可，不可部份複製。

This document is issued by the Company subject to its General Conditions of Service printed overleaf, available on request or accessible at <http://www.sgs.com.tw/Terms-and-Conditions> and for electronic format documents, subject to Terms and Conditions for Electronic Documents at <http://www.sgs.com.tw/Terms-and-Conditions>. Attention is drawn to the limitation of liability, indemnification and jurisdiction issues defined therein. Any holder of this document is advised that information contained hereon reflects the Company's findings at the time of its intervention only and within the limits of Client's instructions, if any. The Company's sole responsibility is to its Client and this document does not exonerate parties to a transaction from exercising all their rights and obligations under the transaction documents. This document cannot be reproduced except in full, without prior written approval of the Company. Any unauthorized alteration, forgery or falsification of the content or appearance of this document is unlawful and offenders may be prosecuted to the fullest extent of the law.

802.11ac_VHT40_Ch0

CH	Frequency (MHz)	Data Rate	Power set	TOTAL POWER (dBm)	TOTAL POWER (mW)	REQUIRED LIMIT (dBm)	RESULT
38	5190	VHT0	16.5	15.94	39.278	23.98	PASS
46	5230	VHT0	17	15.98	39.641	23.98	PASS
54	5270	VHT0	16.5	15.99	39.733	23.98	PASS
62	5310	VHT0	16.5	15.97	39.550	23.98	PASS
102	5510	VHT0	16.5	15.88	38.739	23.98	PASS
110	5550	VHT0	16.5	15.91	39.008	23.98	PASS
134	5670	VHT0	16.5	15.99	39.733	23.98	PASS
151	5755	VHT0	16.5	15.96	39.459	30	PASS
159	5795	VHT0	16.5	15.98	39.641	30	PASS

802.11ac_VHT40_Ch1

CH	Frequency (MHz)	Data Rate	Power set	TOTAL POWER (dBm)	TOTAL POWER (mW)	REQUIRED LIMIT (dBm)	RESULT
38	5190	VHT0	16	15.82	38.207	23.98	PASS
46	5230	VHT0	16	15.72	37.338	23.98	PASS
54	5270	VHT0	16	15.86	38.561	23.98	PASS
62	5310	VHT0	16	15.95	39.368	23.98	PASS
102	5510	VHT0	16	15.86	38.561	23.98	PASS
110	5550	VHT0	16	15.90	38.918	23.98	PASS
134	5670	VHT0	16	15.95	39.368	23.98	PASS
151	5755	VHT0	16	15.93	39.188	30	PASS
159	5795	VHT0	16	15.82	38.207	30	PASS

802.11ac_VHT40_MIMO

CH	Frequency (MHz)	Data Rate	Power set	Avg. POWER (dBm)		TOTAL POWER (dBm)	TOTAL POWER (mW)	REQUIRED LIMIT (dBm)	RESULT
				CH 0	CH 1				
38	5190	VHT0	16	15.66	15.29	18.65	73.295	23.98	PASS
46	5230	VHT0	16	15.72	15.16	18.62	72.791	23.98	PASS
54	5270	VHT0	16	15.79	15.5	18.82	76.194	23.98	PASS
62	5310	VHT0	16	15.92	15.38	18.83	76.387	23.98	PASS
102	5510	VHT0	16	16.02	15.31	18.85	76.759	23.98	PASS
110	5550	VHT0	16	16.06	15.33	18.88	77.305	23.98	PASS
134	5670	VHT0	16	15.98	15.63	18.98	79.073	23.98	PASS
151	5755	VHT0	16	15.85	15.59	18.89	77.513	30	PASS
159	5795	VHT0	16	15.85	15.77	18.98	79.104	30	PASS

Unless otherwise stated the results shown in this test report refer only to the sample(s) tested and such sample(s) are retained for 90 days only.

除非另有說明，此報告結果僅對測試之樣品負責，同時此樣品僅保留90天。本報告未經本公司書面許可，不可部份複製。

This document is issued by the Company subject to its General Conditions of Service printed overleaf, available on request or accessible at <http://www.sgs.com.tw/Terms-and-Conditions> and for electronic format documents, subject to Terms and Conditions for Electronic Documents at <http://www.sgs.com.tw/Terms-and-Conditions>. Attention is drawn to the limitation of liability, indemnification and jurisdiction issues defined therein. Any holder of this document is advised that information contained hereon reflects the Company's findings at the time of its intervention only and within the limits of Client's instructions, if any. The Company's sole responsibility is to its Client and this document does not exonerate parties to a transaction from exercising all their rights and obligations under the transaction documents. This document cannot be reproduced except in full, without prior written approval of the Company. Any unauthorized alteration, forgery or falsification of the content or appearance of this document is unlawful and offenders may be prosecuted to the fullest extent of the law.

802.11ac_VHT80_Ch0

CH	Frequency (MHz)	Data Rate	Power set	TOTAL POWER (dBm)	TOTAL POWER (mW)	REQUIRED LIMIT (dBm)	RESULT
42	5210	VHT0	16	14.91	31.006	23.98	PASS
58	5290	VHT0	16	14.73	29.748	23.98	PASS
106	5530	VHT0	16	14.98	31.510	23.98	PASS
122	5610	VHT0	16	14.95	31.293	23.98	PASS
155	5775	VHT0	16	14.80	30.231	30	PASS

802.11ac_VHT80_Ch1

CH	Frequency (MHz)	Data Rate	Power set	TOTAL POWER (dBm)	TOTAL POWER (mW)	REQUIRED LIMIT (dBm)	RESULT
42	5210	VHT0	15.5	14.86	30.652	23.98	PASS
58	5290	VHT0	15.5	14.70	29.543	23.98	PASS
106	5530	VHT0	15.5	14.91	31.006	23.98	PASS
122	5610	VHT0	15.5	14.89	30.864	23.98	PASS
155	5775	VHT0	15.5	14.77	30.023	30	PASS

802.11ac_VHT80_MIMO

CH	Frequency (MHz)	Data Rate	Power set	Avg. POWER (dBm)		TOTAL POWER (dBm)	TOTAL POWER (mW)	REQUIRED LIMIT (dBm)	RESULT
				CH 0	CH 1				
42	5210	VHT0	15.5	14.72	14.25	17.83	60.620	23.98	PASS
58	5290	VHT0	16	14.89	14.4	17.99	62.903	23.98	PASS
106	5530	VHT0	15.5	14.78	14.32	17.89	61.531	23.98	PASS
122	5610	VHT0	15.5	14.79	14.37	17.92	61.943	23.98	PASS
155	5775	VHT0	15	14.48	14.45	17.80	60.254	30	PASS

Unless otherwise stated the results shown in this test report refer only to the sample(s) tested and such sample(s) are retained for 90 days only.

除非另有說明，此報告結果僅對測試之樣品負責，同時此樣品僅保留90天。本報告未經本公司書面許可，不可部份複製。

This document is issued by the Company subject to its General Conditions of Service printed overleaf, available on request or accessible at <http://www.sgs.com.tw/Terms-and-Conditions> and for electronic format documents, subject to Terms and Conditions for Electronic Documents at <http://www.sgs.com.tw/Terms-and-Conditions>. Attention is drawn to the limitation of liability, indemnification and jurisdiction issues defined therein. Any holder of this document is advised that information contained hereon reflects the Company's findings at the time of its intervention only and within the limits of Client's instructions, if any. The Company's sole responsibility is to its Client and this document does not exonerate parties to a transaction from exercising all their rights and obligations under the transaction documents. This document cannot be reproduced except in full, without prior written approval of the Company. Any unauthorized alteration, forgery or falsification of the content or appearance of this document is unlawful and offenders may be prosecuted to the fullest extent of the law.

10 MAXIMUM POWER SPECTRAL DENSITY

10.1 Standard Applicable

FCC

Operation Band	EUT CATEGORY		LIMIT	Antenna Directional Gain Requirements
U-NII-1	<input type="checkbox"/>	Outdoor Access Point (Master)	1. 17dBm/ MHz 2. EIRP<=125mW(21dBm) at any elevation angle > 30°	6dBi
	<input type="checkbox"/>	Indoor Access Point (Master)	17dBm/ MHz	6dBi
	<input type="checkbox"/>	Fixed point-to-point Access Point	17dBm/ MHz	23dBi
	<input checked="" type="checkbox"/>	Client device	11dBm/ MHz	6dBi
U-NII-2A	All		11dBm/ MHz	6dBi
U-NII-2C	All		11dBm/ MHz	6dBi
U-NII-3	All		30dBm/ 500kHz	6dBi

If transmitting antennas of directional gain greater than the Antenna Directional Gain Requirements column, the Maximum transmit power shall be reduced by the amount in dB that the directional gain of the antenna.

Note:

As per section F. 2). e). (ii) of FCC KDB 662911 D01

If antenna gains are not equal and each transmit antenna is driven by only one spatial stream, directional gain may be calculated by either of the following formulas.

$$DirectionalGain = 10 \cdot \log \left[\frac{\sum_{j=1}^{N_{SS}} \left\{ \sum_{k=1}^{N_{ANT}} g_{j,k} \right\}^2}{N_{ANT}} \right]$$

where

Each antenna is driven by no more than one spatial stream;

NSS = the number of independent spatial streams of data;

NANT = the total number of antennas

g_{j,k} = / 20 10Gk if the kth antenna is being fed by spatial stream j, or zero if it is not;

G_k is the gain in dBi of the kth antenna.

The antenna gain is not greater than 6 dBi. Therefore, reduction of power is not required.

Unless otherwise stated the results shown in this test report refer only to the sample(s) tested and such sample(s) are retained for 90 days only.

除非另有說明，此報告結果僅對測試之樣品負責，同時此樣品僅保留90天。本報告未經本公司書面許可，不可部份複製。

This document is issued by the Company subject to its General Conditions of Service printed overleaf, available on request or accessible at <http://www.sgs.com.tw/Terms-and-Conditions> and for electronic format documents, subject to Terms and Conditions for Electronic Documents at <http://www.sgs.com.tw/Terms-and-Conditions>. Attention is drawn to the limitation of liability, indemnification and jurisdiction issues defined therein. Any holder of this document is advised that information contained hereon reflects the Company's findings at the time of its intervention only and within the limits of Client's instructions, if any. The Company's sole responsibility is to its Client and this document does not exonerate parties to a transaction from exercising all their rights and obligations under the transaction documents. This document cannot be reproduced except in full, without prior written approval of the Company. Any unauthorized alteration, forgery or falsification of the content or appearance of this document is unlawful and offenders may be prosecuted to the fullest extent of the law.

10.2 Measurement Procedure

1. Place the EUT on the table and set it in transmitting mode.
2. The testing follows FCC KDB 789033 D02 General UNII Test Procedures New Rules .
3. Remove the antenna from the EUT and then connect a low loss RF cable from the antenna port to Spectrum.
4. **For U-NII1, U-NII-2A, U-NII-2C Band:**
Set RBW=1MHz, VBW=3MHz, where span is enough to capture the entire bandwidth, Sweep time = Auto (1001 pts), Detector = power averaging (rms), if available. Otherwise, use sample detector mode, traces 100 sweeps of video averaging. (SA-2 with the omission of procedure x, the integration with 26dB EBW bandwidth)
For U-NII-3 Band:
Set RBW=300kHz, VBW=1MHz, where span is enough to capture the entire bandwidth, Sweep time = Auto, detector = RMS or sample, traces 100 sweeps of video averaging. In addition, measurement bandwidth of Maximum PSD is specified in 500 kHz, add 10 log (500 kHz/RBW) to the measured result.
5. Use the cursor on spectrum to peak search the highest level of trace
6. Record the max. reading and add 10 log(1/duty cycle).
7. Repeat above procedures until all default test channel (low, middle, and high) was complete.
8. MIMO mode: offset is set following “measure and add 10 Log (N)” on spectrum to measure the PSD for MIMO mode. Offset = cable loss + 10 log (N), where N is number of transmitting antenna.

Note: For the test of PSD at MIMO mode, the highest emission of worst case employing Measure and add 10 log (N) technical is reported after the comparison between Main Antenna at single transmitting mode and Aux that yields the higher value. The MIMO transmitting mode produces higher value of outcome.

Unless otherwise stated the results shown in this test report refer only to the sample(s) tested and such sample(s) are retained for 90 days only.

除非另有說明，此報告結果僅對測試之樣品負責，同時此樣品僅保留90天。本報告未經本公司書面許可，不可部份複製。

This document is issued by the Company subject to its General Conditions of Service printed overleaf, available on request or accessible at <http://www.sgs.com.tw/Terms-and-Conditions> and for electronic format documents, subject to Terms and Conditions for Electronic Documents at <http://www.sgs.com.tw/Terms-and-Conditions>. Attention is drawn to the limitation of liability, indemnification and jurisdiction issues defined therein. Any holder of this document is advised that information contained hereon reflects the Company's findings at the time of its intervention only and within the limits of Client's instructions, if any. The Company's sole responsibility is to its Client and this document does not exonerate parties to a transaction from exercising all their rights and obligations under the transaction documents. This document cannot be reproduced except in full, without prior written approval of the Company. Any unauthorized alteration, forgery or falsification of the content or appearance of this document is unlawful and offenders may be prosecuted to the fullest extent of the law.

10.3 Measurement Equipment Used

Conducted Emission Test Site: Conducted G					
EQUIPMENT TYPE	MFR	MODEL NUMBER	SERIAL NUMBER	LAST CAL.	CAL DUE.
Spectrum Analyzer	KEYSIGHT	N9010A	MY57120290	04/06/2021	04/05/2022
Attenuator	Marvelous	MVE2213-10	RF09	11/19/2020	11/18/2021
DC Block	PASTERNAK	PE8210	RF151	11/19/2020	11/18/2021
Coaxial Cables	Woken	00100A1F2A196C	RF59	11/19/2020	11/18/2021
Coaxial Cables	Woken	00100A1F2A196C	RF68	11/19/2020	11/18/2021
Test Software	SGS Taiwan	Radio Test Software	Ver.21	N/A	N/A

10.4 Test Set-up

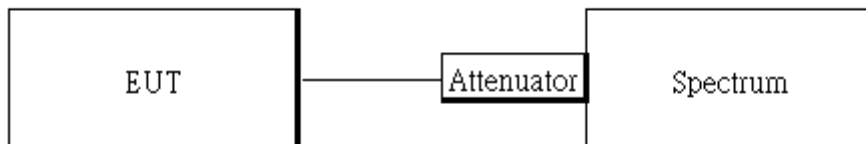

10.5 Measurement Result

POWER DENSITY 802.11a MODE						
Frequency (MHz)	ch0 meas PSD (dBm/MHz)	Duty Factor (dB)	Maxmum Corr'd PSD(dBm/MHz)		Limit	Margin (dB)
5180	5.73	0.00	5.73		11.00 dBm/MHz	-5.27
5220	5.69	0.00	5.69		11.00 dBm/MHz	-5.31
5240	5.44	0.00	5.44		11.00 dBm/MHz	-5.56
5260	5.24	0.00	5.24		11.00 dBm/MHz	-5.76
5300	5.01	0.00	5.01		11.00 dBm/MHz	-5.99
5320	4.31	0.00	4.31		11.00 dBm/MHz	-6.69
5500	4.81	0.00	4.81		11.00 dBm/MHz	-6.19
5580	5.98	0.00	5.98		11.00 dBm/MHz	-5.02
5700	5.53	0.00	5.53		11.00 dBm/MHz	-5.47
5720 (U-NII 2C)	5.61	0.00	5.61		11.00 dBm/MHz	-5.39
Frequency (MHz)	ch0 meas PSD (dBm/300kHz)	Duty Factor (dB)	10log (500kHz/RBW) Factor(dB)	Maxmum Corr'd PSD (dBm/500kHz)	Limit	Margin (dB)
5720 (U-NII 3)	-0.96	0.00	2.22	2.22	30.00 dBm/500kHz	-27.78
5745	0.84	0.00	2.22	3.06	30.00 dBm/500kHz	-26.95
5785	0.61	0.00	2.22	2.83	30.00 dBm/500kHz	-27.17
5825	0.60	0.00	2.22	2.82	30.00 dBm/500kHz	-27.18

Unless otherwise stated the results shown in this test report refer only to the sample(s) tested and such sample(s) are retained for 90 days only.

除非另有說明，此報告結果僅對測試之樣品負責，同時此樣品僅保留90天。本報告未經本公司書面許可，不可部份複製。

This document is issued by the Company subject to its General Conditions of Service printed overleaf, available on request or accessible at <http://www.sgs.com.tw/Terms-and-Conditions> and for electronic format documents, subject to Terms and Conditions for Electronic Documents at <http://www.sgs.com.tw/Terms-and-Conditions>. Attention is drawn to the limitation of liability, indemnification and jurisdiction issues defined therein. Any holder of this document is advised that information contained hereon reflects the Company's findings at the time of its intervention only and within the limits of Client's instructions, if any. The Company's sole responsibility is to its Client and this document does not exonerate parties to a transaction from exercising all their rights and obligations under the transaction documents. This document cannot be reproduced except in full, without prior written approval of the Company. Any unauthorized alteration, forgery or falsification of the content or appearance of this document is unlawful and offenders may be prosecuted to the fullest extent of the law.

POWER DENSITY 802.11ac VHT20 MODE							
Frequency (MHz)	ch0 meas PSD (dBm/MHz)	ch1 meas PSD (dBm/MHz)	Duty Factor (dB)	Maxmum Corr'd PSD(dBm/MHz)	Limit	Margin (dB)	
5180	4.42	4.50	0.00	7.47	11.00 dBm/MHz	-3.53	
5220	4.05	4.18	0.00	7.13	11.00 dBm/MHz	-3.87	
5240	4.32	4.33	0.00	7.33	11.00 dBm/MHz	-3.67	
5260	4.63	4.50	0.00	7.58	11.00 dBm/MHz	-3.42	
5300	4.57	4.56	0.00	7.58	11.00 dBm/MHz	-3.42	
5320	4.37	3.95	0.00	7.17	11.00 dBm/MHz	-3.83	
5500	4.67	4.61	0.00	7.65	11.00 dBm/MHz	-3.35	
5580	6.21	6.22	0.00	9.23	11.00 dBm/MHz	-1.77	
5700	5.98	5.63	0.00	8.82	11.00 dBm/MHz	-2.18	
5720 (U-NII 2C)	5.57	6.13	0.00	8.87	11.00 dBm/MHz	-2.13	
Frequency (MHz)	ch0 meas PSD (dBm/300kHz)	ch1 meas PSD (dBm/300kHz)	Duty Factor (dB)	10log (500kHz/RBW) Factor(dB)	Maxmum Corr'd PSD(dBm/500k Hz)	Limit	Margin (dB)
5720 (U-NII 3)	-0.45	-0.33	0.00	2.22	4.84	30.00 dBm/500kHz	-25.16
5745	1.18	1.44	0.00	2.22	6.54	30.00 dBm/500kHz	-23.46
5785	0.87	1.30	0.00	2.22	6.32	30.00 dBm/500kHz	-23.68
5825	0.77	0.22	0.00	2.22	5.74	30.00 dBm/500kHz	-24.26

POWER DENSITY 802.11ac VHT40 MODE							
Frequency (MHz)	ch0 meas PSD (dBm/MHz)	ch1 meas PSD (dBm/MHz)	Duty Factor (dB)	Maxmum Corr'd PSD(dBm/MHz)	Limit	Margin (dB)	
5190	1.34	1.01	0.16	4.35	11.00 dBm/MHz	-6.65	
5230	0.81	0.86	0.16	4.00	11.00 dBm/MHz	-7.00	
5270	1.20	0.95	0.16	4.25	11.00 dBm/MHz	-6.75	
5310	0.31	0.25	0.16	3.45	11.00 dBm/MHz	-7.55	
5510	1.01	1.05	0.16	4.20	11.00 dBm/MHz	-6.80	
5550	2.26	2.16	0.16	5.38	11.00 dBm/MHz	-5.62	
5670	2.18	2.43	0.16	5.48	11.00 dBm/MHz	-5.52	
Frequency (MHz)	ch0 meas PSD (dBm/300kHz)	ch1 meas PSD (dBm/300kHz)	Duty Factor (dB)	10log (500kHz/RBW) Factor(dB)	Maxmum Corr'd PSD(dBm/500k Hz)	Limit	Margin (dB)
5755	-2.76	-2.92	0.16	2.22	2.55	30.00 dBm/500kHz	-27.45
5795	-3.34	-2.89	0.16	2.22	2.28	30.00 dBm/500kHz	-27.72

Unless otherwise stated the results shown in this test report refer only to the sample(s) tested and such sample(s) are retained for 90 days only.

除非另有說明，此報告結果僅對測試之樣品負責，同時此樣品僅保留90天。本報告未經本公司書面許可，不可部份複製。

This document is issued by the Company subject to its General Conditions of Service printed overleaf, available on request or accessible at <http://www.sgs.com.tw/Terms-and-Conditions> and for electronic format documents, subject to Terms and Conditions for Electronic Documents at <http://www.sgs.com.tw/Terms-and-Conditions>. Attention is drawn to the limitation of liability, indemnification and jurisdiction issues defined therein. Any holder of this document is advised that information contained hereon reflects the Company's findings at the time of its intervention only and within the limits of Client's instructions, if any. The Company's sole responsibility is to its Client and this document does not exonerate parties to a transaction from exercising all their rights and obligations under the transaction documents. This document cannot be reproduced except in full, without prior written approval of the Company. Any unauthorized alteration, forgery or falsification of the content or appearance of this document is unlawful and offenders may be prosecuted to the fullest extent of the law.

POWER DENSITY 802.11ac VHT80 MODE							
Frequency (MHz)	ch0 meas PSD (dBm/MHz)	ch1 meas PSD (dBm/MHz)	Duty Factor (dB)	Maxmum Corr'd PSD(dBm/MHz)		Limit	Margin (dB)
5210	-3.97	-4.17	0.32	-0.74		11.00 dBm/MHz	-11.74
5290	-3.65	-3.43	0.32	-0.21		11.00 dBm/MHz	-11.21
5530	-3.38	-3.71	0.32	-0.21		11.00 dBm/MHz	-11.21
5610	-2.73	-2.63	0.32	0.65		11.00 dBm/MHz	-10.35
Frequency (MHz)	ch0 meas PSD (dBm/300kHz)	ch1 meas PSD (dBm/300kHz)	Duty Factor (dB)	10log (500kHz/RBW) Factor(dB)	Maxmum Corr'd PSD(dBm/500k Hz)	Limit	Margin (dB)
5775	-7.82	-8.17	0.32	2.22	-2.44	30.00 dBm/500kHz	-32.44

Unless otherwise stated the results shown in this test report refer only to the sample(s) tested and such sample(s) are retained for 90 days only.

除非另有說明，此報告結果僅對測試之樣品負責，同時此樣品僅保留90天。本報告未經本公司書面許可，不可部份複製。

This document is issued by the Company subject to its General Conditions of Service printed overleaf, available on request or accessible at <http://www.sgs.com.tw/Terms-and-Conditions> and for electronic format documents, subject to Terms and Conditions for Electronic Documents at <http://www.sgs.com.tw/Terms-and-Conditions>. Attention is drawn to the limitation of liability, indemnification and jurisdiction issues defined therein. Any holder of this document is advised that information contained hereon reflects the Company's findings at the time of its intervention only and within the limits of Client's instructions, if any. The Company's sole responsibility is to its Client and this document does not exonerate parties to a transaction from exercising all their rights and obligations under the transaction documents. This document cannot be reproduced except in full, without prior written approval of the Company. Any unauthorized alteration, forgery or falsification of the content or appearance of this document is unlawful and offenders may be prosecuted to the fullest extent of the law.

802.11a_20MHz_Chain0_5180MHz

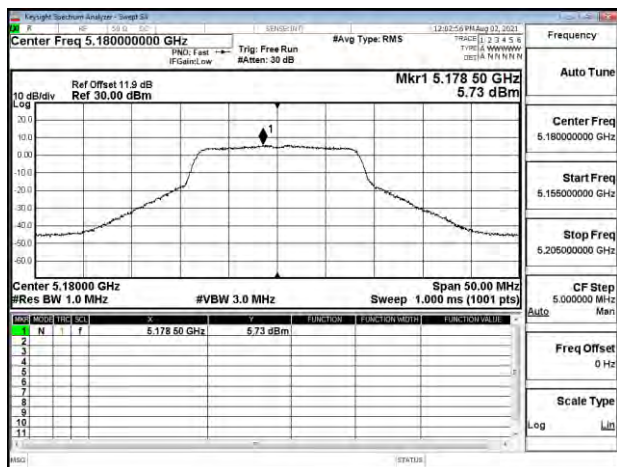

802.11a_20MHz_Chain0_5260MHz

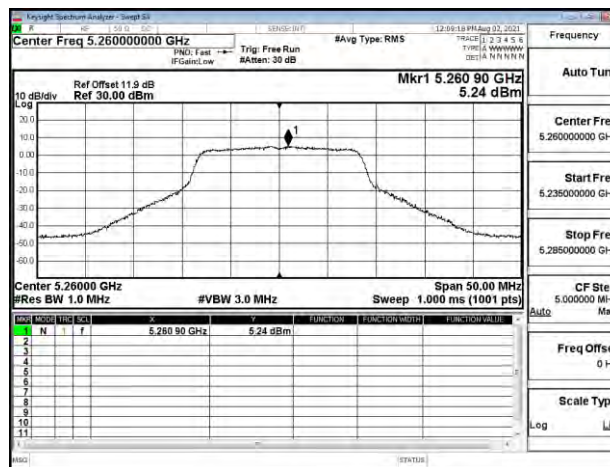

802.11a_20MHz_Chain0_5220MHz

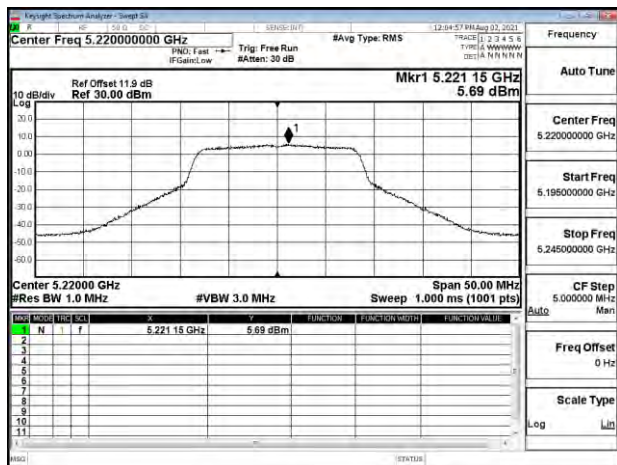

802.11a_20MHz_Chain0_5300MHz

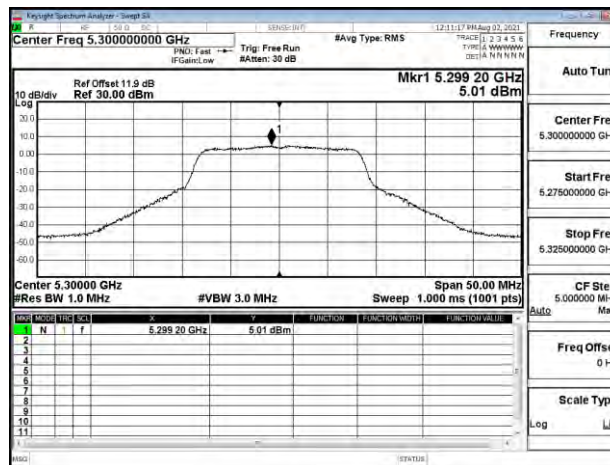

802.11a_20MHz_Chain0_5240MHz

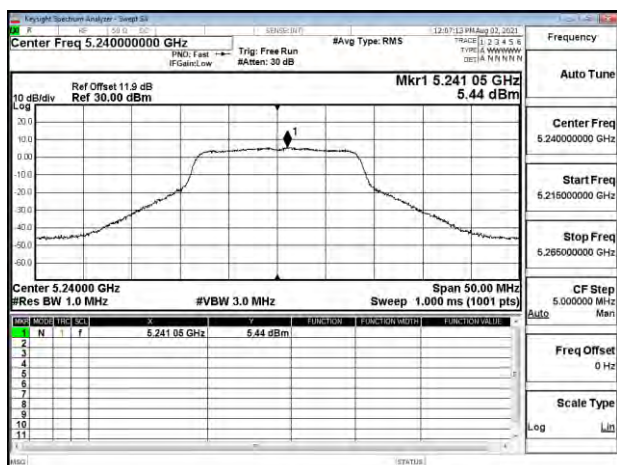

802.11a_20MHz_Chain0_5320MHz

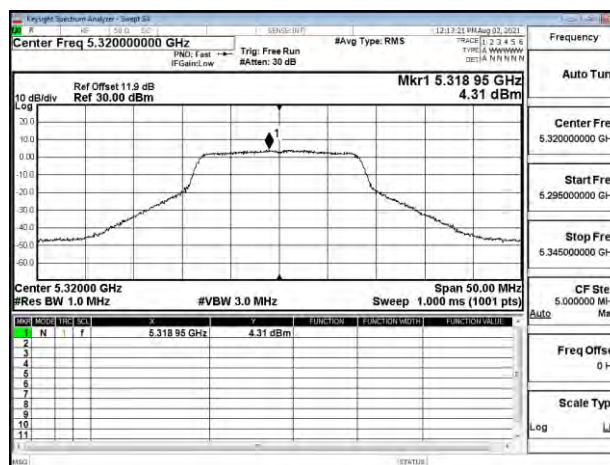

Unless otherwise stated the results shown in this test report refer only to the sample(s) tested and such sample(s) are retained for 90 days only.

除非另有說明，此報告結果僅對測試之樣品負責，同時此樣品僅保留90天。本報告未經本公司書面許可，不可部份複製。

This document is issued by the Company subject to its General Conditions of Service printed overleaf, available on request or accessible at <http://www.sgs.com.tw/Terms-and-Conditions> and for electronic format documents, subject to Terms and Conditions for Electronic Documents at <http://www.sgs.com.tw/Terms-and-Conditions>. Attention is drawn to the limitation of liability, indemnification and jurisdiction issues defined therein. Any holder of this document is advised that information contained herein reflects the Company's findings at the time of its intervention only and within the limits of Client's instructions, if any. The Company's sole responsibility is to its Client and this document does not exonerate parties to a transaction from exercising all their rights and obligations under the transaction documents. This document cannot be reproduced except in full, without prior written approval of the Company. Any unauthorized alteration, forgery or falsification of the content or appearance of this document is unlawful and offenders may be prosecuted to the fullest extent of the law.

802.11a_20MHz_Chain0_5500MHz

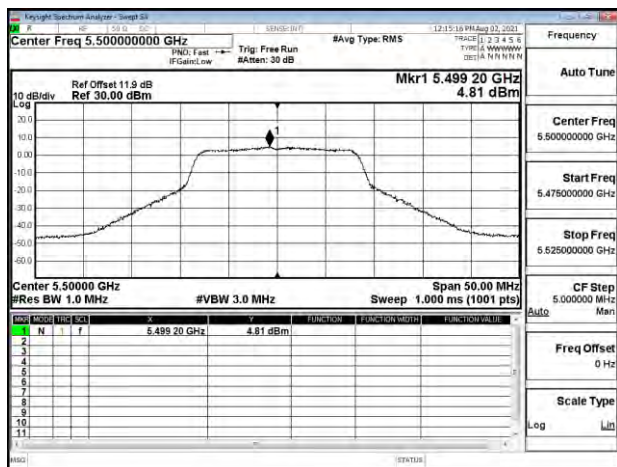

802.11a_20MHz_Chain0_5720MHz_UNII 2C

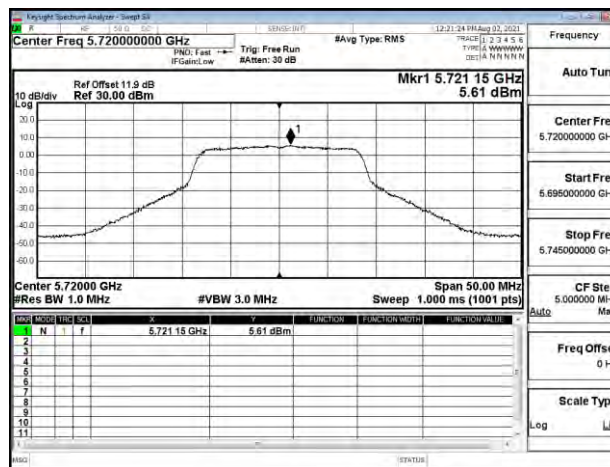

802.11a_20MHz_Chain0_5580MHz

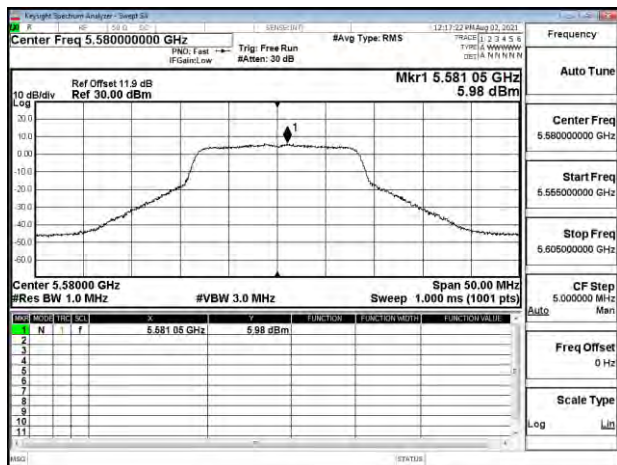

802.11a_20MHz_Chain0_5720MHz_UNII 3

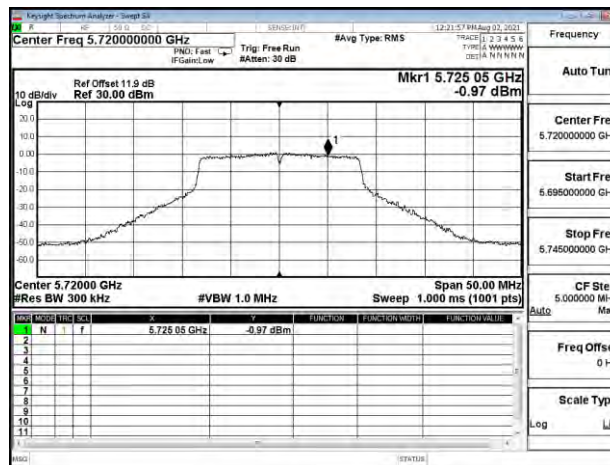

802.11a_20MHz_Chain0_5700MHz

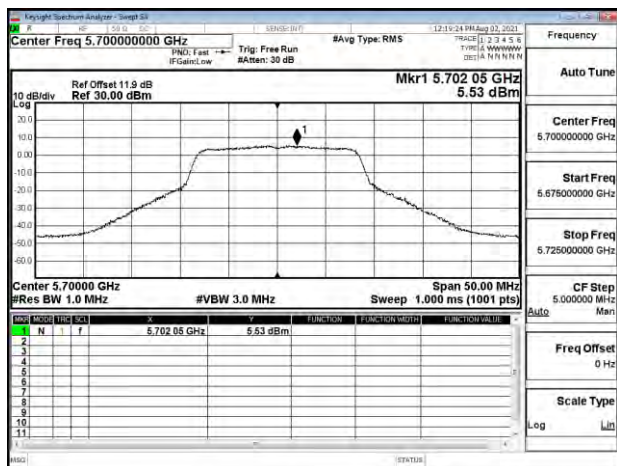

802.11a_20MHz_Chain0_5745MHz

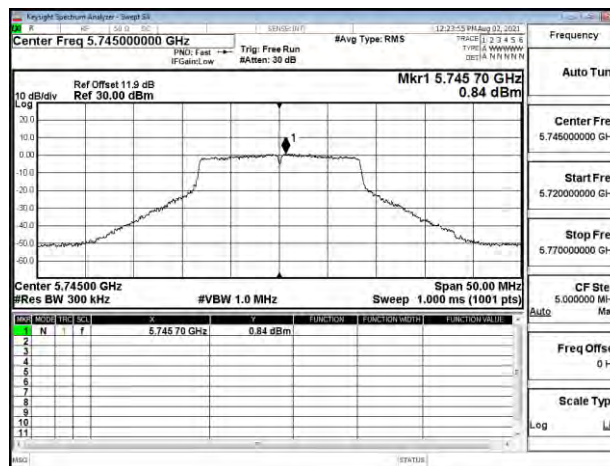

Unless otherwise stated the results shown in this test report refer only to the sample(s) tested and such sample(s) are retained for 90 days only.

除非另有說明，此報告結果僅對測試之樣品負責，同時此樣品僅保留90天。本報告未經本公司書面許可，不可部份複製。

This document is issued by the Company subject to its General Conditions of Service printed overleaf, available on request or accessible at <http://www.sgs.com.tw/Terms-and-Conditions> and for electronic format documents, subject to Terms and Conditions for Electronic Documents at <http://www.sgs.com.tw/Terms-and-Conditions>. Attention is drawn to the limitation of liability, indemnification and jurisdiction issues defined therein. Any holder of this document is advised that information contained herein reflects the Company's findings at the time of its intervention only and within the limits of Client's instructions, if any. The Company's sole responsibility is to its Client and this document does not exonerate parties to a transaction from exercising all their rights and obligations under the transaction documents. This document cannot be reproduced except in full, without prior written approval of the Company. Any unauthorized alteration, forgery or falsification of the content or appearance of this document is unlawful and offenders may be prosecuted to the fullest extent of the law.

802.11a_20MHz_Chain0_5785MHz

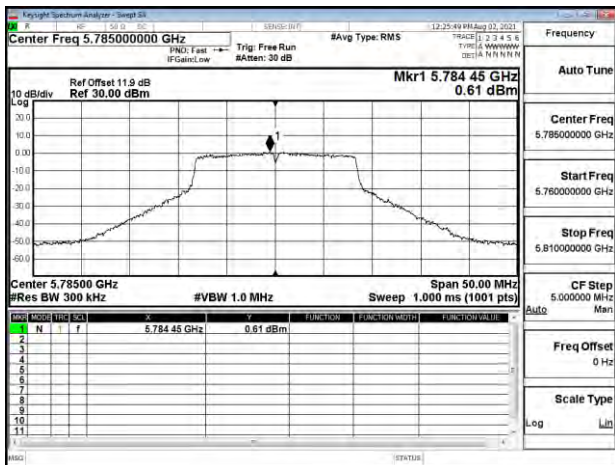

802.11ac_20MHz_Chain0_5220MHz

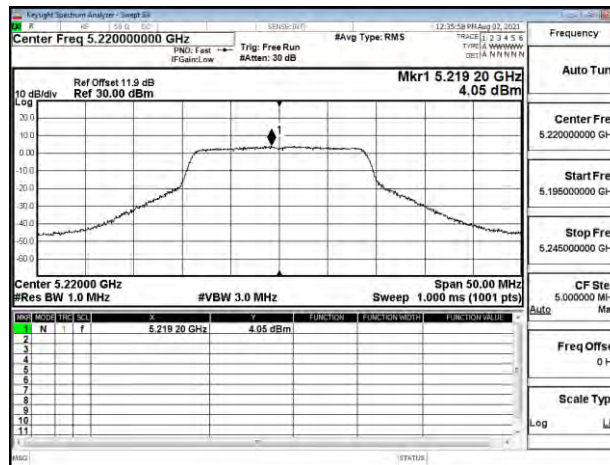

802.11a_20MHz_Chain0_5825MHz

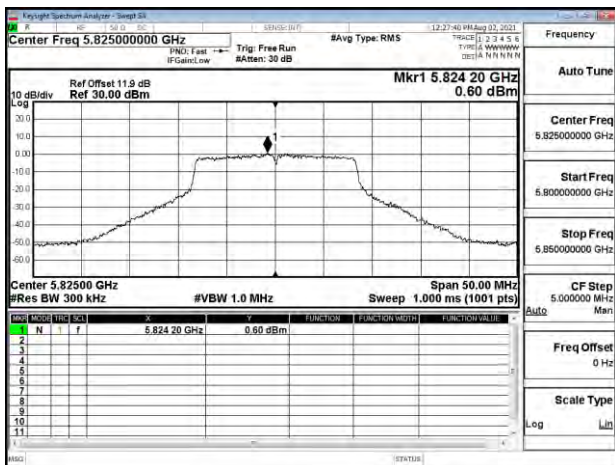

802.11ac_20MHz_Chain0_5240MHz

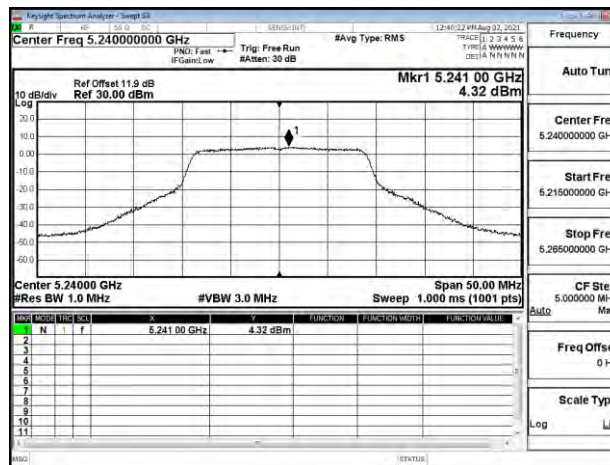

802.11ac_20MHz_Chain0_5180MHz

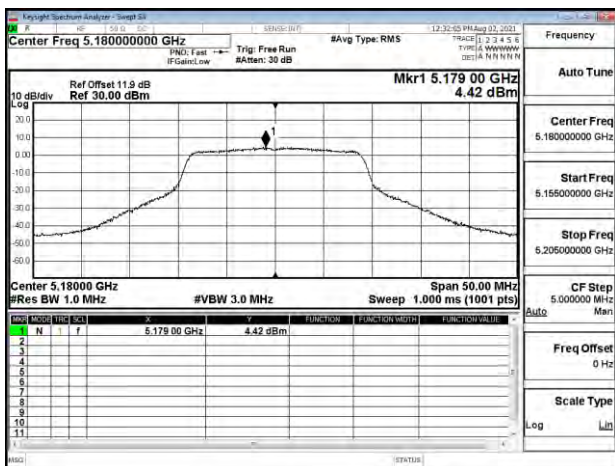

802.11ac_20MHz_Chain0_5260MHz

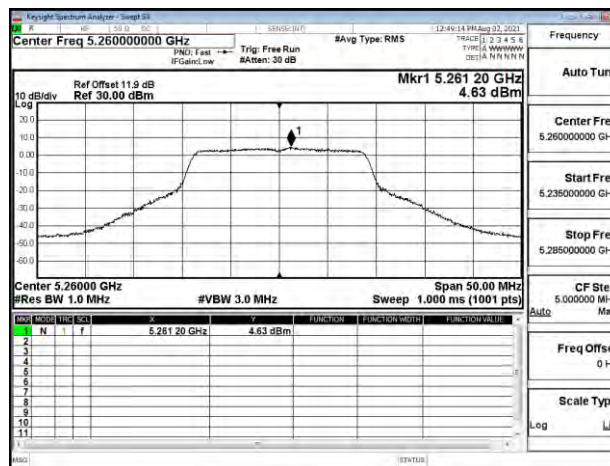

Unless otherwise stated the results shown in this test report refer only to the sample(s) tested and such sample(s) are retained for 90 days only.

除非另有說明，此報告結果僅對測試之樣品負責，同時此樣品僅保留90天。本報告未經本公司書面許可，不可部份複製。

This document is issued by the Company subject to its General Conditions of Service printed overleaf, available on request or accessible at <http://www.sgs.com.tw/Terms-and-Conditions> and for electronic format documents, subject to Terms and Conditions for Electronic Documents at <http://www.sgs.com.tw/Terms-and-Conditions>. Attention is drawn to the limitation of liability, indemnification and jurisdiction issues defined therein. Any holder of this document is advised that information contained herein reflects the Company's findings at the time of its intervention only and within the limits of Client's instructions, if any. The Company's sole responsibility is to its Client and this document does not exonerate parties to a transaction from exercising all their rights and obligations under the transaction documents. This document cannot be reproduced except in full, without prior written approval of the Company. Any unauthorized alteration, forgery or falsification of the content or appearance of this document is unlawful and offenders may be prosecuted to the fullest extent of the law.

802.11ac_20MHz_Chain0_5300MHz

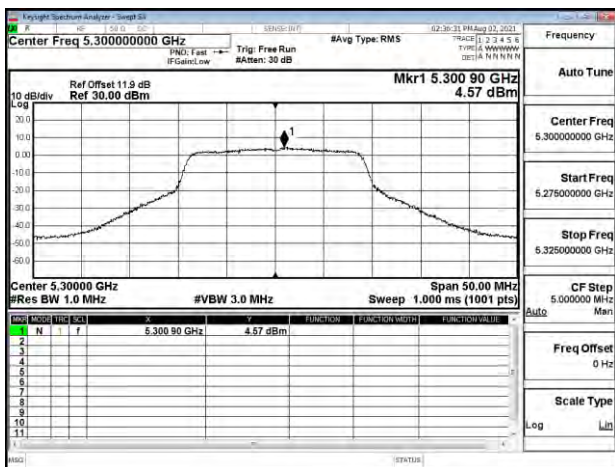

802.11ac_20MHz_Chain0_5580MHz

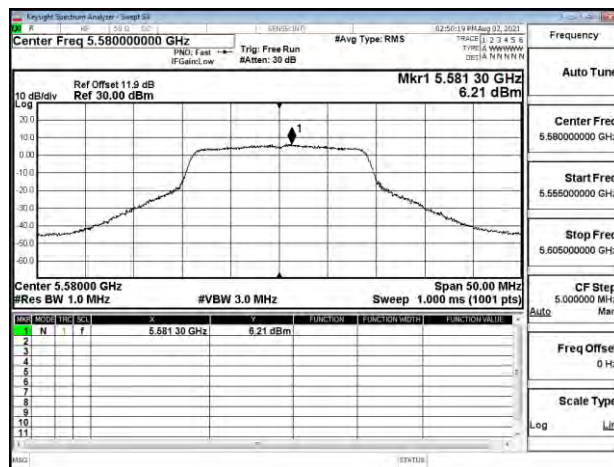

802.11ac_20MHz_Chain0_5320MHz

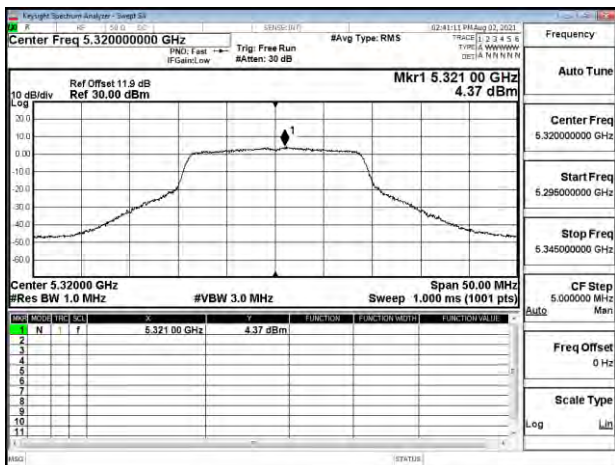

802.11ac_20MHz_Chain0_5700MHz

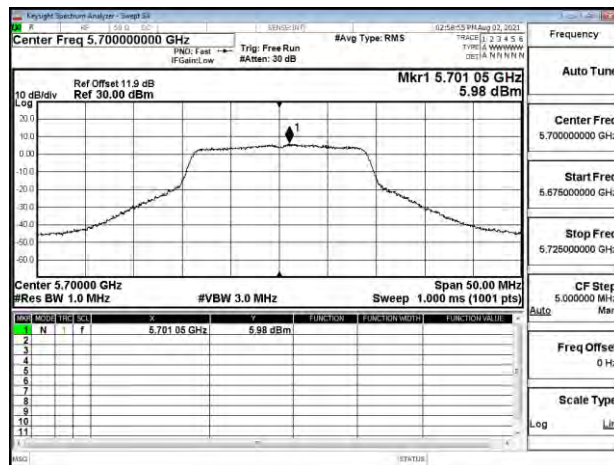

802.11ac_20MHz_Chain0_5500MHz

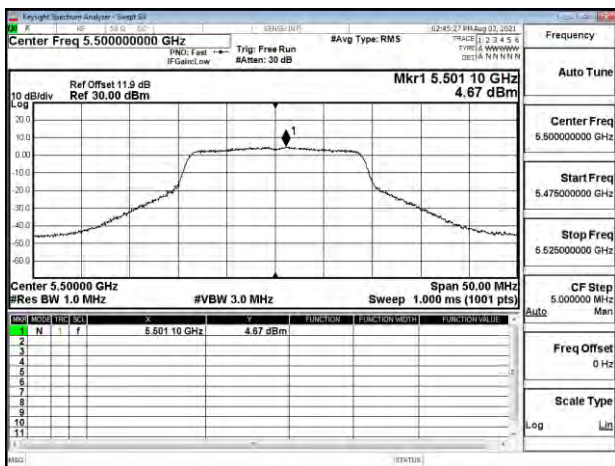

802.11ac_20MHz_Chain0_5720MHz_UNII 2C

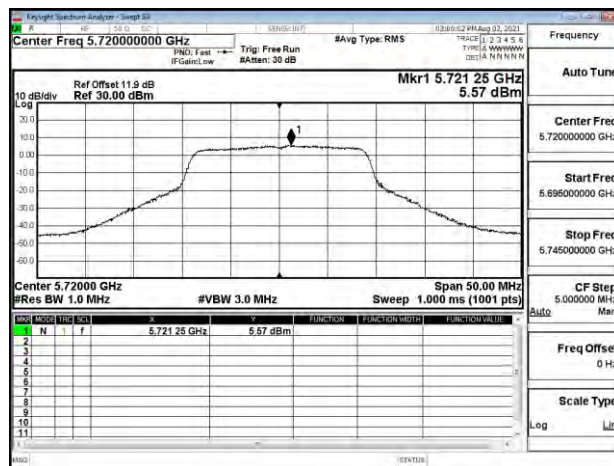

Unless otherwise stated the results shown in this test report refer only to the sample(s) tested and such sample(s) are retained for 90 days only.

除非另有說明，此報告結果僅對測試之樣品負責，同時此樣品僅保留90天。本報告未經本公司書面許可，不可部份複製。

This document is issued by the Company subject to its General Conditions of Service printed overleaf, available on request or accessible at <http://www.sgs.com.tw/Terms-and-Conditions> and for electronic format documents, subject to Terms and Conditions for Electronic Documents at <http://www.sgs.com.tw/Terms-and-Conditions>. Attention is drawn to the limitation of liability, indemnification and jurisdiction issues defined therein. Any holder of this document is advised that information contained herein reflects the Company's findings at the time of its intervention only and within the limits of Client's instructions, if any. The Company's sole responsibility is to its Client and this document does not exonerate parties to a transaction from exercising all their rights and obligations under the transaction documents. This document cannot be reproduced except in full, without prior written approval of the Company. Any unauthorized alteration, forgery or falsification of the content or appearance of this document is unlawful and offenders may be prosecuted to the fullest extent of the law.

802.11ac_20MHz_Chain0_5720MHz_UNII 3

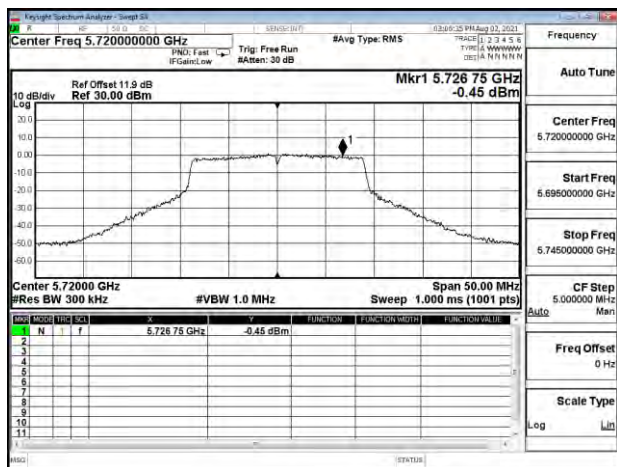

802.11ac_20MHz_Chain0_5825MHz

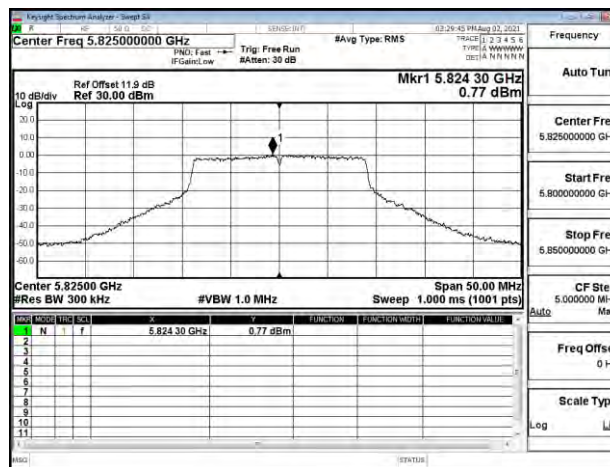

802.11ac_20MHz_Chain0_5745MHz

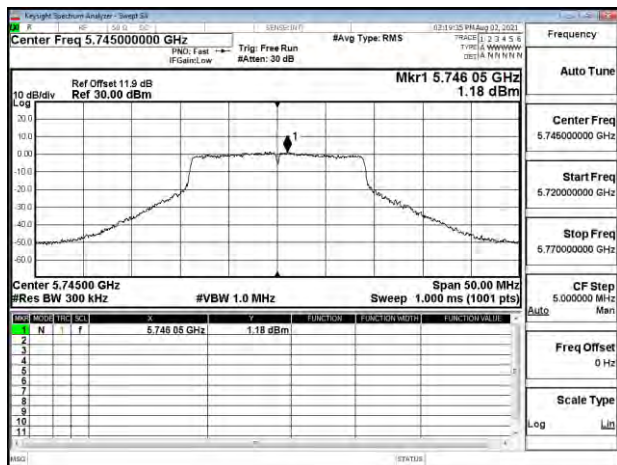

802.11ac_20MHz_Chain1_5180MHz

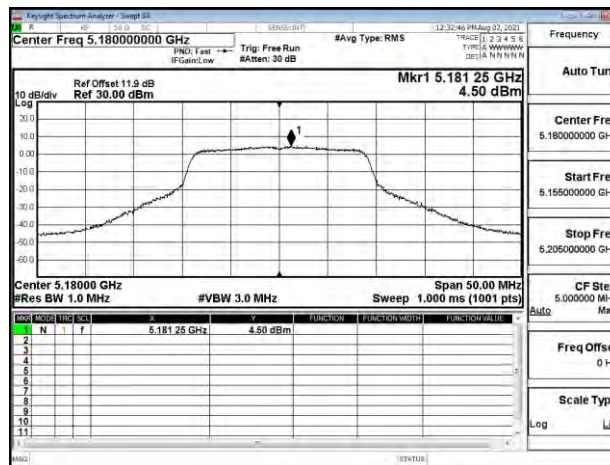

802.11ac_20MHz_Chain0_5785MHz

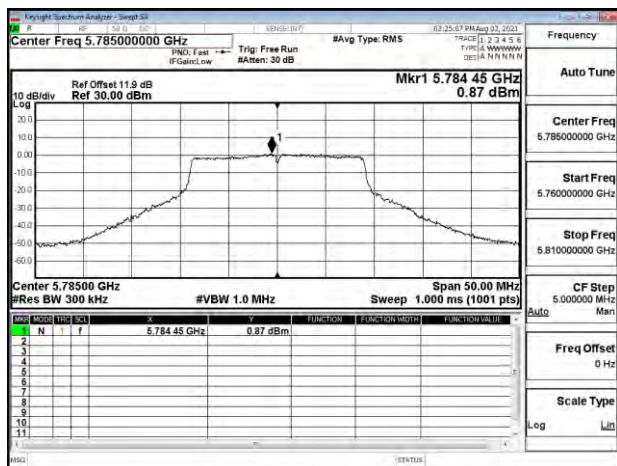

802.11ac_20MHz_Chain1_5220MHz

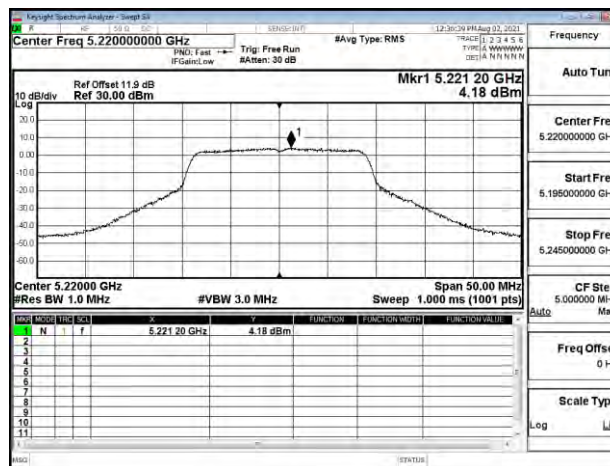

Unless otherwise stated the results shown in this test report refer only to the sample(s) tested and such sample(s) are retained for 90 days only.

除非另有說明，此報告結果僅對測試之樣品負責，同時此樣品僅保留90天。本報告未經本公司書面許可，不可部份複製。

This document is issued by the Company subject to its General Conditions of Service printed overleaf, available on request or accessible at <http://www.sgs.com.tw/Terms-and-Conditions> and for electronic format documents, subject to Terms and Conditions for Electronic Documents at <http://www.sgs.com.tw/Terms-and-Conditions>. Attention is drawn to the limitation of liability, indemnification and jurisdiction issues defined therein. Any holder of this document is advised that information contained herein reflects the Company's findings at the time of its intervention only and within the limits of Client's instructions, if any. The Company's sole responsibility is to its Client and this document does not exonerate parties to a transaction from exercising all their rights and obligations under the transaction documents. This document cannot be reproduced except in full, without prior written approval of the Company. Any unauthorized alteration, forgery or falsification of the content or appearance of this document is unlawful and offenders may be prosecuted to the fullest extent of the law.

802.11ac_20MHz_Chain1_5240MHz

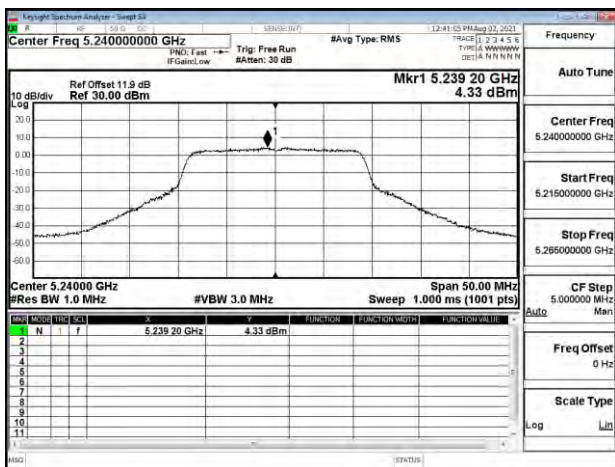

802.11ac_20MHz_Chain1_5320MHz

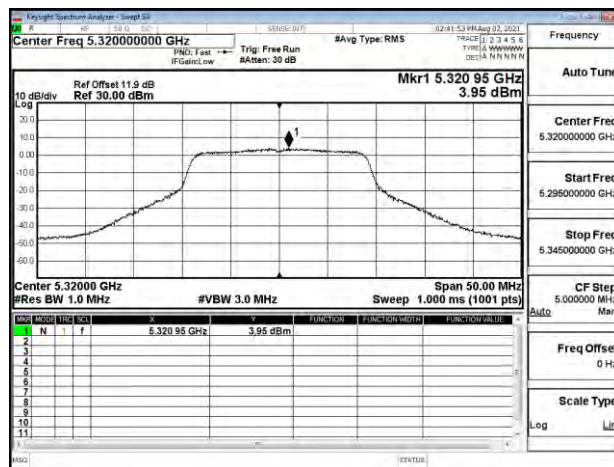

802.11ac_20MHz_Chain1_5260MHz

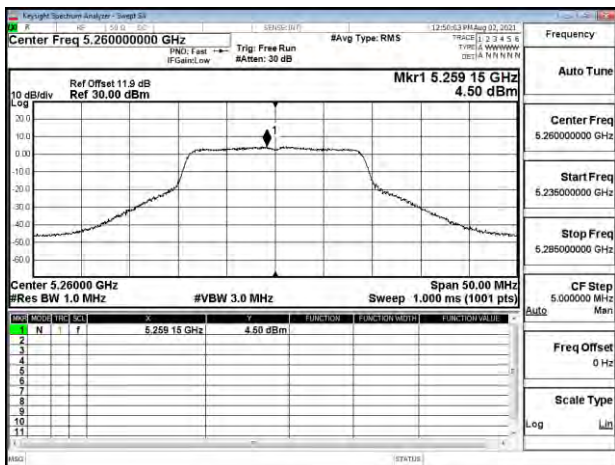

802.11ac_20MHz_Chain1_5500MHz

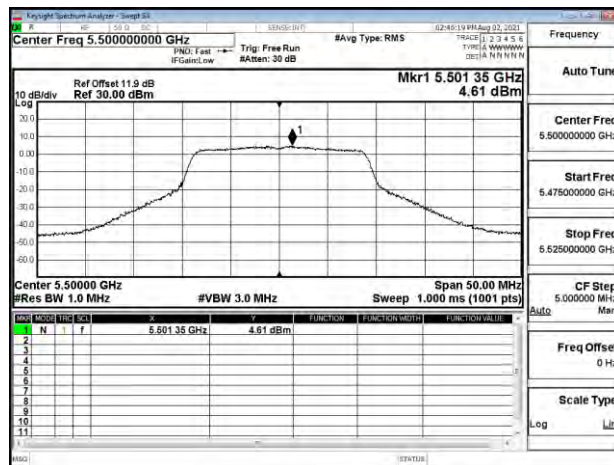

802.11ac_20MHz_Chain1_5300MHz

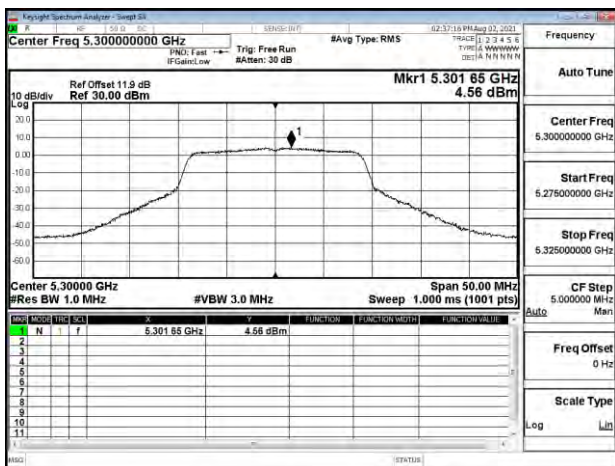

802.11ac_20MHz_Chain1_5580MHz

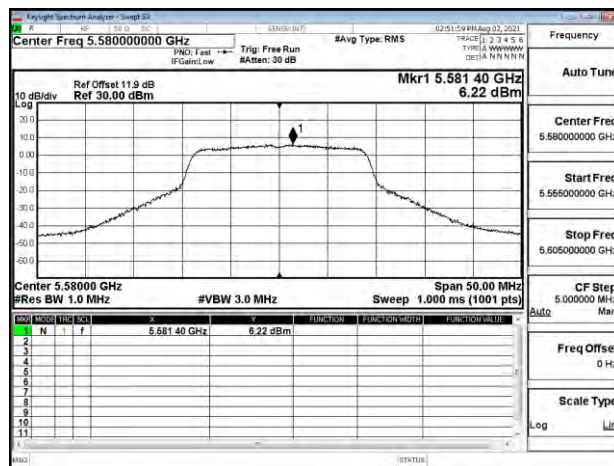

Unless otherwise stated the results shown in this test report refer only to the sample(s) tested and such sample(s) are retained for 90 days only.

除非另有說明，此報告結果僅對測試之樣品負責，同時此樣品僅保留90天。本報告未經本公司書面許可，不可部份複製。

This document is issued by the Company subject to its General Conditions of Service printed overleaf, available on request or accessible at <http://www.sgs.com.tw/Terms-and-Conditions> and for electronic format documents, subject to Terms and Conditions for Electronic Documents at <http://www.sgs.com.tw/Terms-and-Conditions>. Attention is drawn to the limitation of liability, indemnification and jurisdiction issues defined therein. Any holder of this document is advised that information contained herein reflects the Company's findings at the time of its intervention only and within the limits of Client's instructions, if any. The Company's sole responsibility is to its Client and this document does not exonerate parties to a transaction from exercising all their rights and obligations under the transaction documents. This document cannot be reproduced except in full, without prior written approval of the Company. Any unauthorized alteration, forgery or falsification of the content or appearance of this document is unlawful and offenders may be prosecuted to the fullest extent of the law.

802.11ac_20MHz_Chain1_5700MHz

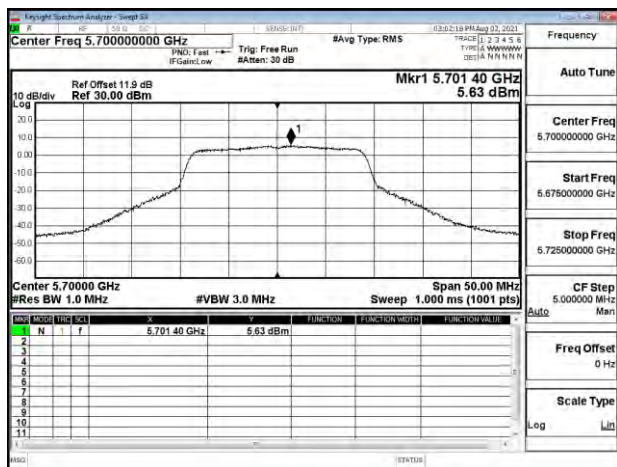

802.11ac_20MHz_Chain1_5745MHz

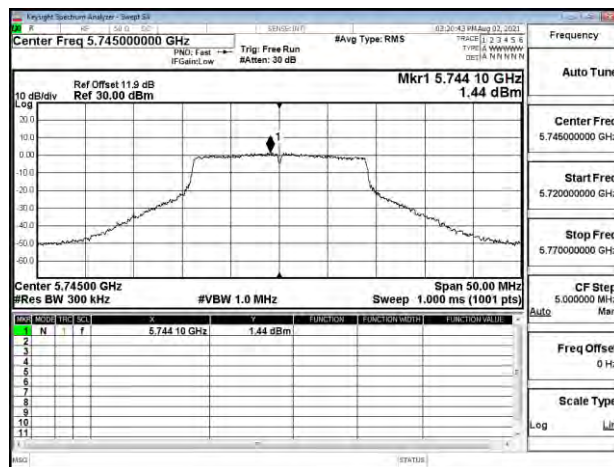

802.11ac_20MHz_Chain1_5720MHz_UNII 2C

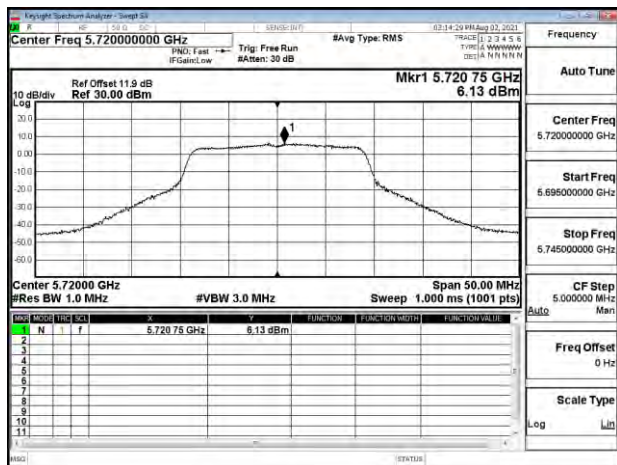

802.11ac_20MHz_Chain1_5785MHz

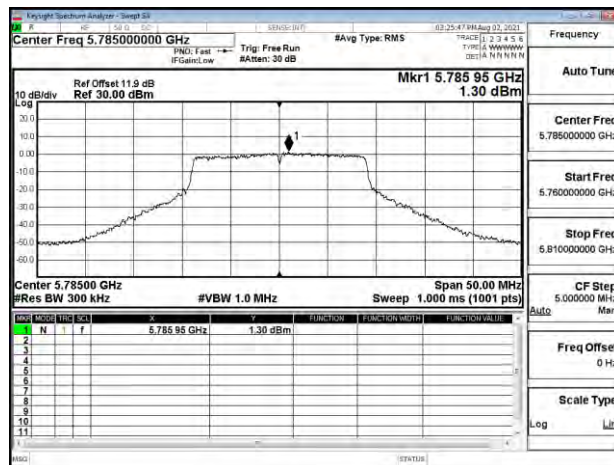

802.11ac_20MHz_Chain1_5720MHz_UNII 3

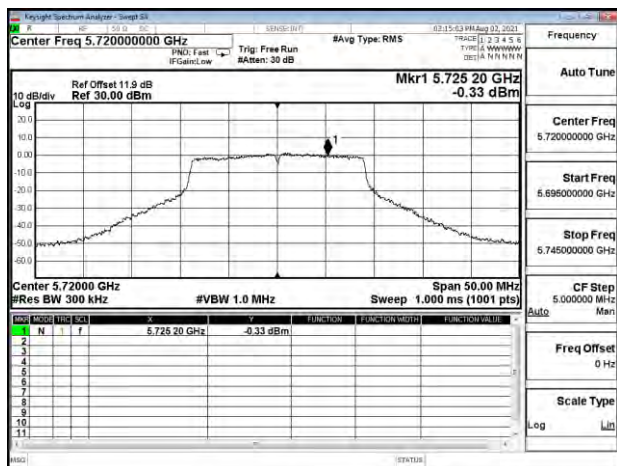

802.11ac_20MHz_Chain1_5825MHz

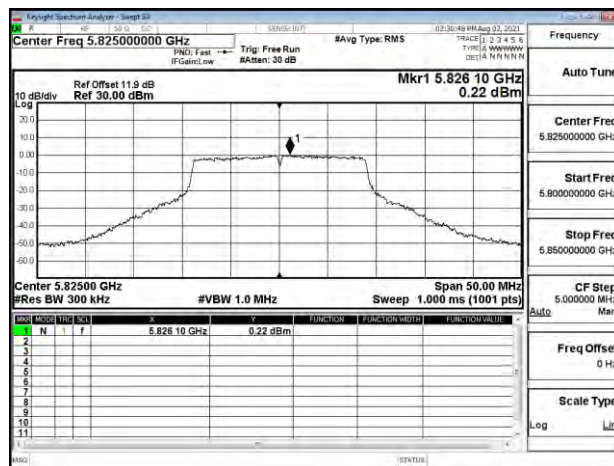

Unless otherwise stated the results shown in this test report refer only to the sample(s) tested and such sample(s) are retained for 90 days only.

除非另有說明，此報告結果僅對測試之樣品負責，同時此樣品僅保留90天。本報告未經本公司書面許可，不可部份複製。

This document is issued by the Company subject to its General Conditions of Service printed overleaf, available on request or accessible at <http://www.sgs.com.tw/Terms-and-Conditions> and for electronic format documents, subject to Terms and Conditions for Electronic Documents at <http://www.sgs.com.tw/Terms-and-Conditions>. Attention is drawn to the limitation of liability, indemnification and jurisdiction issues defined therein. Any holder of this document is advised that information contained herein reflects the Company's findings at the time of its intervention only and within the limits of Client's instructions, if any. The Company's sole responsibility is to its Client and this document does not exonerate parties to a transaction from exercising all their rights and obligations under the transaction documents. This document cannot be reproduced except in full, without prior written approval of the Company. Any unauthorized alteration, forgery or falsification of the content or appearance of this document is unlawful and offenders may be prosecuted to the fullest extent of the law.

802.11ac_40MHz_Chain0_5190MHz

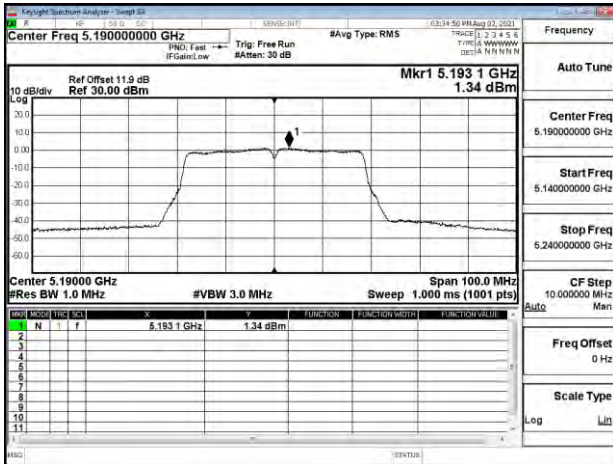

802.11ac_40MHz_Chain0_5310MHz

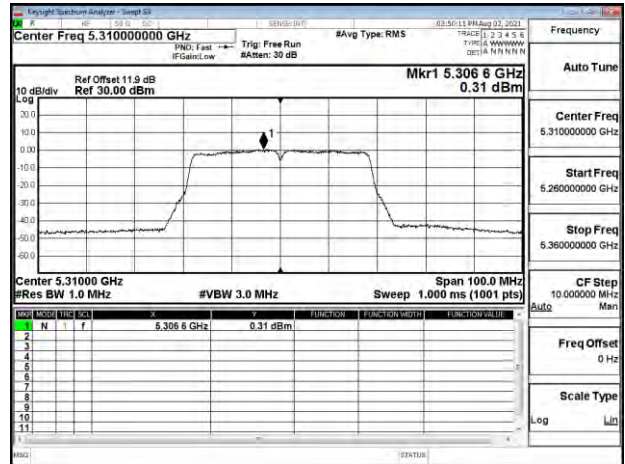

802.11ac_40MHz_Chain0_5230MHz

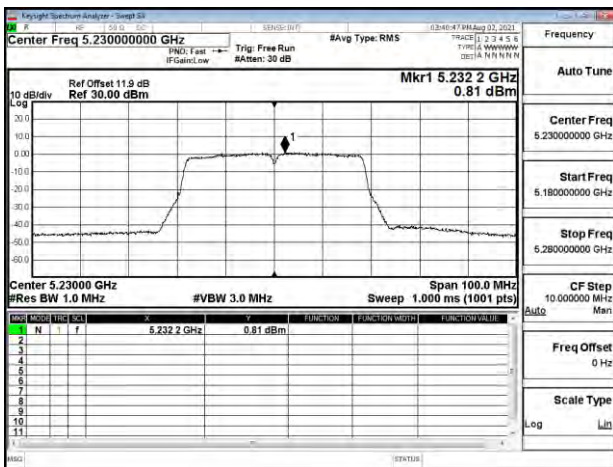

802.11ac_40MHz_Chain0_5510MHz

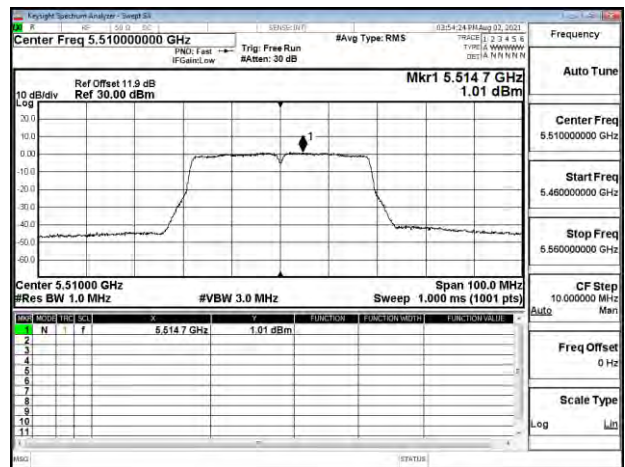

802.11ac_40MHz_Chain0_5270MHz

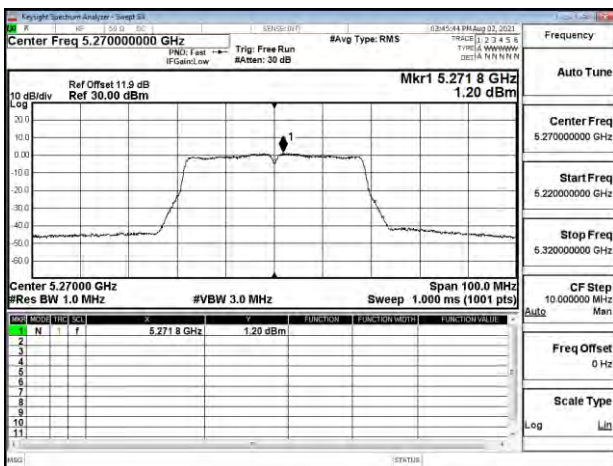

802.11ac_40MHz_Chain0_5550MHz

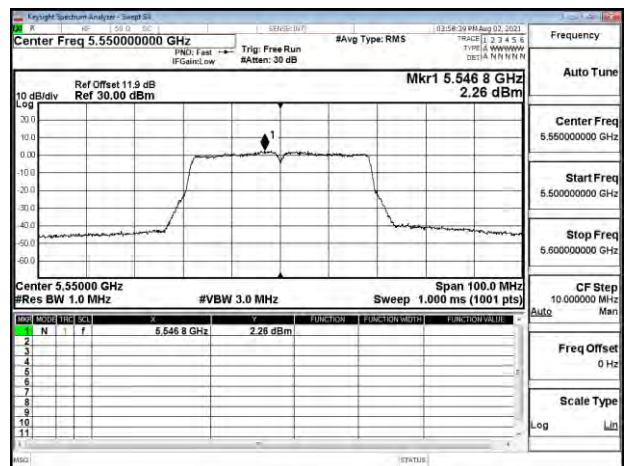

Unless otherwise stated the results shown in this test report refer only to the sample(s) tested and such sample(s) are retained for 90 days only.

除非另有說明，此報告結果僅對測試之樣品負責，同時此樣品僅保留90天。本報告未經本公司書面許可，不可部份複製。

This document is issued by the Company subject to its General Conditions of Service printed overleaf, available on request or accessible at <http://www.sgs.com.tw/Terms-and-Conditions> and for electronic format documents, subject to Terms and Conditions for Electronic Documents at <http://www.sgs.com.tw/Terms-and-Conditions>. Attention is drawn to the limitation of liability, indemnification and jurisdiction issues defined therein. Any holder of this document is advised that information contained herein reflects the Company's findings at the time of its intervention only and within the limits of Client's instructions, if any. The Company's sole responsibility is to its Client and this document does not exonerate parties to a transaction from exercising all their rights and obligations under the transaction documents. This document cannot be reproduced except in full, without prior written approval of the Company. Any unauthorized alteration, forgery or falsification of the content or appearance of this document is unlawful and offenders may be prosecuted to the fullest extent of the law.

802.11ac_40MHz_Chain0_5670MHz

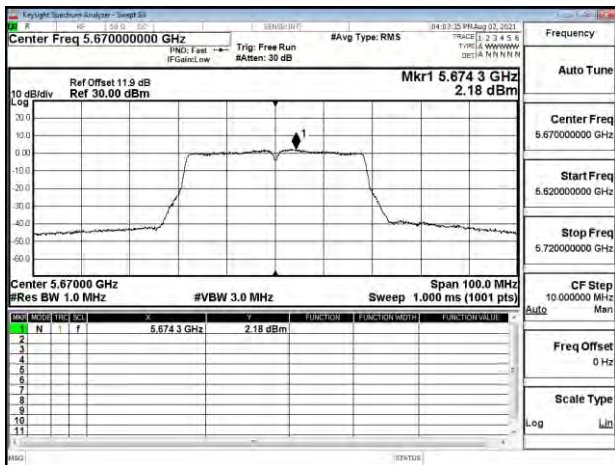

802.11ac_40MHz_Chain1_5190MHz

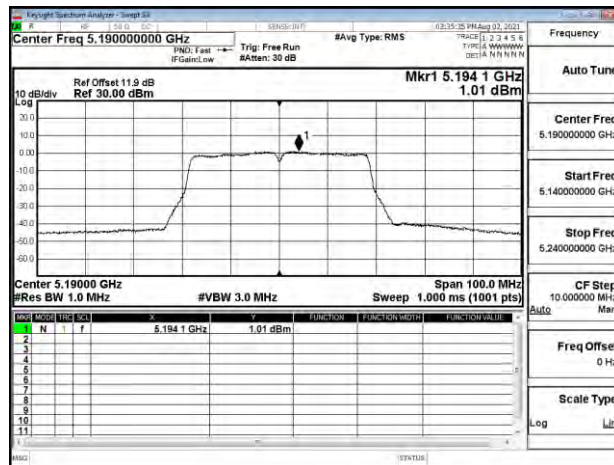

802.11ac_40MHz_Chain0_5755MHz

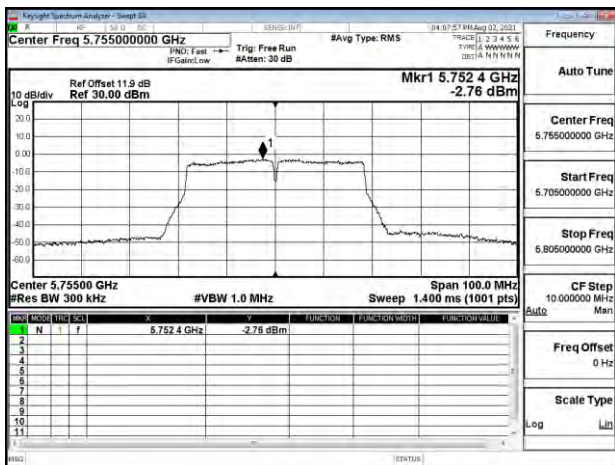

802.11ac_40MHz_Chain1_5230MHz

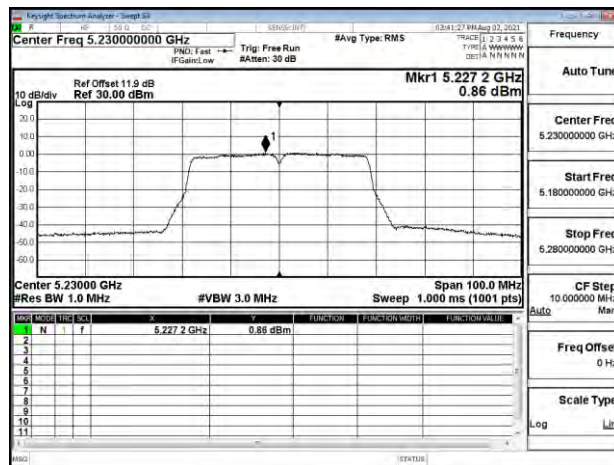

802.11ac_40MHz_Chain0_5795MHz

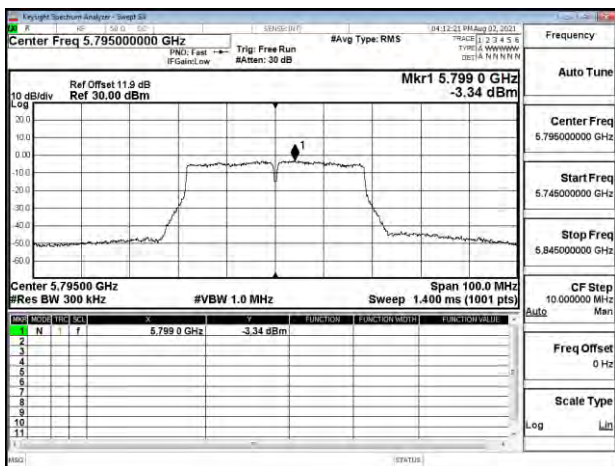

802.11ac_40MHz_Chain1_5270MHz

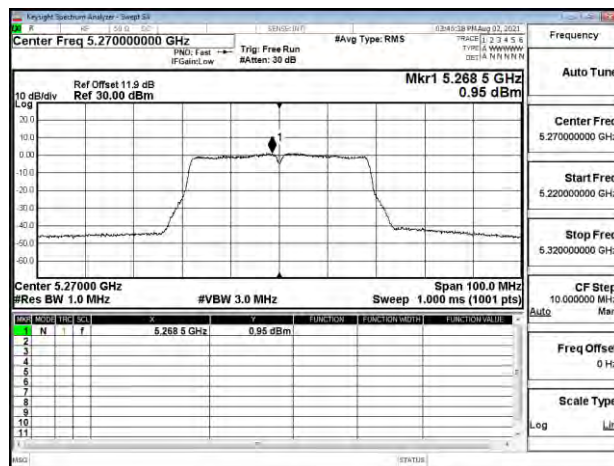

Unless otherwise stated the results shown in this test report refer only to the sample(s) tested and such sample(s) are retained for 90 days only.

除非另有說明，此報告結果僅對測試之樣品負責，同時此樣品僅保留90天。本報告未經本公司書面許可，不可部份複製。

This document is issued by the Company subject to its General Conditions of Service printed overleaf, available on request or accessible at <http://www.sgs.com.tw/Terms-and-Conditions> and for electronic format documents, subject to Terms and Conditions for Electronic Documents at <http://www.sgs.com.tw/Terms-and-Conditions>. Attention is drawn to the limitation of liability, indemnification and jurisdiction issues defined therein. Any holder of this document is advised that information contained herein reflects the Company's findings at the time of its intervention only and within the limits of Client's instructions, if any. The Company's sole responsibility is to its Client and this document does not exonerate parties to a transaction from exercising all their rights and obligations under the transaction documents. This document cannot be reproduced except in full, without prior written approval of the Company. Any unauthorized alteration, forgery or falsification of the content or appearance of this document is unlawful and offenders may be prosecuted to the fullest extent of the law.

802.11ac_40MHz_Chain1_5310MHz

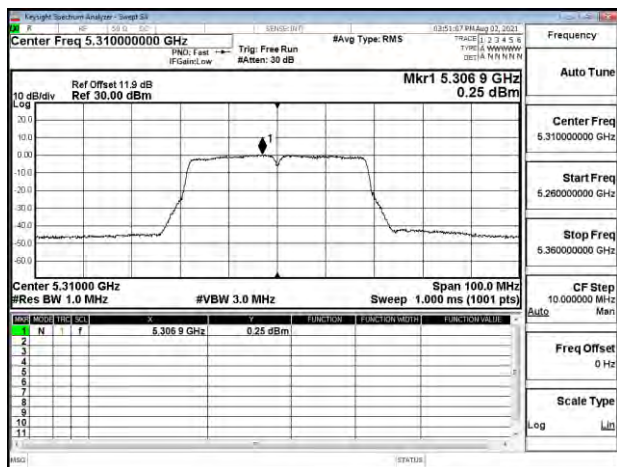

802.11ac_40MHz_Chain1_5670MHz

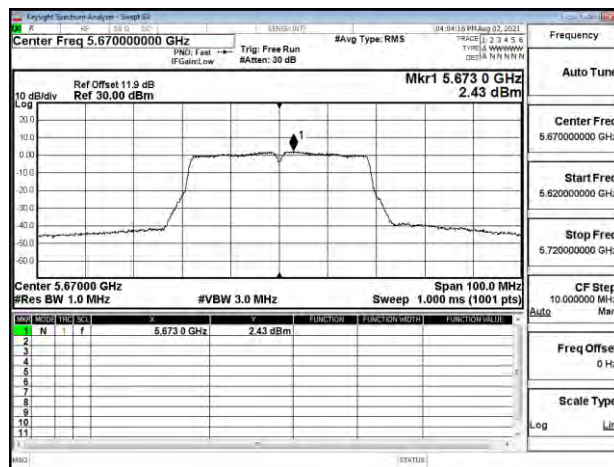

802.11ac_40MHz_Chain1_5510MHz

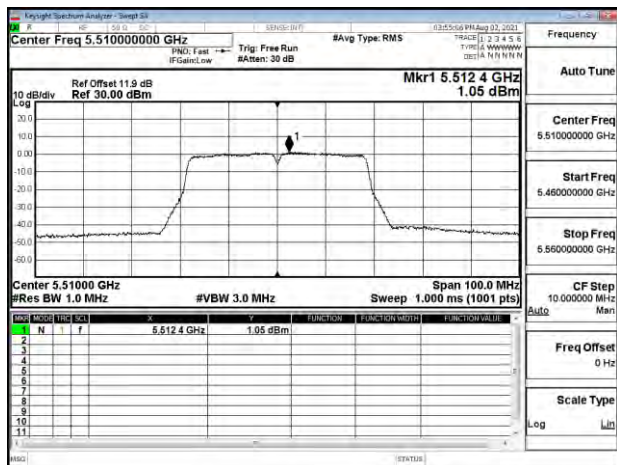

802.11ac_40MHz_Chain1_5755MHz

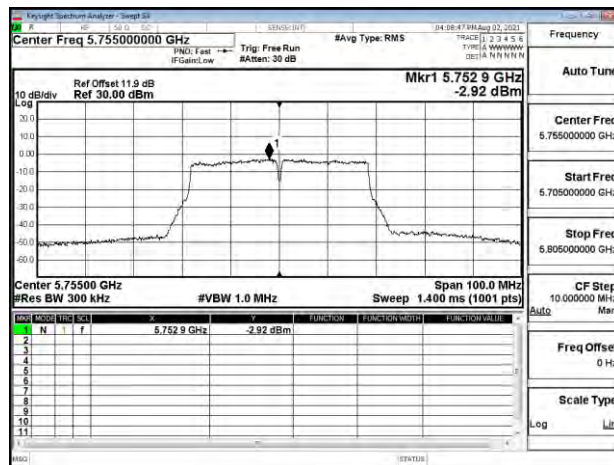

802.11ac_40MHz_Chain1_5550MHz

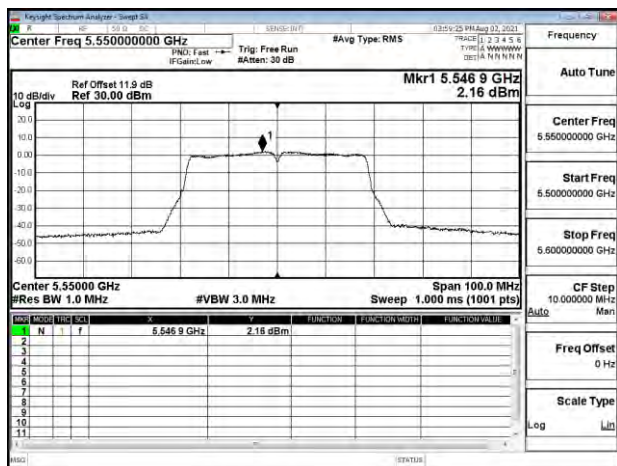

802.11ac_40MHz_Chain1_5795MHz

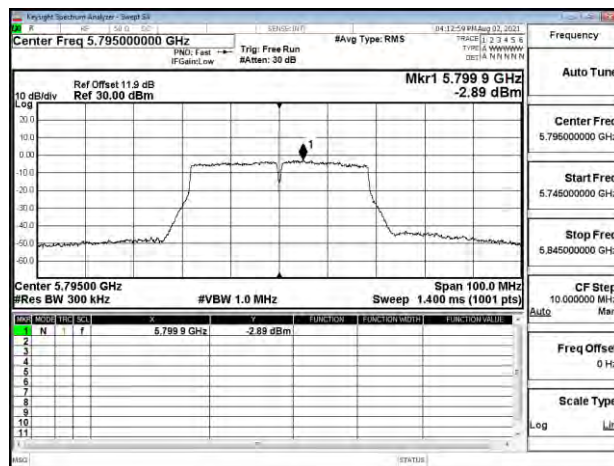

Unless otherwise stated the results shown in this test report refer only to the sample(s) tested and such sample(s) are retained for 90 days only.

除非另有說明，此報告結果僅對測試之樣品負責，同時此樣品僅保留90天。本報告未經本公司書面許可，不可部份複製。

This document is issued by the Company subject to its General Conditions of Service printed overleaf, available on request or accessible at <http://www.sgs.com.tw/Terms-and-Conditions> and for electronic format documents, subject to Terms and Conditions for Electronic Documents at <http://www.sgs.com.tw/Terms-and-Conditions>. Attention is drawn to the limitation of liability, indemnification and jurisdiction issues defined therein. Any holder of this document is advised that information contained herein reflects the Company's findings at the time of its intervention only and within the limits of Client's instructions, if any. The Company's sole responsibility is to its Client and this document does not exonerate parties to a transaction from exercising all their rights and obligations under the transaction documents. This document cannot be reproduced except in full, without prior written approval of the Company. Any unauthorized alteration, forgery or falsification of the content or appearance of this document is unlawful and offenders may be prosecuted to the fullest extent of the law.

802.11ac_80MHz_Chain0_5210MHz

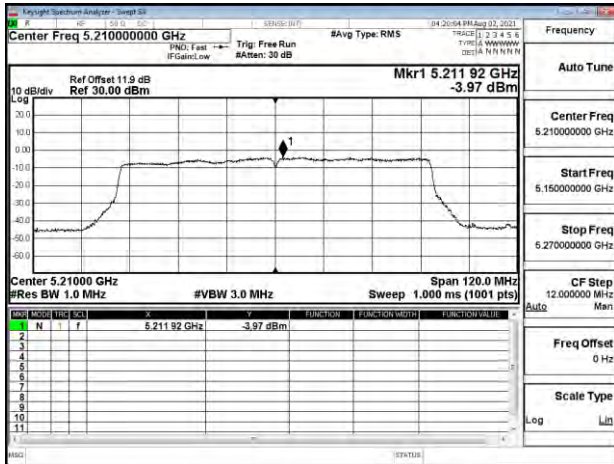

802.11ac_80MHz_Chain0_5610MHz

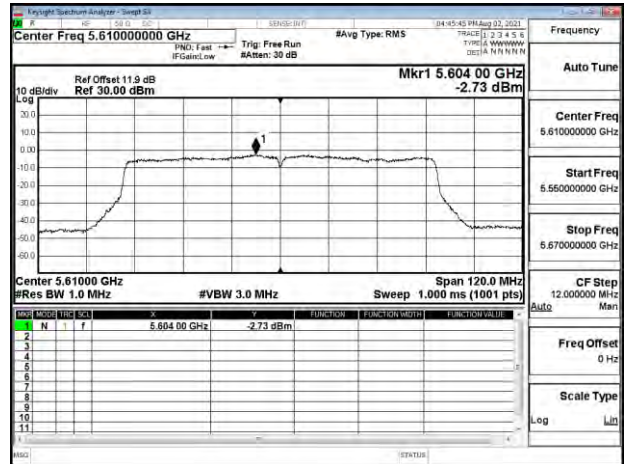

802.11ac_80MHz_Chain0_5290MHz

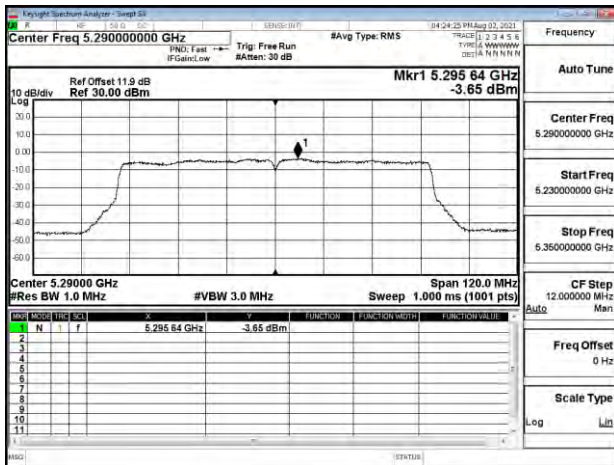

802.11ac_80MHz_Chain0_5775MHz

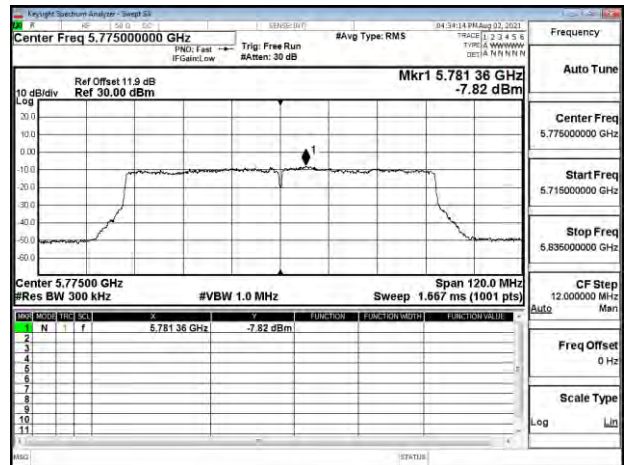

802.11ac_80MHz_Chain0_5530MHz

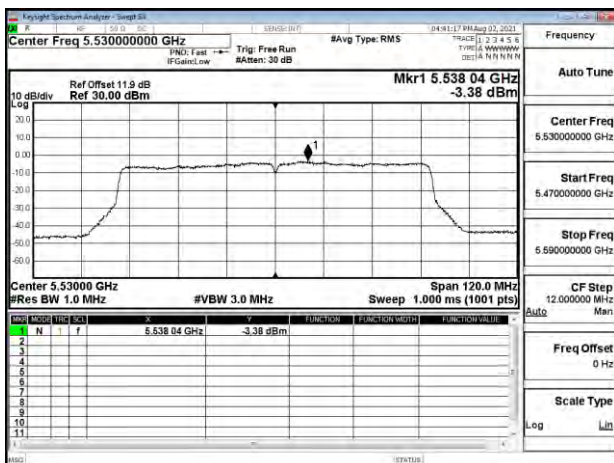

802.11ac_80MHz_Chain1_5210MHz

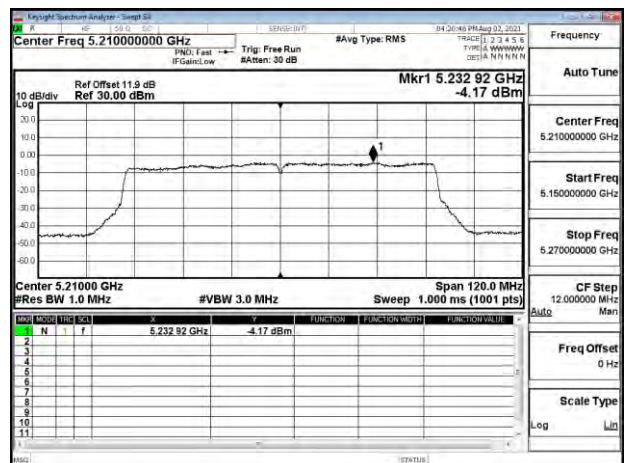

Unless otherwise stated the results shown in this test report refer only to the sample(s) tested and such sample(s) are retained for 90 days only.

除非另有說明，此報告結果僅對測試之樣品負責，同時此樣品僅保留90天。本報告未經本公司書面許可，不可部份複製。

This document is issued by the Company subject to its General Conditions of Service printed overleaf, available on request or accessible at <http://www.sgs.com.tw/Terms-and-Conditions> and for electronic format documents, subject to Terms and Conditions for Electronic Documents at <http://www.sgs.com.tw/Terms-and-Conditions>. Attention is drawn to the limitation of liability, indemnification and jurisdiction issues defined therein. Any holder of this document is advised that information contained herein reflects the Company's findings at the time of its intervention only and within the limits of Client's instructions, if any. The Company's sole responsibility is to its Client and this document does not exonerate parties to a transaction from exercising all their rights and obligations under the transaction documents. This document cannot be reproduced except in full, without prior written approval of the Company. Any unauthorized alteration, forgery or falsification of the content or appearance of this document is unlawful and offenders may be prosecuted to the fullest extent of the law.

802.11ac_80MHz_Chain1_5290MHz

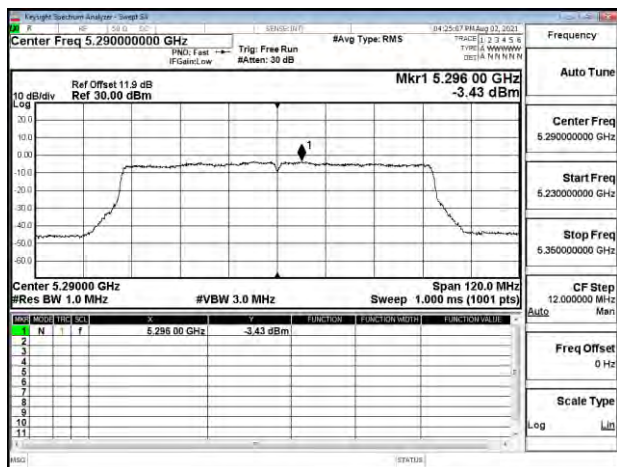

802.11ac_80MHz_Chain1_5775MHz

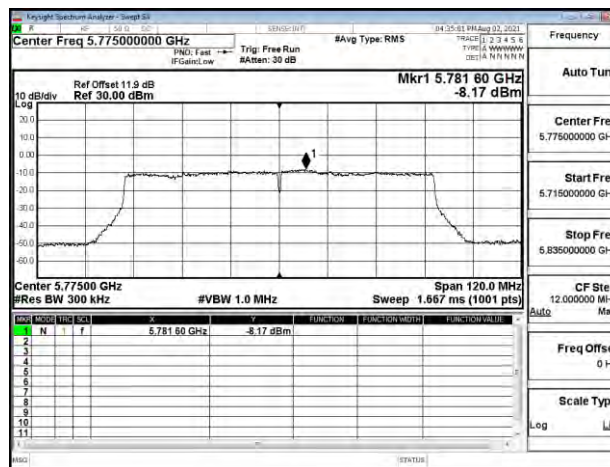

802.11ac_80MHz_Chain1_5530MHz

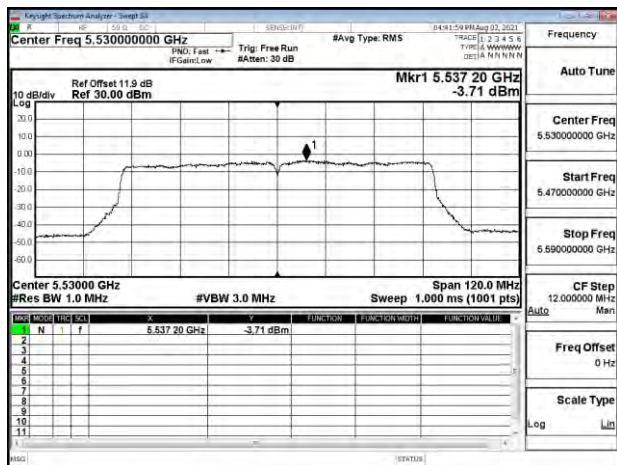

802.11ac_80MHz_Chain1_5610MHz

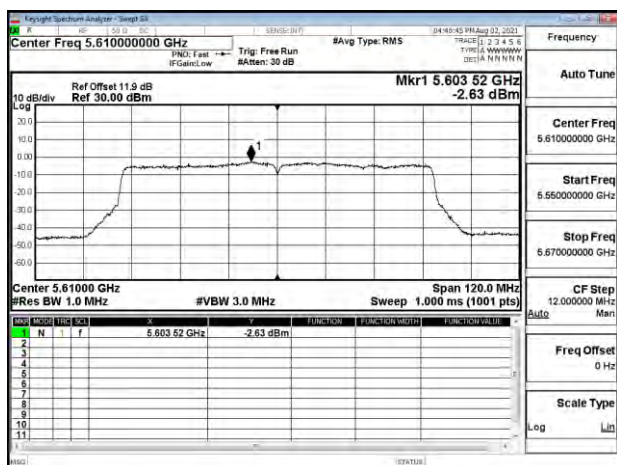

Unless otherwise stated the results shown in this test report refer only to the sample(s) tested and such sample(s) are retained for 90 days only.

除非另有說明，此報告結果僅對測試之樣品負責，同時此樣品僅保留90天。本報告未經本公司書面許可，不可部份複製。

This document is issued by the Company subject to its General Conditions of Service printed overleaf, available on request or accessible at <http://www.sgs.com.tw/Terms-and-Conditions> and for electronic format documents, subject to Terms and Conditions for Electronic Documents at <http://www.sgs.com.tw/Terms-and-Conditions>. Attention is drawn to the limitation of liability, indemnification and jurisdiction issues defined therein. Any holder of this document is advised that information contained hereon reflects the Company's findings at the time of its intervention only and within the limits of Client's instructions, if any. The Company's sole responsibility is to its Client and this document does not exonerate parties to a transaction from exercising all their rights and obligations under the transaction documents. This document cannot be reproduced except in full, without prior written approval of the Company. Any unauthorized alteration, forgery or falsification of the content or appearance of this document is unlawful and offenders may be prosecuted to the fullest extent of the law.

11 UNDESIRABLE RADIATED EMISSION MEASUREMENT

11.1 Standard Applicable

11.1.1 Band Edge

The maximum emissions outside of the frequency bands of operation shall be attenuated in accordance with the following limits:

1. For transmitters operating in the 5.15-5.25 GHz band: All emissions outside of the 5.15-5.35 GHz band shall not exceed an e.i.r.p. of -27 dBm/MHz.
2. For transmitters operating in the 5.725-5.85 GHz band: All emissions shall be limited to a level of -27 dBm/MHz at 75 MHz or more above or below the band edge increasing linearly to 10 dBm/MHz at 25 MHz above or below the band edge, and from 25 MHz above or below the band edge increasing linearly to a level of 15.6 dBm/MHz at 5 MHz above or below the band edge, and from 5 MHz above or below the band edge increasing linearly to a level of 27 dBm/MHz at the band edge.

APPLICABLE TO	EIRP LIMIT	FIELD STRENGTH AT 3m
15.407(b)(1)	PK: -27 (dBm/MHz)	PK: 68.2 (dBμV/m)
15.407(b)(2)		
15.407(b)(3)		
15.407(b)(4)(i)	PK:-27 (dBm/MHz) *1 PK:10 (dBm/MHz) *2 PK:15.6 (dBm/MHz) *3 PK:27 (dBm/MHz) *4	PK: 68.2 (dBμV/m) *1 PK:105.2 (dBμV/m) *2 PK: 110.8(dBμV/m) *3 PK:122.2 (dBμV/m) *4
<p>*1 beyond 75 MHz or more above of the bandedge. *2 below the band edge increasing linearly to 10 dBm/MHz at 25 MHz above. *3 below the band edge increasing linearly to a level of 15.6 dBm/MHz at 5 MHz above. *4 from 5 MHz above or below the band edge increasing linearly to a level of 27 dBm/MHz at the band edge.</p>		

$EIRP = (E \cdot d)^2 / 30$, where E is the field in V/m, d is the measurement distance (3m), $EIRP$ is the equivalent isotropically radiated power in Watts.

Unless otherwise stated the results shown in this test report refer only to the sample(s) tested and such sample(s) are retained for 90 days only.

除非另有說明，此報告結果僅對測試之樣品負責，同時此樣品僅保留90天。本報告未經本公司書面許可，不可部份複製。

This document is issued by the Company subject to its General Conditions of Service printed overleaf, available on request or accessible at <http://www.sgs.com.tw/Terms-and-Conditions> and for electronic format documents, subject to Terms and Conditions for Electronic Documents at <http://www.sgs.com.tw/Terms-and-Conditions>. Attention is drawn to the limitation of liability, indemnification and jurisdiction issues defined therein. Any holder of this document is advised that information contained hereon reflects the Company's findings at the time of its intervention only and within the limits of Client's instructions, if any. The Company's sole responsibility is to its Client and this document does not exonerate parties to a transaction from exercising all their rights and obligations under the transaction documents. This document cannot be reproduced except in full, without prior written approval of the Company. Any unauthorized alteration, forgery or falsification of the content or appearance of this document is unlawful and offenders may be prosecuted to the fullest extent of the law.

11.1.2 Spurious Emission

Unwanted spurious emissions which fall in the restricted bands must comply with the radiated emission limits specified as below table:

Frequency (MHz)	Field strength (microvolts/meter)	Distance (meters)
0.009-0.490	2400/F(kHz)	300
0.490-1.705	24000/F(kHz)	30
1.705-30	30	30
30-88	100	3
88-216	150	3
216-960	200	3
Above 960	500	3

Note:

1. The lower limit shall apply at the transition frequencies.

Unless otherwise stated the results shown in this test report refer only to the sample(s) tested and such sample(s) are retained for 90 days only.

除非另有說明，此報告結果僅對測試之樣品負責，同時此樣品僅保留90天。本報告未經本公司書面許可，不可部份複製。
 This document is issued by the Company subject to its General Conditions of Service printed overleaf, available on request or accessible at <http://www.sgs.com.tw/Terms-and-Conditions> and for electronic format documents, subject to Terms and Conditions for Electronic Documents at <http://www.sgs.com.tw/Terms-and-Conditions>. Attention is drawn to the limitation of liability, indemnification and jurisdiction issues defined therein. Any holder of this document is advised that information contained hereon reflects the Company's findings at the time of its intervention only and within the limits of Client's instructions, if any. The Company's sole responsibility is to its Client and this document does not exonerate parties to a transaction from exercising all their rights and obligations under the transaction documents. This document cannot be reproduced except in full, without prior written approval of the Company. Any unauthorized alteration, forgery or falsification of the content or appearance of this document is unlawful and offenders may be prosecuted to the fullest extent of the law.

11.2 Measurement Equipment Used

Radiated Emission Test Site: SAC D					
EQUIPMENT TYPE	MFR	MODEL NUMBER	SERIAL NUMBER	LAST CAL.	CAL DUE.
Broadband Antenna	TESEQ	CBL 6112D	35240	09/08/2020	09/07/2021
Horn Antenna	Schwarzbeck	BBHA9120D	1341	06/04/2021	06/03/2022
Horn Antenna	Schwarzbeck	BBHA9170	184	12/11/2020	12/10/2021
Loop Antenna	ETS.LINDGREN	6502	143303	05/07/2021	05/06/2022
3m Site NSA	SGS	966 chamber D	N/A	07/12/2021	07/11/2022
Spectrum Analyzer	KEYSIGHT	N9010A	MY54510568	03/22/2021	03/21/2022
Pre-Amplifier	EMC Instruments	EMC184045B	980135	10/27/2020	10/26/2021
Pre-Amplifier	EMC Instruments	EMC9135	980234	11/19/2020	11/18/2021
Pre-Amplifier	EMC Instruments	EMC12630SE	980271	11/19/2020	11/18/2021
Attenuator	Marvelous	WATT-218FS-10	RF25	11/19/2020	11/18/2021
High Pass Filter	R&S	F13 HPF 3GHz	RF175	11/19/2020	11/18/2021
Lowpass Filter	Woken	EWT-56-0019	RF173	11/19/2020	11/18/2021
Notch Filter	Woken	EWT-54-0038	RF178	11/19/2020	11/18/2021
Coaxial Cable	Huber Suhner	EMC106-SM-SM-7200	150703	11/19/2020	11/18/2021
Coaxial Cable	Huber+Suhner	RG 214/U	W21.01	11/19/2020	11/18/2021
Coaxial Cable	Huber Suhner	SUCOFLEX 104	MY17413/4	11/19/2020	11/18/2021
Test Software	audix	e3	20923 sgs Ver.9	N.C.R	N.C.R
USB Cable	廣寰	Z2110	N/A	N.C.R	N.C.R

NOTE: N.C.R refers to Not Calibrated Required.

Unless otherwise stated the results shown in this test report refer only to the sample(s) tested and such sample(s) are retained for 90 days only.

除非另有說明，此報告結果僅對測試之樣品負責，同時此樣品僅保留90天。本報告未經本公司書面許可，不可部份複製。

This document is issued by the Company subject to its General Conditions of Service printed overleaf, available on request or accessible at <http://www.sgs.com.tw/Terms-and-Conditions> and for electronic format documents, subject to Terms and Conditions for Electronic Documents at <http://www.sgs.com.tw/Terms-and-Conditions>. Attention is drawn to the limitation of liability, indemnification and jurisdiction issues defined therein. Any holder of this document is advised that information contained hereon reflects the Company's findings at the time of its intervention only and within the limits of Client's instructions, if any. The Company's sole responsibility is to its Client and this document does not exonerate parties to a transaction from exercising all their rights and obligations under the transaction documents. This document cannot be reproduced except in full, without prior written approval of the Company. Any unauthorized alteration, forgery or falsification of the content or appearance of this document is unlawful and offenders may be prosecuted to the fullest extent of the law.

11.3 Test SET-UP

(A) Radiated Emission Test Set-Up, Frequency Below 30MHz.

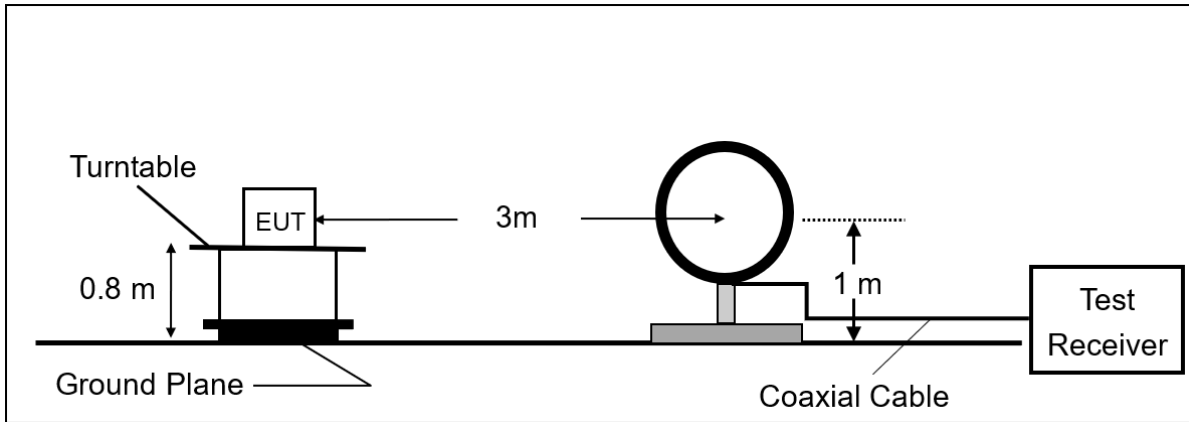

(B) Radiated Emission Test Set-Up, Frequency From 30MHz to 1000MHz

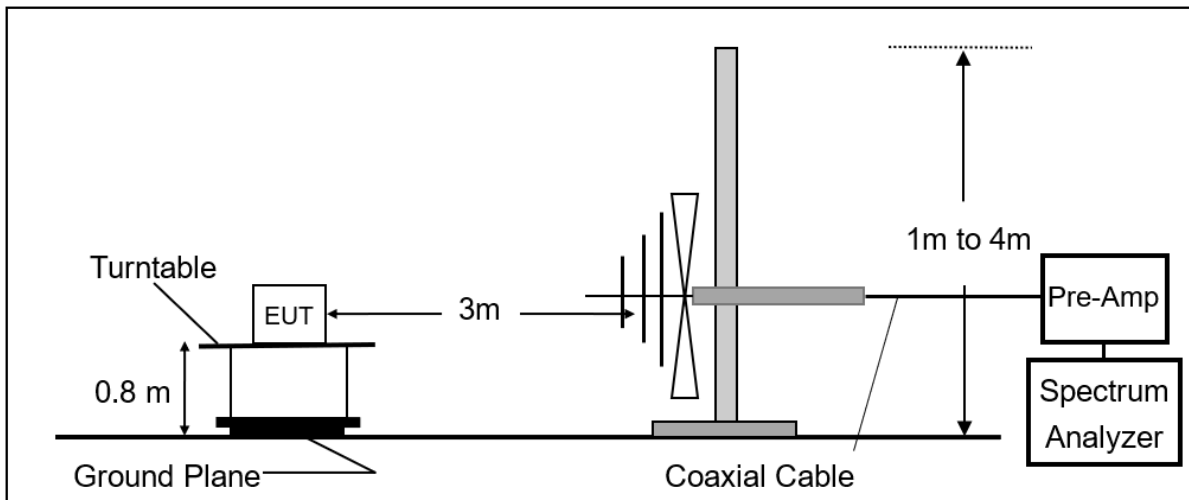

(C) Radiated Emission Test Set-Up, Frequency Above 1GHz

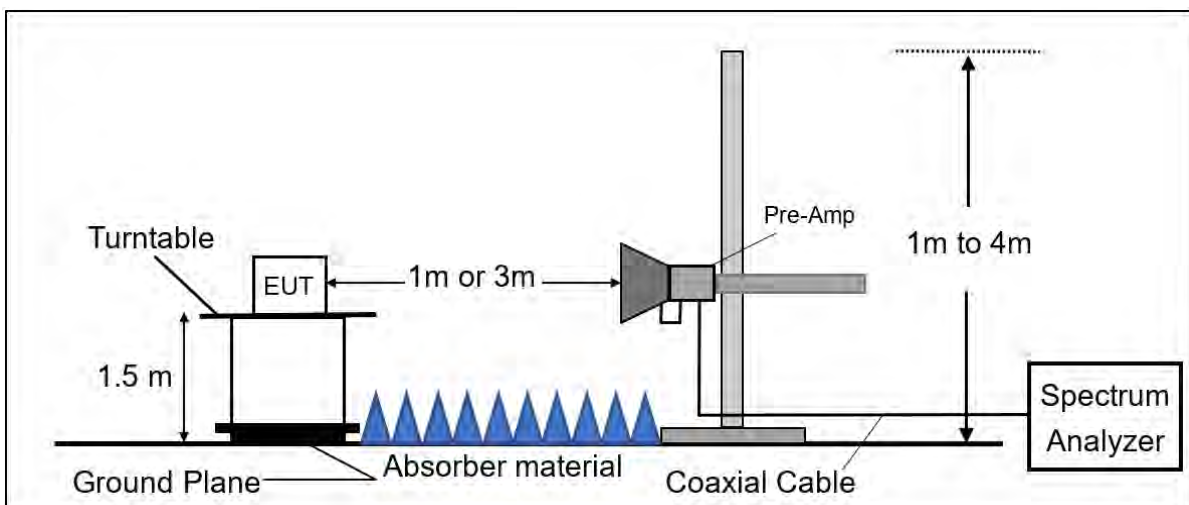

Unless otherwise stated the results shown in this test report refer only to the sample(s) tested and such sample(s) are retained for 90 days only.

除非另有說明，此報告結果僅對測試之樣品負責，同時此樣品僅保留90天。本報告未經本公司書面許可，不可部份複製。

This document is issued by the Company subject to its General Conditions of Service printed overleaf, available on request or accessible at <http://www.sgs.com.tw/Terms-and-Conditions> and for electronic format documents, subject to Terms and Conditions for Electronic Documents at <http://www.sgs.com.tw/Terms-and-Conditions>. Attention is drawn to the limitation of liability, indemnification and jurisdiction issues defined therein. Any holder of this document is advised that information contained hereon reflects the Company's findings at the time of its intervention only and within the limits of Client's instructions, if any. The Company's sole responsibility is to its Client and this document does not exonerate parties to a transaction from exercising all their rights and obligations under the transaction documents. This document cannot be reproduced except in full, without prior written approval of the Company. Any unauthorized alteration, forgery or falsification of the content or appearance of this document is unlawful and offenders may be prosecuted to the fullest extent of the law.

11.4 Measurement Procedure

1. The testing follows FCC KDB 789033 D02.
2. The EUT was placed on a turn table with 0.8m for frequency < 1GHz and 1.5m for frequency > 1GHz above ground plane.
3. The turn table shall rotate 360 degrees to determine the position of maximum emission level.
4. EUT is set 3m away from the receiving antenna which varied from 1m to 4m to find out the highest emissions.
5. Set the spectrum analyzer as RBW=100 kHz and VBW=300 kHz for Peak Detector (PK) at frequency between 30MHz and 1 GHz
6. Use receiver mode as RBW=120 kHz for Quasi-peak (QP) at frequency between 30MHz and 1 GHz.
7. Set the spectrum analyzer as RBW=1 MHz, VBW=3 MHz for Maximum Emission Measurements at frequency above 1 GHz.
8. Set the spectrum analyzer as RBW=1 MHz, VBW=10 Hz (Duty cycle > 98%) or VBW ≥ 1/T (Duty cycle < 98%) for Average Emission Measurements at frequency above 1 GHz.
9. When measurement procedures for electric field radiated emissions above 1 GHz the EUT measurement is to be made “while keeping the antenna in the ‘cone of radiation’ from that area and pointed at the area both in azimuth and elevation, with polarization oriented for maximum response.” is still within the 3dB illumination BW of the measurement antenna.
10. Maximum procedure was performed on the six highest emissions to ensure EUT compliance.
11. And also, each emission was to be maximized by changing the polarization of receiving antenna both horizontal and vertical.
12. Repeat above procedures until all frequency measured were complete.

Unless otherwise stated the results shown in this test report refer only to the sample(s) tested and such sample(s) are retained for 90 days only.
除非另有說明，此報告結果僅對測試之樣品負責，同時此樣品僅保留90天。本報告未經本公司書面許可，不可部份複製。

This document is issued by the Company subject to its General Conditions of Service printed overleaf, available on request or accessible at <http://www.sgs.com.tw/Terms-and-Conditions> and for electronic format documents, subject to Terms and Conditions for Electronic Documents at <http://www.sgs.com.tw/Terms-and-Conditions>. Attention is drawn to the limitation of liability, indemnification and jurisdiction issues defined therein. Any holder of this document is advised that information contained hereon reflects the Company's findings at the time of its intervention only and within the limits of Client's instructions, if any. The Company's sole responsibility is to its Client and this document does not exonerate parties to a transaction from exercising all their rights and obligations under the transaction documents. This document cannot be reproduced except in full, without prior written approval of the Company. Any unauthorized alteration, forgery or falsification of the content or appearance of this document is unlawful and offenders may be prosecuted to the fullest extent of the law.

11.5 Field Strength Calculation

The field strength is calculated by adding the Antenna Factor and Cable Factor and subtracting the Amplifier Gain and Duty Cycle Correction Factor (if any) from the measured reading. The basic equation with a sample calculation is as follows:

$$FS = RA + AF + CL - AG$$

Where *FS* = Field Strength

CL = Cable Attenuation Factor (Cable Loss)

RA = Reading Amplitude

AG = Amplifier Gain

AF = Antenna Factor

The limit of the emission level is expressed in dBuV/m, which converts $20 \cdot \log(uV/m)$

Actual FS(dBμV/m) = SPA. Reading level(dBμV) + Factor(dB)

Factor(dB) = Antenna Factor(dBμV/m) + Cable Loss(dB) – Pre_Amplifier Gain(dB)

11.6 Test Results of Radiated Spurious Emissions from 9 kHz to 30 MHz

The low frequency, which started from 9 kHz to 30MHz, was pre-scanned and the result which was 20dB lower than the limit per 15.31(o) was not reported.

Pre-scanned was done at frequency 5.47 GHz and 5.85 GHz for bandedge measurement of straddle channels 138, 142 and 144 which was 20dB lower than the limit per 15.31(o) & RSS-GEN §6.13.2 was not reported.

Unless otherwise stated the results shown in this test report refer only to the sample(s) tested and such sample(s) are retained for 90 days only.

除非另有說明，此報告結果僅對測試之樣品負責，同時此樣品僅保留90天。本報告未經本公司書面許可，不可部份複製。

This document is issued by the Company subject to its General Conditions of Service printed overleaf, available on request or accessible at <http://www.sgs.com.tw/Terms-and-Conditions> and for electronic format documents, subject to Terms and Conditions for Electronic Documents at <http://www.sgs.com.tw/Terms-and-Conditions>. Attention is drawn to the limitation of liability, indemnification and jurisdiction issues defined therein. Any holder of this document is advised that information contained hereon reflects the Company's findings at the time of its intervention only and within the limits of Client's instructions, if any. The Company's sole responsibility is to its Client and this document does not exonerate parties to a transaction from exercising all their rights and obligations under the transaction documents. This document cannot be reproduced except in full, without prior written approval of the Company. Any unauthorized alteration, forgery or falsification of the content or appearance of this document is unlawful and offenders may be prosecuted to the fullest extent of the law.