

ELECTROMAGNETIC EMISSIONS COMPLIANCE REPORT

INTENTIONAL RADIATOR CERTIFICATION TO FCC PART 15 SUBPART C REQUIREMENT OF

Applicant: Quanta Computer Inc.
No. 188, Wenhua 2nd Road, Guishan District, Taoyuan City
33377, Taiwan

Product Name: Clover Station

Brand Name: clover

Model No.: C500

Model Difference: N/A

FCC ID: HFS-C500

Report Number: E2/2017/90033

FCC Rule Part: §15.247, Cat: DTS

Issue Date: Oct. 27, 2017

Date of Test: Sep. 12, 2017 ~ Oct. 25, 2017

Date of EUT Received: Sep. 12, 2017

We hereby certify that:

The above equipment was tested by SGS Taiwan Ltd. Electronics & Communication Laboratory. The test data, data evaluation, test procedures, and equipment configurations shown in this report were made in accordance with the procedures given in ANSI C63.10:2013 and the energy emitted by the sample EUT tested as described in this report is in compliance with conducted and radiated emission limits.

The test results of this report relate only to the tested sample identified in this report.

Prepared By: 
Karen Huang / Clerk

Approved By: 
Jim Chang / Asst. Manager



Unless otherwise stated the results shown in this test report refer only to the sample(s) tested and such sample(s) are retained for 90 days only.

除非另有說明，此報告結果僅對測試之樣品負責，同時此樣品僅保留90天。本報告未經本公司書面許可，不可部份複製。

This document is issued by the Company subject to its General Conditions of Service printed overleaf, available on request or accessible at www.sgs.com/terms_and_conditions.htm and, for electronic format documents, subject to Terms and Conditions for Electronic Documents at www.sgs.com/terms_e-document.htm. Attention is drawn to the limitation of liability, indemnification and jurisdiction issues defined therein. Any holder of this document is advised that information contained hereon reflects the Company's findings at the time of its intervention only and within the limits of Client's instructions, if any. The Company's sole responsibility is to its Client and this document does not exonerate parties to a transaction from exercising all their rights and obligations under the transaction documents. This document cannot be reproduced except in full, without prior written approval of the Company. Any unauthorized alteration, forgery or falsification of the content or appearance of this document is unlawful and offenders may be prosecuted to the fullest extent of the law.

SGS Taiwan Ltd.

No. 134, WuKungRoad, NewTaipeiIndustrialPark, WukuDistrict, NewTaipeiCity, Taiwan24803/新北市五股區新北產業園區五工路 134 號

台灣檢驗科技股份有限公司

t (886-2) 2299-3279

f (886-2) 2298-0488

www.tw.sgs.com

Member of SGS Group

Revision History

Report Number	Revision	Description	Issue Date
E2/2017/90033	Rev.00	Initial creation of document	Oct. 27, 2017

Unless otherwise stated the results shown in this test report refer only to the sample(s) tested and such sample(s) are retained for 90 days only.

除非另有說明，此報告結果僅對測試之樣品負責，同時此樣品僅保留90天。本報告未經本公司書面許可，不可部份複製。

This document is issued by the Company subject to its General Conditions of Service printed overleaf, available on request or accessible at www.sgs.com/terms_and_conditions.htm and, for electronic format documents, subject to Terms and Conditions for Electronic Documents at www.sgs.com/terms_e-document.htm. Attention is drawn to the limitation of liability, indemnification and jurisdiction issues defined therein. Any holder of this document is advised that information contained hereon reflects the Company's findings at the time of its intervention only and within the limits of Client's instructions, if any. The Company's sole responsibility is to its Client and this document does not exonerate parties to a transaction from exercising all their rights and obligations under the transaction documents. This document cannot be reproduced except in full, without prior written approval of the Company. Any unauthorized alteration, forgery or falsification of the content or appearance of this document is unlawful and offenders may be prosecuted to the fullest extent of the law.

SGS Taiwan Ltd.

No.134,WuKungRoad,NewTaipeiIndustrialPark,WukuDistrict,NewTaipeiCity,Taiwan24803/新北市五股區新北產業園區五工路 134 號

台灣檢驗科技股份有限公司

t (886-2) 2299-3279

f (886-2) 2298-0488

www.tw.sgs.com

Member of SGS Group

Contents

1	GENERAL INFORMATION.....	4
2	SYSTEM TEST CONFIGURATION	6
3	SUMMARY OF TEST RESULTS	8
4	DESCRIPTION OF TEST MODES.....	9
5	MEASUREMENT UNCERTAINTY.....	12
6	CONDUCTED EMISSION TEST.....	13
7	DUTY CYCLE OF TEST SIGNAL.....	17
8	PEAK OUTPUT POWER MEASUREMENT	20
9	CONDUCTED BAND EDGES AND SPURIOUS EMISSION MEASUREMENT.....	31
10	RADIATED BANDEDGE AND SPURIOUS EMISSION MEASUREMENT.....	41
11	PEAK POWER SPECTRAL DENSITY	82
12	ANTENNA REQUIREMENT	86

Unless otherwise stated the results shown in this test report refer only to the sample(s) tested and such sample(s) are retained for 90 days only.

除非另有說明，此報告結果僅對測試之樣品負責，同時此樣品僅保留90天。本報告未經本公司書面許可，不可部份複製。

This document is issued by the Company subject to its General Conditions of Service printed overleaf, available on request or accessible at www.sgs.com/terms_and_conditions.htm and, for electronic format documents, subject to Terms and Conditions for Electronic Documents at www.sgs.com/terms_e-document.htm. Attention is drawn to the limitation of liability, indemnification and jurisdiction issues defined therein. Any holder of this document is advised that information contained hereon reflects the Company's findings at the time of its intervention only and within the limits of Client's instructions, if any. The Company's sole responsibility is to its Client and this document does not exonerate parties to a transaction from exercising all their rights and obligations under the transaction documents. This document cannot be reproduced except in full, without prior written approval of the Company. Any unauthorized alteration, forgery or falsification of the content or appearance of this document is unlawful and offenders may be prosecuted to the fullest extent of the law.

SGS Taiwan Ltd.

No.134,WuKungRoad,NewTaipeiIndustrialPark,WukuDistrict,NewTaipeiCity,Taiwan24803/新北市五股區新北產業園區五工路 134 號

台灣檢驗科技股份有限公司

t (886-2) 2299-3279

f (886-2) 2298-0488

www.tw.sgs.com

Member of SGS Group

1 GENERAL INFORMATION

1.1 Product description

General:

Product Name:	Clover Station	
Brand Name:	clover	
Model No.:	C500	
Model Difference:	N/A	
Product HW version:	1.0	
Product SW version:	android-goldenoak-eng-1010001	
Hub:	Model No.: H500, Brand: clover	
Printer (Optional):	1. Model No.: P550 (with NFC & LCD panel), Brand: clover 2. Model No.: P500 (pure printer), Brand: clover	
Power Supply:	3.8Vdc from Rechargeable Li-ion Polymer Battery or 24Vdc from AC/DC adapter	
	Battery:	Model No.: MLP3853144, Supplier: McNair
	Adapter:	Model No.: FSP120-AABN3, Brand: clover

WLAN 2.4GHz:

Wi-Fi	Frequency Range	Channels	Rated Power	Modulation Technology
11b/g	2412-2462	11	b: 16.57dBm (MIMO Chain 0+1) g: 21.32dBm (MIMO Chain 0+1)	DSSS, OFDM
11n	HT20 2412-2462	11	HT20: 21.56dBm (MIMO Chain 0+1)	OFDM
Modulation type:		CCK, DQPSK, DBPSK for DSSS 64QAM, 16QAM, QPSK, BPSK for OFDM		
Transition Rate:		802.11 b: 1/2/5.5/11 Mbps 802.11 g: 6/9/12/18/24/36/48/54 Mbps 802.11 n_20MHz: 6.5 – 144.4Mbps		

Antenna Designation

Antenna Type	Part Number	Supplier	Peak Gain (dBi)
IFA / Main	N/A	N/A	4.1
IFA / Aux	N/A	N/A	3.9

Unless otherwise stated the results shown in this test report refer only to the sample(s) tested and such sample(s) are retained for 90 days only.

除非另有說明，此報告結果僅對測試之樣品負責，同時此樣品僅保留90天。本報告未經本公司書面許可，不可部份複製。

This document is issued by the Company subject to its General Conditions of Service printed overleaf, available on request or accessible at www.sgs.com/terms_and_conditions.htm and, for electronic format documents, subject to Terms and Conditions for Electronic Documents at www.sgs.com/terms_e-document.htm. Attention is drawn to the limitation of liability, indemnification and jurisdiction issues defined therein. Any holder of this document is advised that information contained hereon reflects the Company's findings at the time of its intervention only and within the limits of Client's instructions, if any. The Company's sole responsibility is to its Client and this document does not exonerate parties to a transaction from exercising all their rights and obligations under the transaction documents. This document cannot be reproduced except in full, without prior written approval of the Company. Any unauthorized alteration, forgery or falsification of the content or appearance of this document is unlawful and offenders may be prosecuted to the fullest extent of the law.

SGS Taiwan Ltd.

No.134,WuKungRoad,NewTaipeiIndustrialPark,WukuDistrict,NewTaipeiCity,Taiwan24803/新北市五股區新北產業園區五工路 134 號

台灣檢驗科技股份有限公司

t (886-2) 2299-3279

f (886-2) 2298-0488

www.tw.sgs.com

Member of SGS Group

1.2 Test Methodology of Applied Standards

FCC Part 15, Subpart C §15.247

FCC KDB 558074 D01 DTS Meas. Guidance

FCC KDB 662911 D01 Multiple Transmitter Output

ANSI C63.10:2013

Note:

All test items have been performed and record as per the above standards.

1.3 Test Facility

SGS Taiwan Ltd. Electronics & Communication Laboratory No.2, Keji 1st Rd.,
Guishan District, Taoyuan City, Taiwan 333

(TAF code 0513)

FCC Registration Number and Designation number are: 735305 / TW0002

1.4 Special Accessories

There are no special accessories used while test was conducted.

1.5 Equipment Modifications

There was no modification incorporated into the EUT.

Unless otherwise stated the results shown in this test report refer only to the sample(s) tested and such sample(s) are retained for 90 days only.

除非另有說明，此報告結果僅對測試之樣品負責，同時此樣品僅保留90天。本報告未經本公司書面許可，不可部份複製。

This document is issued by the Company subject to its General Conditions of Service printed overleaf, available on request or accessible at www.sgs.com/terms_and_conditions.htm and, for electronic format documents, subject to Terms and Conditions for Electronic Documents at www.sgs.com/terms_e-document.htm. Attention is drawn to the limitation of liability, indemnification and jurisdiction issues defined therein. Any holder of this document is advised that information contained hereon reflects the Company's findings at the time of its intervention only and within the limits of Client's instructions, if any. The Company's sole responsibility is to its Client and this document does not exonerate parties to a transaction from exercising all their rights and obligations under the transaction documents. This document cannot be reproduced except in full, without prior written approval of the Company. Any unauthorized alteration, forgery or falsification of the content or appearance of this document is unlawful and offenders may be prosecuted to the fullest extent of the law.

SGS Taiwan Ltd.

No.134,WuKungRoad,NewTaipeiIndustrialPark,WukuDistrict,NewTaipeiCity,Taiwan24803/新北市五股區新北產業園區五工路 134 號

台灣檢驗科技股份有限公司

t (886-2) 2299-3279

f (886-2) 2298-0488

www.tw.sgs.com

Member of SGS Group

2 SYSTEM TEST CONFIGURATION

2.1 EUT Configuration

The EUT configuration for testing is installed on RF field strength measurement to meet the Commissions requirement and operating in a manner which intends to maximize its emission characteristics in a continuous normal application.

2.2 EUT Exercise

An engineering test mode (software/firmware) that applicant provided was utilized to manipulate the EUT into transmit, selection of the test channel, and modulation scheme.

2.3 Test Procedure

2.3.1 Conducted Emissions

The EUT is placed on a turn table which is 0.8 m above ground plane. Conducted emissions from the EUT measured in the frequency range between 0.15 MHz and 30MHz. The CISPR Quasi-Peak and Average detector mode is employed according to §15.207. The two LISNs provide 50 ohm/ 50uH of coupling impedance for the measuring instrument. Both lines of the power mains connected to the EUT were checked for maximum conducted interference.

2.3.2 Radiated Emissions

The EUT is placed on a turn table. For emissions testing at or below 1 GHz, the table height shall be 0.8 m above the reference ground plane. For emission measurements above 1 GHz, the table height shall be 1.5 m. The turn table shall rotate 360 degrees to determine the position of maximum emission level. EUT is set 3m away from the receiving antenna which varied from 1m to 4m to find out the highest emission. And also, each emission was to be maximized by changing the polarization of receiving antenna both horizontal and vertical. In order to find out the max. emission, the relative positions of this hand-held transmitter (EUT) was rotated through three orthogonal axes and measurement procedures for electric field radiated emissions above 1 GHz the EUT measurement is to be made "while keeping the antenna in the 'cone of radiation' from that area and pointed at the area both in azimuth and elevation, with polarization oriented for maximum response." is still within the 3dB illumination BW of the measurement antenna.

2.4 Measurement Results Explanation Example

For all conducted test items:

The offset level is set in the spectrum analyzer to compensate the RF cable loss and attenuation factor between EUT conducted port and spectrum analyzer. With the offset compensation, the spectrum analyzer reading level is exactly EUT RF output level.

Note:

The spectrum analyzer offset is derived from RF cable loss and attenuator factor. Following shows an offset computation example with cable loss and attenuator.

SISO Offset:

= RF cable loss (dB)+ attenuation factor(dB) dB =10.4dB

MIMO Offset:

= RF cable loss (dB)+ attenuation factor(dB) dB =13.4dB

Unless otherwise stated the results shown in this test report refer only to the sample(s) tested and such sample(s) are retained for 90 days only.

除非另有說明，此報告結果僅對測試之樣品負責，同時此樣品僅保留90天。本報告未經本公司書面許可，不可部份複製。

This document is issued by the Company subject to its General Conditions of Service printed overleaf, available on request or accessible at www.sgs.com/terms_and_conditions.htm and, for electronic format documents, subject to Terms and Conditions for Electronic Documents at www.sgs.com/terms_e-document.htm. Attention is drawn to the limitation of liability, indemnification and jurisdiction issues defined therein. Any holder of this document is advised that information contained hereon reflects the Company's findings at the time of its intervention only and within the limits of Client's instructions, if any. The Company's sole responsibility is to its Client and this document does not exonerate parties to a transaction from exercising all their rights and obligations under the transaction documents. This document cannot be reproduced except in full, without prior written approval of the Company. Any unauthorized alteration, forgery or falsification of the content or appearance of this document is unlawful and offenders may be prosecuted to the fullest extent of the law.

2.5 Configuration of Tested System

Fig. 2-1 Conducted (Antenna Port) Emission Configuration

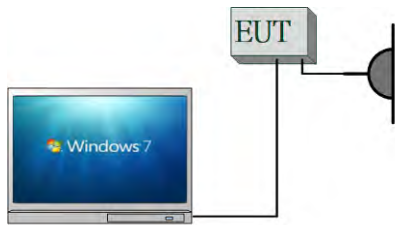

Fig. 2-3 Conduction (AC Power Line) Radiated Emission

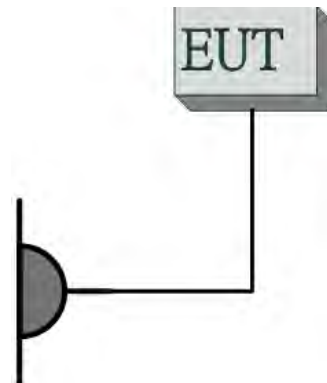

Fig. 2-2 Radiated Emission

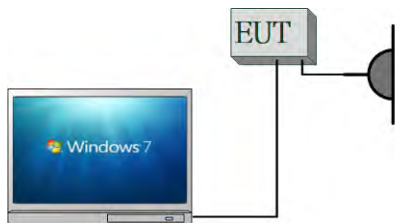

Table 2-1 Equipment Used in Tested System

Item	Equipment	Mfr/Brand	Model/Type No.	Series No.	Data Cable	Power Cord
1.	WLAN Test Software	N/A	N/A	N/A	N/A	N/A
2.	Notebook	Lenovo	L430	R9-YYG88	Shielded	Unshielded

Unless otherwise stated the results shown in this test report refer only to the sample(s) tested and such sample(s) are retained for 90 days only.

除非另有說明，此報告結果僅對測試之樣品負責，同時此樣品僅保留90天。本報告未經本公司書面許可，不可部份複製。

This document is issued by the Company subject to its General Conditions of Service printed overleaf, available on request or accessible at www.sgs.com/terms_and_conditions.htm and, for electronic format documents, subject to Terms and Conditions for Electronic Documents at www.sgs.com/terms_e-document.htm. Attention is drawn to the limitation of liability, indemnification and jurisdiction issues defined therein. Any holder of this document is advised that information contained hereon reflects the Company's findings at the time of its intervention only and within the limits of Client's instructions, if any. The Company's sole responsibility is to its Client and this document does not exonerate parties to a transaction from exercising all their rights and obligations under the transaction documents. This document cannot be reproduced except in full, without prior written approval of the Company. Any unauthorized alteration, forgery or falsification of the content or appearance of this document is unlawful and offenders may be prosecuted to the fullest extent of the law.

SGS Taiwan Ltd.

No.134,WuKungRoad,NewTaipeiIndustrialPark,WukuDistrict,NewTaipeiCity,Taiwan24803/新北市五股區新北產業園區五工路 134 號

台灣檢驗科技股份有限公司

t (886-2) 2299-3279

f (886-2) 2298-0488

www.tw.sgs.com

Member of SGS Group

3 SUMMARY OF TEST RESULTS

FCC Rules / IC Rules	Description Of Test	Result
§15.207(a)	AC Power Line Conducted Emission	Compliant
§15.247(b) (3)	Peak Output Power	Compliant
§15.247(a)(2)	6dB Emission Bandwidth	Compliant
§15.247(d)	Conducted Band Edge and Spurious Emission	Compliant
§15.247(d)	Radiated Band Edge and Spurious Emission	Compliant
§15.247(e)	Power Spectral Density	Compliant
§15.203 §15.247(b)	Antenna Requirement	Compliant

Unless otherwise stated the results shown in this test report refer only to the sample(s) tested and such sample(s) are retained for 90 days only.

除非另有說明，此報告結果僅對測試之樣品負責，同時此樣品僅保留90天。本報告未經本公司書面許可，不可部份複製。

This document is issued by the Company subject to its General Conditions of Service printed overleaf, available on request or accessible at www.sgs.com/terms_and_conditions.htm and, for electronic format documents, subject to Terms and Conditions for Electronic Documents at www.sgs.com/terms_e-document.htm. Attention is drawn to the limitation of liability, indemnification and jurisdiction issues defined therein. Any holder of this document is advised that information contained hereon reflects the Company's findings at the time of its intervention only and within the limits of Client's instructions, if any. The Company's sole responsibility is to its Client and this document does not exonerate parties to a transaction from exercising all their rights and obligations under the transaction documents. This document cannot be reproduced except in full, without prior written approval of the Company. Any unauthorized alteration, forgery or falsification of the content or appearance of this document is unlawful and offenders may be prosecuted to the fullest extent of the law.

SGS Taiwan Ltd.

No.134,WuKungRoad,NewTaipeiIndustrialPark,WukuDistrict,NewTaipeiCity,Taiwan24803/新北市五股區新北產業園區五工路 134 號

台灣檢驗科技股份有限公司

t (886-2) 2299-3279

f (886-2) 2298-0488

www.tw.sgs.com

Member of SGS Group

4 DESCRIPTION OF TEST MODES

4.1 Operated in 2400 ~ 2483.5MHz Band

11 channels are provided for 802.11b, 802.11g and 802.11n_HT20

CHANNEL	FREQUENCY	CHANNEL	FREQUENCY
1	2412 MHz	7	2442 MHz
2	2417 MHz	8	2447 MHz
3	2422 MHz	9	2452 MHz
4	2427 MHz	10	2457 MHz
5	2432 MHz	11	2462 MHz
6	2437 MHz		

7 channels are provided for 802.11n_HT40

CHANNEL	FREQUENCY	CHANNEL	FREQUENCY
3	2422 MHz	7	2442 MHz
4	2427 MHz	8	2447 MHz
5	2432 MHz	9	2452 MHz
6	2437 MHz		

4.2 The Worst Test Modes and Channel Details

1. The EUT has been tested under operating condition.
2. Test program used to control the EUT for staying in continuous transmitting and receiving mode is programmed.
3. Investigation has been done on all the possible configurations for searching the worst case.

Unless otherwise stated the results shown in this test report refer only to the sample(s) tested and such sample(s) are retained for 90 days only.

除非另有說明，此報告結果僅對測試之樣品負責，同時此樣品僅保留90天。本報告未經本公司書面許可，不可部份複製。

This document is issued by the Company subject to its General Conditions of Service printed overleaf, available on request or accessible at www.sgs.com/terms_and_conditions.htm and, for electronic format documents, subject to Terms and Conditions for Electronic Documents at www.sgs.com/terms_e-document.htm. Attention is drawn to the limitation of liability, indemnification and jurisdiction issues defined therein. Any holder of this document is advised that information contained hereon reflects the Company's findings at the time of its intervention only and within the limits of Client's instructions, if any. The Company's sole responsibility is to its Client and this document does not exonerate parties to a transaction from exercising all their rights and obligations under the transaction documents. This document cannot be reproduced except in full, without prior written approval of the Company. Any unauthorized alteration, forgery or falsification of the content or appearance of this document is unlawful and offenders may be prosecuted to the fullest extent of the law.

SGS Taiwan Ltd.

No.134,WuKungRoad,NewTaipeiIndustrialPark,WukuDistrict,NewTaipeiCity,Taiwan24803/新北市五股區新北產業園區五工路 134 號

台灣檢驗科技股份有限公司

t (886-2) 2299-3279

f (886-2) 2298-0488

www.tw.sgs.com

Member of SGS Group

RADIATED EMISSION TEST:

RADIATED EMISSION TEST (BELOW 1 GHz)					
MODE	AVAILABLE CHANNEL	TESTED CHANNEL	MODULATION	DATA RATE (Mbps)	ANTENNA PORT
802.11g	1 to 11	1,6,11	OFDM	6	MIMO

RADIATED EMISSION TEST (ABOVE 1 GHz)					
MODE	AVAILABLE CHANNEL	TESTED CHANNEL	MODULATION	DATA RATE (Mbps)	ANTENNA PORT
802.11b	1 to 11	1, 6, 11	DSSS	1	MIMO
802.11g	1 to 11	1, 6, 11	OFDM	6	MIMO
802.11n (HT20)	1 to 11	1, 6, 11	OFDM	MCS 8	MIMO

Note:

The field strength of radiation emission was measured as EUT stand-up position (H mode) and lie down position (E1, E2 mode) for 802.11b/g/n WLAN Transmitter for channel Low, Mid and High, the worst case H position was reported.

ANTENNA PORT CONDUCTED MEASUREMENT:

CONDUCTED TEST					
MODE	AVAILABLE CHANNEL	TESTED CHANNEL	MODULATION	DATA RATE (Mbps)	ANTENNA PORT
802.11b	1 to 11	1, 6, 11	DSSS	1	MIMO
802.11g	1 to 11	1, 6, 11	OFDM	6	MIMO
802.11n (HT20)	1 to 11	1, 6, 11	OFDM	MCS 8	MIMO

Unless otherwise stated the results shown in this test report refer only to the sample(s) tested and such sample(s) are retained for 90 days only.

除非另有說明，此報告結果僅對測試之樣品負責，同時此樣品僅保留90天。本報告未經本公司書面許可，不可部份複製。

This document is issued by the Company subject to its General Conditions of Service printed overleaf, available on request or accessible at www.sgs.com/terms_and_conditions.htm and, for electronic format documents, subject to Terms and Conditions for Electronic Documents at www.sgs.com/terms_e-document.htm. Attention is drawn to the limitation of liability, indemnification and jurisdiction issues defined therein. Any holder of this document is advised that information contained hereon reflects the Company's findings at the time of its intervention only and within the limits of Client's instructions, if any. The Company's sole responsibility is to its Client and this document does not exonerate parties to a transaction from exercising all their rights and obligations under the transaction documents. This document cannot be reproduced except in full, without prior written approval of the Company. Any unauthorized alteration, forgery or falsification of the content or appearance of this document is unlawful and offenders may be prosecuted to the fullest extent of the law.

SGS Taiwan Ltd.

No.134,WuKungRoad,NewTaipeiIndustrialPark,WukuDistrict,NewTaipeiCity,Taiwan24803/新北市五股區新北產業園區五工路 134 號

台灣檢驗科技股份有限公司

t (886-2) 2299-3279

f (886-2) 2298-0488

www.tw.sgs.com

Member of SGS Group

Directional gain (MIMO)

The Tx transmission to construct MIMO operation is cyclic delay diversity, and the following deduction to obtain the array gain of MIMO operation is based on the approach given by KDB 662911 D01.

Array gain = 3.01dBi (peak spectral density, conducted spurious emission)

Gain that is combined with different magnitude of two antennas:

(ii) If antenna gains are not equal, the user may use either of the following methods to calculate directional gain, provided that each transmit antenna is driven by only one spatial stream:

- Directional gain may be calculated by using the formulas applicable to equal gain antennas with G_{ANT} set equal to the gain of the antenna having the highest gain; or,

$$DirectionalGain = 10 \cdot \log \left[\frac{\sum_{j=1}^{N_{SS}} \left\{ \sum_{k=1}^{N_{ANT}} g_{j,k} \right\}^2}{N_{ANT}} \right]$$

where

Each antenna is driven by no more than one spatial stream;

N_{SS} = the number of independent spatial streams of data;

N_{ANT} = the total number of antennas

$g_{j,k} = 10^{G_k/20}$ if the k th antenna is being fed by spatial stream j , or zero if it is not;

G_k is the gain in dBi of the k th antenna.

Unless otherwise stated the results shown in this test report refer only to the sample(s) tested and such sample(s) are retained for 90 days only.

除非另有說明，此報告結果僅對測試之樣品負責，同時此樣品僅保留90天。本報告未經本公司書面許可，不可部份複製。

This document is issued by the Company subject to its General Conditions of Service printed overleaf, available on request or accessible at www.sgs.com/terms_and_conditions.htm and, for electronic format documents, subject to Terms and Conditions for Electronic Documents at www.sgs.com/terms_e-document.htm. Attention is drawn to the limitation of liability, indemnification and jurisdiction issues defined therein. Any holder of this document is advised that information contained hereon reflects the Company's findings at the time of its intervention only and within the limits of Client's instructions, if any. The Company's sole responsibility is to its Client and this document does not exonerate parties to a transaction from exercising all their rights and obligations under the transaction documents. This document cannot be reproduced except in full, without prior written approval of the Company. Any unauthorized alteration, forgery or falsification of the content or appearance of this document is unlawful and offenders may be prosecuted to the fullest extent of the law.

SGS Taiwan Ltd.

No.134,WuKungRoad,NewTaipeiIndustrialPark,WukuDistrict,NewTaipeiCity,Taiwan24803/新北市五股區新北產業園區五工路 134 號

台灣檢驗科技股份有限公司

t (886-2) 2299-3279

f (886-2) 2298-0488

www.tw.sgs.com

Member of SGS Group

5 MEASUREMENT UNCERTAINTY

Test Items	Uncertainty
AC Power Line Conducted Emission	+/- 2.586 dB
Peak Output Power	+/- 0.84 dB
6dB Bandwidth	+/- 51.33 Hz
100 KHz Bandwidth Of Frequency Band Edges	+/- 0.84 dB
Peak Power Density	+/- 1.3 dB
Temperature	+/- 0.65 °C
Humidity	+/- 4.6 %
DC / AC Power Source	DC= +/- 0.13%, AC= +/- 0.2%

Radiated Spurious Emission:

Measurement uncertainty (Polarization : Vertical)	9kHz-30MHz: +/-2.87dB
	30MHz - 180MHz: +/- 3.37dB
	180MHz -417MHz: +/- 3.19dB
	0.417GHz-1GHz: +/- 3.19dB
	1GHz - 18GHz: +/- 4.04dB
	18GHz - 40GHz: +/- 4.04dB

Measurement uncertainty (Polarization : Horizontal)	9kHz-30MHz: +/-2.87dB
	30MHz - 167MHz: +/- 4.22dB
	167MHz -500MHz: +/- 3.44dB
	0.5GHz-1GHz: +/- 3.39dB
	1GHz - 18GHz: +/- 4.08dB
	18GHz - 40GHz: +/- 4.08dB

This uncertainty represents an expanded uncertainty expressed at approximately the 95% confidence level using a coverage factor of k=2.

Unless otherwise stated the results shown in this test report refer only to the sample(s) tested and such sample(s) are retained for 90 days only.

除非另有說明，此報告結果僅對測試之樣品負責，同時此樣品僅保留90天。本報告未經本公司書面許可，不可部份複製。

This document is issued by the Company subject to its General Conditions of Service printed overleaf, available on request or accessible at www.sgs.com/terms_and_conditions.htm and, for electronic format documents, subject to Terms and Conditions for Electronic Documents at www.sgs.com/terms_e-document.htm. Attention is drawn to the limitation of liability, indemnification and jurisdiction issues defined therein. Any holder of this document is advised that information contained hereon reflects the Company's findings at the time of its intervention only and within the limits of Client's instructions, if any. The Company's sole responsibility is to its Client and this document does not exonerate parties to a transaction from exercising all their rights and obligations under the transaction documents. This document cannot be reproduced except in full, without prior written approval of the Company. Any unauthorized alteration, forgery or falsification of the content or appearance of this document is unlawful and offenders may be prosecuted to the fullest extent of the law.

6 CONDUCTED EMISSION TEST

6.1 Standard Applicable

Frequency range within 150kHz to 30MHz shall not exceed the Limit table as below.

Frequency range MHz	Limits dB(uV)	
	Quasi-peak	Average
0.15 to 0.50	66 to 56	56 to 46
0.50 to 5	56	46
5 to 30	60	50

Note

- 1.The lower limit shall apply at the transition frequencies
- 2.The limit decreases linearly with the logarithm of the frequency in the range 0.15 MHz to 0.50 MHz.

6.2 Measurement Equipment Used

Conducted Emission Test Site					
EQUIPMENT TYPE	MFR	MODEL NUMBER	SERIAL NUMBER	LAST CAL.	CAL DUE.
EMI Test Receiver	R&S	ESCI 7	100950	12/12/2016	12/11/2017
Coaxial Cables	N/A	N30N30-1042-150cm	N/A	08/30/2016	08/29/2017
LISN	Schwarzbeck	NSLK 8127	8127-648	06/18/2017	06/17/2018
Test Software	Farad	EZ-EMC	Ver. SGS-03A2	N.C.R.	N.C.R.

6.3 EUT Setup

1. The conducted emission tests were performed in the test site, using the setup in accordance with the ANSI 63.10:2013.
2. The AC/DC Power adaptor of EUT was plug-in LISN. The EUT was placed flushed with the rear of the table.
3. The LISN was connected with 120Vac/60Hz power source.

Unless otherwise stated the results shown in this test report refer only to the sample(s) tested and such sample(s) are retained for 90 days only.

除非另有說明，此報告結果僅對測試之樣品負責，同時此樣品僅保留90天。本報告未經本公司書面許可，不可部份複製。

This document is issued by the Company subject to its General Conditions of Service printed overleaf, available on request or accessible at www.sgs.com/terms_and_conditions.htm and, for electronic format documents, subject to Terms and Conditions for Electronic Documents at www.sgs.com/terms_e-document.htm. Attention is drawn to the limitation of liability, indemnification and jurisdiction issues defined therein. Any holder of this document is advised that information contained hereon reflects the Company's findings at the time of its intervention only and within the limits of Client's instructions, if any. The Company's sole responsibility is to its Client and this document does not exonerate parties to a transaction from exercising all their rights and obligations under the transaction documents. This document cannot be reproduced except in full, without prior written approval of the Company. Any unauthorized alteration, forgery or falsification of the content or appearance of this document is unlawful and offenders may be prosecuted to the fullest extent of the law.

6.4 Test SET-UP (Block Diagram of Configuration)

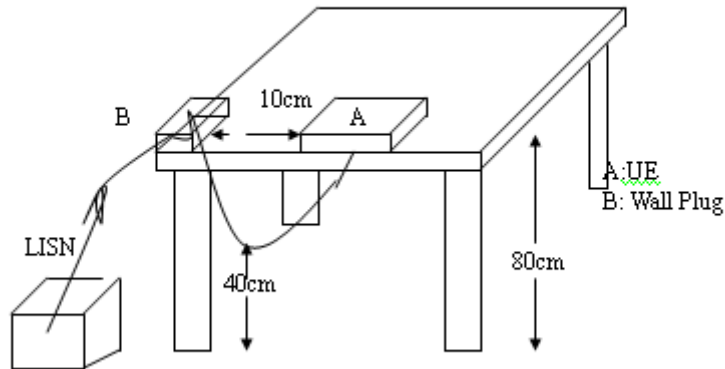

6.5 Measurement Procedure

1. The EUT was placed on a table which is 0.8m above ground plane.
2. Maximum procedure was performed on the six highest emissions to ensure EUT compliance.
3. Repeat above procedures until all phases of power being supplied by given UE are completed

6.6 Measurement Result

Note: Refer to next page for measurement data and plots.

Note2: The * reveals the worst-case results that closet to the limit

Unless otherwise stated the results shown in this test report refer only to the sample(s) tested and such sample(s) are retained for 90 days only.

除非另有說明，此報告結果僅對測試之樣品負責，同時此樣品僅保留90天。本報告未經本公司書面許可，不可部份複製。

This document is issued by the Company subject to its General Conditions of Service printed overleaf, available on request or accessible at www.sgs.com/terms_and_conditions.htm and, for electronic format documents, subject to Terms and Conditions for Electronic Documents at www.sgs.com/terms_e-document.htm. Attention is drawn to the limitation of liability, indemnification and jurisdiction issues defined therein. Any holder of this document is advised that information contained hereon reflects the Company's findings at the time of its intervention only and within the limits of Client's instructions, if any. The Company's sole responsibility is to its Client and this document does not exonerate parties to a transaction from exercising all their rights and obligations under the transaction documents. This document cannot be reproduced except in full, without prior written approval of the Company. Any unauthorized alteration, forgery or falsification of the content or appearance of this document is unlawful and offenders may be prosecuted to the fullest extent of the law.

SGS Taiwan Ltd.

No.134,WuKungRoad,NewTaipeiIndustrialPark,WukuDistrict,NewTaipeiCity,Taiwan24803/新北市五股區新北產業園區五工路 134 號

台灣檢驗科技股份有限公司

t (886-2) 2299-3279

f (886-2) 2298-0488

www.tw.sgs.com

Member of SGS Group

AC POWER LINE CONDUCTED EMISSION TEST DATA

Site : Conduction Room	Phase: L1	Temperature: 23 °C
Limit: FCC Class B Conduction(QP)	Power: AC 120V/60Hz	Humidity: 75 %
Mode:		
Note:		

Conducted Emission

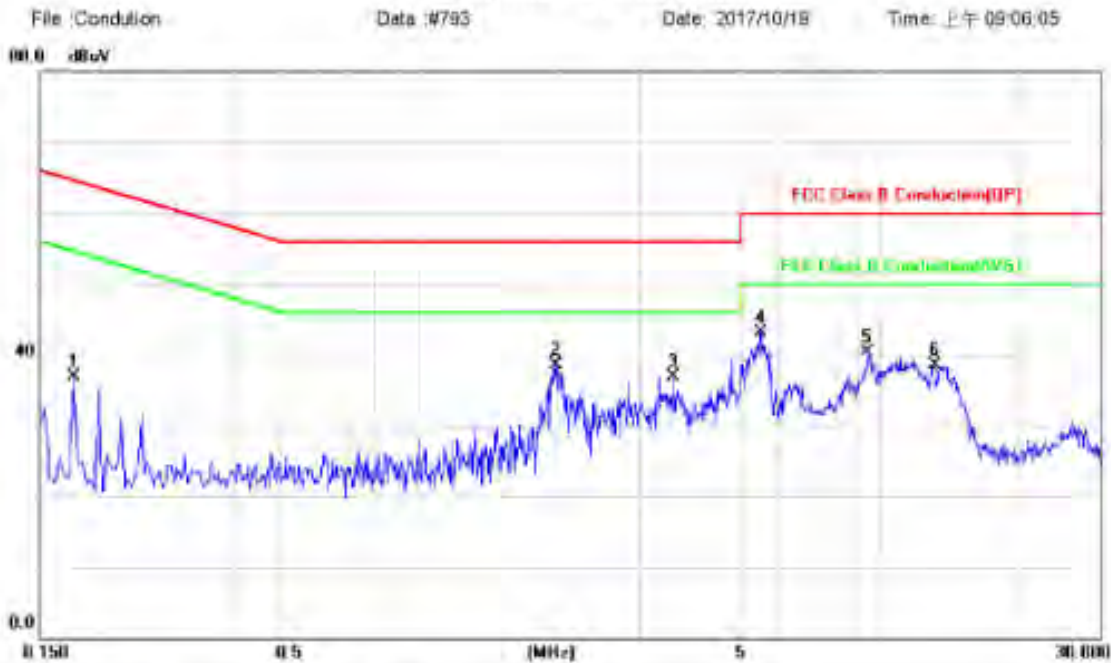

No.	Mk.	Freq. MHz	Reading Level dBuV	Correct Factor dB	Measure- ment dBuV	Limit dBuV	Over dB	Detector	Comment
1		0.1780	17.17	19.64	36.81	64.58	-27.77	peak	
2		1.9860	18.03	20.55	38.58	56.00	-17.42	peak	
3		3.5820	16.66	20.31	36.97	56.00	-19.03	peak	
4	*	5.5300	22.92	20.09	43.01	60.00	-16.99	peak	
5		9.4340	20.32	20.07	40.39	60.00	-19.61	peak	
6		13.1540	18.48	20.12	38.60	60.00	-21.40	peak	

Unless otherwise stated the results shown in this test report refer only to the sample(s) tested and such sample(s) are retained for 90 days only.

除非另有說明，此報告結果僅對測試之樣品負責，同時此樣品僅保留90天。本報告未經本公司書面許可，不可部份複製。

This document is issued by the Company subject to its General Conditions of Service printed overleaf, available on request or accessible at www.sgs.com/terms_and_conditions.htm and, for electronic format documents, subject to Terms and Conditions for Electronic Documents at www.sgs.com/terms_e-document.htm. Attention is drawn to the limitation of liability, indemnification and jurisdiction issues defined therein. Any holder of this document is advised that information contained hereon reflects the Company's findings at the time of its intervention only and within the limits of Client's instructions, if any. The Company's sole responsibility is to its Client and this document does not exonerate parties to a transaction from exercising all their rights and obligations under the transaction documents. This document cannot be reproduced except in full, without prior written approval of the Company. Any unauthorized alteration, forgery or falsification of the content or appearance of this document is unlawful and offenders may be prosecuted to the fullest extent of the law.

SGS Taiwan Ltd.

No.134,WuKungRoad,NewTaipeiIndustrialPark,WukuDistrict,NewTaipeiCity,Taiwan24803/新北市五股區新北產業園區五工路 134 號

台灣檢驗科技股份有限公司

t (886-2) 2299-3279

f (886-2) 2298-0488

www.tw.sgs.com

Member of SGS Group

Site : Conduction Room	Phase: N	Temperature: 23 °C
Limit: FCC Class B Conduction(QP)	Power: AC 120V/60Hz	Humidity: 75 %
Mode:		
Note:		

Conducted Emission

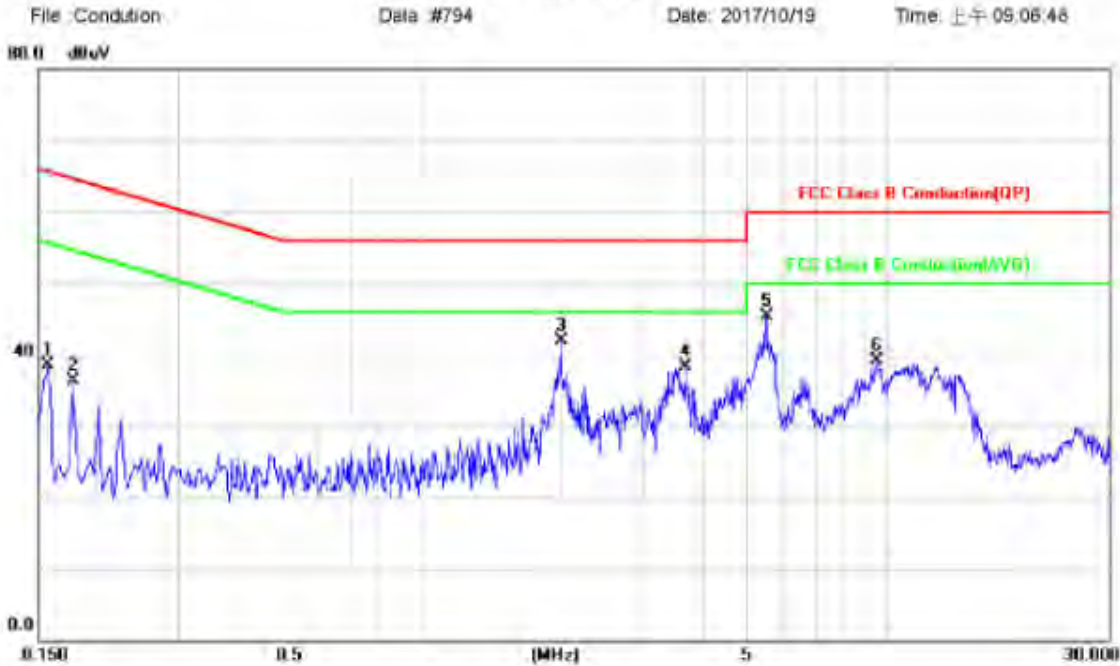

No.	Mk.	Freq.	Reading Level	Correct Factor	Measurement	Limit	Over	Detector	Comment
		MHz	dBuV	dB	dBuV	dBuV	dB		
1		0.1580	18.94	19.50	38.44	65.57	-27.13	peak	
2		0.1780	16.75	19.49	36.24	64.58	-28.34	peak	
3	*	1.9940	21.58	20.42	42.00	56.00	-14.00	peak	
4		3.6900	18.06	20.16	38.22	56.00	-17.78	peak	
5		5.5260	25.34	19.96	45.30	60.00	-14.70	peak	
6		9.5300	19.08	19.94	39.02	60.00	-20.98	peak	

Unless otherwise stated the results shown in this test report refer only to the sample(s) tested and such sample(s) are retained for 90 days only.

除非另有說明，此報告結果僅對測試之樣品負責，同時此樣品僅保留90天。本報告未經本公司書面許可，不可部份複製。

This document is issued by the Company subject to its General Conditions of Service printed overleaf, available on request or accessible at www.sgs.com/terms_and_conditions.htm and, for electronic format documents, subject to Terms and Conditions for Electronic Documents at www.sgs.com/terms_e-document.htm. Attention is drawn to the limitation of liability, indemnification and jurisdiction issues defined therein. Any holder of this document is advised that information contained hereon reflects the Company's findings at the time of its intervention only and within the limits of Client's instructions, if any. The Company's sole responsibility is to its Client and this document does not exonerate parties to a transaction from exercising all their rights and obligations under the transaction documents. This document cannot be reproduced except in full, without prior written approval of the Company. Any unauthorized alteration, forgery or falsification of the content or appearance of this document is unlawful and offenders may be prosecuted to the fullest extent of the law.

SGS Taiwan Ltd.

No.134,WuKungRoad,NewTaipeiIndustrialPark,WukuDistrict,NewTaipeiCity,Taiwan24803/新北市五股區新北產業園區五工路 134 號

台灣檢驗科技股份有限公司

t (886-2) 2299-3279

f (886-2) 2298-0488

www.tw.sgs.com

Member of SGS Group

7 DUTY CYCLE OF TEST SIGNAL

Pre-analysis Check: While conducting average power measurement, duty cycle of each mode shall be checked to ensure its duty cycle in order to compensate for the loss due to insufficient ratio of duty cycle.

All duty cycle is pre-scanned, and result as obtained below shows only the most representative ones where duty cycle is conducted as the given transmission with given virtual operation that expresses the percentage.

Formula:

$$\text{Duty Cycle} = \text{Ton} / (\text{Ton} + \text{Toff})$$

Measurement Procedure:

1. Set span = Zero
2. RBW = 8MHz
3. VBW = 8MHz,
4. Detector = Peak

Duty Cycle:

	Duty Cycle (%)	Duty Factor (dB)
802.11b	99.72	0.01
802.11g	97.55	0.11
802.11n_20	94.89	0.23

$$b = 99.72\%, g = 97.55\%, n_{ht_20} = 94.89\%$$

$$\text{Duty Cycle Factor: } 10 * \log(1/0.9972) = 0.01$$

$$\text{Duty Cycle Factor: } 10 * \log(1/0.9755) = 0.11$$

$$\text{Duty Cycle Factor: } 10 * \log(1/0.9489) = 0.23$$

Unless otherwise stated the results shown in this test report refer only to the sample(s) tested and such sample(s) are retained for 90 days only.

除非另有說明，此報告結果僅對測試之樣品負責，同時此樣品僅保留90天。本報告未經本公司書面許可，不可部份複製。

This document is issued by the Company subject to its General Conditions of Service printed overleaf, available on request or accessible at www.sgs.com/terms_and_conditions.htm and, for electronic format documents, subject to Terms and Conditions for Electronic Documents at www.sgs.com/terms_e-document.htm. Attention is drawn to the limitation of liability, indemnification and jurisdiction issues defined therein. Any holder of this document is advised that information contained hereon reflects the Company's findings at the time of its intervention only and within the limits of Client's instructions, if any. The Company's sole responsibility is to its Client and this document does not exonerate parties to a transaction from exercising all their rights and obligations under the transaction documents. This document cannot be reproduced except in full, without prior written approval of the Company. Any unauthorized alteration, forgery or falsification of the content or appearance of this document is unlawful and offenders may be prosecuted to the fullest extent of the law.

SGS Taiwan Ltd.

No.134,WuKungRoad,NewTaipeiIndustrialPark,WukuDistrict,NewTaipeiCity,Taiwan24803/新北市五股區新北產業園區五工路 134 號

台灣檢驗科技股份有限公司

t (886-2) 2299-3279

f (886-2) 2298-0488

www.tw.sgs.com

Member of SGS Group

7.1 Duty Cycle Test Signal Measurement Result 802.11 b



802.11 g



Unless otherwise stated the results shown in this test report refer only to the sample(s) tested and such sample(s) are retained for 90 days only.

除非另有說明，此報告結果僅對測試之樣品負責，同時此樣品僅保留90天。本報告未經本公司書面許可，不可部份複製。

This document is issued by the Company subject to its General Conditions of Service printed overleaf, available on request or accessible at www.sgs.com/terms_and_conditions.htm and, for electronic format documents, subject to Terms and Conditions for Electronic Documents at www.sgs.com/terms_e-document.htm. Attention is drawn to the limitation of liability, indemnification and jurisdiction issues defined therein. Any holder of this document is advised that information contained hereon reflects the Company's findings at the time of its intervention only and within the limits of Client's instructions, if any. The Company's sole responsibility is to its Client and this document does not exonerate parties to a transaction from exercising all their rights and obligations under the transaction documents. This document cannot be reproduced except in full, without prior written approval of the Company. Any unauthorized alteration, forgery or falsification of the content or appearance of this document is unlawful and offenders may be prosecuted to the fullest extent of the law.

SGS Taiwan Ltd.

No. 134, WuKungRoad, NewTaipeiIndustrialPark, WukuDistrict, NewTaipeiCity, Taiwan24803/新北市五股區新北產業園區五工路 134 號

台灣檢驗科技股份有限公司

t (886-2) 2299-3279

f (886-2) 2298-0488

www.tw.sgs.com

Member of SGS Group

802.11 n_20 MHz



Unless otherwise stated the results shown in this test report refer only to the sample(s) tested and such sample(s) are retained for 90 days only.

除非另有說明，此報告結果僅對測試之樣品負責，同時此樣品僅保留90天。本報告未經本公司書面許可，不可部份複製。

This document is issued by the Company subject to its General Conditions of Service printed overleaf, available on request or accessible at www.sgs.com/terms_and_conditions.htm and, for electronic format documents, subject to Terms and Conditions for Electronic Documents at www.sgs.com/terms_e-document.htm. Attention is drawn to the limitation of liability, indemnification and jurisdiction issues defined therein. Any holder of this document is advised that information contained hereon reflects the Company's findings at the time of its intervention only and within the limits of Client's instructions, if any. The Company's sole responsibility is to its Client and this document does not exonerate parties to a transaction from exercising all their rights and obligations under the transaction documents. This document cannot be reproduced except in full, without prior written approval of the Company. Any unauthorized alteration, forgery or falsification of the content or appearance of this document is unlawful and offenders may be prosecuted to the fullest extent of the law.

SGS Taiwan Ltd.

No.134,WuKungRoad,NewTaipeiIndustrialPark,WukuDistrict,NewTaipeiCity,Taiwan24803/新北市五股區新北產業園區五工路 134 號

台灣檢驗科技股份有限公司

t (886-2) 2299-3279

f (886-2) 2298-0488

www.tw.sgs.com

Member of SGS Group

8 PEAK OUTPUT POWER MEASUREMENT

8.1 Standard Applicable

For systems using digital modulation in the 2400-2483.5 MHz bands, the limit for peak output power is 1Watt.

If the transmitting antenna of directional gain greater than 6dBi are used the peak output power from the intentional radiator shall be reduced below the above stated value by the amount in dB that the directional gain of the Antenna exceeds 6dBi.

In case of point-to-point operation, the limit has to be reduced by 1dB for every 3dB that the directional gain of Antenna exceeds 6dBi.

Note:

Main Antenna Gain:	4.10 dBi
Aux1 Antenna Gain:	3.90 dBi
Aux2 Antenna Gain:	0.00 dBi
Limit:	30 dBm

The antenna gain is not grater than 6dBi in MIMO mode the limit as below:

Directional gain = gain of antenna element + 10 log (# of TX antenna elements)

Effective Legacy Gain (dBi) = 4.1dBi

Limit: 30dBm – (4.1– 6dBi)=30

Unless otherwise stated the results shown in this test report refer only to the sample(s) tested and such sample(s) are retained for 90 days only.

除非另有說明，此報告結果僅對測試之樣品負責，同時此樣品僅保留90天。本報告未經本公司書面許可，不可部份複製。

This document is issued by the Company subject to its General Conditions of Service printed overleaf, available on request or accessible at www.sgs.com/terms_and_conditions.htm and, for electronic format documents, subject to Terms and Conditions for Electronic Documents at www.sgs.com/terms_e-document.htm. Attention is drawn to the limitation of liability, indemnification and jurisdiction issues defined therein. Any holder of this document is advised that information contained hereon reflects the Company's findings at the time of its intervention only and within the limits of Client's instructions, if any. The Company's sole responsibility is to its Client and this document does not exonerate parties to a transaction from exercising all their rights and obligations under the transaction documents. This document cannot be reproduced except in full, without prior written approval of the Company. Any unauthorized alteration, forgery or falsification of the content or appearance of this document is unlawful and offenders may be prosecuted to the fullest extent of the law.

SGS Taiwan Ltd.

No.134,WuKungRoad,NewTaipeiIndustrialPark,WukuDistrict,NewTaipeiCity,Taiwan24803/新北市五股區新北產業園區五工路 134 號

台灣檢驗科技股份有限公司

t (886-2) 2299-3279

f (886-2) 2298-0488

www.tw.sgs.com

Member of SGS Group

8.2 Measurement Equipment Used

Conducted Emission Test Site					
EQUIPMENT TYPE	MFR	MODEL NUMBER	SERIAL NUMBER	LAST CAL.	CAL DUE.
Spectrum Analyzer	KEYSIGHT	N9010A	MY51440113	06/20/2017	06/19/2018
Power Meter	Anritsu	ML2496A	1326001	06/23/2017	06/22/2018
Power Sensor	Anritsu	MA2411B	1315048	06/23/2017	06/22/2018
Power Sensor	Anritsu	MA2411B	1315049	06/23/2017	06/22/2018
Coaxial Cable 30cm	WOKEN	00100A1F1A195C	RF01	12/12/2016	12/11/2017
DC Block	PASTERNAK	PE8210	RF29	12/12/2016	12/11/2017
Splitter	RF-LAMBAD	RFLT2W1G18G	RF35	12/12/2016	12/11/2017
Attenuator	WOKEN	218FS-10	RF23	12/12/2016	12/11/2017
DC Power Supply	Agilent	E3640A	MY53140006	05/02/2017	05/01/2018

8.3 Test Set-up

Power Meter:

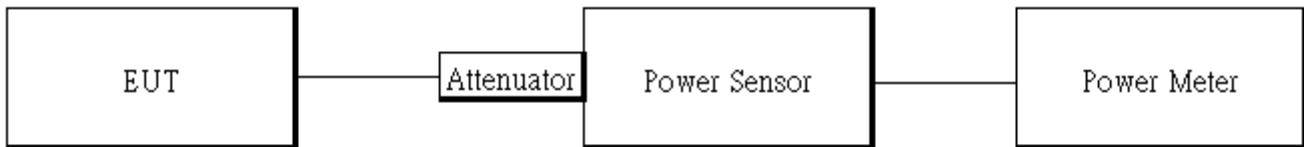

8.4 Measurement Procedure

1. Place the EUT on the table and set it in transmitting mode.
2. The testing follows the Measurement Procedure of FCC KDB 558074 D01 DTS Meas. Guidance .
3. Remove the antenna from the EUT and then connect a low loss RF cable from the antenna port to the power meter.

Power Meter:

It is used as the auxiliary test equipment to conduct the output power measurement.

4. Record the max. Reading as observed from Spectrum or Power Meter.

Unless otherwise stated the results shown in this test report refer only to the sample(s) tested and such sample(s) are retained for 90 days only.

除非另有說明，此報告結果僅對測試之樣品負責，同時此樣品僅保留90天。本報告未經本公司書面許可，不可部份複製。

This document is issued by the Company subject to its General Conditions of Service printed overleaf, available on request or accessible at www.sgs.com/terms_and_conditions.htm and, for electronic format documents, subject to Terms and Conditions for Electronic Documents at www.sgs.com/terms_e-document.htm. Attention is drawn to the limitation of liability, indemnification and jurisdiction issues defined therein. Any holder of this document is advised that information contained hereon reflects the Company's findings at the time of its intervention only and within the limits of Client's instructions, if any. The Company's sole responsibility is to its Client and this document does not exonerate parties to a transaction from exercising all their rights and obligations under the transaction documents. This document cannot be reproduced except in full, without prior written approval of the Company. Any unauthorized alteration, forgery or falsification of the content or appearance of this document is unlawful and offenders may be prosecuted to the fullest extent of the law.

8.5 Measurement Result

802.11b Main					
CH	Freq. (MHz)	Data Rate	Peak Output Power (dBm)	Limit	RESULT
1	2412	1	16.46	1 Watt = 30.00 dBm	PASS
6	2437	1	16.55	1 Watt = 30.00 dBm	PASS
11	2462	1	16.52	1 Watt = 30.00 dBm	PASS

802.11b Main					
CH	Freq. (MHz)	Data Rate	Max. Avg. Output include tune up tolerance Power (dBm)	Limit	RESULT
1	2412	1	13.90	1 Watt = 30.00 dBm	PASS
6	2437	1	13.95	1 Watt = 30.00 dBm	PASS
11	2462	1	13.93	1 Watt = 30.00 dBm	PASS

802.11b Aux1					
CH	Freq. (MHz)	Data Rate	Peak Output Power (dBm)	Limit	RESULT
1	2412	1	16.17	1 Watt = 30.00 dBm	PASS
6	2437	1	16.43	1 Watt = 30.00 dBm	PASS
11	2462	1	16.35	1 Watt = 30.00 dBm	PASS

802.11b Aux1					
CH	Freq. (MHz)	Data Rate	Max. Avg. Output include tune up tolerance Power (dBm)	Limit	RESULT
1	2412	1	13.70	1 Watt = 30.00 dBm	PASS
6	2437	1	13.93	1 Watt = 30.00 dBm	PASS
11	2462	1	13.83	1 Watt = 30.00 dBm	PASS

Unless otherwise stated the results shown in this test report refer only to the sample(s) tested and such sample(s) are retained for 90 days only.

除非另有說明，此報告結果僅對測試之樣品負責，同時此樣品僅保留90天。本報告未經本公司書面許可，不可部份複製。

This document is issued by the Company subject to its General Conditions of Service printed overleaf, available on request or accessible at www.sgs.com/terms_and_conditions.htm and, for electronic format documents, subject to Terms and Conditions for Electronic Documents at www.sgs.com/terms_e-document.htm. Attention is drawn to the limitation of liability, indemnification and jurisdiction issues defined therein. Any holder of this document is advised that information contained hereon reflects the Company's findings at the time of its intervention only and within the limits of Client's instructions, if any. The Company's sole responsibility is to its Client and this document does not exonerate parties to a transaction from exercising all their rights and obligations under the transaction documents. This document cannot be reproduced except in full, without prior written approval of the Company. Any unauthorized alteration, forgery or falsification of the content or appearance of this document is unlawful and offenders may be prosecuted to the fullest extent of the law.

802.11b_MIMO									
CH	Freq. (MHz)	Data Rate	Peak Output Power (dBm)		Total Peak Output Power (dBm)	Total Peak Output Power (mW)	Limit		RESULT
			CH 0	CH 1					
1	2412	1	13.02	13.91	16.50	44.65	1 Watt =	30.00 dBm	PASS
6	2437	1	13.11	13.97	16.57	45.41	1 Watt =	30.00 dBm	PASS
11	2462	1	13.05	13.93	16.52	44.90	1 Watt =	30.00 dBm	PASS

802.11b_MIMO									
CH	Freq. (MHz)	Data Rate	Avg. Output Power (dBm)		Max. Avg. Output include tune up tolerance Power (dBm)	Max. Avg. Output include tune up tolerance Power (mW)	Limit		RESULT
			CH 0	CH 1					
1	2412	1	10.51	11.24	13.91	24.55	1 Watt =	30.00 dBm	PASS
6	2437	1	10.57	11.32	13.98	24.95	1 Watt =	30.00 dBm	PASS
11	2462	1	10.55	11.27	13.95	24.75	1 Watt =	30.00 dBm	PASS

802.11g Main						
CH	Freq. (MHz)	Data Rate	Peak Output Power (dBm)	Limit		RESULT
1	2412	6	21.28	1 Watt =	30.00 dBm	PASS
6	2437	6	21.07	1 Watt =	30.00 dBm	PASS
11	2462	6	21.11	1 Watt =	30.00 dBm	PASS

802.11g Main						
CH	Freq. (MHz)	Data Rate	Max. Avg. Output include tune up tolerance Power (dBm)	Limit		RESULT
1	2412	6	14.93	1 Watt =	30.00 dBm	PASS
6	2437	6	14.72	1 Watt =	30.00 dBm	PASS
11	2462	6	14.86	1 Watt =	30.00 dBm	PASS

Unless otherwise stated the results shown in this test report refer only to the sample(s) tested and such sample(s) are retained for 90 days only.

除非另有說明，此報告結果僅對測試之樣品負責，同時此樣品僅保留90天。本報告未經本公司書面許可，不可部份複製。

This document is issued by the Company subject to its General Conditions of Service printed overleaf, available on request or accessible at www.sgs.com/terms_and_conditions.htm and, for electronic format documents, subject to Terms and Conditions for Electronic Documents at www.sgs.com/terms_e-document.htm. Attention is drawn to the limitation of liability, indemnification and jurisdiction issues defined therein. Any holder of this document is advised that information contained hereon reflects the Company's findings at the time of its intervention only and within the limits of Client's instructions, if any. The Company's sole responsibility is to its Client and this document does not exonerate parties to a transaction from exercising all their rights and obligations under the transaction documents. This document cannot be reproduced except in full, without prior written approval of the Company. Any unauthorized alteration, forgery or falsification of the content or appearance of this document is unlawful and offenders may be prosecuted to the fullest extent of the law.

SGS Taiwan Ltd.

No. 134, WuKungRoad, NewTaipeiIndustrialPark, WukuDistrict, NewTaipeiCity, Taiwan24803/新北市五股區新北產業園區五工路 134 號

台灣檢驗科技股份有限公司

t (886-2) 2299-3279

f (886-2) 2298-0488

www.tw.sgs.com

Member of SGS Group

802.11g Aux1					
CH	Freq. (MHz)	Data Rate	Peak Output Power (dBm)	Limit	RESULT
1	2412	6	20.95	1 Watt = 30.00 dBm	PASS
6	2437	6	20.77	1 Watt = 30.00 dBm	PASS
11	2462	6	20.86	1 Watt = 30.00 dBm	PASS
802.11g Aux1					
CH	Freq. (MHz)	Data Rate	Max. Avg. Output include tune up tolerance Power (dBm)	Limit	RESULT
1	2412	6	14.77	1 Watt = 30.00 dBm	PASS
6	2437	6	14.58	1 Watt = 30.00 dBm	PASS
11	2462	6	14.64	1 Watt = 30.00 dBm	PASS

802.11g_MIMO									
CH	Freq. (MHz)	Data Rate	Peak Output Power (dBm)		Total Peak Output Power (dBm)	Total Peak Output Power (mW)	Limit		RESULT
			CH 0	CH 1					
1	2412	6	18.15	18.47	21.32	135.62	1 Watt = 30.00 dBm		PASS
6	2437	6	17.98	18.24	21.12	129.49	1 Watt = 30.00 dBm		PASS
11	2462	6	18.06	18.33	21.21	132.05	1 Watt = 30.00 dBm		PASS
802.11g_MIMO									
CH	Freq. (MHz)	Data Rate	Avg. Output Power (dBm)		Max. Avg. Output include tune up tolerance Power (dBm)	Max. Avg. Output include tune up tolerance Power (mW)	Limit		RESULT
			CH 0	CH 1					
1	2412	6	11.53	12.14	14.96	30.59	1 Watt = 30.00 dBm		PASS
6	2437	6	11.36	11.91	14.76	29.20	1 Watt = 30.00 dBm		PASS
11	2462	6	11.44	12.08	14.89	30.08	1 Watt = 30.00 dBm		PASS

Unless otherwise stated the results shown in this test report refer only to the sample(s) tested and such sample(s) are retained for 90 days only.

除非另有說明，此報告結果僅對測試之樣品負責，同時此樣品僅保留90天。本報告未經本公司書面許可，不可部份複製。

This document is issued by the Company subject to its General Conditions of Service printed overleaf, available on request or accessible at www.sgs.com/terms_and_conditions.htm and, for electronic format documents, subject to Terms and Conditions for Electronic Documents at www.sgs.com/terms_e-document.htm. Attention is drawn to the limitation of liability, indemnification and jurisdiction issues defined therein. Any holder of this document is advised that information contained hereon reflects the Company's findings at the time of its intervention only and within the limits of Client's instructions, if any. The Company's sole responsibility is to its Client and this document does not exonerate parties to a transaction from exercising all their rights and obligations under the transaction documents. This document cannot be reproduced except in full, without prior written approval of the Company. Any unauthorized alteration, forgery or falsification of the content or appearance of this document is unlawful and offenders may be prosecuted to the fullest extent of the law.

SGS Taiwan Ltd.

No. 134, WuKungRoad, NewTaipeiIndustrialPark, WukuDistrict, NewTaipeiCity, Taiwan24803/新北市五股區新北產業園區五工路 134 號

台灣檢驗科技股份有限公司

t (886-2) 2299-3279

f (886-2) 2298-0488

www.tw.sgs.com

Member of SGS Group

802.11n_HT20M Main						
CH	Freq. (MHz)	Data Rate	Peak Output Power (dBm)	Peak Output Power (mW)	Limit	RESULT
1	2412	MCS0	21.51	141.58	1 Watt = 30.00 dBm	PASS
6	2437	MCS0	21.25	133.35	1 Watt = 30.00 dBm	PASS
11	2462	MCS0	21.43	139.00	1 Watt = 30.00 dBm	PASS
802.11n_HT20M Main						
CH	Freq. (MHz)	Data Rate	Max. Avg. Output include tune up tolerance Power (dBm)	Avg. Output Power (mW)	Limit	RESULT
1	2412	MCS0	14.95	31.24	1 Watt = 30.00 dBm	PASS
6	2437	MCS0	14.77	29.98	1 Watt = 30.00 dBm	PASS
11	2462	MCS0	14.89	30.82	1 Watt = 30.00 dBm	PASS
802.11n_HT20M Aux1						
CH	Freq. (MHz)	Data Rate	Peak Output Power (dBm)	Peak Output Power (mW)	Limit	RESULT
1	2412	MCS0	21.27	133.97	1 Watt = 30.00 dBm	PASS
6	2437	MCS0	21.15	130.32	1 Watt = 30.00 dBm	PASS
11	2462	MCS0	21.21	132.13	1 Watt = 30.00 dBm	PASS
802.11n_HT20M Aux1						
CH	Freq. (MHz)	Data Rate	Max. Avg. Output include tune up tolerance Power (dBm)	Max. Avg. Output include tune up tolerance Power (mW)	Limit	RESULT
1	2412	MCS0	14.90	30.89	1 Watt = 30.00 dBm	PASS
6	2437	MCS0	14.72	29.63	1 Watt = 30.00 dBm	PASS
11	2462	MCS0	14.86	30.60	1 Watt = 30.00 dBm	PASS

Unless otherwise stated the results shown in this test report refer only to the sample(s) tested and such sample(s) are retained for 90 days only.

除非另有說明，此報告結果僅對測試之樣品負責，同時此樣品僅保留90天。本報告未經本公司書面許可，不可部份複製。

This document is issued by the Company subject to its General Conditions of Service printed overleaf, available on request or accessible at www.sgs.com/terms_and_conditions.htm and, for electronic format documents, subject to Terms and Conditions for Electronic Documents at www.sgs.com/terms_e-document.htm. Attention is drawn to the limitation of liability, indemnification and jurisdiction issues defined therein. Any holder of this document is advised that information contained hereon reflects the Company's findings at the time of its intervention only and within the limits of Client's instructions, if any. The Company's sole responsibility is to its Client and this document does not exonerate parties to a transaction from exercising all their rights and obligations under the transaction documents. This document cannot be reproduced except in full, without prior written approval of the Company. Any unauthorized alteration, forgery or falsification of the content or appearance of this document is unlawful and offenders may be prosecuted to the fullest extent of the law.

SGS Taiwan Ltd.

No.134,WuKungRoad,NewTaipeiIndustrialPark,WukuDistrict,NewTaipeiCity,Taiwan24803/新北市五股區新北產業園區五工路 134 號

台灣檢驗科技股份有限公司

t (886-2) 2299-3279

f (886-2) 2298-0488

www.tw.sgs.com

Member of SGS Group

802.11n_HT20M MIMO						
CH	Freq. (MHz)	Data Rate	Total Peak Output Power (dBm)	Total Peak Output Power (mW)	Limit	RESULT
1	2412	MCS8	21.56	143.09	1 Watt = 30.00 dBm	PASS
6	2437	MCS8	21.30	134.95	1 Watt = 30.00 dBm	PASS
11	2462	MCS8	21.47	140.34	1 Watt = 30.00 dBm	PASS
802.11n_HT20M MIMO						
CH	Freq. (MHz)	Data Rate	Max. Avg. Output include tune up tolerance Power (dBm)	Max. Avg. Output include tune up tolerance Power (mW)	Limit	RESULT
1	2412	MCS8	14.97	29.77	1 Watt = 30.00 dBm	PASS
6	2437	MCS8	14.81	28.73	1 Watt = 30.00 dBm	PASS
11	2462	MCS8	14.91	29.36	1 Watt = 30.00 dBm	PASS

Unless otherwise stated the results shown in this test report refer only to the sample(s) tested and such sample(s) are retained for 90 days only.

除非另有說明，此報告結果僅對測試之樣品負責，同時此樣品僅保留90天。本報告未經本公司書面許可，不可部份複製。

This document is issued by the Company subject to its General Conditions of Service printed overleaf, available on request or accessible at www.sgs.com/terms_and_conditions.htm and, for electronic format documents, subject to Terms and Conditions for Electronic Documents at www.sgs.com/terms_e-document.htm. Attention is drawn to the limitation of liability, indemnification and jurisdiction issues defined therein. Any holder of this document is advised that information contained hereon reflects the Company's findings at the time of its intervention only and within the limits of Client's instructions, if any. The Company's sole responsibility is to its Client and this document does not exonerate parties to a transaction from exercising all their rights and obligations under the transaction documents. This document cannot be reproduced except in full, without prior written approval of the Company. Any unauthorized alteration, forgery or falsification of the content or appearance of this document is unlawful and offenders may be prosecuted to the fullest extent of the law.

SGS Taiwan Ltd.

No.134,WuKungRoad,NewTaipeiIndustrialPark,WukuDistrict,NewTaipeiCity,Taiwan24803/新北市五股區新北產業園區五工路 134 號

台灣檢驗科技股份有限公司

t (886-2) 2299-3279

f (886-2) 2298-0488

www.tw.sgs.com

Member of SGS Group

802.11b Main

Freq. (MHz)	6dB BW (kHz)	Limit (kHz)	Result
2412	8090	> 500	PASS
2437	8090	> 500	PASS
2462	8090	> 500	PASS

802.11b Aux1

Freq. (MHz)	6dB BW (kHz)	Limit (kHz)	Result
2412	8080	> 500	PASS
2437	8090	> 500	PASS
2462	8090	> 500	PASS

802.11g Main

Freq. (MHz)	6dB BW (kHz)	Limit (kHz)	Result
2412	15960	> 500	PASS
2437	16330	> 500	PASS
2462	16320	> 500	PASS

802.11g Aux1

Freq. (MHz)	6dB BW (kHz)	Limit (kHz)	Result
2412	15960	> 500	PASS
2437	16340	> 500	PASS
2462	16320	> 500	PASS

802.11_n_HT20 Main

Freq. (MHz)	6dB BW (kHz)	Limit (kHz)	Result
2412	16240	> 500	PASS
2437	16970	> 500	PASS
2462	17180	> 500	PASS

802.11_n_HT20 Aux1

Freq. (MHz)	6dB BW (kHz)	Limit (kHz)	Result
2412	16300	> 500	PASS
2437	17180	> 500	PASS
2462	17280	> 500	PASS

*Refer to next page for plots

Unless otherwise stated the results shown in this test report refer only to the sample(s) tested and such sample(s) are retained for 90 days only.

除非另有說明，此報告結果僅對測試之樣品負責，同時此樣品僅保留90天。本報告未經本公司書面許可，不可部份複製。

This document is issued by the Company subject to its General Conditions of Service printed overleaf, available on request or accessible at www.sgs.com/terms_and_conditions.htm and, for electronic format documents, subject to Terms and Conditions for Electronic Documents at www.sgs.com/terms_e-document.htm. Attention is drawn to the limitation of liability, indemnification and jurisdiction issues defined therein. Any holder of this document is advised that information contained hereon reflects the Company's findings at the time of its intervention only and within the limits of Client's instructions, if any. The Company's sole responsibility is to its Client and this document does not exonerate parties to a transaction from exercising all their rights and obligations under the transaction documents. This document cannot be reproduced except in full, without prior written approval of the Company. Any unauthorized alteration, forgery or falsification of the content or appearance of this document is unlawful and offenders may be prosecuted to the fullest extent of the law.

SGS Taiwan Ltd.

No.134,WuKungRoad,NewTaipeiIndustrialPark,WukuDistrict,NewTaipeiCity,Taiwan24803/新北市五股區新北產業園區五工路 134 號

台灣檢驗科技股份有限公司

t (886-2) 2299-3279

f (886-2) 2298-0488

www.tw.sgs.com

Member of SGS Group

802.11b (Main)
6dB Band Width Test Data CH-Low

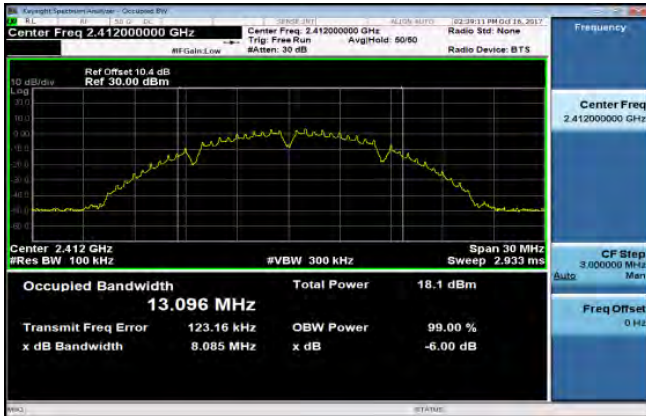

802.11b (Aux)
6dB Band Width Test Data CH-Low

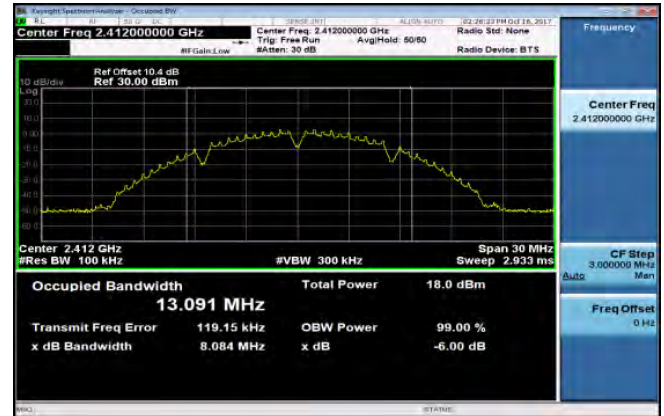

6dB Band Width Test Data CH-Mid

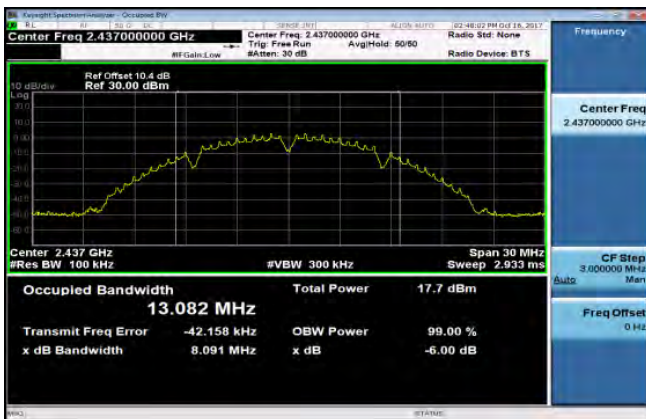

6dB Band Width Test Data CH-Mid

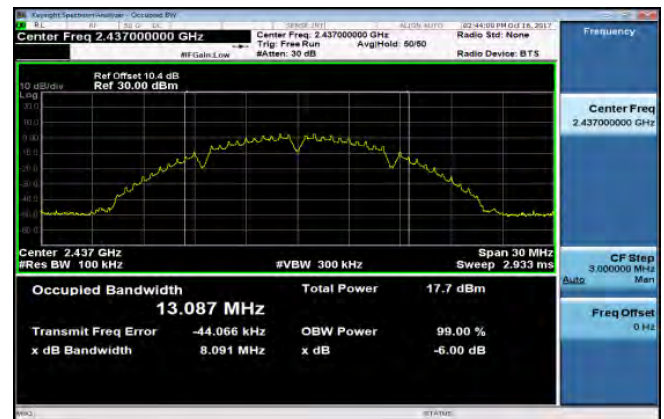

6dB Band Width Test Data CH-High

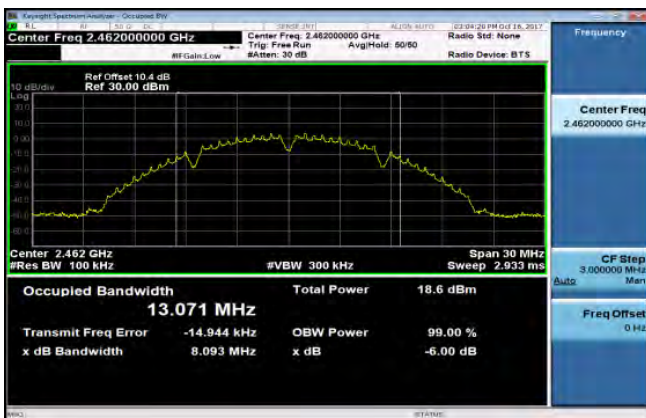

6dB Band Width Test Data CH-High

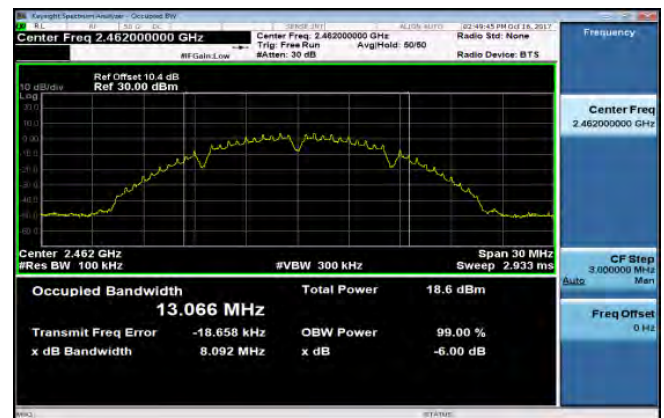

Unless otherwise stated the results shown in this test report refer only to the sample(s) tested and such sample(s) are retained for 90 days only.

除非另有說明，此報告結果僅對測試之樣品負責，同時此樣品僅保留90天。本報告未經本公司書面許可，不可部份複製。

This document is issued by the Company subject to its General Conditions of Service printed overleaf, available on request or accessible at www.sgs.com/terms_and_conditions.htm and, for electronic format documents, subject to Terms and Conditions for Electronic Documents at www.sgs.com/terms_e-document.htm. Attention is drawn to the limitation of liability, indemnification and jurisdiction issues defined therein. Any holder of this document is advised that information contained hereon reflects the Company's findings at the time of its intervention only and within the limits of Client's instructions, if any. The Company's sole responsibility is to its Client and this document does not exonerate parties to a transaction from exercising all their rights and obligations under the transaction documents. This document cannot be reproduced except in full, without prior written approval of the Company. Any unauthorized alteration, forgery or falsification of the content or appearance of this document is unlawful and offenders may be prosecuted to the fullest extent of the law.

802.11g (Main)
6dB Band Width Test Data CH-Low

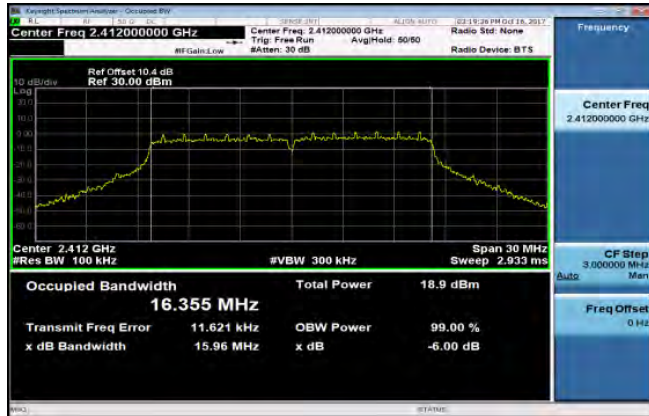

802.11g (Aux)
6dB Band Width Test Data CH-Low

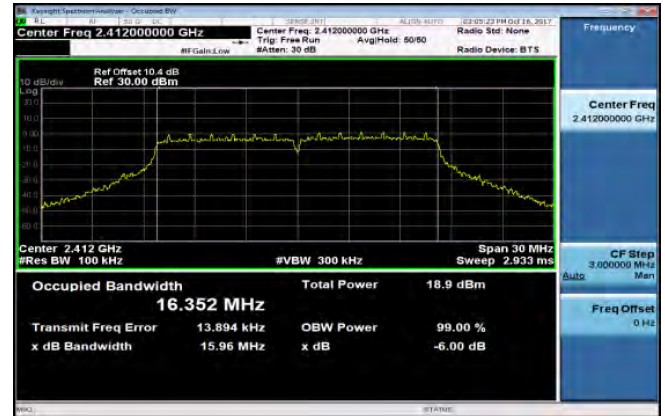

6dB Band Width Test Data CH-Mid

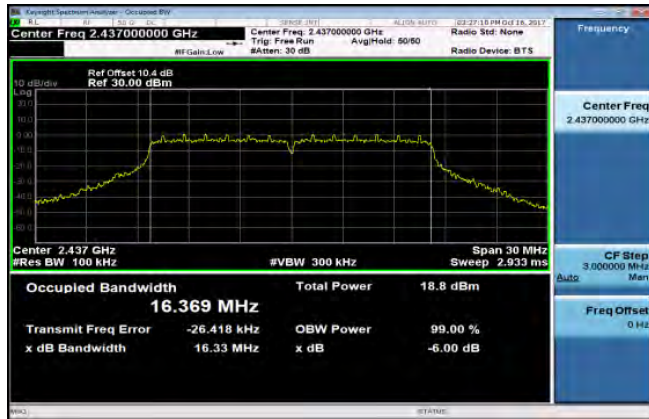

6dB Band Width Test Data CH-Mid

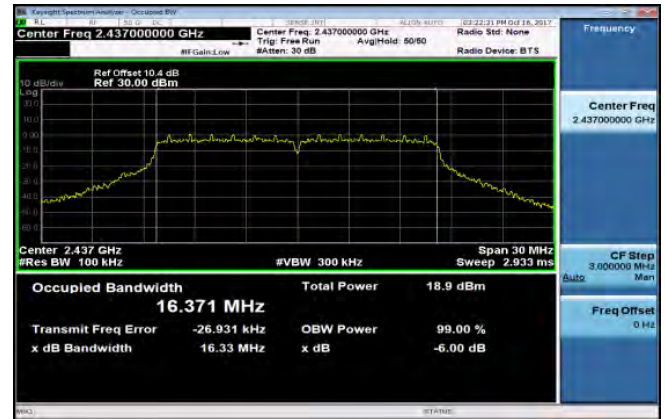

6dB Band Width Test Data CH-High

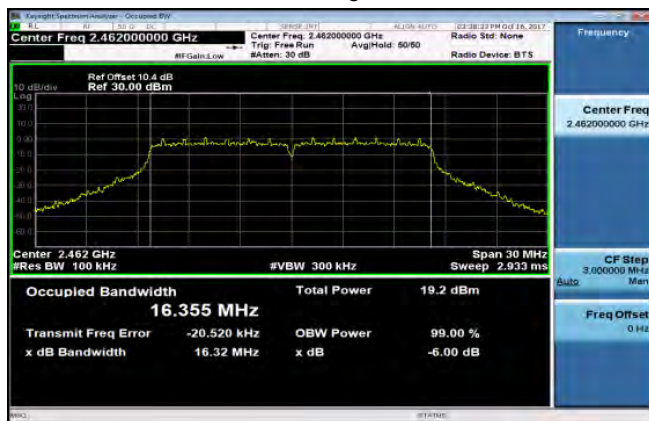

6dB Band Width Test Data CH-High

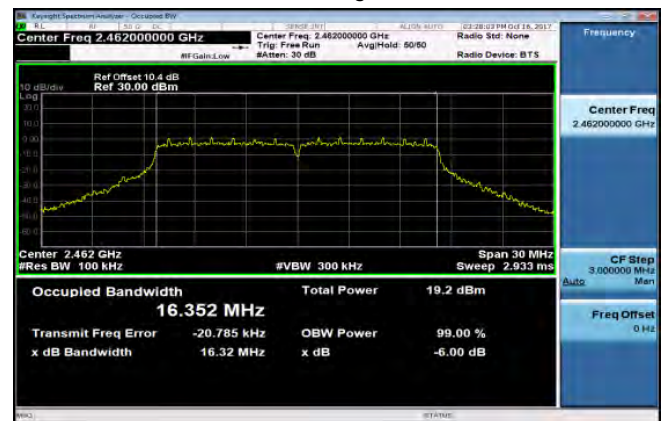

Unless otherwise stated the results shown in this test report refer only to the sample(s) tested and such sample(s) are retained for 90 days only.

除非另有說明，此報告結果僅對測試之樣品負責，同時此樣品僅保留90天。本報告未經本公司書面許可，不可部份複製。

This document is issued by the Company subject to its General Conditions of Service printed overleaf, available on request or accessible at www.sgs.com/terms_and_conditions.htm and, for electronic format documents, subject to Terms and Conditions for Electronic Documents at www.sgs.com/terms_e-document.htm. Attention is drawn to the limitation of liability, indemnification and jurisdiction issues defined therein. Any holder of this document is advised that information contained hereon reflects the Company's findings at the time of its intervention only and within the limits of Client's instructions, if any. The Company's sole responsibility is to its Client and this document does not exonerate parties to a transaction from exercising all their rights and obligations under the transaction documents. This document cannot be reproduced except in full, without prior written approval of the Company. Any unauthorized alteration, forgery or falsification of the content or appearance of this document is unlawful and offenders may be prosecuted to the fullest extent of the law.

802.11n_20M (Main)
6dB Band Width Test Data CH-Low

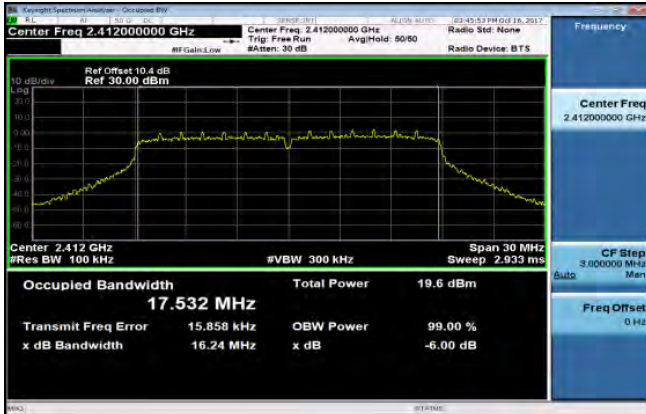

802.11n_20M (AUX)
6dB Band Width Test Data CH-Low

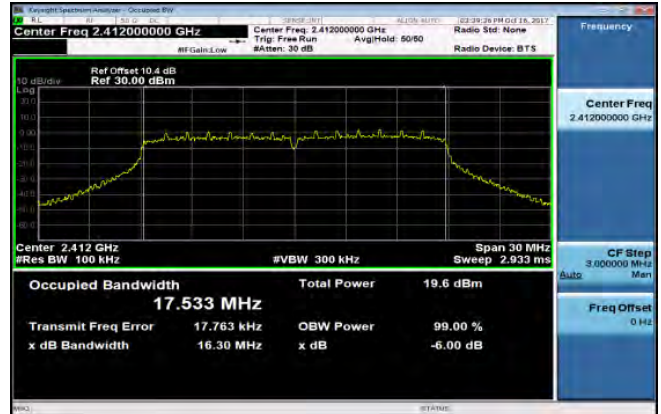

6dB Band Width Test Data CH-Mid

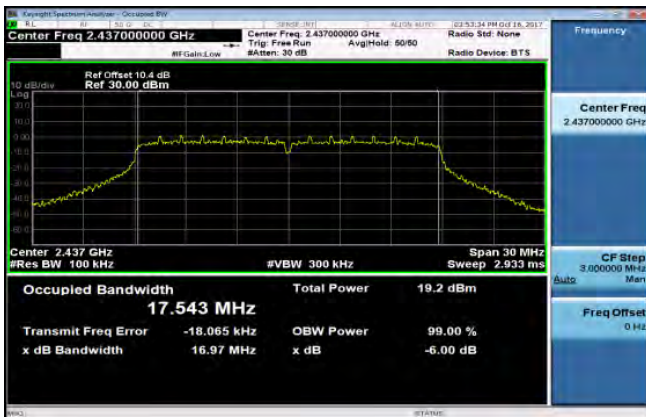

6dB Band Width Test Data CH-Mid

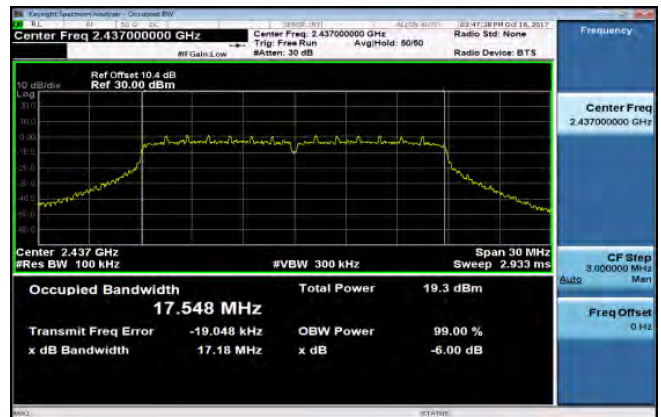

6dB Band Width Test Data CH-High



6dB Band Width Test Data CH-High



Unless otherwise stated the results shown in this test report refer only to the sample(s) tested and such sample(s) are retained for 90 days only.

除非另有說明，此報告結果僅對測試之樣品負責，同時此樣品僅保留90天。本報告未經本公司書面許可，不可部份複製。

This document is issued by the Company subject to its General Conditions of Service printed overleaf, available on request or accessible at www.sgs.com/terms_and_conditions.htm and, for electronic format documents, subject to Terms and Conditions for Electronic Documents at www.sgs.com/terms_e-document.htm. Attention is drawn to the limitation of liability, indemnification and jurisdiction issues defined therein. Any holder of this document is advised that information contained hereon reflects the Company's findings at the time of its intervention only and within the limits of Client's instructions, if any. The Company's sole responsibility is to its Client and this document does not exonerate parties to a transaction from exercising all their rights and obligations under the transaction documents. This document cannot be reproduced except in full, without prior written approval of the Company. Any unauthorized alteration, forgery or falsification of the content or appearance of this document is unlawful and offenders may be prosecuted to the fullest extent of the law.

9 CONDUCTED BAND EDGES AND SPURIOUS EMISSION MEASUREMENT

9.1 Standard Applicable

In any 100 kHz bandwidth outside the frequency band in which the spread spectrum or digitally modulated intentional radiator is operating, the radio frequency power that is produced by the intentional radiator shall be at least 20 dB below that in the 100 kHz bandwidth within the band that contains the highest level of the desired power, based on either an RF conducted or a radiated measurement, provided the transmitter demonstrates compliance with the peak conducted power limits.

In addition, radiated emissions which fall in the restricted bands, as defined in §15.205(a), must also comply with the radiated emission limits specified in §15.209(a).

9.2 Measurement Equipment Used

Conducted Emission Test Site					
EQUIPMENT TYPE	MFR	MODEL NUMBER	SERIAL NUMBER	LAST CAL.	CAL DUE.
Spectrum Analyzer	KEYSIGHT	N9010A	MY51440113	06/20/2017	06/19/2018
DC Block	PASTERNAK	PE8210	RF29	12/12/2016	12/11/2017
Attenuator	WOKEN	218FS-10	RF23	12/12/2016	12/11/2017

9.3 Test SET-UP

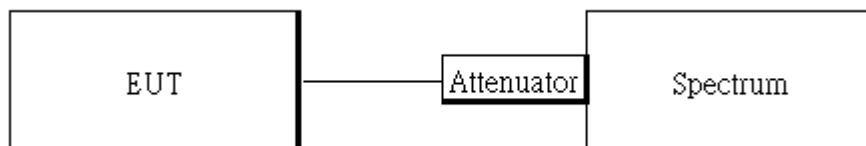

Unless otherwise stated the results shown in this test report refer only to the sample(s) tested and such sample(s) are retained for 90 days only.

除非另有說明，此報告結果僅對測試之樣品負責，同時此樣品僅保留90天。本報告未經本公司書面許可，不可部份複製。

This document is issued by the Company subject to its General Conditions of Service printed overleaf, available on request or accessible at www.sgs.com/terms_and_conditions.htm and, for electronic format documents, subject to Terms and Conditions for Electronic Documents at www.sgs.com/terms_e-document.htm. Attention is drawn to the limitation of liability, indemnification and jurisdiction issues defined therein. Any holder of this document is advised that information contained hereon reflects the Company's findings at the time of its intervention only and within the limits of Client's instructions, if any. The Company's sole responsibility is to its Client and this document does not exonerate parties to a transaction from exercising all their rights and obligations under the transaction documents. This document cannot be reproduced except in full, without prior written approval of the Company. Any unauthorized alteration, forgery or falsification of the content or appearance of this document is unlawful and offenders may be prosecuted to the fullest extent of the law.

SGS Taiwan Ltd.

No.134,WuKungRoad,NewTaipeiIndustrialPark,WukuDistrict,NewTaipeiCity,Taiwan24803/新北市五股區新北產業園區五工路 134 號

台灣檢驗科技股份有限公司

t (886-2) 2299-3279

f (886-2) 2298-0488

www.tw.sgs.com

Member of SGS Group

9.4 Measurement Procedure

Conducted Band Edge:

1. To connect Antenna Port of EUT to Spectrum.
2. The testing follows the Measurement Procedure of FCC KDB 558074 D01 DTS Meas. Guidance .
3. Remove the antenna from the EUT and then connect a low loss RF cable from the antenna port to the spectrum analyzer.
4. Set start to edge frequency, and stop frequency of spectrum analyzer so as to encompass the spectrum to be examined.
5. Set the spectrum analyzer as RBW=100 kHz, VBW=300 kHz, Detector = Peak, Sweep = auto
6. Mark the highest reading of the emission as the reference level measurement.
7. Set DL as the limit = reading on marker 1 – 20dBm
8. Marker on frequency, 2.3999GHz and 2.4836GHz, and examine shall 100 kHz immediately outside the authorized (2400~2483.5) be attenuated by 20dB at least relative to the maximum emission of power.
9. Repeat above procedures until all default test channel (low, middle, and high) was complete.

Conducted Spurious Emission:

1. To connect Antenna Port of EUT to Spectrum
2. The testing follows the Measurement Procedure of FCC KDB 558074 D01 DTS Meas. Guidance .
3. Set RBW = 100 kHz & VBW= 300 kHz, Detector =Peak, Sweep = Auto.
4. Allow trace to fully stabilize.
5. Use the peak marker function to determine the maximum power level in any 100 kHz band segment within the fundamental EBW.
6. Repeat above procedures until all default test channel measured were complete.

Unless otherwise stated the results shown in this test report refer only to the sample(s) tested and such sample(s) are retained for 90 days only.

除非另有說明，此報告結果僅對測試之樣品負責，同時此樣品僅保留90天。本報告未經本公司書面許可，不可部份複製。

This document is issued by the Company subject to its General Conditions of Service printed overleaf, available on request or accessible at www.sgs.com/terms_and_conditions.htm and, for electronic format documents, subject to Terms and Conditions for Electronic Documents at www.sgs.com/terms_e-document.htm. Attention is drawn to the limitation of liability, indemnification and jurisdiction issues defined therein. Any holder of this document is advised that information contained hereon reflects the Company's findings at the time of its intervention only and within the limits of Client's instructions, if any. The Company's sole responsibility is to its Client and this document does not exonerate parties to a transaction from exercising all their rights and obligations under the transaction documents. This document cannot be reproduced except in full, without prior written approval of the Company. Any unauthorized alteration, forgery or falsification of the content or appearance of this document is unlawful and offenders may be prosecuted to the fullest extent of the law.

SGS Taiwan Ltd.

台灣檢驗科技股份有限公司

No.134,WuKungRoad,NewTaipeiIndustrialPark,WukuDistrict,NewTaipeiCity,Taiwan24803/新北市五股區新北產業園區五工路 134 號

t (886-2) 2299-3279

f (886-2) 2298-0488

www.tw.sgs.com

Member of SGS Group

9.5 Measurement Result

Bandedge Limit 802.11b MODE			Bandedge Limit 802.11g MODE		
Freq. (MHz)	PSD (dBm)	Bandedge Limit (dBm)	Freq. (MHz)	PSD (dBm)	Bandedge Limit (dBm)
2412	5.96	-14.04	2412	4.34	-15.66
2462	6.47	-13.53	2462	4.17	-15.83

Bandedge Limit 802.11n20 MODE		
Freq. (MHz)	PSD (dBm)	Bandedge Limit (dBm)
2412	4.82	-15.18
2462	4.62	-15.38

Note:

offset 10.40 dB for SISO mode
offset 13.40 dB for MIMO mode

802.11b PSD for Band edge Limit (CH-Low)



802.11g PSD for Bandedge Limit(CH-Low)



802.11b PSD for Bandedge Limit(CH-High)



802.11g PSD for Bandedge Limit(CH-High)



Unless otherwise stated the results shown in this test report refer only to the sample(s) tested and such sample(s) are retained for 90 days only.

除非另有說明，此報告結果僅對測試之樣品負責，同時此樣品僅保留90天。本報告未經本公司書面許可，不可部份複製。

This document is issued by the Company subject to its General Conditions of Service printed overleaf, available on request or accessible at www.sgs.com/terms_and_conditions.htm and, for electronic format documents, subject to Terms and Conditions for Electronic Documents at www.sgs.com/terms_e-document.htm. Attention is drawn to the limitation of liability, indemnification and jurisdiction issues defined therein. Any holder of this document is advised that information contained hereon reflects the Company's findings at the time of its intervention only and within the limits of Client's instructions, if any. The Company's sole responsibility is to its Client and this document does not exonerate parties to a transaction from exercising all their rights and obligations under the transaction documents. This document cannot be reproduced except in full, without prior written approval of the Company. Any unauthorized alteration, forgery or falsification of the content or appearance of this document is unlawful and offenders may be prosecuted to the fullest extent of the law.

802.11n_HT20 PSD for Bandedge Limit(CH-Low)



802.11n_HT20 PSD for Bandedge Limit(CH-High)



Unless otherwise stated the results shown in this test report refer only to the sample(s) tested and such sample(s) are retained for 90 days only.

除非另有說明，此報告結果僅對測試之樣品負責，同時此樣品僅保留90天。本報告未經本公司書面許可，不可部份複製。

This document is issued by the Company subject to its General Conditions of Service printed overleaf, available on request or accessible at www.sgs.com/terms_and_conditions.htm and, for electronic format documents, subject to Terms and Conditions for Electronic Documents at www.sgs.com/terms_e-document.htm. Attention is drawn to the limitation of liability, indemnification and jurisdiction issues defined therein. Any holder of this document is advised that information contained hereon reflects the Company's findings at the time of its intervention only and within the limits of Client's instructions, if any. The Company's sole responsibility is to its Client and this document does not exonerate parties to a transaction from exercising all their rights and obligations under the transaction documents. This document cannot be reproduced except in full, without prior written approval of the Company. Any unauthorized alteration, forgery or falsification of the content or appearance of this document is unlawful and offenders may be prosecuted to the fullest extent of the law.

SGS Taiwan Ltd.

No. 134, WuKungRoad, NewTaipeiIndustrialPark, WukuDistrict, NewTaipeiCity, Taiwan24803/新北市五股區新北產業園區五工路 134 號

台灣檢驗科技股份有限公司

t (886-2) 2299-3279

f (886-2) 2298-0488

www.tw.sgs.com

Member of SGS Group

802.11b

Band Edges Test Data CH-Low

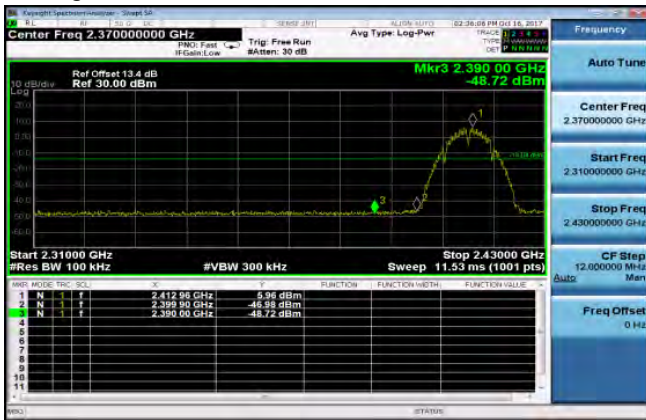

802.11b

Spurious Emission Test Data CH-Low

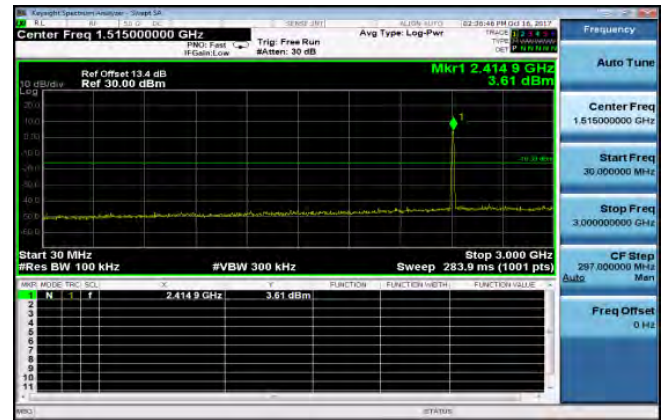

Band Edges Test Data CH-High

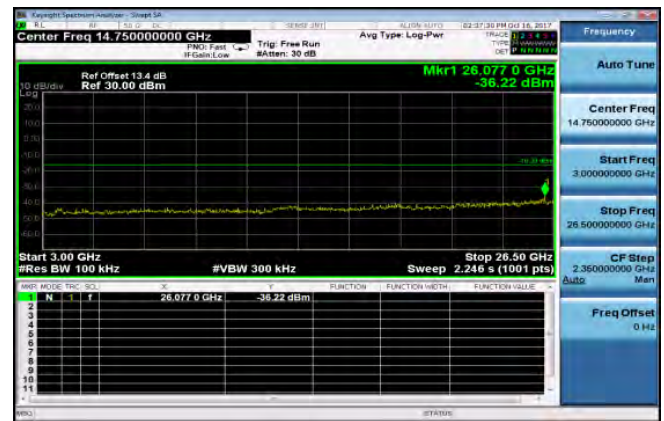

Unless otherwise stated the results shown in this test report refer only to the sample(s) tested and such sample(s) are retained for 90 days only.

除非另有說明，此報告結果僅對測試之樣品負責，同時此樣品僅保留90天。本報告未經本公司書面許可，不可部份複製。

This document is issued by the Company subject to its General Conditions of Service printed overleaf, available on request or accessible at www.sgs.com/terms_and_conditions.htm and, for electronic format documents, subject to Terms and Conditions for Electronic Documents at www.sgs.com/terms_e-document.htm. Attention is drawn to the limitation of liability, indemnification and jurisdiction issues defined therein. Any holder of this document is advised that information contained hereon reflects the Company's findings at the time of its intervention only and within the limits of Client's instructions, if any. The Company's sole responsibility is to its Client and this document does not exonerate parties to a transaction from exercising all their rights and obligations under the transaction documents. This document cannot be reproduced except in full, without prior written approval of the Company. Any unauthorized alteration, forgery or falsification of the content or appearance of this document is unlawful and offenders may be prosecuted to the fullest extent of the law.

SGS Taiwan Ltd.

台灣檢驗科技股份有限公司

No. 134, WuKungRoad, NewTaipeiIndustrialPark, WukuDistrict, NewTaipeiCity, Taiwan24803/新北市五股區新北產業園區五工路 134 號

t (886-2) 2299-3279

f (886-2) 2298-0488

www.tw.sgs.com

Member of SGS Group

Spurious Emission Test Data CH-Mid

Spurious Emission Test Data CH-High

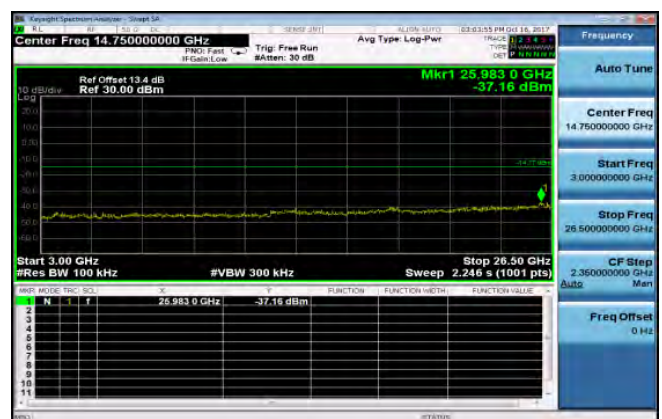
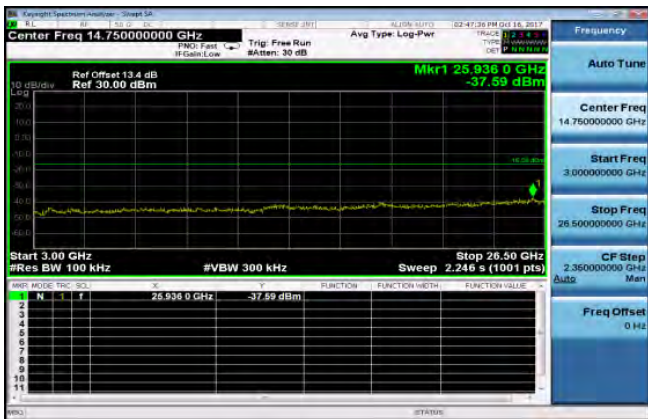
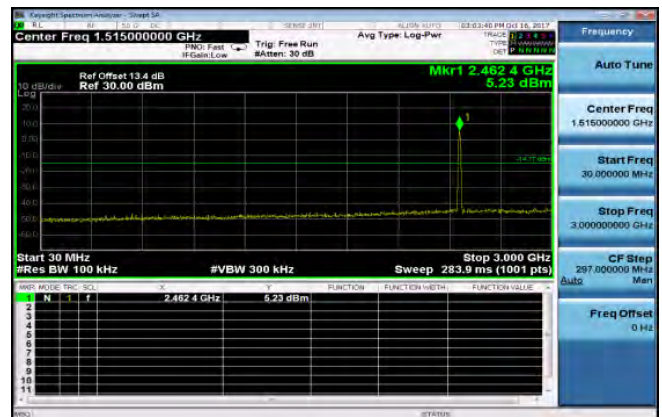
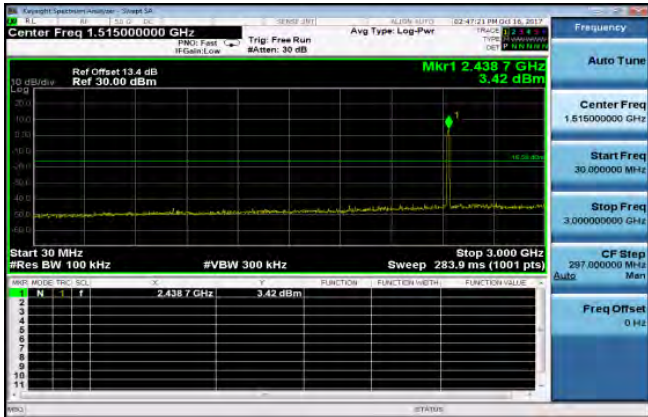

Unless otherwise stated the results shown in this test report refer only to the sample(s) tested and such sample(s) are retained for 90 days only.

除非另有說明，此報告結果僅對測試之樣品負責，同時此樣品僅保留90天。本報告未經本公司書面許可，不可部份複製。

This document is issued by the Company subject to its General Conditions of Service printed overleaf, available on request or accessible at www.sgs.com/terms_and_conditions.htm and, for electronic format documents, subject to Terms and Conditions for Electronic Documents at www.sgs.com/terms_e-document.htm. Attention is drawn to the limitation of liability, indemnification and jurisdiction issues defined therein. Any holder of this document is advised that information contained hereon reflects the Company's findings at the time of its intervention only and within the limits of Client's instructions, if any. The Company's sole responsibility is to its Client and this document does not exonerate parties to a transaction from exercising all their rights and obligations under the transaction documents. This document cannot be reproduced except in full, without prior written approval of the Company. Any unauthorized alteration, forgery or falsification of the content or appearance of this document is unlawful and offenders may be prosecuted to the fullest extent of the law.

SGS Taiwan Ltd.

台灣檢驗科技股份有限公司

No. 134, WuKungRoad, NewTaipeiIndustrialPark, WukuDistrict, NewTaipeiCity, Taiwan24803/新北市五股區新北產業園區五工路 134 號

t (886-2) 2299-3279

f (886-2) 2298-0488

www.tw.sgs.com

Member of SGS Group

802.11g
Band Edges Test Data CH-Low

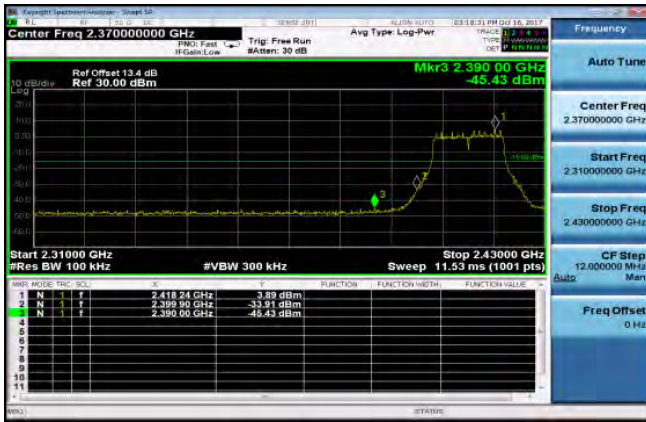

802.11g
Spurious Emission Test Data CH-Low

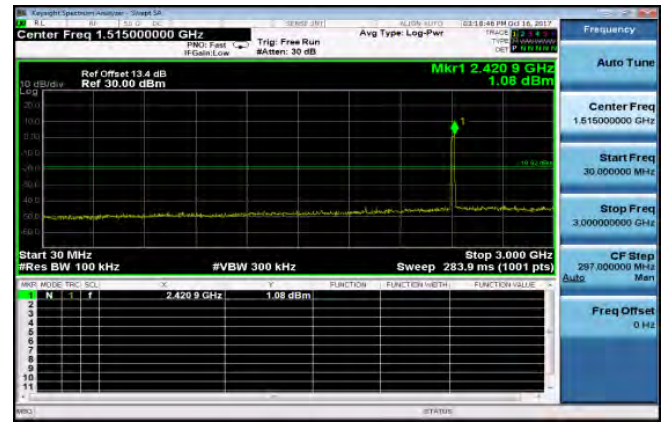

Band Edges Test Data CH-High

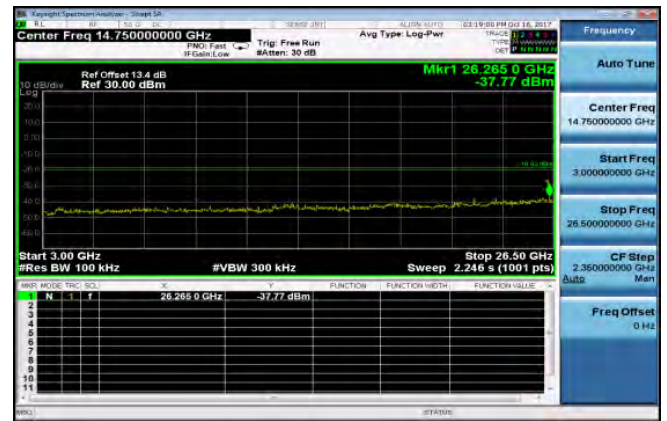

Unless otherwise stated the results shown in this test report refer only to the sample(s) tested and such sample(s) are retained for 90 days only.

除非另有說明，此報告結果僅對測試之樣品負責，同時此樣品僅保留90天。本報告未經本公司書面許可，不可部份複製。

This document is issued by the Company subject to its General Conditions of Service printed overleaf, available on request or accessible at www.sgs.com/terms_and_conditions.htm and, for electronic format documents, subject to Terms and Conditions for Electronic Documents at www.sgs.com/terms_e-document.htm. Attention is drawn to the limitation of liability, indemnification and jurisdiction issues defined therein. Any holder of this document is advised that information contained hereon reflects the Company's findings at the time of its intervention only and within the limits of Client's instructions, if any. The Company's sole responsibility is to its Client and this document does not exonerate parties to a transaction from exercising all their rights and obligations under the transaction documents. This document cannot be reproduced except in full, without prior written approval of the Company. Any unauthorized alteration, forgery or falsification of the content or appearance of this document is unlawful and offenders may be prosecuted to the fullest extent of the law.

Spurious Emission Test Data CH-Mid

Spurious Emission Test Data CH-High

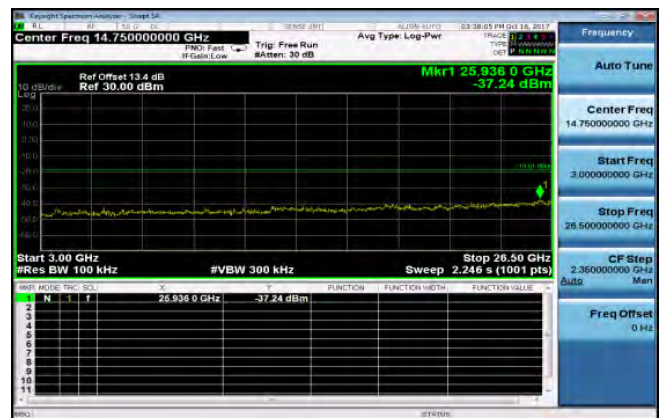
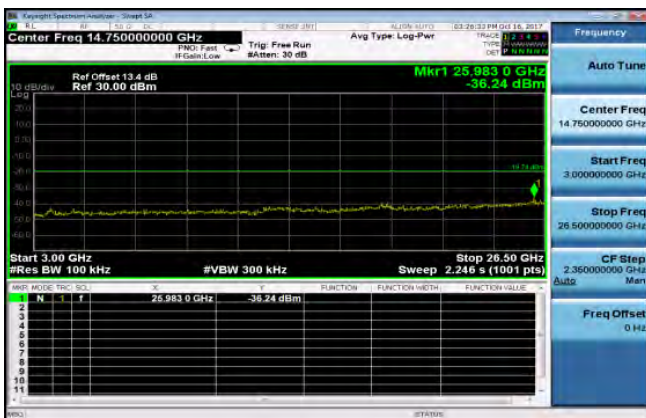
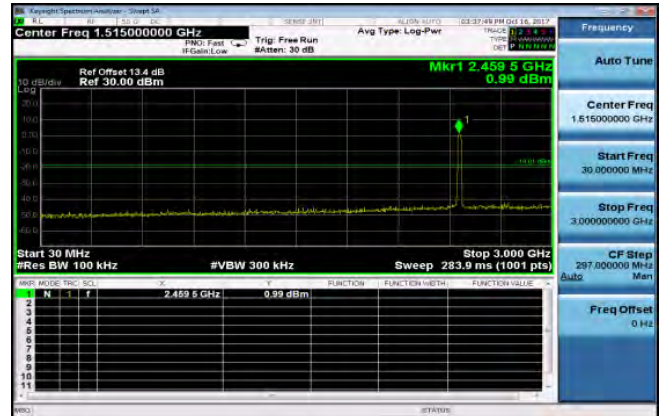
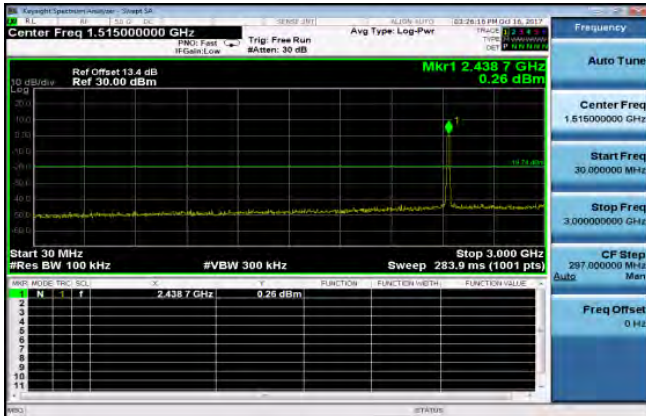

Unless otherwise stated the results shown in this test report refer only to the sample(s) tested and such sample(s) are retained for 90 days only.

除非另有說明，此報告結果僅對測試之樣品負責，同時此樣品僅保留90天。本報告未經本公司書面許可，不可部份複製。

This document is issued by the Company subject to its General Conditions of Service printed overleaf, available on request or accessible at www.sgs.com/terms_and_conditions.htm and, for electronic format documents, subject to Terms and Conditions for Electronic Documents at www.sgs.com/terms_e-document.htm. Attention is drawn to the limitation of liability, indemnification and jurisdiction issues defined therein. Any holder of this document is advised that information contained hereon reflects the Company's findings at the time of its intervention only and within the limits of Client's instructions, if any. The Company's sole responsibility is to its Client and this document does not exonerate parties to a transaction from exercising all their rights and obligations under the transaction documents. This document cannot be reproduced except in full, without prior written approval of the Company. Any unauthorized alteration, forgery or falsification of the content or appearance of this document is unlawful and offenders may be prosecuted to the fullest extent of the law.

SGS Taiwan Ltd.

No. 134, WuKungRoad, NewTaipeiIndustrialPark, WukuDistrict, NewTaipeiCity, Taiwan24803/新北市五股區新北產業園區五工路 134 號

台灣檢驗科技股份有限公司

t (886-2) 2299-3279

f (886-2) 2298-0488

www.tw.sgs.com

Member of SGS Group

802.11n_HT20
Band Edges Test Data CH-Low



802.11n_HT20
Spurious Emission Test Data CH-Low

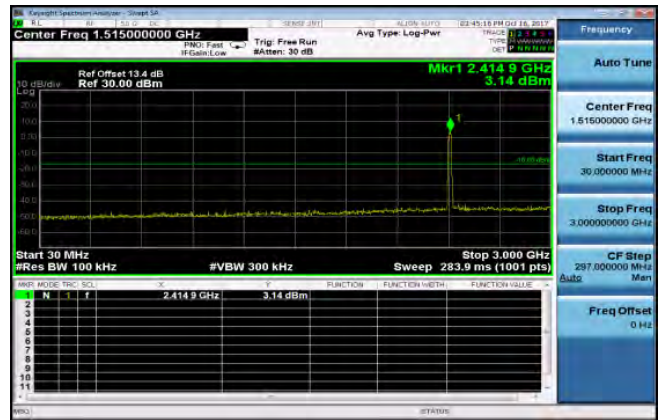

Band Edges Test Data CH-High

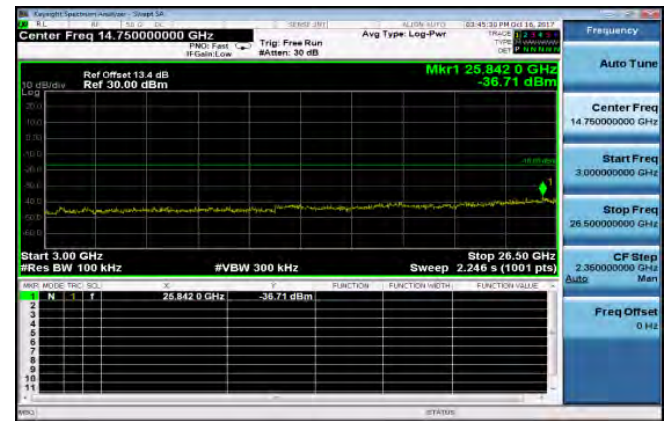
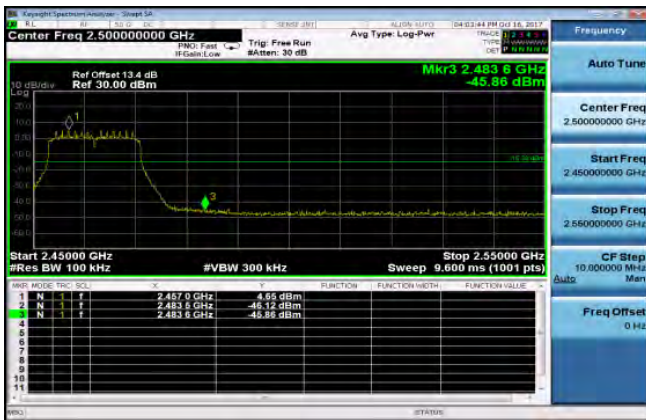

Unless otherwise stated the results shown in this test report refer only to the sample(s) tested and such sample(s) are retained for 90 days only.

除非另有說明，此報告結果僅對測試之樣品負責，同時此樣品僅保留90天。本報告未經本公司書面許可，不可部份複製。

This document is issued by the Company subject to its General Conditions of Service printed overleaf, available on request or accessible at www.sgs.com/terms_and_conditions.htm and, for electronic format documents, subject to Terms and Conditions for Electronic Documents at www.sgs.com/terms_e-document.htm. Attention is drawn to the limitation of liability, indemnification and jurisdiction issues defined therein. Any holder of this document is advised that information contained hereon reflects the Company's findings at the time of its intervention only and within the limits of Client's instructions, if any. The Company's sole responsibility is to its Client and this document does not exonerate parties to a transaction from exercising all their rights and obligations under the transaction documents. This document cannot be reproduced except in full, without prior written approval of the Company. Any unauthorized alteration, forgery or falsification of the content or appearance of this document is unlawful and offenders may be prosecuted to the fullest extent of the law.

SGS Taiwan Ltd.

No. 134, WuKungRoad, NewTaipeiIndustrialPark, WukuDistrict, NewTaipeiCity, Taiwan24803/新北市五股區新北產業園區五工路 134 號

台灣檢驗科技股份有限公司

t (886-2) 2299-3279

f (886-2) 2298-0488

www.tw.sgs.com

Member of SGS Group

Spurious Emission Test Data CH-Mid

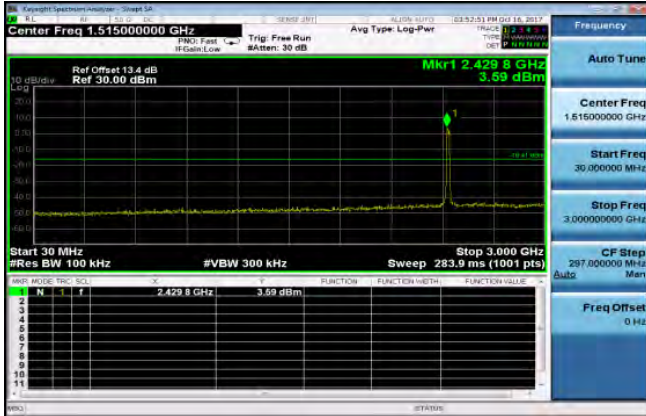

Spurious Emission Test Data CH-High

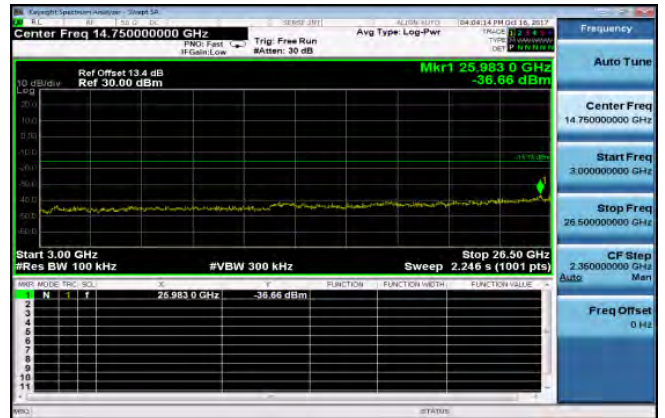
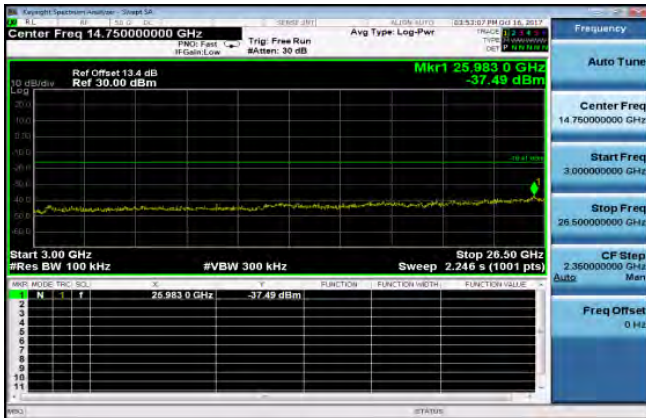
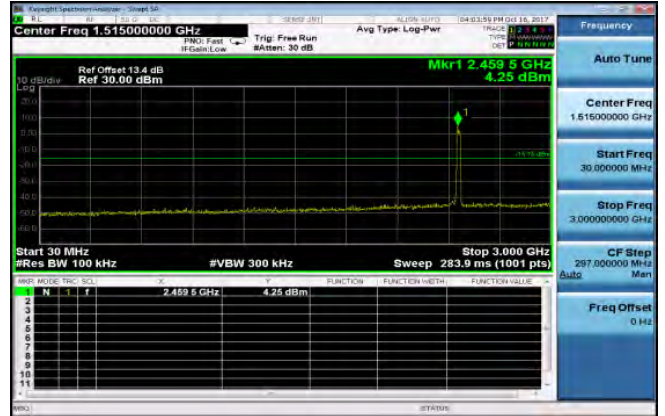

Unless otherwise stated the results shown in this test report refer only to the sample(s) tested and such sample(s) are retained for 90 days only.

除非另有說明，此報告結果僅對測試之樣品負責，同時此樣品僅保留90天。本報告未經本公司書面許可，不可部份複製。

This document is issued by the Company subject to its General Conditions of Service printed overleaf, available on request or accessible at www.sgs.com/terms_and_conditions.htm and, for electronic format documents, subject to Terms and Conditions for Electronic Documents at www.sgs.com/terms_e-document.htm. Attention is drawn to the limitation of liability, indemnification and jurisdiction issues defined therein. Any holder of this document is advised that information contained hereon reflects the Company's findings at the time of its intervention only and within the limits of Client's instructions, if any. The Company's sole responsibility is to its Client and this document does not exonerate parties to a transaction from exercising all their rights and obligations under the transaction documents. This document cannot be reproduced except in full, without prior written approval of the Company. Any unauthorized alteration, forgery or falsification of the content or appearance of this document is unlawful and offenders may be prosecuted to the fullest extent of the law.

SGS Taiwan Ltd.

台灣檢驗科技股份有限公司

No. 134, WuKungRoad, NewTaipeiIndustrialPark, WukuDistrict, NewTaipeiCity, Taiwan24803/新北市五股區新北產業園區五工路 134 號

t (886-2) 2299-3279

f (886-2) 2298-0488

www.tw.sgs.com

Member of SGS Group

10 RADIATED BANDEDGE AND SPURIOUS EMISSION MEASUREMENT

10.1 Standard Applicable

In any 100 kHz bandwidth outside the frequency band in which the spread spectrum or digitally modulated intentional radiator is operating, the radio frequency power that is produced by the intentional radiator shall be at least 20 dB below that in the 100 kHz bandwidth within the band that contains the highest level of the desired power, based on either an RF conducted or a radiated measurement, provided the transmitter demonstrates compliance with the peak conducted power limits. In addition, radiated emissions which fall in the restricted bands must also comply with the §15.209 limit as below.

And according to §15.33(a) (1), for an intentional radiator operates below 10GHz, the frequency range of measurements: to the tenth harmonic of the highest fundamental frequency or to 40GHz, whichever is lower.

Frequency (MHz)	Field strength (microvolts/meter)	Distance (meters)
0.009-0.490	2400/F(kHz)	300
0.490-1.705	24000/F(kHz)	30
1.705-30	30	30
30-88	100	3
88-216	150	3
216-960	200	3
Above 960	500	3

Note:

1. The lower limit shall apply at the transition frequencies.
2. Emission level (dBµV/m) = 20 log Emission level (dBµV/m)

Unless otherwise stated the results shown in this test report refer only to the sample(s) tested and such sample(s) are retained for 90 days only.

除非另有說明，此報告結果僅對測試之樣品負責，同時此樣品僅保留90天。本報告未經本公司書面許可，不可部份複製。

This document is issued by the Company subject to its General Conditions of Service printed overleaf, available on request or accessible at www.sgs.com/terms_and_conditions.htm and, for electronic format documents, subject to Terms and Conditions for Electronic Documents at www.sgs.com/terms_e-document.htm. Attention is drawn to the limitation of liability, indemnification and jurisdiction issues defined therein. Any holder of this document is advised that information contained hereon reflects the Company's findings at the time of its intervention only and within the limits of Client's instructions, if any. The Company's sole responsibility is to its Client and this document does not exonerate parties to a transaction from exercising all their rights and obligations under the transaction documents. This document cannot be reproduced except in full, without prior written approval of the Company. Any unauthorized alteration, forgery or falsification of the content or appearance of this document is unlawful and offenders may be prosecuted to the fullest extent of the law.

SGS Taiwan Ltd.

No.134,WuKungRoad,NewTaipeiIndustrialPark,WukuDistrict,NewTaipeiCity,Taiwan24803/新北市五股區新北產業園區五工路 134 號

台灣檢驗科技股份有限公司

t (886-2) 2299-3279

f (886-2) 2298-0488

www.tw.sgs.com

Member of SGS Group

10.2 Measurement Equipment Used:

966 Chamber					
EQUIPMENT TYPE	MFR	MODEL NUMBER	SERIAL NUMBER	LAST CAL.	CAL DUE.
EMI Test Receiver	R&S	ESU 40	100363	04/18/2017	04/17/2018
Loop Antenna	ETS-Lindgren	6502	00143303	12/23/2016	12/22/2017
Broadband Antenna	TESEQ	CBL 6112D	35240	11/03/2016	11/02/2017
Horn Antenna	ETS-Lindgren	3117	00143272	12/15/2016	12/16/2017
Horn Antenna	Schwarzbeck	BBHA9170	185	07/24/2017	07/23/2018
Pre Amplifier	EMC Instruments	EMC330	980096	12/12/2016	12/11/2017
Pre Amplifier	EMC Instruments	EMC0011830	980199	12/12/2016	12/11/2017
Pre Amplifier	R&S	SCU-18	10204	12/12/2016	12/11/2017
Pre Amplifier	R&S	SCU-26	100780	12/12/2016	12/11/2017
Coaxial Cable	Huber+Suhner	RG 214/U	966Rx 9K-30M	12/12/2016	12/11/2017
Coaxial Cable	Huber+Suhner	RG 214/U SUCOFLEX 104	966Rx 30M-3G	12/12/2016	12/11/2017
Coaxial Cable	Huber+Suhner	SUCOFLEX 104	966Rx 1G-18G	12/12/2016	12/11/2017
Coaxial Cable	Huber+Suhner	mini 141-12 SUCOFLEX 104	966Rx 18G-40G	12/12/2016	12/11/2017
Coaxial Cable	Huber+Suhner	SUCOFLEX 104	966Tx 30M-18G	12/12/2016	12/11/2017
Coaxial Cable	Huber+Suhner	SUCOFLEX 102	966Tx 18G-40G	12/12/2016	12/11/2017
Attenuator	WOKEN	218FS-10	RF27	12/12/2016	12/11/2017
Site NSA	SGS	966 Chamber C	SAC-C	03/02/2017	03/01/2018
Site VSWR	SGS	966 Chamber C	SAC-C	03/02/2017	03/01/2018
DC Power Supply	HOLA	DP-3003	D7070035	05/04/2017	05/03/2018
Controller	MF	MF-7802	N/A	N.C.R.	N.C.R.
Antenna Master	MF	N/A	N/A	N.C.R.	N.C.R.
Turn Table	MF	N/A	N/A	N.C.R.	N.C.R.
Test Software	World-Pallas	Dr. E	V 3.0 Lite	N.C.R.	N.C.R.

NOTE: N.C.R refers to Not Calibrated Required.

Unless otherwise stated the results shown in this test report refer only to the sample(s) tested and such sample(s) are retained for 90 days only.

除非另有說明，此報告結果僅對測試之樣品負責，同時此樣品僅保留90天。本報告未經本公司書面許可，不可部份複製。

This document is issued by the Company subject to its General Conditions of Service printed overleaf, available on request or accessible at www.sgs.com/terms_and_conditions.htm and, for electronic format documents, subject to Terms and Conditions for Electronic Documents at www.sgs.com/terms_e-document.htm. Attention is drawn to the limitation of liability, indemnification and jurisdiction issues defined therein. Any holder of this document is advised that information contained hereon reflects the Company's findings at the time of its intervention only and within the limits of Client's instructions, if any. The Company's sole responsibility is to its Client and this document does not exonerate parties to a transaction from exercising all their rights and obligations under the transaction documents. This document cannot be reproduced except in full, without prior written approval of the Company. Any unauthorized alteration, forgery or falsification of the content or appearance of this document is unlawful and offenders may be prosecuted to the fullest extent of the law.

SGS Taiwan Ltd.

No.134,WuKungRoad,NewTaipeiIndustrialPark,WukuDistrict,NewTaipeiCity,Taiwan24803/新北市五股區新北產業園區五工路 134 號

台灣檢驗科技股份有限公司

t (886-2) 2299-3279

f (886-2) 2298-0488

www.tw.sgs.com

Member of SGS Group

10.3 Test SET-UP

(A) Radiated Emission Test Set-UP Frequency Below 30MHz.

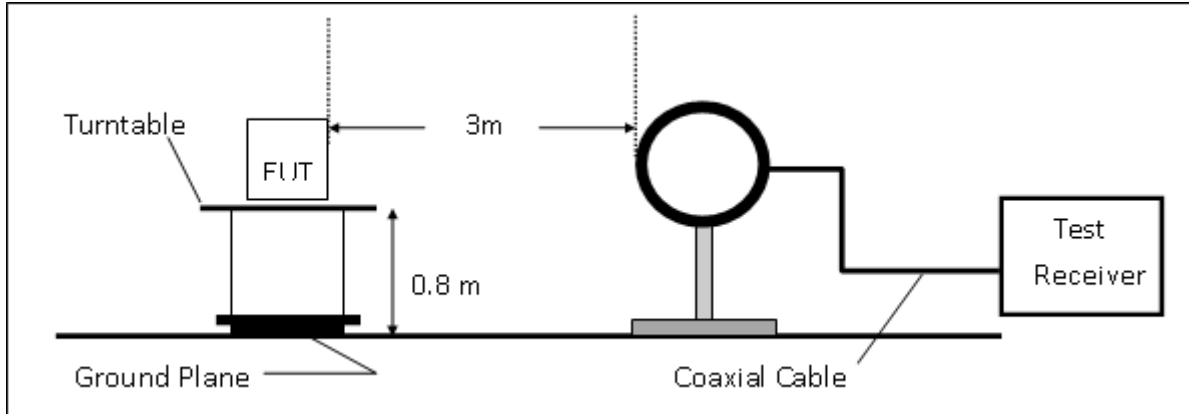

(B) Radiated Emission Test Set-Up, Frequency form 30MHz to 1000MHz

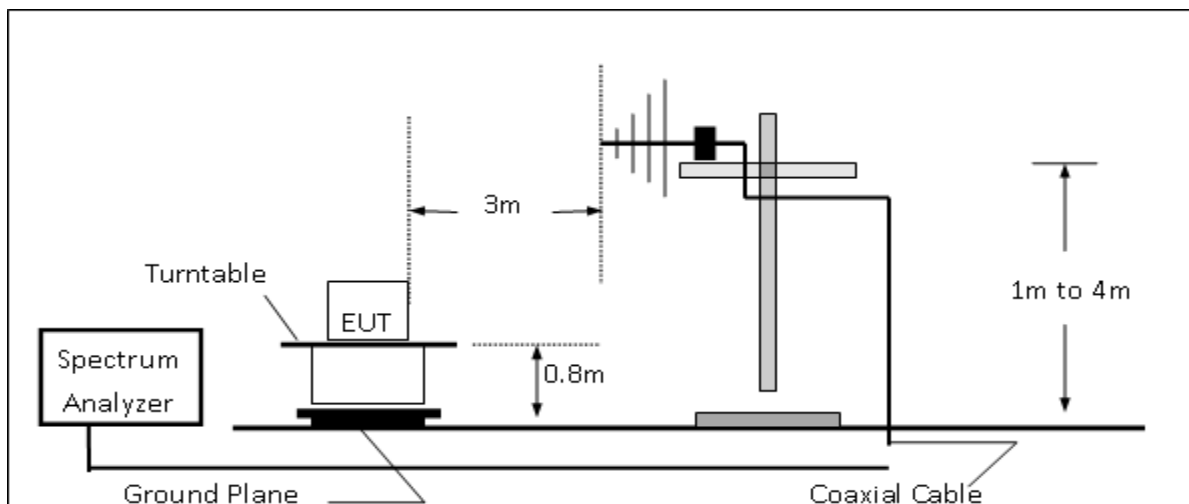

(C) Radiated Emission Test Set-UP Frequency Over 1 GHz

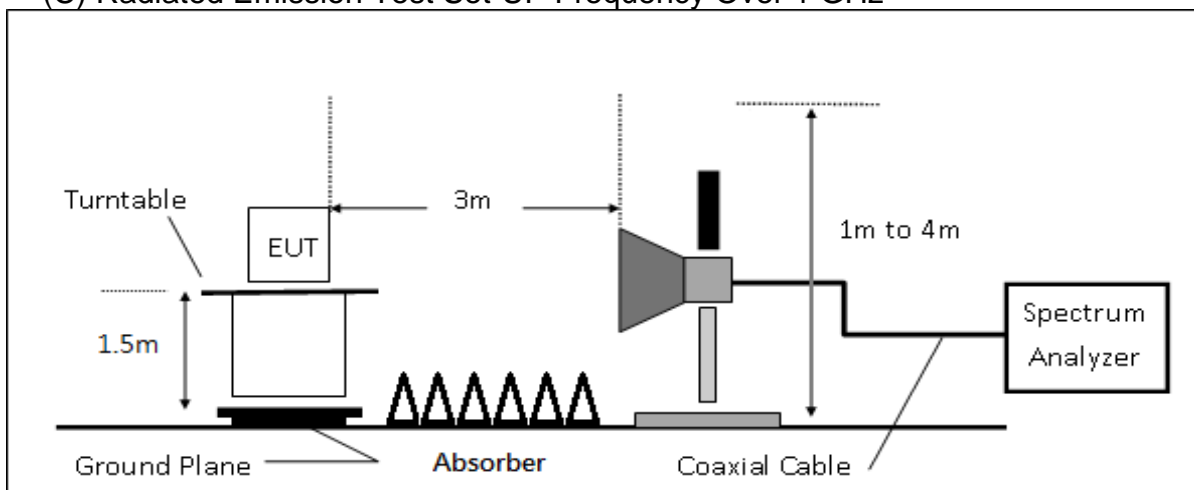

Unless otherwise stated the results shown in this test report refer only to the sample(s) tested and such sample(s) are retained for 90 days only.

除非另有說明，此報告結果僅對測試之樣品負責，同時此樣品僅保留90天。本報告未經本公司書面許可，不可部份複製。

This document is issued by the Company subject to its General Conditions of Service printed overleaf, available on request or accessible at www.sgs.com/terms_and_conditions.htm and, for electronic format documents, subject to Terms and Conditions for Electronic Documents at www.sgs.com/terms_e-document.htm. Attention is drawn to the limitation of liability, indemnification and jurisdiction issues defined therein. Any holder of this document is advised that information contained hereon reflects the Company's findings at the time of its intervention only and within the limits of Client's instructions, if any. The Company's sole responsibility is to its Client and this document does not exonerate parties to a transaction from exercising all their rights and obligations under the transaction documents. This document cannot be reproduced except in full, without prior written approval of the Company. Any unauthorized alteration, forgery or falsification of the content or appearance of this document is unlawful and offenders may be prosecuted to the fullest extent of the law.

10.4 Measurement Procedure

1. The testing follows the Measurement Procedure of FCC KDB 558074 D01 DTS Meas. Guidance .
2. The EUT was placed on a turn table with 0.8m for frequency< 1GHz and 1.5m for frequency> 1GHz above ground plane.
3. The turn table shall rotate 360 degrees to determine the position of maximum emission level.
4. EUT is set 3m away from the receiving antenna which varied from 1m to 4m to find out the highest emissions.
5. When measurement procedures for electric field radiated emissions above 1 GHz the EUT measurement is to be made “while keeping the antenna in the ‘cone of radiation’ from that area and pointed at the area both in azimuth and elevation, with polarization oriented for maximum response.” is still within the 3dB illumination BW of the measurement antenna.
6. Set the spectrum analyzer as RBW=120 kHz and VBW=300 kHz for Peak Detector (PK) and Quasi-peak (QP) at frequency below 1 GHz.
7. Set the spectrum analyzer as RBW=1 MHz, VBW=3 MHz for Peak Detector at frequency above 1 GHz.
8. Set the spectrum analyzer as RBW=1 MHz, VBW=10 Hz (Duty cycle > 98%) or VBW ≥ 1/T (Duty cycle < 98%) for Average Detector at frequency above 1 GHz.
9. The test-receiver system was set to quasi-peak detect function and specified bandwidth with maximum hold mode when the test frequency is below 1 GHz.
10. Maximum procedure was performed on the six highest emissions to ensure EUT compliance.
11. And also, each emission was to be maximized by changing the polarization of receiving antenna both horizontal and vertical. On spectrum, change spectrum mode in linear display mode, and reduce VBW = 10Hz if average reading is measured.
12. Repeat above procedures until all default test channel measured were complete.

Unless otherwise stated the results shown in this test report refer only to the sample(s) tested and such sample(s) are retained for 90 days only.

除非另有說明，此報告結果僅對測試之樣品負責，同時此樣品僅保留90天。本報告未經本公司書面許可，不可部份複製。

This document is issued by the Company subject to its General Conditions of Service printed overleaf, available on request or accessible at www.sgs.com/terms_and_conditions.htm and, for electronic format documents, subject to Terms and Conditions for Electronic Documents at www.sgs.com/terms_e-document.htm. Attention is drawn to the limitation of liability, indemnification and jurisdiction issues defined therein. Any holder of this document is advised that information contained hereon reflects the Company's findings at the time of its intervention only and within the limits of Client's instructions, if any. The Company's sole responsibility is to its Client and this document does not exonerate parties to a transaction from exercising all their rights and obligations under the transaction documents. This document cannot be reproduced except in full, without prior written approval of the Company. Any unauthorized alteration, forgery or falsification of the content or appearance of this document is unlawful and offenders may be prosecuted to the fullest extent of the law.

SGS Taiwan Ltd.

台灣檢驗科技股份有限公司

No.134,WuKungRoad,NewTaipeiIndustrialPark,WukuDistrict,NewTaipeiCity,Taiwan24803/新北市五股區新北產業園區五工路 134 號

t (886-2) 2299-3279

f (886-2) 2298-0488

www.tw.sgs.com

Member of SGS Group

10.5 Field Strength Calculation

The field strength is calculated by adding the Antenna Factor and Cable Factor and subtracting the Amplifier Gain and Duty Cycle Correction Factor (if any) from the measured reading. The basic equation with a sample calculation is as follows:

$$FS = RA + AF + CL - AG$$

Where	FS = Field Strength	CL = Cable Attenuation Factor (Cable Loss)
	RA = Reading Amplitude	AG = Amplifier Gain
	AF = Antenna Factor	

Actual FS(dBµV/m) = SPA. Reading level(dBµV) + Factor(dB)

Factor(dB) = Antenna Factor(dBµV/m) + Cable Loss(dB) – Pre_Amplifier Gain(dB)

Note :

“F” : denotes Fundamental Frequency. ; “H” : denotes Harmonic Frequency.

“E” : denotes Band Edge Frequency. ; “S” : denotes Spurious Frequency.

10.6 Test Results of Radiated Spurious Emissions form 9 kHz to 30 MHz

The low frequency, which started from 9 kHz to 30MHz, was pre-scanned and the result which was 20dB lower than the limit per 15.31(o) was not reported.

10.7 Measurement Result

Note: Refer to next page spectrum analyzer data chart and tabular data sheets.

Unless otherwise stated the results shown in this test report refer only to the sample(s) tested and such sample(s) are retained for 90 days only.

除非另有說明，此報告結果僅對測試之樣品負責，同時此樣品僅保留90天。本報告未經本公司書面許可，不可部份複製。

This document is issued by the Company subject to its General Conditions of Service printed overleaf, available on request or accessible at www.sgs.com/terms_and_conditions.htm and, for electronic format documents, subject to Terms and Conditions for Electronic Documents at www.sgs.com/terms_e-document.htm. Attention is drawn to the limitation of liability, indemnification and jurisdiction issues defined therein. Any holder of this document is advised that information contained hereon reflects the Company's findings at the time of its intervention only and within the limits of Client's instructions, if any. The Company's sole responsibility is to its Client and this document does not exonerate parties to a transaction from exercising all their rights and obligations under the transaction documents. This document cannot be reproduced except in full, without prior written approval of the Company. Any unauthorized alteration, forgery or falsification of the content or appearance of this document is unlawful and offenders may be prosecuted to the fullest extent of the law.

Radiated Band Edge Measurement Result (802.11b)

Operation Mode :	802.11b	Test Date :	2017/10/19
Fundamental Frequency :	2412 MHz	Temp. / Humi. :	24.5deg_C/70RH
Operation Band :	BE CH LOW	Test Engineer :	Enzo
EUT Pol. :	H	Measurement Antenna Pol. :	Vertical

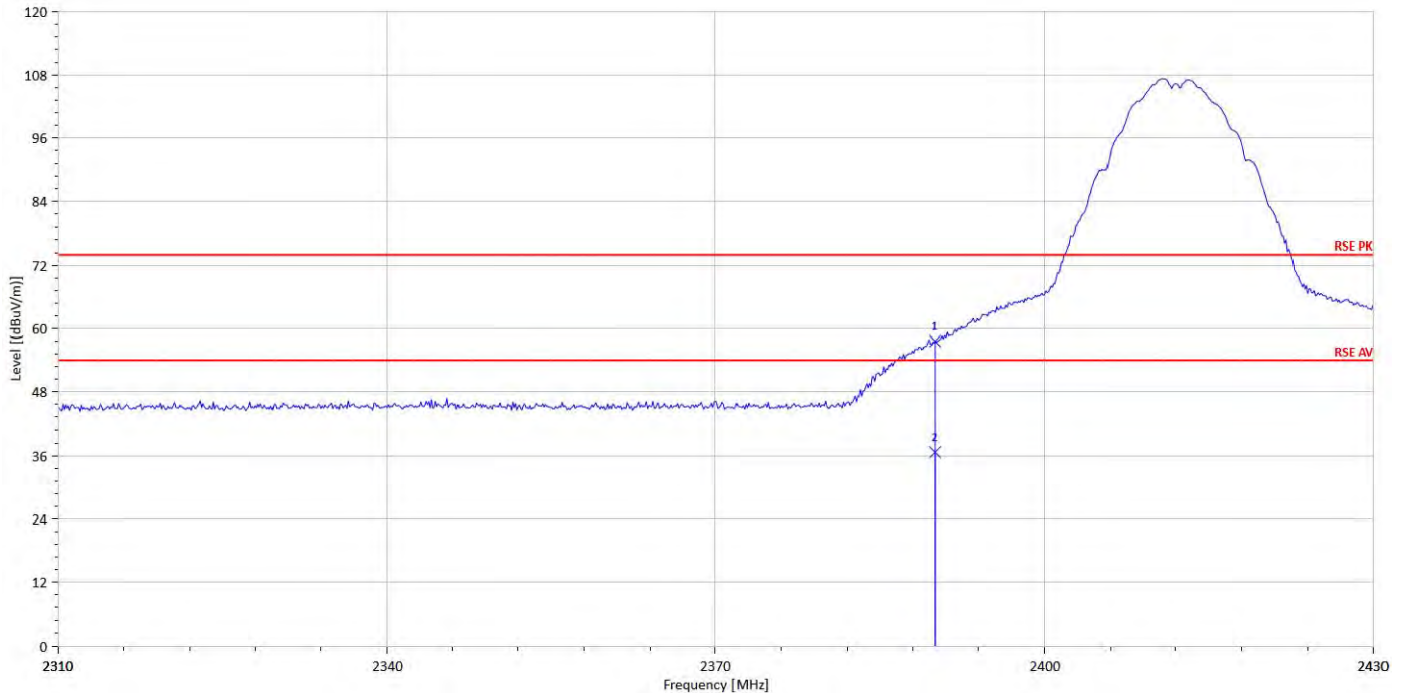

Freq. MHz	Note F/H/E/S	Detector Mode PK/QP/AV	Spectrum Reading Level dBµV	Factor dB	Actual FS dBµV/m	Limit @3m dBµV/m	Margin dB
2390.00	E	Peak	56.70	0.92	57.62	74	-16.38
2390.00	E	Average	35.77	0.92	36.69	54	-17.31

Unless otherwise stated the results shown in this test report refer only to the sample(s) tested and such sample(s) are retained for 90 days only.

除非另有說明，此報告結果僅對測試之樣品負責，同時此樣品僅保留90天。本報告未經本公司書面許可，不可部份複製。

This document is issued by the Company subject to its General Conditions of Service printed overleaf, available on request or accessible at www.sgs.com/terms_and_conditions.htm and, for electronic format documents, subject to Terms and Conditions for Electronic Documents at www.sgs.com/terms_e-document.htm. Attention is drawn to the limitation of liability, indemnification and jurisdiction issues defined therein. Any holder of this document is advised that information contained hereon reflects the Company's findings at the time of its intervention only and within the limits of Client's instructions, if any. The Company's sole responsibility is to its Client and this document does not exonerate parties to a transaction from exercising all their rights and obligations under the transaction documents. This document cannot be reproduced except in full, without prior written approval of the Company. Any unauthorized alteration, forgery or falsification of the content or appearance of this document is unlawful and offenders may be prosecuted to the fullest extent of the law.

SGS Taiwan Ltd.

No. 134, WuKungRoad, NewTaipeiIndustrialPark, WukuDistrict, NewTaipeiCity, Taiwan24803/新北市五股區新北產業園區五工路 134 號

台灣檢驗科技股份有限公司

t (886-2) 2299-3279

f (886-2) 2298-0488

www.tw.sgs.com

Member of SGS Group

Operation Mode :	802.11b	Test Date :	2017/10/19
Fundamental Frequency :	2412 MHz	Temp. / Humi. :	24.5deg_C/70RH
Operation Band :	BE CH LOW	Test Engineer :	Enzo
EUT Pol. :	H	Measurement Antenna Pol. :	Horizontal

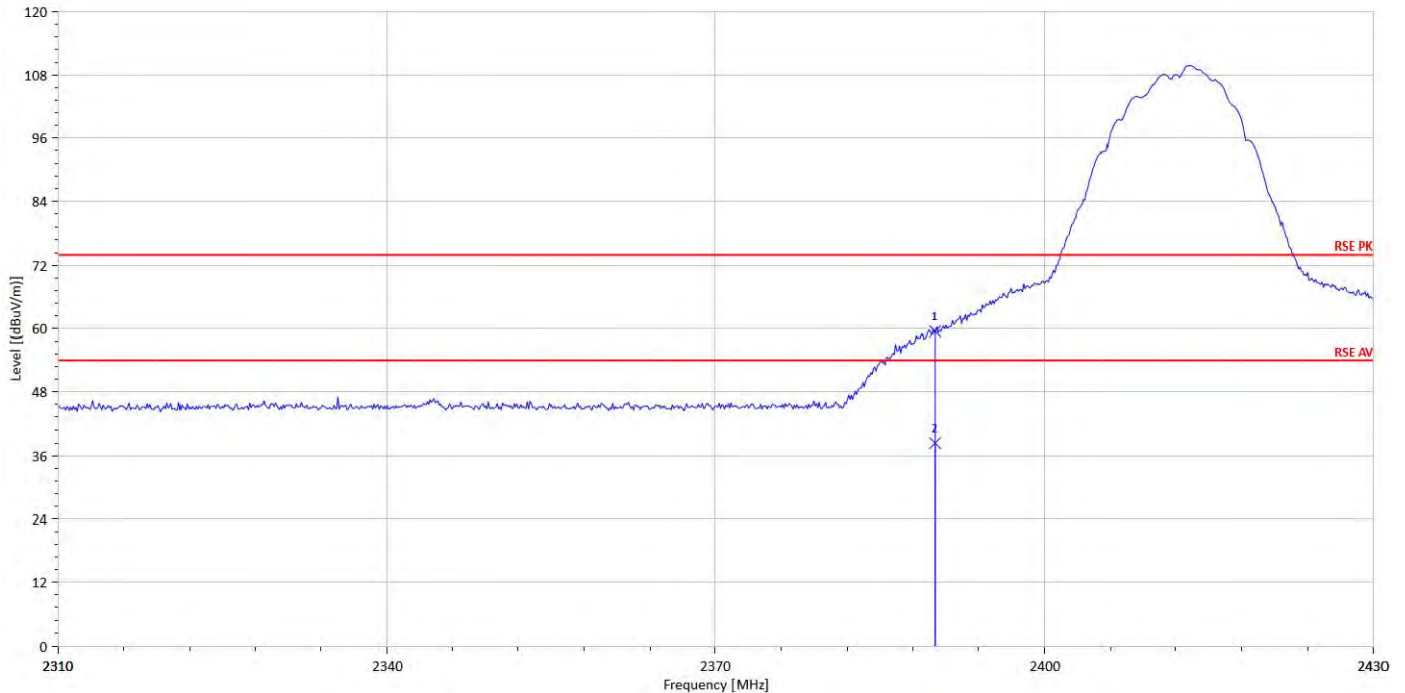

Freq. MHz	Note F/H/E/S	Detector Mode PK/QP/AV	Spectrum Reading Level dBµV	Factor dB	Actual FS dBµV/m	Limit @3m dBµV/m	Margin dB
2390.00	E	Peak	58.53	0.92	59.46	74	-14.54
2390.00	E	Average	37.48	0.92	38.40	54	-15.60

Unless otherwise stated the results shown in this test report refer only to the sample(s) tested and such sample(s) are retained for 90 days only.

除非另有說明，此報告結果僅對測試之樣品負責，同時此樣品僅保留90天。本報告未經本公司書面許可，不可部份複製。

This document is issued by the Company subject to its General Conditions of Service printed overleaf, available on request or accessible at www.sgs.com/terms_and_conditions.htm and, for electronic format documents, subject to Terms and Conditions for Electronic Documents at www.sgs.com/terms_e-document.htm. Attention is drawn to the limitation of liability, indemnification and jurisdiction issues defined therein. Any holder of this document is advised that information contained hereon reflects the Company's findings at the time of its intervention only and within the limits of Client's instructions, if any. The Company's sole responsibility is to its Client and this document does not exonerate parties to a transaction from exercising all their rights and obligations under the transaction documents. This document cannot be reproduced except in full, without prior written approval of the Company. Any unauthorized alteration, forgery or falsification of the content or appearance of this document is unlawful and offenders may be prosecuted to the fullest extent of the law.

SGS Taiwan Ltd.

No. 134, WuKungRoad, NewTaipeiIndustrialPark, WukuDistrict, NewTaipeiCity, Taiwan24803/新北市五股區新北產業園區五工路 134 號

台灣檢驗科技股份有限公司

t (886-2) 2299-3279

f (886-2) 2298-0488

www.tw.sgs.com

Member of SGS Group

Operation Mode : 802.11b Test Date : 2017/10/19
 Fundamental Frequency : 2462 MHz Temp. / Humi. : 24.5deg_C/70RH
 Operation Band : BE CH HIGH Test Engineer : Enzo
 EUT Pol. : H Measurement Antenna Pol. : Vertical

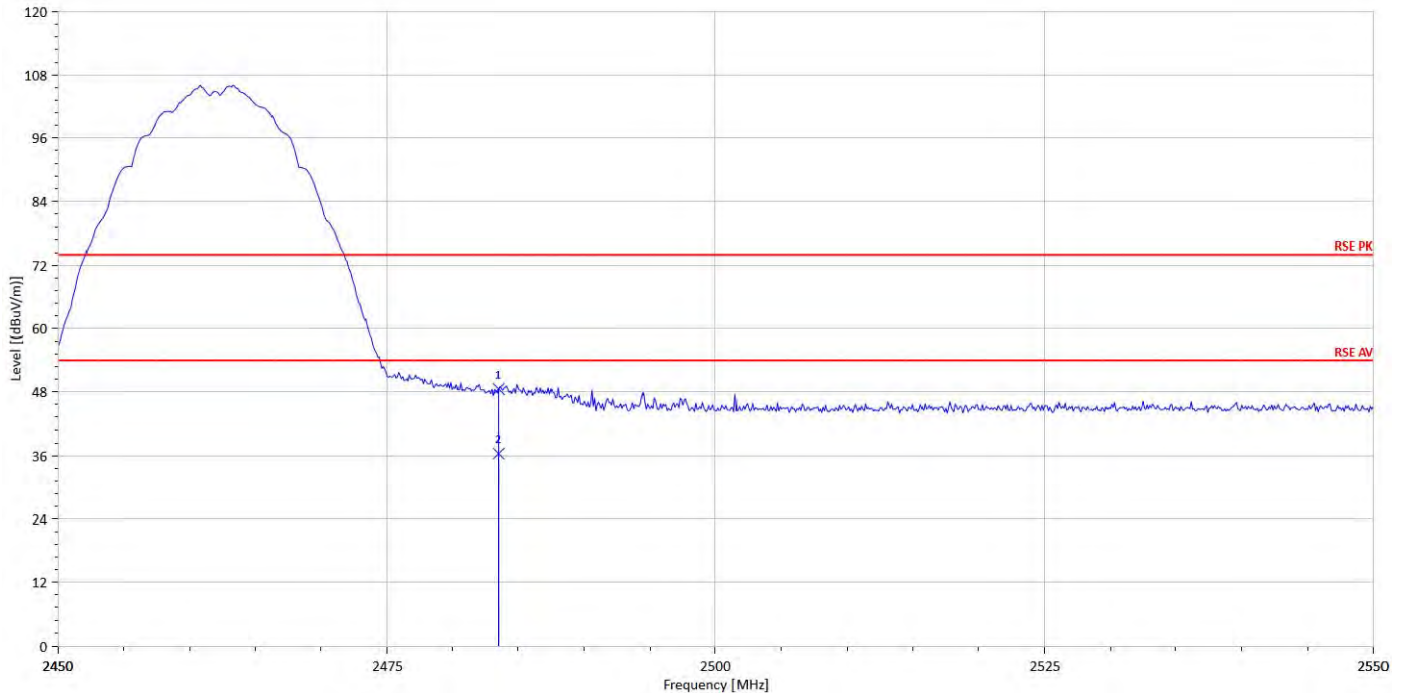

Freq. MHz	Note F/H/E/S	Detector Mode PK/QP/AV	Spectrum Reading Level dBµV	Factor dB	Actual FS dBµV/m	Limit @3m dBµV/m	Margin dB
2483.50	E	Peak	47.41	1.16	48.57	74	-25.43
2483.50	E	Average	35.24	1.16	36.40	54	-17.60

Unless otherwise stated the results shown in this test report refer only to the sample(s) tested and such sample(s) are retained for 90 days only.

除非另有說明，此報告結果僅對測試之樣品負責，同時此樣品僅保留90天。本報告未經本公司書面許可，不可部份複製。

This document is issued by the Company subject to its General Conditions of Service printed overleaf, available on request or accessible at www.sgs.com/terms_and_conditions.htm and, for electronic format documents, subject to Terms and Conditions for Electronic Documents at www.sgs.com/terms_e-document.htm. Attention is drawn to the limitation of liability, indemnification and jurisdiction issues defined therein. Any holder of this document is advised that information contained hereon reflects the Company's findings at the time of its intervention only and within the limits of Client's instructions, if any. The Company's sole responsibility is to its Client and this document does not exonerate parties to a transaction from exercising all their rights and obligations under the transaction documents. This document cannot be reproduced except in full, without prior written approval of the Company. Any unauthorized alteration, forgery or falsification of the content or appearance of this document is unlawful and offenders may be prosecuted to the fullest extent of the law.

SGS Taiwan Ltd.

No. 134, WuKungRoad, NewTaipeiIndustrialPark, WukuDistrict, NewTaipeiCity, Taiwan24803/新北市五股區新北產業園區五工路 134 號

台灣檢驗科技股份有限公司

t (886-2) 2299-3279

f (886-2) 2298-0488

www.tw.sgs.com

Member of SGS Group

Operation Mode :	802.11b	Test Date :	2017/10/19
Fundamental Frequency :	2462 MHz	Temp. / Humi. :	24.5deg_C/70RH
Operation Band :	BE CH HIGH	Test Engineer :	Enzo
EUT Pol. :	H	Measurement Antenna Pol. :	Horizontal

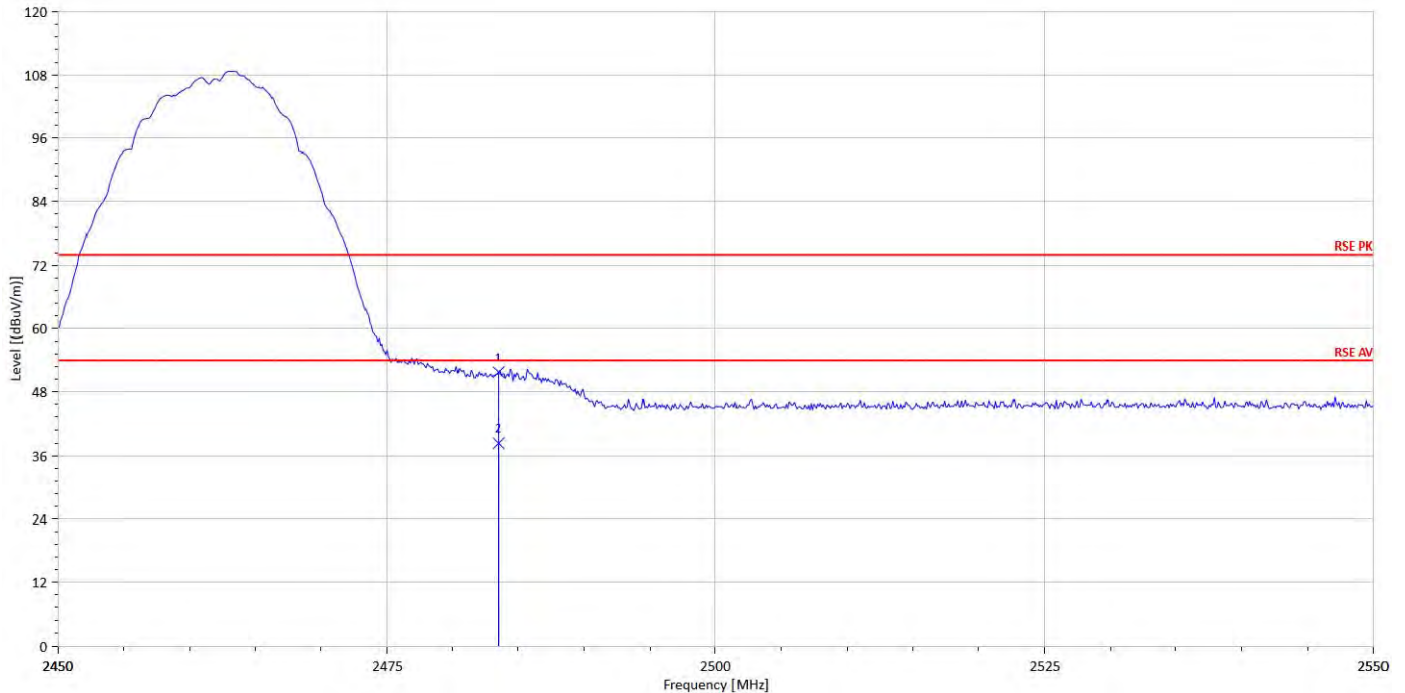

Freq. MHz	Note F/H/E/S	Detector Mode PK/QP/AV	Spectrum Reading Level dBµV	Factor dB	Actual FS dBµV/m	Limit @3m dBµV/m	Margin dB
2483.50	E	Peak	50.62	1.16	51.78	74	-22.22
2483.50	E	Average	37.22	1.16	38.38	54	-15.62

Unless otherwise stated the results shown in this test report refer only to the sample(s) tested and such sample(s) are retained for 90 days only.

除非另有說明，此報告結果僅對測試之樣品負責，同時此樣品僅保留90天。本報告未經本公司書面許可，不可部份複製。

This document is issued by the Company subject to its General Conditions of Service printed overleaf, available on request or accessible at www.sgs.com/terms_and_conditions.htm and, for electronic format documents, subject to Terms and Conditions for Electronic Documents at www.sgs.com/terms_e-document.htm. Attention is drawn to the limitation of liability, indemnification and jurisdiction issues defined therein. Any holder of this document is advised that information contained hereon reflects the Company's findings at the time of its intervention only and within the limits of Client's instructions, if any. The Company's sole responsibility is to its Client and this document does not exonerate parties to a transaction from exercising all their rights and obligations under the transaction documents. This document cannot be reproduced except in full, without prior written approval of the Company. Any unauthorized alteration, forgery or falsification of the content or appearance of this document is unlawful and offenders may be prosecuted to the fullest extent of the law.

SGS Taiwan Ltd.

No. 134, WuKungRoad, NewTaipeiIndustrialPark, WukuDistrict, NewTaipeiCity, Taiwan24803/新北市五股區新北產業園區五工路 134 號

台灣檢驗科技股份有限公司

t (886-2) 2299-3279

f (886-2) 2298-0488

www.tw.sgs.com

Member of SGS Group

Radiated Band Edge Measurement Result (802.11g)

Operation Mode :	802.11g	Test Date :	2017/10/19
Fundamental Frequency :	2412 MHz	Temp. / Humi. :	24.5deg_C/70RH
Operation Band :	BE CH LOW	Test Engineer :	Enzo
EUT Pol. :	H	Measurement Antenna Pol. :	Vertical

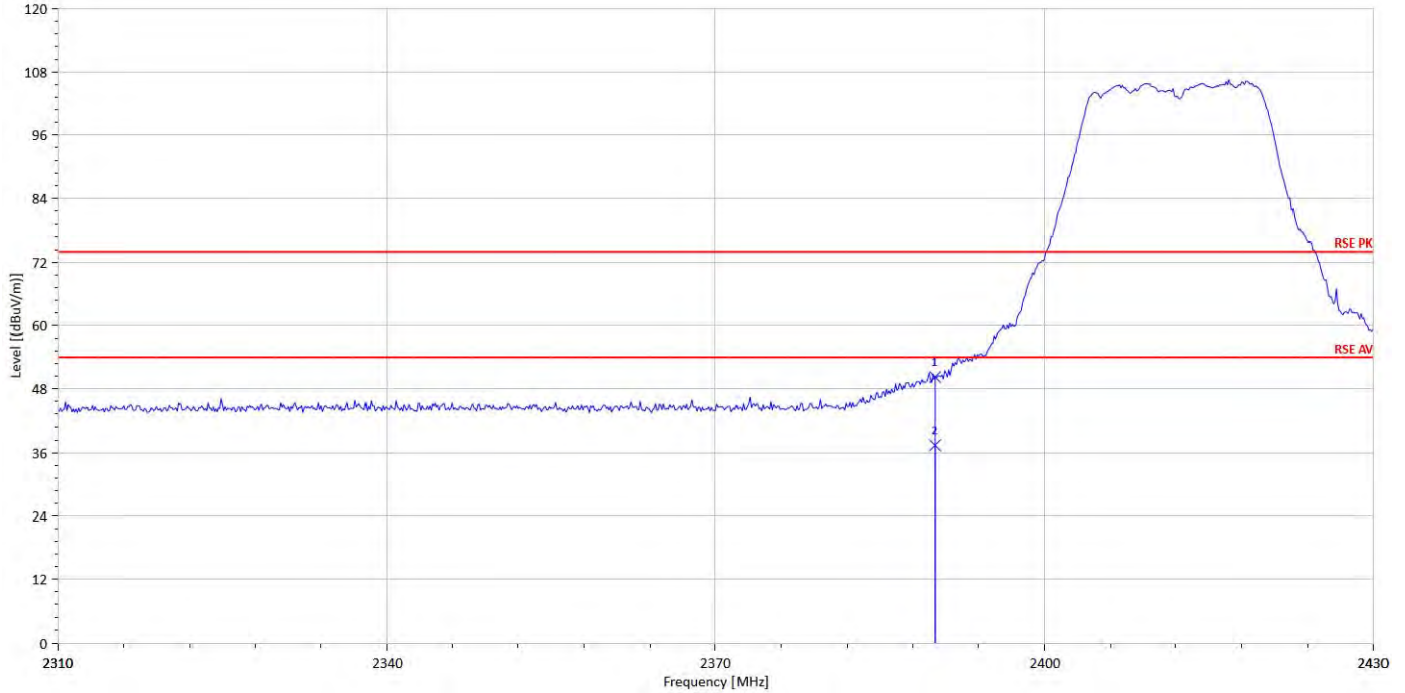

Freq. MHz	Note F/H/E/S	Detector Mode PK/QP/AV	Spectrum Reading Level dBµV	Factor dB	Actual FS dBµV/m	Limit @3m dBµV/m	Margin dB
2390.00	E	Peak	49.35	0.92	50.28	74	-23.72
2390.00	E	Average	36.49	0.92	37.41	54	-16.59

Unless otherwise stated the results shown in this test report refer only to the sample(s) tested and such sample(s) are retained for 90 days only.

除非另有說明，此報告結果僅對測試之樣品負責，同時此樣品僅保留90天。本報告未經本公司書面許可，不可部份複製。

This document is issued by the Company subject to its General Conditions of Service printed overleaf, available on request or accessible at www.sgs.com/terms_and_conditions.htm and, for electronic format documents, subject to Terms and Conditions for Electronic Documents at www.sgs.com/terms_e-document.htm. Attention is drawn to the limitation of liability, indemnification and jurisdiction issues defined therein. Any holder of this document is advised that information contained hereon reflects the Company's findings at the time of its intervention only and within the limits of Client's instructions, if any. The Company's sole responsibility is to its Client and this document does not exonerate parties to a transaction from exercising all their rights and obligations under the transaction documents. This document cannot be reproduced except in full, without prior written approval of the Company. Any unauthorized alteration, forgery or falsification of the content or appearance of this document is unlawful and offenders may be prosecuted to the fullest extent of the law.

SGS Taiwan Ltd.

No.134,WuKungRoad,NewTaipeiIndustrialPark,WukuDistrict,NewTaipeiCity,Taiwan24803/新北市五股區新北產業園區五工路 134 號

台灣檢驗科技股份有限公司

t (886-2) 2299-3279

f (886-2) 2298-0488

www.tw.sgs.com

Member of SGS Group

Operation Mode : 802.11g Test Date : 2017/10/19
 Fundamental Frequency : 2412 MHz Temp. / Humi. : 24.5deg_C/70RH
 Operation Band : BE CH LOW Test Engineer : Enzo
 EUT Pol. : H Measurement Antenna Pol. : Horizontal

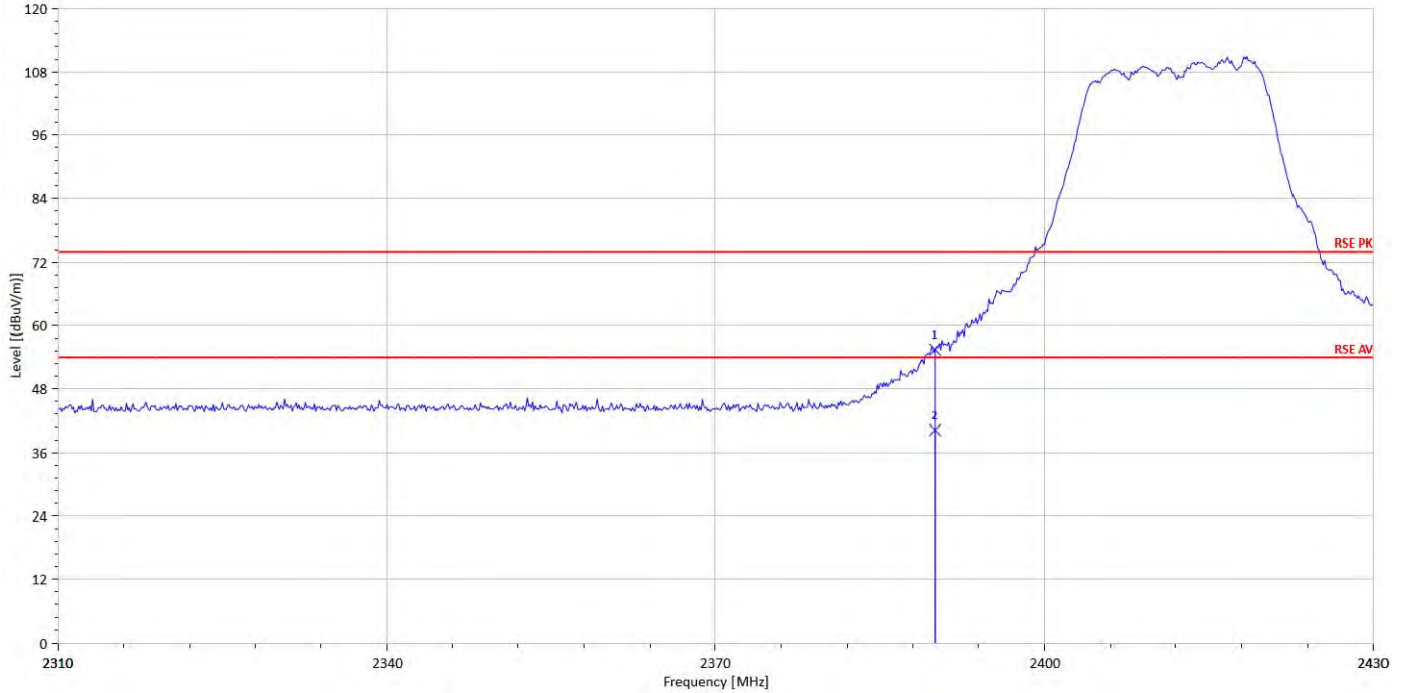

Freq. MHz	Note F/H/E/S	Detector Mode PK/QP/AV	Spectrum Reading Level dBµV	Factor dB	Actual FS dBµV/m	Limit @3m dBµV/m	Margin dB
2390.00	E	Peak	54.57	0.92	55.49	74	-18.51
2390.00	E	Average	39.34	0.92	40.26	54	-13.74

Unless otherwise stated the results shown in this test report refer only to the sample(s) tested and such sample(s) are retained for 90 days only.

除非另有說明，此報告結果僅對測試之樣品負責，同時此樣品僅保留90天。本報告未經本公司書面許可，不可部份複製。

This document is issued by the Company subject to its General Conditions of Service printed overleaf, available on request or accessible at www.sgs.com/terms_and_conditions.htm and, for electronic format documents, subject to Terms and Conditions for Electronic Documents at www.sgs.com/terms_e-document.htm. Attention is drawn to the limitation of liability, indemnification and jurisdiction issues defined therein. Any holder of this document is advised that information contained hereon reflects the Company's findings at the time of its intervention only and within the limits of Client's instructions, if any. The Company's sole responsibility is to its Client and this document does not exonerate parties to a transaction from exercising all their rights and obligations under the transaction documents. This document cannot be reproduced except in full, without prior written approval of the Company. Any unauthorized alteration, forgery or falsification of the content or appearance of this document is unlawful and offenders may be prosecuted to the fullest extent of the law.

SGS Taiwan Ltd.

No. 134, WuKungRoad, NewTaipeiIndustrialPark, WukuDistrict, NewTaipeiCity, Taiwan24803/新北市五股區新北產業園區五工路 134 號

台灣檢驗科技股份有限公司

t (886-2) 2299-3279

f (886-2) 2298-0488

www.tw.sgs.com

Member of SGS Group

Operation Mode :	802.11g	Test Date :	2017/10/19
Fundamental Frequency :	2462 MHz	Temp. / Humi. :	24.5deg_C/70RH
Operation Band :	BE CH HIGH	Test Engineer :	Enzo
EUT Pol. :	H	Measurement Antenna Pol. :	Vertical

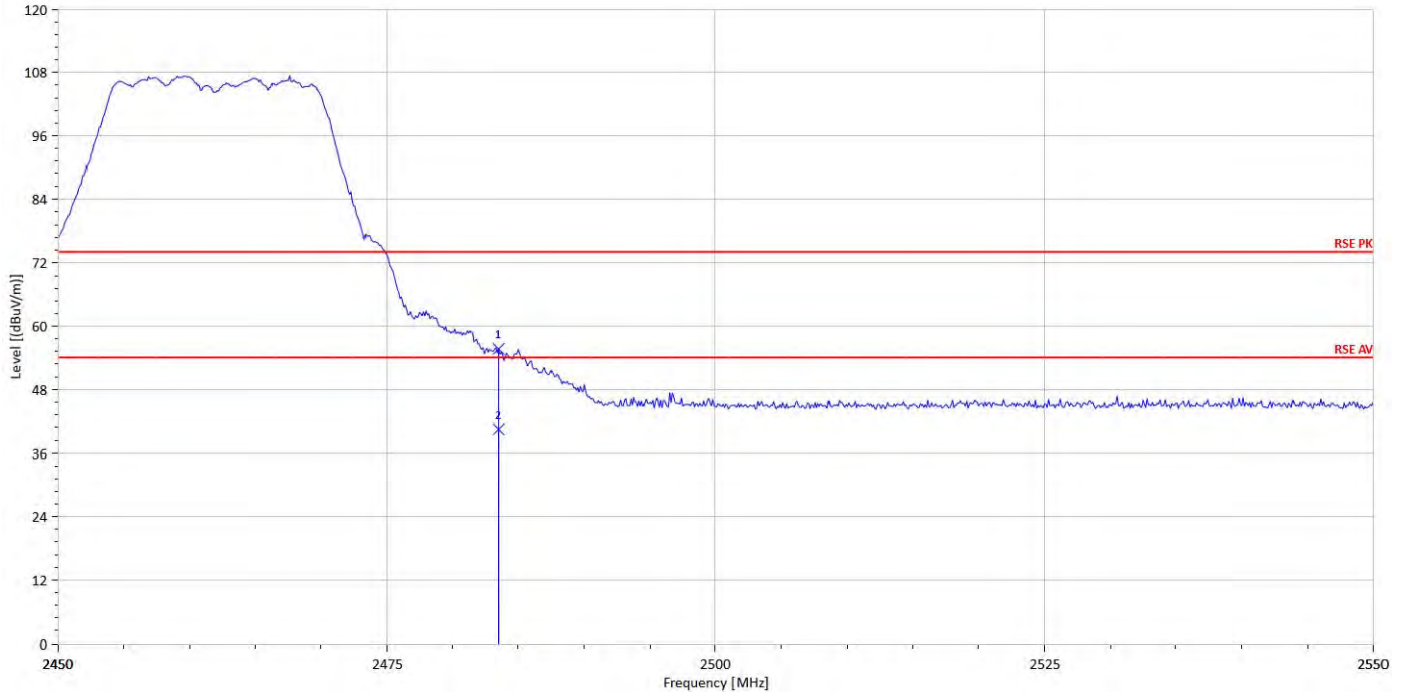

Freq. MHz	Note F/H/E/S	Detector Mode PK/QP/AV	Spectrum Reading Level dBµV	Factor dB	Actual FS dBµV/m	Limit @3m dBµV/m	Margin dB
2483.50	E	Peak	54.48	1.16	55.64	74	-18.36
2483.50	E	Average	39.31	1.16	40.47	54	-13.53

Unless otherwise stated the results shown in this test report refer only to the sample(s) tested and such sample(s) are retained for 90 days only.

除非另有說明，此報告結果僅對測試之樣品負責，同時此樣品僅保留90天。本報告未經本公司書面許可，不可部份複製。

This document is issued by the Company subject to its General Conditions of Service printed overleaf, available on request or accessible at www.sgs.com/terms_and_conditions.htm and, for electronic format documents, subject to Terms and Conditions for Electronic Documents at www.sgs.com/terms_e-document.htm. Attention is drawn to the limitation of liability, indemnification and jurisdiction issues defined therein. Any holder of this document is advised that information contained hereon reflects the Company's findings at the time of its intervention only and within the limits of Client's instructions, if any. The Company's sole responsibility is to its Client and this document does not exonerate parties to a transaction from exercising all their rights and obligations under the transaction documents. This document cannot be reproduced except in full, without prior written approval of the Company. Any unauthorized alteration, forgery or falsification of the content or appearance of this document is unlawful and offenders may be prosecuted to the fullest extent of the law.

SGS Taiwan Ltd.

No. 134, WuKungRoad, NewTaipeiIndustrialPark, WukuDistrict, NewTaipeiCity, Taiwan24803/新北市五股區新北產業園區五工路 134 號

台灣檢驗科技股份有限公司

t (886-2) 2299-3279

f (886-2) 2298-0488

www.tw.sgs.com

Member of SGS Group

Operation Mode : 802.11g Test Date : 2017/10/19
 Fundamental Frequency : 2462 MHz Temp. / Humi. : 24.5deg_C/70RH
 Operation Band : BE CH HIGH Test Engineer : Enzo
 EUT Pol. : H Measurement Antenna Pol. : Horizontal

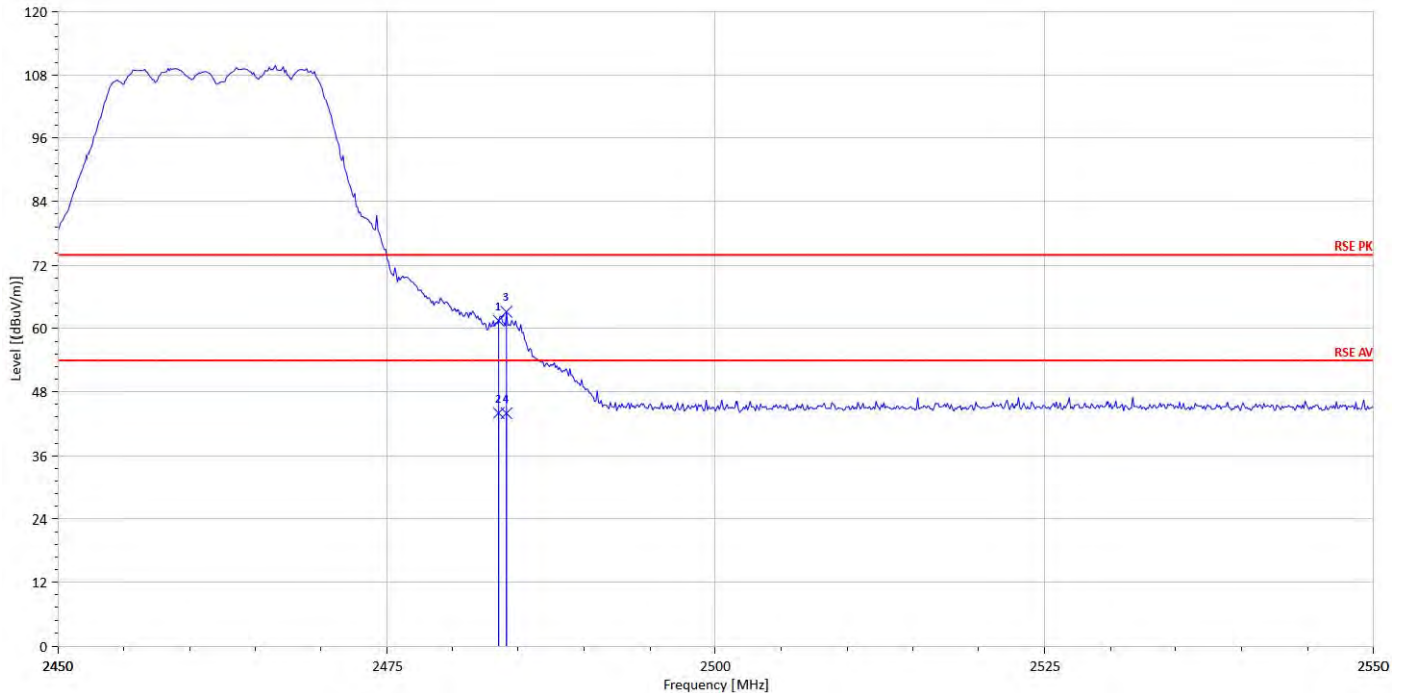

Freq. MHz	Note F/H/E/S	Detector Mode PK/QP/AV	Spectrum Reading Level dBµV	Factor dB	Actual FS dBµV/m	Limit @3m dBµV/m	Margin dB
2483.50	E	Peak	60.27	1.16	61.43	74	-12.57
2483.50	E	Average	42.81	1.16	43.97	54	-10.03
2484.10	S	Peak	61.98	1.16	63.14	74	-10.86
2484.10	S	Average	42.77	1.16	43.93	54	-10.07

Unless otherwise stated the results shown in this test report refer only to the sample(s) tested and such sample(s) are retained for 90 days only.

除非另有說明，此報告結果僅對測試之樣品負責，同時此樣品僅保留90天。本報告未經本公司書面許可，不可部份複製。

This document is issued by the Company subject to its General Conditions of Service printed overleaf, available on request or accessible at www.sgs.com/terms_and_conditions.htm and, for electronic format documents, subject to Terms and Conditions for Electronic Documents at www.sgs.com/terms_e-document.htm. Attention is drawn to the limitation of liability, indemnification and jurisdiction issues defined therein. Any holder of this document is advised that information contained hereon reflects the Company's findings at the time of its intervention only and within the limits of Client's instructions, if any. The Company's sole responsibility is to its Client and this document does not exonerate parties to a transaction from exercising all their rights and obligations under the transaction documents. This document cannot be reproduced except in full, without prior written approval of the Company. Any unauthorized alteration, forgery or falsification of the content or appearance of this document is unlawful and offenders may be prosecuted to the fullest extent of the law.

SGS Taiwan Ltd.

No. 134, WuKungRoad, NewTaipeiIndustrialPark, WukuDistrict, NewTaipeiCity, Taiwan24803/新北市五股區新北產業園區五工路 134 號

台灣檢驗科技股份有限公司

t (886-2) 2299-3279

f (886-2) 2298-0488

www.tw.sgs.com

Member of SGS Group

Radiated Band Edge Measurement Result (802.11_HT20)

Operation Mode :	802.11n20	Test Date :	2017/10/19
Fundamental Frequency :	2412 MHz	Temp. / Humi. :	24.5deg_C/70RH
Operation Band :	BE CH LOW	Test Engineer :	Enzo
EUT Pol. :	H	Measurement Antenna Pol. :	Vertical

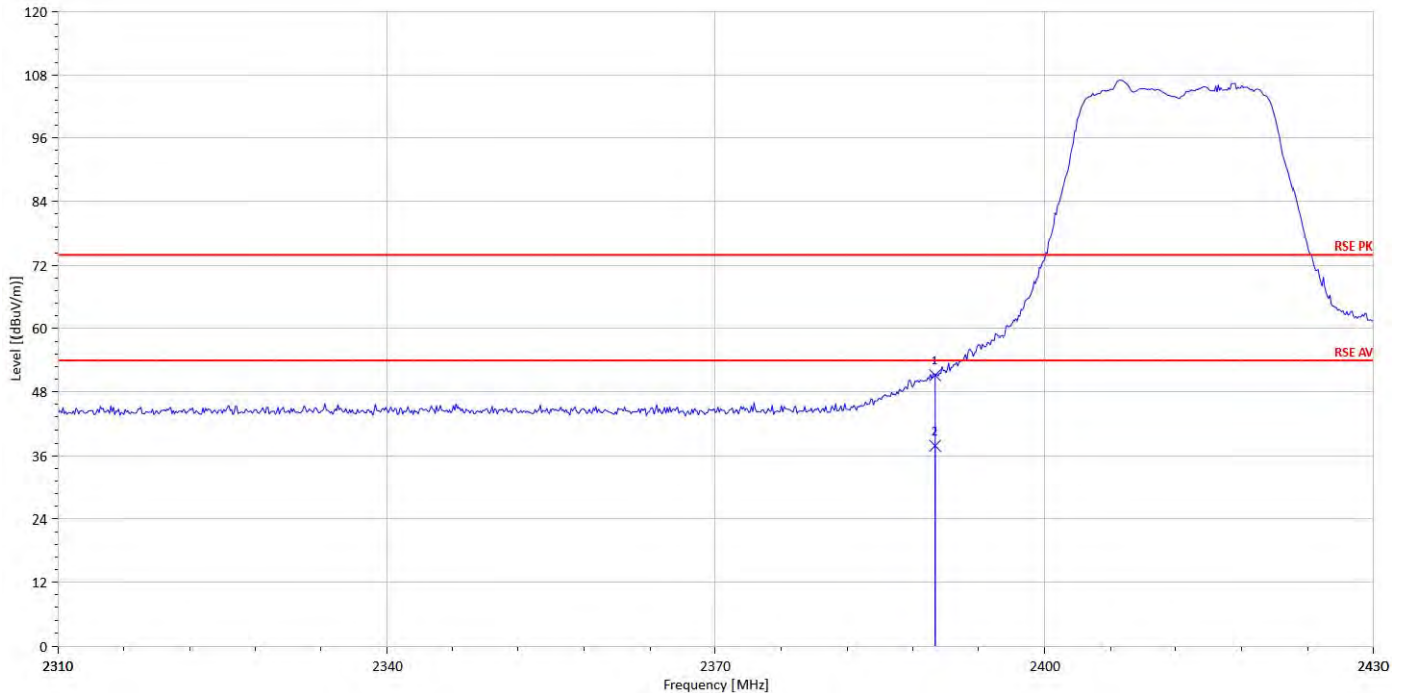

Freq. MHz	Note F/H/E/S	Detector Mode PK/QP/AV	Spectrum Reading Level dBµV	Factor dB	Actual FS dBµV/m	Limit @3m dBµV/m	Margin dB
2390.00	E	Peak	50.28	0.92	51.20	74	-22.80
2390.00	E	Average	36.97	0.92	37.89	54	-16.11

Unless otherwise stated the results shown in this test report refer only to the sample(s) tested and such sample(s) are retained for 90 days only.

除非另有說明，此報告結果僅對測試之樣品負責，同時此樣品僅保留90天。本報告未經本公司書面許可，不可部份複製。

This document is issued by the Company subject to its General Conditions of Service printed overleaf, available on request or accessible at www.sgs.com/terms_and_conditions.htm and, for electronic format documents, subject to Terms and Conditions for Electronic Documents at www.sgs.com/terms_e-document.htm. Attention is drawn to the limitation of liability, indemnification and jurisdiction issues defined therein. Any holder of this document is advised that information contained hereon reflects the Company's findings at the time of its intervention only and within the limits of Client's instructions, if any. The Company's sole responsibility is to its Client and this document does not exonerate parties to a transaction from exercising all their rights and obligations under the transaction documents. This document cannot be reproduced except in full, without prior written approval of the Company. Any unauthorized alteration, forgery or falsification of the content or appearance of this document is unlawful and offenders may be prosecuted to the fullest extent of the law.

SGS Taiwan Ltd.

No.134,WuKungRoad,NewTaipeiIndustrialPark,WukuDistrict,NewTaipeiCity,Taiwan24803/新北市五股區新北產業園區五工路 134 號

台灣檢驗科技股份有限公司

t (886-2) 2299-3279

f (886-2) 2298-0488

www.tw.sgs.com

Member of SGS Group

Operation Mode : 802.11n20 Test Date : 2017/10/19
 Fundamental Frequency : 2412 MHz Temp. / Humi. : 24.5deg_C/70RH
 Operation Band : BE CH LOW Test Engineer : Enzo
 EUT Pol. : H Measurement Antenna Pol. : Horizontal

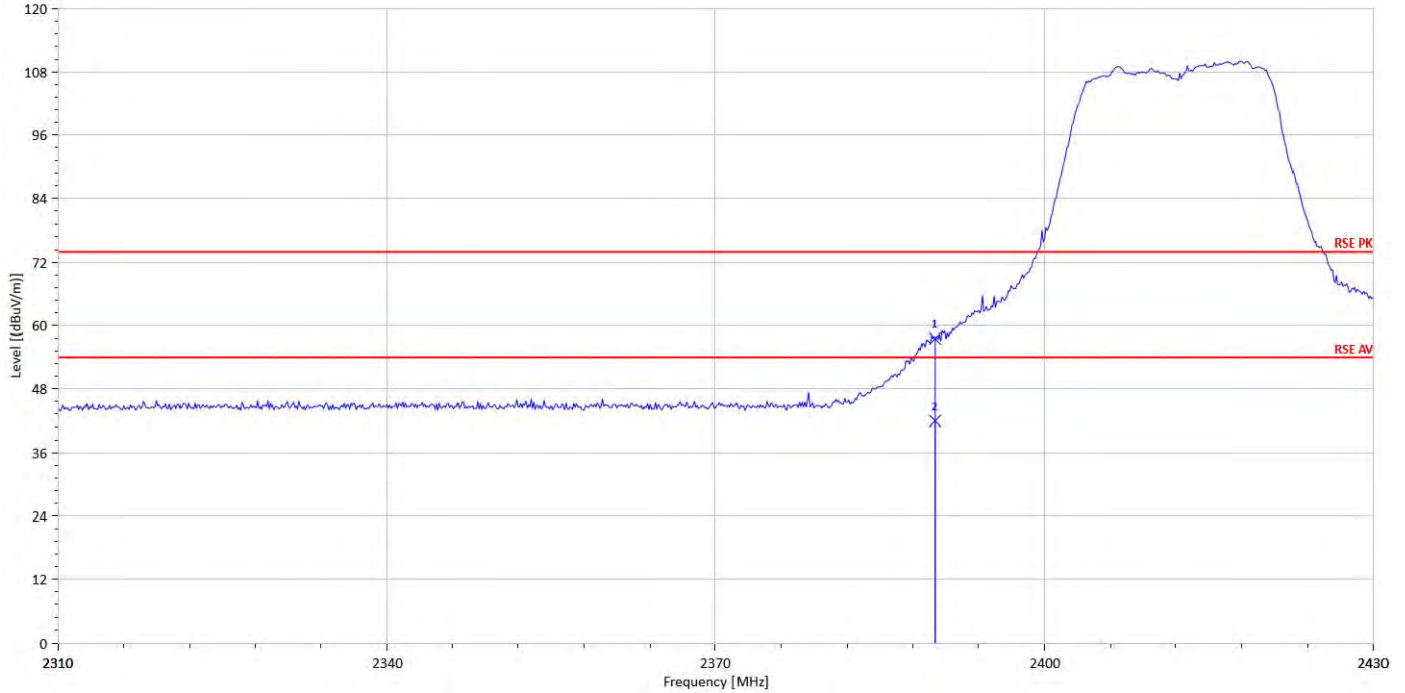

Freq.	Note	Detector Mode	Spectrum Reading Level	Factor	Actual FS	Limit @3m	Margin
MHz	F/H/E/S	PK/QP/AV	dBµV	dB	dBµV/m	dBµV/m	dB
2390.00	E	Peak	56.65	0.92	57.57	74	-16.43
2390.00	E	Average	41.01	0.92	41.93	54	-12.07

Unless otherwise stated the results shown in this test report refer only to the sample(s) tested and such sample(s) are retained for 90 days only.

除非另有說明，此報告結果僅對測試之樣品負責，同時此樣品僅保留90天。本報告未經本公司書面許可，不可部份複製。

This document is issued by the Company subject to its General Conditions of Service printed overleaf, available on request or accessible at www.sgs.com/terms_and_conditions.htm and, for electronic format documents, subject to Terms and Conditions for Electronic Documents at www.sgs.com/terms_e-document.htm. Attention is drawn to the limitation of liability, indemnification and jurisdiction issues defined therein. Any holder of this document is advised that information contained hereon reflects the Company's findings at the time of its intervention only and within the limits of Client's instructions, if any. The Company's sole responsibility is to its Client and this document does not exonerate parties to a transaction from exercising all their rights and obligations under the transaction documents. This document cannot be reproduced except in full, without prior written approval of the Company. Any unauthorized alteration, forgery or falsification of the content or appearance of this document is unlawful and offenders may be prosecuted to the fullest extent of the law.

SGS Taiwan Ltd.

No. 134, WuKungRoad, NewTaipeiIndustrialPark, WukuDistrict, NewTaipeiCity, Taiwan24803/新北市五股區新北產業園區五工路 134 號

台灣檢驗科技股份有限公司

t (886-2) 2299-3279

f (886-2) 2298-0488

www.tw.sgs.com

Member of SGS Group

Operation Mode :	802.11n20	Test Date :	2017/10/19
Fundamental Frequency :	2462 MHz	Temp. / Humi. :	24.5deg_C/70RH
Operation Band :	BE CH HIGH	Test Engineer :	Enzo
EUT Pol. :	H	Measurement Antenna Pol. :	Vertical

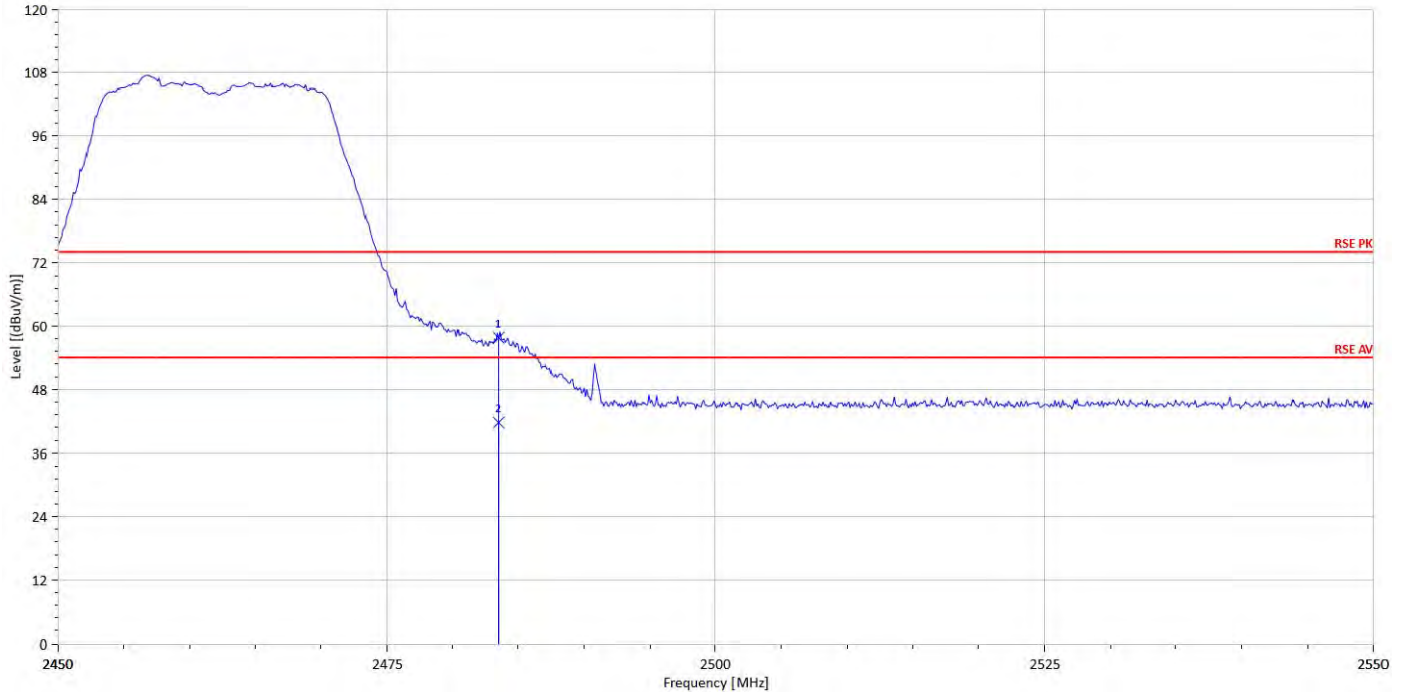

Freq. MHz	Note F/H/E/S	Detector Mode PK/QP/AV	Spectrum Reading Level dBµV	Factor dB	Actual FS dBµV/m	Limit @3m dBµV/m	Margin dB
2483.50	E	Peak	56.63	1.16	57.79	74	-16.21
2483.50	E	Average	40.62	1.16	41.78	54	-12.22

Unless otherwise stated the results shown in this test report refer only to the sample(s) tested and such sample(s) are retained for 90 days only.

除非另有說明，此報告結果僅對測試之樣品負責，同時此樣品僅保留90天。本報告未經本公司書面許可，不可部份複製。

This document is issued by the Company subject to its General Conditions of Service printed overleaf, available on request or accessible at www.sgs.com/terms_and_conditions.htm and, for electronic format documents, subject to Terms and Conditions for Electronic Documents at www.sgs.com/terms_e-document.htm. Attention is drawn to the limitation of liability, indemnification and jurisdiction issues defined therein. Any holder of this document is advised that information contained hereon reflects the Company's findings at the time of its intervention only and within the limits of Client's instructions, if any. The Company's sole responsibility is to its Client and this document does not exonerate parties to a transaction from exercising all their rights and obligations under the transaction documents. This document cannot be reproduced except in full, without prior written approval of the Company. Any unauthorized alteration, forgery or falsification of the content or appearance of this document is unlawful and offenders may be prosecuted to the fullest extent of the law.

SGS Taiwan Ltd.

No. 134, WuKungRoad, NewTaipeiIndustrialPark, WukuDistrict, NewTaipeiCity, Taiwan24803/新北市五股區新北產業園區五工路 134 號

台灣檢驗科技股份有限公司

t (886-2) 2299-3279

f (886-2) 2298-0488

www.tw.sgs.com

Member of SGS Group

Operation Mode : 802.11n20 Test Date : 2017/10/19
 Fundamental Frequency : 2462 MHz Temp. / Humi. : 24.5deg_C/70RH
 Operation Band : BE CH HIGH Test Engineer : Enzo
 EUT Pol. : H Measurement Antenna Pol. : Horizontal

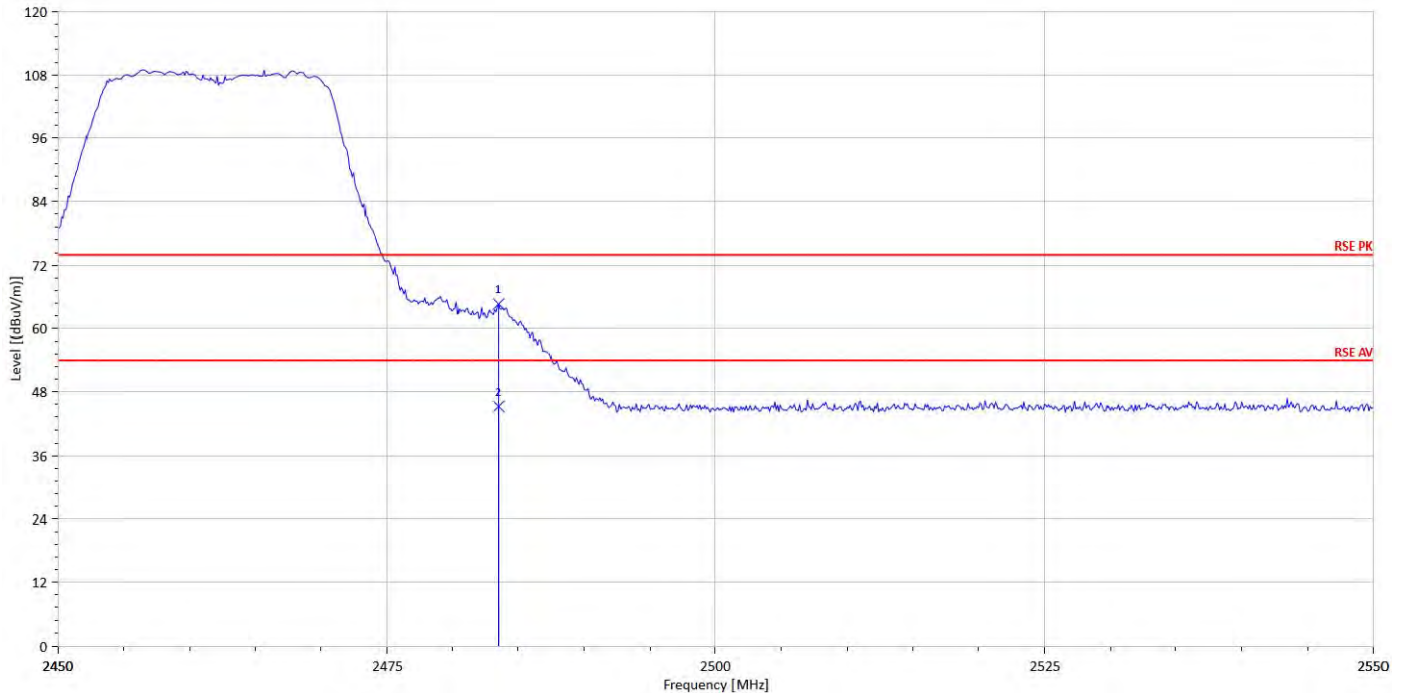

Freq. MHz	Note F/H/E/S	Detector Mode PK/QP/AV	Spectrum Reading Level dBµV	Factor dB	Actual FS dBµV/m	Limit @3m dBµV/m	Margin dB
2483.50	E	Peak	63.46	1.16	64.62	74	-9.38
2483.50	E	Average	44.08	1.16	45.24	54	-8.76

Unless otherwise stated the results shown in this test report refer only to the sample(s) tested and such sample(s) are retained for 90 days only.

除非另有說明，此報告結果僅對測試之樣品負責，同時此樣品僅保留90天。本報告未經本公司書面許可，不可部份複製。

This document is issued by the Company subject to its General Conditions of Service printed overleaf, available on request or accessible at www.sgs.com/terms_and_conditions.htm and, for electronic format documents, subject to Terms and Conditions for Electronic Documents at www.sgs.com/terms_e-document.htm. Attention is drawn to the limitation of liability, indemnification and jurisdiction issues defined therein. Any holder of this document is advised that information contained hereon reflects the Company's findings at the time of its intervention only and within the limits of Client's instructions, if any. The Company's sole responsibility is to its Client and this document does not exonerate parties to a transaction from exercising all their rights and obligations under the transaction documents. This document cannot be reproduced except in full, without prior written approval of the Company. Any unauthorized alteration, forgery or falsification of the content or appearance of this document is unlawful and offenders may be prosecuted to the fullest extent of the law.

SGS Taiwan Ltd.

No. 134, WuKungRoad, NewTaipeiIndustrialPark, WukuDistrict, NewTaipeiCity, Taiwan24803/新北市五股區新北產業園區五工路 134 號

台灣檢驗科技股份有限公司

t (886-2) 2299-3279

f (886-2) 2298-0488

www.tw.sgs.com

Member of SGS Group

Below 1GHz Worst-Case Data:

Radiated Spurious Emission Measurement Result (802.11 g)

Operation Mode : 802.11g Test Date : 2017/10/19
 Fundamental Frequency : 2412 MHz Temp. / Humi. : 24.5deg_C/70RH
 Operation Band : Tx CH Low Test Engineer : Ashton
 EUT Pol. : H Measurement Antenna Pol. : Vertical

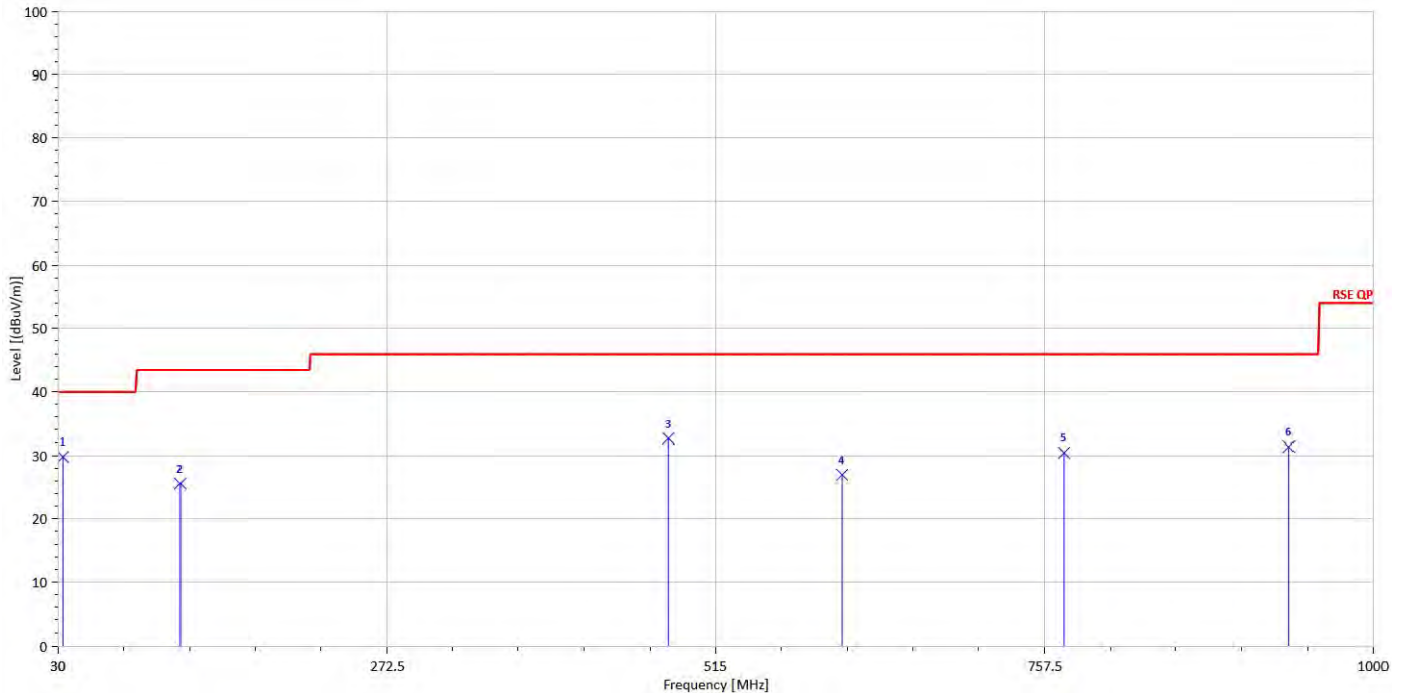

Freq. MHz	Note F/H/E/S	Detector Mode PK/QP/AV	Spectrum Reading Level dBµV	Factor dB	Actual FS dBµV/m	Limit @3m dBµV/m	Margin dB
33.88	S	Peak	39.07	-9.27	29.79	40	-10.21
120.21	S	Peak	41.41	-15.84	25.57	43.5	-17.93
480.08	S	Peak	40.46	-7.81	32.65	46	-13.35
608.12	S	Peak	33.59	-6.64	26.95	46	-19.05
772.05	S	Peak	34.85	-4.41	30.44	46	-15.56
937.92	S	Peak	33.08	-1.71	31.37	46	-14.63

Unless otherwise stated the results shown in this test report refer only to the sample(s) tested and such sample(s) are retained for 90 days only.

除非另有說明，此報告結果僅對測試之樣品負責，同時此樣品僅保留90天。本報告未經本公司書面許可，不可部份複製。

This document is issued by the Company subject to its General Conditions of Service printed overleaf, available on request or accessible at www.sgs.com/terms_and_conditions.htm and, for electronic format documents, subject to Terms and Conditions for Electronic Documents at www.sgs.com/terms_e-document.htm. Attention is drawn to the limitation of liability, indemnification and jurisdiction issues defined therein. Any holder of this document is advised that information contained hereon reflects the Company's findings at the time of its intervention only and within the limits of Client's instructions, if any. The Company's sole responsibility is to its Client and this document does not exonerate parties to a transaction from exercising all their rights and obligations under the transaction documents. This document cannot be reproduced except in full, without prior written approval of the Company. Any unauthorized alteration, forgery or falsification of the content or appearance of this document is unlawful and offenders may be prosecuted to the fullest extent of the law.

SGS Taiwan Ltd.

No.134,WuKungRoad,NewTaipeiIndustrialPark,WukuDistrict,NewTaipeiCity,Taiwan24803/新北市五股區新北產業園區五工路 134 號

台灣檢驗科技股份有限公司

t (886-2) 2299-3279

f (886-2) 2298-0488

www.tw.sgs.com

Member of SGS Group

Operation Mode : 802.11g Test Date : 2017/10/19
 Fundamental Frequency : 2412 MHz Temp. / Humi. : 24.5deg_C/70RH
 Operation Band : Tx CH Low Test Engineer : Ashton
 EUT Pol. : H Measurement Antenna Pol. : Horizontal

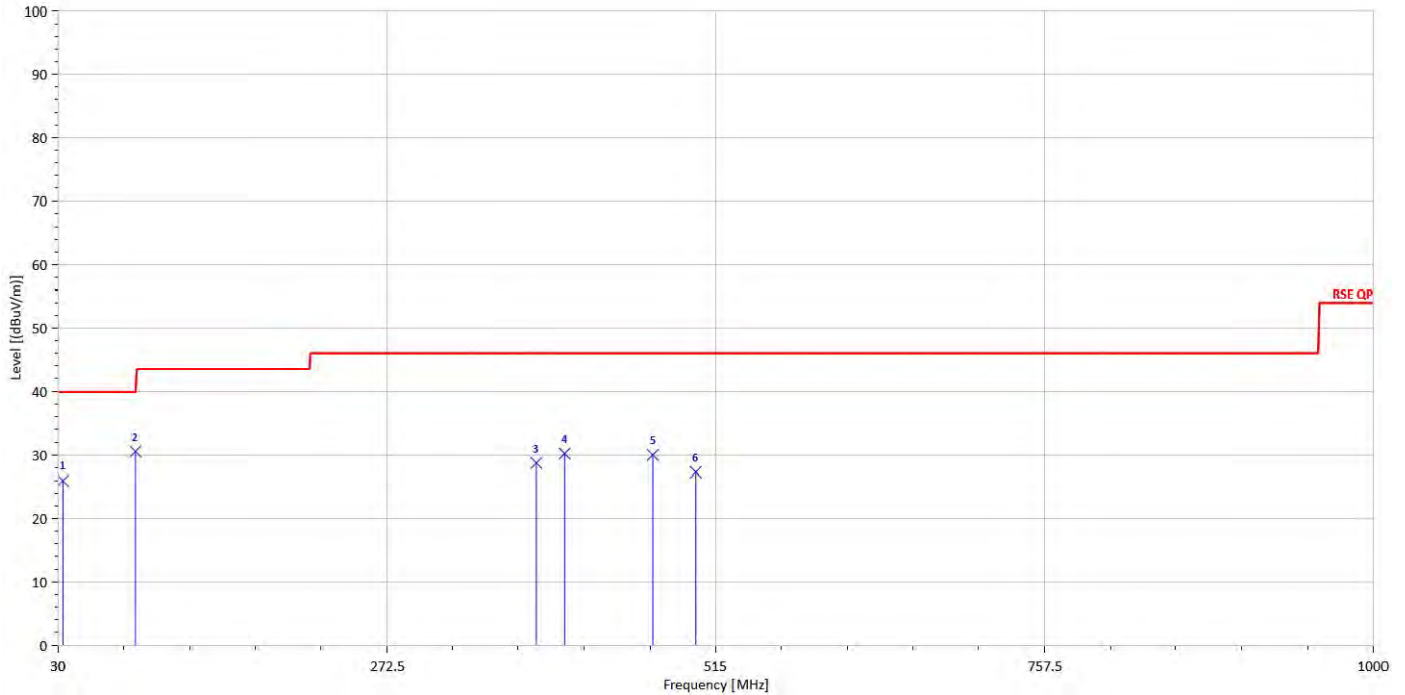

Freq. MHz	Note F/H/E/S	Detector Mode PK/QP/AV	Spectrum Reading Level dBuV	Factor dB	Actual FS dBuV/m	Limit @3m dBuV/m	Margin dB
33.88	S	Peak	35.26	-9.27	25.98	40	-14.02
87.23	S	Peak	50.45	-19.92	30.53	40	-9.47
383.08	S	Peak	39.02	-10.31	28.71	46	-17.29
403.45	S	Peak	39.85	-9.65	30.20	46	-15.80
468.44	S	Peak	37.64	-7.66	29.99	46	-16.01
500.45	S	Peak	34.81	-7.53	27.28	46	-18.72

Unless otherwise stated the results shown in this test report refer only to the sample(s) tested and such sample(s) are retained for 90 days only.

除非另有說明，此報告結果僅對測試之樣品負責，同時此樣品僅保留90天。本報告未經本公司書面許可，不可部份複製。

This document is issued by the Company subject to its General Conditions of Service printed overleaf, available on request or accessible at www.sgs.com/terms_and_conditions.htm and, for electronic format documents, subject to Terms and Conditions for Electronic Documents at www.sgs.com/terms_e-document.htm. Attention is drawn to the limitation of liability, indemnification and jurisdiction issues defined therein. Any holder of this document is advised that information contained hereon reflects the Company's findings at the time of its intervention only and within the limits of Client's instructions, if any. The Company's sole responsibility is to its Client and this document does not exonerate parties to a transaction from exercising all their rights and obligations under the transaction documents. This document cannot be reproduced except in full, without prior written approval of the Company. Any unauthorized alteration, forgery or falsification of the content or appearance of this document is unlawful and offenders may be prosecuted to the fullest extent of the law.

SGS Taiwan Ltd.

No. 134, WuKungRoad, NewTaipeiIndustrialPark, WukuDistrict, NewTaipeiCity, Taiwan24803/新北市五股區新北產業園區五工路 134 號

台灣檢驗科技股份有限公司

t (886-2) 2299-3279

f (886-2) 2298-0488

www.tw.sgs.com

Member of SGS Group

Operation Mode : 802.11g Test Date : 2017/10/19
 Fundamental Frequency : 2437 MHz Temp. / Humi. : 24.5deg_C/70RH
 Operation Band : Tx CH Mid Test Engineer : Ashton
 EUT Pol. : H Measurement Antenna Pol. : Vertical

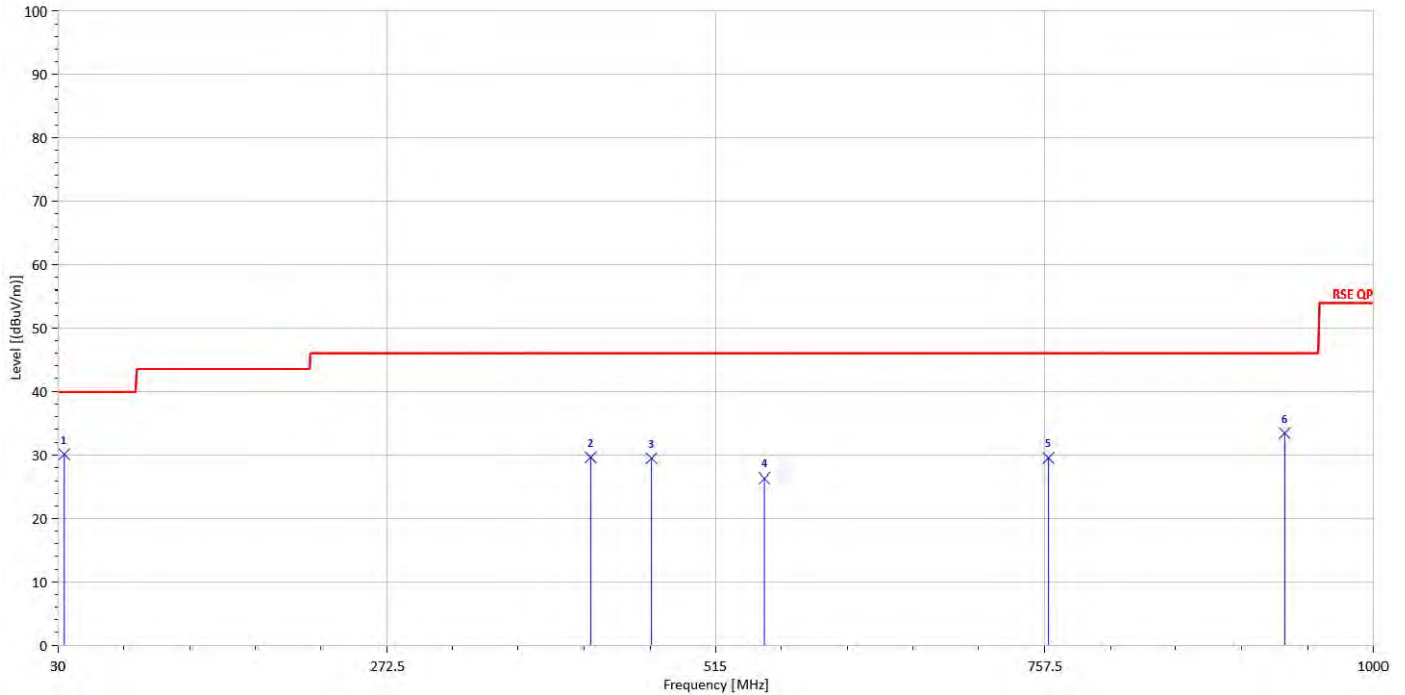

Freq. MHz	Note F/H/E/S	Detector Mode PK/QP/AV	Spectrum Reading Level dBuV	Factor dB	Actual FS dBuV/m	Limit @3m dBuV/m	Margin dB
34.85	S	Peak	39.85	-9.78	30.07	40	-9.93
422.85	S	Peak	38.94	-9.36	29.59	46	-16.41
467.47	S	Peak	37.17	-7.73	29.44	46	-16.56
550.89	S	Peak	33.12	-6.77	26.36	46	-19.64
760.41	S	Peak	33.40	-3.91	29.49	46	-16.51
935.01	S	Peak	35.03	-1.59	33.44	46	-12.56

Unless otherwise stated the results shown in this test report refer only to the sample(s) tested and such sample(s) are retained for 90 days only.

除非另有說明，此報告結果僅對測試之樣品負責，同時此樣品僅保留90天。本報告未經本公司書面許可，不可部份複製。

This document is issued by the Company subject to its General Conditions of Service printed overleaf, available on request or accessible at www.sgs.com/terms_and_conditions.htm and, for electronic format documents, subject to Terms and Conditions for Electronic Documents at www.sgs.com/terms_e-document.htm. Attention is drawn to the limitation of liability, indemnification and jurisdiction issues defined therein. Any holder of this document is advised that information contained hereon reflects the Company's findings at the time of its intervention only and within the limits of Client's instructions, if any. The Company's sole responsibility is to its Client and this document does not exonerate parties to a transaction from exercising all their rights and obligations under the transaction documents. This document cannot be reproduced except in full, without prior written approval of the Company. Any unauthorized alteration, forgery or falsification of the content or appearance of this document is unlawful and offenders may be prosecuted to the fullest extent of the law.

SGS Taiwan Ltd.

No. 134, WuKungRoad, NewTaipeiIndustrialPark, WukuDistrict, NewTaipeiCity, Taiwan24803/新北市五股區新北產業園區五工路 134 號

台灣檢驗科技股份有限公司

t (886-2) 2299-3279

f (886-2) 2298-0488

www.tw.sgs.com

Member of SGS Group

Operation Mode : 802.11g Test Date : 2017/10/19
 Fundamental Frequency : 2437 MHz Temp. / Humi. : 24.5deg_C/70RH
 Operation Band : Tx CH Mid Test Engineer : Ashton
 EUT Pol. : H Measurement Antenna Pol. : Horizontal

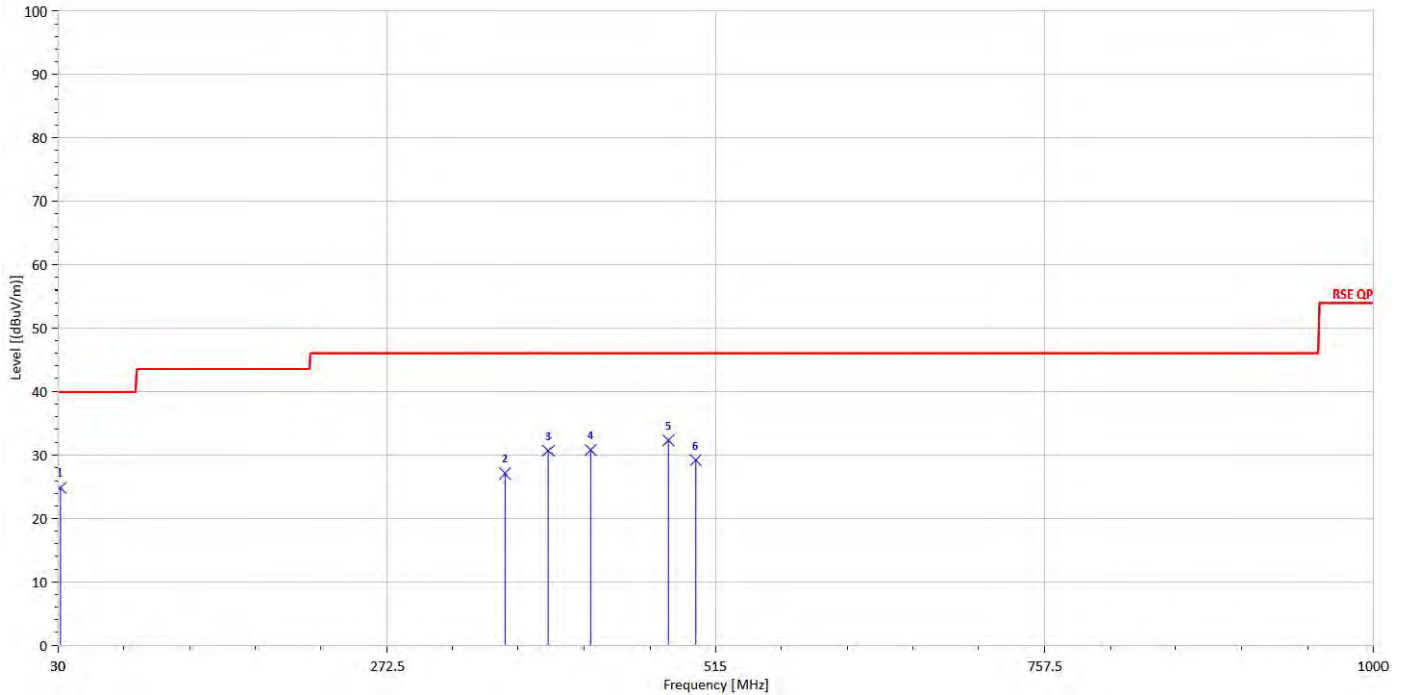

Freq. MHz	Note F/H/E/S	Detector Mode PK/QP/AV	Spectrum Reading Level dBuV	Factor dB	Actual FS dBuV/m	Limit @3m dBuV/m	Margin dB
31.94	S	Peak	33.12	-8.22	24.90	40	-15.10
359.80	S	Peak	38.29	-11.20	27.09	46	-18.91
391.81	S	Peak	40.67	-10.01	30.66	46	-15.34
422.85	S	Peak	40.12	-9.36	30.76	46	-15.24
480.08	S	Peak	40.11	-7.81	32.30	46	-13.70
500.45	S	Peak	36.67	-7.53	29.14	46	-16.86

Unless otherwise stated the results shown in this test report refer only to the sample(s) tested and such sample(s) are retained for 90 days only.

除非另有說明，此報告結果僅對測試之樣品負責，同時此樣品僅保留90天。本報告未經本公司書面許可，不可部份複製。

This document is issued by the Company subject to its General Conditions of Service printed overleaf, available on request or accessible at www.sgs.com/terms_and_conditions.htm and, for electronic format documents, subject to Terms and Conditions for Electronic Documents at www.sgs.com/terms_e-document.htm. Attention is drawn to the limitation of liability, indemnification and jurisdiction issues defined therein. Any holder of this document is advised that information contained hereon reflects the Company's findings at the time of its intervention only and within the limits of Client's instructions, if any. The Company's sole responsibility is to its Client and this document does not exonerate parties to a transaction from exercising all their rights and obligations under the transaction documents. This document cannot be reproduced except in full, without prior written approval of the Company. Any unauthorized alteration, forgery or falsification of the content or appearance of this document is unlawful and offenders may be prosecuted to the fullest extent of the law.

SGS Taiwan Ltd.

No.134,WuKungRoad,NewTaipeiIndustrialPark,WukuDistrict,NewTaipeiCity,Taiwan24803/新北市五股區新北產業園區五工路 134 號

台灣檢驗科技股份有限公司

t (886-2) 2299-3279

f (886-2) 2298-0488

www.tw.sgs.com

Member of SGS Group

Operation Mode : 802.11g Test Date : 2017/10/19
 Fundamental Frequency : 2462 MHz Temp. / Humi. : 24.5deg_C/70RH
 Operation Band : Tx CH HIGH Test Engineer : Ashton
 EUT Pol. : H Measurement Antenna Pol. : Vertical

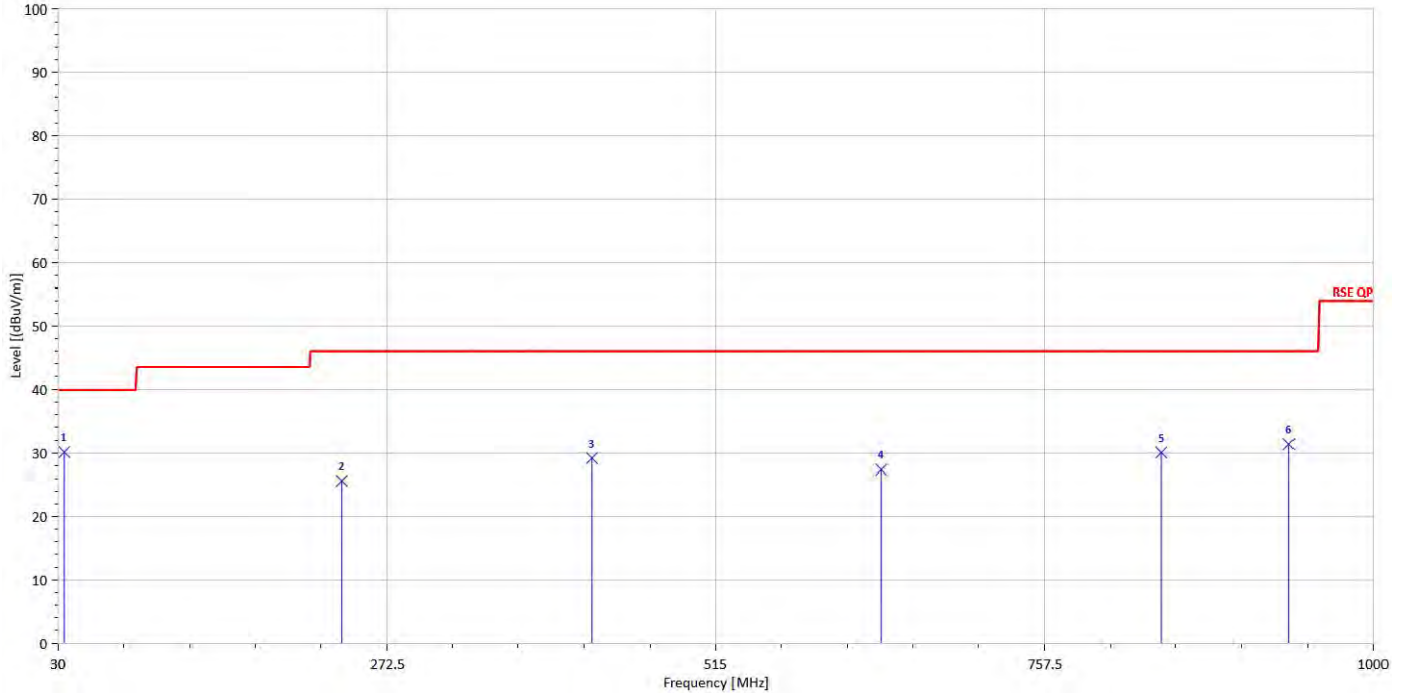

Freq. MHz	Note F/H/E/S	Detector Mode PK/QP/AV	Spectrum Reading Level dBuV	Factor dB	Actual FS dBuV/m	Limit @3m dBuV/m	Margin dB
34.85	S	Peak	39.89	-9.78	30.11	40	-9.89
239.52	S	Peak	40.93	-15.28	25.65	46	-20.35
423.82	S	Peak	38.46	-9.30	29.16	46	-16.84
637.22	S	Peak	32.45	-5.08	27.37	46	-18.63
843.83	S	Peak	32.76	-2.71	30.05	46	-15.95
937.92	S	Peak	33.08	-1.71	31.37	46	-14.63

Unless otherwise stated the results shown in this test report refer only to the sample(s) tested and such sample(s) are retained for 90 days only.

除非另有說明，此報告結果僅對測試之樣品負責，同時此樣品僅保留90天。本報告未經本公司書面許可，不可部份複製。

This document is issued by the Company subject to its General Conditions of Service printed overleaf, available on request or accessible at www.sgs.com/terms_and_conditions.htm and, for electronic format documents, subject to Terms and Conditions for Electronic Documents at www.sgs.com/terms_e-document.htm. Attention is drawn to the limitation of liability, indemnification and jurisdiction issues defined therein. Any holder of this document is advised that information contained hereon reflects the Company's findings at the time of its intervention only and within the limits of Client's instructions, if any. The Company's sole responsibility is to its Client and this document does not exonerate parties to a transaction from exercising all their rights and obligations under the transaction documents. This document cannot be reproduced except in full, without prior written approval of the Company. Any unauthorized alteration, forgery or falsification of the content or appearance of this document is unlawful and offenders may be prosecuted to the fullest extent of the law.

SGS Taiwan Ltd.

No.134,WuKungRoad,NewTaipeiIndustrialPark,WukuDistrict,NewTaipeiCity,Taiwan24803/新北市五股區新北產業園區五工路 134 號

台灣檢驗科技股份有限公司

t (886-2) 2299-3279

f (886-2) 2298-0488

www.tw.sgs.com

Member of SGS Group

Operation Mode : 802.11g Test Date : 2017/10/19
 Fundamental Frequency : 2462 MHz Temp. / Humi. : 24.5deg_C/70RH
 Operation Band : Tx CH HIGH Test Engineer : Ashton
 EUT Pol. : H Measurement Antenna Pol. : Horizontal

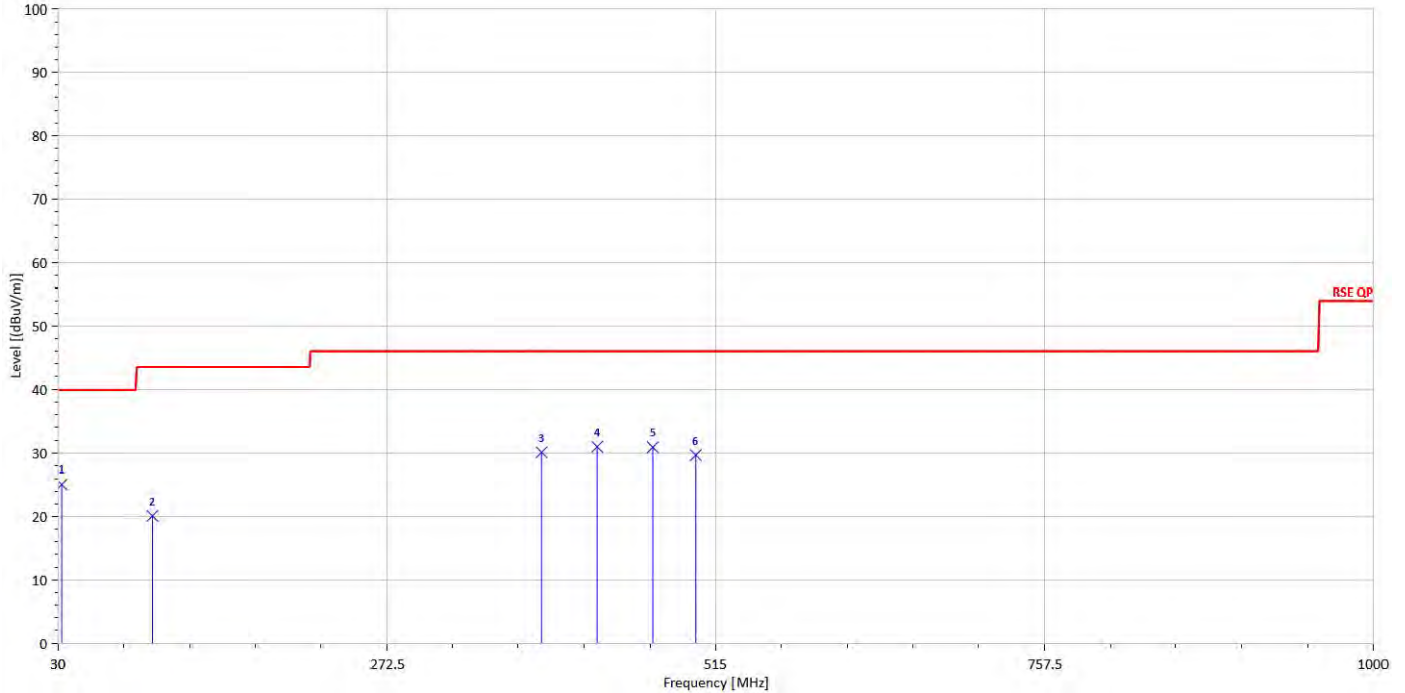

Freq. MHz	Note F/H/E/S	Detector Mode PK/QP/AV	Spectrum Reading Level dBuV	Factor dB	Actual FS dBuV/m	Limit @3m dBuV/m	Margin dB
32.91	S	Peak	33.84	-8.75	25.09	40	-14.91
99.84	S	Peak	37.87	-17.77	20.10	43.5	-23.40
386.96	S	Peak	40.23	-10.15	30.08	46	-15.92
427.70	S	Peak	40.07	-9.12	30.95	46	-15.05
468.44	S	Peak	38.53	-7.66	30.88	46	-15.12
500.45	S	Peak	37.16	-7.53	29.63	46	-16.37

Unless otherwise stated the results shown in this test report refer only to the sample(s) tested and such sample(s) are retained for 90 days only.

除非另有說明，此報告結果僅對測試之樣品負責，同時此樣品僅保留90天。本報告未經本公司書面許可，不可部份複製。

This document is issued by the Company subject to its General Conditions of Service printed overleaf, available on request or accessible at www.sgs.com/terms_and_conditions.htm and, for electronic format documents, subject to Terms and Conditions for Electronic Documents at www.sgs.com/terms_e-document.htm. Attention is drawn to the limitation of liability, indemnification and jurisdiction issues defined therein. Any holder of this document is advised that information contained hereon reflects the Company's findings at the time of its intervention only and within the limits of Client's instructions, if any. The Company's sole responsibility is to its Client and this document does not exonerate parties to a transaction from exercising all their rights and obligations under the transaction documents. This document cannot be reproduced except in full, without prior written approval of the Company. Any unauthorized alteration, forgery or falsification of the content or appearance of this document is unlawful and offenders may be prosecuted to the fullest extent of the law.

SGS Taiwan Ltd.

No.134,WuKungRoad,NewTaipeiIndustrialPark,WukuDistrict,NewTaipeiCity,Taiwan24803/新北市五股區新北產業園區五工路 134 號

台灣檢驗科技股份有限公司

t (886-2) 2299-3279

f (886-2) 2298-0488

www.tw.sgs.com

Member of SGS Group

Above 1GHz Data:

Radiated Spurious Emission Measurement Result (802.11 b)

Operation Mode :	802.11b	Test Date :	2017/10/20
Fundamental Frequency :	2412 MHz	Temp. / Humi. :	24.5deg_C/70RH
Operation Band :	TX CH LOW	Test Engineer :	Enzo
EUT Pol. :	H	Measurement Antenna Pol. :	Vertical

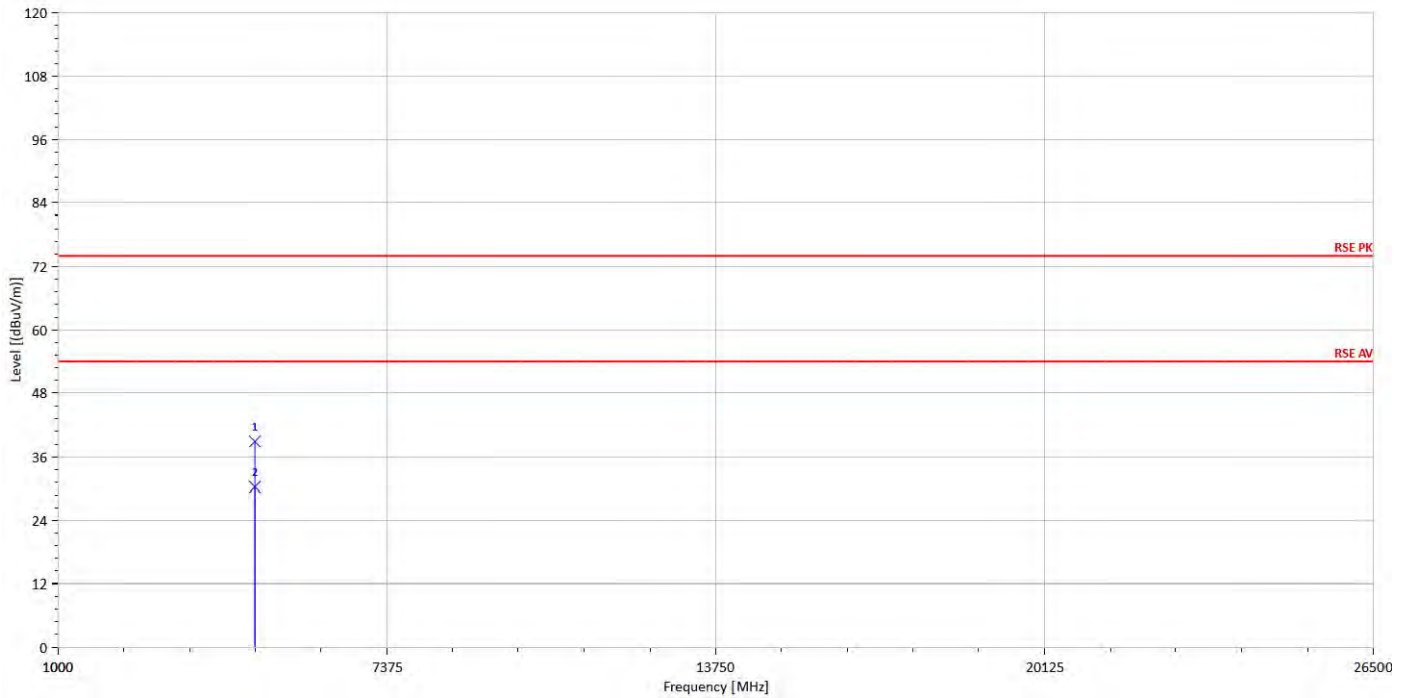

Freq. MHz	Note F/H/E/S	Detector Mode PK/QP/AV	Spectrum Reading Level dBuV	Factor dB	Actual FS dBuV/m	Limit @3m dBuV/m	Margin dB
4824.00	H	Peak	31.34	7.58	38.92	74	-35.08
4824.00	H	Average	22.71	7.58	30.29	54	-23.71

Unless otherwise stated the results shown in this test report refer only to the sample(s) tested and such sample(s) are retained for 90 days only.

除非另有說明，此報告結果僅對測試之樣品負責，同時此樣品僅保留90天。本報告未經本公司書面許可，不可部份複製。

This document is issued by the Company subject to its General Conditions of Service printed overleaf, available on request or accessible at www.sgs.com/terms_and_conditions.htm and, for electronic format documents, subject to Terms and Conditions for Electronic Documents at www.sgs.com/terms_e-document.htm. Attention is drawn to the limitation of liability, indemnification and jurisdiction issues defined therein. Any holder of this document is advised that information contained hereon reflects the Company's findings at the time of its intervention only and within the limits of Client's instructions, if any. The Company's sole responsibility is to its Client and this document does not exonerate parties to a transaction from exercising all their rights and obligations under the transaction documents. This document cannot be reproduced except in full, without prior written approval of the Company. Any unauthorized alteration, forgery or falsification of the content or appearance of this document is unlawful and offenders may be prosecuted to the fullest extent of the law.

SGS Taiwan Ltd.

No.134,WuKungRoad,NewTaipeiIndustrialPark,WukuDistrict,NewTaipeiCity,Taiwan24803/新北市五股區新北產業園區五工路 134 號

台灣檢驗科技股份有限公司

t (886-2) 2299-3279

f (886-2) 2298-0488

www.tw.sgs.com

Member of SGS Group

Operation Mode : 802.11b Test Date : 2017/10/20
 Fundamental Frequency : 2412 MHz Temp. / Humi. : 24.5deg_C/70RH
 Operation Band : TX CH LOW Test Engineer : Enzo
 EUT Pol. : H Measurement Antenna Pol. : Horizontal

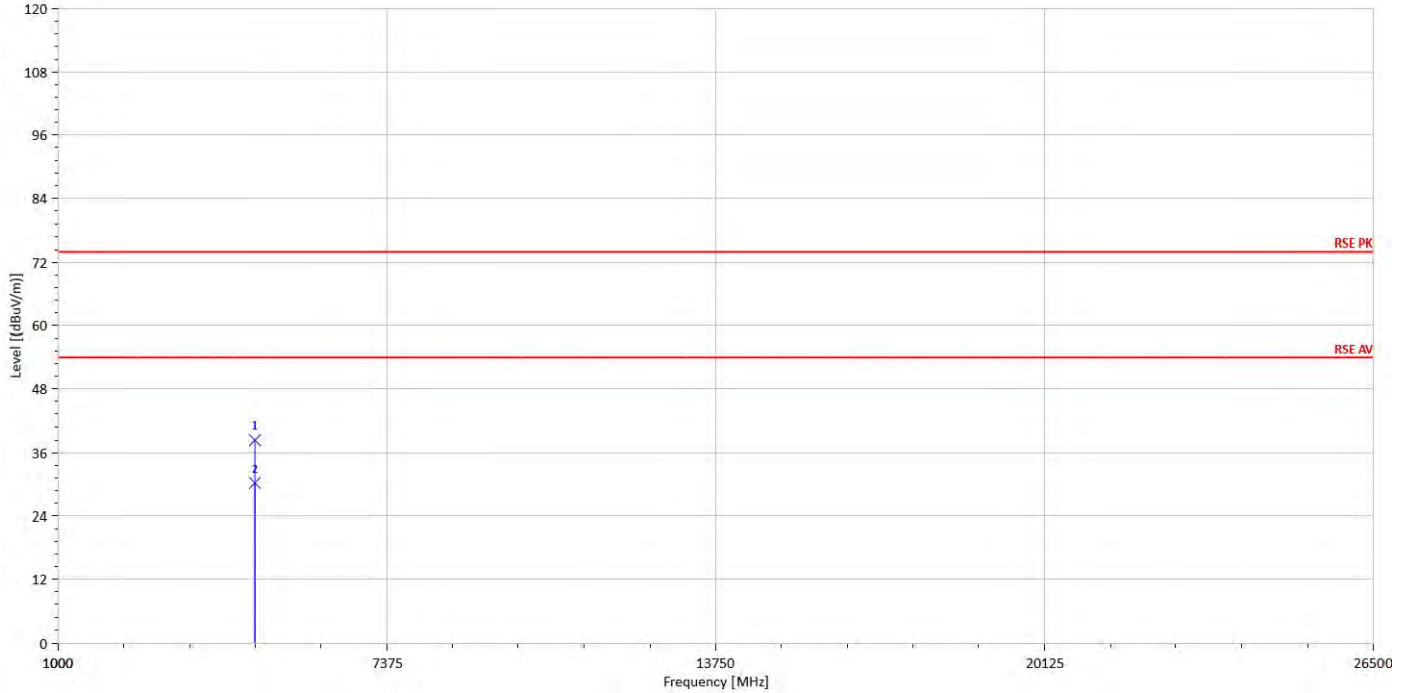

Freq. MHz	Note F/H/E/S	Detector Mode PK/QP/AV	Spectrum Reading Level dBµV	Factor dB	Actual FS dBµV/m	Limit @3m dBµV/m	Margin dB
4824.00	H	Peak	30.82	7.58	38.39	74	-35.61
4824.00	H	Average	22.65	7.58	30.23	54	-23.77

Unless otherwise stated the results shown in this test report refer only to the sample(s) tested and such sample(s) are retained for 90 days only.

除非另有說明，此報告結果僅對測試之樣品負責，同時此樣品僅保留90天。本報告未經本公司書面許可，不可部份複製。

This document is issued by the Company subject to its General Conditions of Service printed overleaf, available on request or accessible at www.sgs.com/terms_and_conditions.htm and, for electronic format documents, subject to Terms and Conditions for Electronic Documents at www.sgs.com/terms_e-document.htm. Attention is drawn to the limitation of liability, indemnification and jurisdiction issues defined therein. Any holder of this document is advised that information contained hereon reflects the Company's findings at the time of its intervention only and within the limits of Client's instructions, if any. The Company's sole responsibility is to its Client and this document does not exonerate parties to a transaction from exercising all their rights and obligations under the transaction documents. This document cannot be reproduced except in full, without prior written approval of the Company. Any unauthorized alteration, forgery or falsification of the content or appearance of this document is unlawful and offenders may be prosecuted to the fullest extent of the law.

SGS Taiwan Ltd.

No.134,WuKungRoad,NewTaipeiIndustrialPark,WukuDistrict,NewTaipeiCity,Taiwan24803/新北市五股區新北產業園區五工路 134 號

台灣檢驗科技股份有限公司

t (886-2) 2299-3279

f (886-2) 2298-0488

www.tw.sgs.com

Member of SGS Group

Operation Mode : 802.11b Test Date : 2017/10/20
 Fundamental Frequency : 2437 MHz Temp. / Humi. : 24.5deg_C/70RH
 Operation Band : TX CH MID Test Engineer : Enzo
 EUT Pol. : H Measurement Antenna Pol. : Vertical

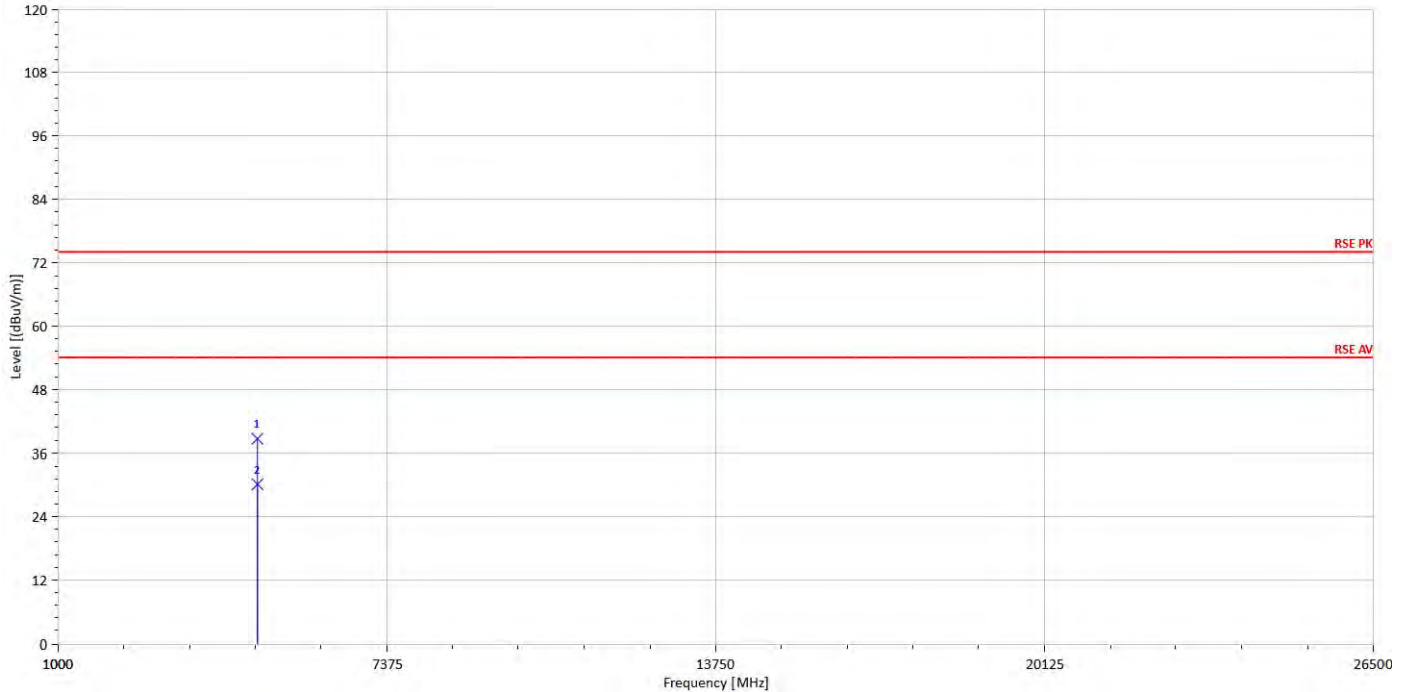

Freq. MHz	Note F/H/E/S	Detector Mode PK/QP/AV	Spectrum Reading Level dBµV	Factor dB	Actual FS dBµV/m	Limit @3m dBµV/m	Margin dB
4874.00	H	Peak	30.77	7.91	38.68	74	-35.32
4874.00	H	Average	22.25	7.91	30.16	54	-23.84

Unless otherwise stated the results shown in this test report refer only to the sample(s) tested and such sample(s) are retained for 90 days only.

除非另有說明，此報告結果僅對測試之樣品負責，同時此樣品僅保留90天。本報告未經本公司書面許可，不可部份複製。

This document is issued by the Company subject to its General Conditions of Service printed overleaf, available on request or accessible at www.sgs.com/terms_and_conditions.htm and, for electronic format documents, subject to Terms and Conditions for Electronic Documents at www.sgs.com/terms_e-document.htm. Attention is drawn to the limitation of liability, indemnification and jurisdiction issues defined therein. Any holder of this document is advised that information contained hereon reflects the Company's findings at the time of its intervention only and within the limits of Client's instructions, if any. The Company's sole responsibility is to its Client and this document does not exonerate parties to a transaction from exercising all their rights and obligations under the transaction documents. This document cannot be reproduced except in full, without prior written approval of the Company. Any unauthorized alteration, forgery or falsification of the content or appearance of this document is unlawful and offenders may be prosecuted to the fullest extent of the law.

SGS Taiwan Ltd.

No.134,WuKungRoad,NewTaipeiIndustrialPark,WukuDistrict,NewTaipeiCity,Taiwan24803/新北市五股區新北產業園區五工路 134 號

台灣檢驗科技股份有限公司

t (886-2) 2299-3279

f (886-2) 2298-0488

www.tw.sgs.com

Member of SGS Group

Operation Mode : 802.11b Test Date : 2017/10/20
 Fundamental Frequency : 2437 MHz Temp. / Humi. : 24.5deg_C/70RH
 Operation Band : TX CH MID Test Engineer : Enzo
 EUT Pol. : H Measurement Antenna Pol. : Horizontal

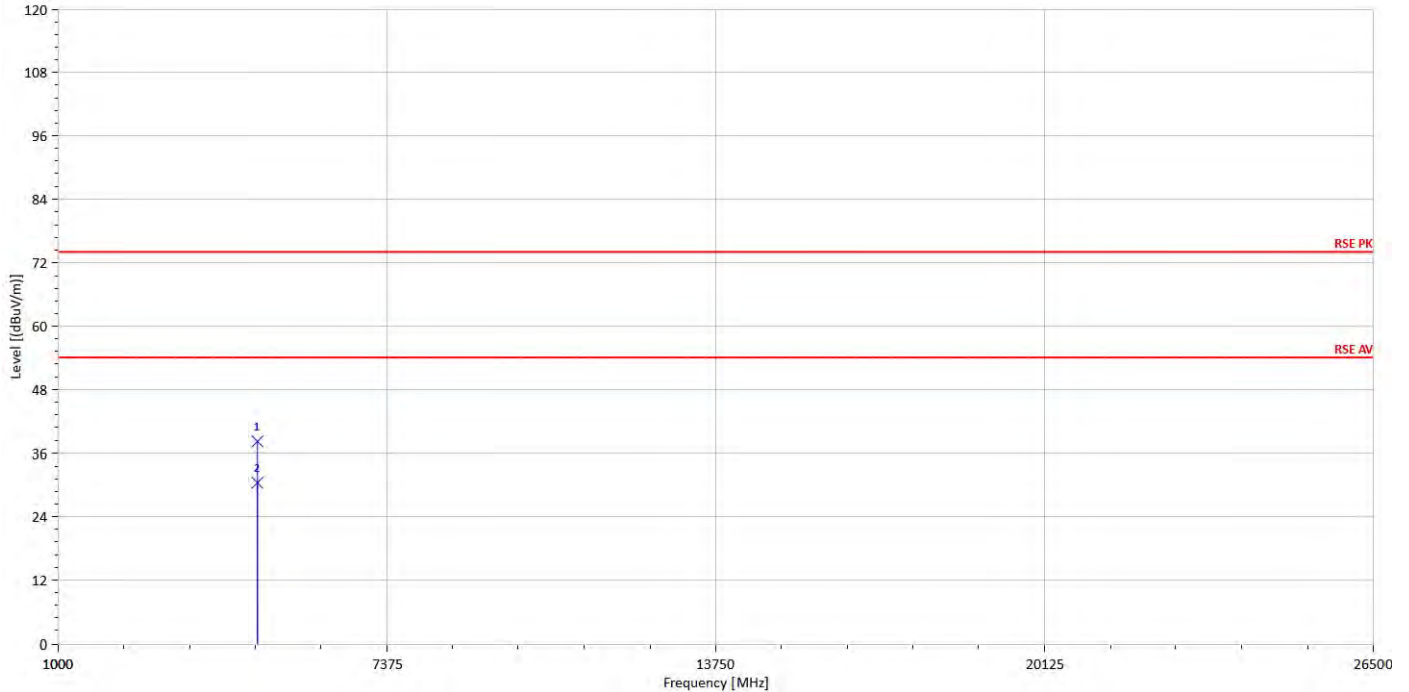

Freq. MHz	Note F/H/E/S	Detector Mode PK/QP/AV	Spectrum Reading Level dBµV	Factor dB	Actual FS dBµV/m	Limit @3m dBµV/m	Margin dB
4874.00	H	Peak	30.26	7.91	38.17	74	-35.83
4874.00	H	Average	22.54	7.91	30.45	54	-23.55

Unless otherwise stated the results shown in this test report refer only to the sample(s) tested and such sample(s) are retained for 90 days only.

除非另有說明，此報告結果僅對測試之樣品負責，同時此樣品僅保留90天。本報告未經本公司書面許可，不可部份複製。

This document is issued by the Company subject to its General Conditions of Service printed overleaf, available on request or accessible at www.sgs.com/terms_and_conditions.htm and, for electronic format documents, subject to Terms and Conditions for Electronic Documents at www.sgs.com/terms_e-document.htm. Attention is drawn to the limitation of liability, indemnification and jurisdiction issues defined therein. Any holder of this document is advised that information contained hereon reflects the Company's findings at the time of its intervention only and within the limits of Client's instructions, if any. The Company's sole responsibility is to its Client and this document does not exonerate parties to a transaction from exercising all their rights and obligations under the transaction documents. This document cannot be reproduced except in full, without prior written approval of the Company. Any unauthorized alteration, forgery or falsification of the content or appearance of this document is unlawful and offenders may be prosecuted to the fullest extent of the law.

SGS Taiwan Ltd.

No. 134, WuKungRoad, New Taipei Industrial Park, Wuku District, New Taipei City, Taiwan 24803/新北市五股區新北產業園區五工路 134 號

台灣檢驗科技股份有限公司

t (886-2) 2299-3279

f (886-2) 2298-0488

www.tw.sgs.com

Member of SGS Group

Operation Mode : 802.11b Test Date : 2017/10/20
 Fundamental Frequency : 2462 MHz Temp. / Humi. : 24.5deg_C/70RH
 Operation Band : TX CH HIGH Test Engineer : Enzo
 EUT Pol. : H Measurement Antenna Pol. : Vertical

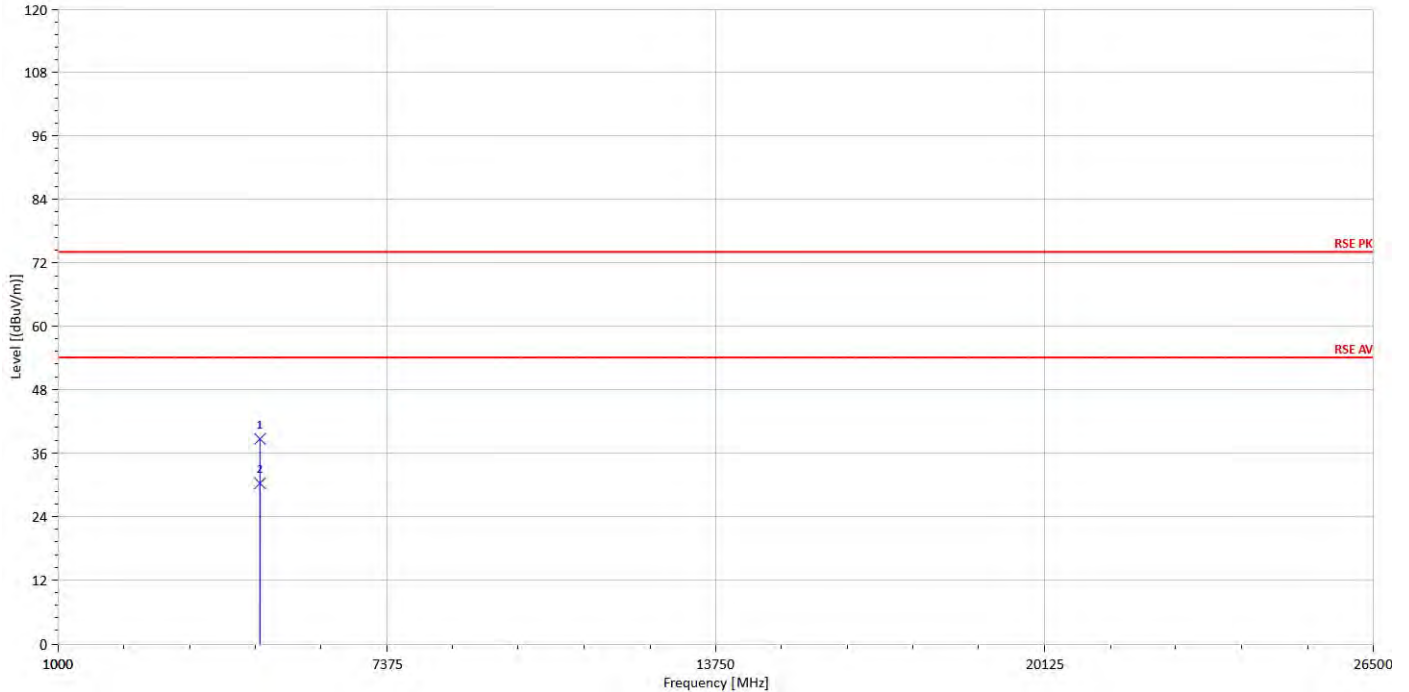

Freq. MHz	Note F/H/E/S	Detector Mode PK/QP/AV	Spectrum Reading Level dBµV	Factor dB	Actual FS dBµV/m	Limit @3m dBµV/m	Margin dB
4924.00	H	Peak	30.74	7.92	38.66	74	-35.34
4924.00	H	Average	22.43	7.92	30.35	54	-23.65

Unless otherwise stated the results shown in this test report refer only to the sample(s) tested and such sample(s) are retained for 90 days only.

除非另有說明，此報告結果僅對測試之樣品負責，同時此樣品僅保留90天。本報告未經本公司書面許可，不可部份複製。

This document is issued by the Company subject to its General Conditions of Service printed overleaf, available on request or accessible at www.sgs.com/terms_and_conditions.htm and, for electronic format documents, subject to Terms and Conditions for Electronic Documents at www.sgs.com/terms_e-document.htm. Attention is drawn to the limitation of liability, indemnification and jurisdiction issues defined therein. Any holder of this document is advised that information contained hereon reflects the Company's findings at the time of its intervention only and within the limits of Client's instructions, if any. The Company's sole responsibility is to its Client and this document does not exonerate parties to a transaction from exercising all their rights and obligations under the transaction documents. This document cannot be reproduced except in full, without prior written approval of the Company. Any unauthorized alteration, forgery or falsification of the content or appearance of this document is unlawful and offenders may be prosecuted to the fullest extent of the law.

SGS Taiwan Ltd.

No.134,WuKungRoad,NewTaipeiIndustrialPark,WukuDistrict,NewTaipeiCity,Taiwan24803/新北市五股區新北產業園區五工路 134 號

台灣檢驗科技股份有限公司

t (886-2) 2299-3279

f (886-2) 2298-0488

www.tw.sgs.com

Member of SGS Group

Operation Mode : 802.11b Test Date : 2017/10/20
 Fundamental Frequency : 2462 MHz Temp. / Humi. : 24.5deg_C/70RH
 Operation Band : TX CH HIGH Test Engineer : Enzo
 EUT Pol. : H Measurement Antenna Pol. : Horizontal

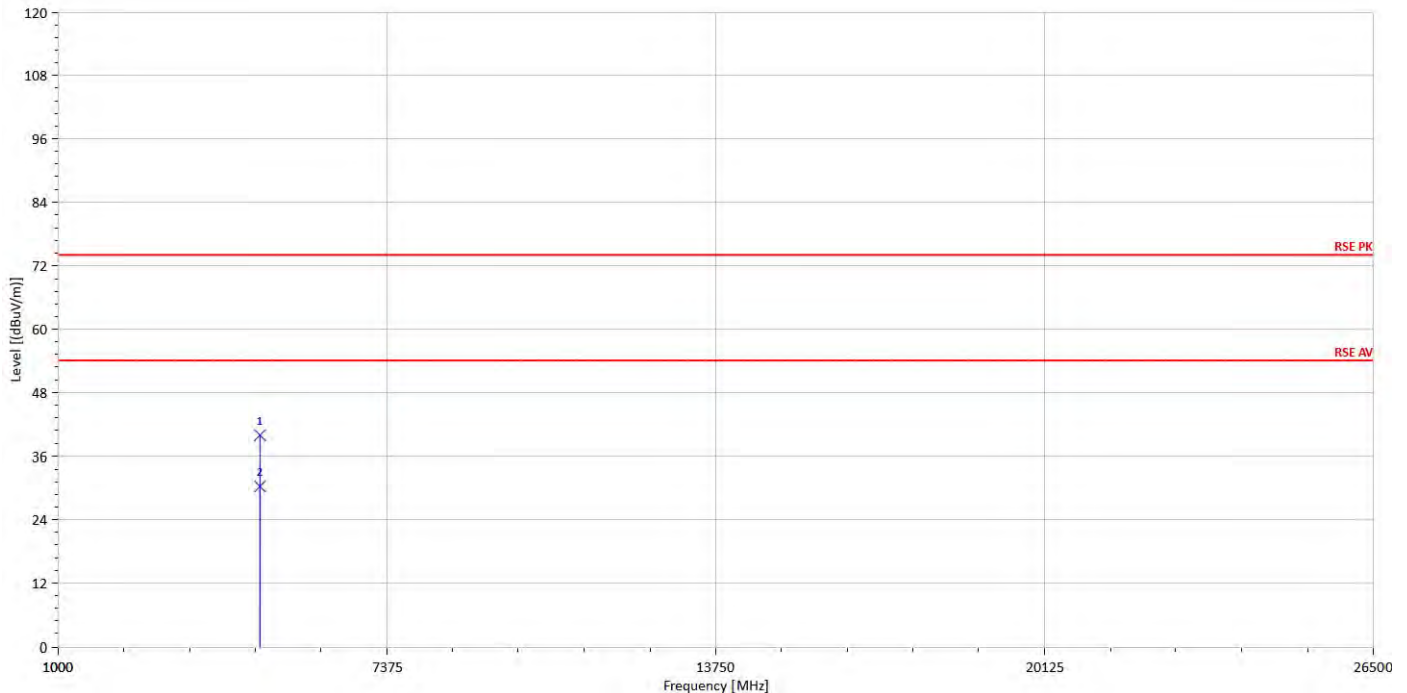

Freq. MHz	Note F/H/E/S	Detector Mode PK/QP/AV	Spectrum Reading Level dBµV	Factor dB	Actual FS dBµV/m	Limit @3m dBµV/m	Margin dB
4924.00	H	Peak	32.01	7.92	39.93	74	-34.07
4924.00	H	Average	22.41	7.92	30.33	54	-23.67

Unless otherwise stated the results shown in this test report refer only to the sample(s) tested and such sample(s) are retained for 90 days only.

除非另有說明，此報告結果僅對測試之樣品負責，同時此樣品僅保留90天。本報告未經本公司書面許可，不可部份複製。

This document is issued by the Company subject to its General Conditions of Service printed overleaf, available on request or accessible at www.sgs.com/terms_and_conditions.htm and, for electronic format documents, subject to Terms and Conditions for Electronic Documents at www.sgs.com/terms_e-document.htm. Attention is drawn to the limitation of liability, indemnification and jurisdiction issues defined therein. Any holder of this document is advised that information contained hereon reflects the Company's findings at the time of its intervention only and within the limits of Client's instructions, if any. The Company's sole responsibility is to its Client and this document does not exonerate parties to a transaction from exercising all their rights and obligations under the transaction documents. This document cannot be reproduced except in full, without prior written approval of the Company. Any unauthorized alteration, forgery or falsification of the content or appearance of this document is unlawful and offenders may be prosecuted to the fullest extent of the law.

SGS Taiwan Ltd.

No.134,WuKungRoad,NewTaipeiIndustrialPark,WukuDistrict,NewTaipeiCity,Taiwan24803/新北市五股區新北產業園區五工路 134 號

台灣檢驗科技股份有限公司

t (886-2) 2299-3279

f (886-2) 2298-0488

www.tw.sgs.com

Member of SGS Group

Radiated Spurious Emission Measurement Result (802.11 g)

Operation Mode :	802.11g	Test Date :	2017/10/20
Fundamental Frequency :	2412 MHz	Temp. / Humi. :	24.5deg_C/70RH
Operation Band :	TX CH LOW	Test Engineer :	Enzo
EUT Pol. :	H	Measurement Antenna Pol. :	Vertical

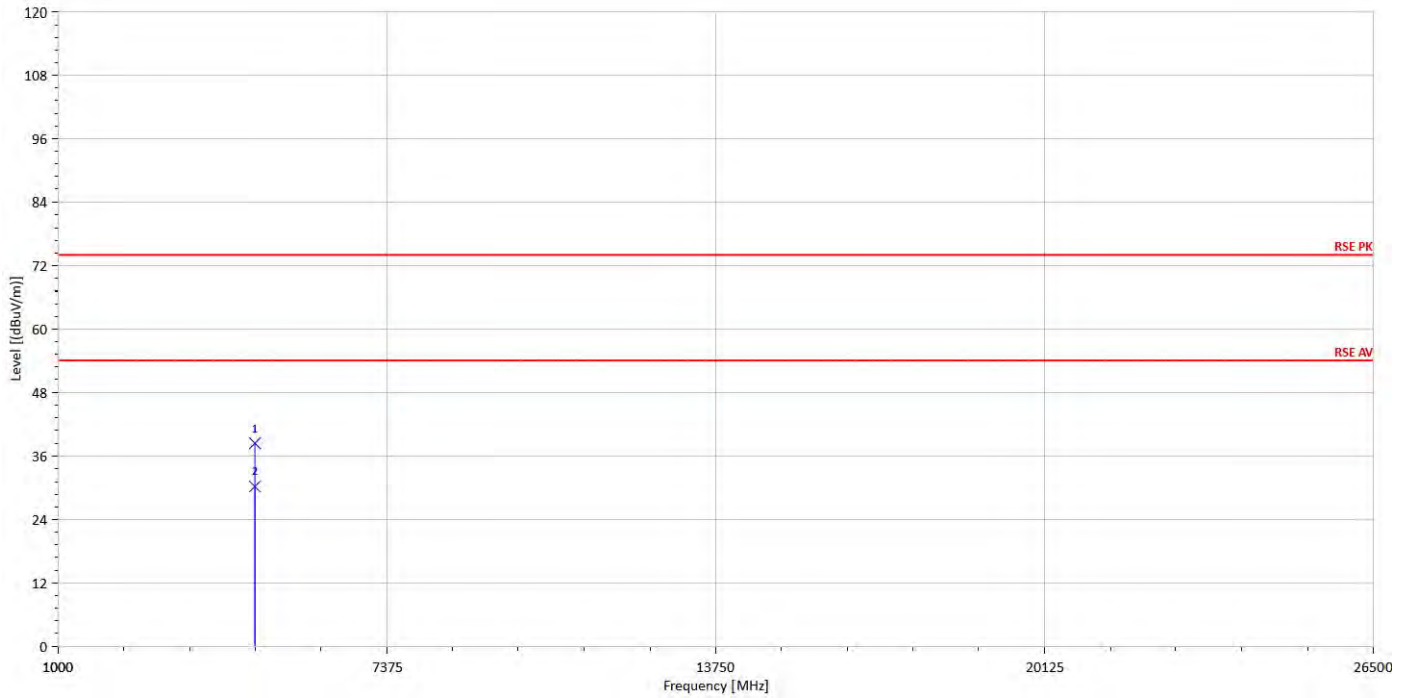

Freq. MHz	Note F/H/E/S	Detector Mode PK/QP/AV	Spectrum Reading Level dBuV	Factor dB	Actual FS dBuV/m	Limit @3m dBuV/m	Margin dB
4824.00	H	Peak	30.82	7.58	38.40	74	-35.60
4824.00	H	Average	22.73	7.58	30.31	54	-23.69

Unless otherwise stated the results shown in this test report refer only to the sample(s) tested and such sample(s) are retained for 90 days only.

除非另有說明，此報告結果僅對測試之樣品負責，同時此樣品僅保留90天。本報告未經本公司書面許可，不可部份複製。

This document is issued by the Company subject to its General Conditions of Service printed overleaf, available on request or accessible at www.sgs.com/terms_and_conditions.htm and, for electronic format documents, subject to Terms and Conditions for Electronic Documents at www.sgs.com/terms_e-document.htm. Attention is drawn to the limitation of liability, indemnification and jurisdiction issues defined therein. Any holder of this document is advised that information contained hereon reflects the Company's findings at the time of its intervention only and within the limits of Client's instructions, if any. The Company's sole responsibility is to its Client and this document does not exonerate parties to a transaction from exercising all their rights and obligations under the transaction documents. This document cannot be reproduced except in full, without prior written approval of the Company. Any unauthorized alteration, forgery or falsification of the content or appearance of this document is unlawful and offenders may be prosecuted to the fullest extent of the law.

SGS Taiwan Ltd.

No.134,WuKungRoad,NewTaipeiIndustrialPark,WukuDistrict,NewTaipeiCity,Taiwan24803/新北市五股區新北產業園區五工路 134 號

台灣檢驗科技股份有限公司

t (886-2) 2299-3279

f (886-2) 2298-0488

www.tw.sgs.com

Member of SGS Group

Operation Mode : 802.11g Test Date : 2017/10/20
 Fundamental Frequency : 2412 MHz Temp. / Humi. : 24.5deg_C/70RH
 Operation Band : TX CH LOW Test Engineer : Enzo
 EUT Pol. : H Measurement Antenna Pol. : Horizontal

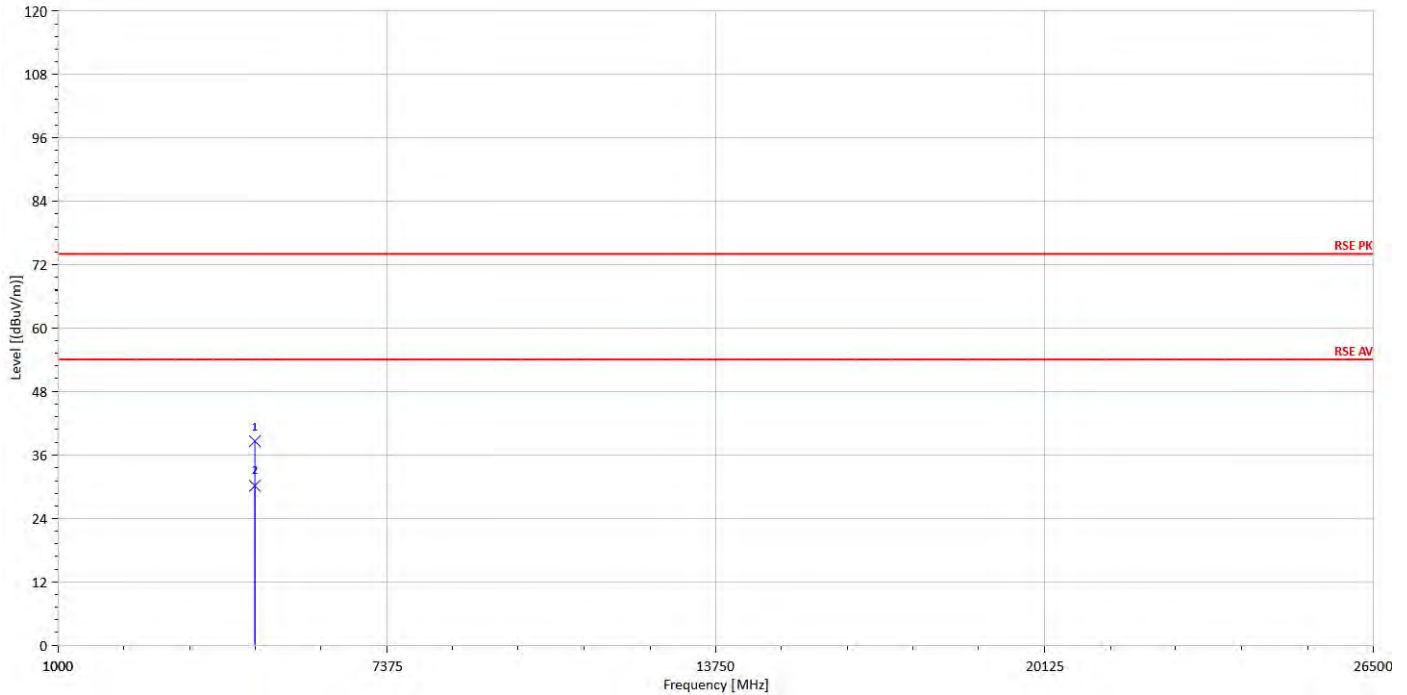

Freq. MHz	Note F/H/E/S	Detector Mode PK/QP/AV	Spectrum Reading Level dBuV	Factor dB	Actual FS dBuV/m	Limit @3m dBuV/m	Margin dB
4824.00	H	Peak	31.01	7.58	38.58	74	-35.42
4824.00	H	Average	22.68	7.58	30.26	54	-23.74

Unless otherwise stated the results shown in this test report refer only to the sample(s) tested and such sample(s) are retained for 90 days only.

除非另有說明，此報告結果僅對測試之樣品負責，同時此樣品僅保留90天。本報告未經本公司書面許可，不可部份複製。

This document is issued by the Company subject to its General Conditions of Service printed overleaf, available on request or accessible at www.sgs.com/terms_and_conditions.htm and, for electronic format documents, subject to Terms and Conditions for Electronic Documents at www.sgs.com/terms_e-document.htm. Attention is drawn to the limitation of liability, indemnification and jurisdiction issues defined therein. Any holder of this document is advised that information contained hereon reflects the Company's findings at the time of its intervention only and within the limits of Client's instructions, if any. The Company's sole responsibility is to its Client and this document does not exonerate parties to a transaction from exercising all their rights and obligations under the transaction documents. This document cannot be reproduced except in full, without prior written approval of the Company. Any unauthorized alteration, forgery or falsification of the content or appearance of this document is unlawful and offenders may be prosecuted to the fullest extent of the law.

SGS Taiwan Ltd.

No.134,WuKungRoad,NewTaipeiIndustrialPark,WukuDistrict,NewTaipeiCity,Taiwan24803/新北市五股區新北產業園區五工路 134 號

台灣檢驗科技股份有限公司

t (886-2) 2299-3279

f (886-2) 2298-0488

www.tw.sgs.com

Member of SGS Group

Operation Mode : 802.11g Test Date : 2017/10/20
 Fundamental Frequency : 2437 MHz Temp. / Humi. : 24.5deg_C/70RH
 Operation Band : TX CH MID Test Engineer : Enzo
 EUT Pol. : H Measurement Antenna Pol. : Vertical

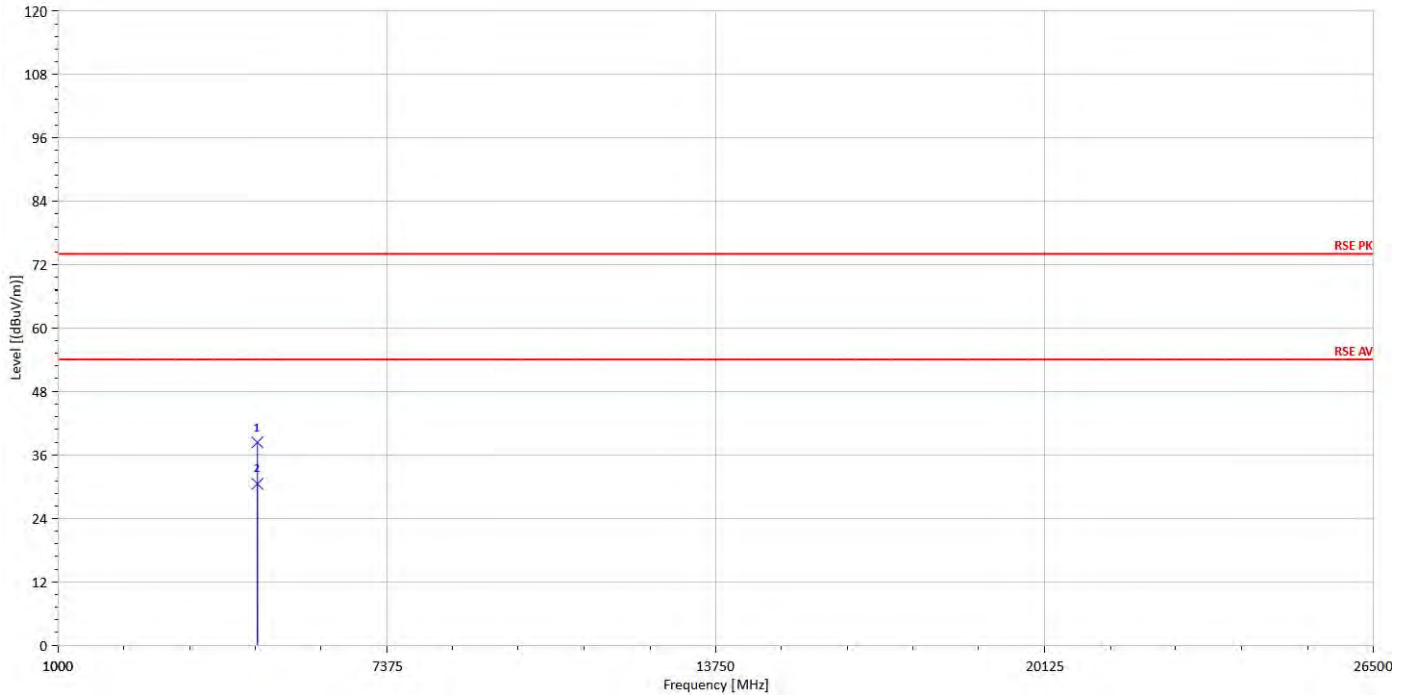

Freq. MHz	Note F/H/E/S	Detector Mode PK/QP/AV	Spectrum Reading Level dBuV	Factor dB	Actual FS dBuV/m	Limit @3m dBuV/m	Margin dB
4874.00	H	Peak	30.46	7.91	38.37	74	-35.63
4874.00	H	Average	22.72	7.91	30.63	54	-23.37

Unless otherwise stated the results shown in this test report refer only to the sample(s) tested and such sample(s) are retained for 90 days only.

除非另有說明，此報告結果僅對測試之樣品負責，同時此樣品僅保留90天。本報告未經本公司書面許可，不可部份複製。

This document is issued by the Company subject to its General Conditions of Service printed overleaf, available on request or accessible at www.sgs.com/terms_and_conditions.htm and, for electronic format documents, subject to Terms and Conditions for Electronic Documents at www.sgs.com/terms_e-document.htm. Attention is drawn to the limitation of liability, indemnification and jurisdiction issues defined therein. Any holder of this document is advised that information contained hereon reflects the Company's findings at the time of its intervention only and within the limits of Client's instructions, if any. The Company's sole responsibility is to its Client and this document does not exonerate parties to a transaction from exercising all their rights and obligations under the transaction documents. This document cannot be reproduced except in full, without prior written approval of the Company. Any unauthorized alteration, forgery or falsification of the content or appearance of this document is unlawful and offenders may be prosecuted to the fullest extent of the law.

SGS Taiwan Ltd.

No. 134, WuKungRoad, NewTaipeiIndustrialPark, WukuDistrict, NewTaipeiCity, Taiwan24803/新北市五股區新北產業園區五工路 134 號

台灣檢驗科技股份有限公司

t (886-2) 2299-3279

f (886-2) 2298-0488

www.tw.sgs.com

Member of SGS Group

Operation Mode : 802.11g Test Date : 2017/10/20
 Fundamental Frequency : 2437 MHz Temp. / Humi. : 24.5deg_C/70RH
 Operation Band : TX CH MID Test Engineer : Enzo
 EUT Pol. : H Measurement Antenna Pol. : Horizontal

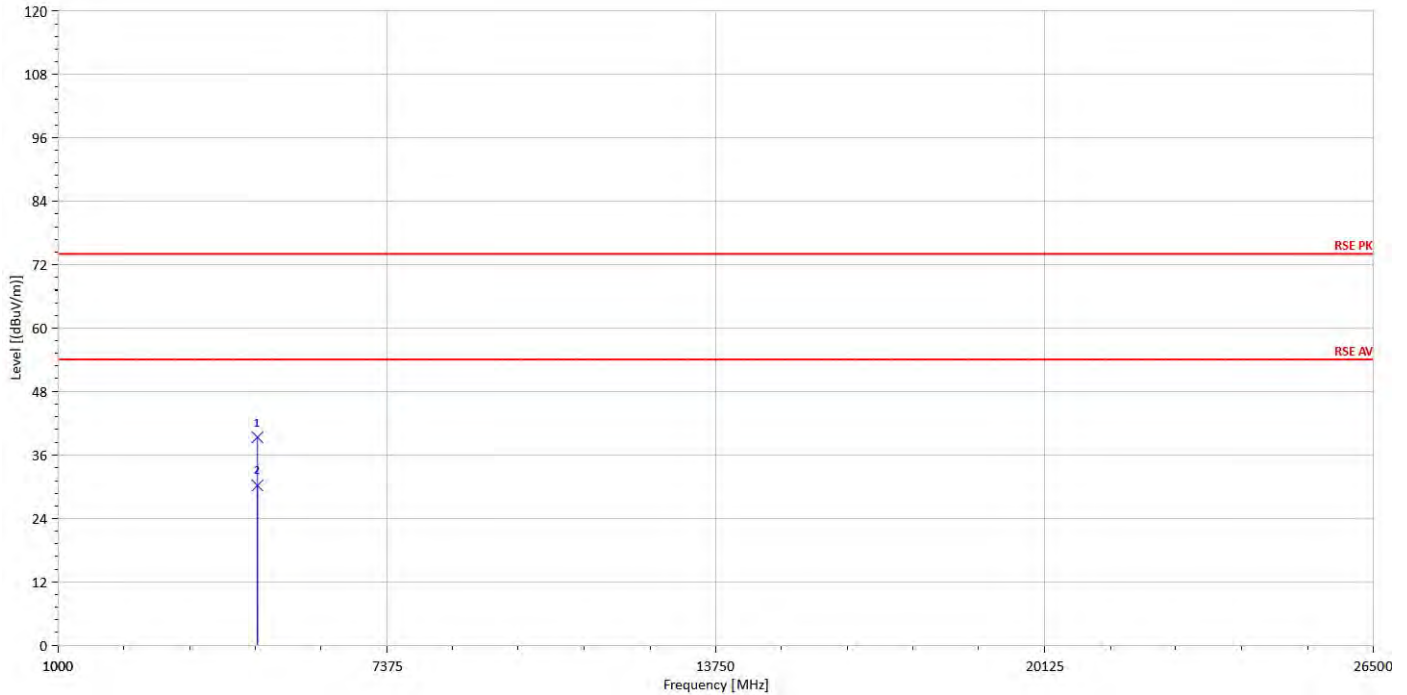

Freq. MHz	Note F/H/E/S	Detector Mode PK/QP/AV	Spectrum Reading Level dBuV	Factor dB	Actual FS dBuV/m	Limit @3m dBuV/m	Margin dB
4874.00	H	Peak	31.43	7.91	39.34	74	-34.66
4874.00	H	Average	22.39	7.91	30.30	54	-23.70

Unless otherwise stated the results shown in this test report refer only to the sample(s) tested and such sample(s) are retained for 90 days only.

除非另有說明，此報告結果僅對測試之樣品負責，同時此樣品僅保留90天。本報告未經本公司書面許可，不可部份複製。

This document is issued by the Company subject to its General Conditions of Service printed overleaf, available on request or accessible at www.sgs.com/terms_and_conditions.htm and, for electronic format documents, subject to Terms and Conditions for Electronic Documents at www.sgs.com/terms_e-document.htm. Attention is drawn to the limitation of liability, indemnification and jurisdiction issues defined therein. Any holder of this document is advised that information contained hereon reflects the Company's findings at the time of its intervention only and within the limits of Client's instructions, if any. The Company's sole responsibility is to its Client and this document does not exonerate parties to a transaction from exercising all their rights and obligations under the transaction documents. This document cannot be reproduced except in full, without prior written approval of the Company. Any unauthorized alteration, forgery or falsification of the content or appearance of this document is unlawful and offenders may be prosecuted to the fullest extent of the law.

SGS Taiwan Ltd.

No.134,WuKungRoad,NewTaipeiIndustrialPark,WukuDistrict,NewTaipeiCity,Taiwan24803/新北市五股區新北產業園區五工路 134 號

台灣檢驗科技股份有限公司

t (886-2) 2299-3279

f (886-2) 2298-0488

www.tw.sgs.com

Member of SGS Group

Operation Mode : 802.11g Test Date : 2017/10/20
 Fundamental Frequency : 2462 MHz Temp. / Humi. : 24.5deg_C/70RH
 Operation Band : TX CH HIGH Test Engineer : Enzo
 EUT Pol. : H Measurement Antenna Pol. : Vertical

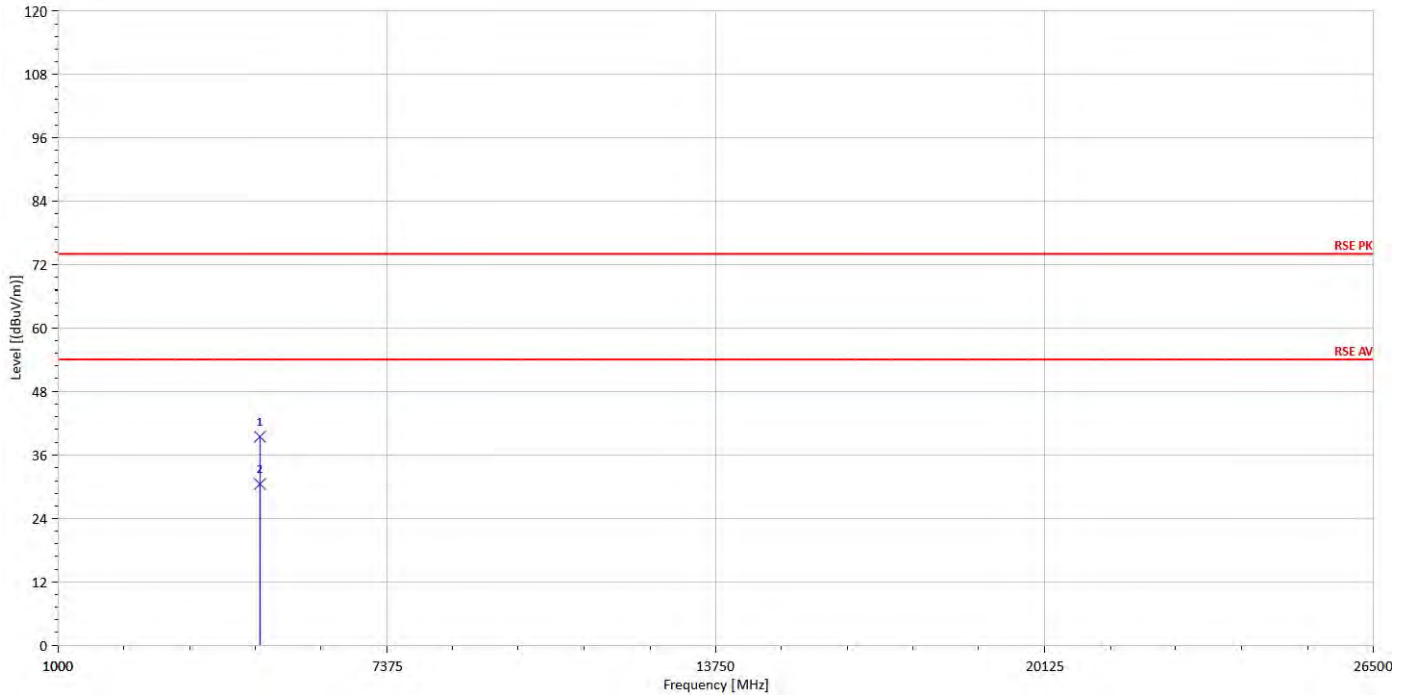

Freq. MHz	Note F/H/E/S	Detector Mode PK/QP/AV	Spectrum Reading Level dBuV	Factor dB	Actual FS dBuV/m	Limit @3m dBuV/m	Margin dB
4924.00	H	Peak	31.53	7.92	39.45	74	-34.55
4924.00	H	Average	22.67	7.92	30.59	54	-23.41

Unless otherwise stated the results shown in this test report refer only to the sample(s) tested and such sample(s) are retained for 90 days only.

除非另有說明，此報告結果僅對測試之樣品負責，同時此樣品僅保留90天。本報告未經本公司書面許可，不可部份複製。

This document is issued by the Company subject to its General Conditions of Service printed overleaf, available on request or accessible at www.sgs.com/terms_and_conditions.htm and, for electronic format documents, subject to Terms and Conditions for Electronic Documents at www.sgs.com/terms_e-document.htm. Attention is drawn to the limitation of liability, indemnification and jurisdiction issues defined therein. Any holder of this document is advised that information contained hereon reflects the Company's findings at the time of its intervention only and within the limits of Client's instructions, if any. The Company's sole responsibility is to its Client and this document does not exonerate parties to a transaction from exercising all their rights and obligations under the transaction documents. This document cannot be reproduced except in full, without prior written approval of the Company. Any unauthorized alteration, forgery or falsification of the content or appearance of this document is unlawful and offenders may be prosecuted to the fullest extent of the law.

SGS Taiwan Ltd.

No.134,WuKungRoad,NewTaipeiIndustrialPark,WukuDistrict,NewTaipeiCity,Taiwan24803/新北市五股區新北產業園區五工路 134 號

台灣檢驗科技股份有限公司

t (886-2) 2299-3279

f (886-2) 2298-0488

www.tw.sgs.com

Member of SGS Group

Operation Mode : 802.11g Test Date : 2017/10/20
 Fundamental Frequency : 2462 MHz Temp. / Humi. : 24.5deg_C/70RH
 Operation Band : TX CH HIGH Test Engineer : Enzo
 EUT Pol. : H Measurement Antenna Pol. : Horizontal

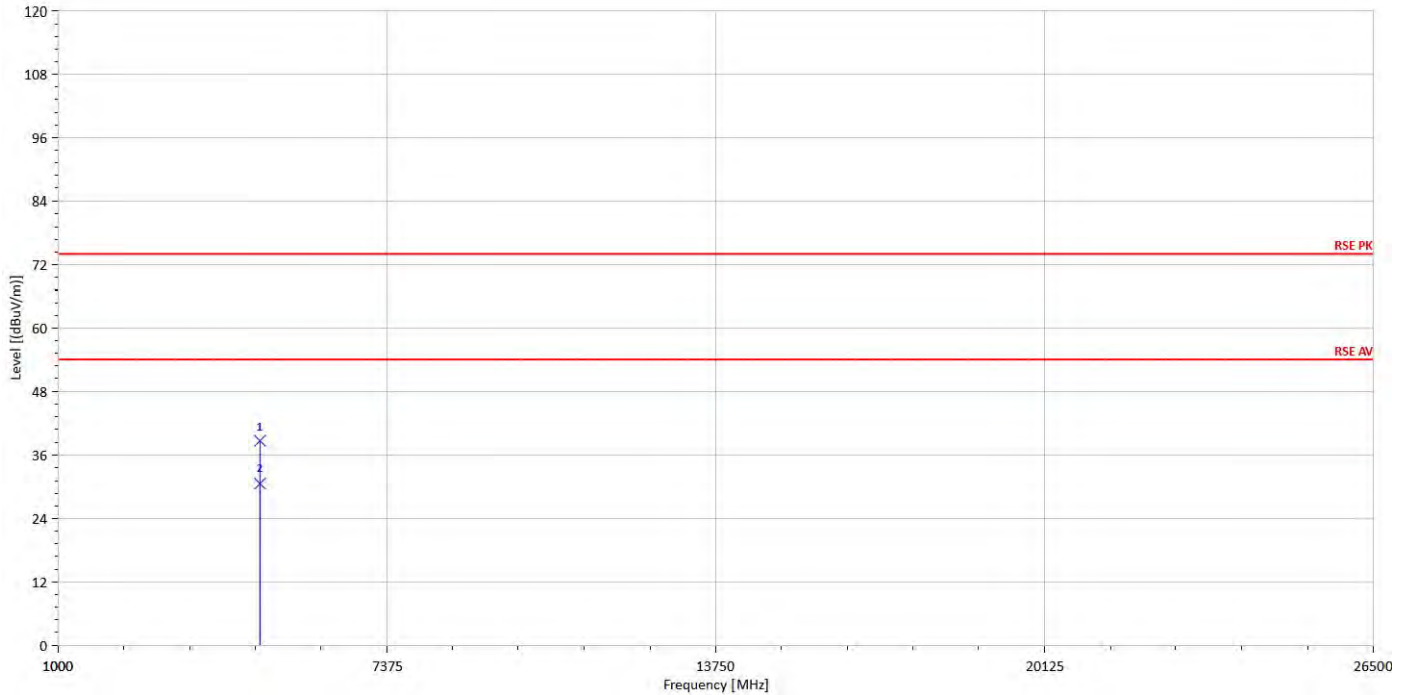

Freq. MHz	Note F/H/E/S	Detector Mode PK/QP/AV	Spectrum Reading Level dBuV	Factor dB	Actual FS dBuV/m	Limit @3m dBuV/m	Margin dB
4924.00	H	Peak	30.76	7.92	38.68	74	-35.32
4924.00	H	Average	22.76	7.92	30.68	54	-23.32

Unless otherwise stated the results shown in this test report refer only to the sample(s) tested and such sample(s) are retained for 90 days only.

除非另有說明，此報告結果僅對測試之樣品負責，同時此樣品僅保留90天。本報告未經本公司書面許可，不可部份複製。

This document is issued by the Company subject to its General Conditions of Service printed overleaf, available on request or accessible at www.sgs.com/terms_and_conditions.htm and, for electronic format documents, subject to Terms and Conditions for Electronic Documents at www.sgs.com/terms_e-document.htm. Attention is drawn to the limitation of liability, indemnification and jurisdiction issues defined therein. Any holder of this document is advised that information contained hereon reflects the Company's findings at the time of its intervention only and within the limits of Client's instructions, if any. The Company's sole responsibility is to its Client and this document does not exonerate parties to a transaction from exercising all their rights and obligations under the transaction documents. This document cannot be reproduced except in full, without prior written approval of the Company. Any unauthorized alteration, forgery or falsification of the content or appearance of this document is unlawful and offenders may be prosecuted to the fullest extent of the law.

SGS Taiwan Ltd.

No.134,WuKungRoad,NewTaipeiIndustrialPark,WukuDistrict,NewTaipeiCity,Taiwan24803/新北市五股區新北產業園區五工路 134 號

台灣檢驗科技股份有限公司

t (886-2) 2299-3279

f (886-2) 2298-0488

www.tw.sgs.com

Member of SGS Group

Radiated Spurious Emission Measurement Result (802.11_HT20)

Operation Mode :	802.11n20	Test Date :	2017/10/20
Fundamental Frequency :	2412 MHz	Temp. / Humi. :	24.5deg_C/70RH
Operation Band :	TX CH LOW	Test Engineer :	Enzo
EUT Pol. :	H	Measurement Antenna Pol. :	Vertical

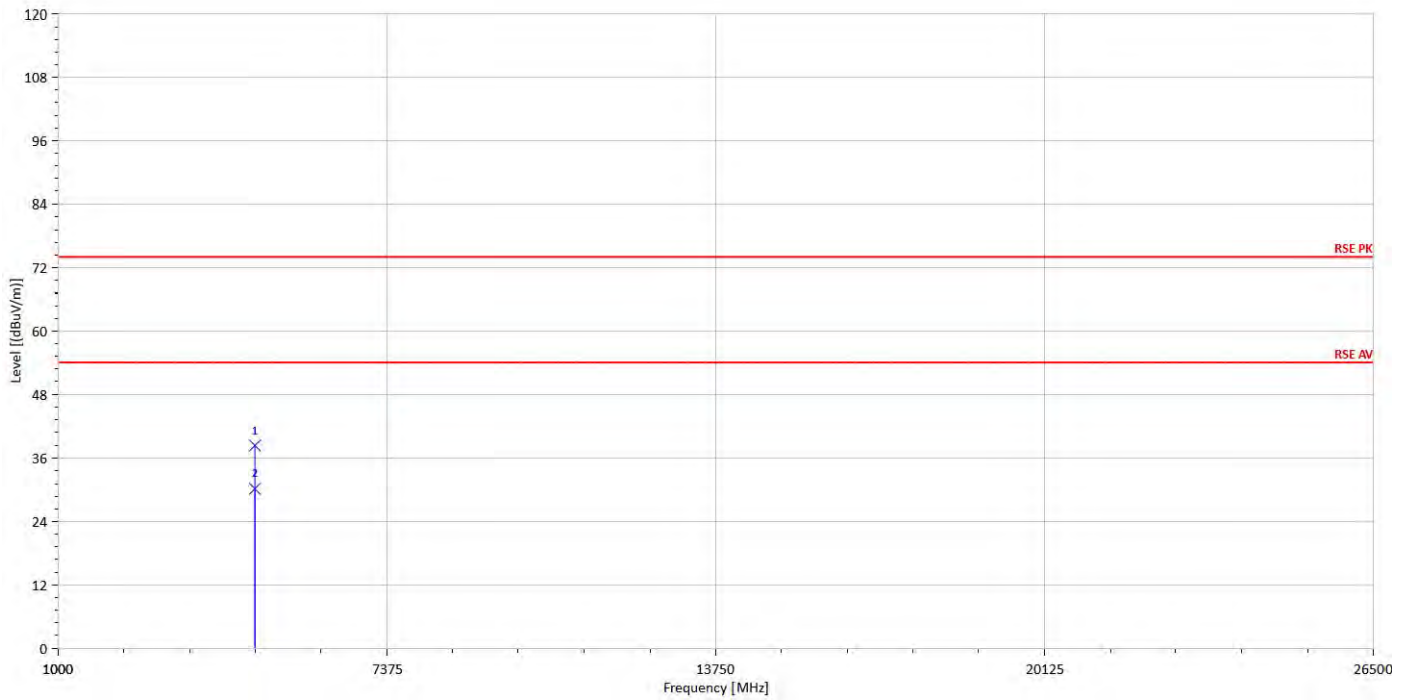

Freq. MHz	Note F/H/E/S	Detector Mode PK/QP/AV	Spectrum Reading Level dBuV	Factor dB	Actual FS dBuV/m	Limit @3m dBuV/m	Margin dB
4824.00	H	Peak	30.77	7.58	38.34	74	-35.66
4824.00	H	Average	22.67	7.58	30.25	54	-23.75

Unless otherwise stated the results shown in this test report refer only to the sample(s) tested and such sample(s) are retained for 90 days only.

除非另有說明，此報告結果僅對測試之樣品負責，同時此樣品僅保留90天。本報告未經本公司書面許可，不可部份複製。

This document is issued by the Company subject to its General Conditions of Service printed overleaf, available on request or accessible at www.sgs.com/terms_and_conditions.htm and, for electronic format documents, subject to Terms and Conditions for Electronic Documents at www.sgs.com/terms_e-document.htm. Attention is drawn to the limitation of liability, indemnification and jurisdiction issues defined therein. Any holder of this document is advised that information contained hereon reflects the Company's findings at the time of its intervention only and within the limits of Client's instructions, if any. The Company's sole responsibility is to its Client and this document does not exonerate parties to a transaction from exercising all their rights and obligations under the transaction documents. This document cannot be reproduced except in full, without prior written approval of the Company. Any unauthorized alteration, forgery or falsification of the content or appearance of this document is unlawful and offenders may be prosecuted to the fullest extent of the law.

SGS Taiwan Ltd.

No.134,WuKungRoad,NewTaipeiIndustrialPark,WukuDistrict,NewTaipeiCity,Taiwan24803/新北市五股區新北產業園區五工路 134 號

台灣檢驗科技股份有限公司

t (886-2) 2299-3279

f (886-2) 2298-0488

www.tw.sgs.com

Member of SGS Group

Operation Mode : 802.11n20 Test Date : 2017/10/20
 Fundamental Frequency : 2412 MHz Temp. / Humi. : 24.5deg_C/70RH
 Operation Band : TX CH LOW Test Engineer : Enzo
 EUT Pol. : H Measurement Antenna Pol. : Horizontal

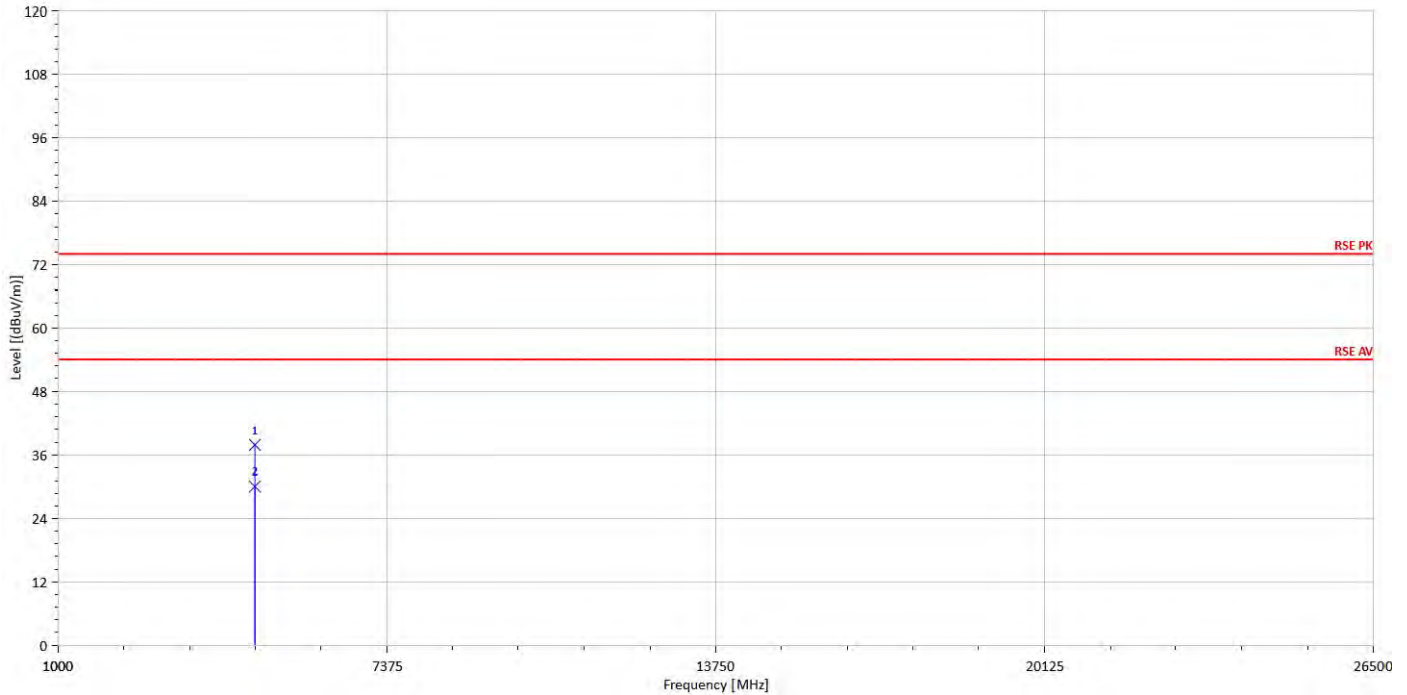

Freq. MHz	Note F/H/E/S	Detector Mode PK/QP/AV	Spectrum Reading Level dBuV	Factor dB	Actual FS dBuV/m	Limit @3m dBuV/m	Margin dB
4824.00	H	Peak	30.32	7.58	37.89	74	-36.11
4824.00	H	Average	22.53	7.58	30.11	54	-23.89

Unless otherwise stated the results shown in this test report refer only to the sample(s) tested and such sample(s) are retained for 90 days only.

除非另有說明，此報告結果僅對測試之樣品負責，同時此樣品僅保留90天。本報告未經本公司書面許可，不可部份複製。

This document is issued by the Company subject to its General Conditions of Service printed overleaf, available on request or accessible at www.sgs.com/terms_and_conditions.htm and, for electronic format documents, subject to Terms and Conditions for Electronic Documents at www.sgs.com/terms_e-document.htm. Attention is drawn to the limitation of liability, indemnification and jurisdiction issues defined therein. Any holder of this document is advised that information contained hereon reflects the Company's findings at the time of its intervention only and within the limits of Client's instructions, if any. The Company's sole responsibility is to its Client and this document does not exonerate parties to a transaction from exercising all their rights and obligations under the transaction documents. This document cannot be reproduced except in full, without prior written approval of the Company. Any unauthorized alteration, forgery or falsification of the content or appearance of this document is unlawful and offenders may be prosecuted to the fullest extent of the law.

SGS Taiwan Ltd.

No.134,WuKungRoad,NewTaipeiIndustrialPark,WukuDistrict,NewTaipeiCity,Taiwan24803/新北市五股區新北產業園區五工路 134 號

台灣檢驗科技股份有限公司

t (886-2) 2299-3279

f (886-2) 2298-0488

www.tw.sgs.com

Member of SGS Group

Operation Mode : 802.11n20 Test Date : 2017/10/20
 Fundamental Frequency : 2437 MHz Temp. / Humi. : 24.5deg_C/70RH
 Operation Band : TX CH MID Test Engineer : Enzo
 EUT Pol. : H Measurement Antenna Pol. : Vertical

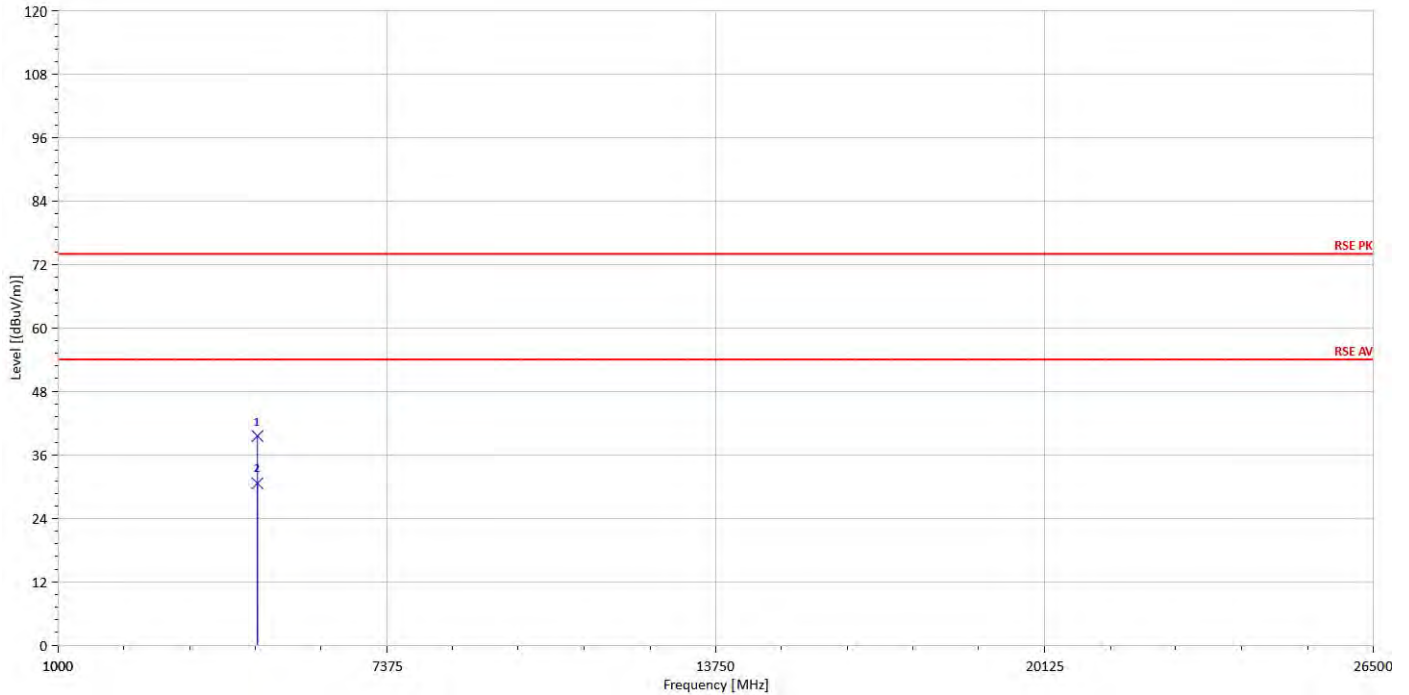

Freq. MHz	Note F/H/E/S	Detector Mode PK/QP/AV	Spectrum Reading Level dBuV	Factor dB	Actual FS dBuV/m	Limit @3m dBuV/m	Margin dB
4874.00	H	Peak	31.67	7.91	39.58	74	-34.42
4874.00	H	Average	22.81	7.91	30.72	54	-23.28

Unless otherwise stated the results shown in this test report refer only to the sample(s) tested and such sample(s) are retained for 90 days only.

除非另有說明，此報告結果僅對測試之樣品負責，同時此樣品僅保留90天。本報告未經本公司書面許可，不可部份複製。

This document is issued by the Company subject to its General Conditions of Service printed overleaf, available on request or accessible at www.sgs.com/terms_and_conditions.htm and, for electronic format documents, subject to Terms and Conditions for Electronic Documents at www.sgs.com/terms_e-document.htm. Attention is drawn to the limitation of liability, indemnification and jurisdiction issues defined therein. Any holder of this document is advised that information contained hereon reflects the Company's findings at the time of its intervention only and within the limits of Client's instructions, if any. The Company's sole responsibility is to its Client and this document does not exonerate parties to a transaction from exercising all their rights and obligations under the transaction documents. This document cannot be reproduced except in full, without prior written approval of the Company. Any unauthorized alteration, forgery or falsification of the content or appearance of this document is unlawful and offenders may be prosecuted to the fullest extent of the law.

SGS Taiwan Ltd.

No. 134, WuKungRoad, NewTaipeiIndustrialPark, WukuDistrict, NewTaipeiCity, Taiwan24803/新北市五股區新北產業園區五工路 134 號

台灣檢驗科技股份有限公司

t (886-2) 2299-3279

f (886-2) 2298-0488

www.tw.sgs.com

Member of SGS Group

Operation Mode : 802.11n20 Test Date : 2017/10/20
 Fundamental Frequency : 2437 MHz Temp. / Humi. : 24.5deg_C/70RH
 Operation Band : TX CH MID Test Engineer : Enzo
 EUT Pol. : H Measurement Antenna Pol. : Horizontal

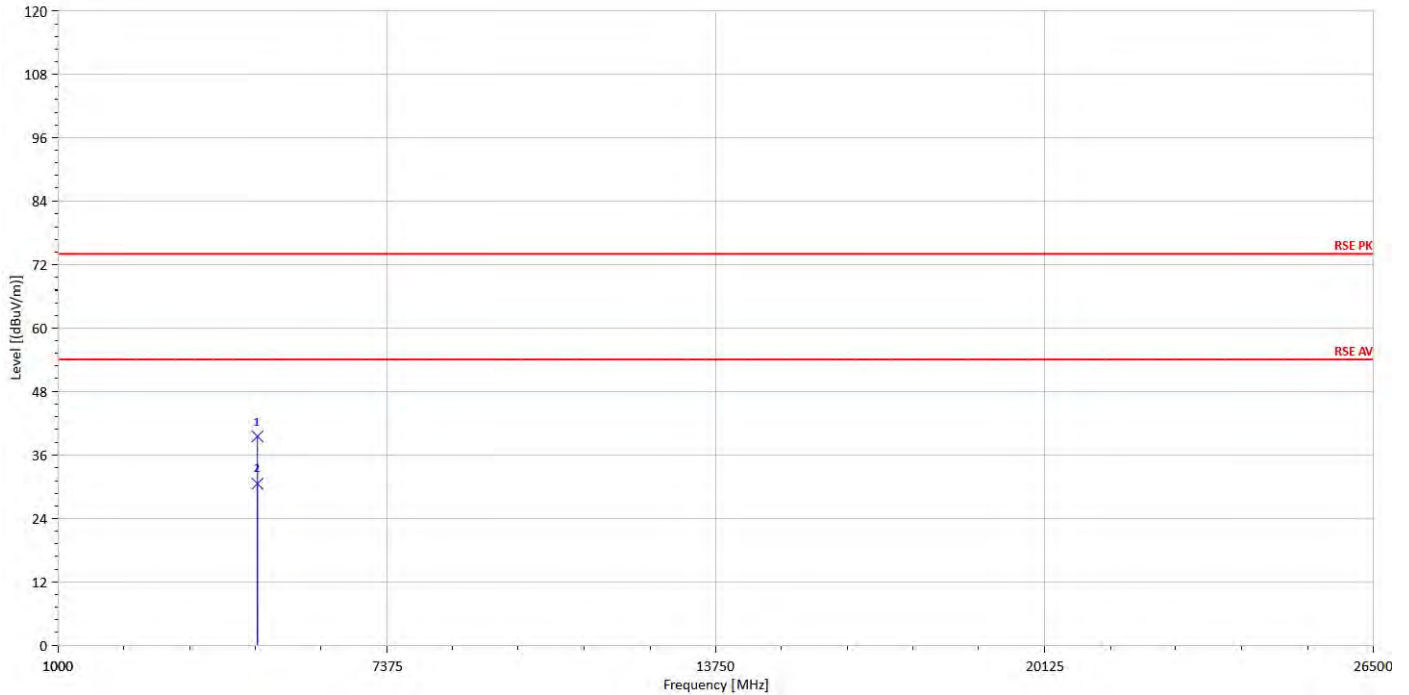

Freq. MHz	Note F/H/E/S	Detector Mode PK/QP/AV	Spectrum Reading Level dBuV	Factor dB	Actual FS dBuV/m	Limit @3m dBuV/m	Margin dB
4874.00	H	Peak	31.62	7.91	39.53	74	-34.47
4874.00	H	Average	22.74	7.91	30.65	54	-23.35

Unless otherwise stated the results shown in this test report refer only to the sample(s) tested and such sample(s) are retained for 90 days only.

除非另有說明，此報告結果僅對測試之樣品負責，同時此樣品僅保留90天。本報告未經本公司書面許可，不可部份複製。

This document is issued by the Company subject to its General Conditions of Service printed overleaf, available on request or accessible at www.sgs.com/terms_and_conditions.htm and, for electronic format documents, subject to Terms and Conditions for Electronic Documents at www.sgs.com/terms_e-document.htm. Attention is drawn to the limitation of liability, indemnification and jurisdiction issues defined therein. Any holder of this document is advised that information contained hereon reflects the Company's findings at the time of its intervention only and within the limits of Client's instructions, if any. The Company's sole responsibility is to its Client and this document does not exonerate parties to a transaction from exercising all their rights and obligations under the transaction documents. This document cannot be reproduced except in full, without prior written approval of the Company. Any unauthorized alteration, forgery or falsification of the content or appearance of this document is unlawful and offenders may be prosecuted to the fullest extent of the law.

SGS Taiwan Ltd.

No.134,WuKungRoad,NewTaipeiIndustrialPark,WukuDistrict,NewTaipeiCity,Taiwan24803/新北市五股區新北產業園區五工路 134 號

台灣檢驗科技股份有限公司

t (886-2) 2299-3279

f (886-2) 2298-0488

www.tw.sgs.com

Member of SGS Group

Operation Mode : 802.11n20 Test Date : 2017/10/20
 Fundamental Frequency : 2462 MHz Temp. / Humi. : 24.5deg_C/70RH
 Operation Band : TX CH HIGH Test Engineer : Enzo
 EUT Pol. : H Measurement Antenna Pol. : Vertical

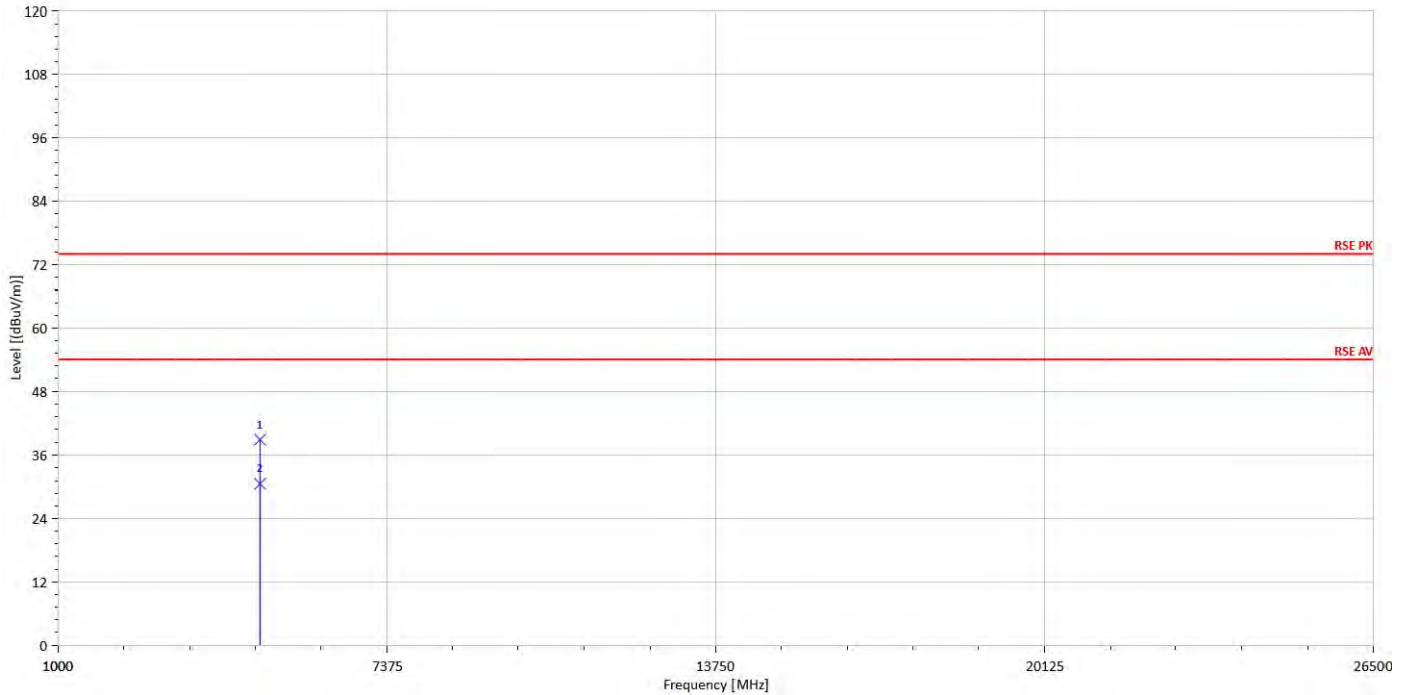

Freq. MHz	Note F/H/E/S	Detector Mode PK/QP/AV	Spectrum Reading Level dBuV	Factor dB	Actual FS dBuV/m	Limit @3m dBuV/m	Margin dB
4924.00	H	Peak	30.96	7.92	38.88	74	-35.12
4924.00	H	Average	22.71	7.92	30.63	54	-23.37

Unless otherwise stated the results shown in this test report refer only to the sample(s) tested and such sample(s) are retained for 90 days only.

除非另有說明，此報告結果僅對測試之樣品負責，同時此樣品僅保留90天。本報告未經本公司書面許可，不可部份複製。

This document is issued by the Company subject to its General Conditions of Service printed overleaf, available on request or accessible at www.sgs.com/terms_and_conditions.htm and, for electronic format documents, subject to Terms and Conditions for Electronic Documents at www.sgs.com/terms_e-document.htm. Attention is drawn to the limitation of liability, indemnification and jurisdiction issues defined therein. Any holder of this document is advised that information contained hereon reflects the Company's findings at the time of its intervention only and within the limits of Client's instructions, if any. The Company's sole responsibility is to its Client and this document does not exonerate parties to a transaction from exercising all their rights and obligations under the transaction documents. This document cannot be reproduced except in full, without prior written approval of the Company. Any unauthorized alteration, forgery or falsification of the content or appearance of this document is unlawful and offenders may be prosecuted to the fullest extent of the law.

SGS Taiwan Ltd.

No.134,WuKungRoad,NewTaipeiIndustrialPark,WukuDistrict,NewTaipeiCity,Taiwan24803/新北市五股區新北產業園區五工路 134 號

台灣檢驗科技股份有限公司

t (886-2) 2299-3279

f (886-2) 2298-0488

www.tw.sgs.com

Member of SGS Group

Operation Mode : 802.11n20 Test Date : 2017/10/20
 Fundamental Frequency : 2462 MHz Temp. / Humi. : 24.5deg_C/70RH
 Operation Band : TX CH HIGH Test Engineer : Enzo
 EUT Pol. : H Measurement Antenna Pol. : Horizontal

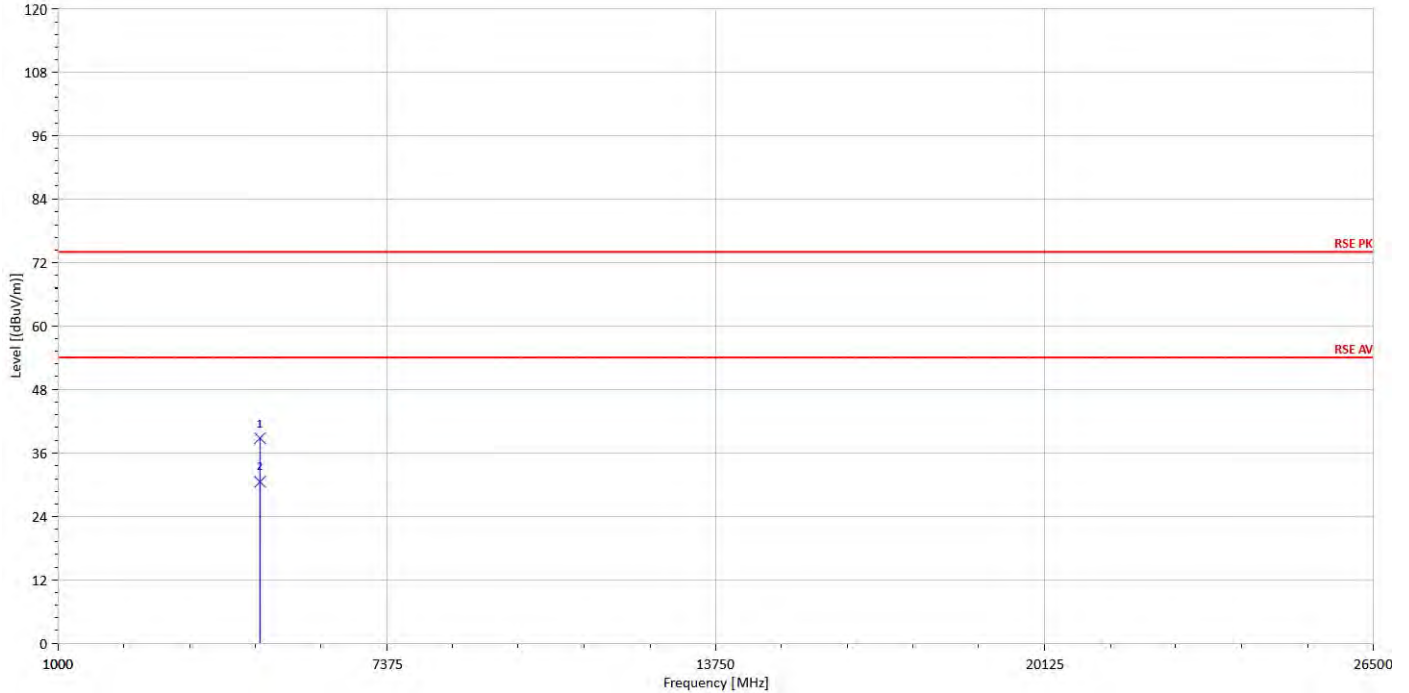

Freq. MHz	Note F/H/E/S	Detector Mode PK/QP/AV	Spectrum Reading Level dBuV	Factor dB	Actual FS dBuV/m	Limit @3m dBuV/m	Margin dB
4924.00	H	Peak	30.87	7.92	38.79	74	-35.21
4924.00	H	Average	22.71	7.92	30.63	54	-23.37

Unless otherwise stated the results shown in this test report refer only to the sample(s) tested and such sample(s) are retained for 90 days only.

除非另有說明，此報告結果僅對測試之樣品負責，同時此樣品僅保留90天。本報告未經本公司書面許可，不可部份複製。

This document is issued by the Company subject to its General Conditions of Service printed overleaf, available on request or accessible at www.sgs.com/terms_and_conditions.htm and, for electronic format documents, subject to Terms and Conditions for Electronic Documents at www.sgs.com/terms_e-document.htm. Attention is drawn to the limitation of liability, indemnification and jurisdiction issues defined therein. Any holder of this document is advised that information contained hereon reflects the Company's findings at the time of its intervention only and within the limits of Client's instructions, if any. The Company's sole responsibility is to its Client and this document does not exonerate parties to a transaction from exercising all their rights and obligations under the transaction documents. This document cannot be reproduced except in full, without prior written approval of the Company. Any unauthorized alteration, forgery or falsification of the content or appearance of this document is unlawful and offenders may be prosecuted to the fullest extent of the law.

SGS Taiwan Ltd.

No.134,WuKungRoad,NewTaipeiIndustrialPark,WukuDistrict,NewTaipeiCity,Taiwan24803/新北市五股區新北產業園區五工路 134 號

台灣檢驗科技股份有限公司

t (886-2) 2299-3279

f (886-2) 2298-0488

www.tw.sgs.com

Member of SGS Group

11 PEAK POWER SPECTRAL DENSITY

11.1 Standard Applicable

The power spectral density conducted from the intentional radiator to the antenna shall not be greater than 8dBm in any 3 kHz band during any time interval of continuous transmission.

11.2 Measurement Equipment Used

Conducted Emission Test Site					
EQUIPMENT TYPE	MFR	MODEL NUMBER	SERIAL NUMBER	LAST CAL.	CAL DUE.
Spectrum Analyzer	KEYSIGHT	N9010A	MY51440113	06/20/2017	06/19/2018
DC Block	PASTERNAK	PE8210	RF29	12/12/2016	12/11/2017
Attenuator	WOKEN	218FS-10	RF23	12/12/2016	12/11/2017

11.3 Test Set-up

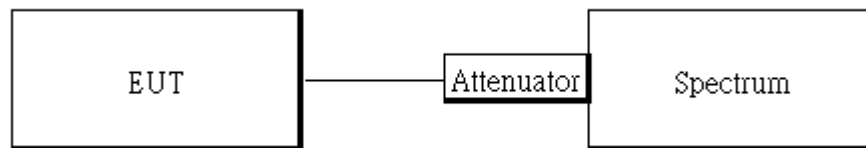

11.4 Measurement Procedure

1. Set analyzer center frequency to DTS channel center frequency.
2. The testing follows the Measurement Procedure of FCC KDB 558074 D01 DTS Meas. Guidance .
3. Set the span to 1.5 times the DTS channel bandwidth.
4. Set the RBW = 3 kHz.
5. Set the VBW = 10 kHz.
6. Detector = peak.
7. Sweep time = auto couple.
8. Trace mode = max hold.
9. Allow trace to fully stabilize.
10. Use the peak marker function to determine the maximum amplitude level.
11. 802.11n MIMO mode: offset is set following “measure and add 10 Log (N)” on spectrum to measure the PSD for MIMO mode. Offset = cable loss + 10 log (N), where N is number of transmitting antenna. N=2 for this given application.

Unless otherwise stated the results shown in this test report refer only to the sample(s) tested and such sample(s) are retained for 90 days only.

除非另有說明，此報告結果僅對測試之樣品負責，同時此樣品僅保留90天。本報告未經本公司書面許可，不可部份複製。

This document is issued by the Company subject to its General Conditions of Service printed overleaf, available on request or accessible at www.sgs.com/terms_and_conditions.htm and, for electronic format documents, subject to Terms and Conditions for Electronic Documents at www.sgs.com/terms_e-document.htm. Attention is drawn to the limitation of liability, indemnification and jurisdiction issues defined therein. Any holder of this document is advised that information contained hereon reflects the Company's findings at the time of its intervention only and within the limits of Client's instructions, if any. The Company's sole responsibility is to its Client and this document does not exonerate parties to a transaction from exercising all their rights and obligations under the transaction documents. This document cannot be reproduced except in full, without prior written approval of the Company. Any unauthorized alteration, forgery or falsification of the content or appearance of this document is unlawful and offenders may be prosecuted to the fullest extent of the law.

SGS Taiwan Ltd.

No.134,WuKungRoad,NewTaipeiIndustrialPark,WukuDistrict,NewTaipeiCity,Taiwan24803/新北市五股區新北產業園區五工路 134 號

台灣檢驗科技股份有限公司

t (886-2) 2299-3279

f (886-2) 2298-0488

www.tw.sgs.com

Member of SGS Group

Note:

Antenna Gain: 4.10 dBi
 Aux1 Antenna Gain: 3.90 dBi
 Aux2 Antenna Gain: 0.00 dBi
 Aux3 Antenna Gain: 0.00 dBi
 Number Antenna: 2 pcs
 Limit: 8 dBm

The antenna gain is not grater than 6dBi in MIMO mode the limit as below:

Directional gain = gain of antenna element + 10 log (# of TX antenna elements)

Effective Legacy Gain (dBi) = 4.1dBi

Limit: 8dBm - (4.1- 6dBi)=8

11.5 Measurement Result

POWER DENSITY 802.11b						
Freq. (MHz)	PPSD W/O Duty Factor (dBm)	Offset	Duty Factor	PPSD With Duty Factor (dBm)	Limit (dBm)	Result
2412	-5.30	10.40	0.01	-5.29	8.00	PASS
2437	-11.53	10.40	0.01	-11.52	8.00	PASS
2462	-10.24	10.40	0.01	-10.23	8.00	PASS

POWER DENSITY 802.11g						
Freq. (MHz)	PPSD W/O Duty Factor (dBm)	Offset	Duty Factor	PPSD With Duty Factor (dBm)	Limit (dBm)	Result
2412	-12.86	10.40	0.11	-12.75	8.00	PASS
2437	-12.28	10.40	0.11	-12.17	8.00	PASS
2462	-12.74	10.40	0.11	-12.63	8.00	PASS

POWER DENSITY 802.11n HT20						
Freq. (MHz)	PPSD W/O Duty Factor (dBm)	Offset	Duty Factor	PPSD With Duty Factor (dBm)	Limit (dBm)	Result
2412	-11.88	10.40	0.23	-11.65	8.00	PASS
2437	-13.12	10.40	0.23	-12.89	8.00	PASS
2462	-11.74	10.40	0.23	-11.51	8.00	PASS

*Refer to next page for plots

Unless otherwise stated the results shown in this test report refer only to the sample(s) tested and such sample(s) are retained for 90 days only.

除非另有說明，此報告結果僅對測試之樣品負責，同時此樣品僅保留90天。本報告未經本公司書面許可，不可部份複製。

This document is issued by the Company subject to its General Conditions of Service printed overleaf, available on request or accessible at www.sgs.com/terms_and_conditions.htm and, for electronic format documents, subject to Terms and Conditions for Electronic Documents at www.sgs.com/terms_e-document.htm. Attention is drawn to the limitation of liability, indemnification and jurisdiction issues defined therein. Any holder of this document is advised that information contained hereon reflects the Company's findings at the time of its intervention only and within the limits of Client's instructions, if any. The Company's sole responsibility is to its Client and this document does not exonerate parties to a transaction from exercising all their rights and obligations under the transaction documents. This document cannot be reproduced except in full, without prior written approval of the Company. Any unauthorized alteration, forgery or falsification of the content or appearance of this document is unlawful and offenders may be prosecuted to the fullest extent of the law.

802.11b
Power Spectral Density Test Plot (CH-Low)



802.11g
Power Spectral Density Test Plot (CH-Low)

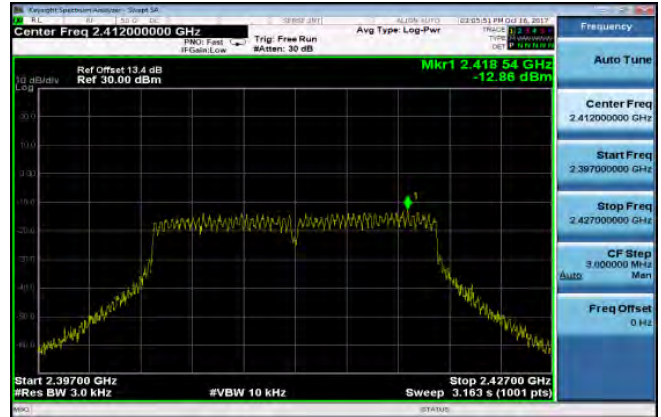

Power Spectral Density Test Plot (CH-Mid)



Power Spectral Density Test Plot (CH-Mid)

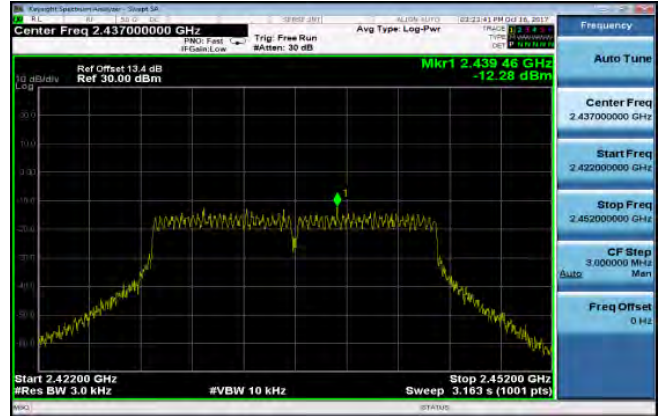

Power Spectral Density Test Plot (CH-High)



Power Spectral Density Test Plot (CH-High)

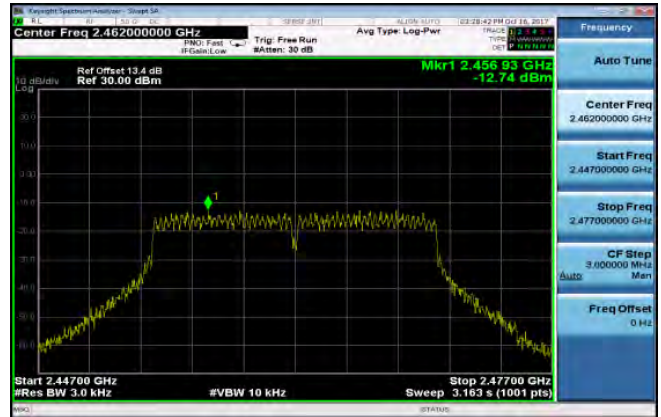

Unless otherwise stated the results shown in this test report refer only to the sample(s) tested and such sample(s) are retained for 90 days only.

除非另有說明，此報告結果僅對測試之樣品負責，同時此樣品僅保留90天。本報告未經本公司書面許可，不可部份複製。

This document is issued by the Company subject to its General Conditions of Service printed overleaf, available on request or accessible at www.sgs.com/terms_and_conditions.htm and, for electronic format documents, subject to Terms and Conditions for Electronic Documents at www.sgs.com/terms_e-document.htm. Attention is drawn to the limitation of liability, indemnification and jurisdiction issues defined therein. Any holder of this document is advised that information contained hereon reflects the Company's findings at the time of its intervention only and within the limits of Client's instructions, if any. The Company's sole responsibility is to its Client and this document does not exonerate parties to a transaction from exercising all their rights and obligations under the transaction documents. This document cannot be reproduced except in full, without prior written approval of the Company. Any unauthorized alteration, forgery or falsification of the content or appearance of this document is unlawful and offenders may be prosecuted to the fullest extent of the law.

SGS Taiwan Ltd.

台灣檢驗科技股份有限公司

No. 134, WuKungRoad, NewTaipeiIndustrialPark, WukuDistrict, NewTaipeiCity, Taiwan24803/新北市五股區新北產業園區五工路 134 號

t (886-2) 2299-3279

f (886-2) 2298-0488

www.tw.sgs.com

Member of SGS Group

802.11n_HT20 (MIMO)
Power Spectral Density Test Plot (CH-Low)

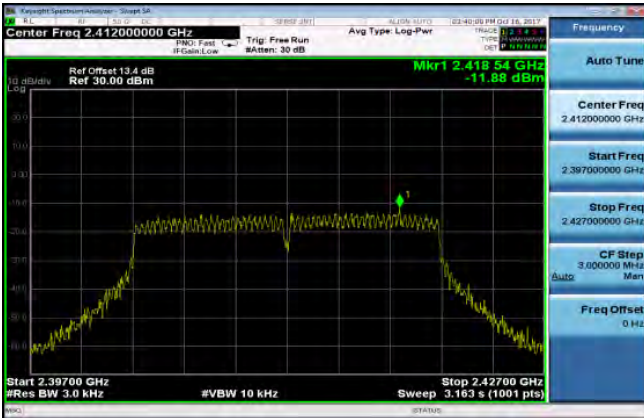

Power Spectral Density Test Plot (CH-Mid)

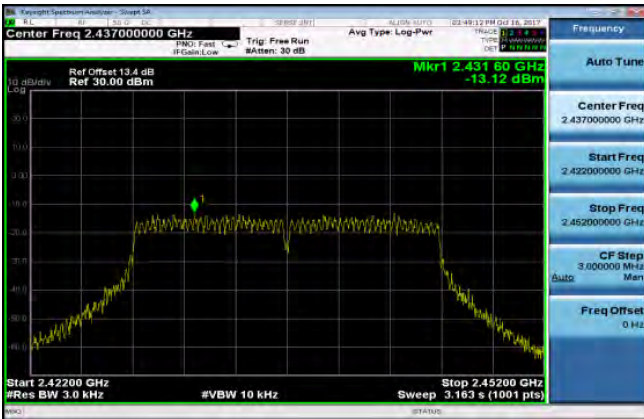

Power Spectral Density Test Plot (CH-High)

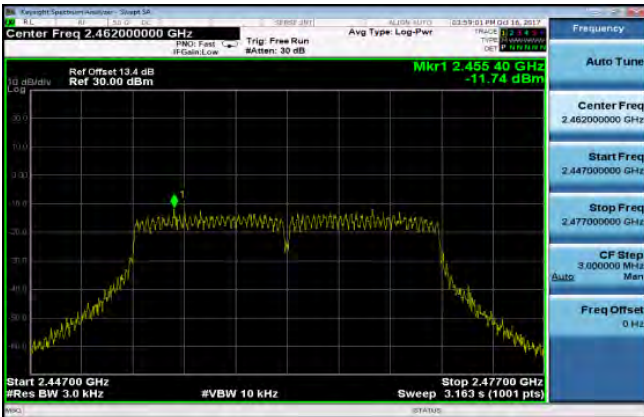

Unless otherwise stated the results shown in this test report refer only to the sample(s) tested and such sample(s) are retained for 90 days only.

除非另有說明，此報告結果僅對測試之樣品負責，同時此樣品僅保留90天。本報告未經本公司書面許可，不可部份複製。

This document is issued by the Company subject to its General Conditions of Service printed overleaf, available on request or accessible at www.sgs.com/terms_and_conditions.htm and, for electronic format documents, subject to Terms and Conditions for Electronic Documents at www.sgs.com/terms_e-document.htm. Attention is drawn to the limitation of liability, indemnification and jurisdiction issues defined therein. Any holder of this document is advised that information contained hereon reflects the Company's findings at the time of its intervention only and within the limits of Client's instructions, if any. The Company's sole responsibility is to its Client and this document does not exonerate parties to a transaction from exercising all their rights and obligations under the transaction documents. This document cannot be reproduced except in full, without prior written approval of the Company. Any unauthorized alteration, forgery or falsification of the content or appearance of this document is unlawful and offenders may be prosecuted to the fullest extent of the law.

SGS Taiwan Ltd.

No. 134, WuKungRoad, NewTaipeiIndustrialPark, WukuDistrict, NewTaipeiCity, Taiwan24803/新北市五股區新北產業園區五工路 134 號

台灣檢驗科技股份有限公司

t (886-2) 2299-3279

f (886-2) 2298-0488

www.tw.sgs.com

Member of SGS Group

12 ANTENNA REQUIREMENT

12.1 Standard Applicable

For intentional device, according to §15.203, an intentional radiator shall be designed to ensure that no antenna other than furnished by the responsible party shall be used with the device.

If the transmitting antenna is greater than 6dBi, the power shall be reduced by the same level in dB comparing to gain minus 6dBi.

12.2 Antenna Connected Construction

An embedded-in antenna design is used.

The antenna connector is designed with unique type RF connector and no consideration of replacement. Please see EUT photo and antenna spec. for details.

The antenna gain is less than 6dBi. Therefore, it is not necessary to reduce maximum output power limit.

~ End of Report ~

Unless otherwise stated the results shown in this test report refer only to the sample(s) tested and such sample(s) are retained for 90 days only.

除非另有說明，此報告結果僅對測試之樣品負責，同時此樣品僅保留90天。本報告未經本公司書面許可，不可部份複製。

This document is issued by the Company subject to its General Conditions of Service printed overleaf, available on request or accessible at www.sgs.com/terms_and_conditions.htm and, for electronic format documents, subject to Terms and Conditions for Electronic Documents at www.sgs.com/terms_e-document.htm. Attention is drawn to the limitation of liability, indemnification and jurisdiction issues defined therein. Any holder of this document is advised that information contained hereon reflects the Company's findings at the time of its intervention only and within the limits of Client's instructions, if any. The Company's sole responsibility is to its Client and this document does not exonerate parties to a transaction from exercising all their rights and obligations under the transaction documents. This document cannot be reproduced except in full, without prior written approval of the Company. Any unauthorized alteration, forgery or falsification of the content or appearance of this document is unlawful and offenders may be prosecuted to the fullest extent of the law.

SGS Taiwan Ltd.

台灣檢驗科技股份有限公司

No.134,WuKungRoad,NewTaipeiIndustrialPark,WukuDistrict,NewTaipeiCity,Taiwan24803/新北市五股區新北產業園區五工路 134 號

t (886-2) 2299-3279

f (886-2) 2298-0488

www.tw.sgs.com

Member of SGS Group