

**ELECTROMAGNETIC EMISSIONS
COMPLIANCE REPORT**

Applicant: Quanta Computer Inc.
No. 188, Wenhua 2nd Road, Guishan District, Taoyuan City
33377, Taiwan

Product Name: Clover Flex

Brand Name: clover

Model No.: C403

HVIN: C403W

Model Difference: N/A

Report Number: ER/2021/50020

FCC ID HFS-C403W

IC: 1787B-C403W

Issue Date: July 9, 2021

Date of Test: June 10, 2021 ~ June 30, 2021

Date of EUT Received: May 21, 2021

Approved By _____

Blue Yang**We hereby certify that:**

The above equipment was tested by SGS Taiwan Ltd. Central RF Lab The test data, data evaluation, test procedures, and equipment configurations shown in this report were made in accordance with the procedures given in ANSI C63.10:2013 and the energy emitted by the sample EUT comply with FCC rule part §15.247, ISED RSS-247.

The results of this report relate only to the sample identified in this report.

Unless otherwise stated the results shown in this test report refer only to the sample(s) tested and such sample(s) are retained for 90 days only.

除非另有說明，此報告結果僅對測試之樣品負責，同時此樣品僅保留90天。本報告未經本公司書面許可，不可部份複製。

This document is issued by the Company subject to its General Conditions of Service printed overleaf, available on request or accessible at <http://www.sgs.com.tw/Terms-and-Conditions> and for electronic format documents, subject to Terms and Conditions for Electronic Documents at <http://www.sgs.com.tw/Terms-and-Conditions>. Attention is drawn to the limitation of liability, indemnification and jurisdiction issues defined therein. Any holder of this document is advised that information contained hereon reflects the Company's findings at the time of its intervention only and within the limits of Client's instructions, if any. The Company's sole responsibility is to its Client and this document does not exonerate parties to a transaction from exercising all their rights and obligations under the transaction documents. This document cannot be reproduced except in full, without prior written approval of the Company. Any unauthorized alteration, forgery or falsification of the content or appearance of this document is unlawful and offenders may be prosecuted to the fullest extent of the law.

Revision History

Report Number	Revision	Description	Issue Date	Revised By
ER/2021/50020	00	Original	July 9, 2021	Yuri Tsai

Unless otherwise stated the results shown in this test report refer only to the sample(s) tested and such sample(s) are retained for 90 days only.

除非另有說明，此報告結果僅對測試之樣品負責，同時此樣品僅保留90天。本報告未經本公司書面許可，不可部份複製。

This document is issued by the Company subject to its General Conditions of Service printed overleaf, available on request or accessible at <http://www.sgs.com.tw/Terms-and-Conditions> and for electronic format documents, subject to Terms and Conditions for Electronic Documents at <http://www.sgs.com.tw/Terms-and-Conditions>. Attention is drawn to the limitation of liability, indemnification and jurisdiction issues defined therein. Any holder of this document is advised that information contained hereon reflects the Company's findings at the time of its intervention only and within the limits of Client's instructions, if any. The Company's sole responsibility is to its Client and this document does not exonerate parties to a transaction from exercising all their rights and obligations under the transaction documents. This document cannot be reproduced except in full, without prior written approval of the Company. Any unauthorized alteration, forgery or falsification of the content or appearance of this document is unlawful and offenders may be prosecuted to the fullest extent of the law.

Table of Contents

1	GENERAL INFORMATION	4
2	SYSTEM TEST CONFIGURATION.....	7
3	SUMMARY OF TEST RESULTS.....	10
4	DESCRIPTION OF TEST MODES.....	11
5	MEASUREMENT UNCERTAINTY	13
6	CONDUCTED EMISSION TEST	14
7	PEAK OUTPUT POWER MEASUREMENT	18
8	EMISSION BANDWIDTH MEASUREMENT	24
9	CONDUCTED BAND EDGES AND SPURIOUS EMISSION MEASUREMENT.....	29
10	RADIATED BANEDGE AND SPURIOUS EMISSION MEASUREMENT.....	35
11	POWER SPECTRAL DENSITY	64
12	ANTENNA REQUIREMENT.....	67

Unless otherwise stated the results shown in this test report refer only to the sample(s) tested and such sample(s) are retained for 90 days only.

除非另有說明，此報告結果僅對測試之樣品負責，同時此樣品僅保留90天。本報告未經本公司書面許可，不可部份複製。

This document is issued by the Company subject to its General Conditions of Service printed overleaf, available on request or accessible at <http://www.sgs.com.tw/Terms-and-Conditions> and for electronic format documents, subject to Terms and Conditions for Electronic Documents at <http://www.sgs.com.tw/Terms-and-Conditions>. Attention is drawn to the limitation of liability, indemnification and jurisdiction issues defined therein. Any holder of this document is advised that information contained hereon reflects the Company's findings at the time of its intervention only and within the limits of Client's instructions, if any. The Company's sole responsibility is to its Client and this document does not exonerate parties to a transaction from exercising all their rights and obligations under the transaction documents. This document cannot be reproduced except in full, without prior written approval of the Company. Any unauthorized alteration, forgery or falsification of the content or appearance of this document is unlawful and offenders may be prosecuted to the fullest extent of the law.

1 GENERAL INFORMATION

1.1 Product Description

Product Name:	Clover Flex
Brand Name:	clover
Model No.:	C403
HVIN:	C403W
Model Difference:	N/A
Hardware Version:	N/A
Firmware Version:	N/A
EUT Series No.:	C043UT11750016
Power Supply:	7.6V from Li-ion Polymer rechargeable battery or 12V from Adapter

1.2 RF Specification

Radio Technology:	BLE
Frequency Range:	2402 – 2480MHz
Channel number:	40 channels
Modulation type:	GFSK
Transmit Power:	BLE 1M: 1.33 dBm BLE 2M: 1.45 dBm

1.3 Antenna Designation

Antenna Type	Supplier	Antenna Part No.	Freq. (MHz)	Peak Antenna Gain (dBi)	Worst Antenna Gain
PIFA	SAA	DQ60AYF0002	2.4GHz	-1.47	-

Note: Antenna information is provided by the applicant.

Unless otherwise stated the results shown in this test report refer only to the sample(s) tested and such sample(s) are retained for 90 days only.

除非另有說明，此報告結果僅對測試之樣品負責，同時此樣品僅保留90天。本報告未經本公司書面許可，不可部份複製。

This document is issued by the Company subject to its General Conditions of Service printed overleaf, available on request or accessible at <http://www.sgs.com.tw/Terms-and-Conditions> and for electronic format documents, subject to Terms and Conditions for Electronic Documents at <http://www.sgs.com.tw/Terms-and-Conditions>. Attention is drawn to the limitation of liability, indemnification and jurisdiction issues defined therein. Any holder of this document is advised that information contained hereon reflects the Company's findings at the time of its intervention only and within the limits of Client's instructions, if any. The Company's sole responsibility is to its Client and this document does not exonerate parties to a transaction from exercising all their rights and obligations under the transaction documents. This document cannot be reproduced except in full, without prior written approval of the Company. Any unauthorized alteration, forgery or falsification of the content or appearance of this document is unlawful and offenders may be prosecuted to the fullest extent of the law.

1.4 Test Methodology of Applied Standards

FCC Part 15, Subpart C §15.247
 FCC KDB 558074 D01 15.247 Meas Guidance v05r02
 RSS-247 issue 2 Feb. 2017
 RSS-Gen Issue 5, Amendment 2, February 2021
 ANSI C63.10:2013

1.5 Test Facility

Laboratory	Test Site Address	Test Site Name	FCC Designation number	IC CAB identifier
SGS Taiwan Ltd. Central RF Lab. (TAF code 3702)	No.134, Wu Kung Road, New Taipei Industrial Park, Wuku District, New Taipei City, Taiwan.	SAC 1	TW0027	TW3702
		SAC 3		
		Conduction 1		
		Conducted 1		
		Conducted 2		
		Conducted 3		
	No.2, Keji 1st Rd., Guishan District, Taoyuan City, Taiwan 333	Conducted 4	TW0028	
		Conducted 5		
		Conducted 6		
		Conduction A		
		SAC C		
		SAC D		
		SAC G		
		Conducted A		
		Conducted B		
		Conducted C		
		Conducted D		
		Conducted E		
		Conducted F		
Conducted G				

Note: Test site name is remarked on the equipment list in each section of this report as an indication where measurements occurred in specific test site and address.

Unless otherwise stated the results shown in this test report refer only to the sample(s) tested and such sample(s) are retained for 90 days only.

除非另有說明，此報告結果僅對測試之樣品負責，同時此樣品僅保留90天。本報告未經本公司書面許可，不可部份複製。

This document is issued by the Company subject to its General Conditions of Service printed overleaf, available on request or accessible at <http://www.sgs.com.tw/Terms-and-Conditions> and for electronic format documents, subject to Terms and Conditions for Electronic Documents at <http://www.sgs.com.tw/Terms-and-Conditions>. Attention is drawn to the limitation of liability, indemnification and jurisdiction issues defined therein. Any holder of this document is advised that information contained hereon reflects the Company's findings at the time of its intervention only and within the limits of Client's instructions, if any. The Company's sole responsibility is to its Client and this document does not exonerate parties to a transaction from exercising all their rights and obligations under the transaction documents. This document cannot be reproduced except in full, without prior written approval of the Company. Any unauthorized alteration, forgery or falsification of the content or appearance of this document is unlawful and offenders may be prosecuted to the fullest extent of the law.

1.6 Special Accessories

There are no special accessories used while test was conducted.

1.7 Equipment Modifications

There was no modification incorporated into the EUT.

Unless otherwise stated the results shown in this test report refer only to the sample(s) tested and such sample(s) are retained for 90 days only.

除非另有說明，此報告結果僅對測試之樣品負責，同時此樣品僅保留90天。本報告未經本公司書面許可，不可部份複製。

This document is issued by the Company subject to its General Conditions of Service printed overleaf, available on request or accessible at <http://www.sgs.com.tw/Terms-and-Conditions> and for electronic format documents, subject to Terms and Conditions for Electronic Documents at <http://www.sgs.com.tw/Terms-and-Conditions>. Attention is drawn to the limitation of liability, indemnification and jurisdiction issues defined therein. Any holder of this document is advised that information contained hereon reflects the Company's findings at the time of its intervention only and within the limits of Client's instructions, if any. The Company's sole responsibility is to its Client and this document does not exonerate parties to a transaction from exercising all their rights and obligations under the transaction documents. This document cannot be reproduced except in full, without prior written approval of the Company. Any unauthorized alteration, forgery or falsification of the content or appearance of this document is unlawful and offenders may be prosecuted to the fullest extent of the law.

2 SYSTEM TEST CONFIGURATION

2.1 EUT Configuration

The EUT configuration for testing is installed on RF field strength measurement to meet the Commissions requirement and operating in a manner which intends to maximize its emission characteristics in a continuous normal application.

2.2 EUT Exercise

An engineering test mode (software/firmware) that applicant provided was utilized to manipulate the EUT into transmit, selection of the test channel, and modulation scheme.

2.3 Test Procedure

2.3.1 Conducted Emissions

The EUT is placed on a table which is 0.8 m above ground plane. Conducted emissions from the EUT measured in the frequency range between 0.15 MHz and 30MHz. The CISPR Quasi-Peak and Average detector mode is employed. The two LISNs provide 50uH/50 ohm of coupling impedance for the measuring instrument. Both lines of the power mains connected to the EUT were checked for maximum conducted interference.

2.3.2 Conducted Test (RF)

The active antenna port of the unlicensed wireless device is connected to the spectrum analyzer with attenuator to protect the instrumentation. If a second antenna port is available, it is tested at one operating frequency, with other port(s) appropriately terminated, to verify it has similar output characteristics as the fully tested port.

2.3.3 Radiated Emissions

The EUT is placed on a turn table. For emissions testing at or below 1 GHz, the table height shall be 0.8 m above the reference ground plane. For emission measurements above 1 GHz, the table height shall be 1.5 m. The turn table shall rotate 360 degrees to determine the position of maximum emission level. EUT is set 3m away from the receiving antenna which varied from 1m to 4m to find out the highest emission. And also, each emission was to be maximized by changing the polarization of receiving antenna both horizontal and vertical. In order to find out the max. emission, the relative positions of this transmitter (EUT) was rotated through three orthogonal axes and measurement procedures for electric field radiated emissions above 1 GHz the EUT measurement is to be made "while keeping the antenna in the 'cone of radiation' from that area and pointed at the area both in azimuth and elevation, with polarization oriented for maximum response." is still within the 3dB illumination BW of the measurement antenna.

Unless otherwise stated the results shown in this test report refer only to the sample(s) tested and such sample(s) are retained for 90 days only.

除非另有說明，此報告結果僅對測試之樣品負責，同時此樣品僅保留90天。本報告未經本公司書面許可，不可部份複製。

This document is issued by the Company subject to its General Conditions of Service printed overleaf, available on request or accessible at <http://www.sgs.com.tw/Terms-and-Conditions> and for electronic format documents, subject to Terms and Conditions for Electronic Documents at <http://www.sgs.com.tw/Terms-and-Conditions>. Attention is drawn to the limitation of liability, indemnification and jurisdiction issues defined therein. Any holder of this document is advised that information contained hereon reflects the Company's findings at the time of its intervention only and within the limits of Client's instructions, if any. The Company's sole responsibility is to its Client and this document does not exonerate parties to a transaction from exercising all their rights and obligations under the transaction documents. This document cannot be reproduced except in full, without prior written approval of the Company. Any unauthorized alteration, forgery or falsification of the content or appearance of this document is unlawful and offenders may be prosecuted to the fullest extent of the law.

2.4 Measurement Results Explanation Example

2.4.1 Radiated Emission Test Sites For Measurements From 9 kHz To 30 MHz

Radiated emission below 30MHz is measured in a 9m*9m*6m semi-anechoic chamber, the measurements correspond to those obtained at an open-field test site.

There is a comparison data of both open-field test site and semi-Anechoic chamber, and the result came out very similar.

2.4.2 For all conducted test items:

The offset level is set in the spectrum analyzer to compensate the RF cable loss and attenuation factor between EUT conducted port and spectrum analyzer. With the offset compensation, the spectrum analyzer reading level is exactly EUT RF output level.

Unless otherwise stated the results shown in this test report refer only to the sample(s) tested and such sample(s) are retained for 90 days only.

除非另有說明，此報告結果僅對測試之樣品負責，同時此樣品僅保留90天。本報告未經本公司書面許可，不可部份複製。

This document is issued by the Company subject to its General Conditions of Service printed overleaf, available on request or accessible at <http://www.sgs.com.tw/Terms-and-Conditions> and for electronic format documents, subject to Terms and Conditions for Electronic Documents at <http://www.sgs.com.tw/Terms-and-Conditions>. Attention is drawn to the limitation of liability, indemnification and jurisdiction issues defined therein. Any holder of this document is advised that information contained hereon reflects the Company's findings at the time of its intervention only and within the limits of Client's instructions, if any. The Company's sole responsibility is to its Client and this document does not exonerate parties to a transaction from exercising all their rights and obligations under the transaction documents. This document cannot be reproduced except in full, without prior written approval of the Company. Any unauthorized alteration, forgery or falsification of the content or appearance of this document is unlawful and offenders may be prosecuted to the fullest extent of the law.

2.5 Configuration of Tested System

Fig. 2-1 Conducted (Antenna Port) Emission Configuration



Fig 2-3 Conduction (AC Power Line) Radiated Emission

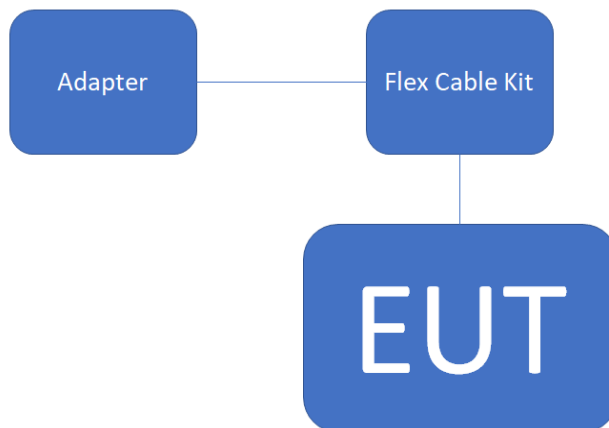

Fig 2-2 Radiated Emission

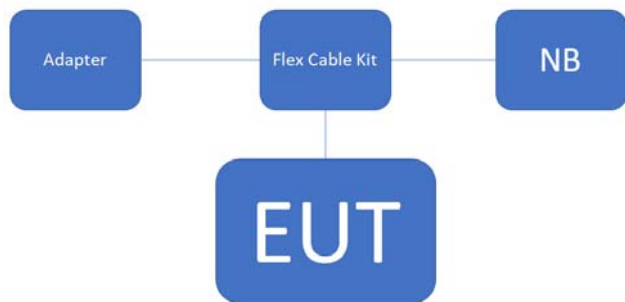

Table 2-1 Equipment Used in Tested System

Item	Equipment	Mfr/Brand	Model/Type No.	Series No.
1	Bluetooth Test Software	N/A	N/A	N/A
2	Notebook	Lenovo	T440P	PC-014TAK
3	Flex Cable Kit	Clover	N/A	H041UQ63940213

Unless otherwise stated the results shown in this test report refer only to the sample(s) tested and such sample(s) are retained for 90 days only.

除非另有說明，此報告結果僅對測試之樣品負責，同時此樣品僅保留90天。本報告未經本公司書面許可，不可部份複製。

This document is issued by the Company subject to its General Conditions of Service printed overleaf, available on request or accessible at <http://www.sgs.com.tw/Terms-and-Conditions> and for electronic format documents, subject to Terms and Conditions for Electronic Documents at <http://www.sgs.com.tw/Terms-and-Conditions>. Attention is drawn to the limitation of liability, indemnification and jurisdiction issues defined therein. Any holder of this document is advised that information contained hereon reflects the Company's findings at the time of its intervention only and within the limits of Client's instructions, if any. The Company's sole responsibility is to its Client and this document does not exonerate parties to a transaction from exercising all their rights and obligations under the transaction documents. This document cannot be reproduced except in full, without prior written approval of the Company. Any unauthorized alteration, forgery or falsification of the content or appearance of this document is unlawful and offenders may be prosecuted to the fullest extent of the law.

3 SUMMARY OF TEST RESULTS

FCC Rules	ISED Rules	Description Of Test	Result
§15.207(a)	RSS-Gen §8.8	AC Power Line Conducted Emission	Compliant
§15.247(b) (3)	RSS-247 §5.4 d	Peak Output Power	Compliant
§15.247(a)(2)	RSS-247 §5.2 a RSS-Gen §6.7	Emission Bandwidth	Compliant
§15.247(d) §15.205 §15.209	RSS-247 §5.5 RSS-Gen §8.9 RSS-Gen §8.10	Radiated & Conducted Band Edge and Spurious Emission	Compliant
§15.247(e)	RSS-247 §5.2 b	Peak Power Density	Compliant
§15.203 §15.247(b)	N/A	Antenna Requirement	Compliant

Unless otherwise stated the results shown in this test report refer only to the sample(s) tested and such sample(s) are retained for 90 days only.

除非另有說明，此報告結果僅對測試之樣品負責，同時此樣品僅保留90天。本報告未經本公司書面許可，不可部份複製。

This document is issued by the Company subject to its General Conditions of Service printed overleaf, available on request or accessible at <http://www.sgs.com.tw/Terms-and-Conditions> and for electronic format documents, subject to Terms and Conditions for Electronic Documents at <http://www.sgs.com.tw/Terms-and-Conditions>. Attention is drawn to the limitation of liability, indemnification and jurisdiction issues defined therein. Any holder of this document is advised that information contained hereon reflects the Company's findings at the time of its intervention only and within the limits of Client's instructions, if any. The Company's sole responsibility is to its Client and this document does not exonerate parties to a transaction from exercising all their rights and obligations under the transaction documents. This document cannot be reproduced except in full, without prior written approval of the Company. Any unauthorized alteration, forgery or falsification of the content or appearance of this document is unlawful and offenders may be prosecuted to the fullest extent of the law.

4 DESCRIPTION OF TEST MODES

4.1 Operating Frequencies

ITEM	FREQUENCY	ITEM	FREQUENCY	ITEM	FREQUENCY
1	2402 MHz	15	2430 MHz	29	2458 MHz
2	2404 MHz	16	2432 MHz	30	2460 MHz
3	2406 MHz	17	2434 MHz	31	2462 MHz
4	2408 MHz	18	2436 MHz	32	2464 MHz
5	2410 MHz	19	2438 MHz	33	2466 MHz
6	2412 MHz	20	2440 MHz	34	2468 MHz
7	2414 MHz	21	2442 MHz	35	2470 MHz
8	2416MHz	22	2444 MHz	36	2472 MHz
9	2418 MHz	23	2446 MHz	37	2474 MHz
10	2420 MHz	24	2448 MHz	38	2476 MHz
11	2422 MHz	25	2450 MHz	39	2478 MHz
12	2424 MHz	26	2452 MHz	40	2480 MHz
13	2426 MHz	27	2454 MHz		
14	2428 MHz	28	2456 MHz		

Unless otherwise stated the results shown in this test report refer only to the sample(s) tested and such sample(s) are retained for 90 days only.

除非另有說明，此報告結果僅對測試之樣品負責，同時此樣品僅保留90天。本報告未經本公司書面許可，不可部份複製。

This document is issued by the Company subject to its General Conditions of Service printed overleaf, available on request or accessible at <http://www.sgs.com.tw/Terms-and-Conditions> and for electronic format documents, subject to Terms and Conditions for Electronic Documents at <http://www.sgs.com.tw/Terms-and-Conditions>. Attention is drawn to the limitation of liability, indemnification and jurisdiction issues defined therein. Any holder of this document is advised that information contained hereon reflects the Company's findings at the time of its intervention only and within the limits of Client's instructions, if any. The Company's sole responsibility is to its Client and this document does not exonerate parties to a transaction from exercising all their rights and obligations under the transaction documents. This document cannot be reproduced except in full, without prior written approval of the Company. Any unauthorized alteration, forgery or falsification of the content or appearance of this document is unlawful and offenders may be prosecuted to the fullest extent of the law.

4.2 The Worst Test Modes and Channel Details

1. The EUT has been tested under operating condition.
2. Test program used to control the EUT for staying in continuous transmitting and receiving mode is programmed.
3. Investigation has been done on all the possible configurations for searching the worst case.

MODE	AVAILABLE FREQUENCY (MHz)	TESTED FREQUENCY (MHz)	MODULATION	DATA RATE (Mbps)
RADIATED EMISSION TEST (BELOW 1 GHz)				
Bluetooth LE	2402 to 2480	2442	GFSK	1
RADIATED EMISSION TEST (ABOVE 1 GHz)				
Bluetooth LE	2402 to 2480	2402, 2442, 2480	GFSK	1
<p>Note: The field strength of radiation emission was measured as EUT three orthogonal planes, E1 / E2 / H, are positioned to pre-scan the emission generating the highest one. The worst position is tested and recorded.</p>				

ANTENNA PORT CONDUCTED MEASUREMENT				
MODE	AVAILABLE FREQUENCY (MHz)	TESTED FREQUENCY (MHz)	MODULATION	DATA RATE (Mbps)
Bluetooth LE	2402 to 2480	2402, 2442, 2480	GFSK	1

Unless otherwise stated the results shown in this test report refer only to the sample(s) tested and such sample(s) are retained for 90 days only.

除非另有說明，此報告結果僅對測試之樣品負責，同時此樣品僅保留90天。本報告未經本公司書面許可，不可部份複製。

This document is issued by the Company subject to its General Conditions of Service printed overleaf, available on request or accessible at <http://www.sgs.com.tw/Terms-and-Conditions> and for electronic format documents, subject to Terms and Conditions for Electronic Documents at <http://www.sgs.com.tw/Terms-and-Conditions>. Attention is drawn to the limitation of liability, indemnification and jurisdiction issues defined therein. Any holder of this document is advised that information contained hereon reflects the Company's findings at the time of its intervention only and within the limits of Client's instructions, if any. The Company's sole responsibility is to its Client and this document does not exonerate parties to a transaction from exercising all their rights and obligations under the transaction documents. This document cannot be reproduced except in full, without prior written approval of the Company. Any unauthorized alteration, forgery or falsification of the content or appearance of this document is unlawful and offenders may be prosecuted to the fullest extent of the law.

5 MEASUREMENT UNCERTAINTY

Test Items	Uncertainty
AC Power Line Conducted Emission	+/- 2.34 dB
Peak Output Power	+/- 1 dB
6dB Bandwidth & 99% Bandwidth	+/- 1.53 Hz
100 kHz Bandwidth Of Frequency Band Edges	+/- 1.69 dB
Peak Power Density	+/- 1.53 dB
Temperature	+/- 0.4 °C
Humidity	+/- 3.5 %
DC / AC Power Source	+/- 1 %

Radiated Spurious Emission Measurement Uncertainty		
Polarization: Vertical	+/- 2.64 dB	9kHz~30MHz
	+/- 4.93 dB	30MHz - 1000MHz
	+/- 4.81 dB	1GHz - 18GHz
	+/- 4.52 dB	18GHz - 40GHz
Polarization: Horizontal	+/- 2.64 dB	9kHz~30MHz
	+/- 4.45 dB	30MHz - 1000MHz
	+/- 4.81 dB	1GHz - 18GHz
	+/- 4.52 dB	18GHz - 40GHz

Note:

1. This uncertainty represents an expanded uncertainty expressed at approximately the 95% confidence level using a coverage factor of k=2.
2. The conformity assessment statement in this report is based solely on the test results, measurement uncertainty is excluded.

Unless otherwise stated the results shown in this test report refer only to the sample(s) tested and such sample(s) are retained for 90 days only.

除非另有說明，此報告結果僅對測試之樣品負責，同時此樣品僅保留90天。本報告未經本公司書面許可，不可部份複製。

This document is issued by the Company subject to its General Conditions of Service printed overleaf, available on request or accessible at <http://www.sgs.com.tw/Terms-and-Conditions> and for electronic format documents, subject to Terms and Conditions for Electronic Documents at <http://www.sgs.com.tw/Terms-and-Conditions>. Attention is drawn to the limitation of liability, indemnification and jurisdiction issues defined therein. Any holder of this document is advised that information contained hereon reflects the Company's findings at the time of its intervention only and within the limits of Client's instructions, if any. The Company's sole responsibility is to its Client and this document does not exonerate parties to a transaction from exercising all their rights and obligations under the transaction documents. This document cannot be reproduced except in full, without prior written approval of the Company. Any unauthorized alteration, forgery or falsification of the content or appearance of this document is unlawful and offenders may be prosecuted to the fullest extent of the law.

6 CONDUCTED EMISSION TEST

6.1 Standard Applicable:

Frequency range within 150kHz to 30MHz shall not exceed the Limit table as below.

Frequency range MHz	Limits (dB μ V)	
	Quasi-peak	Average
0.15 to 0.50	66 to 56	56 to 46
0.50 to 5	56	46
5 to 30	60	50

Note

1. The lower limit shall apply at the transition frequencies
2. The limit decreases linearly with the logarithm of the frequency in the range 0.15 MHz to 0.50 MHz.

6.2 Measurement Equipment Used:

Radiated Emission Test Site: Conduction 1					
EQUIPMENT TYPE	MFR	MODEL NUMBER	SERIAL NUMBER	LAST CAL.	CAL DUE.
LISN	SCHWARZBECK	NSLK 8127	8127-465	04/09/2021	04/08/2022
Coaxial Cables	N/A	Coaxial Cable	161207	12/07/2020	12/06/2021
Test Software	audix	e3	Ver. 6.11-20180413	01/01/2021	12/31/2021
EMI Test Receiver	R&S	ESCI 7	100759	07/13/2020	07/12/2021

6.3 EUT Setup:

1. The conducted emission tests were performed in the test site, using the setup in accordance with the ANSI C63.10:2013.
2. The AC/DC Power adaptor of EUT was plug-in LISN. The EUT was placed flushed with the rear of the table.
3. The LISN was connected with 120Vac/60Hz power source.

Unless otherwise stated the results shown in this test report refer only to the sample(s) tested and such sample(s) are retained for 90 days only.

除非另有說明，此報告結果僅對測試之樣品負責，同時此樣品僅保留90天。本報告未經本公司書面許可，不可部份複製。

This document is issued by the Company subject to its General Conditions of Service printed overleaf, available on request or accessible at <http://www.sgs.com.tw/Terms-and-Conditions> and for electronic format documents, subject to Terms and Conditions for Electronic Documents at <http://www.sgs.com.tw/Terms-and-Conditions>. Attention is drawn to the limitation of liability, indemnification and jurisdiction issues defined therein. Any holder of this document is advised that information contained hereon reflects the Company's findings at the time of its intervention only and within the limits of Client's instructions, if any. The Company's sole responsibility is to its Client and this document does not exonerate parties to a transaction from exercising all their rights and obligations under the transaction documents. This document cannot be reproduced except in full, without prior written approval of the Company. Any unauthorized alteration, forgery or falsification of the content or appearance of this document is unlawful and offenders may be prosecuted to the fullest extent of the law.

6.4 Test SET-UP (Block Diagram of Configuration)

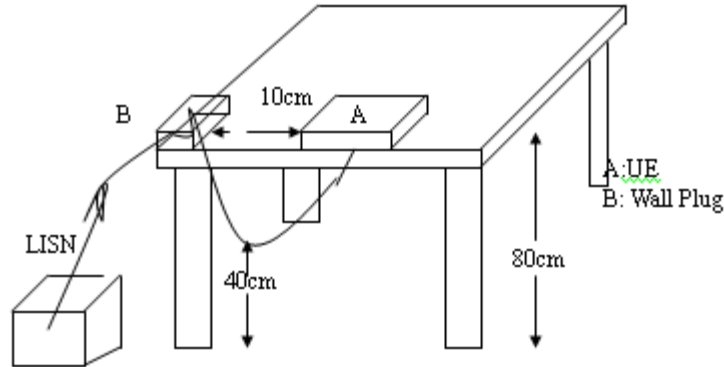

6.5 Measurement Procedure:

1. The EUT was placed on a table which is 0.8m above ground plane.
2. Maximum procedure was performed on the six highest emissions to ensure EUT compliance.
3. Repeat above procedures until all phases of power being supplied by given UE are completed

6.6 Measurement Result:

Note: Refer to next page for measurement data and plots.

Note2: The * reveals the worst-case results that closet to the limit.

Unless otherwise stated the results shown in this test report refer only to the sample(s) tested and such sample(s) are retained for 90 days only.

除非另有說明，此報告結果僅對測試之樣品負責，同時此樣品僅保留90天。本報告未經本公司書面許可，不可部份複製。

This document is issued by the Company subject to its General Conditions of Service printed overleaf, available on request or accessible at <http://www.sgs.com.tw/Terms-and-Conditions> and for electronic format documents, subject to Terms and Conditions for Electronic Documents at <http://www.sgs.com.tw/Terms-and-Conditions>. Attention is drawn to the limitation of liability, indemnification and jurisdiction issues defined therein. Any holder of this document is advised that information contained hereon reflects the Company's findings at the time of its intervention only and within the limits of Client's instructions, if any. The Company's sole responsibility is to its Client and this document does not exonerate parties to a transaction from exercising all their rights and obligations under the transaction documents. This document cannot be reproduced except in full, without prior written approval of the Company. Any unauthorized alteration, forgery or falsification of the content or appearance of this document is unlawful and offenders may be prosecuted to the fullest extent of the law.

AC POWER LINE CONDUCTED EMISSION TEST DATA

Report Number :ER/2021/50020
 Test Mode :BLE
 Power :AC 120V/60Hz
 Probe :L
 Note: :

Test Site :Conduction 6F
 Test Date :2021-06-16
 Temp./Humi. :25.3/58
 Engineer :Neo Tsai

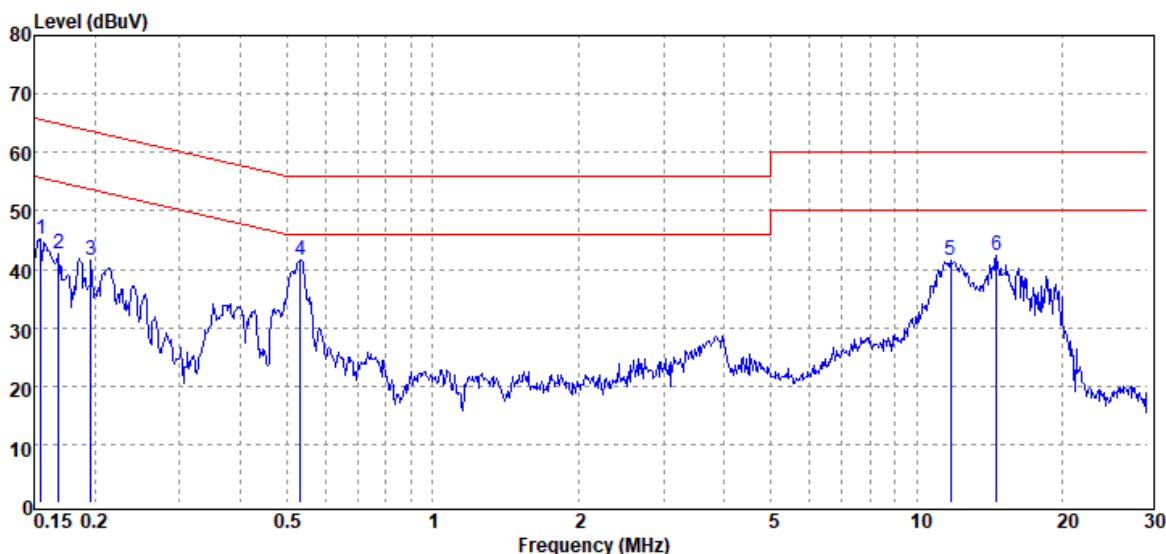

Freq. MHz	Detector Mode PK/QP/AV	Spectrum Reading Level dB μ V	Factor dB	Actual FS dB μ V	Limit dB μ V	Margin dB
0.15	Peak	45.19	0.04	45.23	65.74	-20.51
0.17	Peak	42.51	0.04	42.55	65.03	-22.48
0.20	Peak	41.37	0.04	41.41	63.76	-22.35
0.53	Peak	41.30	0.15	41.45	56.00	-14.55
11.75	Peak	40.67	0.91	41.58	60.00	-18.42
14.59	Peak	41.46	1.02	42.48	60.00	-17.52

Unless otherwise stated the results shown in this test report refer only to the sample(s) tested and such sample(s) are retained for 90 days only.

除非另有說明，此報告結果僅對測試之樣品負責，同時此樣品僅保留90天。本報告未經本公司書面許可，不可部份複製。

This document is issued by the Company subject to its General Conditions of Service printed overleaf, available on request or accessible at <http://www.sgs.com.tw/Terms-and-Conditions> and for electronic format documents, subject to Terms and Conditions for Electronic Documents at <http://www.sgs.com.tw/Terms-and-Conditions>. Attention is drawn to the limitation of liability, indemnification and jurisdiction issues defined therein. Any holder of this document is advised that information contained hereon reflects the Company's findings at the time of its intervention only and within the limits of Client's instructions, if any. The Company's sole responsibility is to its Client and this document does not exonerate parties to a transaction from exercising all their rights and obligations under the transaction documents. This document cannot be reproduced except in full, without prior written approval of the Company. Any unauthorized alteration, forgery or falsification of the content or appearance of this document is unlawful and offenders may be prosecuted to the fullest extent of the law.

Report Number :ER/2021/50020
 Test Mode :BLE
 Power :AC 120V/60Hz
 Probe :N
 Note: :

Test Site :Conduction 6F
 Test Date :2021-06-16
 Temp./Humi. :25.3/58
 Engineer :Neo Tsai

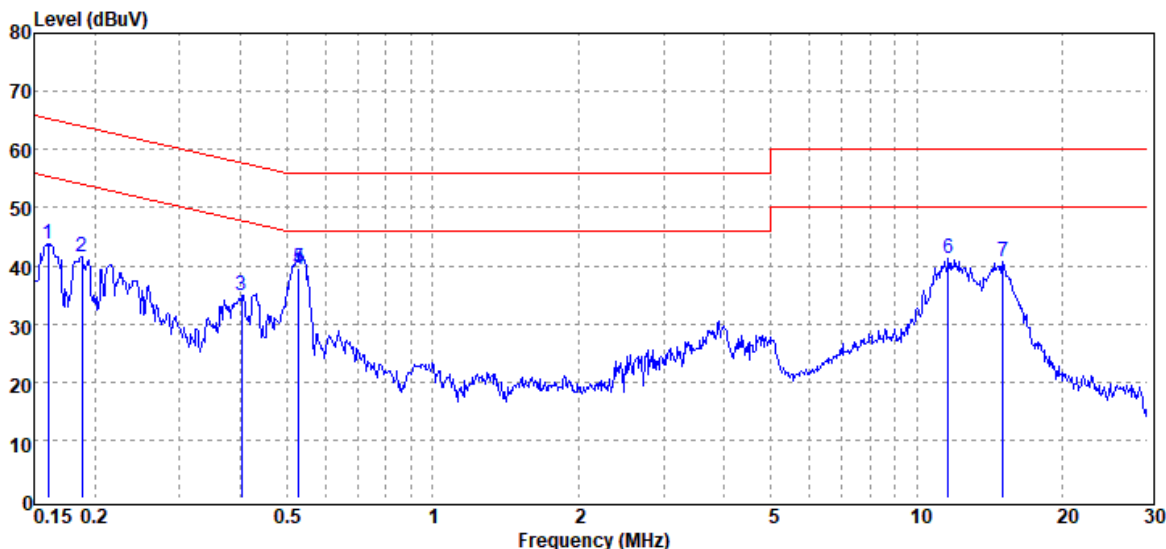

Freq. MHz	Detector Mode PK/QP/AV	Spectrum Reading Level dBμV	Factor dB	Actual FS dBμV	Limit dBμV	Margin dB
0.16	Peak	43.62	0.11	43.73	65.43	-21.70
0.19	Peak	41.36	0.11	41.47	64.11	-22.64
0.40	Peak	34.83	0.17	35.00	57.81	-22.81
0.53	Average	39.20	0.21	39.41	46.00	-6.59
0.53	QP	39.30	0.21	39.51	56.00	-16.49
11.62	Peak	40.41	0.80	41.21	60.00	-18.79
15.07	Peak	39.75	0.98	40.73	60.00	-19.27

Unless otherwise stated the results shown in this test report refer only to the sample(s) tested and such sample(s) are retained for 90 days only.

除非另有說明，此報告結果僅對測試之樣品負責，同時此樣品僅保留90天。本報告未經本公司書面許可，不可部份複製。

This document is issued by the Company subject to its General Conditions of Service printed overleaf, available on request or accessible at <http://www.sgs.com.tw/Terms-and-Conditions> and for electronic format documents, subject to Terms and Conditions for Electronic Documents at <http://www.sgs.com.tw/Terms-and-Conditions>. Attention is drawn to the limitation of liability, indemnification and jurisdiction issues defined therein. Any holder of this document is advised that information contained hereon reflects the Company's findings at the time of its intervention only and within the limits of Client's instructions, if any. The Company's sole responsibility is to its Client and this document does not exonerate parties to a transaction from exercising all their rights and obligations under the transaction documents. This document cannot be reproduced except in full, without prior written approval of the Company. Any unauthorized alteration, forgery or falsification of the content or appearance of this document is unlawful and offenders may be prosecuted to the fullest extent of the law.

7 PEAK OUTPUT POWER MEASUREMENT

7.1 Standard Applicable:

For systems using digital modulation in the 2400-2483.5 MHz bands, the limit for peak output power is 1Watt and the e.i.r.p. shall not exceed 4 W.

If the transmitting antenna of directional gain greater than 6dBi are used the peak output power from the intentional radiator shall be reduced below the above stated value by the amount in dB that the directional gain of the Antenna exceeds 6dBi.

In case of point-to-point operation, the limit has to be reduced by 1dB for every 3dB that the directional gain of Antenna exceeds 6dBi.

7.2 Measurement Equipment Used:

Conducted Emission Test Site: Conducted 4					
EQUIPMENT TYPE	MFR	MODEL NUMBER	SERIAL NUMBER	LAST CAL.	CAL DUE.
PXA Spectrum Analyzer	Agilent	N9030A	MY53120760	04/27/2021	04/26/2022
Power Meter	Anritsu	ML2496A	1804001	03/02/2021	03/01/2022
Power Sensor	Anritsu	MA2411B	1726104	03/02/2021	03/01/2022
Power Sensor	Anritsu	MA2411B	1726107	03/02/2021	03/01/2022
Attenuator	Mini-Circuit	BW-S10W2+	4	12/16/2020	12/15/2021
DC Block	Mini-Circuits	BLK-18-S+	1	12/16/2020	12/15/2021
Notebook	Lenovo	T440P	PC-014TAK	N/A	N/A

Unless otherwise stated the results shown in this test report refer only to the sample(s) tested and such sample(s) are retained for 90 days only.

除非另有說明，此報告結果僅對測試之樣品負責，同時此樣品僅保留90天。本報告未經本公司書面許可，不可部份複製。

This document is issued by the Company subject to its General Conditions of Service printed overleaf, available on request or accessible at <http://www.sgs.com.tw/Terms-and-Conditions> and for electronic format documents, subject to Terms and Conditions for Electronic Documents at <http://www.sgs.com.tw/Terms-and-Conditions>. Attention is drawn to the limitation of liability, indemnification and jurisdiction issues defined therein. Any holder of this document is advised that information contained hereon reflects the Company's findings at the time of its intervention only and within the limits of Client's instructions, if any. The Company's sole responsibility is to its Client and this document does not exonerate parties to a transaction from exercising all their rights and obligations under the transaction documents. This document cannot be reproduced except in full, without prior written approval of the Company. Any unauthorized alteration, forgery or falsification of the content or appearance of this document is unlawful and offenders may be prosecuted to the fullest extent of the law.

7.3 Test Set-up:

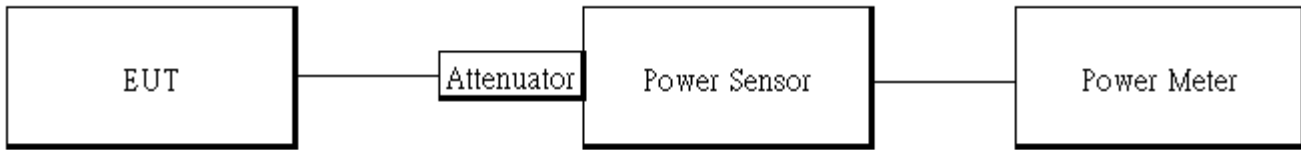

7.4 Measurement Procedure:

1. Place the EUT on the table and set it in transmitting mode.
2. The testing follows the Measurement Procedure of FCC KDB 558074 D01 DTS Meas. Guidance.
3. Remove the antenna from the EUT and then connect a low loss RF cable from the antenna port to the power meter.
4. Record the max. Reading as observed from Power Meter.
5. Repeat above procedures until all test default channel measured was complete.

Unless otherwise stated the results shown in this test report refer only to the sample(s) tested and such sample(s) are retained for 90 days only.

除非另有說明，此報告結果僅對測試之樣品負責，同時此樣品僅保留90天。本報告未經本公司書面許可，不可部份複製。

This document is issued by the Company subject to its General Conditions of Service printed overleaf, available on request or accessible at <http://www.sgs.com.tw/Terms-and-Conditions> and for electronic format documents, subject to Terms and Conditions for Electronic Documents at <http://www.sgs.com.tw/Terms-and-Conditions>. Attention is drawn to the limitation of liability, indemnification and jurisdiction issues defined therein. Any holder of this document is advised that information contained hereon reflects the Company's findings at the time of its intervention only and within the limits of Client's instructions, if any. The Company's sole responsibility is to its Client and this document does not exonerate parties to a transaction from exercising all their rights and obligations under the transaction documents. This document cannot be reproduced except in full, without prior written approval of the Company. Any unauthorized alteration, forgery or falsification of the content or appearance of this document is unlawful and offenders may be prosecuted to the fullest extent of the law.

7.5 Duty Factor:

Mode: BLE 1M

	Duty Cycle (%) = Ton / (Ton+Toff)	Duty Factor (dB) =10*log (1/Duty Cycle)	1/T (kHz)	VBW setting (kHz)
BLE	63.00	2.01	2.53	3.00

BLE_1M_LowCH00-2402

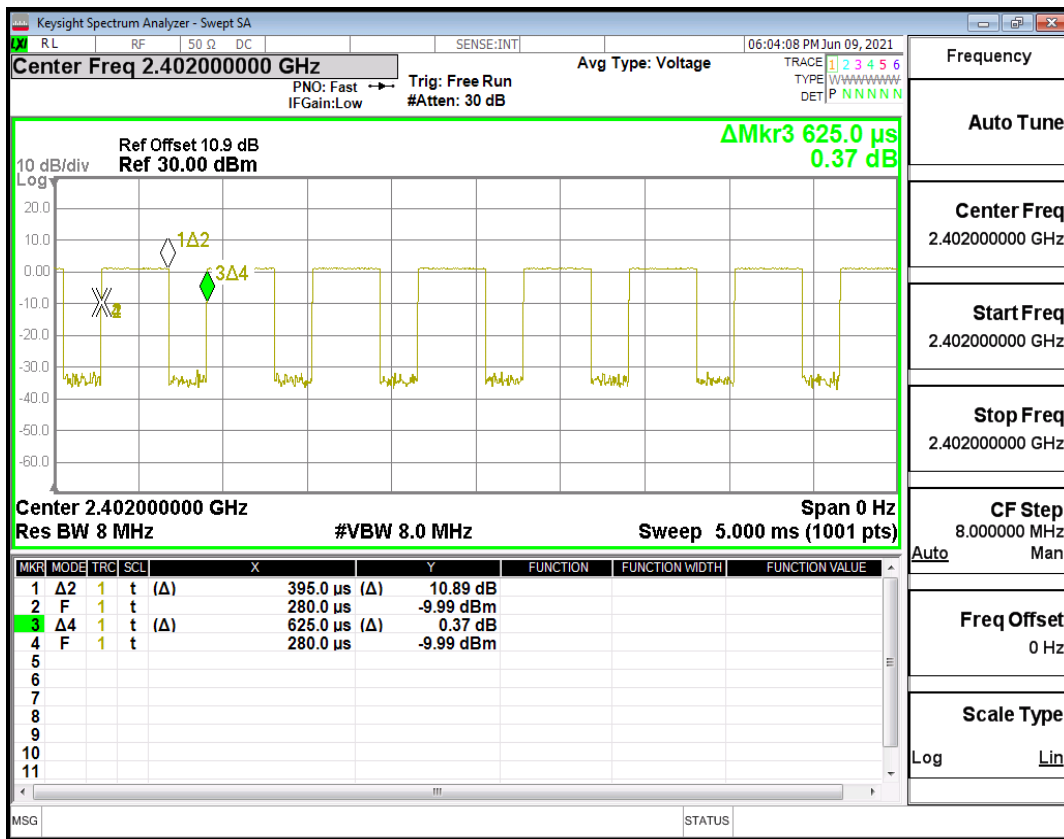

Unless otherwise stated the results shown in this test report refer only to the sample(s) tested and such sample(s) are retained for 90 days only.

除非另有說明，此報告結果僅對測試之樣品負責，同時此樣品僅保留90天。本報告未經本公司書面許可，不可部份複製。

This document is issued by the Company subject to its General Conditions of Service printed overleaf, available on request or accessible at <http://www.sgs.com.tw/Terms-and-Conditions> and for electronic format documents, subject to Terms and Conditions for Electronic Documents at <http://www.sgs.com.tw/Terms-and-Conditions>.

Attention is drawn to the limitation of liability, indemnification and jurisdiction issues defined therein. Any holder of this document is advised that information contained hereon reflects the Company's findings at the time of its intervention only and within the limits of Client's instructions, if any. The Company's sole responsibility is to its Client and this document does not exonerate parties to a transaction from exercising all their rights and obligations under the transaction documents. This document cannot be reproduced except in full, without prior written approval of the Company. Any unauthorized alteration, forgery or falsification of the content or appearance of this document is unlawful and offenders may be prosecuted to the fullest extent of the law.

Mode: BLE 2M

	Duty Cycle (%)	Duty Factor (dB)	1/T (kHz)	VBW setting (kHz)
BLE 2M	33.00	4.81	4.88	5.00

BLE_2M_LowCH00-2402



Unless otherwise stated the results shown in this test report refer only to the sample(s) tested and such sample(s) are retained for 90 days only.

除非另有說明，此報告結果僅對測試之樣品負責，同時此樣品僅保留90天。本報告未經本公司書面許可，不可部份複製。

This document is issued by the Company subject to its General Conditions of Service printed overleaf, available on request or accessible at <http://www.sgs.com.tw/Terms-and-Conditions> and for electronic format documents, subject to Terms and Conditions for Electronic Documents at <http://www.sgs.com.tw/Terms-and-Conditions>. Attention is drawn to the limitation of liability, indemnification and jurisdiction issues defined therein. Any holder of this document is advised that information contained hereon reflects the Company's findings at the time of its intervention only and within the limits of Client's instructions, if any. The Company's sole responsibility is to its Client and this document does not exonerate parties to a transaction from exercising all their rights and obligations under the transaction documents. This document cannot be reproduced except in full, without prior written approval of the Company. Any unauthorized alteration, forgery or falsification of the content or appearance of this document is unlawful and offenders may be prosecuted to the fullest extent of the law.

7.6 Output Power:

7.6.1 Peak & Avg

Mode: BLE 1M

BLE mode:

CH	Frequency (MHz)	Power set	Peak Power Output (dBm)	Required Limit (dBm)
Low	2402	default	1.22	30
Mid	2442	default	1.32	30
High	2480	default	1.33	30
CH	Frequency (MHz)	Power set	Max. Avg. Output include tune up tolerance Power (dBm)	Required Limit (dBm)
Low	2402	default	0.98	30
Mid	2442	default	1.07	30
High	2480	default	1.11	30

**Note: Measured by power meter, cable loss 10.9 dB + Duty cycle factor has been offseted to the*

Mode: BLE 2M

BLE 2M mode:

CH	Frequency (MHz)	Power set	Peak Power Output (dBm)	Required Limit (dBm)
Low	2402	default	1.39	30
Mid	2442	default	1.45	30
High	2480	default	1.44	30
BLE 2M mode:				
CH	Frequency (MHz)	Power set	Max. Avg. Output include tune up tolerance Power (dBm)	Required Limit (dBm)
Low	2402	default	1.15	30
Mid	2442	default	1.11	30
High	2480	default	1.28	30

**Note: Measured by power meter, cable loss 10.9 dB + Duty cycle factor has been offseted to the power meter for Avg. power and cable loss has been offseted for Peak power measurement.*

Unless otherwise stated the results shown in this test report refer only to the sample(s) tested and such sample(s) are retained for 90 days only.

除非另有說明，此報告結果僅對測試之樣品負責，同時此樣品僅保留90天。本報告未經本公司書面許可，不可部份複製。

This document is issued by the Company subject to its General Conditions of Service printed overleaf, available on request or accessible at <http://www.sgs.com.tw/Terms-and-Conditions> and for electronic format documents, subject to Terms and Conditions for Electronic Documents at <http://www.sgs.com.tw/Terms-and-Conditions>. Attention is drawn to the limitation of liability, indemnification and jurisdiction issues defined therein. Any holder of this document is advised that information contained hereon reflects the Company's findings at the time of its intervention only and within the limits of Client's instructions, if any. The Company's sole responsibility is to its Client and this document does not exonerate parties to a transaction from exercising all their rights and obligations under the transaction documents. This document cannot be reproduced except in full, without prior written approval of the Company. Any unauthorized alteration, forgery or falsification of the content or appearance of this document is unlawful and offenders may be prosecuted to the fullest extent of the law.

7.6.2 EIRP

Mode: BLE 1M

EIRP BLE mode

CH	Frequency (MHz)	Power set	Max. Avg. Output include tune up tolerance Power (dBm)	Antenna Gain (dBi)	EIRP (dBm)	Limit
Low	2402	default	0.98	-1.47	-0.49	4W= 36 dBm
Mid	2442	default	1.07	-1.47	-0.40	4W= 36 dBm
High	2480	default	1.11	-1.47	-0.36	4W= 36 dBm

* **Note:** EIRP = Average Power + Gain

Mode: BLE 2M

EIRP BLE 2M mode

CH	Frequency (MHz)	Power set	Max. Avg. Output include tune up tolerance Power (dBm)	Antenna Gain (dBi)	EIRP (dBm)	Limit
Low	2402	default	1.15	-1.47	-0.32	4W= 36 dBm
Mid	2442	default	1.11	-1.47	-0.36	4W= 36 dBm
High	2480	default	1.28	-1.47	-0.19	4W= 36 dBm

* **Note:** EIRP = Average Power + Gain

Unless otherwise stated the results shown in this test report refer only to the sample(s) tested and such sample(s) are retained for 90 days only.

除非另有說明，此報告結果僅對測試之樣品負責，同時此樣品僅保留90天。本報告未經本公司書面許可，不可部份複製。

This document is issued by the Company subject to its General Conditions of Service printed overleaf, available on request or accessible at <http://www.sgs.com.tw/Terms-and-Conditions> and for electronic format documents, subject to Terms and Conditions for Electronic Documents at <http://www.sgs.com.tw/Terms-and-Conditions>. Attention is drawn to the limitation of liability, indemnification and jurisdiction issues defined therein. Any holder of this document is advised that information contained hereon reflects the Company's findings at the time of its intervention only and within the limits of Client's instructions, if any. The Company's sole responsibility is to its Client and this document does not exonerate parties to a transaction from exercising all their rights and obligations under the transaction documents. This document cannot be reproduced except in full, without prior written approval of the Company. Any unauthorized alteration, forgery or falsification of the content or appearance of this document is unlawful and offenders may be prosecuted to the fullest extent of the law.

8 EMISSION BANDWIDTH MEASUREMENT

8.1 Standard Applicable

The minimum 6 dB bandwidth shall be at least 500 kHz .

8.2 Measurement Equipment Used

Conducted Emission Test Site: Conducted 4					
EQUIPMENT TYPE	MFR	MODEL NUMBER	SERIAL NUMBER	LAST CAL.	CAL DUE.
PXA Spectrum Analyzer	Agilent	N9030A	MY53120760	04/27/2021	04/26/2022
Attenuator	Mini-Circuit	BW-S10W2+	4	12/16/2020	12/15/2021
DC Block	Mini-Circuits	BLK-18-S+	1	12/16/2020	12/15/2021
Notebook	Lenovo	T440P	PC-014TAK	N/A	N/A

8.3 Test Set-up:

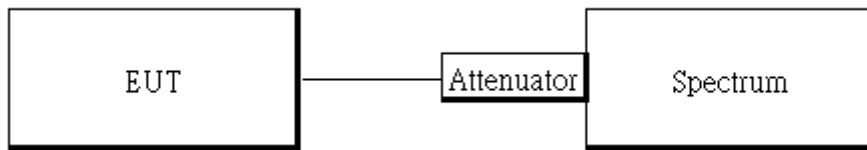

Unless otherwise stated the results shown in this test report refer only to the sample(s) tested and such sample(s) are retained for 90 days only.

除非另有說明，此報告結果僅對測試之樣品負責，同時此樣品僅保留90天。本報告未經本公司書面許可，不可部份複製。

This document is issued by the Company subject to its General Conditions of Service printed overleaf, available on request or accessible at <http://www.sgs.com.tw/Terms-and-Conditions> and for electronic format documents, subject to Terms and Conditions for Electronic Documents at <http://www.sgs.com.tw/Terms-and-Conditions>. Attention is drawn to the limitation of liability, indemnification and jurisdiction issues defined therein. Any holder of this document is advised that information contained hereon reflects the Company's findings at the time of its intervention only and within the limits of Client's instructions, if any. The Company's sole responsibility is to its Client and this document does not exonerate parties to a transaction from exercising all their rights and obligations under the transaction documents. This document cannot be reproduced except in full, without prior written approval of the Company. Any unauthorized alteration, forgery or falsification of the content or appearance of this document is unlawful and offenders may be prosecuted to the fullest extent of the law.

8.4 Measurement Procedure:

1. Place the EUT on the table and set it in transmitting mode.
2. The testing follows the Measurement Procedure of FCC KDB 558074 D01 DTS Meas. Guidance.
3. Remove the antenna from the EUT and then connect a low loss RF cable from the antenna port to the spectrum analyzer.
4. Set the spectrum analyzer as
RBW= 100 kHz ,
VBW = 3 X RBW,
Span= 2 to 5 times of the OBW,
Sweep=auto,
Detector = Peak, and Max hold for -6dB Bandwidth test.
5. Set the spectrum analyzer as
RBW= 1 % to 5% of 99% Bandwidth ,
VBW \geq 3 X RBW,
Span= large enough to capture all products of the modulation process,
Sweep=auto,
Detector = Peak, and Max hold for 99% Bandwidth test.
6. Mark the peak frequency and 99%dB (upper and lower) frequency
7. Repeat above procedures until all test default channel is completed

Unless otherwise stated the results shown in this test report refer only to the sample(s) tested and such sample(s) are retained for 90 days only.

除非另有說明，此報告結果僅對測試之樣品負責，同時此樣品僅保留90天。本報告未經本公司書面許可，不可部份複製。

This document is issued by the Company subject to its General Conditions of Service printed overleaf, available on request or accessible at <http://www.sgs.com.tw/Terms-and-Conditions> and for electronic format documents, subject to Terms and Conditions for Electronic Documents at <http://www.sgs.com.tw/Terms-and-Conditions>. Attention is drawn to the limitation of liability, indemnification and jurisdiction issues defined therein. Any holder of this document is advised that information contained hereon reflects the Company's findings at the time of its intervention only and within the limits of Client's instructions, if any. The Company's sole responsibility is to its Client and this document does not exonerate parties to a transaction from exercising all their rights and obligations under the transaction documents. This document cannot be reproduced except in full, without prior written approval of the Company. Any unauthorized alteration, forgery or falsification of the content or appearance of this document is unlawful and offenders may be prosecuted to the fullest extent of the law.

8.5 Measurement Result:

Mode: BLE 1M

BLE mode

Frequency (MHz)	6dB BW (MHz)	Required BW (MHz)	Result
2402	0.6682	≥ 0.5	PASS
2442	0.6727	≥ 0.5	PASS
2480	0.6723	≥ 0.5	PASS

Mode: BLE 2M

BLE 2M mode

Frequency (MHz)	6dB BW (MHz)	BW (MHz)	Result
2402	1.14	≥ 0.5	PASS
2442	1.143	≥ 0.5	PASS
2480	1.143	≥ 0.5	PASS

Mode: BLE 1M

BLE mode

Frequency (MHz)	99%Bandwidth (MHz)
2402	1.0281
2442	1.0295
2480	1.03

Mode: BLE 2M

BLE 2M mode

Frequency (MHz)	99%Bandwidth (MHz)
2402	2.0374
2442	2.0354
2480	2.0351

Unless otherwise stated the results shown in this test report refer only to the sample(s) tested and such sample(s) are retained for 90 days only.

除非另有說明，此報告結果僅對測試之樣品負責，同時此樣品僅保留90天。本報告未經本公司書面許可，不可部份複製。

This document is issued by the Company subject to its General Conditions of Service printed overleaf, available on request or accessible at <http://www.sgs.com.tw/Terms-and-Conditions> and for electronic format documents, subject to Terms and Conditions for Electronic Documents at <http://www.sgs.com.tw/Terms-and-Conditions>. Attention is drawn to the limitation of liability, indemnification and jurisdiction issues defined therein. Any holder of this document is advised that information contained hereon reflects the Company's findings at the time of its intervention only and within the limits of Client's instructions, if any. The Company's sole responsibility is to its Client and this document does not exonerate parties to a transaction from exercising all their rights and obligations under the transaction documents. This document cannot be reproduced except in full, without prior written approval of the Company. Any unauthorized alteration, forgery or falsification of the content or appearance of this document is unlawful and offenders may be prosecuted to the fullest extent of the law.

OBW_BLE 1M_LowCH00-2402MHz

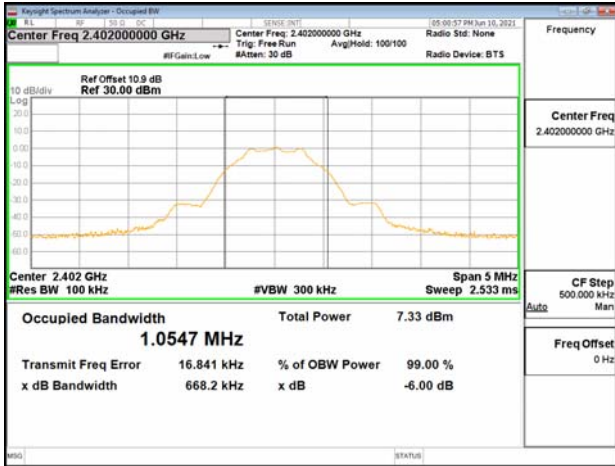

OBW_BLE 2M_LowCH00-2402MHz

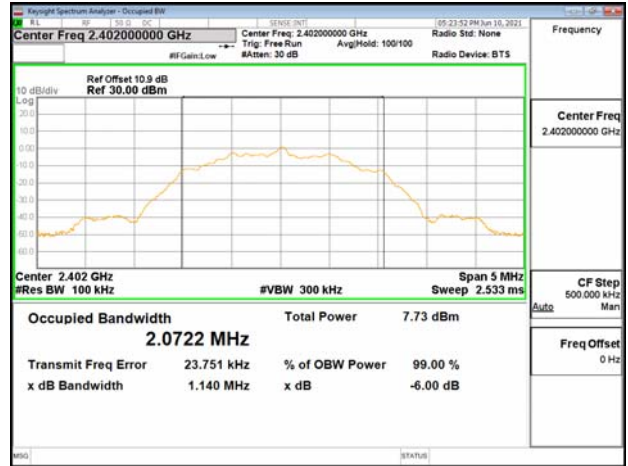

OBW_BLE 1M_MidCH20-2442MHz



OBW_BLE 2M_MidCH20-2442MHz

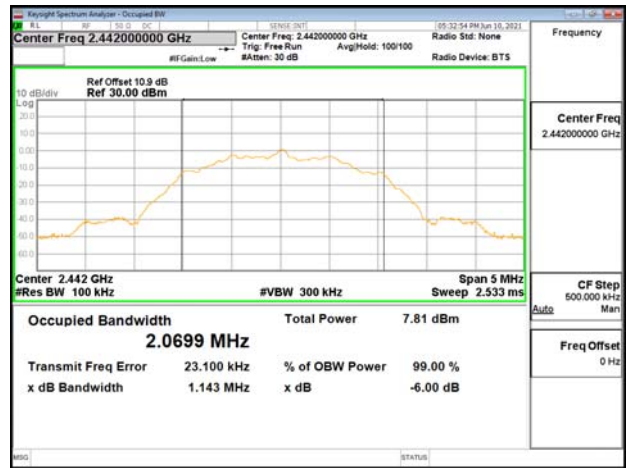

OBW_BLE 1M_HighCH39-2480MHz



OBW_BLE 2M_HighCH39-2480MHz

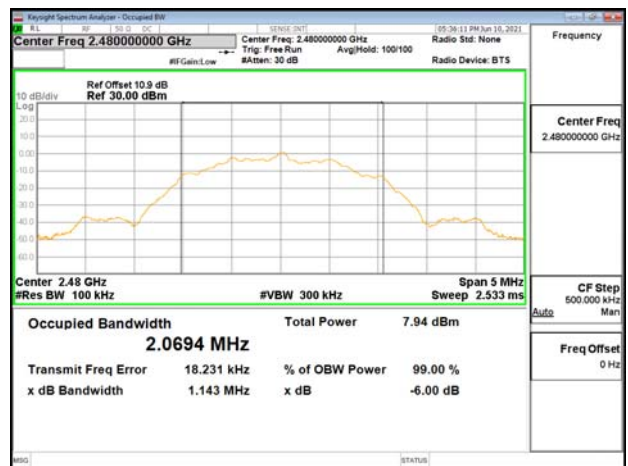

Unless otherwise stated the results shown in this test report refer only to the sample(s) tested and such sample(s) are retained for 90 days only.

除非另有說明，此報告結果僅對測試之樣品負責，同時此樣品僅保留90天。本報告未經本公司書面許可，不可部份複製。

This document is issued by the Company subject to its General Conditions of Service printed overleaf, available on request or accessible at <http://www.sgs.com.tw/Terms-and-Conditions> and for electronic format documents, subject to Terms and Conditions for Electronic Documents at <http://www.sgs.com.tw/Terms-and-Conditions>. Attention is drawn to the limitation of liability, indemnification and jurisdiction issues defined therein. Any holder of this document is advised that information contained hereon reflects the Company's findings at the time of its intervention only and within the limits of Client's instructions, if any. The Company's sole responsibility is to its Client and this document does not exonerate parties to a transaction from exercising all their rights and obligations under the transaction documents. This document cannot be reproduced except in full, without prior written approval of the Company. Any unauthorized alteration, forgery or falsification of the content or appearance of this document is unlawful and offenders may be prosecuted to the fullest extent of the law.

IC OBW_BLE 1M_LowCH00-2402MHz

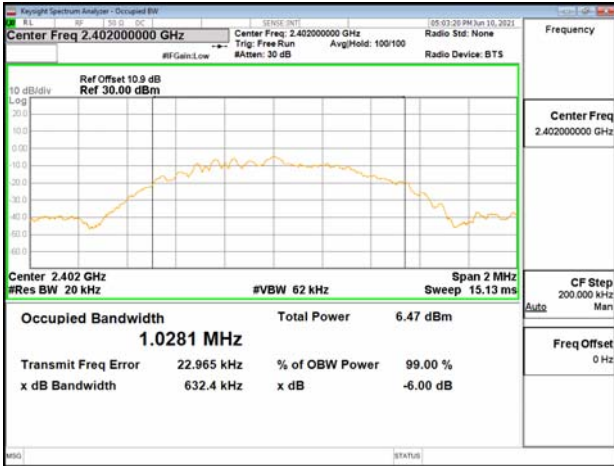

IC OBW_BLE 2M_LowCH00-2402MHz

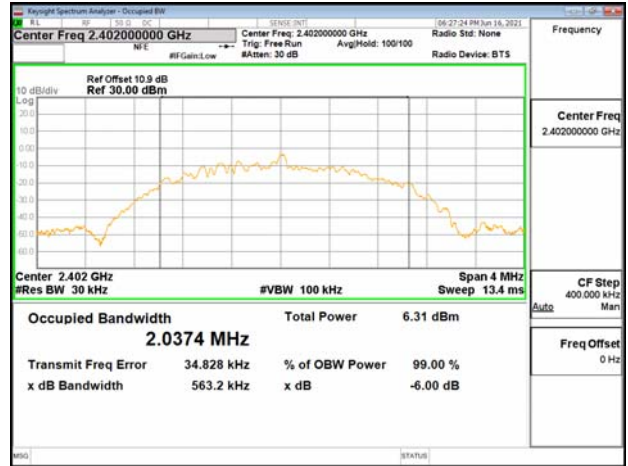

IC OBW_BLE 1M_MidCH20-2442MHz

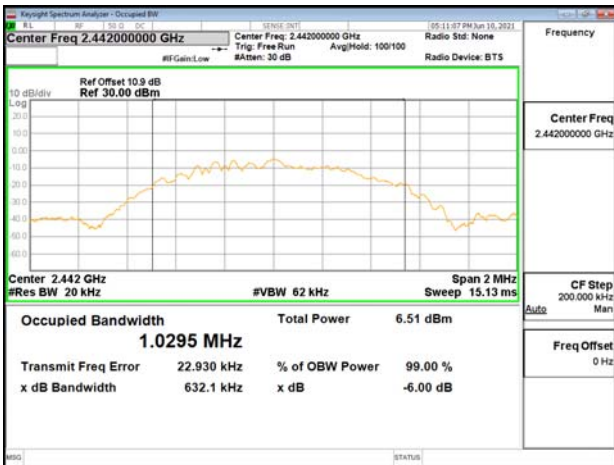

IC OBW_BLE 2M_MidCH20-2442MHz



IC OBW_BLE 1M_HighCH39-2480MHz



IC OBW_BLE 2M_HighCH39-2480MHz



Unless otherwise stated the results shown in this test report refer only to the sample(s) tested and such sample(s) are retained for 90 days only.

除非另有說明，此報告結果僅對測試之樣品負責，同時此樣品僅保留90天。本報告未經本公司書面許可，不可部份複製。

This document is issued by the Company subject to its General Conditions of Service printed overleaf, available on request or accessible at <http://www.sgs.com.tw/Terms-and-Conditions> and for electronic format documents, subject to Terms and Conditions for Electronic Documents at <http://www.sgs.com.tw/Terms-and-Conditions>. Attention is drawn to the limitation of liability, indemnification and jurisdiction issues defined therein. Any holder of this document is advised that information contained hereon reflects the Company's findings at the time of its intervention only and within the limits of Client's instructions, if any. The Company's sole responsibility is to its Client and this document does not exonerate parties to a transaction from exercising all their rights and obligations under the transaction documents. This document cannot be reproduced except in full, without prior written approval of the Company. Any unauthorized alteration, forgery or falsification of the content or appearance of this document is unlawful and offenders may be prosecuted to the fullest extent of the law.

9 CONDUCTED BAND EDGES AND SPURIOUS EMISSION MEASUREMENT

9.1 Standard Applicable

In any 100 kHz bandwidth outside the frequency band in which the spread spectrum or digitally modulated intentional radiator is operating, the radio frequency power that is produced by the intentional radiator shall be at least 20 dB below that in the 100 kHz bandwidth within the band that contains the highest level of the desired power, based on either an RF conducted or a radiated measurement, provided the transmitter demonstrates compliance with the peak conducted power limits. In addition, radiated emissions which fall in the restricted bands, as defined in §15.205(a) & RSS-Gen §8.10, must also comply with the radiated emission limits specified in §15.209(a) & RSS-Gen §8.9.

9.2 Measurement Equipment Used:

Conducted Emission Test Site: Conducted 4					
EQUIPMENT TYPE	MFR	MODEL NUMBER	SERIAL NUMBER	LAST CAL.	CAL DUE.
PXA Spectrum Analyzer	Agilent	N9030A	MY53120760	04/27/2021	04/26/2022
Attenuator	Mini-Circuit	BW-S10W2+	4	12/16/2020	12/15/2021
DC Block	Mini-Circuits	BLK-18-S+	1	12/16/2020	12/15/2021
Notebook	Lenovo	T440P	PC-014TAK	N/A	N/A

9.3 Test SET-UP:

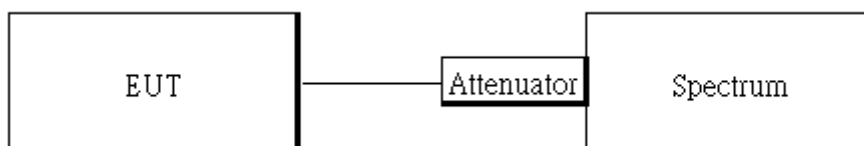

9.4 Measurement Procedure

9.4.1 Reference Level of Emission Limit:

1. Set analyzer center frequency to DTS channel center frequency.
2. The testing follows the Measurement Procedure of FCC KDB 558074 D01 DTS Meas. Guidance.
3. Set the span to 1.5 times the DTS channel bandwidth.
4. Set the RBW = 100kHz & VBW = 300 kHz.
5. Detector = peak.
6. Sweep time = auto couple.

Unless otherwise stated the results shown in this test report refer only to the sample(s) tested and such sample(s) are retained for 90 days only.

除非另有說明，此報告結果僅對測試之樣品負責，同時此樣品僅保留90天。本報告未經本公司書面許可，不可部份複製。

This document is issued by the Company subject to its General Conditions of Service printed overleaf, available on request or accessible at <http://www.sgs.com.tw/Terms-and-Conditions> and for electronic format documents, subject to Terms and Conditions for Electronic Documents at <http://www.sgs.com.tw/Terms-and-Conditions>. Attention is drawn to the limitation of liability, indemnification and jurisdiction issues defined therein. Any holder of this document is advised that information contained hereon reflects the Company's findings at the time of its intervention only and within the limits of Client's instructions, if any. The Company's sole responsibility is to its Client and this document does not exonerate parties to a transaction from exercising all their rights and obligations under the transaction documents. This document cannot be reproduced except in full, without prior written approval of the Company. Any unauthorized alteration, forgery or falsification of the content or appearance of this document is unlawful and offenders may be prosecuted to the fullest extent of the law.

7. Trace mode = max hold.
8. Allow trace to fully stabilize.
9. Use the peak marker function to determine the maximum amplitude level.

9.4.2 Conducted Band Edge:

1. To connect Antenna Port of EUT to Spectrum.
2. The testing follows the Measurement Procedure of FCC KDB 558074 D01 DTS Meas. Guidance.
3. Remove the antenna from the EUT and then connect a low loss RF cable from the antenna port to the spectrum analyzer.
4. Set start to edge frequency, and stop frequency of spectrum analyzer so as to encompass the spectrum to be examined.
5. Set the spectrum analyzer as RBW=100 kHz, VBW=300 kHz, Detector = Peak, Sweep = auto
6. Set DL as the limit = reading on marker of reference level measurement – 20dBm
7. Mark the highest readings of the emissions outside of 2400MHz~2483.5MHz.
8. Repeat above procedures until all default test channel (low and high) was complete.

9.4.3 Conducted Spurious Emission:

1. To connect Antenna Port of EUT to Spectrum.
2. The testing follows the Measurement Procedure of FCC KDB 558074 D01 DTS Meas. Guidance.
3. Set RBW = 100 kHz & VBW=300 kHz, Detector =Peak, Sweep = Auto
4. Allow trace to fully stabilize.
5. Use the peak marker function to determine the maximum power level in any 100 kHz band segment within the fundamental EBW.
6. Repeat above procedures until all default test channel measured were complete.

Unless otherwise stated the results shown in this test report refer only to the sample(s) tested and such sample(s) are retained for 90 days only.

除非另有說明，此報告結果僅對測試之樣品負責，同時此樣品僅保留90天。本報告未經本公司書面許可，不可部份複製。

This document is issued by the Company subject to its General Conditions of Service printed overleaf, available on request or accessible at <http://www.sgs.com.tw/Terms-and-Conditions> and for electronic format documents, subject to Terms and Conditions for Electronic Documents at <http://www.sgs.com.tw/Terms-and-Conditions>. Attention is drawn to the limitation of liability, indemnification and jurisdiction issues defined therein. Any holder of this document is advised that information contained hereon reflects the Company's findings at the time of its intervention only and within the limits of Client's instructions, if any. The Company's sole responsibility is to its Client and this document does not exonerate parties to a transaction from exercising all their rights and obligations under the transaction documents. This document cannot be reproduced except in full, without prior written approval of the Company. Any unauthorized alteration, forgery or falsification of the content or appearance of this document is unlawful and offenders may be prosecuted to the fullest extent of the law.

9.5 Measurement Result

Mode: BLE 1M

Reference Level of Limit

Frequency (MHz)	RF Power Density (dBm)	Reference Level of Limit = PSD - 20dB (dBm)
2402	0.65	-19.35
2442	0.58	-19.42
2480	0.79	-19.21

NOTE: cable loss as 10.9dB that offsets in the spectrum

NOTE: Refer to next page for plots.

Mode: BLE 2M

Reference Level of Limit

Frequency (MHz)	RF Power Density (dBm)	Reference Level of Limit = PSD - 20dB (dBm)
2402	0.63	-19.37
2442	0.62	-19.38
2480	0.78	-19.22

NOTE: cable loss as 10.9dB that offsets in the spectrum

NOTE: Refer to next page for plots.

Unless otherwise stated the results shown in this test report refer only to the sample(s) tested and such sample(s) are retained for 90 days only.

除非另有說明，此報告結果僅對測試之樣品負責，同時此樣品僅保留90天。本報告未經本公司書面許可，不可部份複製。

This document is issued by the Company subject to its General Conditions of Service printed overleaf, available on request or accessible at <http://www.sgs.com.tw/Terms-and-Conditions> and for electronic format documents, subject to Terms and Conditions for Electronic Documents at <http://www.sgs.com.tw/Terms-and-Conditions>. Attention is drawn to the limitation of liability, indemnification and jurisdiction issues defined therein. Any holder of this document is advised that information contained hereon reflects the Company's findings at the time of its intervention only and within the limits of Client's instructions, if any. The Company's sole responsibility is to its Client and this document does not exonerate parties to a transaction from exercising all their rights and obligations under the transaction documents. This document cannot be reproduced except in full, without prior written approval of the Company. Any unauthorized alteration, forgery or falsification of the content or appearance of this document is unlawful and offenders may be prosecuted to the fullest extent of the law.

Reference Level_BLE 1M_LowCH00-2402MHz



Reference Level_BLE 2M_LowCH00-2402MHz



Reference Level_BLE 1M_MidCH20-2442MHz



Reference Level_BLE 2M_MidCH20-2442MHz



Reference Level_BLE 1M_HighCH39-2480MHz



Reference Level_BLE 2M_HighCH39-2480MHz



Unless otherwise stated the results shown in this test report refer only to the sample(s) tested and such sample(s) are retained for 90 days only.

除非另有說明，此報告結果僅對測試之樣品負責，同時此樣品僅保留90天。本報告未經本公司書面許可，不可部份複製。

This document is issued by the Company subject to its General Conditions of Service printed overleaf, available on request or accessible at <http://www.sgs.com.tw/Terms-and-Conditions> and for electronic format documents, subject to Terms and Conditions for Electronic Documents at <http://www.sgs.com.tw/Terms-and-Conditions>. Attention is drawn to the limitation of liability, indemnification and jurisdiction issues defined therein. Any holder of this document is advised that information contained hereon reflects the Company's findings at the time of its intervention only and within the limits of Client's instructions, if any. The Company's sole responsibility is to its Client and this document does not exonerate parties to a transaction from exercising all their rights and obligations under the transaction documents. This document cannot be reproduced except in full, without prior written approval of the Company. Any unauthorized alteration, forgery or falsification of the content or appearance of this document is unlawful and offenders may be prosecuted to the fullest extent of the law.

Band Edge_BLE 1M_LowCH00-2402MHz



Band Edge_BLE 2M_LowCH00-2402MHz



Band Edge_BLE 1M_HighCH39-2480MHz

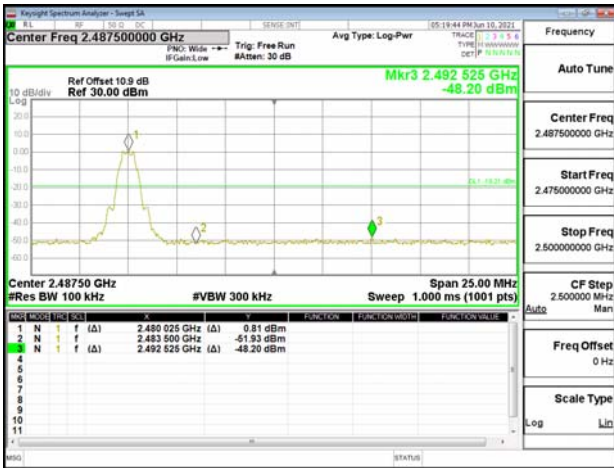

Band Edge_BLE 2M_HighCH39-2480MHz

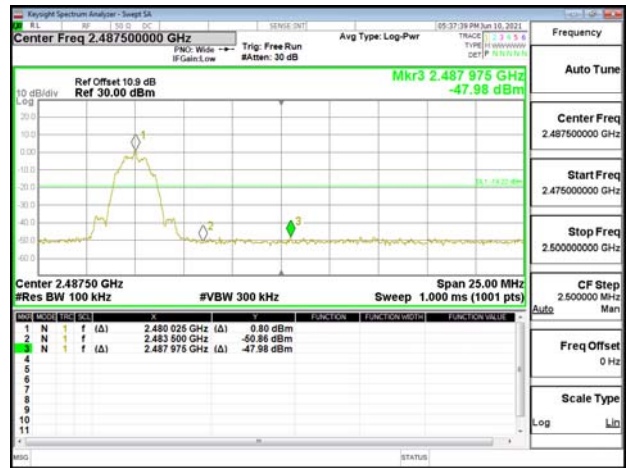

Spurious Emission_BLE 1M_LowCH00-2402MHz



Spurious Emission_BLE 2M_LowCH00-2402MHz

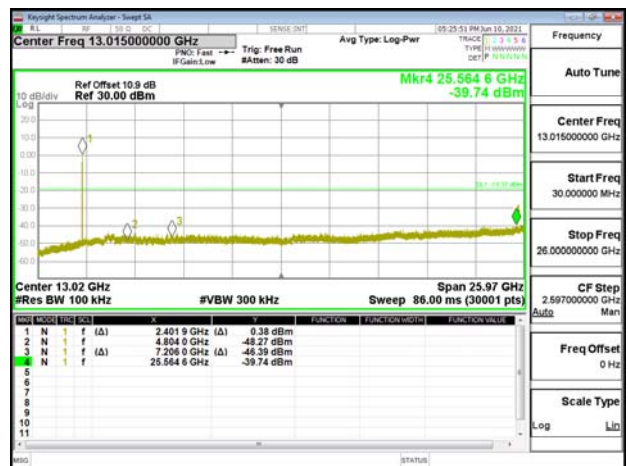

Unless otherwise stated the results shown in this test report refer only to the sample(s) tested and such sample(s) are retained for 90 days only.

除非另有說明，此報告結果僅對測試之樣品負責，同時此樣品僅保留90天。本報告未經本公司書面許可，不可部份複製。

This document is issued by the Company subject to its General Conditions of Service printed overleaf, available on request or accessible at <http://www.sgs.com.tw/Terms-and-Conditions> and for electronic format documents, subject to Terms and Conditions for Electronic Documents at <http://www.sgs.com.tw/Terms-and-Conditions>. Attention is drawn to the limitation of liability, indemnification and jurisdiction issues defined therein. Any holder of this document is advised that information contained hereon reflects the Company's findings at the time of its intervention only and within the limits of Client's instructions, if any. The Company's sole responsibility is to its Client and this document does not exonerate parties to a transaction from exercising all their rights and obligations under the transaction documents. This document cannot be reproduced except in full, without prior written approval of the Company. Any unauthorized alteration, forgery or falsification of the content or appearance of this document is unlawful and offenders may be prosecuted to the fullest extent of the law.

Spurious Emission_BLE 1M_MidCH20-2442MHz



Spurious Emission_BLE 2M_MidCH20-2442MHz

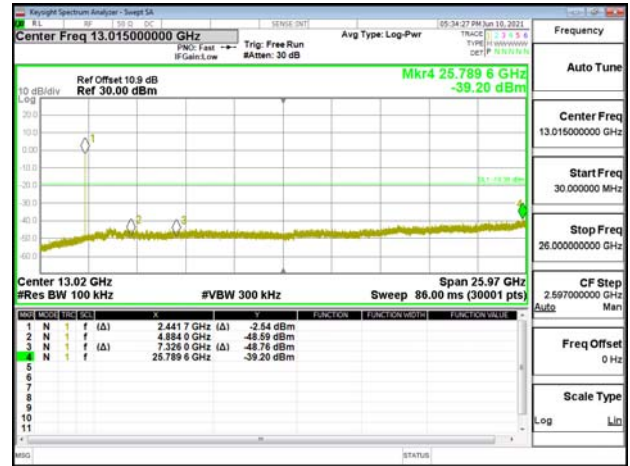

Spurious Emission_BLE 1M_HighCH39-2480MHz



Spurious Emission_BLE 2M_HighCH39-2480MHz

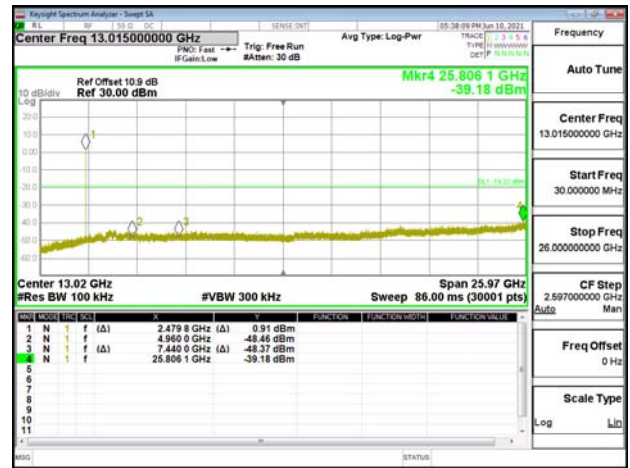

Unless otherwise stated the results shown in this test report refer only to the sample(s) tested and such sample(s) are retained for 90 days only.

除非另有說明，此報告結果僅對測試之樣品負責，同時此樣品僅保留90天。本報告未經本公司書面許可，不可部份複製。
This document is issued by the Company subject to its General Conditions of Service printed overleaf, available on request or accessible at <http://www.sgs.com.tw/Terms-and-Conditions> and for electronic format documents, subject to Terms and Conditions for Electronic Documents at <http://www.sgs.com.tw/Terms-and-Conditions>. Attention is drawn to the limitation of liability, indemnification and jurisdiction issues defined therein. Any holder of this document is advised that information contained hereon reflects the Company's findings at the time of its intervention only and within the limits of Client's instructions, if any. The Company's sole responsibility is to its Client and this document does not exonerate parties to a transaction from exercising all their rights and obligations under the transaction of this document is unlawful and offenders may be prosecuted to the fullest extent of the law.

10 RADIATED BANDEDGE AND SPURIOUS EMISSION MEASUREMENT

10.1 Standard Applicable

In any 100 kHz bandwidth outside the frequency band in which the spread spectrum or digitally modulated intentional radiator is operating, the radio frequency power that is produced by the intentional radiator shall be at least 20 dB below that in the 100 kHz bandwidth within the band that contains the highest level of the desired power, based on either an RF conducted or a radiated measurement, provided the transmitter demonstrates compliance with the peak conducted power limits. In addition, radiated emissions which fall in the restricted bands must also comply with the §15.209 and RSS-Gen §8.9 Table 5 and 6 limit as below.

And according to §15.33(a) (1) & RSS-Gen §6.13.2.a for an intentional radiator operates below 10GHz, the frequency range of measurements: to the tenth harmonic of the highest fundamental frequency or to 40GHz, whichever is lower.

Frequency (MHz)	Field strength (microvolts/meter)	Distance (meters)
0.009-0.490	2400/F(kHz)	300
0.490-1.705	24000/F(kHz)	30
1.705-30	30	30
30-88	100	3
88-216	150	3
216-960	200	3
Above 960	500	3

Note:

1. The lower limit shall apply at the transition frequencies.
2. Emission level (dBµV/m) = 20 log Emission level (µV/m)

Unless otherwise stated the results shown in this test report refer only to the sample(s) tested and such sample(s) are retained for 90 days only.

除非另有說明，此報告結果僅對測試之樣品負責，同時此樣品僅保留90天。本報告未經本公司書面許可，不可部份複製。

This document is issued by the Company subject to its General Conditions of Service printed overleaf, available on request or accessible at <http://www.sgs.com.tw/Terms-and-Conditions> and for electronic format documents, subject to Terms and Conditions for Electronic Documents at <http://www.sgs.com.tw/Terms-and-Conditions>. Attention is drawn to the limitation of liability, indemnification and jurisdiction issues defined therein. Any holder of this document is advised that information contained hereon reflects the Company's findings at the time of its intervention only and within the limits of Client's instructions, if any. The Company's sole responsibility is to its Client and this document does not exonerate parties to a transaction from exercising all their rights and obligations under the transaction documents. This document cannot be reproduced except in full, without prior written approval of the Company. Any unauthorized alteration, forgery or falsification of the content or appearance of this document is unlawful and offenders may be prosecuted to the fullest extent of the law.

10.2 Measurement Equipment Used

Radiated Emission Test Site: SAC 1					
EQUIPMENT TYPE	MFR	MODEL NUMBER	SERIAL NUMBER	LAST CAL.	CAL DUE.
Horn Antenna	SCHWARZBECK	BBHA9170	184	12/11/2020	12/10/2021
Site Cal	SGS	SAC I chamber	N/A	01/01/2021	12/31/2021
Horn Antenna	SCHWARZBECK	BBHA9120D	D803	12/17/2020	12/16/2021
Bi-log Antenna	TESEO	CBL 6112D	35242 & AT-N0555	01/13/2021	01/12/2022
Loop Antenna	ETS.LINDGREN	6502	148045	10/19/2020	10/18/2021
Spectrum Analyzer	Agilent	E4446A	MY51100003	10/29/2020	10/28/2021
Test Software	audix	e3	Ver. 6.11-20180413	01/01/2021	12/31/2021
EMI Test Receiver	R&S	ESCI 7	100759	07/13/2020	07/12/2021
Pre-Amplifier	EMC Instruments	EMC184045B	980135	12/16/2020	12/15/2021
Pre-Amplifier	HP	8449B	3008A01973	12/16/2020	12/15/2021
Pre-Amplifier	HP	8447D	2944A09469	12/16/2020	12/15/2021
Attenuator	Mini-Circuit	BW-S10W2+	4	12/16/2020	12/15/2021
Bandreject Filter 2400-2483.5	EWT	EWT-14-0166	M1	12/16/2020	12/15/2021
3.2GHz High Pass Filter	WI	WHKX10-2624-80SS	3	04/20/2021	12/15/2021
Coaxial Cable	Huber Suhner	succoflex 102	MY2622/2	12/16/2020	12/15/2021
Coaxial Cable	Huber Suhner	succoflex 104A	800086/4a	12/16/2020	12/15/2021
Coaxial Cable	Huber Suhner	EMC 104-SM-SM-2000	160123	12/16/2020	12/15/2021
Coaxial Cable	Huber Suhner	SUCOFLEX 106	76096/6	12/16/2020	12/15/2021
Coaxial Cable	Huber Suhner	SUCOFLEX 102	MY2630/2	12/16/2020	12/15/2021
Coaxial Cable	Huber Suhner	SUCOFLEX 102	MY22962/2	12/16/2020	12/15/2021

Unless otherwise stated the results shown in this test report refer only to the sample(s) tested and such sample(s) are retained for 90 days only.

除非另有說明，此報告結果僅對測試之樣品負責，同時此樣品僅保留90天。本報告未經本公司書面許可，不可部份複製。

This document is issued by the Company subject to its General Conditions of Service printed overleaf, available on request or accessible at <http://www.sgs.com.tw/Terms-and-Conditions> and for electronic format documents, subject to Terms and Conditions for Electronic Documents at <http://www.sgs.com.tw/Terms-and-Conditions>. Attention is drawn to the limitation of liability, indemnification and jurisdiction issues defined therein. Any holder of this document is advised that information contained hereon reflects the Company's findings at the time of its intervention only and within the limits of Client's instructions, if any. The Company's sole responsibility is to its Client and this document does not exonerate parties to a transaction from exercising all their rights and obligations under the transaction documents. This document cannot be reproduced except in full, without prior written approval of the Company. Any unauthorized alteration, forgery or falsification of the content or appearance of this document is unlawful and offenders may be prosecuted to the fullest extent of the law.

10.3 Test SET-UP

(A) Radiated Emission Test Set-Up, Frequency Below 30MHz.

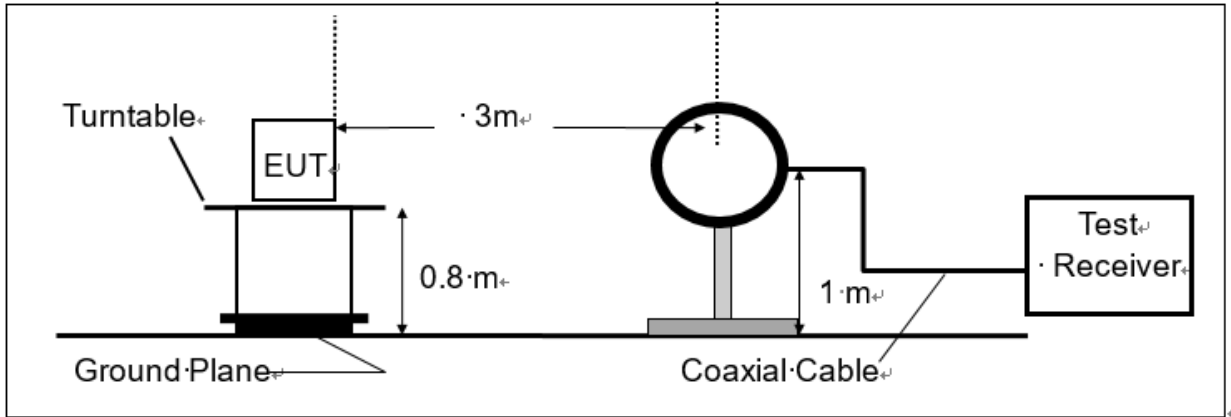

(B) Radiated Emission Test Set-Up, Frequency From 30MHz to 1000MHz

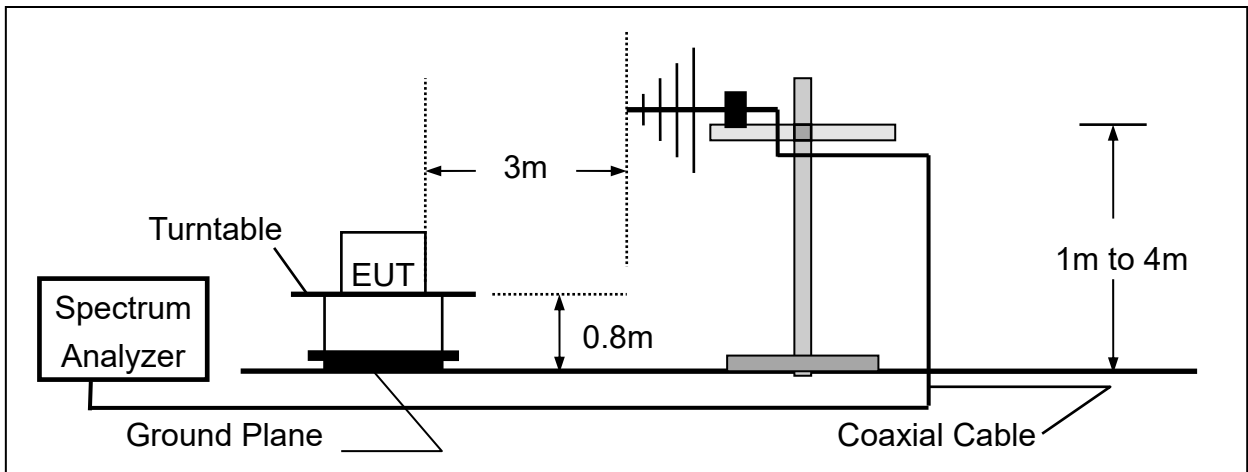

(C) Radiated Emission Test Set-Up, Frequency Above 1GHz

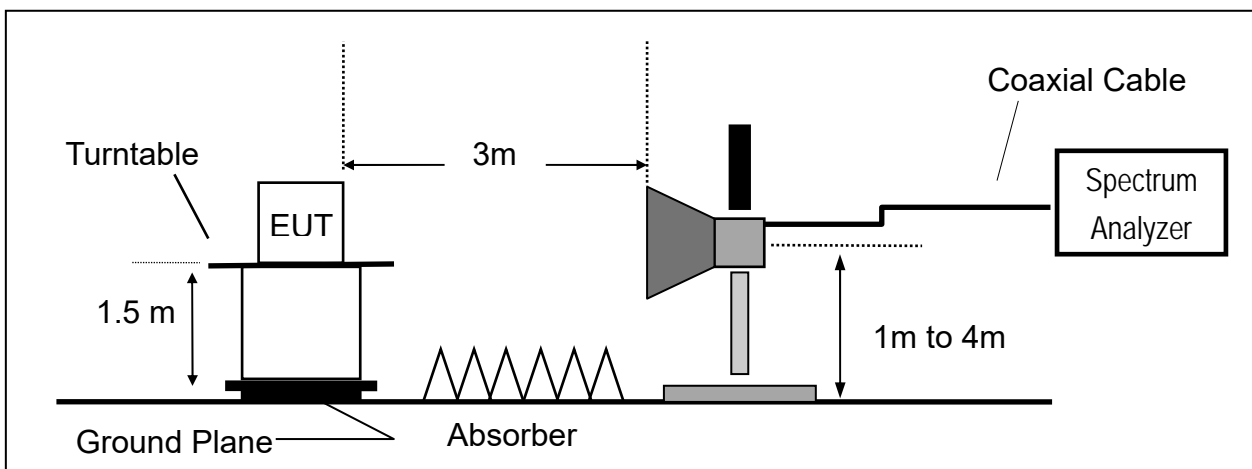

Unless otherwise stated the results shown in this test report refer only to the sample(s) tested and such sample(s) are retained for 90 days only.

除非另有說明，此報告結果僅對測試之樣品負責，同時此樣品僅保留90天。本報告未經本公司書面許可，不可部份複製。

This document is issued by the Company subject to its General Conditions of Service printed overleaf, available on request or accessible at <http://www.sgs.com.tw/Terms-and-Conditions> and for electronic format documents, subject to Terms and Conditions for Electronic Documents at <http://www.sgs.com.tw/Terms-and-Conditions>. Attention is drawn to the limitation of liability, indemnification and jurisdiction issues defined therein. Any holder of this document is advised that information contained hereon reflects the Company's findings at the time of its intervention only and within the limits of Client's instructions, if any. The Company's sole responsibility is to its Client and this document does not exonerate parties to a transaction from exercising all their rights and obligations under the transaction documents. This document cannot be reproduced except in full, without prior written approval of the Company. Any unauthorized alteration, forgery or falsification of the content or appearance of this document is unlawful and offenders may be prosecuted to the fullest extent of the law.

10.4 Measurement Procedure

1. The testing follows the Measurement Procedure of FCC KDB 558074 D01 DTS Meas. Guidance.
2. The EUT was placed on a turn table with 0.8m for frequency < 1GHz and 1.5m for frequency > 1GHz above ground plane.
3. The turn table shall rotate 360 degrees to determine the position of maximum emission level.
4. EUT is set 3m away from the receiving antenna which varied from 1m to 4m to find out the highest emissions.
5. Set the spectrum analyzer as RBW=120 kHz and VBW=300 kHz for Peak Detector (PK) and Quasi-peak (QP) at frequency below 1 GHz.
6. Set the spectrum analyzer as RBW=1 MHz, VBW=3 MHz for Peak Detector at frequency above 1 GHz.
7. Set the spectrum analyzer as RBW=1 MHz, VBW=10 Hz (Duty cycle > 98%) or VBW ≥ 1/T (Duty cycle < 98%) for Average Detector at frequency above 1 GHz.
8. When measurement procedures for electric field radiated emissions above 1 GHz the EUT measurement is to be made “while keeping the antenna in the ‘cone of radiation’ from that area and pointed at the area both in azimuth and elevation, with polarization oriented for maximum response.” is still within the 3dB illumination BW of the measurement antenna.
9. Maximum procedure was performed on the six highest emissions to ensure EUT compliance.
10. And also, each emission was to be maximized by changing the polarization of receiving antenna both horizontal and vertical. On spectrum, change spectrum mode in linear display mode, and reduce VBW = 10Hz if average reading is measured.
11. Repeat above procedures until all default test channel measured were complete.

Unless otherwise stated the results shown in this test report refer only to the sample(s) tested and such sample(s) are retained for 90 days only.

除非另有說明，此報告結果僅對測試之樣品負責，同時此樣品僅保留90天。本報告未經本公司書面許可，不可部份複製。

This document is issued by the Company subject to its General Conditions of Service printed overleaf, available on request or accessible at <http://www.sgs.com.tw/Terms-and-Conditions> and for electronic format documents, subject to Terms and Conditions for Electronic Documents at <http://www.sgs.com.tw/Terms-and-Conditions>. Attention is drawn to the limitation of liability, indemnification and jurisdiction issues defined therein. Any holder of this document is advised that information contained hereon reflects the Company's findings at the time of its intervention only and within the limits of Client's instructions, if any. The Company's sole responsibility is to its Client and this document does not exonerate parties to a transaction from exercising all their rights and obligations under the transaction documents. This document cannot be reproduced except in full, without prior written approval of the Company. Any unauthorized alteration, forgery or falsification of the content or appearance of this document is unlawful and offenders may be prosecuted to the fullest extent of the law.

10.5 Field Strength Calculation

The field strength is calculated by adding the Antenna Factor and Cable Factor and subtracting the Amplifier Gain and Duty Cycle Correction Factor (if any) from the measured reading. The basic equation with a sample calculation is as follows:

$$FS = RA + AF + CL - AG$$

Where *FS = Field Strength* *CL = Cable Attenuation Factor (Cable Loss)*
RA = Reading Amplitude *AG = Amplifier Gain*
AF = Antenna Factor

*The limit of the emission level is expressed in dBuV/m, which converts 20*log(uV/m)*

Actual FS(dBμV/m) = SPA. Reading level(dBμV) + Factor(dB)

Factor(dB) = Antenna Factor(dBμV/m) + Cable Loss(dB) – Pre_Amplifier Gain(dB)

10.6 Test Results of Radiated Spurious Emissions from 9 kHz to 30 MHz

The low frequency, which started from 9 kHz to 30MHz, was pre-scanned and the result which was 20dB lower than the limit per 15.31(o) & RSS-GEN §6.13.2 was not reported.

10.7 Measurement Result:

Note: Refer to next page spectrum analyzer data chart and tabular data sheets.

Unless otherwise stated the results shown in this test report refer only to the sample(s) tested and such sample(s) are retained for 90 days only.

除非另有說明，此報告結果僅對測試之樣品負責，同時此樣品僅保留90天。本報告未經本公司書面許可，不可部份複製。

This document is issued by the Company subject to its General Conditions of Service printed overleaf, available on request or accessible at <http://www.sgs.com.tw/Terms-and-Conditions> and for electronic format documents, subject to Terms and Conditions for Electronic Documents at <http://www.sgs.com.tw/Terms-and-Conditions>. Attention is drawn to the limitation of liability, indemnification and jurisdiction issues defined therein. Any holder of this document is advised that information contained hereon reflects the Company's findings at the time of its intervention only and within the limits of Client's instructions, if any. The Company's sole responsibility is to its Client and this document does not exonerate parties to a transaction from exercising all their rights and obligations under the transaction documents. This document cannot be reproduced except in full, without prior written approval of the Company. Any unauthorized alteration, forgery or falsification of the content or appearance of this document is unlawful and offenders may be prosecuted to the fullest extent of the law.

10.7.1 Radiated Band Edge Measurement Result

Report Number	:ER/2021/50020	Test Site	:SAC I Chamber
Operation Mode	:BLE(1M)	Test Date	:2021-06-26
Test Frequency	:2402 MHz	Temp./Humi.	:25.8/61
Test Mode	:Bandedge CH Low	Antenna Pol.	:VERTICAL
EUT Pol	:E2 Plane	Engineer	:Neo Tsai

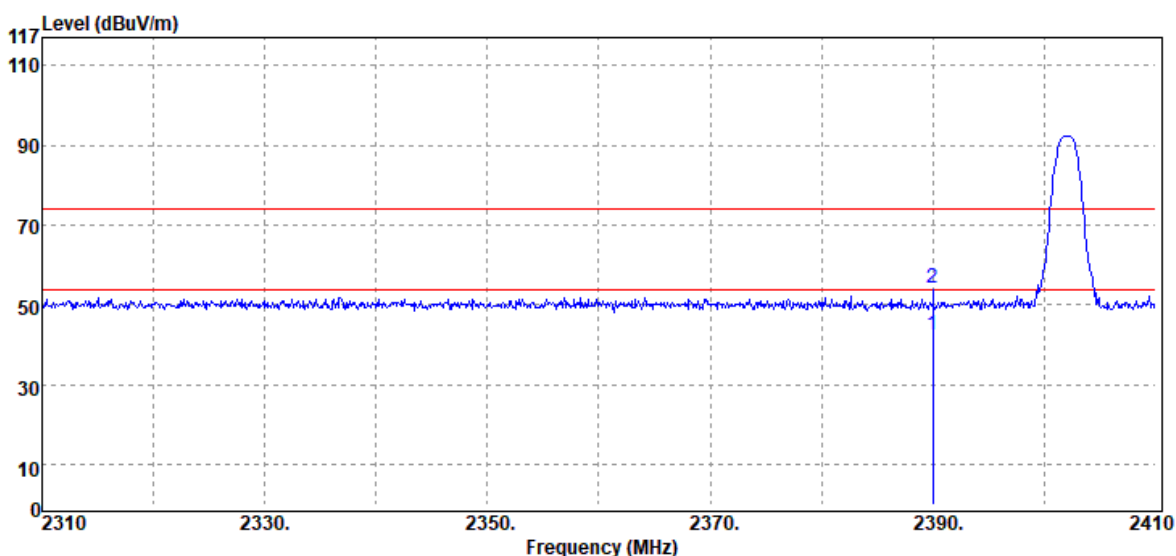

Freq. MHz	Detector Mode PK/QP/AV	Spectrum Reading Level dBuV	Factor dB	Actual FS dBuV/m	Limit @3m dBuV/m	Margin dB
2390.00	Average	42.77	-0.12	42.65	54.00	-11.35
2390.00	Peak	54.17	-0.12	54.05	74.00	-19.95

Unless otherwise stated the results shown in this test report refer only to the sample(s) tested and such sample(s) are retained for 90 days only.

除非另有說明，此報告結果僅對測試之樣品負責，同時此樣品僅保留90天。本報告未經本公司書面許可，不可部份複製。

This document is issued by the Company subject to its General Conditions of Service printed overleaf, available on request or accessible at <http://www.sgs.com.tw/Terms-and-Conditions> and for electronic format documents, subject to Terms and Conditions for Electronic Documents at <http://www.sgs.com.tw/Terms-and-Conditions>. Attention is drawn to the limitation of liability, indemnification and jurisdiction issues defined therein. Any holder of this document is advised that information contained hereon reflects the Company's findings at the time of its intervention only and within the limits of Client's instructions, if any. The Company's sole responsibility is to its Client and this document does not exonerate parties to a transaction from exercising all their rights and obligations under the transaction documents. This document cannot be reproduced except in full, without prior written approval of the Company. Any unauthorized alteration, forgery or falsification of the content or appearance of this document is unlawful and offenders may be prosecuted to the fullest extent of the law.

Report Number	:ER/2021/50020	Test Site	:SAC I Chamber
Operation Mode	:BLE(1M)	Test Date	:2021-06-26
Test Frequency	:2402 MHz	Temp./Humi.	:25.8/61
Test Mode	:Bandedge CH Low	Antenna Pol.	:HORIZONTAL
EUT Pol	:E2 Plane	Engineer	:Neo Tsai

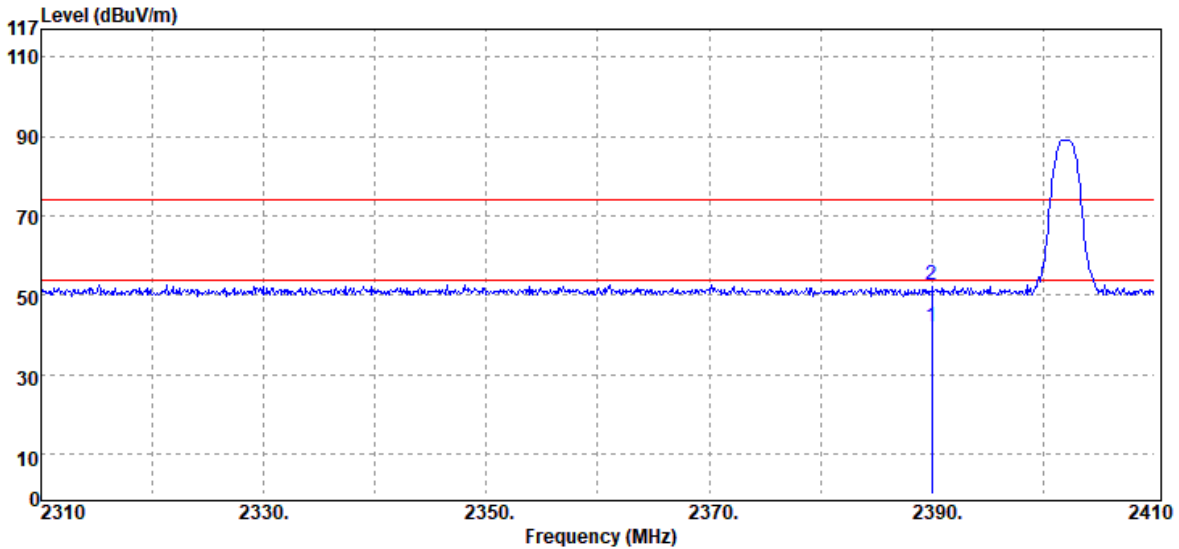

Freq. MHz	Detector Mode PK/QP/AV	Spectrum Reading Level dB μ V	Factor dB	Actual FS dB μ V/m	Limit @3m dB μ V/m	Margin dB
2390.00	Average	42.29	-0.12	42.17	54.00	-11.83
2390.00	Peak	52.93	-0.12	52.81	74.00	-21.19

Unless otherwise stated the results shown in this test report refer only to the sample(s) tested and such sample(s) are retained for 90 days only.

除非另有說明，此報告結果僅對測試之樣品負責，同時此樣品僅保留90天。本報告未經本公司書面許可，不可部份複製。

This document is issued by the Company subject to its General Conditions of Service printed overleaf, available on request or accessible at <http://www.sgs.com.tw/Terms-and-Conditions> and for electronic format documents, subject to Terms and Conditions for Electronic Documents at <http://www.sgs.com.tw/Terms-and-Conditions>. Attention is drawn to the limitation of liability, indemnification and jurisdiction issues defined therein. Any holder of this document is advised that information contained hereon reflects the Company's findings at the time of its intervention only and within the limits of Client's instructions, if any. The Company's sole responsibility is to its Client and this document does not exonerate parties to a transaction from exercising all their rights and obligations under the transaction documents. This document cannot be reproduced except in full, without prior written approval of the Company. Any unauthorized alteration, forgery or falsification of the content or appearance of this document is unlawful and offenders may be prosecuted to the fullest extent of the law.

Report Number	:ER/2021/50020	Test Site	:SAC I Chamber
Operation Mode	:BLE(1M)	Test Date	:2021-06-26
Test Frequency	:2480 MHz	Temp./Humi.	:25.8/61
Test Mode	:Bandedge CH High	Antenna Pol.	:VERTICAL
EUT Pol	:E2 Plane	Engineer	:Neo Tsai

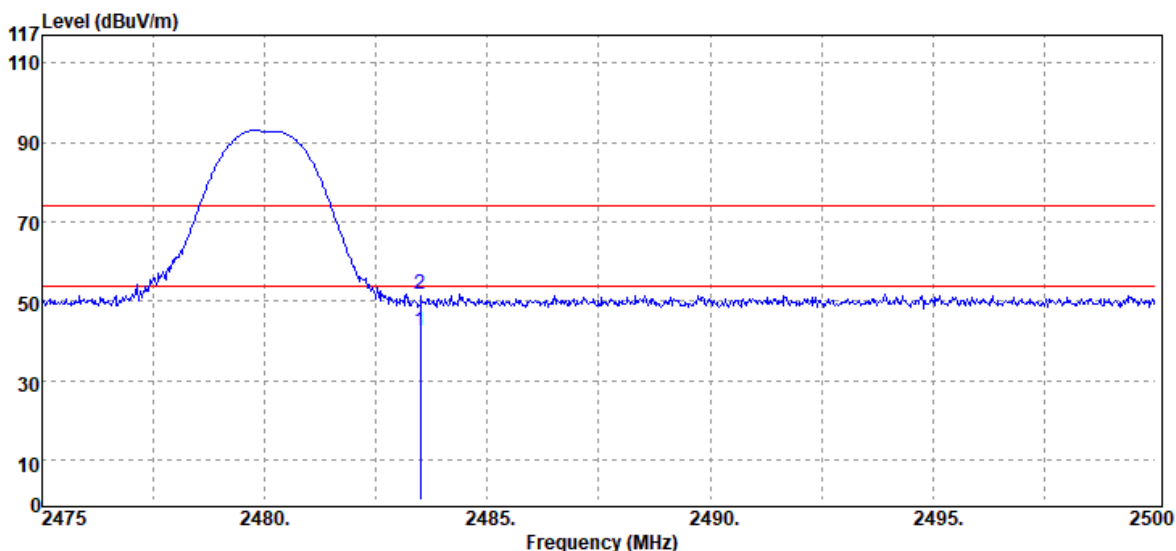

Freq. MHz	Detector Mode PK/QP/AV	Spectrum Reading Level dB μ V	Factor dB	Actual FS dB μ V/m	Limit @3m dB μ V/m	Margin dB
2483.50	Average	42.62	-0.16	42.46	54.00	-11.54
2483.50	Peak	51.87	-0.16	51.71	74.00	-22.29

Unless otherwise stated the results shown in this test report refer only to the sample(s) tested and such sample(s) are retained for 90 days only.

除非另有說明，此報告結果僅對測試之樣品負責，同時此樣品僅保留90天。本報告未經本公司書面許可，不可部份複製。

This document is issued by the Company subject to its General Conditions of Service printed overleaf, available on request or accessible at <http://www.sgs.com.tw/Terms-and-Conditions> and for electronic format documents, subject to Terms and Conditions for Electronic Documents at <http://www.sgs.com.tw/Terms-and-Conditions>. Attention is drawn to the limitation of liability, indemnification and jurisdiction issues defined therein. Any holder of this document is advised that information contained hereon reflects the Company's findings at the time of its intervention only and within the limits of Client's instructions, if any. The Company's sole responsibility is to its Client and this document does not exonerate parties to a transaction from exercising all their rights and obligations under the transaction documents. This document cannot be reproduced except in full, without prior written approval of the Company. Any unauthorized alteration, forgery or falsification of the content or appearance of this document is unlawful and offenders may be prosecuted to the fullest extent of the law.

Report Number	:ER/2021/50020	Test Site	:SAC I Chamber
Operation Mode	:BLE(1M)	Test Date	:2021-06-26
Test Frequency	:2480 MHz	Temp./Humi.	:25.8/61
Test Mode	:Bandedge CH High	Antenna Pol.	:HORIZONTAL
EUT Pol	:E2 Plane	Engineer	:Neo Tsai

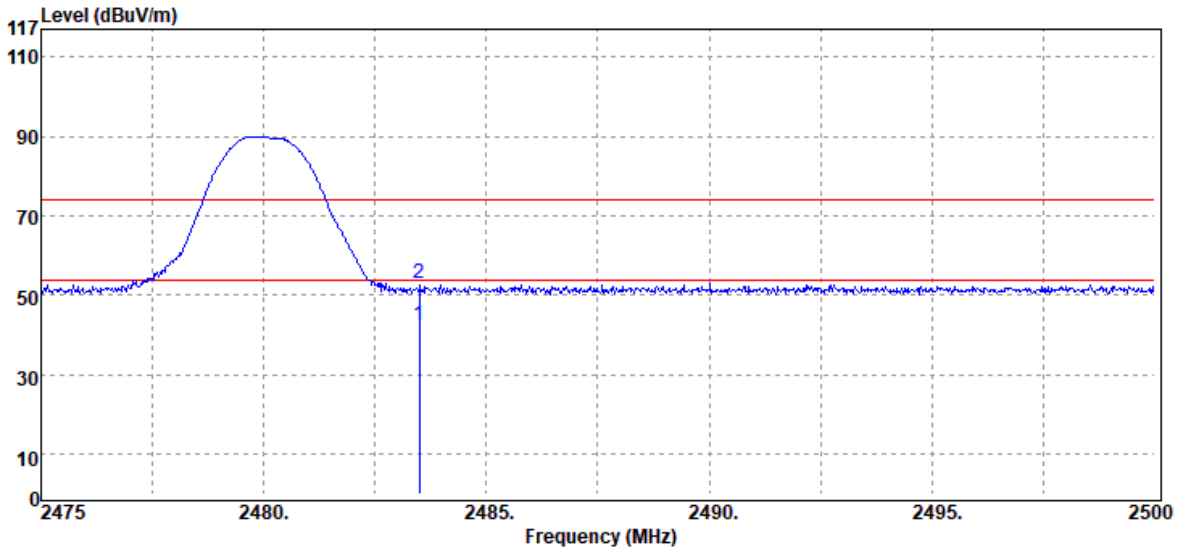

Freq. MHz	Detector Mode PK/QP/AV	Spectrum Reading Level dB μ V	Factor dB	Actual FS dB μ V/m	Limit @3m dB μ V/m	Margin dB
2483.50	Average	42.62	-0.16	42.46	54.00	-11.54
2483.50	Peak	53.07	-0.16	52.91	74.00	-21.09

Unless otherwise stated the results shown in this test report refer only to the sample(s) tested and such sample(s) are retained for 90 days only.

除非另有說明，此報告結果僅對測試之樣品負責，同時此樣品僅保留90天。本報告未經本公司書面許可，不可部份複製。

This document is issued by the Company subject to its General Conditions of Service printed overleaf, available on request or accessible at <http://www.sgs.com.tw/Terms-and-Conditions> and for electronic format documents, subject to Terms and Conditions for Electronic Documents at <http://www.sgs.com.tw/Terms-and-Conditions>. Attention is drawn to the limitation of liability, indemnification and jurisdiction issues defined therein. Any holder of this document is advised that information contained hereon reflects the Company's findings at the time of its intervention only and within the limits of Client's instructions, if any. The Company's sole responsibility is to its Client and this document does not exonerate parties to a transaction from exercising all their rights and obligations under the transaction documents. This document cannot be reproduced except in full, without prior written approval of the Company. Any unauthorized alteration, forgery or falsification of the content or appearance of this document is unlawful and offenders may be prosecuted to the fullest extent of the law.

Report Number	:ER/2021/50020	Test Site	:SAC I Chamber
Operation Mode	:BLE(2M)	Test Date	:2021-06-26
Test Frequency	:2402 MHz	Temp./Humi.	:25.8/61
Test Mode	:Bandedge CH Low	Antenna Pol.	:VERTICAL
EUT Pol	:E2 Plane	Engineer	:Neo Tsai

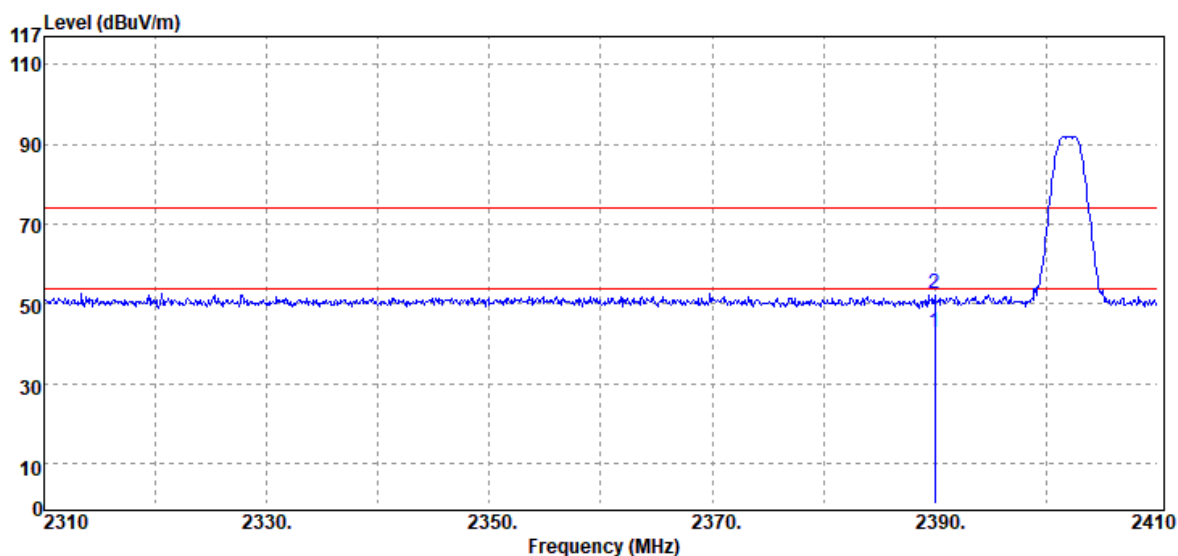

Freq. MHz	Detector Mode PK/QP/AV	Spectrum Reading Level dB μ V	Factor dB	Actual FS dB μ V/m	Limit @3m dB μ V/m	Margin dB
2390.00	Average	43.07	-0.12	42.95	54.00	-11.05
2390.00	Peak	52.68	-0.12	52.56	74.00	-21.44

Unless otherwise stated the results shown in this test report refer only to the sample(s) tested and such sample(s) are retained for 90 days only.

除非另有說明，此報告結果僅對測試之樣品負責，同時此樣品僅保留90天。本報告未經本公司書面許可，不可部份複製。

This document is issued by the Company subject to its General Conditions of Service printed overleaf, available on request or accessible at <http://www.sgs.com.tw/Terms-and-Conditions> and for electronic format documents, subject to Terms and Conditions for Electronic Documents at <http://www.sgs.com.tw/Terms-and-Conditions>. Attention is drawn to the limitation of liability, indemnification and jurisdiction issues defined therein. Any holder of this document is advised that information contained hereon reflects the Company's findings at the time of its intervention only and within the limits of Client's instructions, if any. The Company's sole responsibility is to its Client and this document does not exonerate parties to a transaction from exercising all their rights and obligations under the transaction documents. This document cannot be reproduced except in full, without prior written approval of the Company. Any unauthorized alteration, forgery or falsification of the content or appearance of this document is unlawful and offenders may be prosecuted to the fullest extent of the law.

Report Number	:ER/2021/50020	Test Site	:SAC I Chamber
Operation Mode	:BLE(2M)	Test Date	:2021-06-26
Test Frequency	:2402 MHz	Temp./Humi.	:25.8/61
Test Mode	:Bandedge CH Low	Antenna Pol.	:HORIZONTAL
EUT Pol	:E2 Plane	Engineer	:Neo Tsai

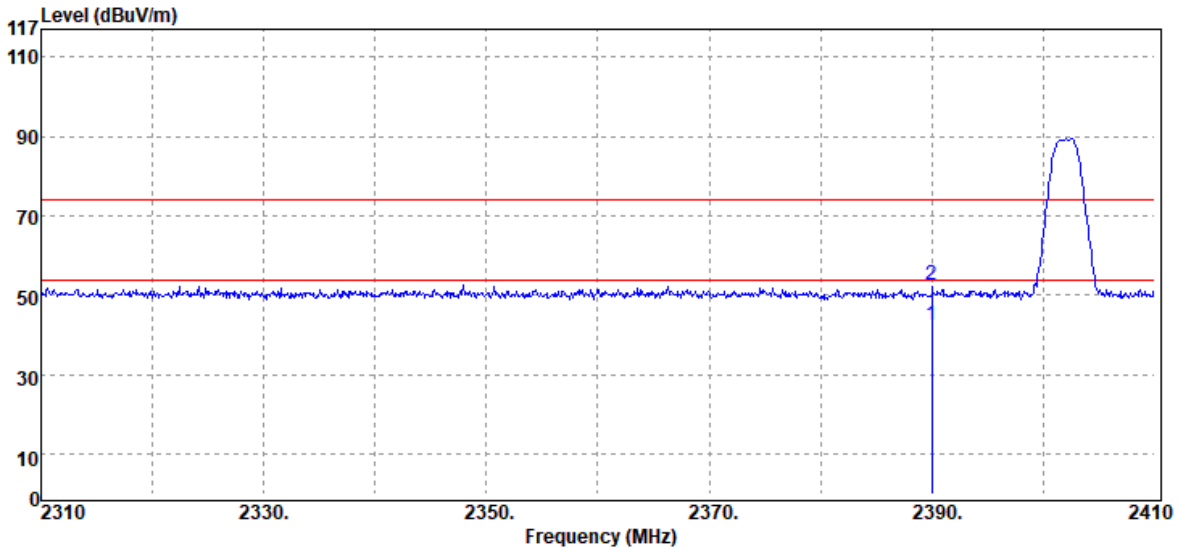

Freq. MHz	Detector Mode PK/QP/AV	Spectrum Reading Level dB μ V	Factor dB	Actual FS dB μ V/m	Limit @3m dB μ V/m	Margin dB
2390.00	Average	42.81	-0.12	42.69	54.00	-11.31
2390.00	Peak	52.58	-0.12	52.46	74.00	-21.54

Unless otherwise stated the results shown in this test report refer only to the sample(s) tested and such sample(s) are retained for 90 days only.

除非另有說明，此報告結果僅對測試之樣品負責，同時此樣品僅保留90天。本報告未經本公司書面許可，不可部份複製。

This document is issued by the Company subject to its General Conditions of Service printed overleaf, available on request or accessible at <http://www.sgs.com.tw/Terms-and-Conditions> and for electronic format documents, subject to Terms and Conditions for Electronic Documents at <http://www.sgs.com.tw/Terms-and-Conditions>. Attention is drawn to the limitation of liability, indemnification and jurisdiction issues defined therein. Any holder of this document is advised that information contained hereon reflects the Company's findings at the time of its intervention only and within the limits of Client's instructions, if any. The Company's sole responsibility is to its Client and this document does not exonerate parties to a transaction from exercising all their rights and obligations under the transaction documents. This document cannot be reproduced except in full, without prior written approval of the Company. Any unauthorized alteration, forgery or falsification of the content or appearance of this document is unlawful and offenders may be prosecuted to the fullest extent of the law.

Report Number :ER/2021/50020

Test Site :SAC I Chamber

Operation Mode :BLE(2M)

Test Date :2021-06-26

Test Frequency :2480 MHz

Temp./Humi. :25.8/61

Test Mode :Bandedge CH High

Antenna Pol. :VERTICAL

EUT Pol :E2 Plane

Engineer :Neo Tsai

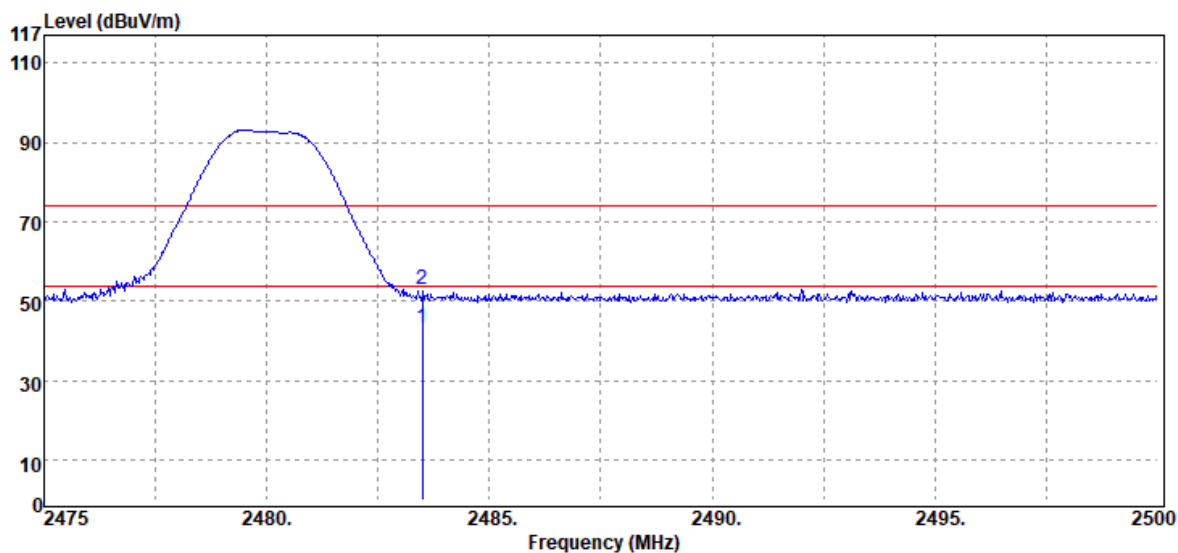

Freq. MHz	Detector Mode PK/QP/AV	Spectrum Reading Level dB μ V	Factor dB	Actual FS dB μ V/m	Limit @3m dB μ V/m	Margin dB
2483.50	Average	43.34	-0.16	43.18	54.00	-10.82
2483.50	Peak	53.02	-0.16	52.86	74.00	-21.14

Unless otherwise stated the results shown in this test report refer only to the sample(s) tested and such sample(s) are retained for 90 days only.

除非另有說明，此報告結果僅對測試之樣品負責，同時此樣品僅保留90天。本報告未經本公司書面許可，不可部份複製。

This document is issued by the Company subject to its General Conditions of Service printed overleaf, available on request or accessible at <http://www.sgs.com.tw/Terms-and-Conditions> and for electronic format documents, subject to Terms and Conditions for Electronic Documents at <http://www.sgs.com.tw/Terms-and-Conditions>. Attention is drawn to the limitation of liability, indemnification and jurisdiction issues defined therein. Any holder of this document is advised that information contained hereon reflects the Company's findings at the time of its intervention only and within the limits of Client's instructions, if any. The Company's sole responsibility is to its Client and this document does not exonerate parties to a transaction from exercising all their rights and obligations under the transaction documents. This document cannot be reproduced except in full, without prior written approval of the Company. Any unauthorized alteration, forgery or falsification of the content or appearance of this document is unlawful and offenders may be prosecuted to the fullest extent of the law.

Report Number	:ER/2021/50020	Test Site	:SAC I Chamber
Operation Mode	:BLE(2M)	Test Date	:2021-06-26
Test Frequency	:2480 MHz	Temp./Humi.	:25.8/61
Test Mode	:Bandedge CH High	Antenna Pol.	:HORIZONTAL
EUT Pol	:E2 Plane	Engineer	:Neo Tsai

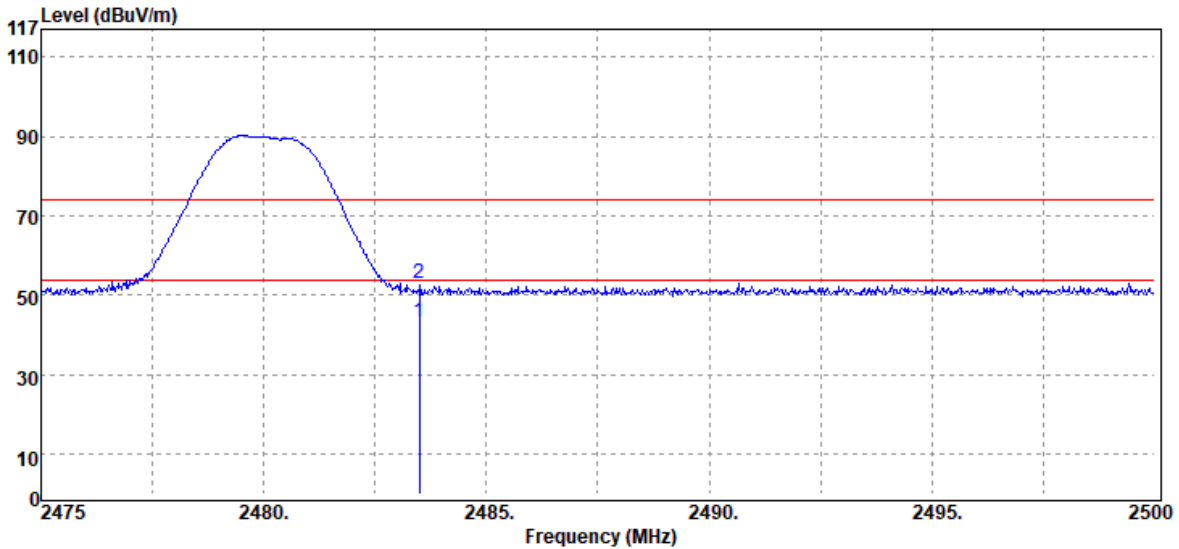

Freq. MHz	Detector Mode PK/QP/AV	Spectrum Reading Level dB μ V	Factor dB	Actual FS dB μ V/m	Limit @3m dB μ V/m	Margin dB
2483.50	Average	43.32	-0.16	43.16	54.00	-10.84
2483.50	Peak	53.10	-0.16	52.94	74.00	-21.06

Unless otherwise stated the results shown in this test report refer only to the sample(s) tested and such sample(s) are retained for 90 days only.

除非另有說明，此報告結果僅對測試之樣品負責，同時此樣品僅保留90天。本報告未經本公司書面許可，不可部份複製。

This document is issued by the Company subject to its General Conditions of Service printed overleaf, available on request or accessible at <http://www.sgs.com.tw/Terms-and-Conditions> and for electronic format documents, subject to Terms and Conditions for Electronic Documents at <http://www.sgs.com.tw/Terms-and-Conditions>. Attention is drawn to the limitation of liability, indemnification and jurisdiction issues defined therein. Any holder of this document is advised that information contained hereon reflects the Company's findings at the time of its intervention only and within the limits of Client's instructions, if any. The Company's sole responsibility is to its Client and this document does not exonerate parties to a transaction from exercising all their rights and obligations under the transaction documents. This document cannot be reproduced except in full, without prior written approval of the Company. Any unauthorized alteration, forgery or falsification of the content or appearance of this document is unlawful and offenders may be prosecuted to the fullest extent of the law.

10.7.2 Radiated Spurious Emission from 30MHz to 1000MHz

Report Number	:ER/2021/50020	Test Site	:SAC I Chamber
Operation Mode	:BLE(1M)	Test Date	:2021-06-30
Test Frequency	:2442 MHz	Temp./Humi.	:26.8/62
Test Mode	:Tx CH Mid	Antenna Pol.	:VERTICAL
EUT Pol	:E2 Plane	Engineer	:Neo Tsai

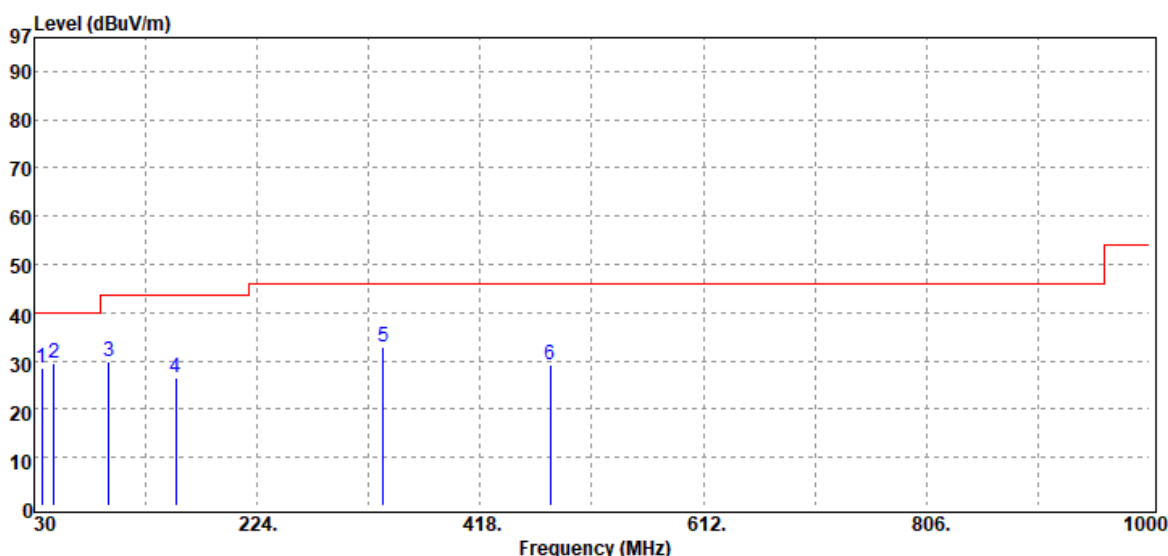

Freq. MHz	Detector Mode PK/QP/AV	Spectrum Reading Level dBuV	Factor dB	Actual FS dBuV/m	Limit @3m dBuV/m	Margin dB
36.79	Peak	36.97	-8.40	28.57	40.00	-11.43
47.46	Peak	43.98	-14.37	29.61	40.00	-10.39
94.99	Peak	44.16	-14.30	29.86	43.50	-13.64
153.19	Peak	39.41	-12.97	26.44	43.50	-17.06
333.61	Peak	41.44	-8.54	32.90	46.00	-13.10
479.11	Peak	35.32	-5.96	29.36	46.00	-16.64

Unless otherwise stated the results shown in this test report refer only to the sample(s) tested and such sample(s) are retained for 90 days only.

除非另有說明，此報告結果僅對測試之樣品負責，同時此樣品僅保留90天。本報告未經本公司書面許可，不可部份複製。

This document is issued by the Company subject to its General Conditions of Service printed overleaf, available on request or accessible at <http://www.sgs.com.tw/Terms-and-Conditions> and for electronic format documents, subject to Terms and Conditions for Electronic Documents at <http://www.sgs.com.tw/Terms-and-Conditions>. Attention is drawn to the limitation of liability, indemnification and jurisdiction issues defined therein. Any holder of this document is advised that information contained hereon reflects the Company's findings at the time of its intervention only and within the limits of Client's instructions, if any. The Company's sole responsibility is to its Client and this document does not exonerate parties to a transaction from exercising all their rights and obligations under the transaction documents. This document cannot be reproduced except in full, without prior written approval of the Company. Any unauthorized alteration, forgery or falsification of the content or appearance of this document is unlawful and offenders may be prosecuted to the fullest extent of the law.

Report Number :ER/2021/50020
 Operation Mode :BLE(1M)
 Test Frequency :2442 MHz
 Test Mode :Tx CH Mid
 EUT Pol :E2 Plane

Test Site :SAC I Chamber
 Test Date :2021-06-30
 Temp./Humi. :26.8/62
 Antenna Pol. :HORIZONTAL
 Engineer :Neo Tsai

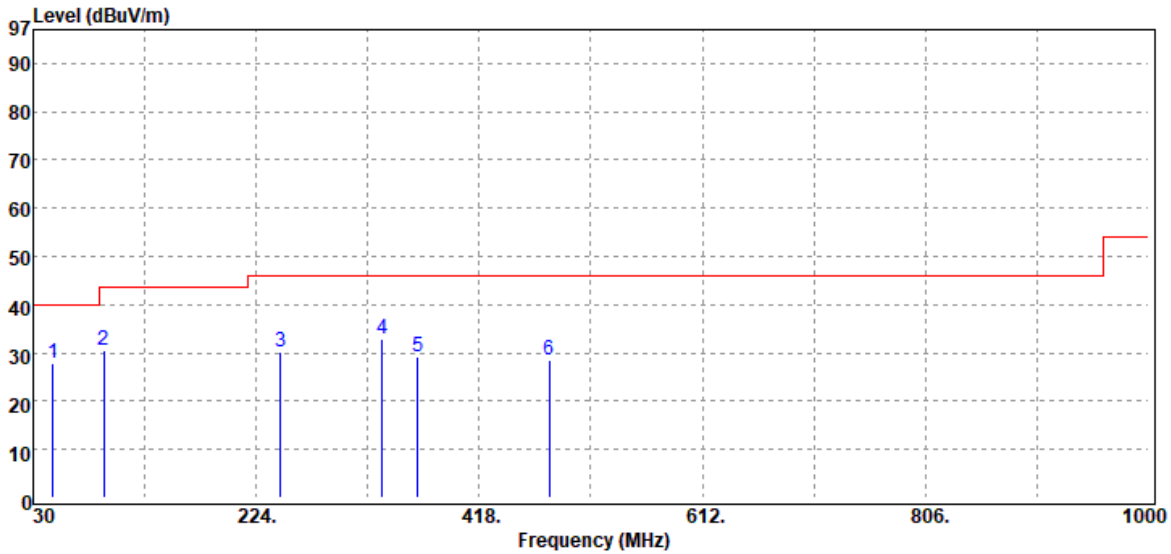

Freq. MHz	Detector Mode PK/QP/AV	Spectrum Reading Level dB μ V	Factor dB	Actual FS dB μ V/m	Limit @3m dB μ V/m	Margin dB
47.46	Peak	42.11	-14.37	27.74	40.00	-12.26
91.11	Peak	45.58	-15.11	30.47	43.50	-13.03
245.34	Peak	40.88	-10.64	30.24	46.00	-15.76
333.61	Peak	41.39	-8.54	32.85	46.00	-13.15
364.65	Peak	37.16	-8.02	29.14	46.00	-16.86
479.11	Peak	34.52	-5.96	28.56	46.00	-17.44

Unless otherwise stated the results shown in this test report refer only to the sample(s) tested and such sample(s) are retained for 90 days only.

除非另有說明，此報告結果僅對測試之樣品負責，同時此樣品僅保留90天。本報告未經本公司書面許可，不可部份複製。

This document is issued by the Company subject to its General Conditions of Service printed overleaf, available on request or accessible at <http://www.sgs.com.tw/Terms-and-Conditions> and for electronic format documents, subject to Terms and Conditions for Electronic Documents at <http://www.sgs.com.tw/Terms-and-Conditions>. Attention is drawn to the limitation of liability, indemnification and jurisdiction issues defined therein. Any holder of this document is advised that information contained hereon reflects the Company's findings at the time of its intervention only and within the limits of Client's instructions, if any. The Company's sole responsibility is to its Client and this document does not exonerate parties to a transaction from exercising all their rights and obligations under the transaction documents. This document cannot be reproduced except in full, without prior written approval of the Company. Any unauthorized alteration, forgery or falsification of the content or appearance of this document is unlawful and offenders may be prosecuted to the fullest extent of the law.

Report Number :ER/2021/50020
 Operation Mode :BLE(2M)
 Test Frequency :2442 MHz
 Test Mode :Tx CH Mid
 EUT Pol :E2 Plane

Test Site :SAC I Chamber
 Test Date :2021-06-30
 Temp./Humi. :26.8/62
 Antenna Pol. :VERTICAL
 Engineer :Neo Tsai

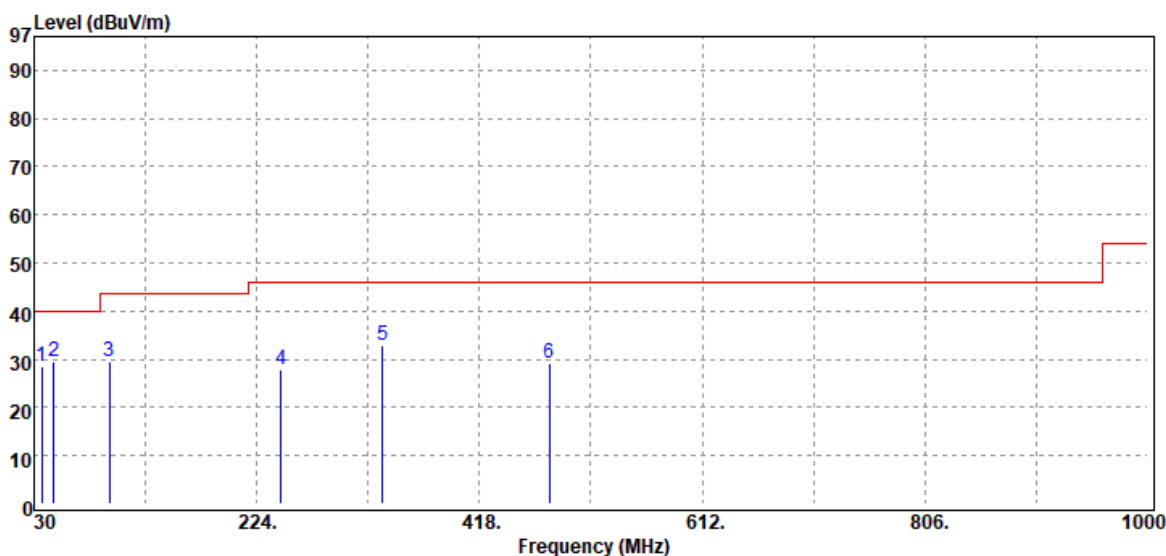

Freq. MHz	Detector Mode PK/QP/AV	Spectrum Reading Level dBμV	Factor dB	Actual FS dBμV/m	Limit @3m dBμV/m	Margin dB
36.79	Peak	37.04	-8.40	28.64	40.00	-11.36
47.46	Peak	43.81	-14.37	29.44	40.00	-10.56
95.96	Peak	43.82	-14.30	29.52	43.50	-13.98
245.34	Peak	38.40	-10.64	27.76	46.00	-18.24
333.61	Peak	41.40	-8.54	32.86	46.00	-13.14
479.11	Peak	35.06	-5.96	29.10	46.00	-16.90

Unless otherwise stated the results shown in this test report refer only to the sample(s) tested and such sample(s) are retained for 90 days only.

除非另有說明，此報告結果僅對測試之樣品負責，同時此樣品僅保留90天。本報告未經本公司書面許可，不可部份複製。

This document is issued by the Company subject to its General Conditions of Service printed overleaf, available on request or accessible at <http://www.sgs.com.tw/Terms-and-Conditions> and for electronic format documents, subject to Terms and Conditions for Electronic Documents at <http://www.sgs.com.tw/Terms-and-Conditions>. Attention is drawn to the limitation of liability, indemnification and jurisdiction issues defined therein. Any holder of this document is advised that information contained hereon reflects the Company's findings at the time of its intervention only and within the limits of Client's instructions, if any. The Company's sole responsibility is to its Client and this document does not exonerate parties to a transaction from exercising all their rights and obligations under the transaction documents. This document cannot be reproduced except in full, without prior written approval of the Company. Any unauthorized alteration, forgery or falsification of the content or appearance of this document is unlawful and offenders may be prosecuted to the fullest extent of the law.

Report Number :ER/2021/50020
 Operation Mode :BLE(2M)
 Test Frequency :2442 MHz
 Test Mode :Tx CH Mid
 EUT Pol :E2 Plane

Test Site :SAC I Chamber
 Test Date :2021-06-30
 Temp./Humi. :26.8/62
 Antenna Pol. :HORIZONTAL
 Engineer :Neo Tsai

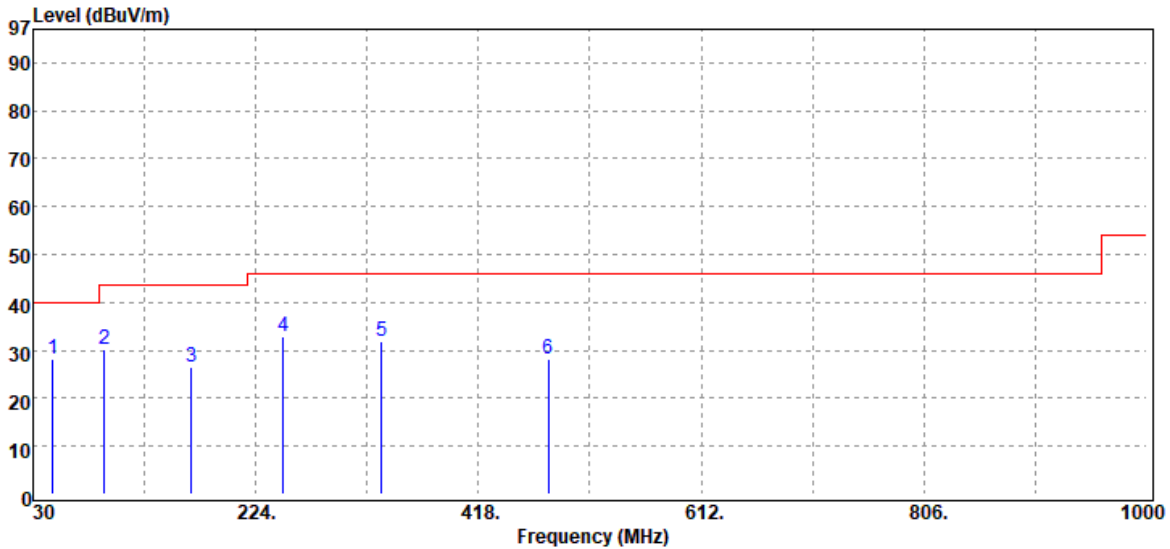

Freq. MHz	Detector Mode PK/QP/AV	Spectrum Reading Level dB μ V	Factor dB	Actual FS dB μ V/m	Limit @3m dB μ V/m	Margin dB
47.46	Peak	42.64	-14.37	28.27	40.00	-11.73
92.08	Peak	45.09	-14.83	30.26	43.50	-13.24
167.74	Peak	40.22	-13.60	26.62	43.50	-16.88
248.25	Peak	43.27	-10.26	33.01	46.00	-12.99
333.61	Peak	40.53	-8.54	31.99	46.00	-14.01
479.11	Peak	34.02	-5.96	28.06	46.00	-17.94

Unless otherwise stated the results shown in this test report refer only to the sample(s) tested and such sample(s) are retained for 90 days only.

除非另有說明，此報告結果僅對測試之樣品負責，同時此樣品僅保留90天。本報告未經本公司書面許可，不可部份複製。

This document is issued by the Company subject to its General Conditions of Service printed overleaf, available on request or accessible at <http://www.sgs.com.tw/Terms-and-Conditions> and for electronic format documents, subject to Terms and Conditions for Electronic Documents at <http://www.sgs.com.tw/Terms-and-Conditions>. Attention is drawn to the limitation of liability, indemnification and jurisdiction issues defined therein. Any holder of this document is advised that information contained hereon reflects the Company's findings at the time of its intervention only and within the limits of Client's instructions, if any. The Company's sole responsibility is to its Client and this document does not exonerate parties to a transaction from exercising all their rights and obligations under the transaction documents. This document cannot be reproduced except in full, without prior written approval of the Company. Any unauthorized alteration, forgery or falsification of the content or appearance of this document is unlawful and offenders may be prosecuted to the fullest extent of the law.

10.7.3 Radiated Spurious Emission above 1GHz

Report Number	:ER/2021/50020	Test Site	:SAC I Chamber
Operation Mode	:BLE(1M)	Test Date	:2021-06-26
Test Frequency	:2402 MHz	Temp./Humi.	:25.8/61
Test Mode	:Tx CH Low	Antenna Pol.	:VERTICAL
EUT Pol	:E2 Plane	Engineer	:Neo Tsai

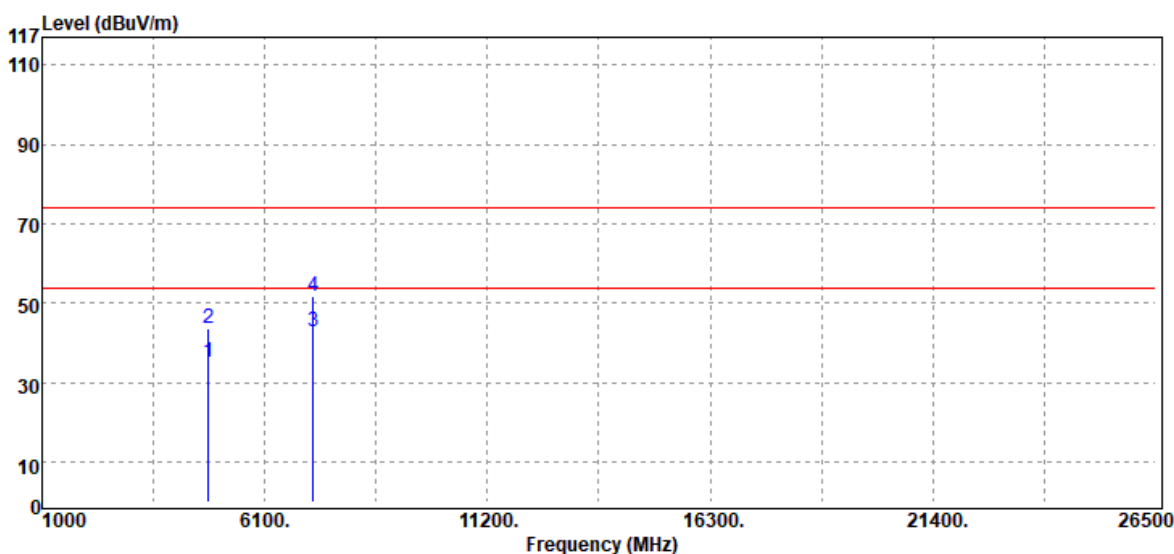

Freq. MHz	Detector Mode PK/QP/AV	Spectrum Reading Level dB μ V	Factor dB	Actual FS dB μ V/m	Limit @3m dB μ V/m	Margin dB
4804.00	Average	28.07	7.16	35.23	54.00	-18.77
4804.00	Peak	36.66	7.16	43.82	74.00	-30.18
7206.00	Average	27.13	15.71	42.84	54.00	-11.16
7206.00	Peak	36.07	15.71	51.78	74.00	-22.22

Unless otherwise stated the results shown in this test report refer only to the sample(s) tested and such sample(s) are retained for 90 days only.

除非另有說明，此報告結果僅對測試之樣品負責，同時此樣品僅保留90天。本報告未經本公司書面許可，不可部份複製。

This document is issued by the Company subject to its General Conditions of Service printed overleaf, available on request or accessible at <http://www.sgs.com.tw/Terms-and-Conditions> and for electronic format documents, subject to Terms and Conditions for Electronic Documents at <http://www.sgs.com.tw/Terms-and-Conditions>. Attention is drawn to the limitation of liability, indemnification and jurisdiction issues defined therein. Any holder of this document is advised that information contained hereon reflects the Company's findings at the time of its intervention only and within the limits of Client's instructions, if any. The Company's sole responsibility is to its Client and this document does not exonerate parties to a transaction from exercising all their rights and obligations under the transaction documents. This document cannot be reproduced except in full, without prior written approval of the Company. Any unauthorized alteration, forgery or falsification of the content or appearance of this document is unlawful and offenders may be prosecuted to the fullest extent of the law.

Report Number :ER/2021/50020
 Operation Mode :BLE(1M)
 Test Frequency :2402 MHz
 Test Mode :Tx CH Low
 EUT Pol :E2 Plane

Test Site :SAC I Chamber
 Test Date :2021-06-26
 Temp./Humi. :25.8/61
 Antenna Pol. :HORIZONTAL
 Engineer :Neo Tsai

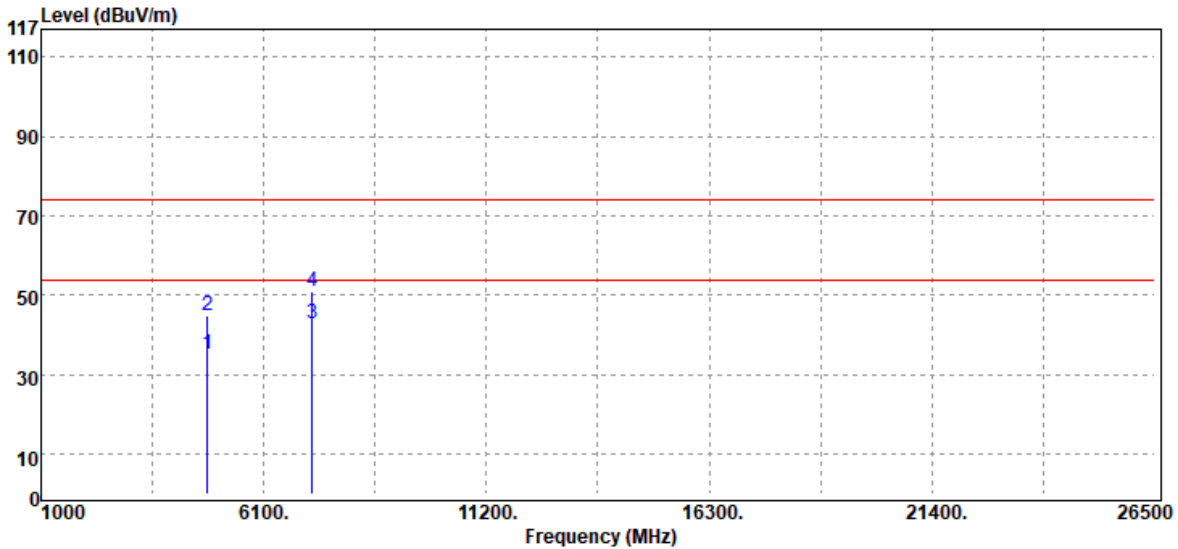

Freq. MHz	Detector Mode PK/QP/AV	Spectrum Reading Level dB μ V	Factor dB	Actual FS dB μ V/m	Limit @3m dB μ V/m	Margin dB
4804.00	Average	28.12	7.16	35.28	54.00	-18.72
4804.00	Peak	37.60	7.16	44.76	74.00	-29.24
7206.00	Average	27.34	15.71	43.05	54.00	-10.95
7206.00	Peak	35.35	15.71	51.06	74.00	-22.94

Unless otherwise stated the results shown in this test report refer only to the sample(s) tested and such sample(s) are retained for 90 days only.

除非另有說明，此報告結果僅對測試之樣品負責，同時此樣品僅保留90天。本報告未經本公司書面許可，不可部份複製。

This document is issued by the Company subject to its General Conditions of Service printed overleaf, available on request or accessible at <http://www.sgs.com.tw/Terms-and-Conditions> and for electronic format documents, subject to Terms and Conditions for Electronic Documents at <http://www.sgs.com.tw/Terms-and-Conditions>. Attention is drawn to the limitation of liability, indemnification and jurisdiction issues defined therein. Any holder of this document is advised that information contained hereon reflects the Company's findings at the time of its intervention only and within the limits of Client's instructions, if any. The Company's sole responsibility is to its Client and this document does not exonerate parties to a transaction from exercising all their rights and obligations under the transaction documents. This document cannot be reproduced except in full, without prior written approval of the Company. Any unauthorized alteration, forgery or falsification of the content or appearance of this document is unlawful and offenders may be prosecuted to the fullest extent of the law.

Report Number :ER/2021/50020
 Operation Mode :BLE(1M)
 Test Frequency :2442 MHz
 Test Mode :Tx CH Mid
 EUT Pol :E2 Plane

Test Site :SAC I Chamber
 Test Date :2021-06-26
 Temp./Humi. :25.8/61
 Antenna Pol. :VERTICAL
 Engineer :Neo Tsai

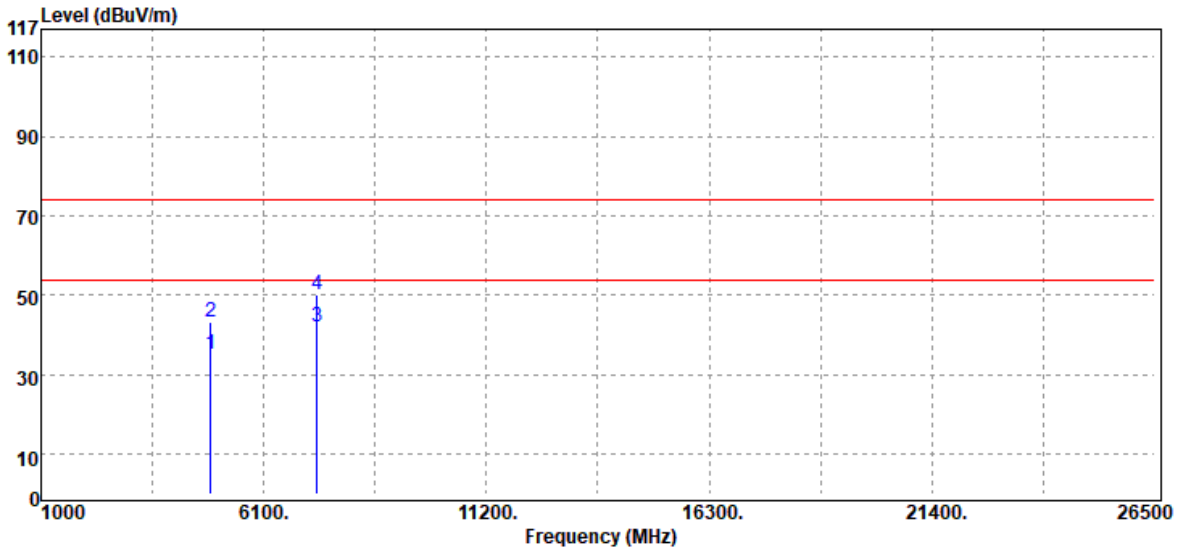

Freq. MHz	Detector Mode PK/QP/AV	Spectrum Reading Level dB μ V	Factor dB	Actual FS dB μ V/m	Limit @3m dB μ V/m	Margin dB
4884.00	Average	28.26	7.06	35.32	54.00	-18.68
4884.00	Peak	36.39	7.06	43.45	74.00	-30.55
7326.00	Average	27.14	14.87	42.01	54.00	-11.99
7326.00	Peak	35.26	14.87	50.13	74.00	-23.87

Unless otherwise stated the results shown in this test report refer only to the sample(s) tested and such sample(s) are retained for 90 days only.

除非另有說明，此報告結果僅對測試之樣品負責，同時此樣品僅保留90天。本報告未經本公司書面許可，不可部份複製。

This document is issued by the Company subject to its General Conditions of Service printed overleaf, available on request or accessible at <http://www.sgs.com.tw/Terms-and-Conditions> and for electronic format documents, subject to Terms and Conditions for Electronic Documents at <http://www.sgs.com.tw/Terms-and-Conditions>. Attention is drawn to the limitation of liability, indemnification and jurisdiction issues defined therein. Any holder of this document is advised that information contained hereon reflects the Company's findings at the time of its intervention only and within the limits of Client's instructions, if any. The Company's sole responsibility is to its Client and this document does not exonerate parties to a transaction from exercising all their rights and obligations under the transaction documents. This document cannot be reproduced except in full, without prior written approval of the Company. Any unauthorized alteration, forgery or falsification of the content or appearance of this document is unlawful and offenders may be prosecuted to the fullest extent of the law.

Report Number :ER/2021/50020
 Operation Mode :BLE(1M)
 Test Frequency :2442 MHz
 Test Mode :Tx CH Mid
 EUT Pol :E2 Plane

Test Site :SAC I Chamber
 Test Date :2021-06-26
 Temp./Humi. :25.8/61
 Antenna Pol. :HORIZONTAL
 Engineer :Neo Tsai

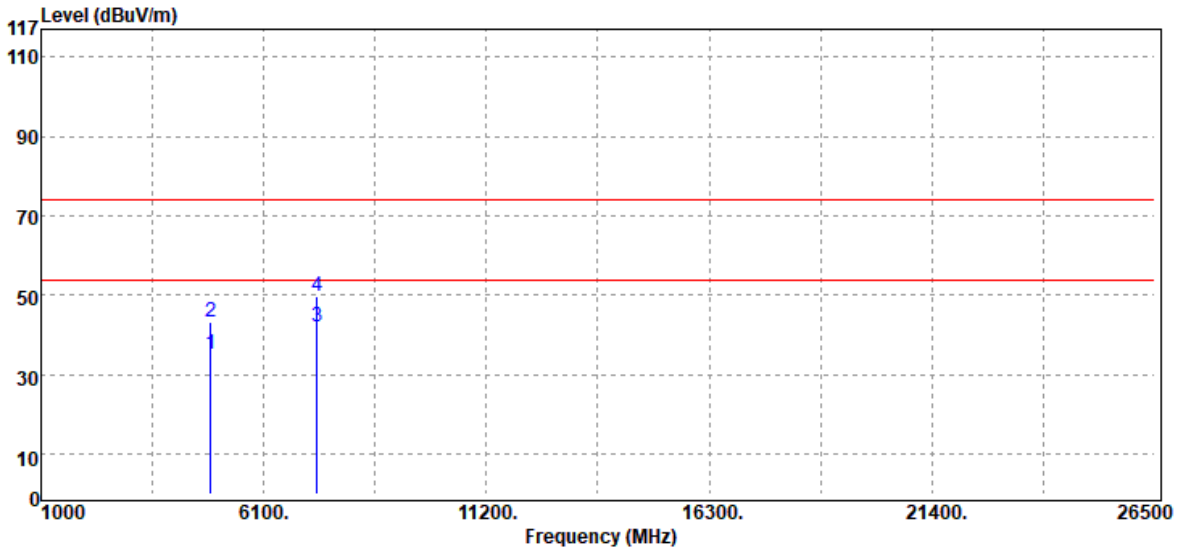

Freq. MHz	Detector Mode PK/QP/AV	Spectrum Reading Level dB μ V	Factor dB	Actual FS dB μ V/m	Limit @3m dB μ V/m	Margin dB
4884.00	Average	28.17	7.06	35.23	54.00	-18.77
4884.00	Peak	36.16	7.06	43.22	74.00	-30.78
7326.00	Average	27.21	14.87	42.08	54.00	-11.92
7326.00	Peak	34.88	14.87	49.75	74.00	-24.25

Unless otherwise stated the results shown in this test report refer only to the sample(s) tested and such sample(s) are retained for 90 days only.

除非另有說明，此報告結果僅對測試之樣品負責，同時此樣品僅保留90天。本報告未經本公司書面許可，不可部份複製。

This document is issued by the Company subject to its General Conditions of Service printed overleaf, available on request or accessible at <http://www.sgs.com.tw/Terms-and-Conditions> and for electronic format documents, subject to Terms and Conditions for Electronic Documents at <http://www.sgs.com.tw/Terms-and-Conditions>. Attention is drawn to the limitation of liability, indemnification and jurisdiction issues defined therein. Any holder of this document is advised that information contained hereon reflects the Company's findings at the time of its intervention only and within the limits of Client's instructions, if any. The Company's sole responsibility is to its Client and this document does not exonerate parties to a transaction from exercising all their rights and obligations under the transaction documents. This document cannot be reproduced except in full, without prior written approval of the Company. Any unauthorized alteration, forgery or falsification of the content or appearance of this document is unlawful and offenders may be prosecuted to the fullest extent of the law.

Report Number :ER/2021/50020
 Operation Mode :BLE(1M)
 Test Frequency :2480 MHz
 Test Mode :Tx CH High
 EUT Pol :E2 Plane

Test Site :SAC I Chamber
 Test Date :2021-06-26
 Temp./Humi. :25.8/61
 Antenna Pol. :VERTICAL
 Engineer :Neo Tsai

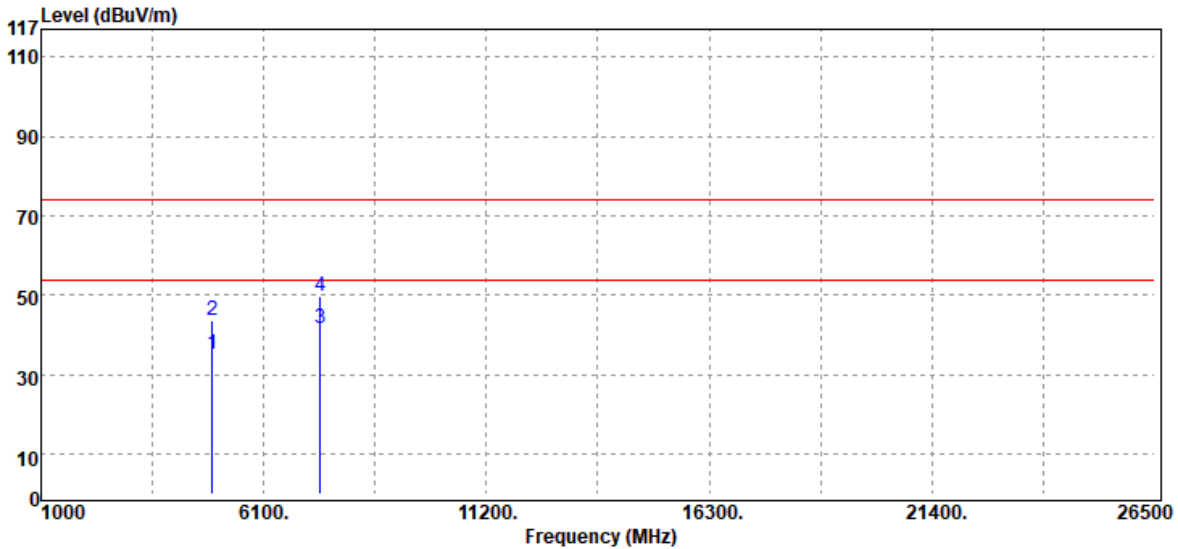

Freq. MHz	Detector Mode PK/QP/AV	Spectrum Reading Level dB μ V	Factor dB	Actual FS dB μ V/m	Limit @3m dB μ V/m	Margin dB
4924.00	Average	28.12	7.30	35.42	54.00	-18.58
4924.00	Peak	36.38	7.30	43.68	74.00	-30.32
7386.00	Average	27.22	14.55	41.77	54.00	-12.23
7386.00	Peak	35.40	14.55	49.95	74.00	-24.05

Unless otherwise stated the results shown in this test report refer only to the sample(s) tested and such sample(s) are retained for 90 days only.

除非另有說明，此報告結果僅對測試之樣品負責，同時此樣品僅保留90天。本報告未經本公司書面許可，不可部份複製。

This document is issued by the Company subject to its General Conditions of Service printed overleaf, available on request or accessible at <http://www.sgs.com.tw/Terms-and-Conditions> and for electronic format documents, subject to Terms and Conditions for Electronic Documents at <http://www.sgs.com.tw/Terms-and-Conditions>. Attention is drawn to the limitation of liability, indemnification and jurisdiction issues defined therein. Any holder of this document is advised that information contained hereon reflects the Company's findings at the time of its intervention only and within the limits of Client's instructions, if any. The Company's sole responsibility is to its Client and this document does not exonerate parties to a transaction from exercising all their rights and obligations under the transaction documents. This document cannot be reproduced except in full, without prior written approval of the Company. Any unauthorized alteration, forgery or falsification of the content or appearance of this document is unlawful and offenders may be prosecuted to the fullest extent of the law.

Report Number :ER/2021/50020
 Operation Mode :BLE(1M)
 Test Frequency :2480 MHz
 Test Mode :Tx CH High
 EUT Pol :E2 Plane

Test Site :SAC I Chamber
 Test Date :2021-06-26
 Temp./Humi. :25.8/61
 Antenna Pol. :HORIZONTAL
 Engineer :Neo Tsai

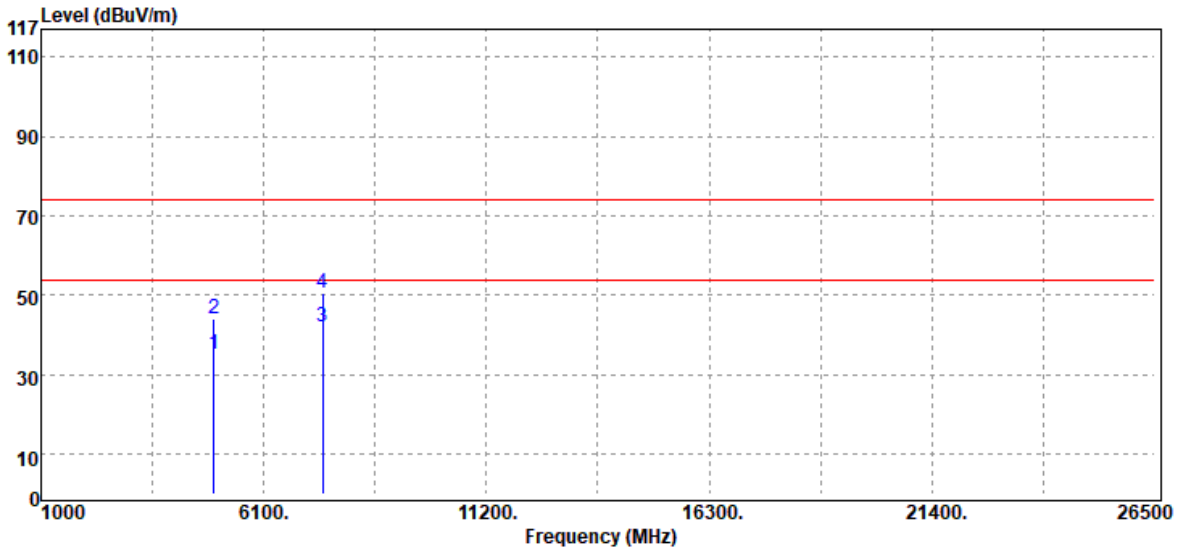

Freq. MHz	Detector Mode PK/QP/AV	Spectrum Reading Level dB μ V	Factor dB	Actual FS dB μ V/m	Limit @3m dB μ V/m	Margin dB
4960.00	Average	27.81	7.60	35.41	54.00	-18.59
4960.00	Peak	36.34	7.60	43.94	74.00	-30.06
7440.00	Average	27.22	14.77	41.99	54.00	-12.01
7440.00	Peak	35.67	14.77	50.44	74.00	-23.56

Unless otherwise stated the results shown in this test report refer only to the sample(s) tested and such sample(s) are retained for 90 days only.

除非另有說明，此報告結果僅對測試之樣品負責，同時此樣品僅保留90天。本報告未經本公司書面許可，不可部份複製。

This document is issued by the Company subject to its General Conditions of Service printed overleaf, available on request or accessible at <http://www.sgs.com.tw/Terms-and-Conditions> and for electronic format documents, subject to Terms and Conditions for Electronic Documents at <http://www.sgs.com.tw/Terms-and-Conditions>. Attention is drawn to the limitation of liability, indemnification and jurisdiction issues defined therein. Any holder of this document is advised that information contained hereon reflects the Company's findings at the time of its intervention only and within the limits of Client's instructions, if any. The Company's sole responsibility is to its Client and this document does not exonerate parties to a transaction from exercising all their rights and obligations under the transaction documents. This document cannot be reproduced except in full, without prior written approval of the Company. Any unauthorized alteration, forgery or falsification of the content or appearance of this document is unlawful and offenders may be prosecuted to the fullest extent of the law.

Report Number :ER/2021/50020
 Operation Mode :BLE(2M)
 Test Frequency :2402 MHz
 Test Mode :Tx CH Low
 EUT Pol :E2 Plane

Test Site :SAC I Chamber
 Test Date :2021-06-26
 Temp./Humi. :25.8/61
 Antenna Pol. :VERTICAL
 Engineer :Neo Tsai

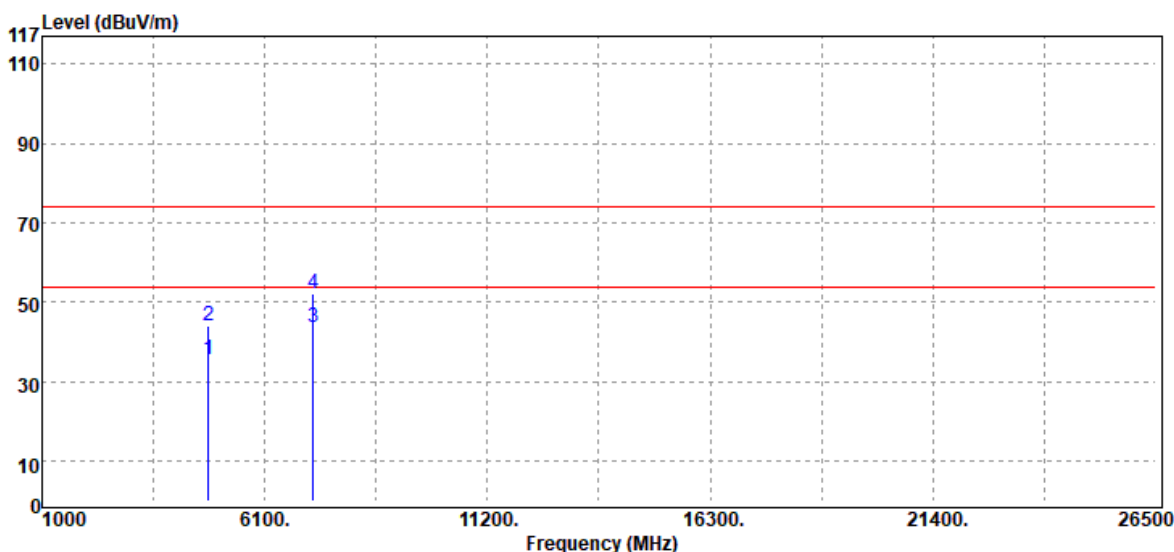

Freq. MHz	Detector Mode PK/QP/AV	Spectrum Reading Level dBµV	Factor dB	Actual FS dBµV/m	Limit @3m dBµV/m	Margin dB
4804.00	Average	28.44	7.16	35.60	54.00	-18.40
4804.00	Peak	37.09	7.16	44.25	74.00	-29.75
7206.00	Average	27.93	15.71	43.64	54.00	-10.36
7206.00	Peak	36.57	15.71	52.28	74.00	-21.72

Unless otherwise stated the results shown in this test report refer only to the sample(s) tested and such sample(s) are retained for 90 days only.

除非另有說明，此報告結果僅對測試之樣品負責，同時此樣品僅保留90天。本報告未經本公司書面許可，不可部份複製。

This document is issued by the Company subject to its General Conditions of Service printed overleaf, available on request or accessible at <http://www.sgs.com.tw/Terms-and-Conditions> and for electronic format documents, subject to Terms and Conditions for Electronic Documents at <http://www.sgs.com.tw/Terms-and-Conditions>. Attention is drawn to the limitation of liability, indemnification and jurisdiction issues defined therein. Any holder of this document is advised that information contained hereon reflects the Company's findings at the time of its intervention only and within the limits of Client's instructions, if any. The Company's sole responsibility is to its Client and this document does not exonerate parties to a transaction from exercising all their rights and obligations under the transaction documents. This document cannot be reproduced except in full, without prior written approval of the Company. Any unauthorized alteration, forgery or falsification of the content or appearance of this document is unlawful and offenders may be prosecuted to the fullest extent of the law.

Report Number :ER/2021/50020
 Operation Mode :BLE(2M)
 Test Frequency :2402 MHz
 Test Mode :Tx CH Low
 EUT Pol :E2 Plane

Test Site :SAC I Chamber
 Test Date :2021-06-26
 Temp./Humi. :25.8/61
 Antenna Pol. :HORIZONTAL
 Engineer :Neo Tsai

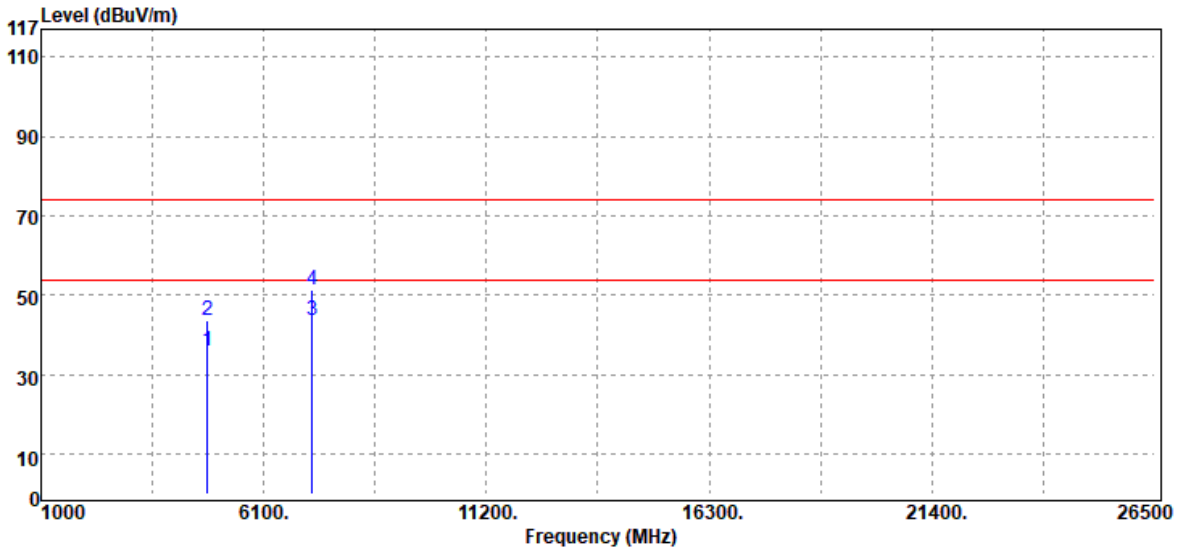

Freq. MHz	Detector Mode PK/QP/AV	Spectrum Reading Level dB μ V	Factor dB	Actual FS dB μ V/m	Limit @3m dB μ V/m	Margin dB
4804.00	Average	28.78	7.16	35.94	54.00	-18.06
4804.00	Peak	36.73	7.16	43.89	74.00	-30.11
7206.00	Average	27.84	15.71	43.55	54.00	-10.45
7206.00	Peak	35.64	15.71	51.35	74.00	-22.65

Unless otherwise stated the results shown in this test report refer only to the sample(s) tested and such sample(s) are retained for 90 days only.

除非另有說明，此報告結果僅對測試之樣品負責，同時此樣品僅保留90天。本報告未經本公司書面許可，不可部份複製。

This document is issued by the Company subject to its General Conditions of Service printed overleaf, available on request or accessible at <http://www.sgs.com.tw/Terms-and-Conditions> and for electronic format documents, subject to Terms and Conditions for Electronic Documents at <http://www.sgs.com.tw/Terms-and-Conditions>. Attention is drawn to the limitation of liability, indemnification and jurisdiction issues defined therein. Any holder of this document is advised that information contained hereon reflects the Company's findings at the time of its intervention only and within the limits of Client's instructions, if any. The Company's sole responsibility is to its Client and this document does not exonerate parties to a transaction from exercising all their rights and obligations under the transaction documents. This document cannot be reproduced except in full, without prior written approval of the Company. Any unauthorized alteration, forgery or falsification of the content or appearance of this document is unlawful and offenders may be prosecuted to the fullest extent of the law.

Report Number :ER/2021/50020
 Operation Mode :BLE(2M)
 Test Frequency :2442 MHz
 Test Mode :Tx CH Mid
 EUT Pol :E2 Plane

Test Site :SAC I Chamber
 Test Date :2021-06-26
 Temp./Humi. :25.8/61
 Antenna Pol. :VERTICAL
 Engineer :Neo Tsai

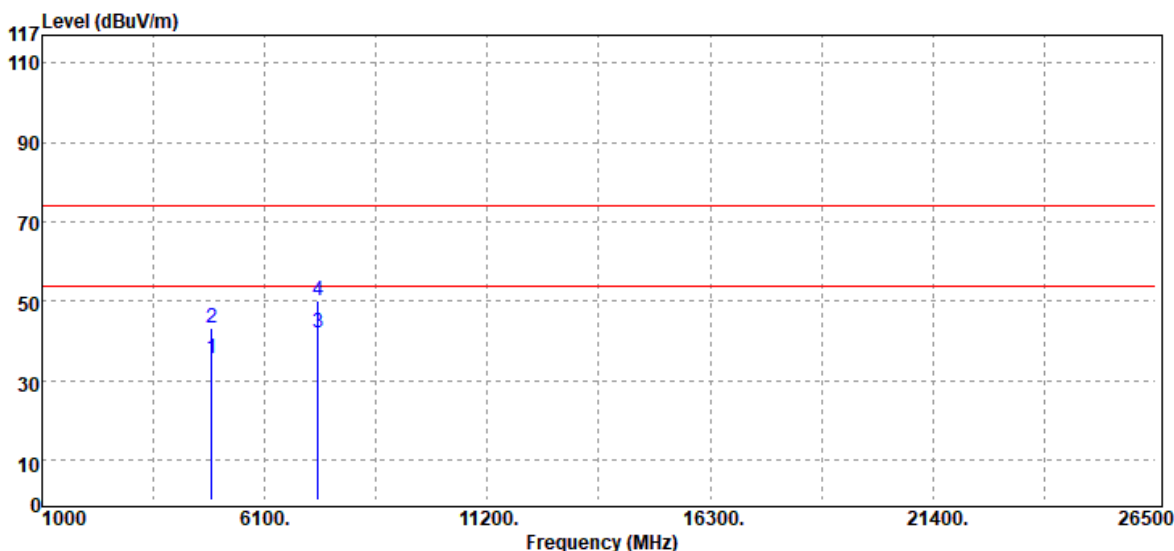

Freq. MHz	Detector Mode PK/QP/AV	Spectrum Reading Level dB μ V	Factor dB	Actual FS dB μ V/m	Limit @3m dB μ V/m	Margin dB
4884.00	Average	28.46	7.06	35.52	54.00	-18.48
4884.00	Peak	36.37	7.06	43.43	74.00	-30.57
7326.00	Average	27.37	14.87	42.24	54.00	-11.76
7326.00	Peak	35.26	14.87	50.13	74.00	-23.87

Unless otherwise stated the results shown in this test report refer only to the sample(s) tested and such sample(s) are retained for 90 days only.

除非另有說明，此報告結果僅對測試之樣品負責，同時此樣品僅保留90天。本報告未經本公司書面許可，不可部份複製。

This document is issued by the Company subject to its General Conditions of Service printed overleaf, available on request or accessible at <http://www.sgs.com.tw/Terms-and-Conditions> and for electronic format documents, subject to Terms and Conditions for Electronic Documents at <http://www.sgs.com.tw/Terms-and-Conditions>. Attention is drawn to the limitation of liability, indemnification and jurisdiction issues defined therein. Any holder of this document is advised that information contained hereon reflects the Company's findings at the time of its intervention only and within the limits of Client's instructions, if any. The Company's sole responsibility is to its Client and this document does not exonerate parties to a transaction from exercising all their rights and obligations under the transaction documents. This document cannot be reproduced except in full, without prior written approval of the Company. Any unauthorized alteration, forgery or falsification of the content or appearance of this document is unlawful and offenders may be prosecuted to the fullest extent of the law.

Report Number :ER/2021/50020
 Operation Mode :BLE(2M)
 Test Frequency :2442 MHz
 Test Mode :Tx CH Mid
 EUT Pol :E2 Plane

Test Site :SAC I Chamber
 Test Date :2021-06-26
 Temp./Humi. :25.8/61
 Antenna Pol. :HORIZONTAL
 Engineer :Neo Tsai

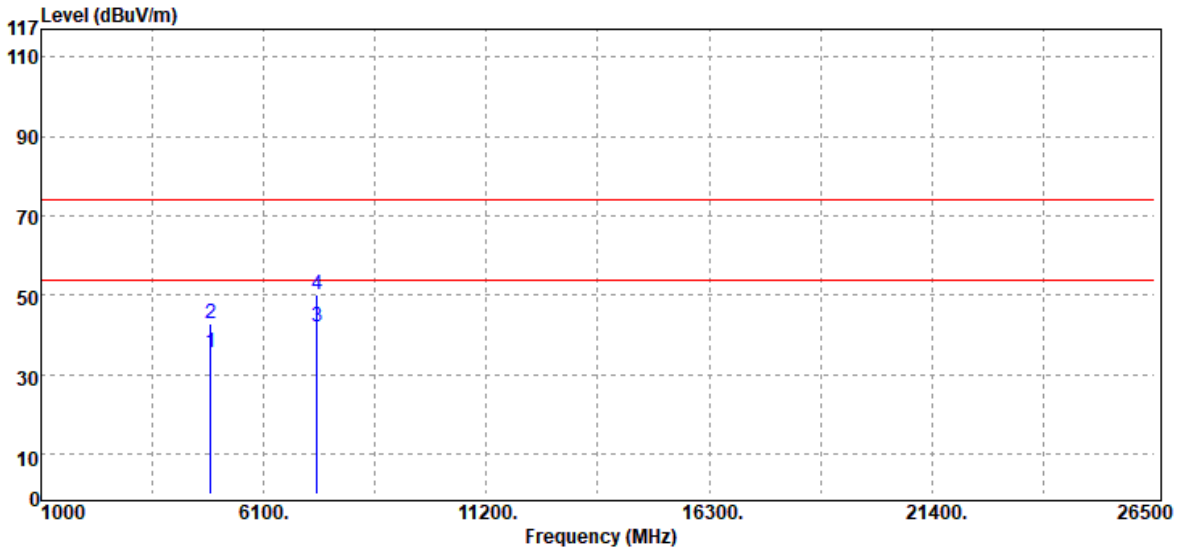

Freq. MHz	Detector Mode PK/QP/AV	Spectrum Reading Level dB μ V	Factor dB	Actual FS dB μ V/m	Limit @3m dB μ V/m	Margin dB
4884.00	Average	28.38	7.06	35.44	54.00	-18.56
4884.00	Peak	35.97	7.06	43.03	74.00	-30.97
7326.00	Average	27.41	14.87	42.28	54.00	-11.72
7326.00	Peak	35.41	14.87	50.28	74.00	-23.72

Unless otherwise stated the results shown in this test report refer only to the sample(s) tested and such sample(s) are retained for 90 days only.

除非另有說明，此報告結果僅對測試之樣品負責，同時此樣品僅保留90天。本報告未經本公司書面許可，不可部份複製。

This document is issued by the Company subject to its General Conditions of Service printed overleaf, available on request or accessible at <http://www.sgs.com.tw/Terms-and-Conditions> and for electronic format documents, subject to Terms and Conditions for Electronic Documents at <http://www.sgs.com.tw/Terms-and-Conditions>. Attention is drawn to the limitation of liability, indemnification and jurisdiction issues defined therein. Any holder of this document is advised that information contained hereon reflects the Company's findings at the time of its intervention only and within the limits of Client's instructions, if any. The Company's sole responsibility is to its Client and this document does not exonerate parties to a transaction from exercising all their rights and obligations under the transaction documents. This document cannot be reproduced except in full, without prior written approval of the Company. Any unauthorized alteration, forgery or falsification of the content or appearance of this document is unlawful and offenders may be prosecuted to the fullest extent of the law.

Report Number :ER/2021/50020
 Operation Mode :BLE(2M)
 Test Frequency :2480 MHz
 Test Mode :Tx CH High
 EUT Pol :E2 Plane

Test Site :SAC I Chamber
 Test Date :2021-06-26
 Temp./Humi. :25.8/61
 Antenna Pol. :VERTICAL
 Engineer :Neo Tsai

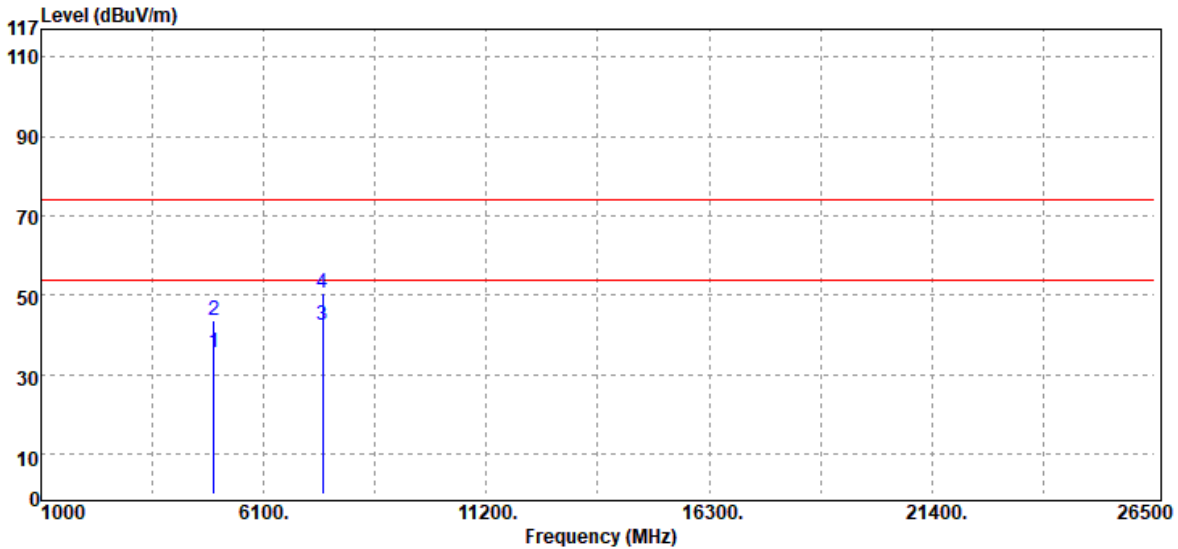

Freq. MHz	Detector Mode PK/QP/AV	Spectrum Reading Level dB μ V	Factor dB	Actual FS dB μ V/m	Limit @3m dB μ V/m	Margin dB
4960.00	Average	28.18	7.60	35.78	54.00	-18.22
4960.00	Peak	36.11	7.60	43.71	74.00	-30.29
7440.00	Average	27.88	14.77	42.65	54.00	-11.35
7440.00	Peak	35.78	14.77	50.55	74.00	-23.45

Unless otherwise stated the results shown in this test report refer only to the sample(s) tested and such sample(s) are retained for 90 days only.

除非另有說明，此報告結果僅對測試之樣品負責，同時此樣品僅保留90天。本報告未經本公司書面許可，不可部份複製。

This document is issued by the Company subject to its General Conditions of Service printed overleaf, available on request or accessible at <http://www.sgs.com.tw/Terms-and-Conditions> and for electronic format documents, subject to Terms and Conditions for Electronic Documents at <http://www.sgs.com.tw/Terms-and-Conditions>. Attention is drawn to the limitation of liability, indemnification and jurisdiction issues defined therein. Any holder of this document is advised that information contained hereon reflects the Company's findings at the time of its intervention only and within the limits of Client's instructions, if any. The Company's sole responsibility is to its Client and this document does not exonerate parties to a transaction from exercising all their rights and obligations under the transaction documents. This document cannot be reproduced except in full, without prior written approval of the Company. Any unauthorized alteration, forgery or falsification of the content or appearance of this document is unlawful and offenders may be prosecuted to the fullest extent of the law.

Report Number :ER/2021/50020
 Operation Mode :BLE(2M)
 Test Frequency :2480 MHz
 Test Mode :Tx CH High
 EUT Pol :E2 Plane

Test Site :SAC I Chamber
 Test Date :2021-06-26
 Temp./Humi. :25.8/61
 Antenna Pol. :HORIZONTAL
 Engineer :Neo Tsai

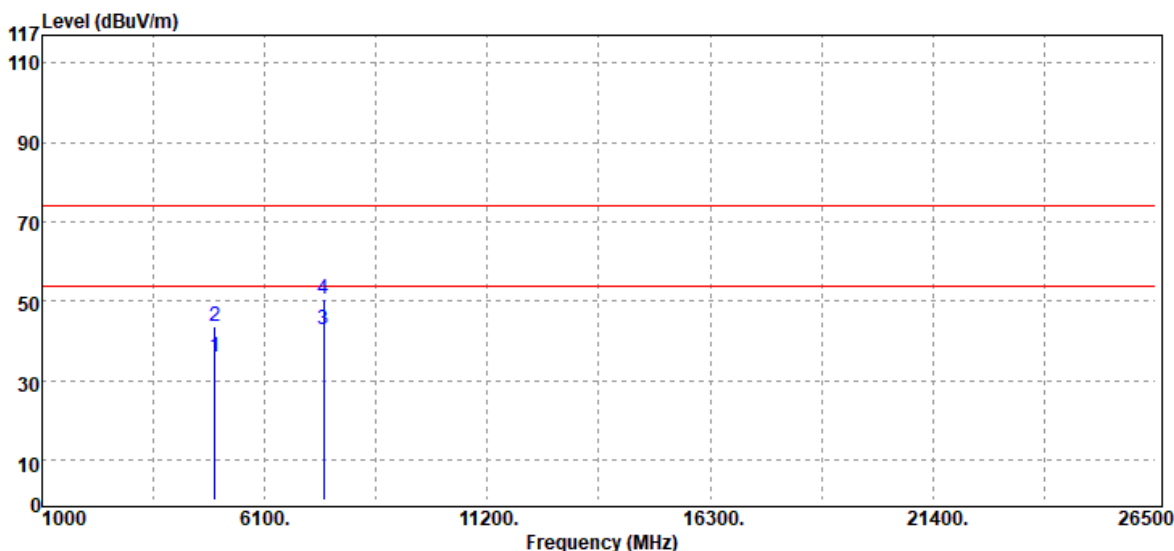

Freq. MHz	Detector Mode PK/QP/AV	Spectrum Reading Level dB μ V	Factor dB	Actual FS dB μ V/m	Limit @3m dB μ V/m	Margin dB
4960.00	Average	28.24	7.60	35.84	54.00	-18.16
4960.00	Peak	35.99	7.60	43.59	74.00	-30.41
7440.00	Average	28.01	14.77	42.78	54.00	-11.22
7440.00	Peak	35.82	14.77	50.59	74.00	-23.41

Unless otherwise stated the results shown in this test report refer only to the sample(s) tested and such sample(s) are retained for 90 days only.

除非另有說明，此報告結果僅對測試之樣品負責，同時此樣品僅保留90天。本報告未經本公司書面許可，不可部份複製。

This document is issued by the Company subject to its General Conditions of Service printed overleaf, available on request or accessible at <http://www.sgs.com.tw/Terms-and-Conditions> and for electronic format documents, subject to Terms and Conditions for Electronic Documents at <http://www.sgs.com.tw/Terms-and-Conditions>. Attention is drawn to the limitation of liability, indemnification and jurisdiction issues defined therein. Any holder of this document is advised that information contained hereon reflects the Company's findings at the time of its intervention only and within the limits of Client's instructions, if any. The Company's sole responsibility is to its Client and this document does not exonerate parties to a transaction from exercising all their rights and obligations under the transaction documents. This document cannot be reproduced except in full, without prior written approval of the Company. Any unauthorized alteration, forgery or falsification of the content or appearance of this document is unlawful and offenders may be prosecuted to the fullest extent of the law.

11 POWER SPECTRAL DENSITY

11.1 Standard Applicable:

The power spectral density conducted from the intentional radiator to the antenna shall not be greater than 8dBm in any 3 kHz band during any time interval of continuous transmission.

11.2 Measurement Equipment Used:

Conducted Emission Test Site: Conducted 4					
EQUIPMENT TYPE	MFR	MODEL NUMBER	SERIAL NUMBER	LAST CAL.	CAL DUE.
PXA Spectrum Analyzer	Agilent	N9030A	MY53120760	04/27/2021	04/26/2022
Attenuator	Mini-Circuit	BW-S10W2+	4	12/16/2020	12/15/2021
DC Block	Mini-Circuits	BLK-18-S+	1	12/16/2020	12/15/2021
Notebook	Lenovo	T440P	PC-014TAK	N/A	N/A

11.3 Test Set-up:

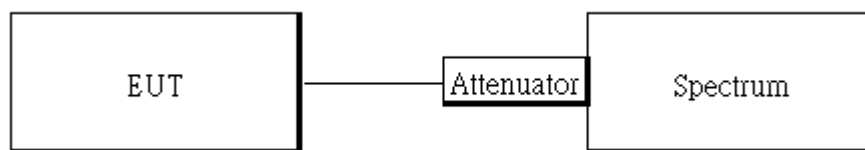

11.4 Measurement Procedure:

1. Set analyzer center frequency to DTS channel center frequency.
2. The testing follows the Measurement Procedure of FCC KDB 558074 D01 DTS Meas. Guidance.
3. Set the span to 1.5 times the DTS channel bandwidth.
4. Set the RBW = 3 kHz. & the VBW = 10 kHz
5. Detector = peak.
6. Sweep time = auto couple.
7. Trace mode = max hold.
8. Allow trace to fully stabilize.
9. Use the peak marker function to determine the maximum amplitude level.

Unless otherwise stated the results shown in this test report refer only to the sample(s) tested and such sample(s) are retained for 90 days only.

除非另有說明，此報告結果僅對測試之樣品負責，同時此樣品僅保留90天。本報告未經本公司書面許可，不可部份複製。

This document is issued by the Company subject to its General Conditions of Service printed overleaf, available on request or accessible at <http://www.sgs.com.tw/Terms-and-Conditions> and for electronic format documents, subject to Terms and Conditions for Electronic Documents at <http://www.sgs.com.tw/Terms-and-Conditions>. Attention is drawn to the limitation of liability, indemnification and jurisdiction issues defined therein. Any holder of this document is advised that information contained hereon reflects the Company's findings at the time of its intervention only and within the limits of Client's instructions, if any. The Company's sole responsibility is to its Client and this document does not exonerate parties to a transaction from exercising all their rights and obligations under the transaction documents. This document cannot be reproduced except in full, without prior written approval of the Company. Any unauthorized alteration, forgery or falsification of the content or appearance of this document is unlawful and offenders may be prosecuted to the fullest extent of the law.

11.5 Measurement Result:

Mode: BLE 1M

Frequency (MHz)	RF Power Density (dBm/3kHz)	Maximum Limit (dBm/3kHz)	Result
2402	-13.940	8	PASS
2442	-13.990	8	PASS
2480	-13.790	8	PASS

NOTE: cable loss as 10.9dB that offsets in the spectrum

Mode: BLE 2M

BLE 2M mode

Frequency (MHz)	RF Power Density (dBm)	Maximum Limit (dBm)	Result
2402	-17.480	8	PASS
2442	-17.450	8	PASS
2480	-17.260	8	PASS

NOTE: cable loss as 10.9dB that offsets in the spectrum

Unless otherwise stated the results shown in this test report refer only to the sample(s) tested and such sample(s) are retained for 90 days only.

除非另有說明，此報告結果僅對測試之樣品負責，同時此樣品僅保留90天。本報告未經本公司書面許可，不可部份複製。

This document is issued by the Company subject to its General Conditions of Service printed overleaf, available on request or accessible at <http://www.sgs.com.tw/Terms-and-Conditions> and for electronic format documents, subject to Terms and Conditions for Electronic Documents at <http://www.sgs.com.tw/Terms-and-Conditions>. Attention is drawn to the limitation of liability, indemnification and jurisdiction issues defined therein. Any holder of this document is advised that information contained hereon reflects the Company's findings at the time of its intervention only and within the limits of Client's instructions, if any. The Company's sole responsibility is to its Client and this document does not exonerate parties to a transaction from exercising all their rights and obligations under the transaction documents. This document cannot be reproduced except in full, without prior written approval of the Company. Any unauthorized alteration, forgery or falsification of the content or appearance of this document is unlawful and offenders may be prosecuted to the fullest extent of the law.

PSD_BLE 1M_LowCH00-2402MHz



PSD_BLE 2M_LowCH00-2402MHz

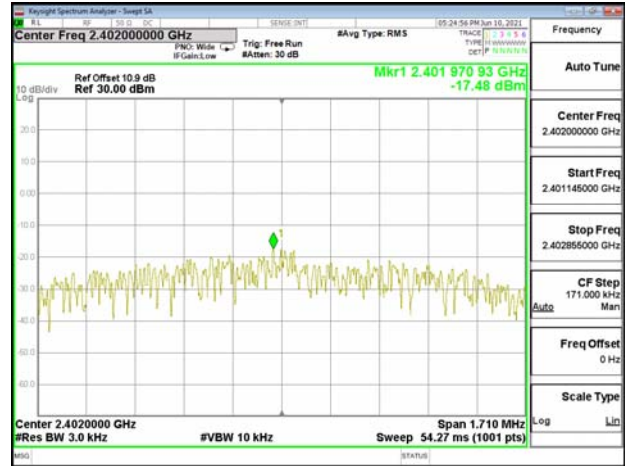

PSD_BLE 1M_MidCH20-2442MHz



PSD_BLE 2M_MidCH20-2442MHz

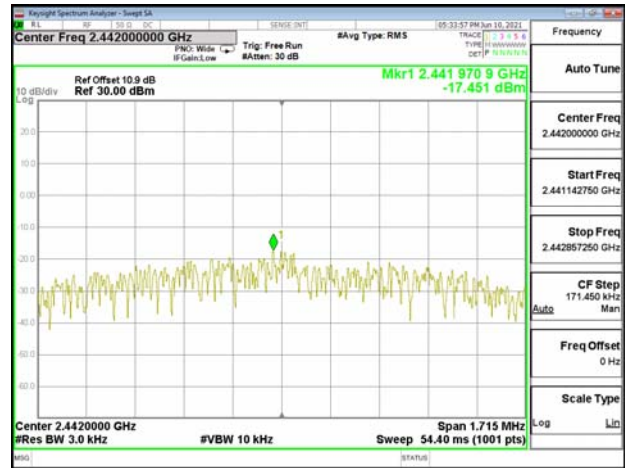

PSD_BLE 1M_HighCH39-2480MHz

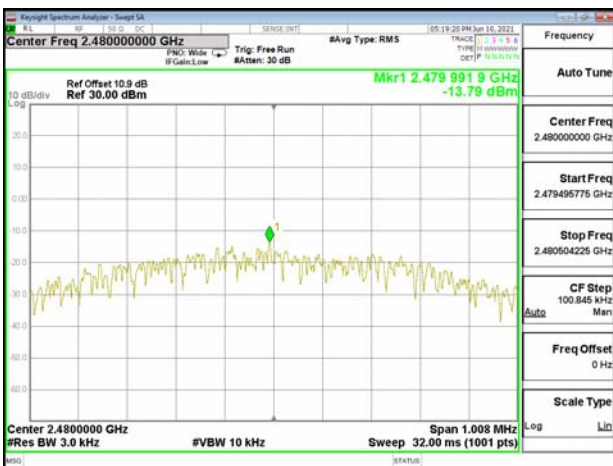

PSD_BLE 2M_HighCH39-2480MHz

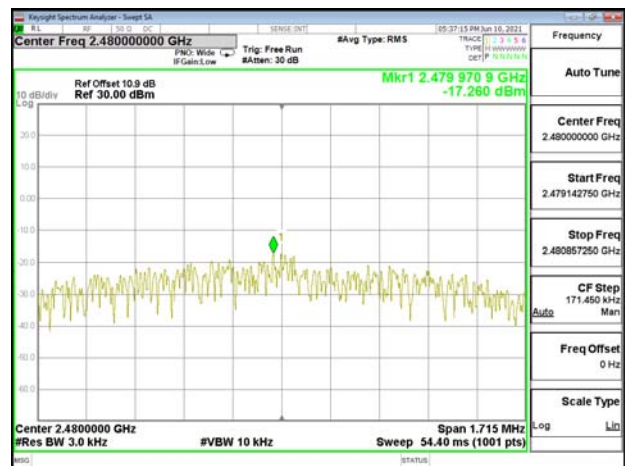

Unless otherwise stated the results shown in this test report refer only to the sample(s) tested and such sample(s) are retained for 90 days only.

除非另有說明，此報告結果僅對測試之樣品負責，同時此樣品僅保留90天。本報告未經本公司書面許可，不可部份複製。

This document is issued by the Company subject to its General Conditions of Service printed overleaf, available on request or accessible at <http://www.sgs.com.tw/Terms-and-Conditions> and for electronic format documents, subject to Terms and Conditions for Electronic Documents at <http://www.sgs.com.tw/Terms-and-Conditions>. Attention is drawn to the limitation of liability, indemnification and jurisdiction issues defined therein. Any holder of this document is advised that information contained herein reflects the Company's findings at the time of its intervention only and within the limits of Client's instructions, if any. The Company's sole responsibility is to its Client and this document does not exonerate parties to a transaction from exercising all their rights and obligations under the transaction documents. This document cannot be reproduced except in full, without prior written approval of the Company. Any unauthorized alteration, forgery or falsification of the content or appearance of this document is unlawful and offenders may be prosecuted to the fullest extent of the law.

12 ANTENNA REQUIREMENT

12.1 Standard Applicable:

For intentional device, according to §15.203, an intentional radiator shall be designed to ensure that no antenna other than furnished by the responsible party shall be used with the device.

12.2 Antenna Connected Construction:

The antenna is designed as permanently attached and no consideration of replacement. Please see EUT photo for details.

~ End of Report ~

Unless otherwise stated the results shown in this test report refer only to the sample(s) tested and such sample(s) are retained for 90 days only.

除非另有說明，此報告結果僅對測試之樣品負責，同時此樣品僅保留90天。本報告未經本公司書面許可，不可部份複製。

This document is issued by the Company subject to its General Conditions of Service printed overleaf, available on request or accessible at <http://www.sgs.com.tw/Terms-and-Conditions> and for electronic format documents, subject to Terms and Conditions for Electronic Documents at <http://www.sgs.com.tw/Terms-and-Conditions>. Attention is drawn to the limitation of liability, indemnification and jurisdiction issues defined therein. Any holder of this document is advised that information contained hereon reflects the Company's findings at the time of its intervention only and within the limits of Client's instructions, if any. The Company's sole responsibility is to its Client and this document does not exonerate parties to a transaction from exercising all their rights and obligations under the transaction documents. This document cannot be reproduced except in full, without prior written approval of the Company. Any unauthorized alteration, forgery or falsification of the content or appearance of this document is unlawful and offenders may be prosecuted to the fullest extent of the law.