

FCC Test Report

(Part 22)

Report No.: RF161004D09-5

FCC ID: HFS-C401U

Test Model: C401U

Received Date: Oct. 04, 2016

Test Date: Dec. 16, 2016 ~ Jan. 07, 2017

Issued Date: Jan. 19, 2017

Applicant: QUANTA COMPUTER INC.

Address: 188, WEN HUA 2ND RD., GUISHAN DIST., TAO YUAN CITY 33377, TAIWAN

Issued By: Bureau Veritas Consumer Products Services (H.K.) Ltd., Taoyuan Branch

Lab Address: No. 47-2, 14th Ling, Chia Pau Vil., Lin Kou Dist., New Taipei City, Taiwan (R.O.C.)

Test Location: No.19, Hwa Ya 2nd Rd., Wen Hwa Vil., Kwei Shan Dist., Taoyuan City 33383, TAIWAN (R.O.C.)



This report is for your exclusive use. Any copying or replication of this report to or for any other person or entity, or use of our name or trademark, is permitted only with our prior written permission. This report sets forth our findings solely with respect to the test samples identified herein. The results set forth in this report are not indicative or representative of the quality or characteristics of the lot from which a test sample was taken or any similar or identical product unless specifically and expressly noted. Our report includes all of the tests requested by you and the results thereof based upon the information that you provided to us. You have 60 days from date of issuance of this report to notify us of any material error or omission caused by our negligence, provided, however, that such notice shall be in writing and shall specifically address the issue you wish to raise. A failure to raise such issue within the prescribed time shall constitute your unqualified acceptance of the completeness of this report, the tests conducted and the correctness of the report contents. Unless specifically mentioned, the uncertainty of measurement has been explicitly taken into account to declare the compliance or non-compliance to the specification. The report must not be used by the client to claim product certification, approval, or endorsement by TAF or any government agencies

Table of Contents

Release Control Record	3
1 Certificate of Conformity	4
2 Summary of Test Results	5
2.1 Measurement Uncertainty.....	5
2.2 Test Site and Instruments.....	6
3 General Information	7
3.1 General Description of EUT.....	7
3.2 Configuration of System Under Test.....	8
3.2.1 Description of Support Units.....	8
3.3 Test Mode Applicability and Tested Channel Detail.....	9
3.4 EUT Operating Conditions.....	10
3.5 General Description of Applied Standards.....	10
4 Test Types and Results	11
4.1 Output Power Measurement.....	11
4.1.1 Limits of Output Power Measurement.....	11
4.1.2 Test Procedures.....	11
4.1.3 Test Setup.....	12
4.1.4 Test Results.....	13
4.2 Frequency Stability Measurement.....	15
4.2.1 Limits of Frequency Stability Measurement.....	15
4.2.2 Test Procedure.....	15
4.2.3 Test Setup.....	15
4.2.4 Test Results.....	16
4.3 Occupied Bandwidth Measurement.....	17
4.3.1 Test Procedure.....	17
4.3.2 Test Setup.....	17
4.3.3 Test Result.....	18
4.4 Band Edge Measurement.....	19
4.4.1 Limits of Band Edge Measurement.....	19
4.4.2 Test Setup.....	19
4.4.3 Test Procedures.....	19
4.4.4 Test Results.....	20
4.5 Peak To Average Ratio.....	21
4.5.1 Limits of Peak To Average Ratio Measurement.....	21
4.5.2 Test Setup.....	21
4.5.3 Test Procedures.....	21
4.5.4 Test Results.....	22
4.6 Conducted Spurious Emissions.....	23
4.6.1 Limits of Conducted Spurious Emissions Measurement.....	23
4.6.2 Test Setup.....	23
4.6.3 Test Procedure.....	23
4.6.4 Test Results.....	24
4.7 Radiated Emission Measurement.....	33
4.7.1 Limits of Radiated Emission Measurement.....	33
4.7.2 Test Procedure.....	33
4.7.3 Deviation from Test Standard.....	33
4.7.4 Test Setup.....	34
4.7.5 Test Results.....	35
5 Pictures of Test Arrangements	37
Appendix – Information on the Testing Laboratories	38

Release Control Record

Issue No.	Description	Date Issued
RF161004D09-5	Original release.	Jan. 19, 2017

1 Certificate of Conformity

Product: Clover Flex

Brand: clover

Test Model: C401U

Sample Status: Engineering sample

Applicant: QUANTA COMPUTER INC.

Test Date: Dec. 16, 2016 ~ Jan. 07, 2017

Standards: FCC Part 22, Subpart H

The above equipment has been tested by **Bureau Veritas Consumer Products Services (H.K.) Ltd., Taoyuan Branch**, and found compliance with the requirement of the above standards. The test record, data evaluation & Equipment Under Test (EUT) configurations represented herein are true and accurate accounts of the measurements of the sample's EMC characteristics under the conditions specified in this report.

Prepared by :

Pettie Chen / Senior Specialist

Date:

Jan. 19, 2017

Approved by :

Dylan Chiou / Project Engineer

Date:

Jan. 19, 2017

2 Summary of Test Results

Applied Standard: FCC Part 22 & Part 2			
FCC Clause	Test Item	Result	Remarks
2.1046 22.913 (a)	Effective radiated power	Pass	Meet the requirement of limit.
---	Peak To Average Ratio	Pass	Meet the requirement of limit.
2.1055 22.355	Frequency Stability	Pass	Meet the requirement of limit.
2.1049	Occupied Bandwidth	Pass	Meet the requirement of limit.
22.917	Band Edge Measurements	Pass	Meet the requirement of limit.
2.1051 22.917	Conducted Spurious Emissions	Pass	Meet the requirement of limit.
2.1053 22.917	Radiated Spurious Emissions	Pass	Meet the requirement of limit. Minimum passing margin is -35.5dB at 1672.80MHz.

2.1 Measurement Uncertainty

Where relevant, the following measurement uncertainty levels have been estimated for tests performed on the EUT as specified in CISPR 16-4-2:

Measurement	Frequency	Expanded Uncertainty (k=2) (\pm)
Radiated Emissions up to 1 GHz	30MHz ~ 200MHz	3.86 dB
	200MHz ~1000MHz	3.87 dB
Radiated Emissions above 1 GHz	1GHz ~ 18GHz	2.29 dB
	18GHz ~ 40GHz	2.29 dB

2.2 Test Site and Instruments

Description & Manufacturer	Model No.	Serial No.	Cal. Date	Cal. Due
Test Receiver ROHDE & SCHWARZ	ESIB7	100187	Apr. 18, 2016	Apr. 17, 2017
Spectrum Analyzer ROHDE & SCHWARZ	FSP40	100041	Nov. 16, 2016	Nov. 15, 2017
BILOG Antenna SCHWARZBECK	VULB9168	9168-151	Dec. 16, 2016	Dec. 15, 2017
HORN Antenna SCHWARZBECK	BBHA 9120 D	9120D-969	Dec. 12, 2016	Dec. 13, 2017
HORN Antenna SCHWARZBECK	BBHA 9170	BBHA9170241	Dec. 14, 2016	Dec. 13, 2017
Loop Antenna	EM-6879	269	Aug. 11, 2016	Aug. 10, 2017
Preamplifier Agilent	8447D	2944A10738	Aug. 22, 2016	Aug. 21, 2017
Preamplifier Agilent	8449B	3008A01964	Aug. 22, 2016	Aug. 21, 2017
RF signal cable HUBER+SUHNER	SUCOFLEX 104	Cable-CH3-03 (214378)	Aug. 22, 2016	Aug. 21, 2017
RF signal cable HUBER+SUHNER	SUCOFLEX 106	Cable-CH3-03 (309224+12738)	Aug. 22, 2016	Aug. 21, 2017
Software BV ADT	ADT_Radiated_ V7.6.15.9.4	NA	NA	NA
Antenna Tower inn-co GmbH	MA 4000	013303	NA	NA
Antenna Tower Controller BV ADT	AT100	AT93021702	NA	NA
Turn Table BV ADT	TT100	TT93021702	NA	NA
Turn Table Controller BV ADT	SC100	SC93021702	NA	NA
High Speed Peak Power Meter	ML2495A	0824012	Aug. 11, 2016	Aug. 10, 2017
Power Sensor	MA2411B	0738171	Aug. 11, 2016	Aug. 10, 2017
WIT Standard Temperature And Humidity Chamber	TH-4S-C	W981030	Jun. 08, 2016	Jun. 07, 2017
Mini-Circuits Power Splitter	ZN2PD-9G	NA	Jun. 13, 2016	Jun. 12, 2017
JFW 20dB attenuation	50HF-020-SMA	NA	NA	NA

- Note: 1. The calibration interval of the above test instruments is 12 months and the calibrations are traceable to NML/ROC and NIST/USA.
2. The test was performed in HwaYa Chamber 3.
3. The horn antenna and preamplifier (model: 8449B) are used only for the measurement of emission frequency above 1GHz if tested.
4. The FCC Site Registration No. is 988962.
5. The IC Site Registration No. is IC 7450F-3.

3 General Information

3.1 General Description of EUT

Product	Clover Flex
Brand	clover
Test Model	C401U
Sample Status	Engineering sample
Power Supply Rating	7.6 Vdc (Battery) 12Vdc (Adapter)
Modulation Type	WCDMA: BPSK, QPSK HSDPA: BPSK HSUPA: QPSK
Operating Frequency	WCDMA, HSDPA, HSUPA: 826.4MHz ~ 846.6MHz
Max. ERP Power	WCDMA: 123.027mW (20.9dBm)
Antenna Type	PIFA antenna with -5.7dBi gain
Antenna Connector	NA
Accessory Device	Charging Dock (Brand: Clover, Model: K400) Microhub (Brand: Clover, Model: H400)
Data Cable Supplied	0.8m shielded Type-C cable without core

Note:

1. The EUT consumes power from the following battery and adapter.

Battery	
Brand	LG Chem, Ltd.
Model	MPPCLOYJ4
Rating	7.6Vdc, 2170mAh (Typ)

Adapter	
Brand	clover
Model	FSP040-RHBN2 A
Input Power	100-240Vac~, 1.5A, 50-60Hz
Output Power	12.0Vdc / 3.33A
Power Line	1.2m shielded DC cable with one core

2. Spurious emission of the simultaneous operation (WLAN+WWAN+NFC or BT+WWAN+NFC) has been evaluated and no non-compliance was found.

3.2 Configuration of System Under Test

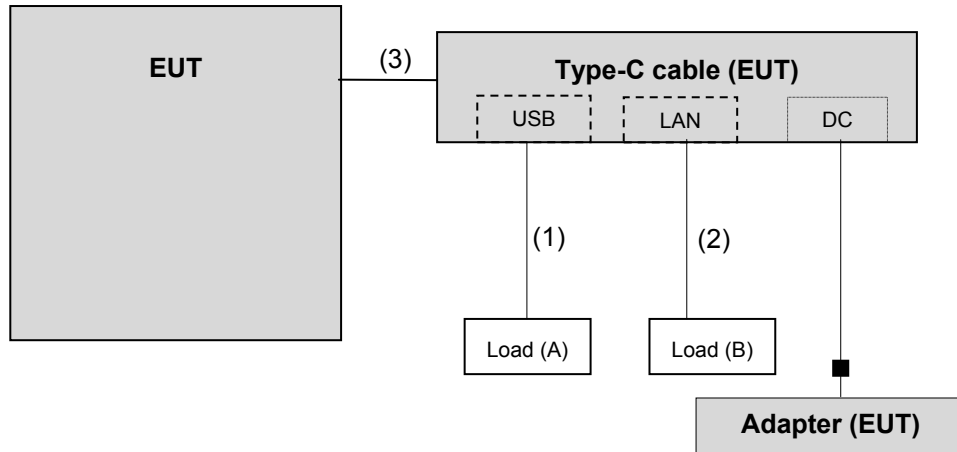

3.2.1 Description of Support Units

The EUT has been tested as an independent unit together with other necessary accessories or support units. The following support units or accessories were used to form a representative test configuration during the tests.

ID	Product	Brand	Model No.	Serial No.	FCC ID	Remarks
A.	Load	N/A	N/A	N/A	N/A	-
B.	Load	N/A	N/A	N/A	N/A	-
C.	Universal Radio Communication Tester	R&S	CMU200	123112	NA	-

Note:

1. All power cords of the above support units are non-shielded (1.8m).
2. Item C acted as a communication partner to transfer data.

ID	Descriptions	Qty.	Length (m)	Shielding (Yes/No)	Cores (Qty.)	Remarks
1.	USB cable	1	1.8	N	0	-
2.	LAN cable	1	1.8	N	0	-
3.	Type-C cable	1	0.8	Y	0	Accessory of EUT

3.3 Test Mode Applicability and Tested Channel Detail

Pre-Scan has been conducted to determine the worst-case mode from all possible combinations between available modulations, data rates, XYZ axis and antenna ports. The worst case was found when positioned on X-plane. Following channel(s) was (were) selected for the final test as listed below:

EUT Configure Mode	Test Item	Available Channel	Tested Channel	Mode
-	ERP	4132 to 4233	4132, 4182, 4233	WCDMA
-	Frequency Stability	4132 to 4233	4182	WCDMA
-	Occupied Bandwidth	4132 to 4233	4132, 4182, 4233	WCDMA, HSDPA, HSUPA
-	Band Edge	4132 to 4233	4132, 4233	WCDMA, HSDPA, HSUPA
-	Peak To Average Ratio	4132 to 4233	4132, 4182, 4233	WCDMA, HSDPA, HSUPA
-	Condcudeted Emission	4132 to 4233	4132, 4182, 4233	WCDMA, HSDPA, HSUPA
-	Radiated Emission Below 1GHz	4132 to 4233	4182	WCDMA
-	Radiated Emission Above 1GHz	4132 to 4233	4132, 4182, 4233	WCDMA

Note: The EUT had been pre-tested on the positioned of each 3 axis. The worst case was found when positioned on Y-plane.

Test Condition:

Test Item	Environmental Conditions	Input Power	Tested By
ERP	20deg. C, 66%RH	120Vac, 60Hz	Jones Chang
Frequency Stability	24deg. C, 64%RH	120Vac, 60Hz	Match Tsui
Occupied Bandwidth	24deg. C, 64%RH	120Vac, 60Hz	Match Tsui
Band Edge	24deg. C, 64%RH	120Vac, 60Hz	Match Tsui
Peak To Average Ratio	24deg. C, 64%RH	120Vac, 60Hz	Match Tsui
Condcudeted Emission	24deg. C, 64%RH	120Vac, 60Hz	Match Tsui
Radiated Emission	20deg. C, 66%RH	120Vac, 60Hz	Jones Chang

3.4 EUT Operating Conditions

The EUT makes a call to the communication simulator. The communication simulator station system controlled a EUT to export maximum output power under transmission mode and specific channel frequency

3.5 General Description of Applied Standards

The EUT is a RF Product. According to the specifications of the manufacturer, it must comply with the requirements of the following standards:

FCC 47 CFR Part 2

FCC 47 CFR Part 22

KDB 971168 D01 Power Meas License Digital Systems v02r02

ANSI/TIA/EIA-603 D2010

All test items have been performed and recorded as per the above standards.

4 Test Types and Results

4.1 Output Power Measurement

4.1.1 Limits of Output Power Measurement

Mobile / Portable station are limited to 7 watts e.r.p.

4.1.2 Test Procedures

EIRP / ERP Measurement:

- a. All measurements were done at low, middle and high operational frequency range. RBW and VBW is 5MHz for WCDMA, HSDPA, HSUPA mode.
- b. Substitution method is used for E.I.R.P measurement. In the semi-anechoic chamber, EUT placed on the 0.8m height of Turn Table, rotated the table around 360 degrees to search the maximum radiation power and receiver antenna shall be rotated vertical and horizontal polarization and moved height from 1m to 4m to find the maximum polar radiated power. The "Read Value" is the spectrum reading the maximum power value.
- c. The substitution horn antenna is substituted for EUT at the same position and signals generator export the CW signal to the substitution antenna via a TX cable. Rotated the Turn Table and moved receiving antenna to find the maximum radiation power. Adjust output power level of S.G to get a Value of spectrum reading equal to "Read Value" of step b. Record the power level of S.G
- d. $EIRP = \text{Output power level of S.G} - \text{TX cable loss} + \text{Antenna gain of substitution horn}$. E.R.P power can be calculated form E.I.R.P power by subtracting the gain of dipole, $E.R.P \text{ power} = E.I.R.P \text{ power} - 2.15\text{dBi}$.

Conducted Power Measurement:

The EUT was set up for the maximum power with WCDMA, HSDPA, HSUPA link data modulation and link up with simulator. Set the EUT to transmit under low, middle and high channel and record the power level shown on simulator.

4.1.3 Test Setup

EIRP / ERP Measurement:

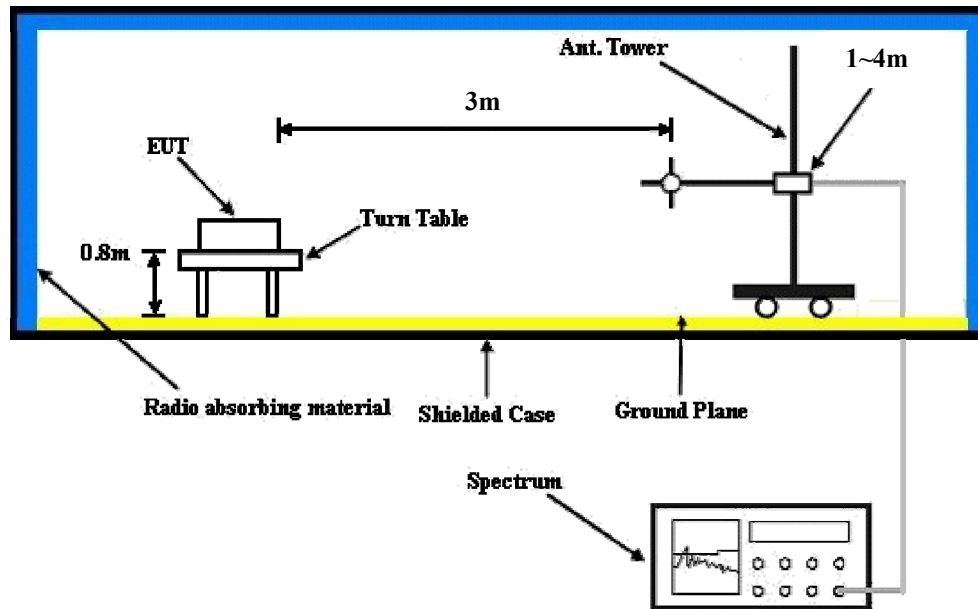

For the actual test configuration, please refer to the attached file (Test Setup Photo).

Conducted Power Measurement:

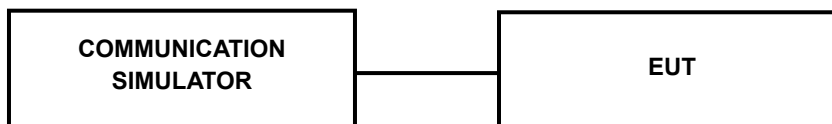

For the actual test configuration, please refer to the attached file (Test Setup Photo).

4.1.4 Test Results

Conducted Output Power (dBm)

Band	WCDMA V		
	4132	4182	4233
Channel	826.4	836.4	846.6
Frequency (MHz)	826.4	836.4	846.6
RMC 12.2K	22.91	22.98	22.84
HSDPA Subtest-1	22.86	22.95	22.77
HSDPA Subtest-2	22.65	22.71	22.48
HSDPA Subtest-3	22.36	22.44	22.30
HSDPA Subtest-4	22.04	22.14	22.00
HSUPA Subtest-1	21.76	21.80	21.65
HSUPA Subtest-2	20.56	20.63	20.51
HSUPA Subtest-3	21.52	21.59	21.43
HSUPA Subtest-4	20.50	20.44	20.53
HSUPA Subtest-5	22.56	22.62	22.40

ERP Power (dBm)

Mode		TX channel 4132					
Antenna Polarity & Test Distance: Horizontal at 3 M							
No.	Freq. (MHz)	Reading (dBm)	S.G Power Value (dBm)	Correction Factor (dB)	ERP (dBm)	Limit (dBm)	Margin (dB)
1	826.4	-13.7	20.9	0.0	20.9	38.5	-17.6
Antenna Polarity & Test Distance: Vertical at 3 M							
No.	Freq. (MHz)	Reading (dBm)	S.G Power Value (dBm)	Correction Factor (dB)	ERP (dBm)	Limit (dBm)	Margin (dB)
1	826.4	-19.4	14.7	0.0	14.7	38.5	-23.8

Mode		TX channel 4182					
Antenna Polarity & Test Distance: Horizontal at 3 M							
No.	Freq. (MHz)	Reading (dBm)	S.G Power Value (dBm)	Correction Factor (dB)	ERP (dBm)	Limit (dBm)	Margin (dB)
1	836.4	-14.6	19.8	0.2	20.0	38.5	-18.5
Antenna Polarity & Test Distance: Vertical at 3 M							
No.	Freq. (MHz)	Reading (dBm)	S.G Power Value (dBm)	Correction Factor (dB)	ERP (dBm)	Limit (dBm)	Margin (dB)
1	836.4	-23.4	10.5	0.2	10.7	38.5	-27.8

Mode		TX channel 4233					
Antenna Polarity & Test Distance: Horizontal at 3 M							
No.	Freq. (MHz)	Reading (dBm)	S.G Power Value (dBm)	Correction Factor (dB)	ERP (dBm)	Limit (dBm)	Margin (dB)
1	846.6	-14.9	19.3	0.4	19.7	38.5	-18.8
Antenna Polarity & Test Distance: Vertical at 3 M							
No.	Freq. (MHz)	Reading (dBm)	S.G Power Value (dBm)	Correction Factor (dB)	ERP (dBm)	Limit (dBm)	Margin (dB)
1	846.6	-19.5	14.2	0.4	14.6	38.5	-23.9

Note: ERP (dBm) = S.G Power Value (dBm) + Correction Factor (dB).

4.2 Frequency Stability Measurement

4.2.1 Limits of Frequency Stability Measurement

1.5 ppm is for base and fixed station. 2.5 ppm is for mobile station.

4.2.2 Test Procedure

- Device is placed at the oven room. The oven room could control the temperatures and humidity. Power warm up is at least 15 min and power applied should perform before recording frequency error.
- EUT is connected the external power supply to control the AC input power. The test voltage range is from minimum to maximum working voltage. Each step shall be record the frequency error rate.
- The temperature range step is 10 degrees in this test items. All temperature levels shall be hold the ± 0.5 °C during the measurement testing. The each temperature step shall be at least 0.5 hours, consider the EUT could be test under the stability condition.

Note: The frequency error was recorded frequency error from the communication simulator.

4.2.3 Test Setup

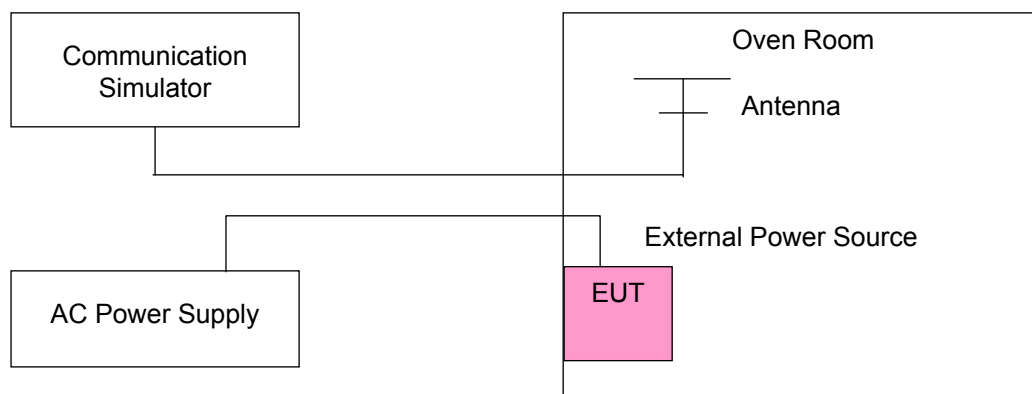

4.2.4 Test Results

Frequency Error vs. Voltage

Voltage (Volts)	Frequency Error (ppm)	Limit (ppm)
	WCDMA	
132	-0.015	2.5
120	-0.013	2.5
108	-0.014	2.5

Note: The applicant defined the normal working voltage of the battery is from 108Vac to 132Vac.

Frequency Error vs. Temperature.

TEMP. (°C)	Frequency Error (ppm)	Limit (ppm)
	WCDMA	
50	-0.014	2.5
40	-0.014	2.5
30	-0.013	2.5
20	-0.013	2.5
10	-0.014	2.5
0	-0.015	2.5
-10	-0.015	2.5
-20	-0.018	2.5

4.3 Occupied Bandwidth Measurement

4.3.1 Test Procedure

The EUT makes a call to the communication simulator. All measurements were done at low, middle and high operational frequency range. The communication simulator station system controlled a EUT to export maximum output power under transmission mode and specific channel frequency. Use OBW measurement function of Spectrum analyzer to measure 99 % occupied bandwidth.

4.3.2 Test Setup

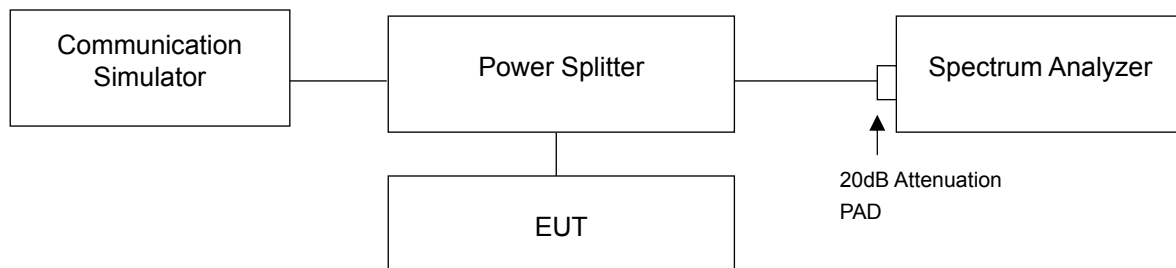

4.3.3 Test Result

Channel	Frequency (MHz)	99% Occupied Bandwidth (MHz)		
		WCDMA	HSDPA	HSUPA
4132	826.4	4.10	4.03	4.08
4182	836.4	4.10	4.08	4.08
4233	846.6	4.08	4.07	4.10

Spectrum Plot of Worst Value

WCDMA

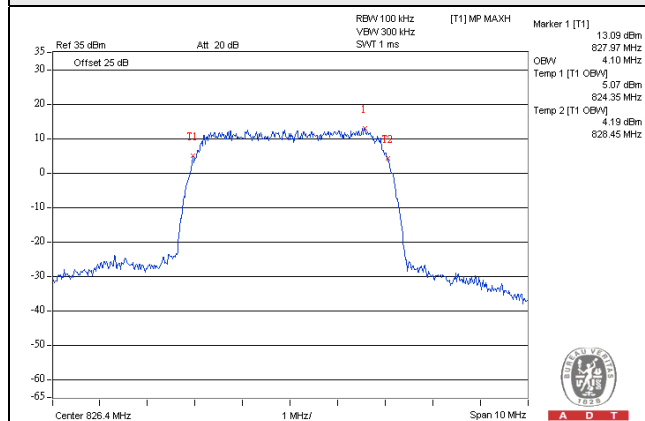

HSDPA

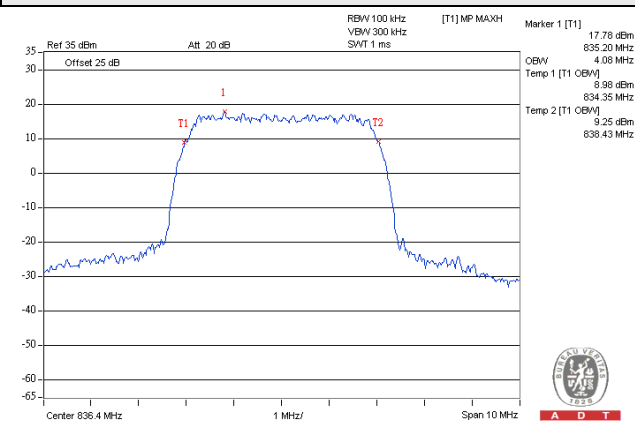

HSUPA

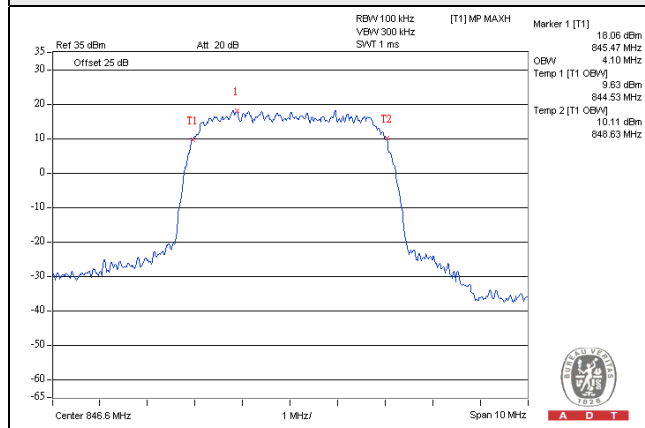

4.4 Band Edge Measurement

4.4.1 Limits of Band Edge Measurement

Power of any emission outside of the authorized operating frequency ranges must be attenuated below the transmitting power (P) by a factor of at least $43 + 10 \log(P)$ dB. In the 1 MHz bands immediately outside and adjacent to the frequency block a resolution bandwidth of at least one percent of the emission bandwidth of the fundamental emission of the transmitter may be employed.

4.4.2 Test Setup

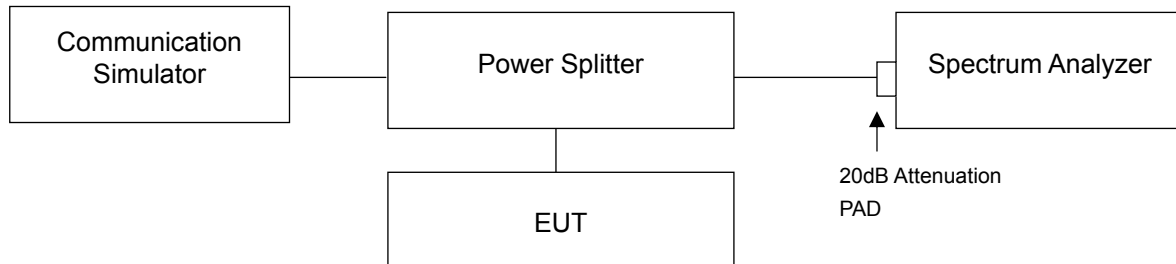

4.4.3 Test Procedures

- All measurements were done at low and high operational frequency range.
- The center frequency of spectrum is the band edge frequency and span is 10MHz. RB of the spectrum is 100kHz and VB of the spectrum is 300kHz (WCDMA / HSDPA / HSUPA).
- Record the max trace plot into the test report.

4.4.4 Test Results

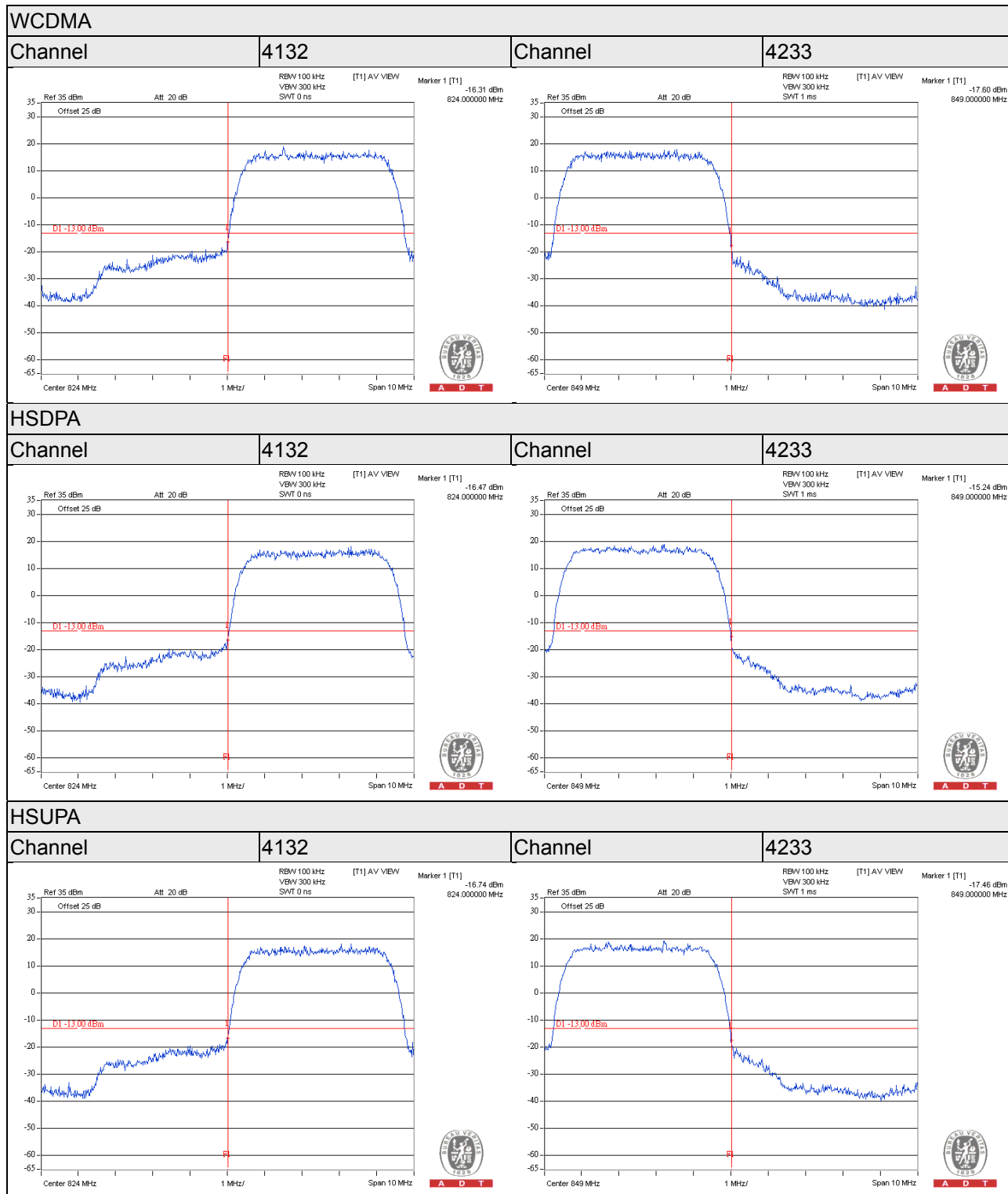

4.5 Peak to Average Ratio

4.5.1 Limits of Peak to Average Ratio Measurement

In measuring transmissions in this band using an average power technique, the peak to-average ratio (PAR) of the transmission may not exceed 13 dB

4.5.2 Test Setup

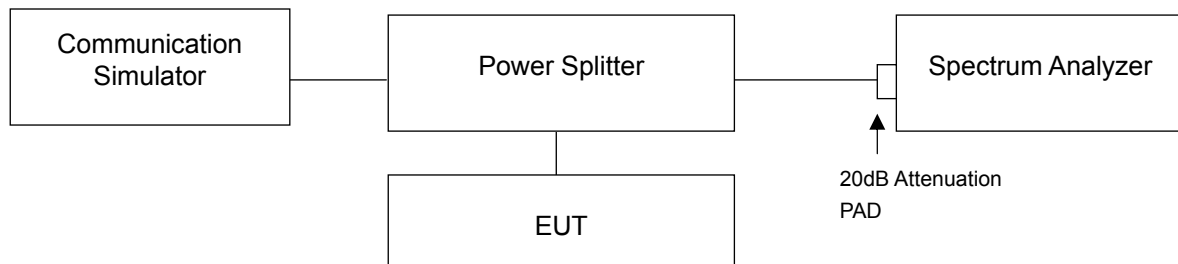

4.5.3 Test Procedures

1. Set resolution/measurement bandwidth \geq signal's occupied bandwidth;
2. Set the number of counts to a value that stabilizes the measured CCDF curve;
3. Record the maximum PAPR level associated with a probability of 0.1%.

4.5.4 Test Results

Channel	Frequency (MHz)	Peak To Average Ratio (dB)		
		WCDMA	HSDPA	HSUPA
4132	826.4	3.25	3.26	3.27
4182	836.4	3.40	3.37	3.36
4233	846.6	3.29	3.28	3.30

Spectrum Plot of Worst Value

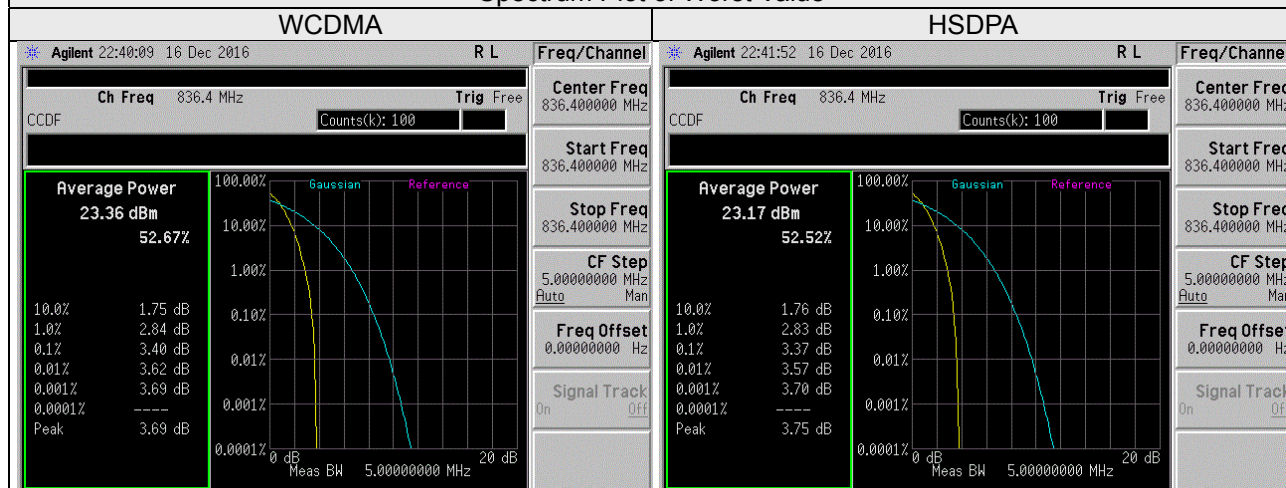

Copyright 2000-2012 Agilent Technologies



Copyright 2000-2012 Agilent Technologies

4.6 Conducted Spurious Emissions

4.6.1 Limits of Conducted Spurious Emissions Measurement

The power of any emission outside of the authorized operating frequency ranges must be attenuated below the transmitting power (P) by a factor of at least $43 + 10 \log(P)$ dB. The emission limit equal to -13dBm .

4.6.2 Test Setup

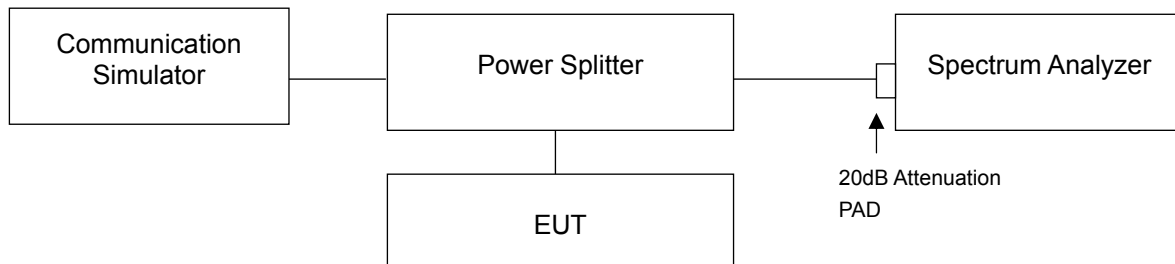

4.6.3 Test Procedure

- The EUT makes a phone call to the communication simulator. All measurements were done at low, middle and high operational frequency range.
- Measuring frequency range is from 9 kHz to 9GHz. 20dB attenuation pad is connected with spectrum. RBW=1MHz and VBW=3MHz is used for conducted emission measurement.

4.6.4 Test Results

WCDMA

Channel 4132

Frequency Range : 9kHz~1GHz Frequency Range : 1GHz~4GHz

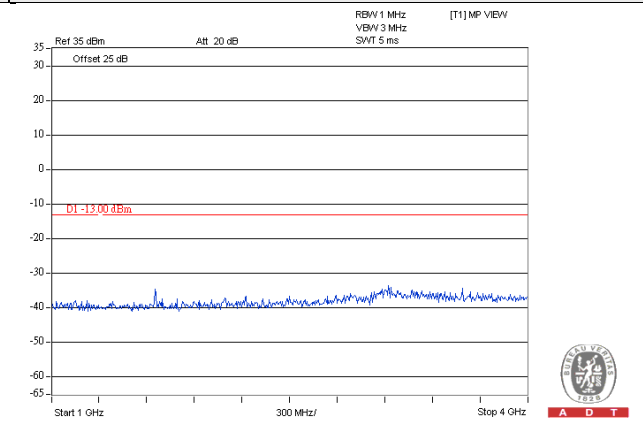
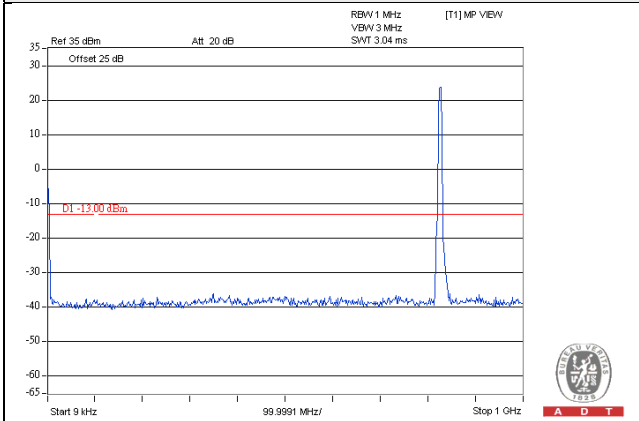

Frequency Range : 4GHz~7GHz Frequency Range : 7GHz~9GHz

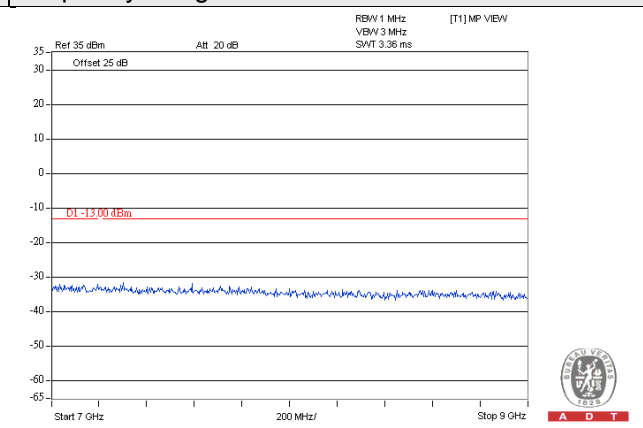
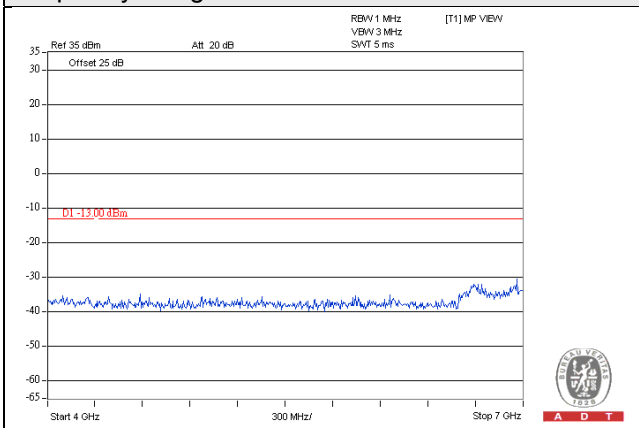

WCDMA

Channel 4182

Frequency Range : 9kHz~1GHz

Frequency Range : 1GHz~4GHz

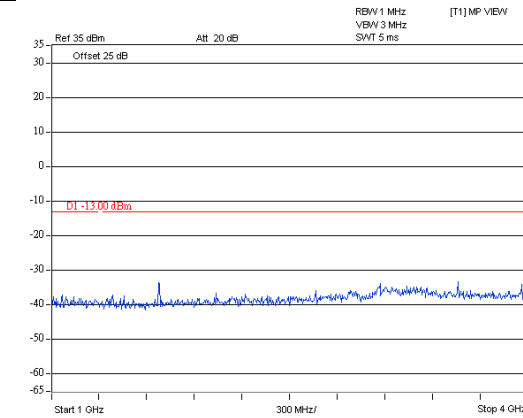
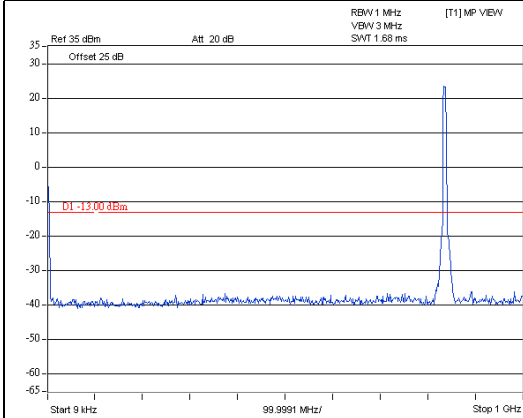

Frequency Range : 4GHz~7GHz

Frequency Range : 7GHz~9GHz

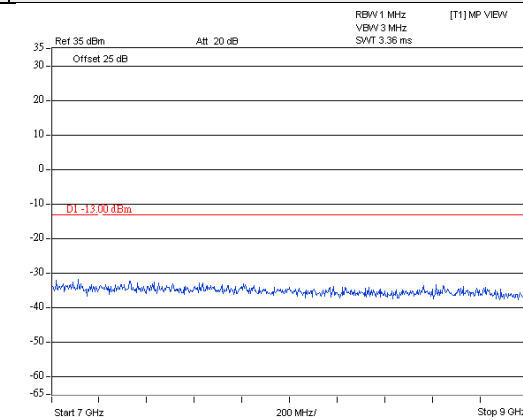
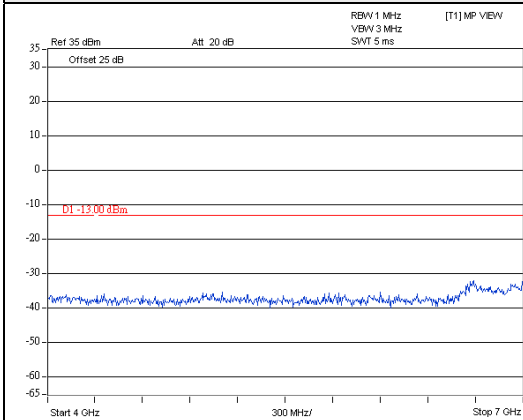

WCDMA

Channel 4233

Frequency Range : 9kHz~1GHz

Frequency Range : 1GHz~4GHz

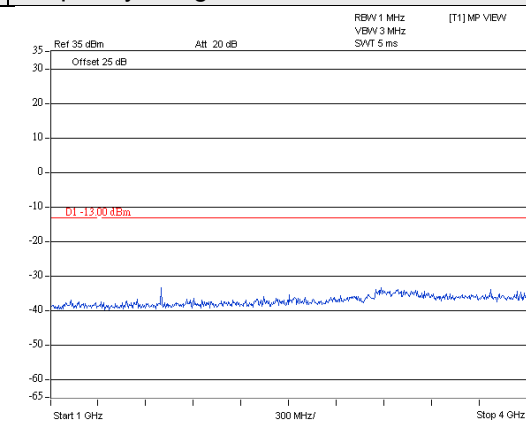
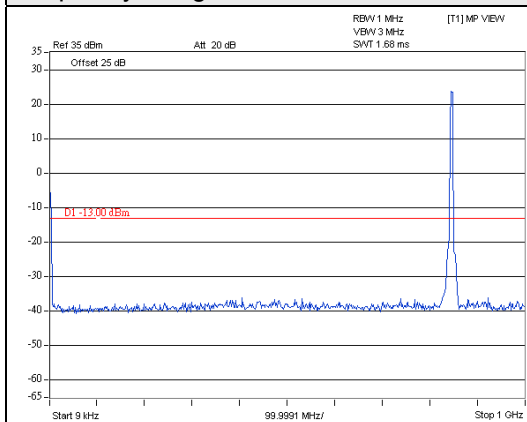

Frequency Range : 4GHz~7GHz

Frequency Range : 7GHz~9GHz

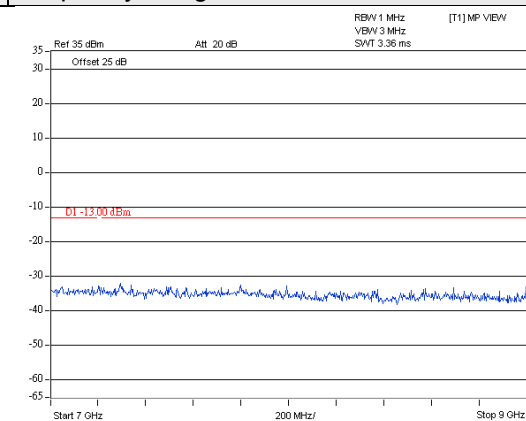
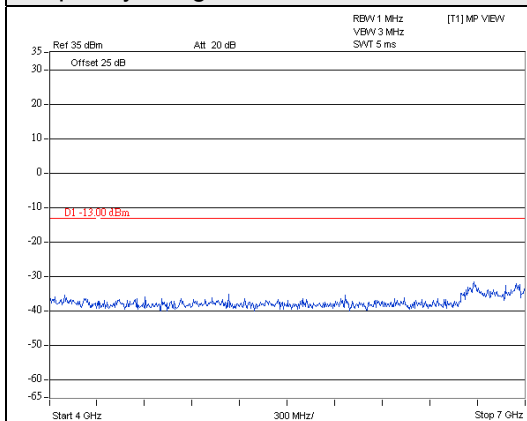

HSDPA

Channel 4132

Frequency Range : 9kHz~1GHz

Frequency Range : 1GHz~4GHz

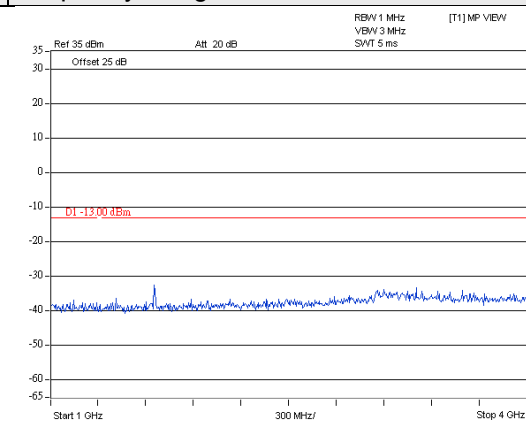
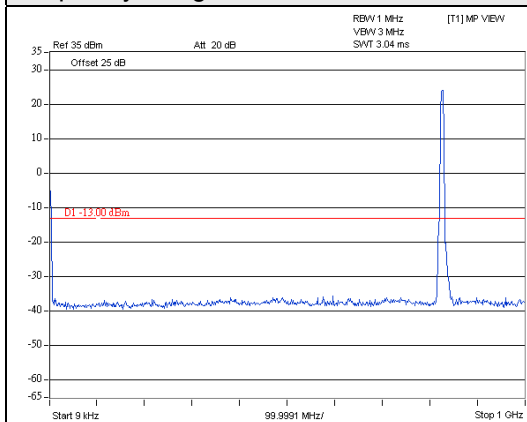

Frequency Range : 4GHz~7GHz

Frequency Range : 7GHz~9GHz

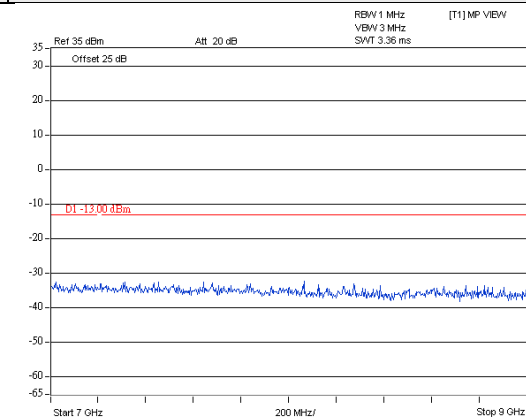
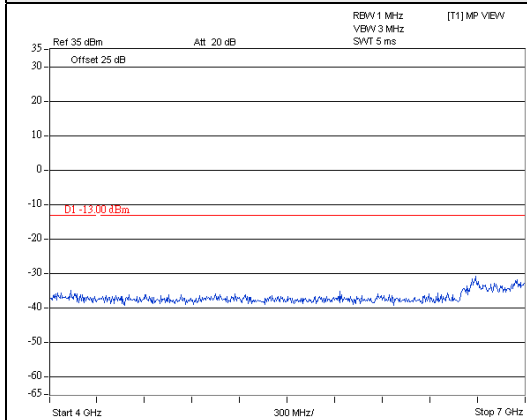

HSDPA

Channel 4182

Frequency Range : 9kHz~1GHz

Frequency Range : 1GHz~4GHz

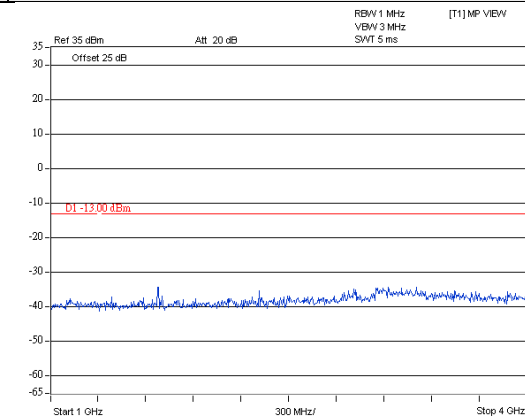
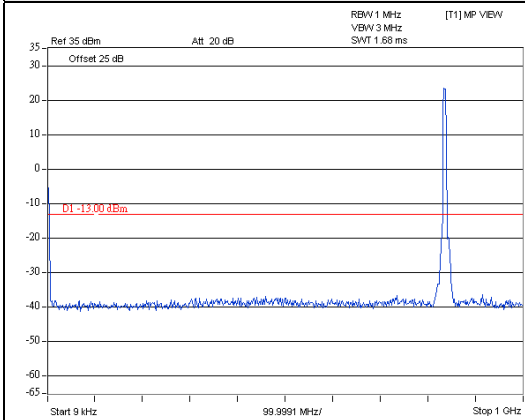

Frequency Range : 4GHz~7GHz

Frequency Range : 7GHz~9GHz

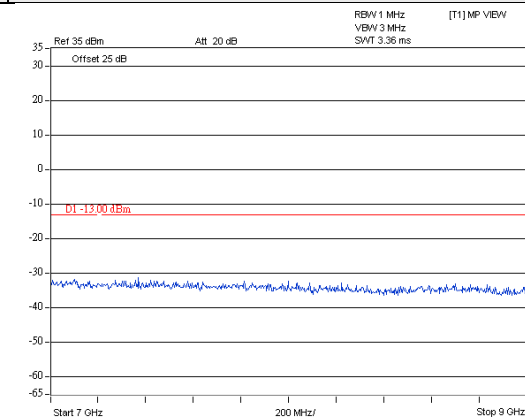
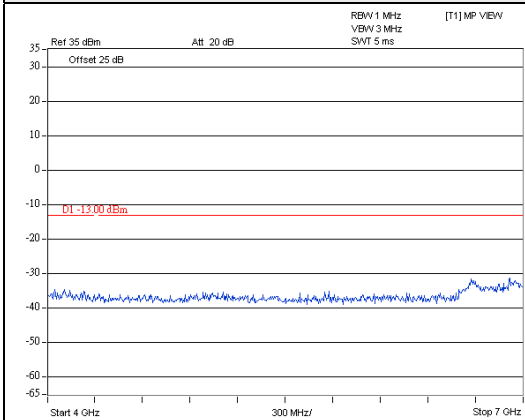

HSDPA

Channel 4233

Frequency Range : 9kHz~1GHz

Frequency Range : 1GHz~4GHz

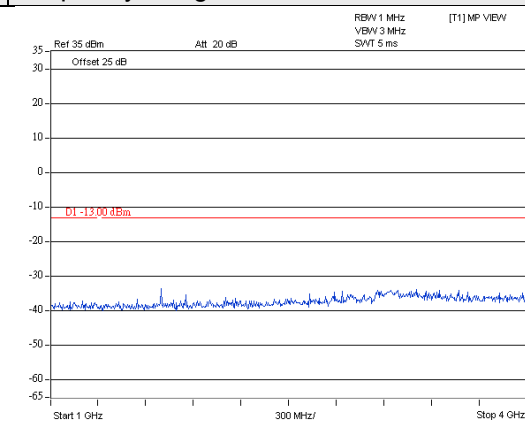
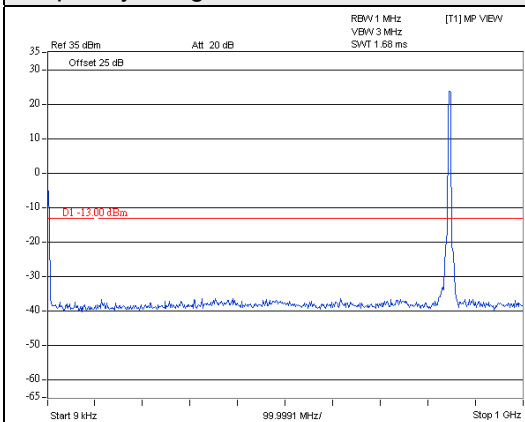

Frequency Range : 4GHz~7GHz

Frequency Range : 7GHz~9GHz

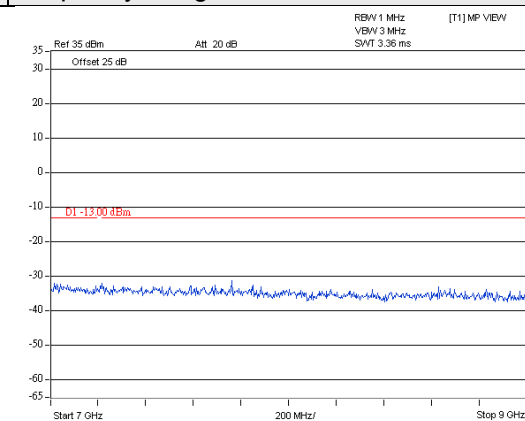
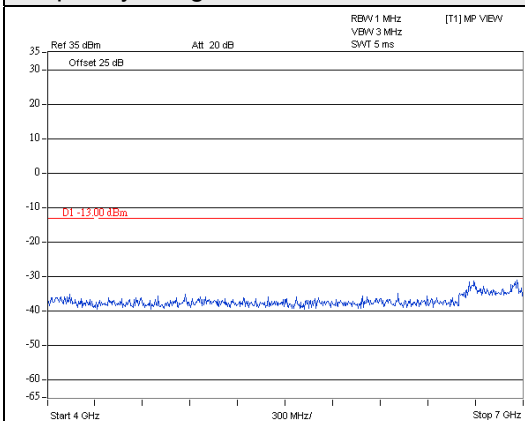

HSUPA

Channel 4132

Frequency Range : 9kHz~1GHz

Frequency Range : 1GHz~4GHz

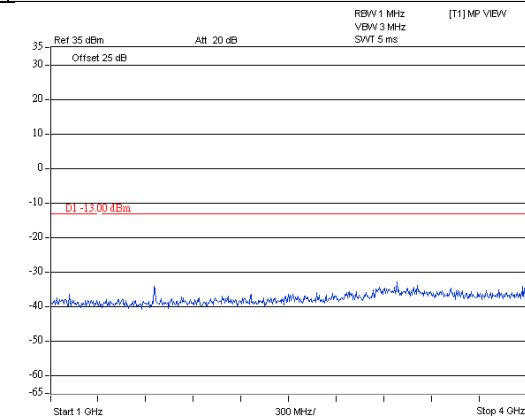
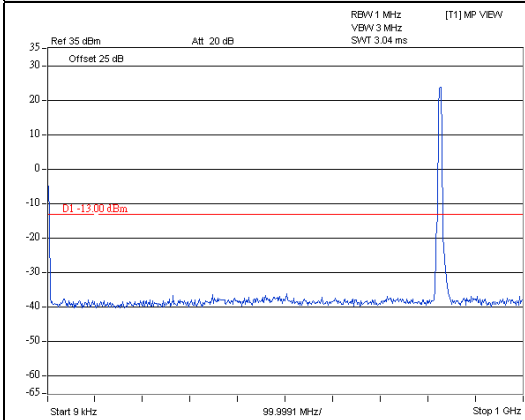

Frequency Range : 4GHz~7GHz

Frequency Range : 7GHz~9GHz

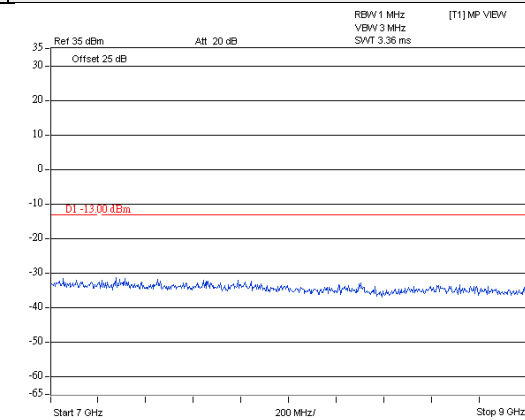
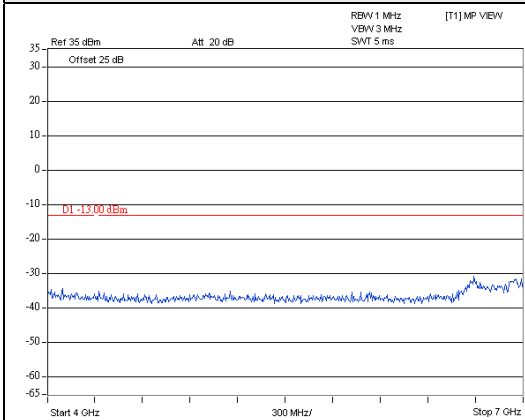

HSUPA

Channel 4182

Frequency Range : 9kHz~1GHz

Frequency Range : 1GHz~4GHz

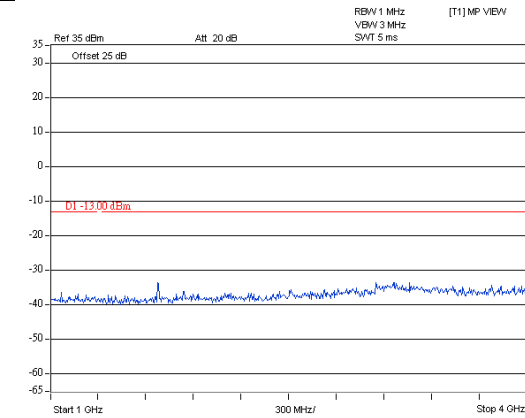
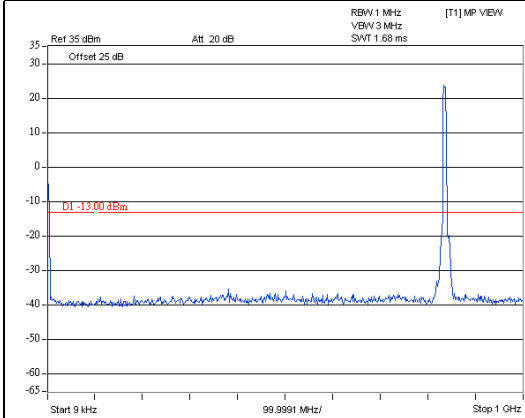

Frequency Range : 4GHz~7GHz

Frequency Range : 7GHz~9GHz

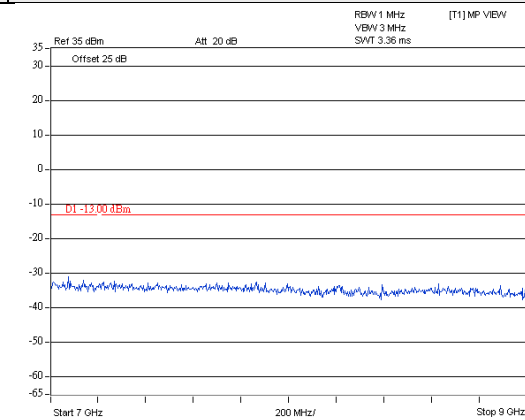
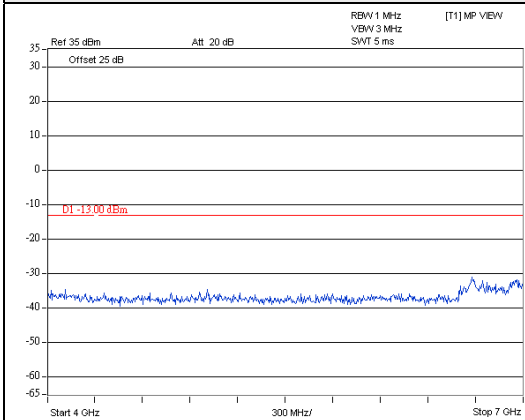

HSUPA

Channel 4233

Frequency Range : 9kHz~1GHz

Frequency Range : 1GHz~4GHz

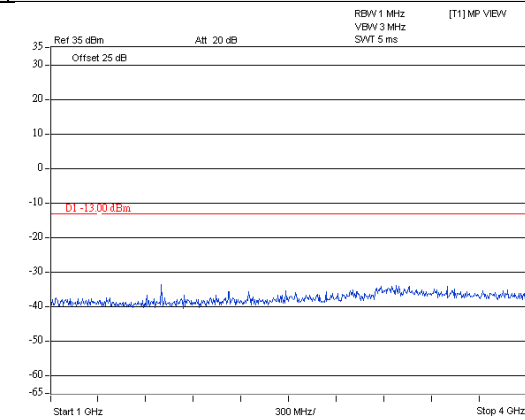
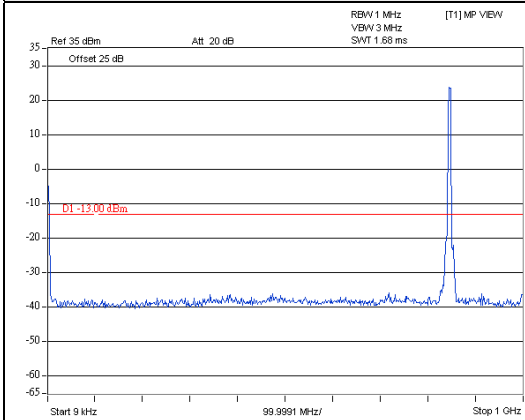

Frequency Range : 4GHz~7GHz

Frequency Range : 7GHz~9GHz

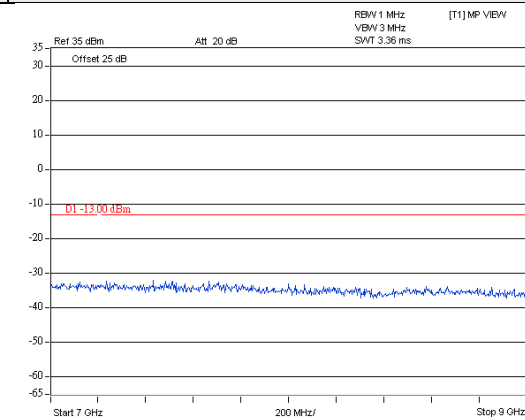
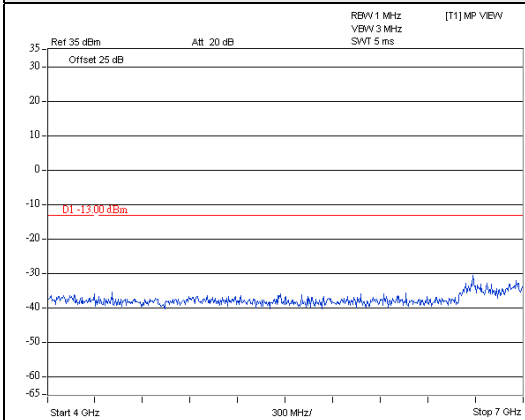

4.7 Radiated Emission Measurement

4.7.1 Limits of Radiated Emission Measurement

The power of any emission outside of the authorized operating frequency ranges must be attenuated below the transmitting power (P) by a factor of at least $43 + 10 \log(P)$ dB. The emission limit equal to -13dBm .

4.7.2 Test Procedure

- a. Substitution method is used for E.I.R.P measurement. In the semi-anechoic chamber, EUT placed on the 0.8m height of Turn Table, rotated the table around 360 degrees to search the maximum radiation power and receiver antenna shall be rotated vertical and horizontal polarization and moved height from 1m to 4m to find the maximum polar radiated power. The "Read Value" is the spectrum reading the maximum power value.
- b. The substitution horn antenna is substituted for EUT at the same position and signals generator export the CW signal to the substitution antenna via a TX cable. Rotated the Turn Table and moved receiving antenna to find the maximum radiation power. Adjust output power level of S.G to get a Value of spectrum reading equal to "Read Value" of step a. Record the power level of S.G
- c. $\text{EIRP} = \text{Output power level of S.G} - \text{TX cable loss} + \text{Antenna gain of substitution horn}$.
- d. E.R.P power can be calculated form E.I.R.P power by subtracting the gain of dipole, $\text{E.R.P power} = \text{E.I.R.P power} - 2.15\text{dBi}$.

Note: The resolution bandwidth and video bandwidth of test receiver/spectrum analyzer is 1MHz/3MHz.

4.7.3 Deviation from Test Standard

No deviation.

4.7.4 Test Setup

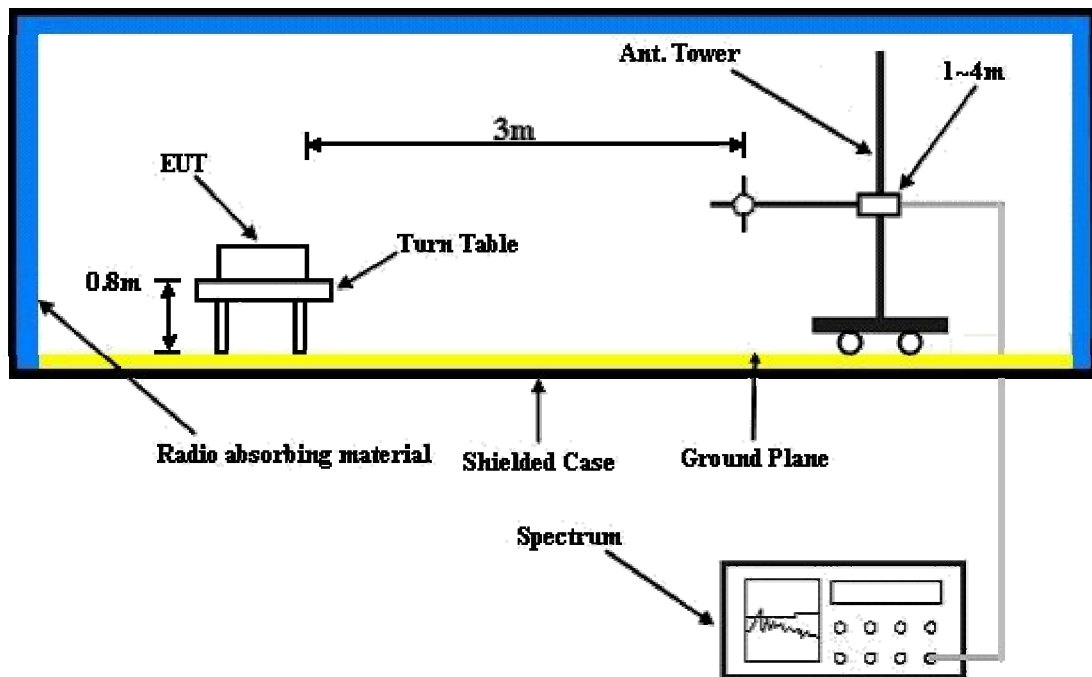

For the actual test configuration, please refer to the attached file (Test Setup Photo).

4.7.5 Test Results

Below 1GHz

Mode	TX channel 4182	Frequency Range	Below 1000 MHz
------	-----------------	-----------------	----------------

Antenna Polarity & Test Distance: Horizontal at 3 M							
No.	Freq. (MHz)	Reading (dBm)	S.G Power Value (dBm)	Correction Factor (dB)	ERP (dBm)	Limit (dBm)	Margin (dB)
1	321.58	-59.6	-60.5	5.2	-55.3	-13.0	-42.3
2	370.18	-65.8	-66.6	5.2	-61.4	-13.0	-48.4
3	568.46	-69.0	-69.3	4.5	-64.8	-13.0	-51.8
4	632.61	-67.7	-67.9	4.7	-63.2	-13.0	-50.2
5	698.70	-67.8	-68.1	5.3	-62.8	-13.0	-49.8
6	792.00	-55.8	-55.8	4.1	-51.7	-13.0	-38.7
Antenna Polarity & Test Distance: Vertical at 3 M							
No.	Freq. (MHz)	Reading (dBm)	S.G Power Value (dBm)	Correction Factor (dB)	ERP (dBm)	Limit (dBm)	Margin (dB)
1	245.77	-55.8	-56.7	5.4	-51.3	-13.0	-38.3
2	377.96	-66.2	-66.9	5.3	-61.6	-13.0	-48.6
3	566.51	-66.5	-66.8	4.5	-62.3	-13.0	-49.3
4	634.55	-64.3	-64.6	4.7	-59.9	-13.0	-46.9
5	700.64	-66.5	-66.6	5.2	-61.4	-13.0	-48.4
6	793.95	-62.5	-62.6	4.1	-58.5	-13.0	-45.5

Remarks:

1. Output Power (dBm) = S.G Value (dBm) + Correction Factor (dB).
2. Correction Factor (dB) = Substitution Antenna Gain (dB) + Cable Loss (dB).

Above 1GHz

Mode	TX channel 4132	Frequency Range	Above 1000MHz
------	-----------------	-----------------	---------------

Antenna Polarity & Test Distance: Horizontal at 3 M							
No.	Freq. (MHz)	Reading (dBm)	S.G Power Value (dBm)	Correction Factor (dB)	ERP (dBm)	Limit (dBm)	Margin (dB)
1	1652.80	-61.5	-65.0	5.5	-59.5	-13.0	-46.5
2	2509.20	-64.8	-64.9	6.4	-58.5	-13.0	-45.5
Antenna Polarity & Test Distance: Vertical at 3 M							
No.	Freq. (MHz)	Reading (dBm)	S.G Power Value (dBm)	Correction Factor (dB)	ERP (dBm)	Limit (dBm)	Margin (dB)
1	1652.80	-61.0	-63.0	5.5	-57.5	-13.0	-44.5
2	2509.20	-64.5	-63.6	6.4	-57.2	-13.0	-44.2

Remarks:

1. Output Power (dBm) = S.G Value (dBm) + Correction Factor (dB).
2. Correction Factor (dB) = Substitution Antenna Gain (dB) + Cable Loss (dB).

Mode	TX channel 4182	Frequency Range	Above 1000MHz
------	-----------------	-----------------	---------------

Antenna Polarity & Test Distance: Horizontal at 3 M							
No.	Freq. (MHz)	Reading (dBm)	S.G Power Value (dBm)	Correction Factor (dB)	ERP (dBm)	Limit (dBm)	Margin (dB)
1	1672.80	-61.8	-65.0	5.5	-59.5	-13.0	-46.5
2	2509.20	-64.8	-64.9	6.4	-58.5	-13.0	-45.5
Antenna Polarity & Test Distance: Vertical at 3 M							
No.	Freq. (MHz)	Reading (dBm)	S.G Power Value (dBm)	Correction Factor (dB)	ERP (dBm)	Limit (dBm)	Margin (dB)
1	1672.80	-52.0	-54.0	5.5	-48.5	-13.0	-35.5
2	2509.20	-64.5	-63.7	6.4	-57.3	-13.0	-44.3

Remarks:

1. Output Power (dBm) = S.G Value (dBm) + Correction Factor (dB).
2. Correction Factor (dB) = Substitution Antenna Gain (dB) + Cable Loss (dB).

Mode	TX channel 4233	Frequency Range	Above 1000MHz
------	-----------------	-----------------	---------------

Antenna Polarity & Test Distance: Horizontal at 3 M							
No.	Freq. (MHz)	Reading (dBm)	S.G Power Value (dBm)	Correction Factor (dB)	ERP (dBm)	Limit (dBm)	Margin (dB)
1	1693.20	-61.6	-64.7	5.6	-59.1	-13.0	-46.1
2	2539.80	-64.0	-64.2	6.4	-57.8	-13.0	-44.8
Antenna Polarity & Test Distance: Vertical at 3 M							
No.	Freq. (MHz)	Reading (dBm)	S.G Power Value (dBm)	Correction Factor (dB)	ERP (dBm)	Limit (dBm)	Margin (dB)
1	1693.20	-62.5	-64.5	5.6	-58.9	-13.0	-45.9
2	2539.80	-70.5	-69.4	6.4	-63.0	-13.0	-50.0

Remarks:

1. Output Power (dBm) = S.G Value (dBm) + Correction Factor (dB).
2. Correction Factor (dB) = Substitution Antenna Gain (dB) + Cable Loss (dB).

5 Pictures of Test Arrangements

Please refer to the attached file (Test Setup Photo).

Appendix – Information on the Testing Laboratories

We, Bureau Veritas Consumer Products Services (H.K.) Ltd., Taoyuan Branch, were founded in 1988 to provide our best service in EMC, Radio, Telecom and Safety consultation. Our laboratories are accredited and approved according to ISO/IEC 17025.

If you have any comments, please feel free to contact us at the following:

Linko EMC/RF Lab

Tel: 886-2-26052180

Fax: 886-2-26051924

Hsin Chu EMC/RF/Telecom Lab

Tel: 886-3-6668565

Fax: 886-3-6668323

Hwa Ya EMC/RF/Safety

Tel: 886-3-3183232

Fax: 886-3-3270892

Email: service.adt@tw.bureauveritas.com

Web Site: www.bureauveritas-adt.com

The address and road map of all our labs can be found in our web site also.

--- END ---