



FCC RF Test Report

APPLICANT : Quanta Computer Inc.
EQUIPMENT : Clover Mobile WiFi
BRAND NAME : Clover
MODEL NAME : C200
FCC ID : HFS-C200
STANDARD : FCC Part 15 Subpart C §15.247
CLASSIFICATION : (DTS) Digital Transmission System

The product was received on Oct. 25, 2014 and testing was completed on Dec. 26, 2014. We, SPORTON INTERNATIONAL INC., would like to declare that the tested sample has been evaluated in accordance with the test procedures and has been in compliance with the applicable technical standards.

The test results in this report apply exclusively to the tested model / sample. Without written approval of SPORTON INTERNATIONAL INC., the test report shall not be reproduced except in full.

Reviewed by: Joseph Lin / Supervisor

Approved by: Jones Tsai / Manager



SPORTON INTERNATIONAL INC.

No. 52, Hwa Ya 1st Rd., Hwa Ya Technology Park, Kwei-Shan District, Tao Yuan City, Taiwan, R.O.C.



TABLE OF CONTENTS

REVISION HISTORY 3

SUMMARY OF TEST RESULT 4

1 GENERAL DESCRIPTION 5

 1.1 Applicant 5

 1.2 Manufacturer 5

 1.3 Product Feature of Equipment Under Test 5

 1.4 Product Specification subjective to this standard 6

 1.5 Modification of EUT 6

 1.6 Testing Location 7

 1.7 Applicable Standards 7

2 TEST CONFIGURATION OF EQUIPMENT UNDER TEST 8

 2.1 Carrier Frequency and Channel 8

 2.2 Pre-Scanned RF Power 9

 2.3 Test Mode 10

 2.4 Connection Diagram of Test System 11

 2.5 Support Unit used in test configuration and system 12

 2.6 EUT Operation Test Setup 12

 2.7 Measurement Results Explanation Example 12

3 TEST RESULT 13

 3.1 6dB and 99% Bandwidth Measurement 13

 3.2 Peak Output Power Measurement 15

 3.3 Power Spectral Density Measurement 17

 3.4 Conducted Band Edges and Spurious Emission Measurement 19

 3.5 Radiated Band Edges and Spurious Emission Measurement 32

 3.6 AC Conducted Emission Measurement 36

 3.7 Antenna Requirements 40

4 LIST OF MEASURING EQUIPMENT 42

5 UNCERTAINTY OF EVALUATION 43

APPENDIX A. CONDUCTED TEST RESULTS

APPENDIX B. RADIATED TEST RESULTS

APPENDIX C. SETUP PHOTOGRAPHS



REVISION HISTORY

REPORT NO.	VERSION	DESCRIPTION	ISSUED DATE
FR4O2508C	Rev. 01	Initial issue of report	Jan. 27, 2015



SUMMARY OF TEST RESULT

Report Section	FCC Rule	IC Rule	Description	Limit	Result	Remark
3.1	15.247(a)(2)	RSS-210 A8.2(a)	6dB Bandwidth	$\geq 0.5\text{MHz}$	Pass	-
3.1	-	RSS-Gen 4.6.1	99% Bandwidth	-	Pass	-
3.2	15.247(b)	RSS-210 A8.4	Power Output Measurement	$\leq 30\text{dBm}$	Pass	-
3.3	15.247(e)	RSS-210 A8.2(b)	Power Spectral Density	$\leq 8\text{dBm}/3\text{kHz}$	Pass	-
3.4	15.247(d)	RSS-210 A8.5	Conducted Band Edges	$\leq 20\text{dBc}$	Pass	-
			Conducted Spurious Emission		Pass	-
3.5	15.247(d)	RSS-210 A8.5	Radiated Band Edges and Radiated Spurious Emission	15.209(a) & 15.247(d)	Pass	Under limit 0.04 dB at 2389.830 MHz
3.6	15.207	RSS-Gen 7.2.4	AC Conducted Emission	15.207(a)	Pass	Under limit 13.20 dB at 0.582 MHz
3.7	15.203 & 15.247(b)	RSS-210 A8.4	Antenna Requirement	N/A	Pass	-



1 General Description

1.1 Applicant

Quanta Computer Inc.

No.188, Wenhua 2nd Rd., Guishan Dist., Taoyuan City 33377, Taiwan

1.2 Manufacturer

Quanta Computer Inc.

No.188, Wenhua 2nd Rd., Guishan Dist., Taoyuan City 33377, Taiwan

1.3 Product Feature of Equipment Under Test

Product Feature	
Equipment	Clover Mobile WiFi
Brand Name	Clover
Model Name	C200
FCC ID	HFS-C200
EUT supports Radios application	NFC WLAN 11b/g/n HT20 WLAN 11a/n HT20/HT40 Bluetooth v4.0 EDR/LE
EUT Stage	Identical Prototype

Remark: The above EUT's information was declared by manufacturer. Please refer to the specifications or user's manual for more detailed description.

Accessory List	
AC Adapter 1	Brand Name: Clover
	Model Name: WB-10G05FU
AC Adapter 2	Brand Name: Clover
	Model Name: WB-10G05R
USB Cable	Brand Name: Golden Bridge Electech Inc.
	Model Name: AA002GB-B0308BX
Battery	Brand Name: CELXPART ENERGY CORPORATION
	Model Name: CQT-1401



1.4 Product Specification subjective to this standard

Product Specification subjective to this standard																
Tx/Rx Channel Frequency Range	802.11b/g/n : 2412 MHz ~ 2462 MHz															
Maximum (Peak) Output Power to antenna	<p><Ant. 1> 802.11b : 19.27 dBm (0.0845 W) 802.11g : 23.07 dBm (0.2028 W)</p> <p><Ant. 2> 802.11b : 18.88 dBm (0.0773 W) 802.11g : 22.78 dBm (0.1897 W)</p> <p>SISO <Ant. 1> 802.11n HT20 : 22.59 dBm (0.1816 W)</p> <p>SISO <Ant. 2> 802.11n HT20 : 22.36 dBm (0.1722 W)</p> <p>MIMO <Ant. 1+2> 802.11n HT20 : 25.33 dBm (0.3412 W)</p>															
99% Occupied Bandwidth	802.11b : 11.60MHz 802.11g : 17.25MHz 802.11n HT20 : 18.10MHz															
Antenna Type	<p><Ant 1> 802.11b/g/n : PIFA Antenna type with gain -2.84 dBi</p> <p><Ant 2> 802.11b/g/n : PIFA Antenna type with gain -3.79 dBi</p>															
Type of Modulation	802.11b : DSSS (DBPSK / DQPSK / CCK) 802.11g/n : OFDM (BPSK / QPSK / 16QAM / 64QAM)															
Antenna Function for Transmitter	<table border="1"> <thead> <tr> <th></th> <th>Ant. 1</th> <th>Ant. 2</th> </tr> </thead> <tbody> <tr> <td>802.11 b</td> <td>V</td> <td>-</td> </tr> <tr> <td>802.11 g</td> <td>V</td> <td>-</td> </tr> <tr> <td>802.11 n SISO</td> <td>V</td> <td>V</td> </tr> <tr> <td>802.11 n MIMO</td> <td>V</td> <td>V</td> </tr> </tbody> </table>		Ant. 1	Ant. 2	802.11 b	V	-	802.11 g	V	-	802.11 n SISO	V	V	802.11 n MIMO	V	V
	Ant. 1	Ant. 2														
802.11 b	V	-														
802.11 g	V	-														
802.11 n SISO	V	V														
802.11 n MIMO	V	V														

1.5 Modification of EUT

No modifications are made to the EUT during all test items.



1.6 Testing Location

Sporton Lab is accredited to ISO 17025 by Taiwan Accreditation Foundation (TAF code : 1190) and the FCC designation No. TW1022 under the FCC 2.948(e) by Mutual Recognition Agreement (MRA) in FCC Test.

Test Site	SPORTON INTERNATIONAL INC.		
Test Site Location	No. 52, Hwa Ya 1st Rd., Hwa Ya Technology Park, Kwei-Shan District, Tao Yuan City, Taiwan, R.O.C. TEL: +886-3-327-3456 FAX: +886-3-328-4978		
Test Site No.	Sporton Site No.		
	TH02-HY	CO05-HY	03CH07-HY

Note: The test site complies with ANSI C63.4 2009 requirement.

1.7 Applicable Standards

According to the specifications of the manufacturer, the EUT must comply with the requirements of the following standards:

- ♦ FCC Part 15 Subpart C §15.247
- ♦ FCC KDB Publication No. 558074 D01 DTS Meas. Guidance v03r02
- ♦ FCC KDB 662911 D01 Multiple Transmitter Output v02r01.
- ♦ ANSI C63.10-2013

Remark:

1. All test items were verified and recorded according to the standards and without any deviation during the test.
2. FCC permits the use of the 1.5 meter table for frequency above 1GHz as an alternative in C63.10-2013 through inquiry tracking number 961829.
3. This EUT has also been tested and complied with the requirements of FCC Part 15, Subpart B, recorded in a separate test report.



2 Test Configuration of Equipment Under Test

The EUT has been associated with peripherals and configuration operated in a manner tended to maximize its emission characteristics in a typical application. Frequency range investigated: conducted emission (150 kHz to 30 MHz) and radiated emission (9 kHz to the 10th harmonic of the highest fundamental frequency or to 40 GHz, whichever is lower). For radiated measurement, pre-scanned in three orthogonal panels, X, Y, Z. The worst cases (Z plane) were recorded in this report.

The final configuration from all the combinations and the worst-case data rates were investigated by measuring the maximum power across all the data rates and modulation modes under section 2.2.

Based on the worst configuration found above, the RF power setting is set individually to meet FCC compliance limit for the final conducted and radiated tests shown in section 2.3.

2.1 Carrier Frequency and Channel

Frequency Band	Channel	Freq. (MHz)	Channel	Freq. (MHz)
2400-2483.5 MHz	1	2412	7	2442
	2	2417	8	2447
	3	2422	9	2452
	4	2427	10	2457
	5	2432	11	2462
	6	2437		



2.2 Pre-Scanned RF Power

Preliminary tests were performed in different data rate and data rate associated with the highest power were chosen for full test shown in the following tables.

<Ant. 1>

802.11b				
Data Rate (MHz)	1M bps	2M bps	5.5M bps	11M bps
Peak Power (dBm)	19.27	19.21	19.24	19.26

802.11g								
Data Rate (MHz)	6M bps	9M bps	12M bps	18M bps	24M bps	36M bps	48M bps	54M bps
Peak Power (dBm)	23.07	23.01	22.89	22.85	22.78	22.83	22.85	22.89

<Ant. 2>

802.11b				
Data Rate (MHz)	1M bps	2M bps	5.5M bps	11M bps
Peak Power (dBm)	18.88	18.76	18.79	18.75

802.11g								
Data Rate (MHz)	6M bps	9M bps	12M bps	18M bps	24M bps	36M bps	48M bps	54M bps
Peak Power (dBm)	22.78	22.69	22.60	22.58	22.61	22.53	22.52	22.71

SISO <Ant. 1>

2.4GHz 802.11n HT20								
Data Rate (MHz)	MCS0	MCS1	MCS2	MCS3	MCS4	MCS5	MCS6	MCS7
Peak Power (dBm)	22.59	22.50	22.39	22.41	22.39	22.47	22.50	22.52

SISO <Ant. 1>

2.4GHz 802.11n HT20								
Data Rate (MHz)	MCS0	MCS1	MCS2	MCS3	MCS4	MCS5	MCS6	MCS7
Peak Power (dBm)	22.36	22.01	22.01	22.11	22.10	22.01	22.02	22.11

MIMO <Ant. 1+2>

2.4GHz 802.11n HT20								
Data Rate (MHz)	MCS8	MCS9	MCS10	MCS11	MCS12	MCS13	MCS14	MCS15
Peak Power (dBm)	25.33	25.07	25.13	25.10	25.15	25.20	25.19	25.09

Note: MIMO Ant. 1+2 is a calculated result from sum of the power MIMO Ant. 1 and MIMO Ant. 2.



2.3 Test Mode

Final test mode of conducted test items and radiated spurious emissions are considering the modulation and worse data rates from the power table described in section 2.2.

Single Antenna

<2.4GHz>

Modulation	Data Rate
802.11b	1 Mbps
802.11g	6 Mbps
802.11n HT20	MCS0

MIMO Antenna

<2.4GHz>

Modulation	Data Rate
802.11n HT20	MCS8

Test Cases	
AC Conducted Emission	Mode 1 : Bluetooth Link + WLAN (2.4GHz) Link + Camera (Back) + Earphone + USB Cable (Charging from Adapter) + TF
Remark:	TF stands for Test Fuction, and consists of Barcode Scan, Magnetic Stripe Card Read, Chipcard Read, and NFC Card Read.

2.4 Connection Diagram of Test System

<WLAN Tx Mode>

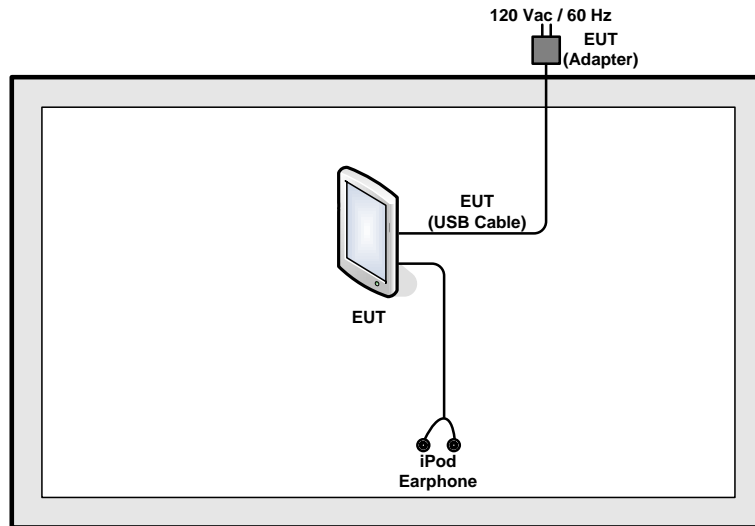

<AC Conducted Emission Mode>

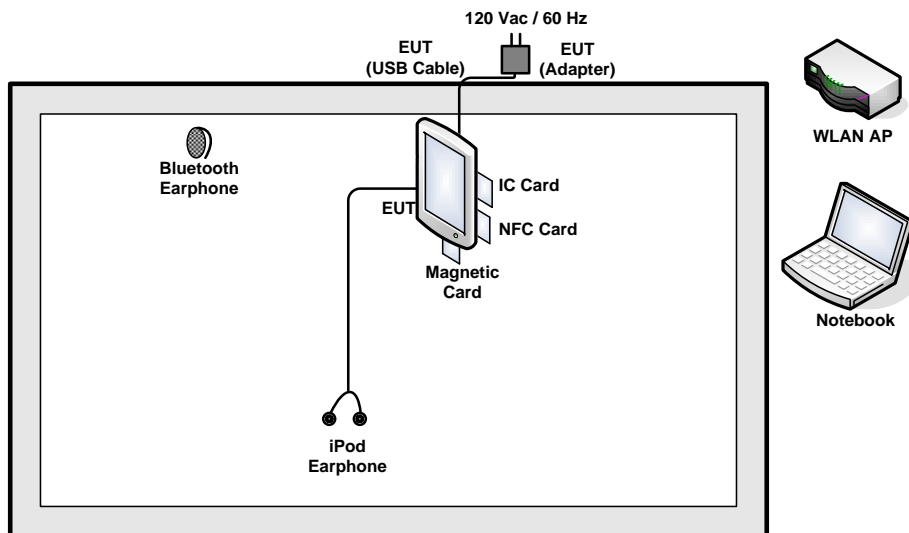



2.5 Support Unit used in test configuration and system

Item	Equipment	Trade Name	Model Name	FCC ID	Data Cable	Power Cord
1.	WLAN AP	D-Link	DIR-628	KA2DIR628A2	N/A	Unshielded, 1.8 m
2.	Notebook	DELL	Latitude E6320	FCC DoC/ Contains FCC ID: QDS-BRCM1054	N/A	AC I/P: Unshielded, 1.2 m DC O/P: Shielded, 1.8 m
3.	Bluetooth Earphone	Sony Ericsson	MW600	PY7DDA-2029	N/A	N/A
4.	iPod Earphone	Apple	N/A	Verification	Unshielded, 1.0 m	N/A
5.	IC Card	N/A	N/A	N/A	N/A	N/A
6.	Magnetic Card	N/A	N/A	N/A	N/A	N/A
7.	NFC Card	N/A	N/A	N/A	N/A	N/A

2.6 EUT Operation Test Setup

For WLAN RF test items, an engineering test program was provided and enabled to make EUT continuous transmit/receive.

2.7 Measurement Results Explanation Example

For all conducted test items:

The offset level is set in the spectrum analyzer to compensate the RF cable loss and attenuator factor between EUT conducted output port and spectrum analyzer. With the offset compensation, the spectrum analyzer reading level is exactly the EUT RF output level.

Example:

The spectrum analyzer offset is derived from RF cable loss and attenuator factor.

$$\text{Offset} = \text{RF cable loss} + \text{attenuator factor}.$$

Following shows an offset computation example with cable loss 4.2 dB and 10dB attenuator.

$$\begin{aligned} \text{Offset}(dB) &= \text{RF cable loss}(dB) + \text{attenuator factor}(dB). \\ &= 4.2 + 10 = 14.2 \text{ (dB)} \end{aligned}$$

3 Test Result

3.1 6dB and 99% Bandwidth Measurement

3.1.1 Limit of 6dB and 99% Bandwidth

The minimum 6 dB bandwidth shall be at least 500 kHz.

3.1.2 Measuring Instruments

The measuring equipment is listed in the section 4 of this test report.

3.1.3 Test Procedures

1. The testing follows FCC KDB Publication No. 558074 DTS D01 Meas. Guidance v03r02.
2. The RF output of EUT was connected to the spectrum analyzer by RF cable and attenuator. The path loss was compensated to the results for each measurement.
3. Set to the maximum power setting and enable the EUT transmit continuously.
4. Make the measurement with the spectrum analyzer's resolution bandwidth (RBW) = 100 kHz. Set the Video bandwidth (VBW) = 300 kHz. In order to make an accurate measurement. The 6 dB bandwidth must be greater than 500 kHz.
5. For 99% Bandwidth Measurement, the spectrum analyzer's resolution bandwidth (RBW) = 1MHz and set the Video bandwidth (VBW) = 3MHz.
6. Measure and record the results in the test report.

3.1.4 Test Setup





3.1.5 Test Result of 6dB and 99% Occupied Bandwidth

Please refer to Appendix A of this test report.

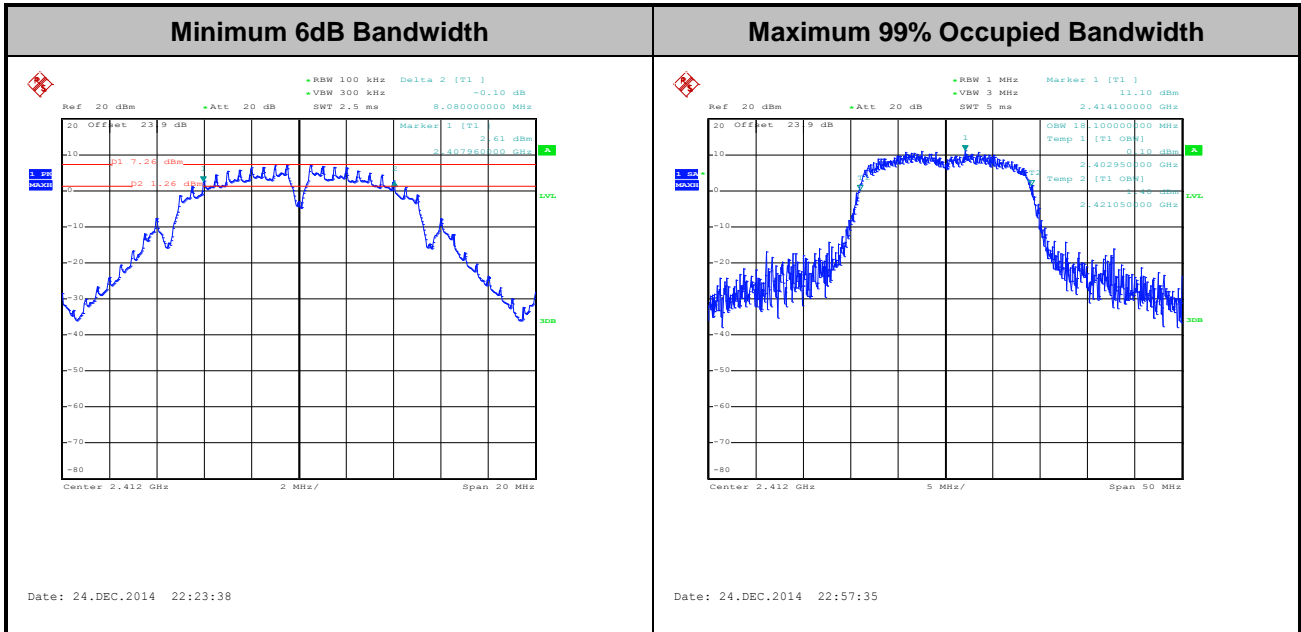

Note : The occupied channel bandwidth is maintained within the band of operation for all of the modulations.

3.2 Peak Output Power Measurement

3.2.1 Limit of Peak Output Power

For systems using digital modulation in the 2400-2483.5MHz, the limit for peak output power is 30dBm. If transmitting antenna with directional gain greater than 6dBi is used, the peak output power from the intentional radiator shall be reduced below the above stated value by the amount in dB that the directional gain of the antenna exceeds 6 dBi. In case of point-to-point operation, the limit has to be reduced by 1dB for every 3dB that the directional gain of the antenna exceeds 6dBi.

3.2.2 Measuring Instruments

The measuring equipment is listed in the section 4 of this test report.

3.2.3 Test Procedures

1. The testing follows the Measurement Procedure of FCC KDB No. 558074 DTS D01 Meas. Guidance v03r02.
2. The RF output of EUT was connected to the power meter by RF cable and attenuator. The path loss was compensated to the results for each measurement.
3. Set to the maximum power setting and enable the EUT transmit continuously.
4. Measure the conducted output power and record the results in the test report.
5. For MIMO mode, calculation method follows FCC KDB 662911 D01 Multiple Transmitter Output v02r01.

3.2.4 Test Setup

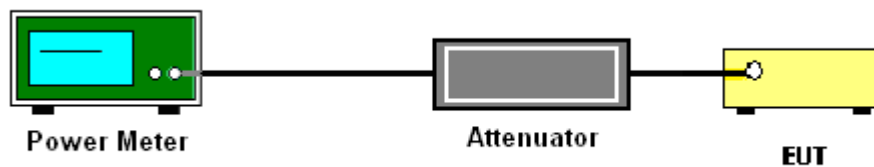



3.2.5 Test Result of Peak Output Power

Please refer to Appendix A of this test report.

3.2.6 Test Result of Average output Power (Reporting Only)

Please refer to Appendix A of this test report.



3.3 Power Spectral Density Measurement

3.3.1 Limit of Power Spectral Density

The peak power spectral density shall not be greater than 8dBm in any 3kHz band at any time interval of continuous transmission.

3.3.2 Measuring Instruments

The measuring equipment is listed in the section 4 of this test report.

3.3.3 Test Procedures

1. The testing follows Measurement Procedure 10.2 Method PKPSD of FCC KDB Publication No. 558074 D01 DTS Meas. Guidance v03r02
2. The RF output of EUT was connected to the spectrum analyzer by RF cable and attenuator. The path loss was compensated to the results for each measurement.
3. Set to the maximum power setting and enable the EUT transmit continuously.
4. Make the measurement with the spectrum analyzer's resolution bandwidth (RBW) = 3 kHz. Video bandwidth VBW = 10 kHz In order to make an accurate measurement, set the span to 1.5 times DTS Channel Bandwidth. (6dB BW)
5. Detector = peak, Sweep time = auto couple, Trace mode = max hold, Allow trace to fully stabilize. Use the peak marker function to determine the maximum power level.
6. Measure and record the results in the test report.
7. For MIMO mode, calculation method follows FCC KDB 662911 D01 Multiple Transmitter Output v02r01.

If measurements performed using method (2) plus $10 \log(N)$ exceeds the emission limit, the test should choose method (1) before declaring that the device fails the emission limit.

Method (1): Measure and sum the spectra across the outputs.

The total final Power Spectral Density is from a device with 2 transmitter outputs. The spectrum measurements of the individual outputs are all performed with the same span and number of points, the spectrum value in the first spectral bin of output 1 is summed with that in the first spectral bin of output 2 to obtain the value for the first frequency bin of the summed spectrum.

Method (2): Measure and add $10 \log(N)$ dB, where N is the number of outputs. (N=2)

3.3.4 Test Setup

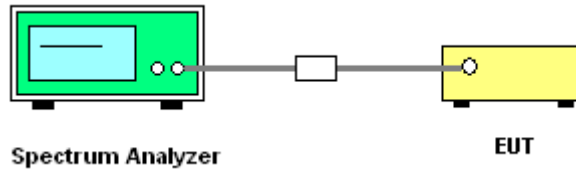

3.3.5 Test Result of Power Spectral Density

Please refer to Appendix A of this test report.

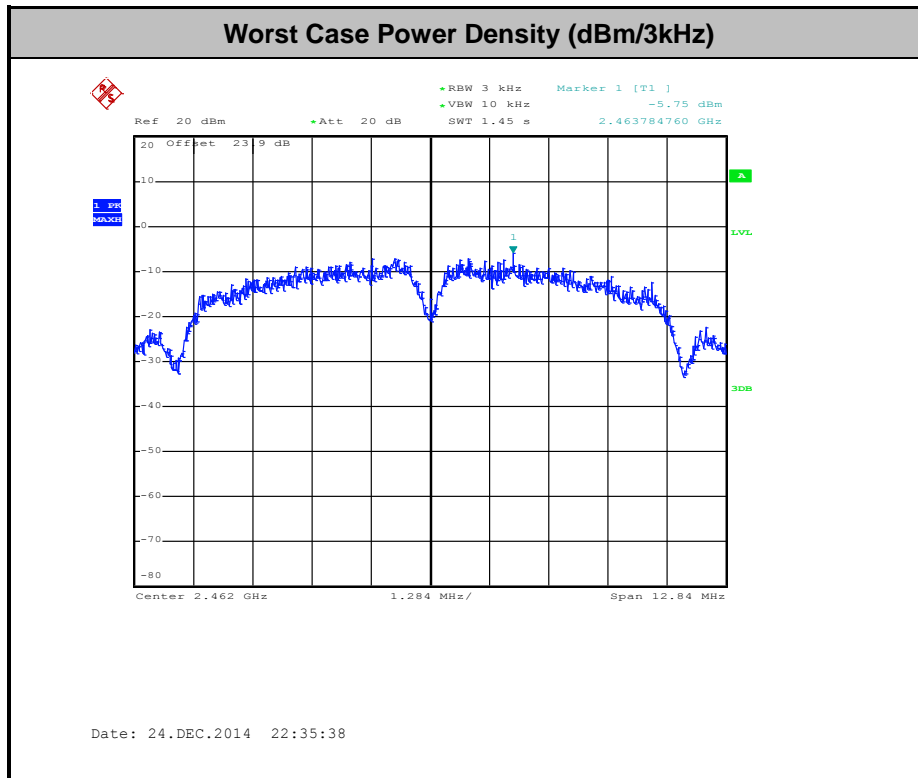

3.4 Conducted Band Edges and Spurious Emission Measurement

3.4.1 Limit of Conducted Band Edges and Spurious Emission Measurement

In any 100 kHz bandwidth outside of the authorized frequency band, the emissions which fall in the non-restricted bands shall be attenuated at least 20 dB / 30dB relative to the maximum PSD level in 100 kHz by RF conducted measurement and radiated emissions which fall in the restricted bands, as defined in Section 15.205(a), must also comply with the radiated emission limits specified in Section 15.209(a).

3.4.2 Measuring Instruments

The measuring equipment is listed in the section 4 of this test report.

3.4.3 Test Procedures

1. The testing follows FCC KDB Publication No. 558074 D01 DTS Meas. Guidance v03r02.
2. The RF output of EUT was connected to the spectrum analyzer by RF cable and attenuator. The path loss was compensated to the results for each measurement.
3. Set to the maximum power setting and enable the EUT transmit continuously.
4. Set RBW = 100 kHz, VBW=300 kHz, Peak Detector. Unwanted Emissions measured in any 100 kHz bandwidth outside of the authorized frequency band shall be attenuated by at least 20 dB relative to the maximum in-band peak PSD level in 100 kHz when maximum peak conducted output power procedure is used. If the transmitter complies with the conducted power limits based on the use of RMS averaging over a time interval, the attenuation required under this paragraph shall be 30 dB instead of 20 dB per 15.247(d).
5. Measure and record the results in the test report.
6. The RF fundamental frequency should be excluded against the limit line in the operating frequency band.

3.4.4 Test Setup

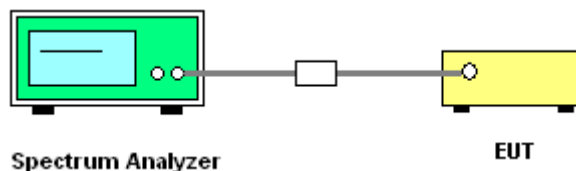



3.4.5 Test Result of Conducted Band Edges and Spurious Emission

Number of TX = 1, Ant. 1 (Measured)

Number of TX	1	Ant. :	1
Test Mode :	802.11b	Temperature :	21~25°C
Test Band :	2.4GHz Low	Relative Humidity :	51~54%
Test Channel :	01	Test Engineer :	Bill Kuo and AC Chang

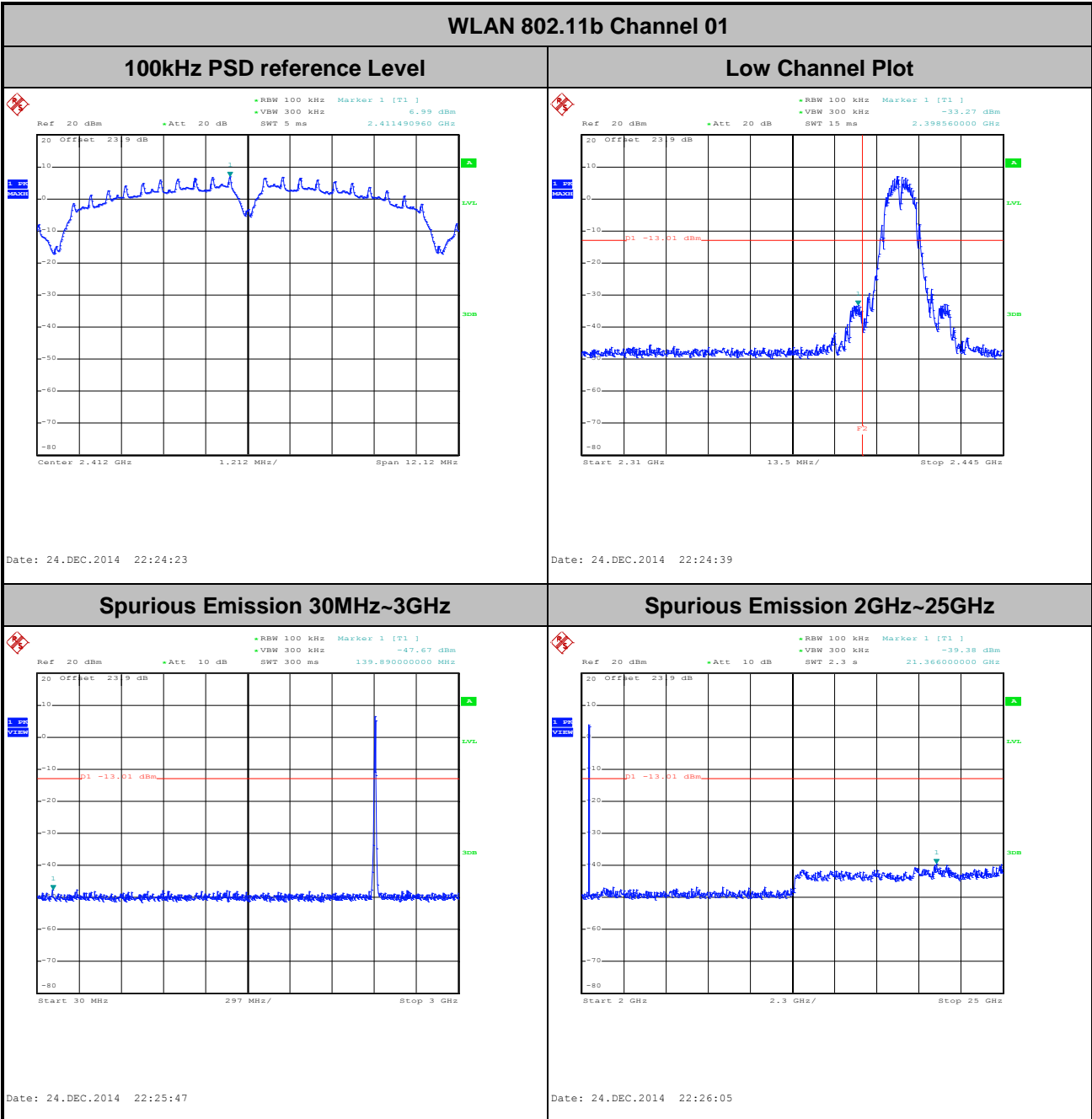



Number of TX :	1	Ant. :	1
Test Mode :	802.11b	Temperature :	21~25°C
Test Band :	2.4GHz Mid	Relative Humidity :	51~54%
Test Channel :	06	Test Engineer :	Bill Kuo and AC Chang

WLAN 802.11b Channel 06

100kHz PSD reference Level

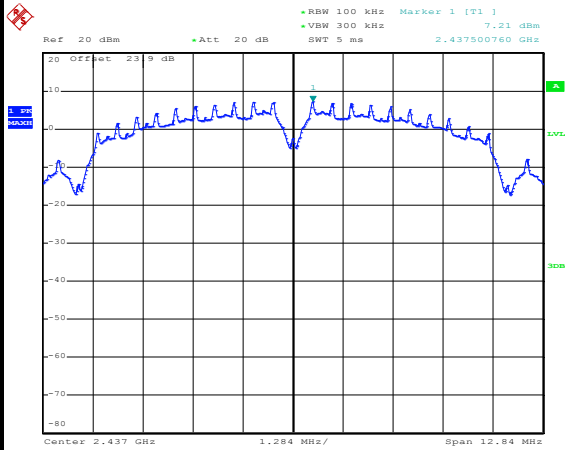

Date: 24.DEC.2014 22:32:50

Spurious Emission 30MHz~3GHz

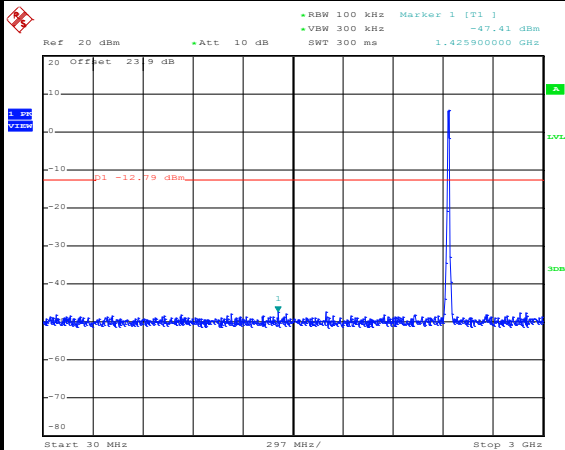

Date: 24.DEC.2014 22:33:21

Spurious Emission 2GHz~25GHz

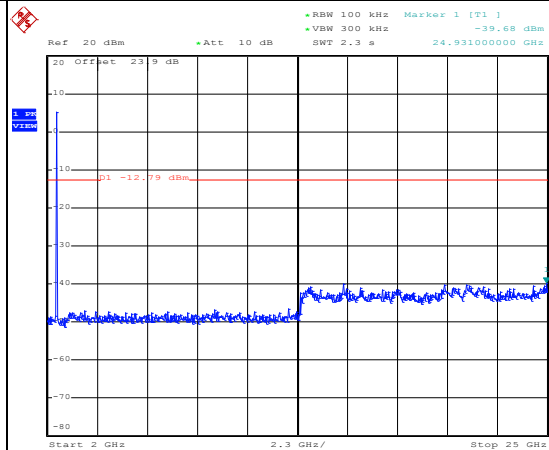

Date: 24.DEC.2014 22:33:39



Number of TX :	1	Ant. :	1
Test Mode :	802.11b	Temperature :	21~25°C
Test Band :	2.4GHz High	Relative Humidity :	51~54%
Test Channel :	11	Test Engineer :	Bill Kuo and AC Chang

WLAN 802.11b Channel 11

100kHz PSD reference Level

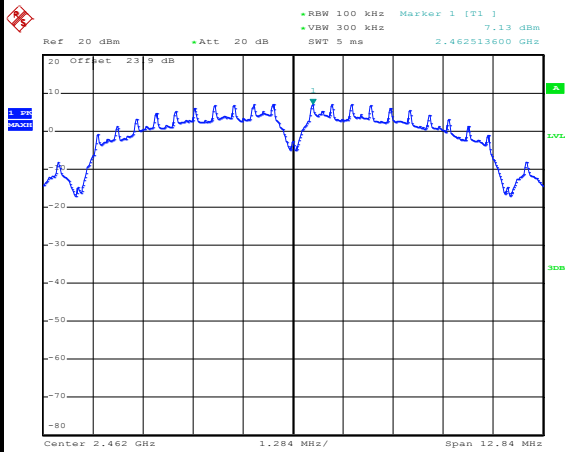

Date: 24.DEC.2014 22:36:05

High Channel Plot

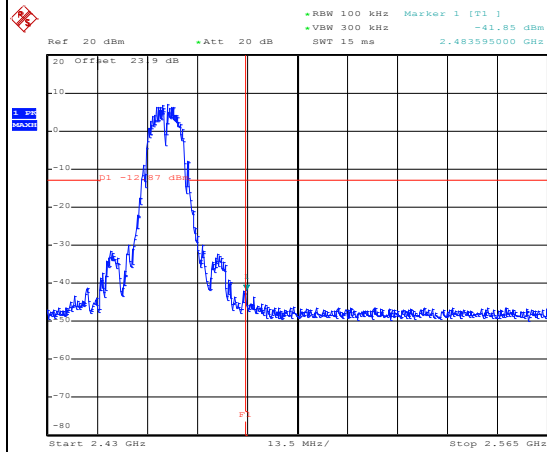

Date: 24.DEC.2014 23:35:54

Spurious Emission 30MHz~3GHz

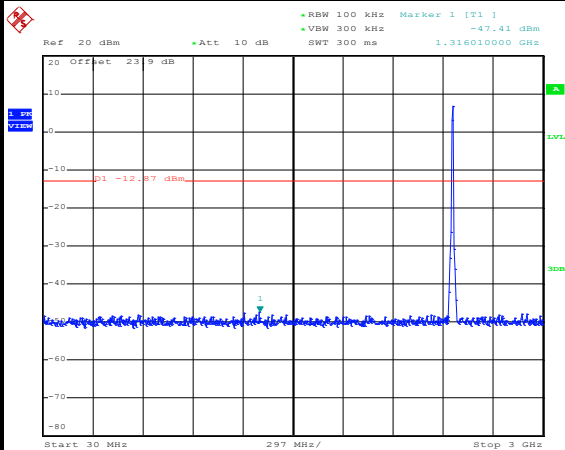

Date: 24.DEC.2014 22:38:50

Spurious Emission 2GHz~25GHz

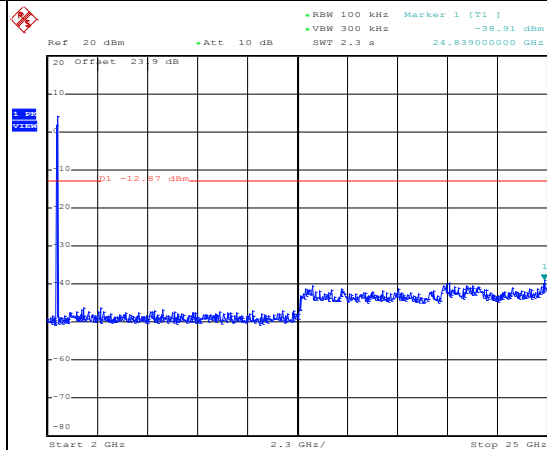

Date: 24.DEC.2014 22:39:08



Number of TX :	1	Ant. :	1
Test Mode :	802.11g	Temperature :	21~25°C
Test Band :	2.4GHz Low	Relative Humidity :	51~54%
Test Channel :	01	Test Engineer :	Bill Kuo and AC Chang

WLAN 802.11g Channel 01

100kHz PSD reference Level

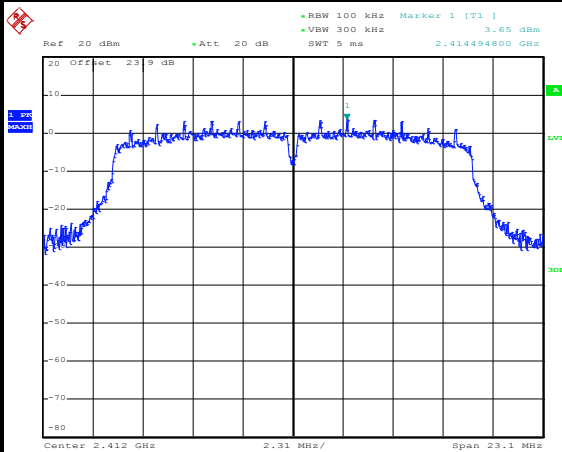

Date: 24.DEC.2014 22:52:21

Low Channel Plot

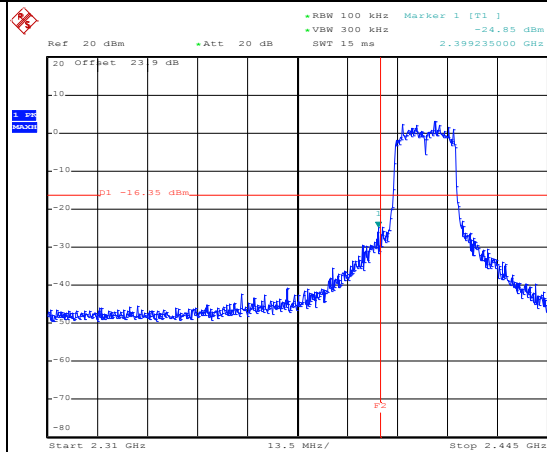

Date: 24.DEC.2014 22:52:43

Spurious Emission 30MHz~3GHz

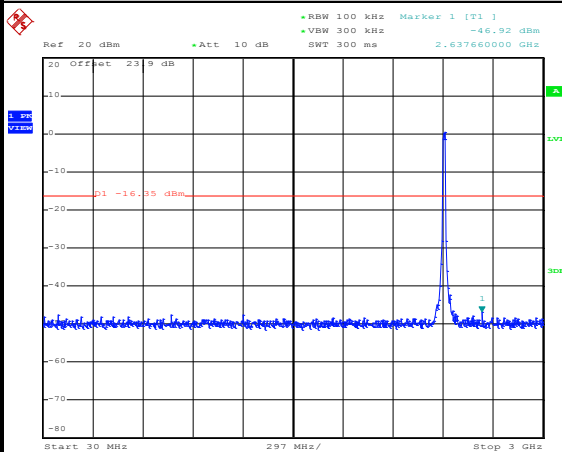

Date: 24.DEC.2014 22:53:08

Spurious Emission 2GHz~25GHz

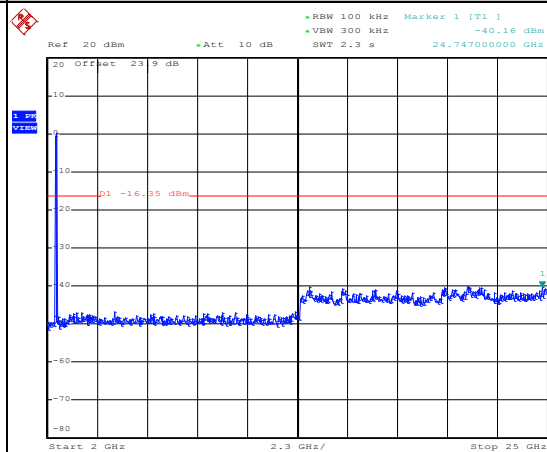

Date: 24.DEC.2014 22:53:26



Number of TX :	1	Ant. :	1
Test Mode :	802.11g	Temperature :	21~25°C
Test Band :	2.4GHz Mid	Relative Humidity :	51~54%
Test Channel :	06	Test Engineer :	Bill Kuo and AC Chang

WLAN 802.11g Channel 06

100kHz PSD reference Level

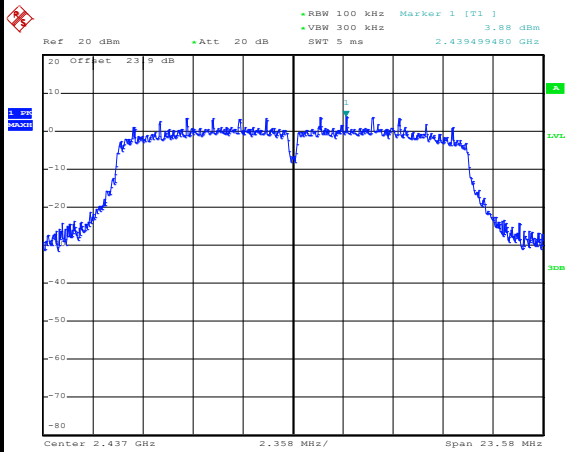

Date: 24.DEC.2014 22:47:57

Spurious Emission 30MHz~3GHz

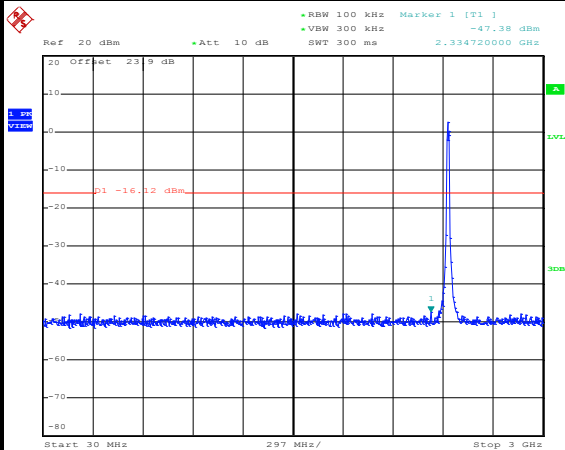

Date: 24.DEC.2014 22:49:08

Spurious Emission 2GHz~25GHz

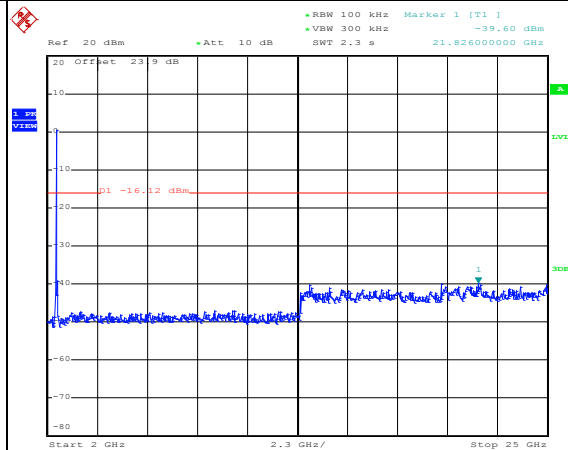

Date: 24.DEC.2014 22:49:26



Number of TX :	1	Ant. :	1
Test Mode :	802.11g	Temperature :	21~25°C
Test Band :	2.4GHz High	Relative Humidity :	51~54%
Test Channel :	11	Test Engineer :	Bill Kuo and AC Chang

WLAN 802.11g Channel 11

100kHz PSD reference Level

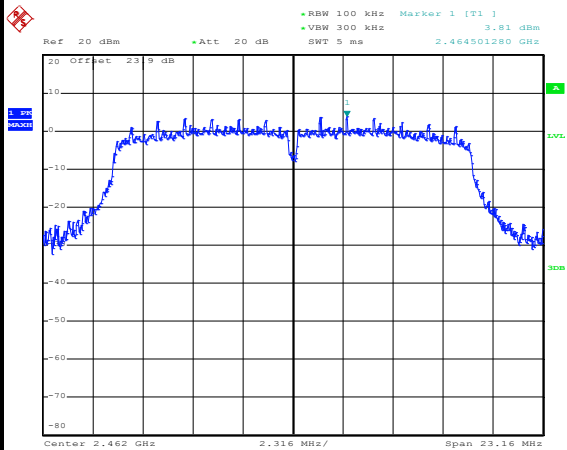

Date: 24.DEC.2014 22:42:20

High Channel Plot

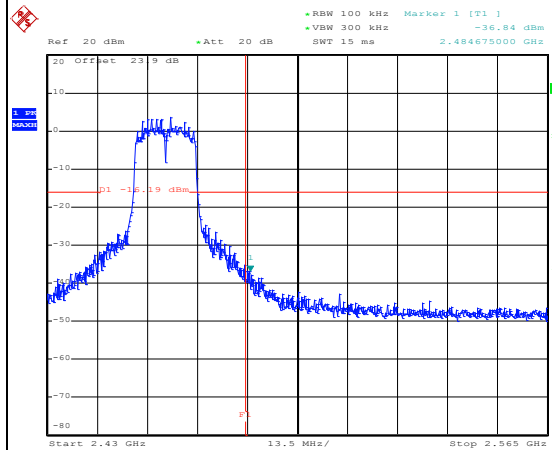

Date: 24.DEC.2014 22:43:01

Spurious Emission 30MHz~3GHz

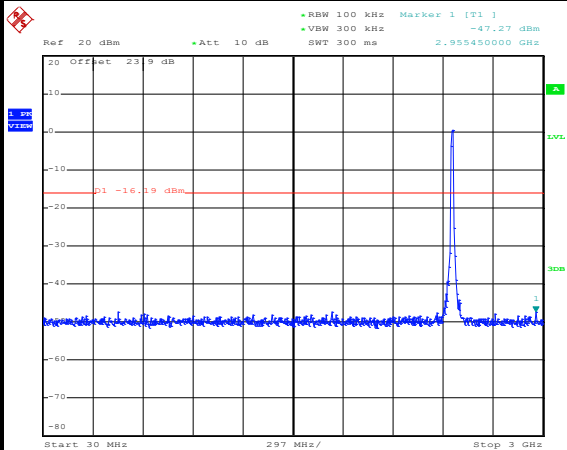

Date: 24.DEC.2014 22:43:26

Spurious Emission 2GHz~25GHz

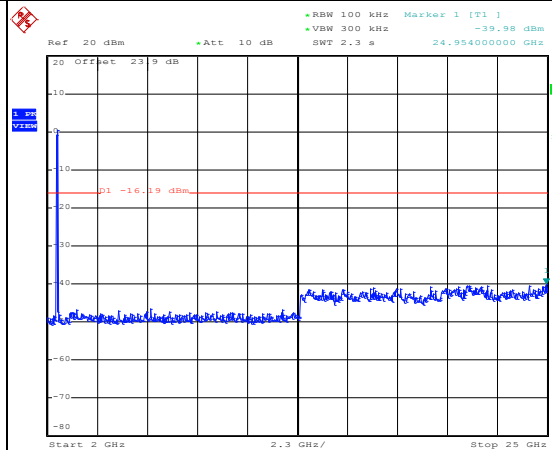

Date: 24.DEC.2014 22:43:44



Number of TX = 2, Ant. 1 (Measured)

Number of TX :	2	Ant. :	1
Test Mode :	802.11n HT20	Temperature :	21~25°C
Test Band :	2.4GHz Low	Relative Humidity :	51~54%
Test Channel :	01	Test Engineer :	Bill Kuo and AC Chang

WLAN 802.11n HT20 Channel 01

100kHz PSD reference Level

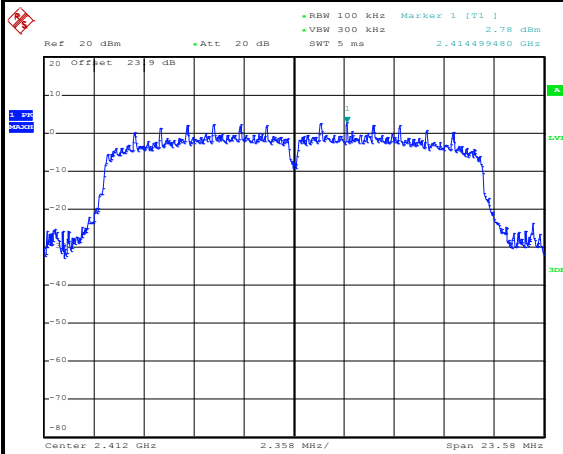

Date: 24.DEC.2014 23:07:52

Low Channel Plot

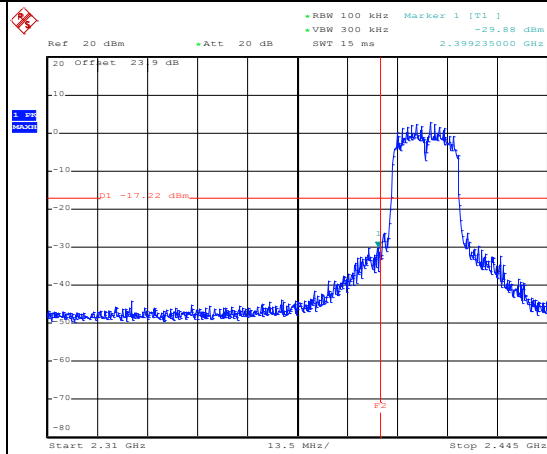

Date: 24.DEC.2014 23:08:33

Spurious Emission 30MHz~3GHz

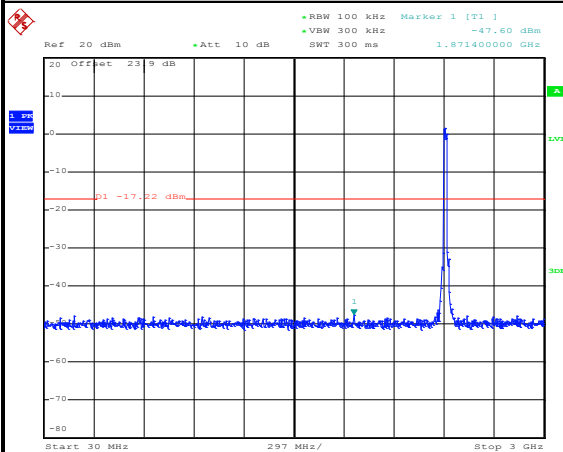

Date: 24.DEC.2014 23:09:07

Spurious Emission 2GHz~25GHz

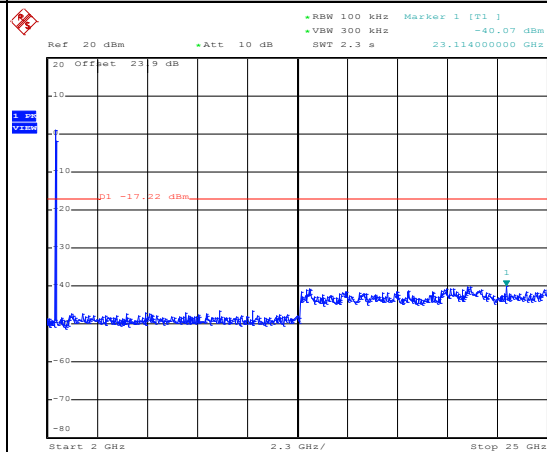

Date: 24.DEC.2014 23:09:25



Number of TX :	2	Ant. :	1
Test Mode :	802.11n HT20	Temperature :	21~25°C
Test Band :	2.4GHz Mid	Relative Humidity :	51~54%
Test Channel :	06	Test Engineer :	Bill Kuo and AC Chang

WLAN 802.11n HT20 Channel 06

100kHz PSD reference Level

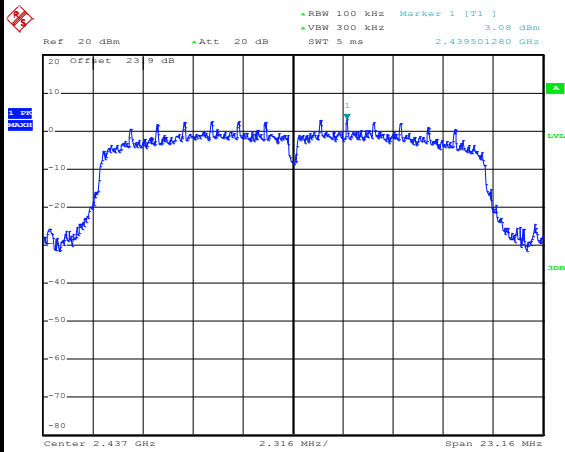

Date: 24.DEC.2014 23:14:43

Spurious Emission 30MHz~3GHz

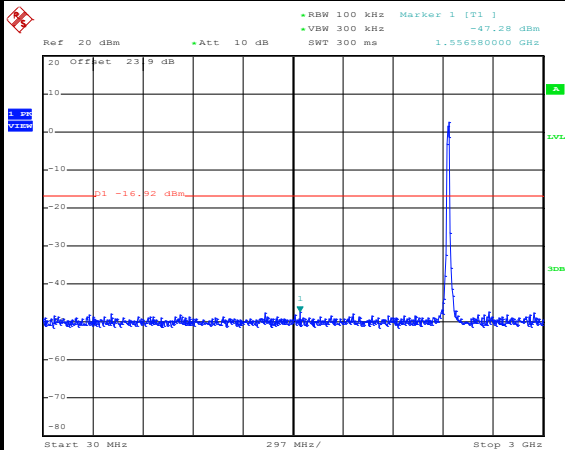

Date: 24.DEC.2014 23:15:08

Spurious Emission 2GHz~25GHz

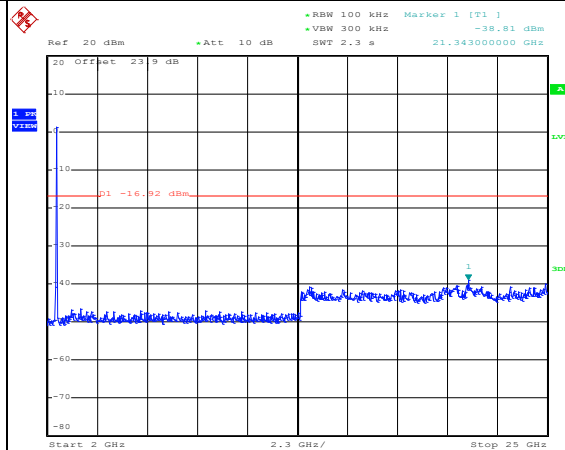

Date: 24.DEC.2014 23:15:26



Number of TX :	2	Ant. :	1
Test Mode :	802.11n HT20	Temperature :	21~25°C
Test Band :	2.4GHz High	Relative Humidity :	51~54%
Test Channel :	11	Test Engineer :	Bill Kuo and AC Chang

WLAN 802.11n HT20 Channel 11

100kHz PSD reference Level

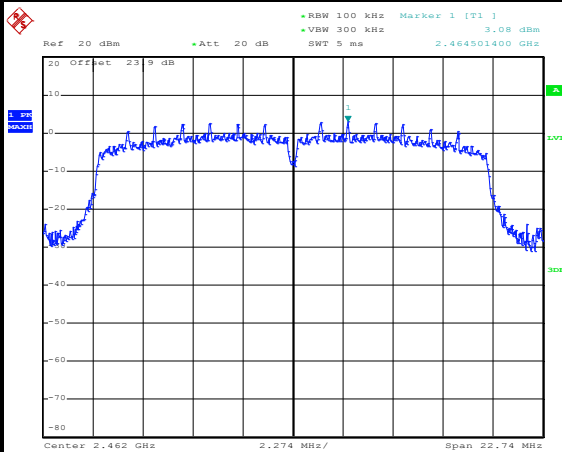

Date: 24.DEC.2014 23:26:15

High Channel Plot

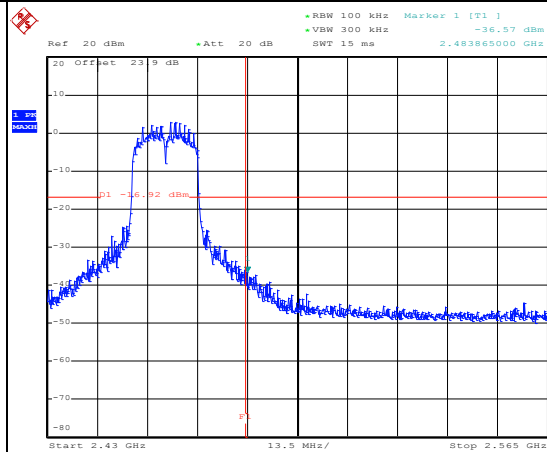

Date: 24.DEC.2014 23:29:28

Spurious Emission 30MHz~3GHz

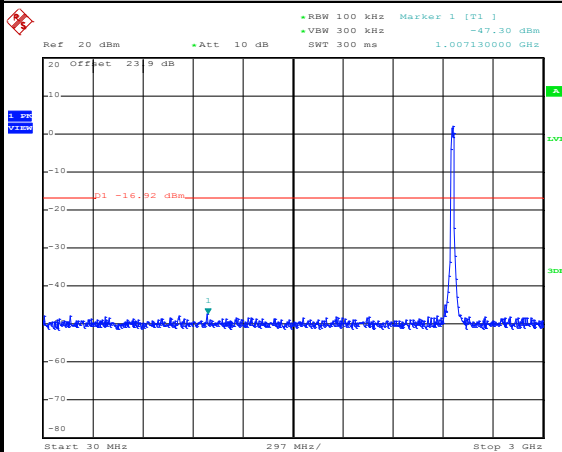

Date: 24.DEC.2014 23:26:54

Spurious Emission 2GHz~25GHz

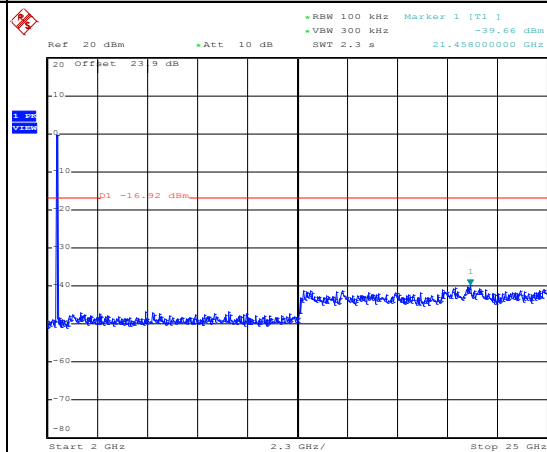

Date: 24.DEC.2014 23:27:12



Number of TX = 2, Ant. 2 (Measured)

Number of TX :	2	Ant. :	2
Test Mode :	802.11n HT20	Temperature :	21~25°C
Test Band :	2.4GHz Low	Relative Humidity :	51~54%
Test Channel :	01	Test Engineer :	Bill Kuo and AC Chang

WLAN 802.11n HT20 Channel 01

100kHz PSD reference Level

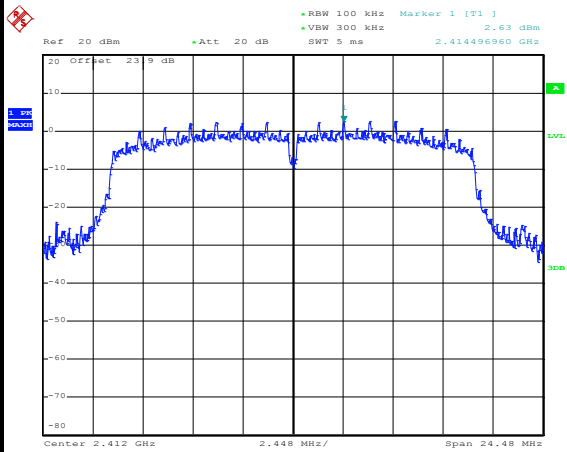

Date: 24.DEC.2014 23:03:25

Low Channel Plot

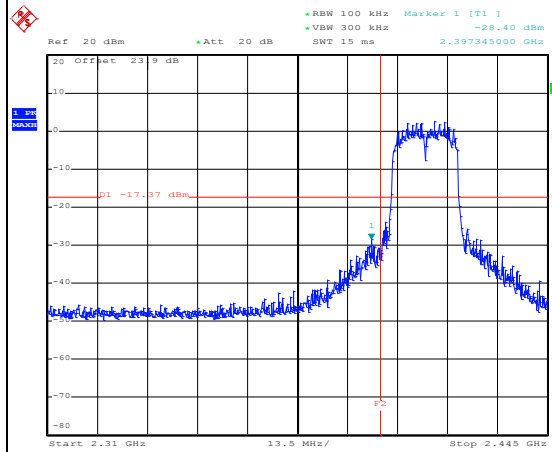

Date: 24.DEC.2014 23:04:02

Spurious Emission 30MHz~3GHz

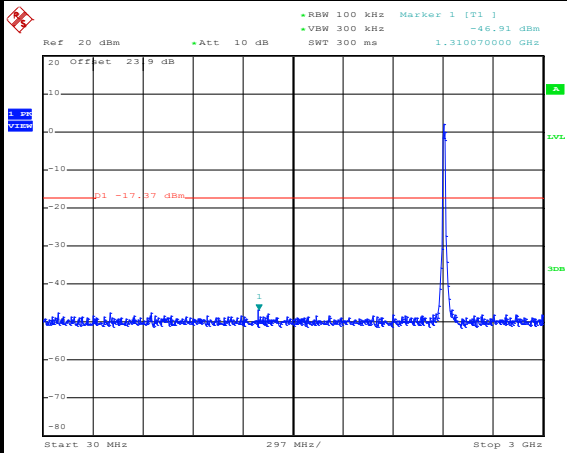

Date: 24.DEC.2014 23:04:23

Spurious Emission 2GHz~25GHz

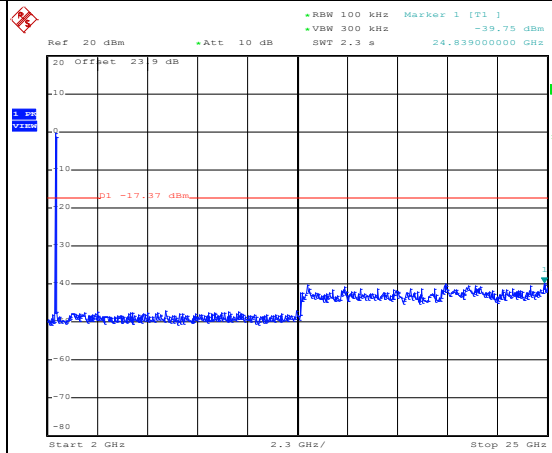

Date: 24.DEC.2014 23:04:41



Number of TX :	2	Ant. :	2
Test Mode :	802.11n HT20	Temperature :	21~25°C
Test Band :	2.4GHz Mid	Relative Humidity :	51~54%
Test Channel :	06	Test Engineer :	Bill Kuo and AC Chang

WLAN 802.11n HT20 Channel 06

100kHz PSD reference Level

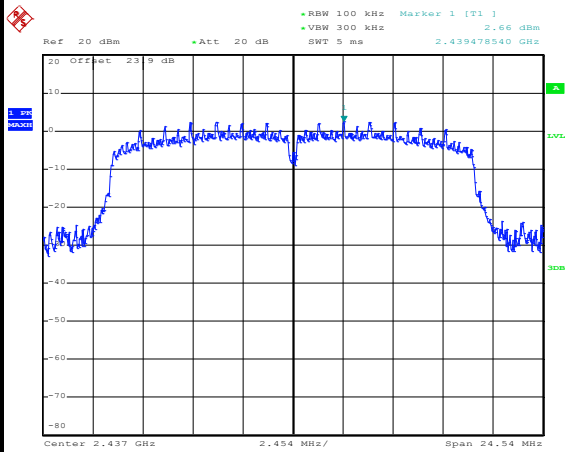

Date: 24.DEC.2014 23:18:13

Spurious Emission 30MHz~3GHz

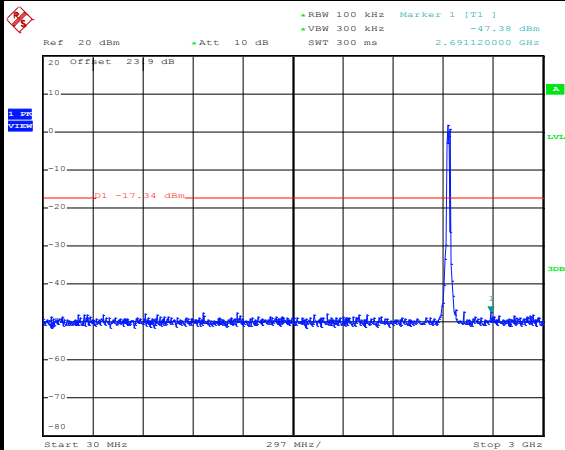

Date: 24.DEC.2014 23:19:14

Spurious Emission 2GHz~25GHz

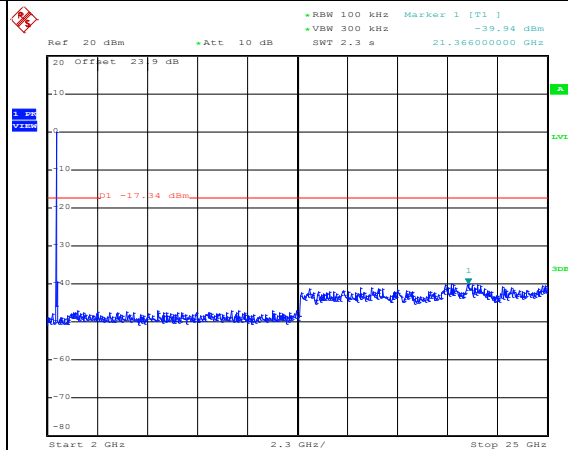

Date: 24.DEC.2014 23:19:32



Number of TX :	2	Ant. :	2
Test Mode :	802.11n HT20	Temperature :	21~25°C
Test Band :	2.4GHz High	Relative Humidity :	51~54%
Test Channel :	11	Test Engineer :	Bill Kuo and AC Chang

WLAN 802.11n HT20 Channel 11

100kHz PSD reference Level

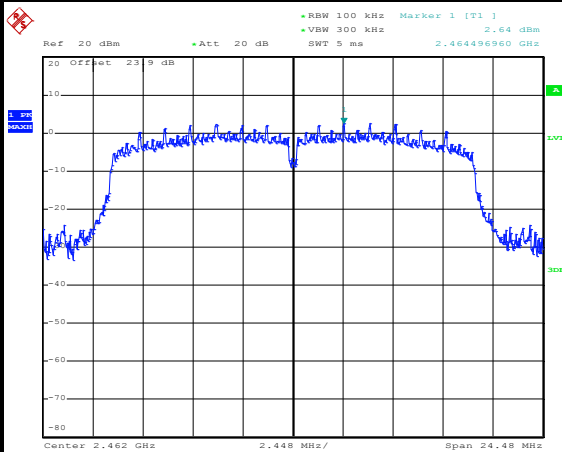

Date: 24.DEC.2014 23:22:44

High Channel Plot

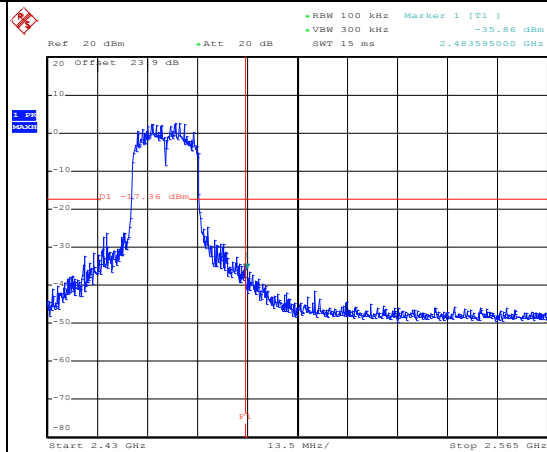

Date: 24.DEC.2014 23:23:58

Spurious Emission 30MHz~3GHz

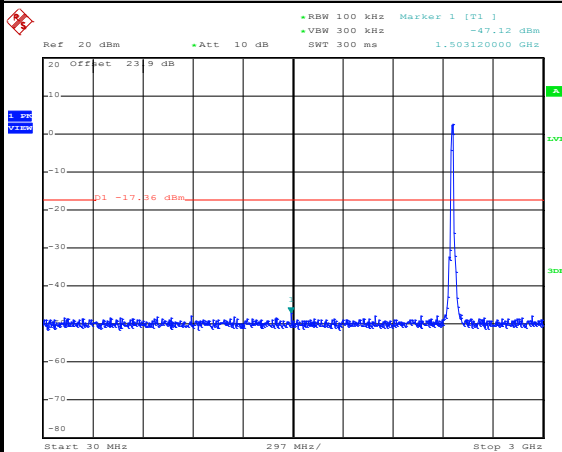

Date: 24.DEC.2014 23:23:23

Spurious Emission 2GHz~25GHz

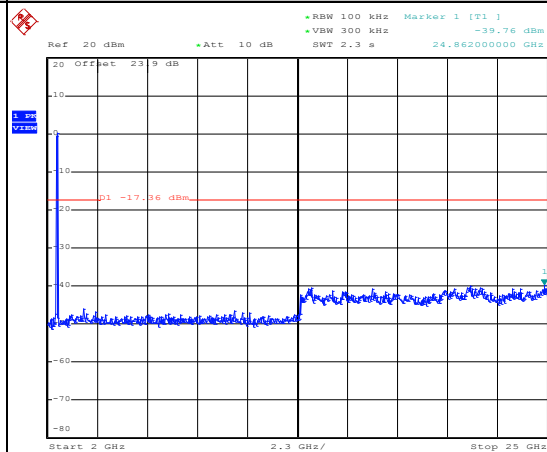

Date: 24.DEC.2014 23:23:41



3.5 Radiated Band Edges and Spurious Emission Measurement

3.5.1 Limit of Radiated band edge and Spurious Emission Measurement

In any 100 kHz bandwidth outside the intentional radiator frequency band, all harmonics/spurious must be at least 20 dB below the highest emission level within the authorized band. If the output power of this device was measured by spectrum analyzer, the attenuation under this paragraph shall be 30 dB instead of 20 dB. In addition, radiated emissions which fall in the restricted bands must also comply with the FCC section 15.209 limits as below.

Frequency (MHz)	Field Strength (microvolts/meter)	Measurement Distance (meters)
0.009 – 0.490	2400/F(kHz)	300
0.490 – 1.705	24000/F(kHz)	30
1.705 – 30.0	30	30
30 – 88	100	3
88 – 216	150	3
216 - 960	200	3
Above 960	500	3

3.5.2 Measuring Instruments

The measuring equipment is listed in the section 4 of this test report.

3.5.3 Test Procedure

1. The testing follows FCC KDB Publication No. 558074 D01 DTS Meas. Guidance v03r02.
2. The EUT was arranged to its worst case and then tune the antenna tower (from 1 m to 4 m) and turntable (from 0 degree to 360 degrees) to find the maximum reading. A pre-amp and a high pass filter are used for the test in order to get better signal level.
3. The EUT was placed on a turntable with 0.8 meter for frequency below 1GHz and 1.5 meter for frequency above 1GHz respectively above ground.
4. The EUT was set 3 meters from the interference receiving antenna, which was mounted on the top of a variable height antenna tower.
5. Corrected Reading: $\text{Antenna Factor} + \text{Cable Loss} + \text{Read Level} - \text{Preamp Factor} = \text{Level}$
6. For measurement below 1GHz, If the emission level of the EUT measured by the peak detector is 3 dB lower than the applicable limit, the peak emission level will be reported. Otherwise, the emission measurement will be repeated using the quasi-peak detector and reported.



7. Use the following spectrum analyzer settings:
- (1) Span shall wide enough to fully capture the emission being measured;
 - (2) Set RBW=100 kHz for $f < 1$ GHz; $VBW \geq RBW$; Sweep = auto; Detector function = peak; Trace = max hold;
 - (3) Set RBW = 1 MHz, VBW= 3MHz for $f \geq 1$ GHz for peak measurement.
- For average measurement:
- $VBW = 10$ Hz, when duty cycle is no less than 98 percent.
 - $VBW \geq 1/T$, when duty cycle is less than 98 percent where T is the minimum transmission duration over which the transmitter is on and is transmitting at its maximum power control level for the tested mode of operation.

Antenna	Band	Duty Cycle(%)	T(us)	1/T(kHz)	VBW Setting
1	802.11b	97.64	12420.00	0.08	100Hz
2	802.11b	97.65	12480.00	0.08	100Hz
1	802.11g	87.39	2080.00	0.48	1kHz
2	802.11g	87.29	2060.00	0.49	1kHz
1	2.4GHz 802.11n HT20 for Ant. 1	86.61	1940.00	0.52	1kHz
2	2.4GHz 802.11n HT20 for Ant. 2	86.61	1940.00	0.52	1kHz
1+2	2.4GHz 802.11n HT20 for Ant. 1	76.92	1000.00	1.00	1kHz
1+2	2.4GHz 802.11n HT20 for Ant. 2	76.56	980.00	1.02	3kHz

3.5.4 Test Setup

For radiated emissions below 30MHz

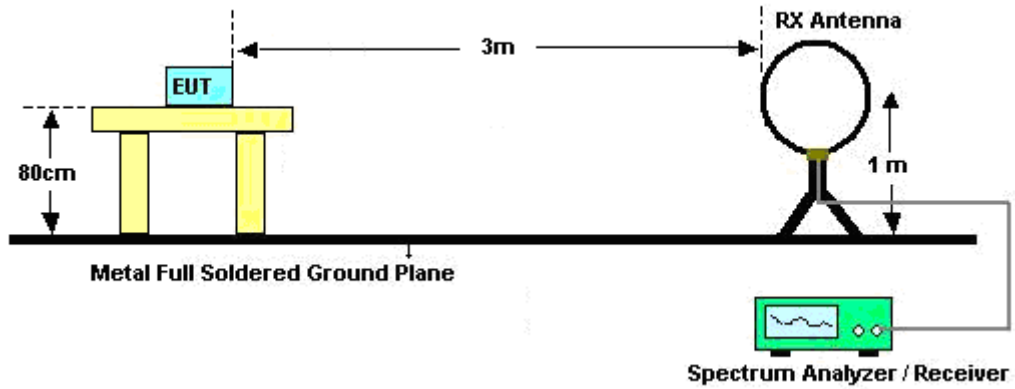

For radiated emissions from 30MHz to 1GHz

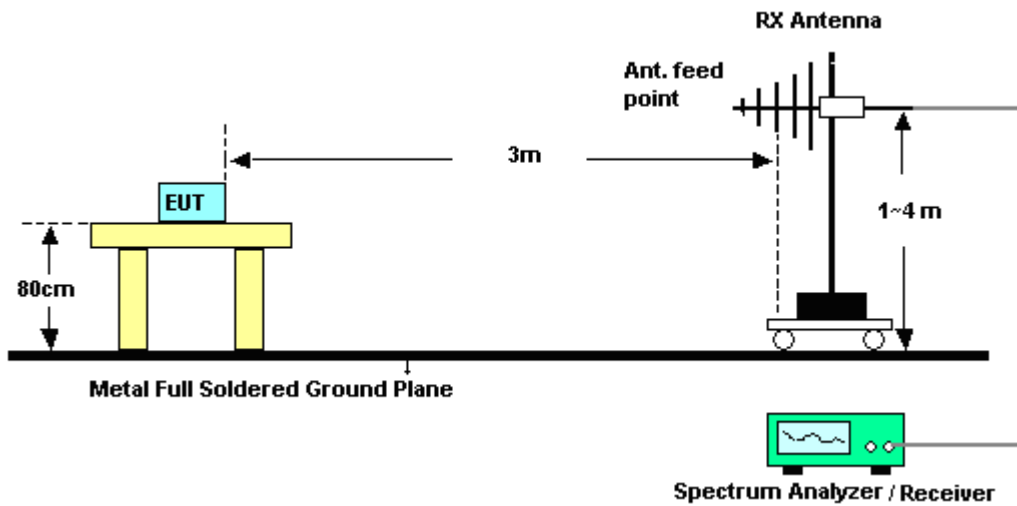

For radiated emissions above 1GHz

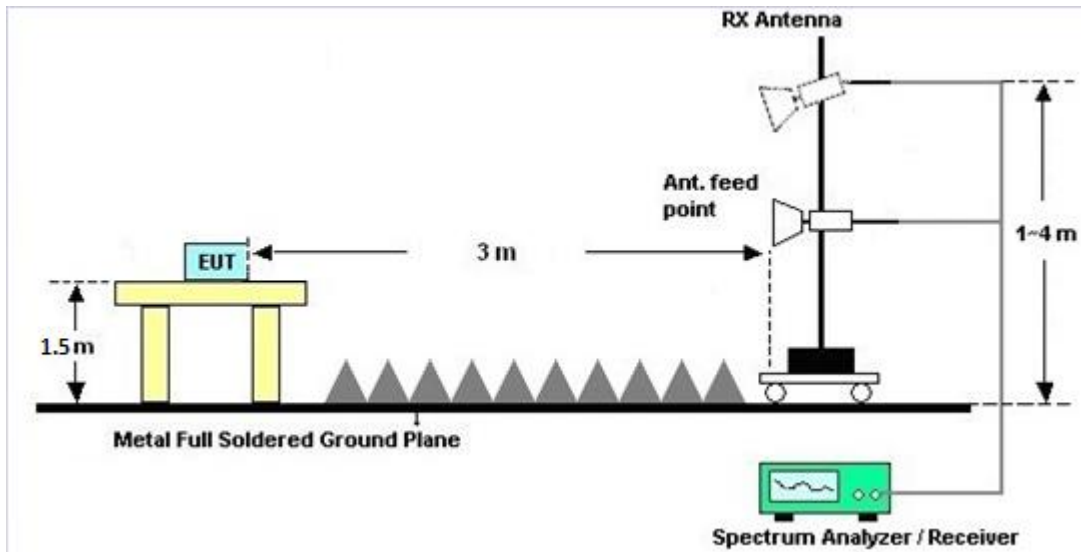

3.5.5 Test Results of Radiated Emissions (9kHz ~ 30MHz)

The low frequency, which started from 9 kHz to 30MHz, was pre-scanned and the result which was 20dB lower than the limit line per 15.31(o) was not reported.

3.5.6 Test Result of Radiated Spurious at Band Edges

Please refer to Appendix B of this test report.

3.5.7 Test Result of Radiated Spurious Emission (30MHz ~ 10th Harmonic)

Please refer to Appendix B of this test report.



3.6 AC Conducted Emission Measurement

3.6.1 Limit of AC Conducted Emission

For equipment that is designed to be connected to the public utility (AC) power line, the radio frequency voltage that is conducted back onto the AC power line on any frequency or frequencies within the band 150 kHz to 30 MHz shall not exceed the limits in the following table.

Frequency of Emission (MHz)	Conducted Limit (dB μ V)	
	Quasi-Peak	Average
0.15-0.5	66 to 56*	56 to 46*
0.5-5	56	46
5-30	60	50

*Decreases with the logarithm of the frequency.

3.6.2 Measuring Instruments

The measuring equipment is listed in the section 4 of this test report.

3.6.3 Test Procedures

1. The EUT was placed 0.4 meter from the conducting wall of the shielding room, and it was kept at least 80 centimeters from any other grounded conducting surface.
2. Connect EUT to the power mains through a line impedance stabilization network (LISN).
3. All the support units are connecting to the other LISN.
4. The LISN provides 50 ohm coupling impedance for the measuring instrument.
5. The FCC states that a 50 ohm, 50 microhenry LISN should be used.
6. Both sides of AC line were checked for maximum conducted interference.
7. The frequency range from 150 kHz to 30 MHz was searched.
8. Set the test-receiver system to Peak Detect Function and specified bandwidth (IF bandwidth = 9kHz) with Maximum Hold Mode.

3.6.4 Test Setup

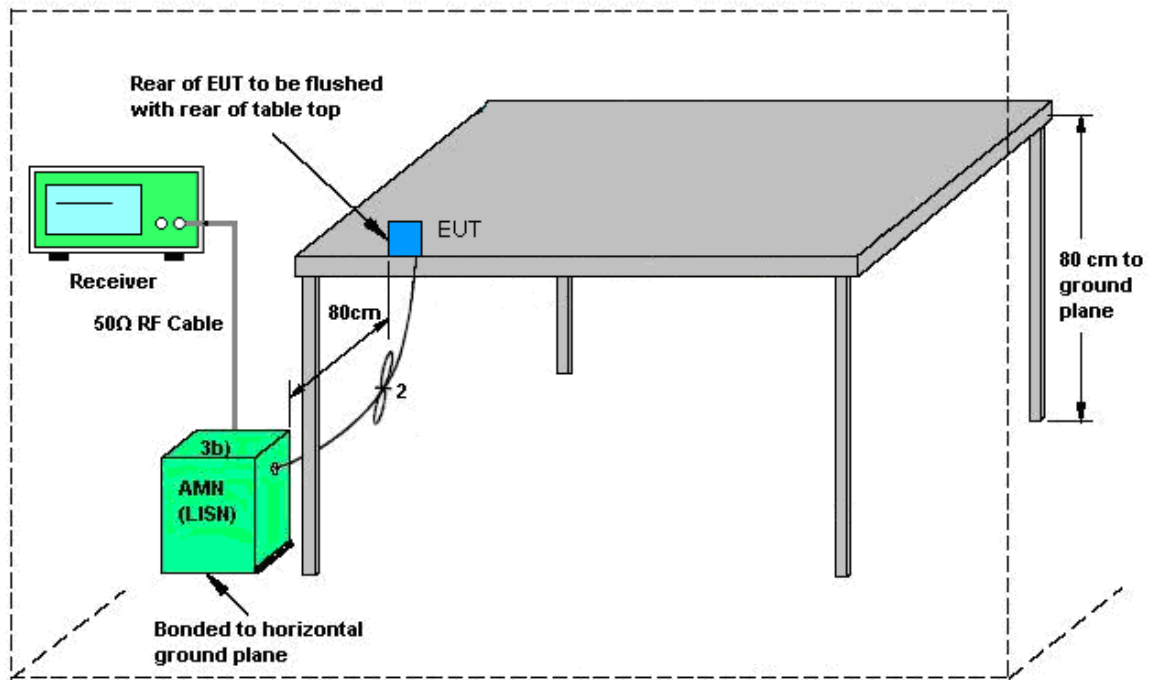

AMN = Artificial mains network (LISN)
AE = Associated equipment
EUT = Equipment under test
ISN = Impedance stabilization network

3.6.5 Test Result of AC Conducted Emission

Test Mode :	Mode 1	Temperature :	20~22°C
Test Engineer :	Eric Jeng	Relative Humidity :	46~48%
Test Voltage :	120Vac / 60Hz	Phase :	Line
Function Type :	Bluetooth Link + WLAN (2.4GHz) Link + Camera (Back) + Earphone + USB Cable (Charging from Adapter) + TF		

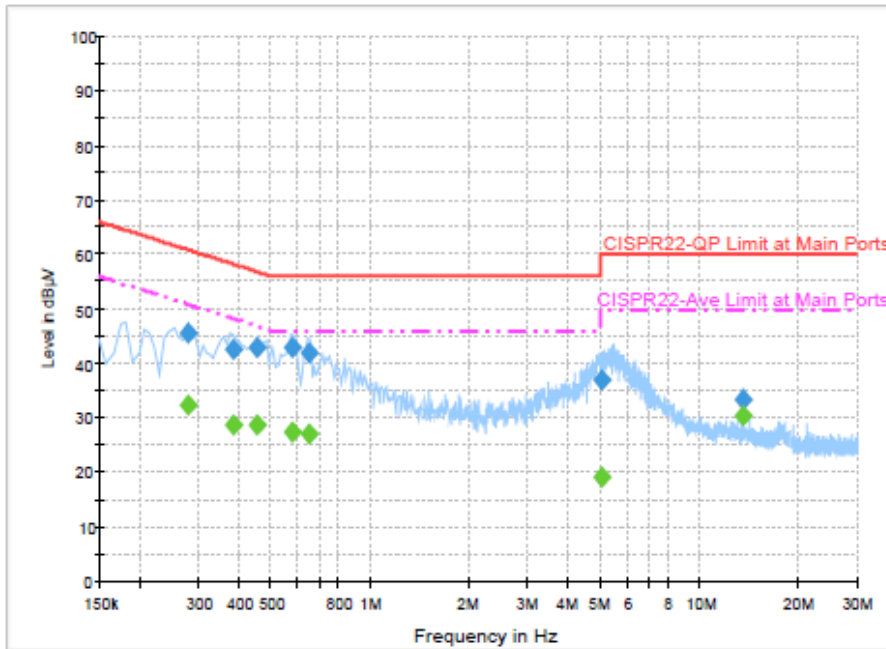

Final Result : Quasi-Peak

Frequency (MHz)	Quasi-Peak (dBµV)	Filter	Line	Corr. (dB)	Margin (dB)	Limit (dBµV)
0.278000	45.7	Off	L1	19.5	15.2	60.9
0.382000	42.7	Off	L1	19.5	15.5	58.2
0.454000	42.8	Off	L1	19.5	14.0	56.8
0.582000	42.8	Off	L1	19.5	13.2	56.0
0.654000	41.9	Off	L1	19.5	14.1	56.0
5.030000	37.0	Off	L1	19.6	23.0	60.0
13.558000	33.4	Off	L1	19.7	26.6	60.0

Final Result : Average

Frequency (MHz)	Average (dBµV)	Filter	Line	Corr. (dB)	Margin (dB)	Limit (dBµV)
0.278000	32.3	Off	L1	19.5	18.6	50.9
0.382000	28.9	Off	L1	19.5	19.3	48.2
0.454000	28.6	Off	L1	19.5	18.2	46.8
0.582000	27.4	Off	L1	19.5	18.6	46.0
0.654000	27.2	Off	L1	19.5	18.8	46.0
5.030000	19.2	Off	L1	19.6	30.8	50.0
13.558000	30.2	Off	L1	19.7	19.8	50.0



Test Mode :	Mode 1	Temperature :	20~22°C
Test Engineer :	Eric Jeng	Relative Humidity :	46~48%
Test Voltage :	120Vac / 60Hz	Phase :	Neutral
Function Type :	Bluetooth Link + WLAN (2.4GHz) Link + Camera (Back) + Earphone + USB Cable (Charging from Adapter) + TF		

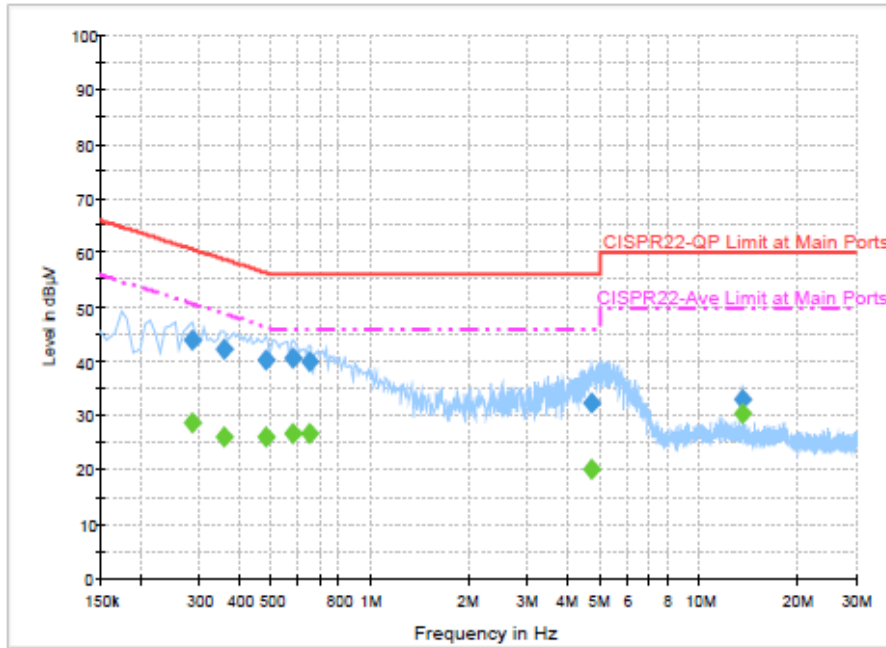

Final Result : Quasi-Peak

Frequency (MHz)	Quasi-Peak (dBµV)	Filter	Line	Corr. (dB)	Margin (dB)	Limit (dBµV)
0.286000	44.0	Off	N	19.5	16.6	60.6
0.358000	42.4	Off	N	19.5	16.4	58.8
0.478000	40.4	Off	N	19.5	16.0	56.4
0.582000	40.7	Off	N	19.5	15.3	56.0
0.654000	39.8	Off	N	19.5	16.2	56.0
4.670000	32.2	Off	N	19.6	23.8	56.0
13.558000	32.9	Off	N	19.7	27.1	60.0

Final Result : Average

Frequency (MHz)	Average (dBµV)	Filter	Line	Corr. (dB)	Margin (dB)	Limit (dBµV)
0.286000	28.6	Off	N	19.5	22.0	50.6
0.358000	26.1	Off	N	19.5	22.7	48.8
0.478000	25.9	Off	N	19.5	20.5	46.4
0.582000	26.8	Off	N	19.5	19.2	46.0
0.654000	26.8	Off	N	19.5	19.2	46.0
4.670000	20.0	Off	N	19.6	26.0	46.0
13.558000	30.2	Off	N	19.7	19.8	50.0

3.7 Antenna Requirements

3.7.1 Standard Applicable

If directional gain of transmitting Antennas is greater than 6dBi, the power shall be reduced by the same level in dB comparing to gain minus 6dBi. For the fixed point-to-point operation, the power shall be reduced by one dB for every 3 dB that the directional gain of the Antenna exceeds 6 dBi. The use of a permanently attached Antenna or of an Antenna that uses a unique coupling to the intentional radiator shall be considered sufficient to comply with the FCC rule.

3.7.2 Antenna Anti-Replacement Construction

An embedded-in antenna design is used.

3.7.3 Antenna Gain

$$DirectionalGain = 10 \cdot \log \left[\frac{\sum_{j=1}^{N_{SS}} \left\{ \sum_{k=1}^{N_{ANT}} g_{j,k} \right\}^2}{N_{ANT}} \right]$$

where

Each antenna is driven by no more than one spatial stream;

N_{SS} = the number of independent spatial streams of data;

N_{ANT} = the total number of antennas

$g_{j,k} = 10^{G_k / 20}$ if the k th antenna is being fed by spatial stream j , or zero if it is not;
 G_k is the gain in dBi of the k th antenna.

The EUT supports CDD mode.

The power and PSD limit should be modified if the directional gain of EUT is over 6 dBi,

The directional gain “DG” is calculated as following table.



			DG	DG	Power	PSD
			for	for	Limit	Limit
	Ant. 1	Ant. 2	Power	PSD	Reduction	Reduction
	(dBi)	(dBi)	(dBi)	(dBi)	(dB)	(dB)
2.4 GHz	-2.84	-3.79	-0.29	-0.29	0.00	0.00

Power Limit Reduction = DG(Power) – 6dBi, (min = 0)

PSD Limit Reduction = DG(PSD) – 6dBi, (min = 0)



4 List of Measuring Equipment

Instrument	Manufacturer	Model No.	Serial No.	Characteristics	Calibration Date	Test Date	Due Date	Remark
Spectrum Analyzer	Rohde & Schwarz	FSP40	100055	9kHz~40GHz	Jun. 09, 2014	Nov. 13, 2014~ Dec. 24, 2014	Jun. 08, 2015	Conducted (TH02-HY)
Power Meter	Anritsu	ML2495A	1036004	300MHz~40GHz	Aug. 09, 2014	Nov. 13, 2014~ Dec. 24, 2014	Aug. 08, 2015	Conducted (TH02-HY)
Power Sensor	Anritsu	MA2411B	1027253	300MHz~40GHz	Aug. 09, 2014	Nov. 13, 2014~ Dec. 24, 2014	Aug. 08, 2015	Conducted (TH02-HY)
EMI Test Receiver	Rohde & Schwarz	ESCI 7	100724	9 kHz~7 GHz	Aug. 30, 2014	Dec. 18, 2014~ Dec. 26, 2014	Aug. 29, 2015	Radiation (03CH07-HY)
Spectrum Analyzer	Rohde & Schwarz	FSV30	101749	10Hz ~ 30GHz	Feb. 10, 2014	Dec. 18, 2014~ Dec. 26, 2014	Feb. 09, 2015	Radiation (03CH07-HY)
Loop Antenna	R&S	HFH2-Z2	100315	9 kHz~30 MHz	Jul. 28, 2014	Dec. 18, 2014~ Dec. 26, 2014	Jul. 27, 2015	Radiation (03CH07-HY)
Bilog Antenna	Schaffner	CBL6111C	2726	30MHz ~ 1GHz	Sep. 27, 2014	Dec. 18, 2014~ Dec. 26, 2014	Sep. 26, 2015	Radiation (03CH07-HY)
Double Ridge Horn Antenna	ESCO	3117	75962	1GHz~18GHz	Aug. 19, 2014	Dec. 18, 2014~ Dec. 26, 2014	Aug. 18, 2015	Radiation (03CH07-HY)
SHF-EHF Horn Antenna	SCHWARZBECK	BBHA 9170	BBHA9170 251	18GHz~40GHz	Oct. 02, 2014	Dec. 18, 2014~ Dec. 26, 2014	Oct. 01, 2015	Radiation (03CH07-HY)
Preamplifier	COM-POWER	PA-103A	161241	10 MHz ~ 1000MHz	Mar. 17, 2014	Dec. 18, 2014~ Dec. 26, 2014	Mar. 16, 2015	Radiation (03CH07-HY)
Preamplifier	Agilent	8449B	3008A023 62	1 GHz~26.5 GHz	Oct. 21, 2014	Dec. 18, 2014~ Dec. 26, 2014	Oct. 20, 2015	Radiation (03CH07-HY)
Preamplifier	MITEQ	AMF-7D-0010 1800-30-10P	1590074	DC~18 GHz	Jul. 07, 2014	Dec. 18, 2014~ Dec. 26, 2014	Jul. 06, 2015	Radiation (03CH07-HY)
Preamplifier	MITEQ	AMF-7D-0010 1800-30-10P	1590075	DC~18 GHz	Apr. 21, 2014	Dec. 18, 2014~ Dec. 26, 2014	Apr. 20, 2015	Radiation (03CH07-HY)
Turn Table	ChainTek	ChainTek 3000	N/A	0 ~ 360 degree	N/A	Dec. 18, 2014~ Dec. 26, 2014	N/A	Radiation (03CH07-HY)
Antenna Mast	ChainTek	ChainTek 3000	N/A	N/A	N/A	Dec. 18, 2014~ Dec. 26, 2014	N/A	Radiation (03CH07-HY)
EMI Test Receiver	Rohde & Schwarz	ESCI 7	100724	9kHz~7GHz	Aug. 30, 2014	Nov. 28, 2014	Aug. 29, 2015	Conduction (CO05-HY)
LISN (for auxiliary equipment)	Rohde & Schwarz	ENV216	100081	9kHz ~ 30MHz	Dec. 12, 2013	Nov. 28, 2014	Dec. 11, 2014	Conduction (CO05-HY)
LISN	Rohde & Schwarz	ENV216	100080	9kHz ~ 30MHz	Dec. 04, 2013	Nov. 28, 2014	Dec. 03, 2014	Conduction (CO05-HY)
AC Power Source	ChainTek	APC-1000W	N/A	N/A	N/A	Nov. 28, 2014	N/A	Conduction (CO05-HY)



5 Uncertainty of Evaluation

Uncertainty of Conducted Emission Measurement (150kHz ~ 30MHz)

Measuring Uncertainty for a Level of Confidence of 95% ($U = 2Uc(y)$)	2.26
---	------

Uncertainty of Radiated Emission Measurement (30 MHz ~ 1000 MHz)

Measuring Uncertainty for a Level of Confidence of 95% ($U = 2Uc(y)$)	4.50
---	------



Appendix A. Conducted Test Results