



FCC TEST REPORT

REPORT NO.: RF920217H02

MODEL NO.: WLAN Access Point 2220

RECEIVED: Feb. 17, 2003

TESTED: Feb. 19 Mar. 12, 2003

APPLICANT: Accton Technology Corporation

ADDRESS: No.1, Creation Rd. III, Science-based Industrial Park, Hsinchu, Taiwan, R.O.C

ISSUED BY: Advance Data Technology Corporation

LAB LOCATION: No. 81-1, Lu Liao Keng, 9 Ling, Wu Lung Tsuen, Chiung Lin Hsiang, Hsin Chu Hsien, Taiwan, R.O.C.

This test report consists of 145 pages in total. It may be duplicated completely for legal use with the approval of the applicant. It should not be reproduced except in full, without the written approval of our laboratory. The client should not use it to claim product endorsement by CNLA, NVLAP or any government agencies. The test results in the report only apply to the tested sample.



0536

ILAC MRA



Lab Code: 200376-0



Table of Contents

1.	CERTIFICATION.....	5
2.	SUMMARY OF TEST RESULTS.....	6
3.	GENERAL INFORMATION.....	8
3.1	GENERAL DESCRIPTION OF EUT.....	8
3.2	DESCRIPTION OF TEST MODES.....	10
3.3	GENERAL DESCRIPTION OF APPLIED STANDARDS.....	11
3.4	DESCRIPTION OF SUPPORT UNITS.....	12
4.	TEST TYPES AND RESULTS (For Part 802.11b).....	15
4.1	CONDUCTED EMISSION MEASUREMENT.....	15
4.1.1	LIMITS OF CONDUCTED EMISSION MEASUREMENT.....	15
4.1.2	TEST INSTRUMENTS.....	15
4.1.3	TEST PROCEDURES.....	16
4.1.4	DEVIATION FROM TEST STANDARD.....	16
4.1.5	TEST SETUP.....	17
4.1.6	EUT OPERATING CONDITIONS.....	17
4.1.7	TEST RESULTS.....	18
4.2	Radiated Emission Measurement.....	24
4.2.1	LIMITS OF RADIATED EMISSION MEASUREMENT.....	24
4.2.2	TEST INSTRUMENTS.....	25
4.2.3	TEST PROCEDURES.....	26
4.2.4	DEVIATION FROM TEST STANDARD.....	26
4.2.5	TEST SETUP.....	27
4.2.6	EUT OPERATING CONDITIONS.....	27
4.2.7	TEST RESULTS.....	28
4.3	6dB BANDWIDTH MEASUREMENT.....	33
4.3.1	LIMITS OF 6dB BANDWIDTH MEASUREMENT.....	33
4.3.2	TEST INSTRUMENTS.....	33
4.3.3	TEST PROCEDURE.....	34
4.3.4	DEVIATION FROM TEST STANDARD.....	34
4.3.5	TEST SETUP.....	34
4.3.6	EUT OPERATING CONDITIONS.....	34
4.3.7	TEST RESULTS.....	35
4.4	MAXIMUM PEAK OUTPUT POWER.....	39
4.4.1	LIMITS OF MAXIMUM PEAK OUTPUT POWER MEASUREMENT.....	39
4.4.2	INSTRUMENTS.....	39
4.4.3	TEST PROCEDURES.....	40
4.4.4	DEVIATION FROM TEST STANDARD.....	40
4.4.5	TEST SETUP.....	40
4.4.6	EUT OPERATING CONDITIONS.....	40
4.4.7	TEST RESULTS.....	41
4.5	POWER SPECTRAL DENSITY MEASUREMENT.....	42



4.5.1	LIMITS OF POWER SPECTRAL DENSITY MEASUREMENT.....	42
4.5.2	TEST INSTRUMENTS.....	42
4.5.3	TEST PROCEDURE	43
4.5.4	DEVIATION FROM TEST STANDARD	43
4.5.5	TEST SETUP.....	43
4.5.6	EUT OPERATING CONDITION.....	43
4.5.7	TEST RESULTS.....	44
4.6	BAND EDGES MEASUREMENT.....	48
4.6.1	LIMITS OF BAND EDGES MEASUREMENT.....	48
4.6.2	TEST INSTRUMENTS.....	48
4.6.3	TEST PROCEDURE	48
4.6.4	DEVIATION FROM TEST STANDARD	48
4.6.5	EUT OPERATING CONDITION.....	49
4.6.6	TEST RESULTS.....	49
4.7	ANTENNA REQUIREMENT.....	52
4.7.1	STANDARD APPLICABLE	52
4.7.2	ANTENNA CONNECTED CONSTRUCTION.....	52
5.	TEST TYPES AND RESULTS (For part 802.11a).....	53
5.1	CONDUCTED EMISSION MEASUREMENT.....	53
5.1.1	LIMITS OF CONDUCTED EMISSION MEASUREMENT.....	53
5.1.2	TEST INSTRUMENTS.....	53
5.1.3	TEST PROCEDURES.....	54
5.1.4	DEVIATION FROM TEST STANDARD	54
5.1.5	TEST SETUP.....	55
5.1.6	EUT OPERATING CONDITIONS	55
5.1.7	TEST RESULTS.....	56
5.2	Radiated Emission Measurement	58
5.2.1	LIMITS OF RADIATED EMISSION MEASUREMENT.....	58
5.2.2	LIMITS OF UNWANTED EMISSION OUT OF THE RESTRICTED BANDS	59
5.2.3	TEST INSTRUMENTS.....	60
5.2.4	TEST PROCEDURES	61
5.2.5	DEVIATION FROM TEST STANDARD	61
5.2.6	TEST SETUP.....	62
5.2.7	EUT OPERATING CONDITIONS	62
5.2.8	TEST RESULTS.....	63
5.2.9	TEST RESULTS.....	65
5.3	Peak transmit power MEASUREMENT.....	76
5.3.1	LIMITS OF PEAK TRANSMIT POWER MEASUREMENT.....	76
5.3.2	TEST INSTRUMENTS.....	76
5.3.3	TEST PROCEDURE	77
5.3.4	DEVIATION FROM TEST STANDARD	77
5.3.5	TEST SETUP.....	77
5.3.6	EUT OPERATING CONDITIONS	77
5.3.7	TEST RESULTS.....	78



5.4	Peak power EXCURSION MEASUREMENT.....	102
5.4.1	LIMITS OF PEAK POWER EXCURSION MEASUREMENT.....	102
5.4.2	TEST INSTRUMENTS.....	102
5.4.3	TEST PROCEDURE	103
5.4.4	DEVIATION FROM TEST STANDARD	103
5.4.5	TEST SETUP.....	103
5.4.6	EUT OPERATING CONDITIONS	103
5.4.7	TEST RESULTS.....	104
5.5	PEAK power spectral density measurement.....	117
5.5.1	LIMITS OF PEAK POWER SPECTRAL DENSITY MEASUREMENT.....	117
5.5.2	TEST INSTRUMENTS.....	117
5.5.3	TEST PROCEDURES	118
5.5.4	DEVIATION FROM TEST STANDARD	118
5.5.5	TEST SETUP.....	118
5.5.6	EUT OPERATING CONDITIONS	118
5.5.7	TEST RESULTS.....	119
5.6	FREQUENCY STABILITY	132
5.6.1	LIMITS OF FREQUENCY STABILITY MEASUREMENT.....	132
5.6.2	TEST INSTRUMENTS.....	132
5.6.3	TEST PROCEDURE	132
5.6.4	DEVIATION FROM TEST STANDARD	132
5.6.5	TEST SETUP.....	133
5.6.6	EUT OPERATING CONDITION.....	133
5.6.7	TEST RESULTS.....	134
5.7	BAND EDGES MEASUREMENT	135
5.7.1	TEST INSTRUMENTS.....	135
5.7.2	TEST PROCEDURE	135
5.7.3	EUT OPERATING CONDITION.....	135
5.7.4	TEST RESULTS.....	136
5.8	ANTENNA REQUIREMENT.....	141
5.8.1	STANDARD APPLICABLE.....	141
5.8.2	ANTENNA CONNECTED CONSTRUCTION.....	141
6.	PHOTOGRAPHS OF THE TEST CONFIGURATION.....	142
7.	INFORMATION ON THE TESTING LABORATORIES.....	145



1. CERTIFICATION

PRODUCT : WLAN Access Point 2220
BRAND NAME : NORTEL
MODEL NO. : WLAN Access Point 2220
APPLICANT : Accton Technology Corporation
STANDARDS : 47 CFR Part 15, Subpart C (Section 15.247),
Subpart E (Section 15.407), ANSI C63.4-1992

We, **Advance Data Technology Corporation**, hereby certify that one sample of the designation has been tested in our facility from Feb. 19 Mar. 12, 2003. The test record data evaluation and Equipment under Test (EUT) configurations represented herein are true and accurate accounts of the measurements of the sample's EMC characteristics under the conditions herein specified.

CHECKED BY: *Amanda Chu* , **DATE:** *Mar. 17, 2003*
(Amanda Chu)

APPROVED BY: *Eric Lin* , **DATE:** *Mar. 17, 2003*
(Eric Lin, Manager)

2. SUMMARY OF TEST RESULTS

The EUT has been tested according to the following specifications:

APPLIED STANDARD: 47 CFR Part 15, Subpart C			
Standard Section	Test Type and Limit	Result	REMARK
15.207	AC Power Conducted Emission	PASS	Meet the requirement of limit Minimum passing margin is -21.18dBuV at 1.060MHz
15.247(a)(2)	Spectrum Bandwidth of a Direct Sequence Spread Spectrum System Limit: min. 500kHz	PASS	Meet the requirement of limit
15.247(b)	Maximum Peak Output Power Limit: max. 30dBm	PASS	Meet the requirement of limit
15.247(c)	Radiated Emissions Limit: Table 15.209	PASS	Meet the requirement of limit Minimum passing margin is -4.8dBuV at 43.77MHz
15.247(d)	Power Spectral Density Limit: max. 8dBm	PASS	Meet the requirement of limit
15.247(c)	Band Edge Measurement Limit: 20dB less than the peak value of fundamental frequency	PASS	Meet the requirement of limit



APPLIED STANDARD: 47 CFR Part 15, Subpart E

Standard Section	Test Type	Result	REMARK
15.407(b)(5)	AC Power Conducted Emission	PASS	Meet the requirement of limit Minimum passing margin is -17.62dBuV at 0.197MHz
15.407(b/1/2/3)(b)(5)	Electric Field Strength Spurious Emissions, 30 MHz – 40000 MHz	PASS	Meet the requirement of limit Minimum passing margin is -0.7dBuV at 5835.00MHz
15.407(a/1/2/3)	Peak Transmit Power	PASS	Meet the requirement of limit
15.407(a)(6)	Peak Power Excursion	PASS	Meet the requirement of limit
15.407(a/1/2/3)	Peak Power Spectral Density	PASS	Meet the requirement of limit
15.407(g)	Frequency Stability	PASS	Meet the requirement of limit

3. GENERAL INFORMATION

3.1 GENERAL DESCRIPTION OF EUT

PRODUCT	WLAN Access Point 2220
MODEL NO.	WLAN Access Point 2220
POWER SUPPLY	5.1VDC from AC adapter or 4.8VDC from POE
MODULATION	802.11b: DSSS 802.11a: OFDM
TRANSFER RATE	802.11b: 1 / 2 / 5.5 / 11Mbps 802.11a: 6 to 54Mbps *(Turbo mode : up to 108Mbps)
FREQUENCY RANGE	802.11b: 2412MHz ~ 2462MHz 802.11a: 5.15GHz ~ 5.35GHz, 5.725GHz ~ 5.825GHz
NUMBER OF CHANNEL	802.11b: 11 802.11a: 12 for Normal mode / 5 for Turbo mode
CHANNEL SPACING	802.11b: 5MHz 802.11a: 20MHz for Normal mode / 40MHz for Turbo mode
OUTPUT POWER	802.11b: 15.12dBm 802.11a: 19.77dBm
DATA CABLE	NA
ANTENNA TYPE	Integral antenna
I/O PORTS	NA
ASSOCIATED DEVICES	NA

NOTE:

- The EUT was powered by the following adapter and POE (Power Over Ethernet):

Adapter:	
Brand:	Delta
Model No.:	ADP-15KB
Input power :	AC100-240V, 0.5A, 50/60Hz
Output power :	DC 5.1V, 3.0A

POE:	
Brand:	PowerDsine 6006
Model No.:	PD-PH-6006/AC/48
Input power :	AC 100-240V, 4-1A, 50/60Hz
Output power :	DC 4.8V, 3.0A



2. The EUT operates in both the 5GHz and 2.4GHz Bands and compatibility with 802.11a and 802.11b technology.
3. For more detailed features description, please refer to the manufacturer's specifications or User's Manual.

3.2 DESCRIPTION OF TEST MODES

For 802.11b: Eleven channels are provided to this EUT.

Channel	Frequency	Channel	Frequency
1	2412 MHz	7	2442 MHz
2	2417 MHz	8	2447 MHz
3	2422 MHz	9	2452 MHz
4	2427 MHz	10	2457 MHz
5	2432 MHz	11	2462 MHz
6	2437 MHz		

NOTE:

1. Below 1 GHz, the channel 1, 6, and 11 were pre-tested in chamber. The channel 11, worst case one, was chosen for final test.
2. Above 1 GHz, the channel 1, 6, and 11 were tested individually.

For 802.11a: Twelve channels are provided to this EUT for Normal mode.

Channel	Frequency	Channel	Frequency
1	5180 MHz	7	5300 MHz
2	5200 MHz	8	5320 MHz
3	5220 MHz	9	5745MHz
4	5240 MHz	10	5765MHz
5	5260 MHz	11	5785MHz
6	5280 MHz	12	5805MHz

Five channels are provided to this EUT for Turbo Mode.

Channel	Frequency	Channel	Frequency
1	5210 MHz	4	5760MHz
2	5250 MHz	5	5800MHz
3	5290 MHz		

NOTE:

1. The EUT was transmitting at full power on the specified channel with a duty cycle of 99% (maximum allowed). The EUT was tested in both normal mode (channel bandwidth of approximately 30MHz) and turbo mode (channel bandwidth of approximately 60MHz).
2. "Normal Mode" allows data rates of up to 54Mbps. The device was, therefore, tested in Normal mode at the data rate that produced the highest output power for normal mode (6Mbps).
3. "Turbo Mode" allows data rates of up to 108Mbps. At data rates higher than 12Mbps the PA gain is reduced to improve signal fidelity. The device was, therefore, tested in turbo mode at the data rate that produced the highest output power for turbo mode (12Mbps).
4. Channel 1, 4, 5, 8, 9 and 12 are the closest frequencies to the band edge, were chosen for final test of Normal Mode.
5. Channel 1 ~ 5 were chosen for final test of turbo mode.



3.3 GENERAL DESCRIPTION OF APPLIED STANDARDS

The EUT is a WLAN Access Point 2220 According to the specifications of the manufacturer, it must comply with the requirements of the following standards:

**FCC 47CFR Part 15, Subpart C. (15.247),
Subpart E (15.407). ANSI C63.4 : 1992**

All tests have been performed and recorded as per the above standards.

NOTE: The EUT is also considered as a kind of computer peripheral, because the connection to computer is necessary for typical use. It has been verified to comply with the requirements of FCC Part 15, Subpart B, Class B (DoC). The test report has been issued separately.



3.4 DESCRIPTION OF SUPPORT UNITS

The EUT has been tested as an independent unit together with other necessary accessories or support units. The following support units or accessories were used to form a representative test configuration during the tests.

No.	Product	Brand	Model No.	Serial No.	FCC ID
1	NOTEBOOK COMPUTER	DELL	PP01L	TW-09C748-12800- 17Q-C504	FCC DoC

No.	Signal cable description
1	NA

Note: 1. All power cords of the above support units are unshielded (1.8m).

WITH ADAPTER:

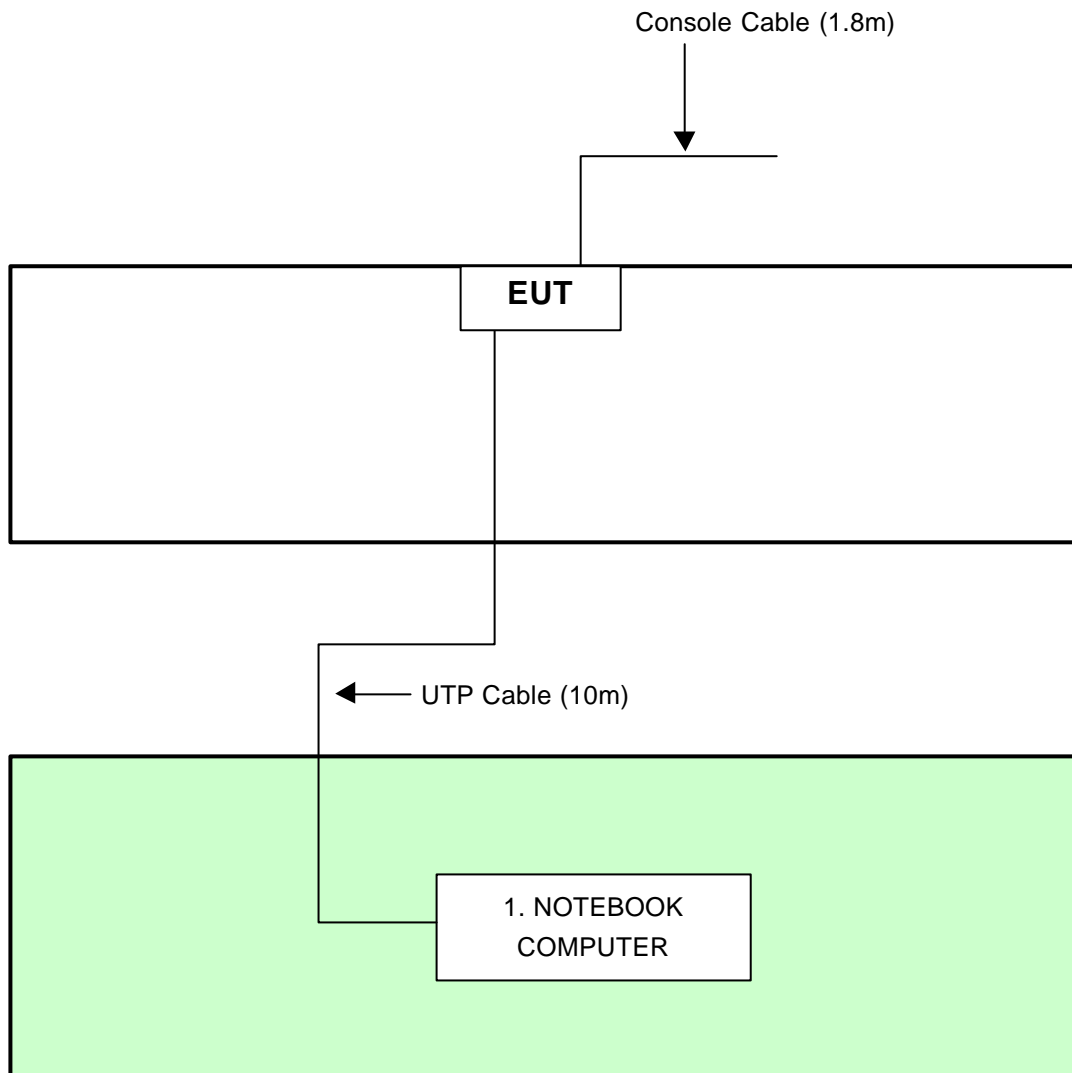

- NOTE:** 1. Support unit 1 was kept in the control room during the test.
2. Please refer to the photos of test configuration in Item 5 also.

WITH POE:

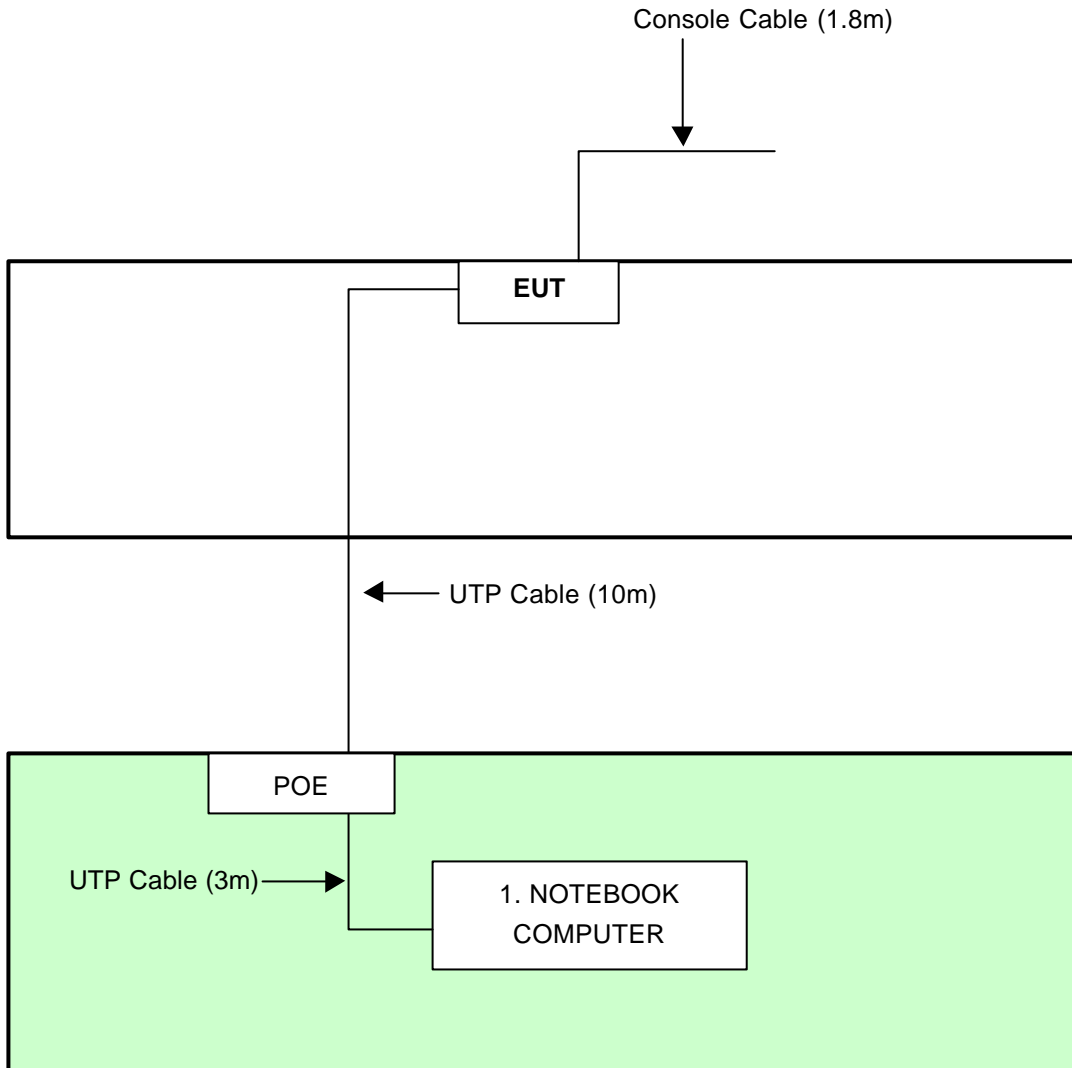

- NOTE:** 1. Support unit 1 was kept in the control room during the test.
2. Please refer to the photos of test configuration in Item 5 also.



4. TEST TYPES AND RESULTS (FOR PART 802.11b)

4.1 CONDUCTED EMISSION MEASUREMENT

4.1.1 LIMITS OF CONDUCTED EMISSION MEASUREMENT

FREQUENCY OF EMISSION (MHz)	CONDUCTED LIMIT (dB μ V)	
	Quasi-peak	Average
0.15-0.5	66 to 56	56 to 46
0.5-5	56	46
5-30	60	50

- NOTE:**
1. The lower limit shall apply at the transition frequencies.
 2. The limit decreases in line with the logarithm of the frequency in the range of 0.15 to 0.50 MHz.
 3. All emanations from a class A/B digital device or system, including any network of conductors and apparatus connected thereto, shall not exceed the level of field strengths specified above.

4.1.2 TEST INSTRUMENTS

DESCRIPTION & MANUFACTURER	MODEL NO.	SERIAL NO.	CALIBRATED UNTIL
ROHDE & SCHWARZ Test Receiver	ESCS 30	847124/029	Nov. 17, 2003
ROHDE & SCHWARZ LISN (for EUT)	ESHS-Z5	848773/004	Nov. 13, 2003
KYORITSU LISN (for peripheral)	KNW-407	8/1395/12	Jul. 23, 2003
RF Cable (JETBAO)	RG233/U	Cable_CA_01	Jul. 03, 2003
Terminator(for KYORITSU)	50	3	Apr. 11, 2003
Software	Cond-V2e	NA	NA

- NOTE:**
1. The calibration interval of the above test instruments is 12 months and the calibrations are traceable to NML/ROC and NIST/USA.
 2. The test was performed in ADT Shielded Room No. A.
 3. The VCCI Con A Registration No. is C-817.



4.1.3 TEST PROCEDURES

- a. The EUT was placed 0.4 meters from the conducting wall of the shielded room with EUT being connected to the power mains through a line impedance stabilization network (LISN). Other support units were connected to the power mains through another LISN. The two LISNs provide 50 ohm/ 50uH of coupling impedance for the measuring instrument.
- b. Both lines of the power mains connected to the EUT were checked for maximum conducted interference.
- c. The frequency range from 150 kHz to 30 MHz was searched. Emission levels over 10dB under the prescribed limits could not be reported

4.1.4 DEVIATION FROM TEST STANDARD

No deviation

4.1.5 TEST SETUP

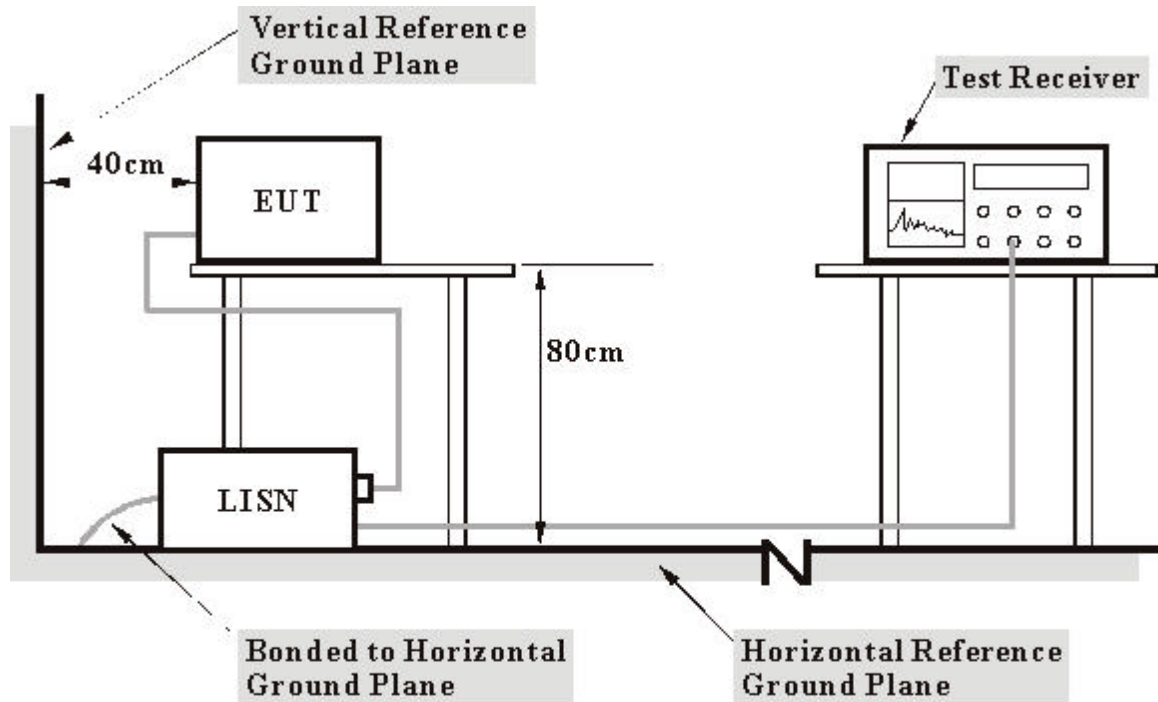

- Note:**
1. Support units were connected to second LISN.
 2. Both of LISNs (AMN) 80 cm from EUT and at the least 80 cm from other units and other metal planes support units.

For the actual test configuration, please refer to the related item – Photographs of the Test Configuration.

4.1.6 EUT OPERATING CONDITIONS

- a. Placed the EUT on the testing table.
- b. Prepared another computer system to act as a communication partner and placed it outside of testing area.
- c. The communication partner run a test program to enable EUT under transmission/receiving condition continuously at specific channel frequency via an RJ 45 cable and wireless.
- d. The communication partner sent data to EUT by command "PING".



4.1.7 TEST RESULTS

EUT	WLAN Access Point 2220	MODEL	WLAN Access Point 2220
MODE	Channel 1	6dB BANDWIDTH	9 kHz
INPUT POWER (SYSTEM)	120Vac, 60Hz	PHASE	Line (L)
ENVIRONMENTAL CONDITIONS	20deg. C, 60%RH, 976 hPa	TESTED BY	Mike Hsieh

No	Freq. [MHz]	Corr. Factor [dB]	Reading Value [dB (uV)]		Emission Level [dB (uV)]		Limit [dB (uV)]		Margin (dB)	
			Q.P.	AV.	Q.P.	AV.	Q.P.	AV.	Q.P.	AV.
			1	0.263	0.10	37.74	-	37.84	-	61.33
2	0.795	0.10	27.91	-	28.01	-	56.00	46.00	-27.99	-
3	1.056	0.10	34.12	-	34.22	-	56.00	46.00	-21.78	-
4	14.805	0.79	31.70	-	32.49	-	60.00	50.00	-27.51	-
5	21.664	1.07	32.89	-	33.96	-	60.00	50.00	-26.04	-
6	28.688	1.20	32.77	-	33.97	-	60.00	50.00	-26.03	-

- NOTES: (1) "***": Undetectable
 (2) Q.P. and AV. are abbreviations of quasi-peak and average.
 (3) "-": The Quasi-peak reading value also meets an average limit, thus measurement with the average detector is unnecessary.
 (4) The emission levels of other frequencies were very low against the limit.
 (5) Correction Factor = Insertion loss + Cable loss
 (6) Margin value = Emission level - Limit value

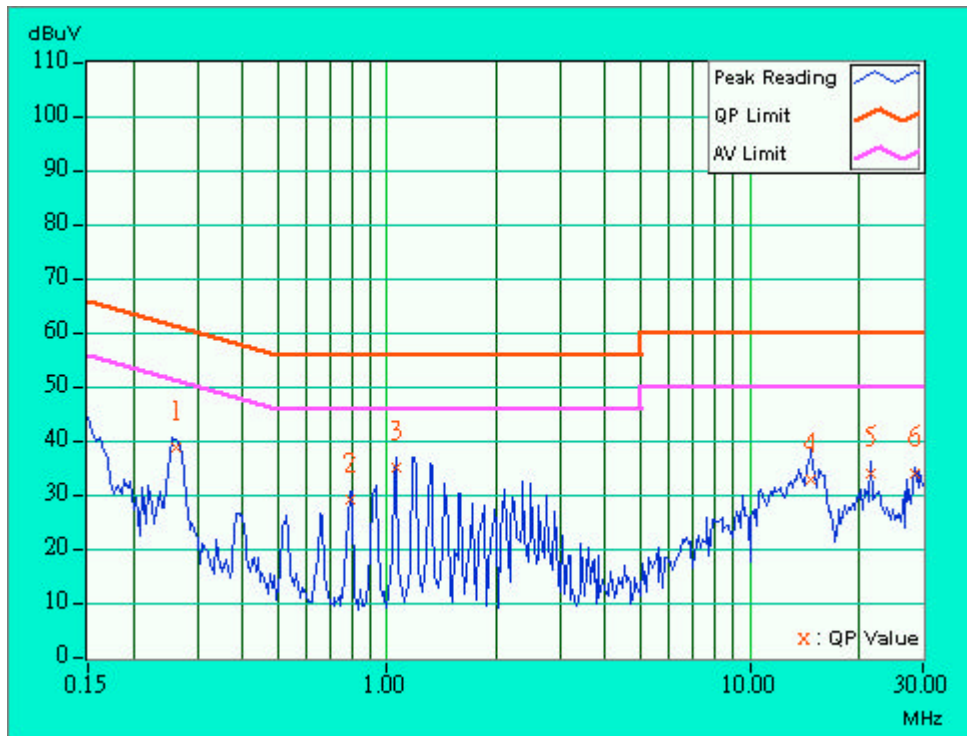



EUT	WLAN Access Point 2220	MODEL	WLAN Access Point 2220
MODE	Channel 1	6dB BANDWIDTH	9 kHz
INPUT POWER (SYSTEM)	120Vac, 60Hz	PHASE	Neutral (N)
ENVIRONMENTAL CONDITIONS	20deg. C, 60%RH, 976 hPa	TESTED BY	Mike Hsieh

No	Freq. [MHz]	Corr. Factor [dB]	Reading Value [dB (uV)]		Emission Level [dB (uV)]		Limit [dB (uV)]		Margin (dB)	
			Q.P.	AV.	Q.P.	AV.	Q.P.	AV.	Q.P.	AV.
			1	0.259	0.10	37.36	-	37.46	-	61.45
2	1.064	0.10	34.47	-	34.57	-	56.00	46.00	-21.43	-
3	2.490	0.12	28.19	-	28.31	-	56.00	46.00	-27.69	-
4	10.738	0.51	25.18	-	25.69	-	60.00	50.00	-34.31	-
5	14.816	0.60	32.35	-	32.95	-	60.00	50.00	-27.05	-
6	29.234	0.90	33.12	-	34.02	-	60.00	50.00	-25.98	-

- NOTES: (1) "***": Undetectable
 (2) Q.P. and AV. are abbreviations of quasi-peak and average.
 (3) "-": The Quasi-peak reading value also meets an average limit, thus measurement with the average detector is unnecessary.
 (4) The emission levels of other frequencies were very low against the limit.
 (5) Correction Factor = Insertion loss + Cable loss
 (6) Margin value = Emission level - Limit value

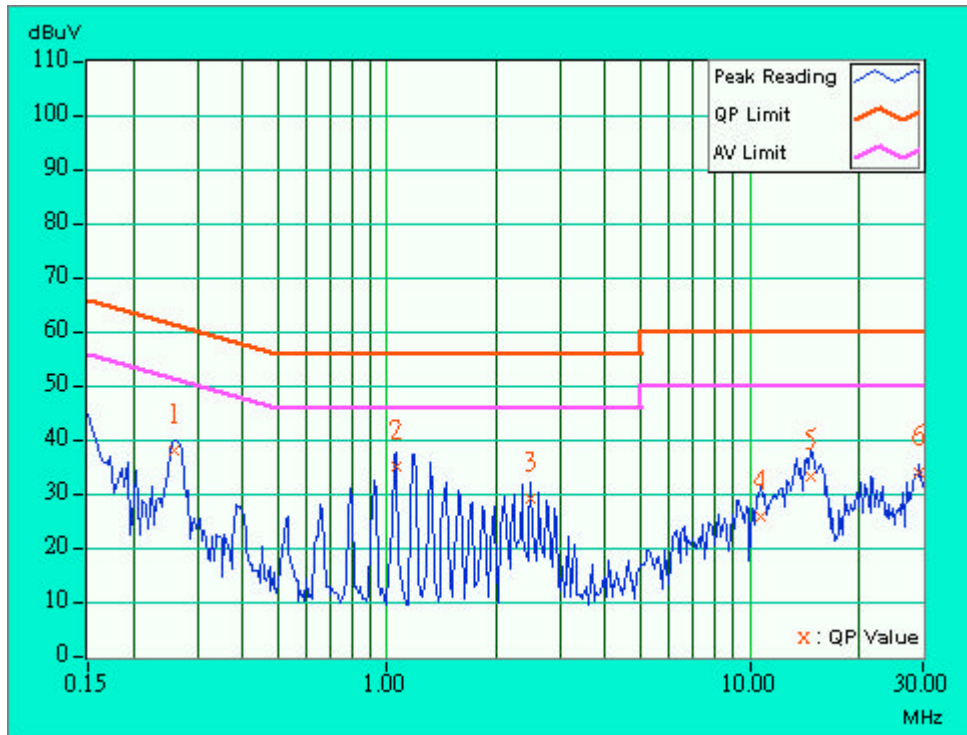



EUT	WLAN Access Point 2220	MODEL	WLAN Access Point 2220
MODE	Channel 6	6dB BANDWIDTH	9 kHz
INPUT POWER (SYSTEM)	120Vac, 60Hz	PHASE	Line (L)
ENVIRONMENTAL CONDITIONS	20deg. C, 60%RH, 976 hPa	TESTED BY	Mike Hsieh

No	Freq. [MHz]	Corr. Factor (dB)	Reading Value [dB (uV)]		Emission Level [dB (uV)]		Limit [dB (uV)]		Margin (dB)	
			Q.P.	AV.	Q.P.	AV.	Q.P.	AV.	Q.P.	AV.
			1	0.259	0.10	38.12	-	38.22	-	61.45
2	1.060	0.10	34.72	-	34.82	-	56.00	46.00	-21.18	-
3	1.591	0.10	27.63	-	27.73	-	56.00	46.00	-28.27	-
4	2.377	0.12	28.71	-	28.83	-	56.00	46.00	-27.17	-
5	14.684	0.79	30.85	-	31.64	-	60.00	50.00	-28.36	-
6	29.234	1.20	32.96	-	34.16	-	60.00	50.00	-25.84	-

- NOTES: (1) "": Undetectable
 (2) Q.P. and AV. are abbreviations of quasi-peak and average.
 (3) "-": The Quasi-peak reading value also meets an average limit, thus measurement with the average detector is unnecessary.
 (4) The emission levels of other frequencies were very low against the limit.
 (5) Correction Factor = Insertion loss + Cable loss
 (6) Margin value = Emission level - Limit value

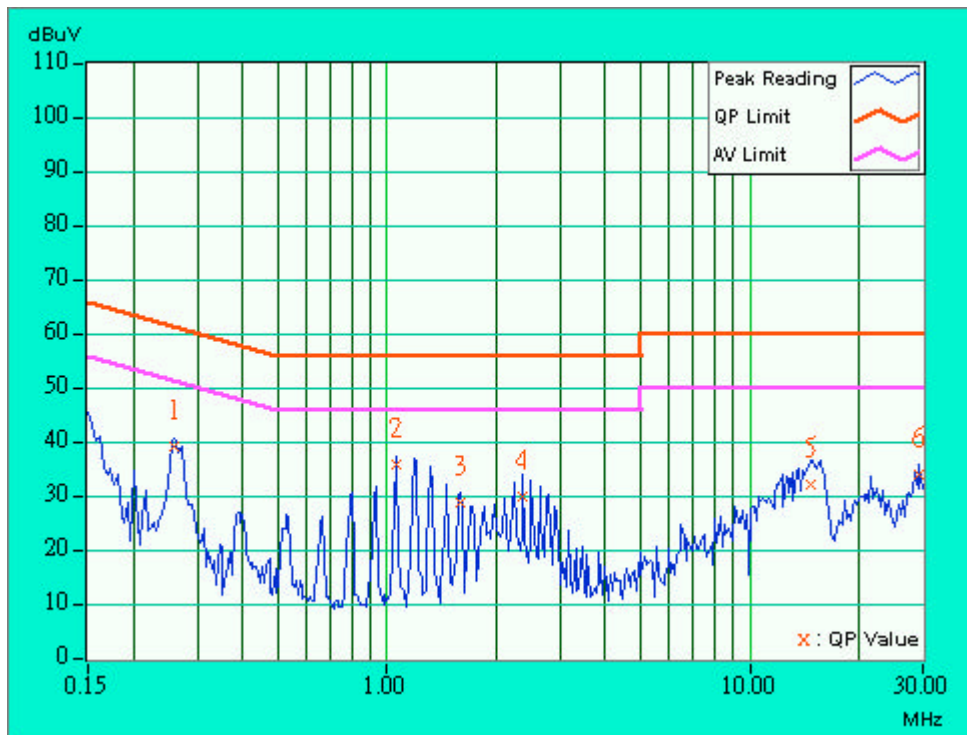



EUT	WLAN Access Point 2220	MODEL	WLAN Access Point 2220
MODE	Channel 6	6dB BANDWIDTH	9 kHz
INPUT POWER (SYSTEM)	120Vac, 60Hz	PHASE	Neutral (N)
ENVIRONMENTAL CONDITIONS	20deg. C, 60%RH, 976 hPa	TESTED BY	Mike Hsieh

No	Freq. [MHz]	Corr. Factor [dB]	Reading Value [dB (uV)]		Emission Level [dB (uV)]		Limit [dB (uV)]		Margin (dB)	
			Q.P.	AV.	Q.P.	AV.	Q.P.	AV.	Q.P.	AV.
			1	0.150	0.10	36.40	-	36.50	-	66.00
2	0.267	0.10	37.50	-	37.60	-	61.20	51.20	-23.60	-
3	1.193	0.10	34.21	-	34.31	-	56.00	46.00	-21.69	-
4	2.365	0.12	26.25	-	26.37	-	56.00	46.00	-29.63	-
5	14.742	0.59	31.20	-	31.79	-	60.00	50.00	-28.21	-
6	28.688	0.90	32.87	-	33.77	-	60.00	50.00	-26.23	-

- NOTES: (1) "***": Undetectable
 (2) Q.P. and AV. are abbreviations of quasi-peak and average.
 (3) "-": The Quasi-peak reading value also meets an average limit, thus measurement with the average detector is unnecessary.
 (4) The emission levels of other frequencies were very low against the limit.
 (5) Correction Factor = Insertion loss + Cable loss
 (6) Margin value = Emission level - Limit value

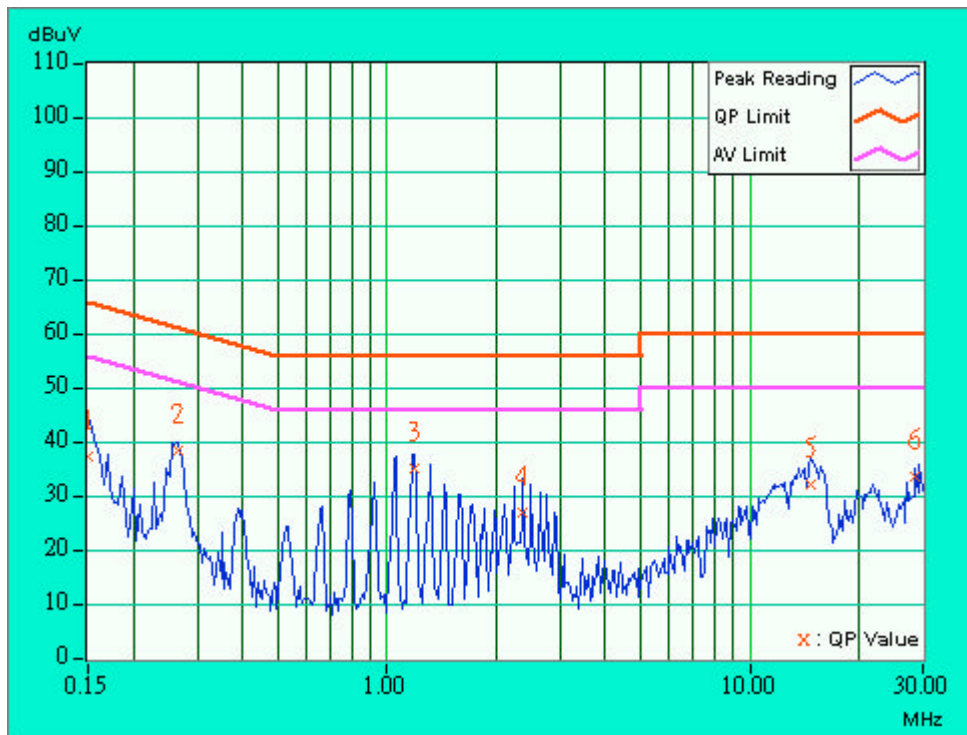



EUT	WLAN Access Point 2220	MODEL	WLAN Access Point 2220
MODE	Channel 11	6dB BANDWIDTH	9 kHz
INPUT POWER (SYSTEM)	120Vac, 60Hz	PHASE	Line (L)
ENVIRONMENTAL CONDITIONS	20deg. C, 60%RH, 976 hPa	TESTED BY	Mike Hsieh

No	Freq. [MHz]	Corr. Factor [dB]	Reading Value [dB (uV)]		Emission Level [dB (uV)]		Limit [dB (uV)]		Margin (dB)	
			Q.P.	AV.	Q.P.	AV.	Q.P.	AV.	Q.P.	AV.
			1	0.259	0.10	38.12	-	38.22	-	61.45
2	1.193	0.10	34.50	-	34.60	-	56.00	46.00	-21.40	-
3	2.365	0.12	20.09	-	20.21	-	56.00	46.00	-35.79	-
4	14.578	0.78	30.18	-	30.96	-	60.00	50.00	-29.04	-
5	21.664	1.07	32.83	-	33.90	-	60.00	50.00	-26.10	-
6	28.688	1.20	32.73	-	33.93	-	60.00	50.00	-26.07	-

- NOTES: (1) "***": Undetectable
 (2) Q.P. and AV. are abbreviations of quasi-peak and average.
 (3) "-": The Quasi-peak reading value also meets an average limit, thus measurement with the average detector is unnecessary.
 (4) The emission levels of other frequencies were very low against the limit.
 (5) Correction Factor = Insertion loss + Cable loss
 (6) Margin value = Emission level - Limit value

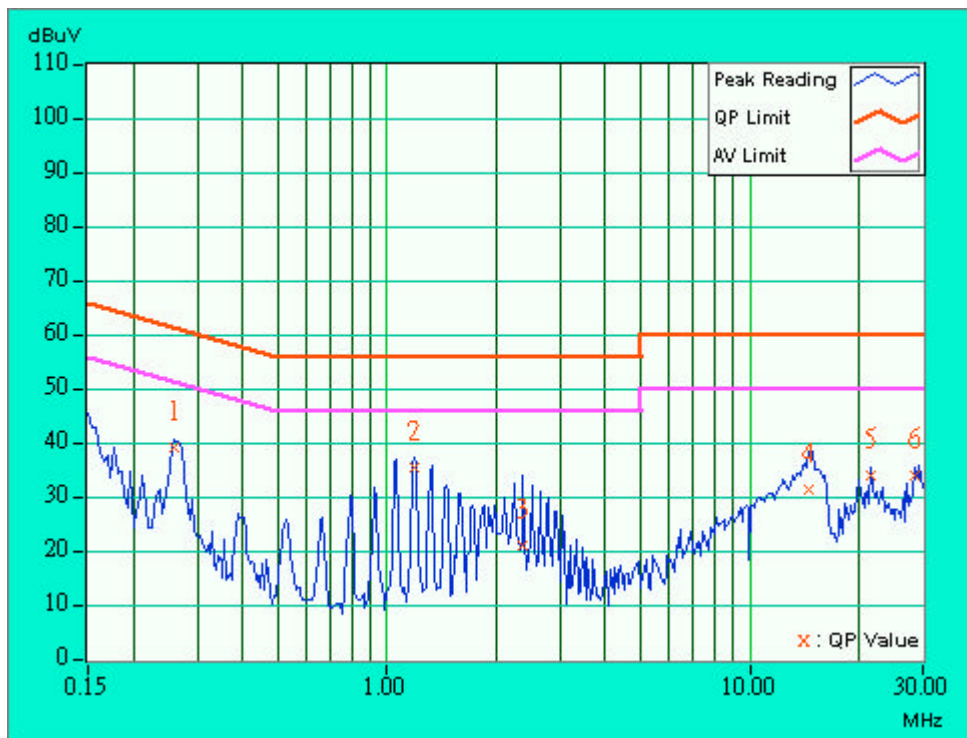



EUT	WLAN Access Point 2220	MODEL	WLAN Access Point 2220
MODE	Channel 11	6dB BANDWIDTH	9 kHz
INPUT POWER (SYSTEM)	120Vac, 60Hz	PHASE	Neutral (N)
ENVIRONMENTAL CONDITIONS	20deg. C, 60%RH, 976 hPa	TESTED BY	Mike Hsieh

No	Freq. [MHz]	Corr. Factor (dB)	Reading Value [dB (uV)]		Emission Level [dB (uV)]		Limit [dB (uV)]		Margin (dB)	
			Q.P.	AV.	Q.P.	AV.	Q.P.	AV.	Q.P.	AV.
			1	0.267	0.10	37.72	-	37.82	-	61.20
2	1.189	0.10	34.32	-	34.42	-	56.00	46.00	-21.58	-
3	2.365	0.12	27.77	-	27.89	-	56.00	46.00	-28.11	-
4	15.633	0.61	29.35	-	29.96	-	60.00	50.00	-30.04	-
5	21.664	0.77	32.91	-	33.68	-	60.00	50.00	-26.32	-
6	28.688	0.90	32.83	-	33.73	-	60.00	50.00	-26.27	-

- NOTES: (1) "": Undetectable
 (2) Q.P. and AV. are abbreviations of quasi-peak and average.
 (3) "-": The Quasi-peak reading value also meets an average limit, thus measurement with the average detector is unnecessary.
 (4) The emission levels of other frequencies were very low against the limit.
 (5) Correction Factor = Insertion loss + Cable loss
 (6) Margin value = Emission level - Limit value

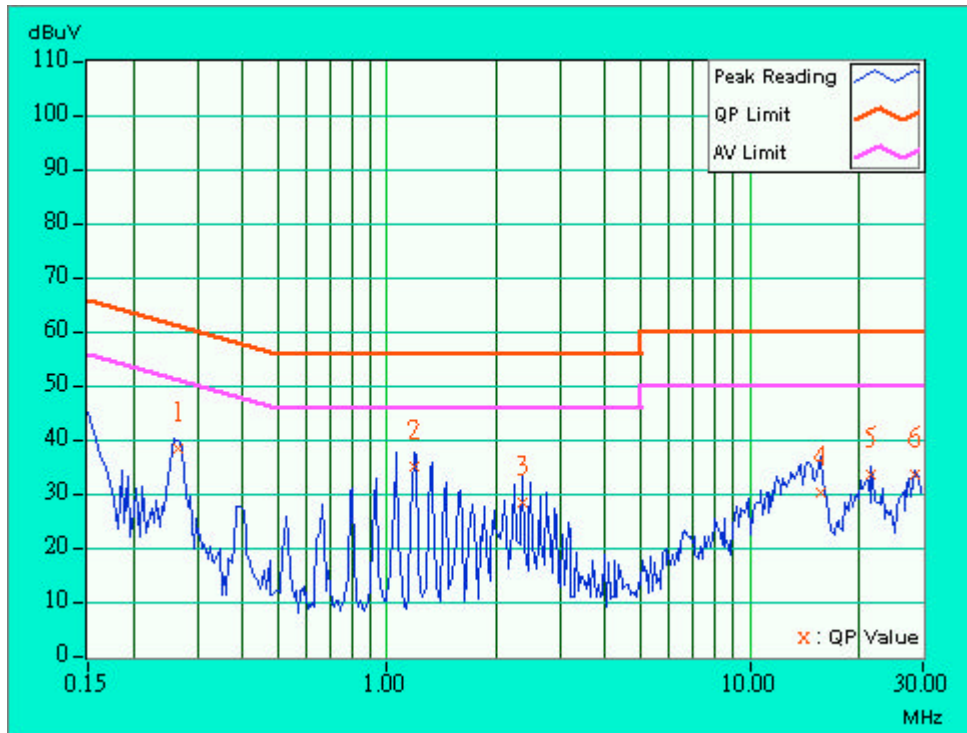



4.2 RADIATED EMISSION MEASUREMENT

4.2.1 LIMITS OF RADIATED EMISSION MEASUREMENT

Emissions radiated outside of the specified bands, shall be according to the general radiated limits in 15.209 as following:

Frequencies (MHz)	Field strength (microvolts/meter)	Measurement distance (meters)
0.009-0.490	2400/F(kHz)	300
0.490-1.705	24000/F(kHz)	30
1.705-30.0	30	30
30-88	100	3
88-216	150	3
216-960	200	3
Above 960	500	3

NOTE

1. The lower limit shall apply at the transition frequencies.
2. Emission level (dBuV/m) = 20 log Emission level (uV/m).
3. As shown in 15.35(b), for frequencies above 1000MHz, the field strength limits are based on average detector, however, the peak field strength of any emission shall not exceed the maximum permitted average limits, specified above by more than 20dB under any condition of modulation.



4.2.2 TEST INSTRUMENTS

DESCRIPTION & MANUFACTURER	MODEL NO.	SERIAL NO.	CALIBRATED UNTIL
HP Spectrum Analyzer	8594ER	3829U04676	Jul. 14, 2003
ADVANTEST Spectrum Analyzer	R3271A	85060311	May 21, 2003
CHASE RF Pre_Amplifier	CPA9232	1057	Apr. 24, 2003
HP Pre_Amplifier	8449B	3008A01281	June 27, 2003
ROHDE & SCHWARZ Test Receiver	ESVS 10	849231 /019	Nov. 03, 2003
CHASE Broadband Antenna	CBL6111c	2730	Jul 17, 2003
Schwarzbeck Horn_Antenna	BBHA9120-D1	D123	Jul. 31, 2003
SCHWARZBECK Tunable Dipole Antenna	UHAP	897	Mar. 07, 2005
SCHWARZBECK Tunable Dipole Antenna	VHAP	880	Mar. 07, 2005
RF Switches (ARNITSU)	CS-201	1565157	Jul. 29, 2003
RF CABLE (Chaintek) 1GHz-20GHz	Ak 9515-D	001	Aug. 20.2003
RF Cable(RICHTEC)	9913-30M	STCCAB-30M- 1GHz-021	Nov. 5, 2003
Software	AS60P8	NA	NA
CHANCE MOST Antenna Tower	AT-100	0203	NA
CHANCE MOST Turn Table	TT-100	0203	NA

Note: 1. The calibration interval of the above test instruments is 12 months and the calibrations are traceable to NML/ROC and NIST/USA.

2. * = These equipment are used for the final measurement.

3. The horn antenna and HP preamplifier (model: 8449B) are used only for the measurement of emission frequency above 1GHz if tested.

4. The test was performed in ADT Open Site No. C.

5. The FCC Site Registration No. is 656396.

6. The VCCI Site Registration No. is R-1626.



4.2.3 TEST PROCEDURES

- a. The EUT was placed on the top of a rotating table 0.8 meters above the ground at a 10 meter open area test site. The table was rotated 360 degrees to determine the position of the highest radiation.
- b. The EUT was set 3 meters away from the interference-receiving antenna, which was mounted on the top of a variable-height antenna tower.
- c. The antenna is a broadband antenna, and its height is varied from one meter to four meters above the ground to determine the maximum value of the field strength. Both horizontal and vertical polarizations of the antenna are set to make the measurement.
- d. For each suspected emission, the EUT was arranged to its worst case and then the antenna was tuned to heights from 1 meter to 4 meters and the rotatable table was turned from 0 degrees to 360 degrees to find the maximum reading.
- e. The test-receiver system was set to Peak Detect Function and Specified Bandwidth with Maximum Hold Mode.
- f. If the emission level of the EUT in peak mode was 10 dB lower than the limit specified, then testing could be stopped and the peak values of the EUT would be reported. Otherwise the emissions that did not have 10 dB margin would be re-tested one by one using the quasi-peak method or average method as specified and then reported in Data sheet peak mode and QP mode.

NOTE:

1. The resolution bandwidth and video bandwidth of test receiver/spectrum analyzer is 120kHz for Quasi-peak detection at frequency below 1GHz.
2. The resolution bandwidth and video bandwidth of test receiver/spectrum analyzer is 1 MHz for Peak detection (PK) at frequency above 1GHz.
3. The resolution bandwidth of test receiver/spectrum analyzer is 1 MHz and the video bandwidth is 300 Hz for Average detection (AV) at frequency above 1GHz.

4.2.4 DEVIATION FROM TEST STANDARD

No deviation

4.2.5 TEST SETUP

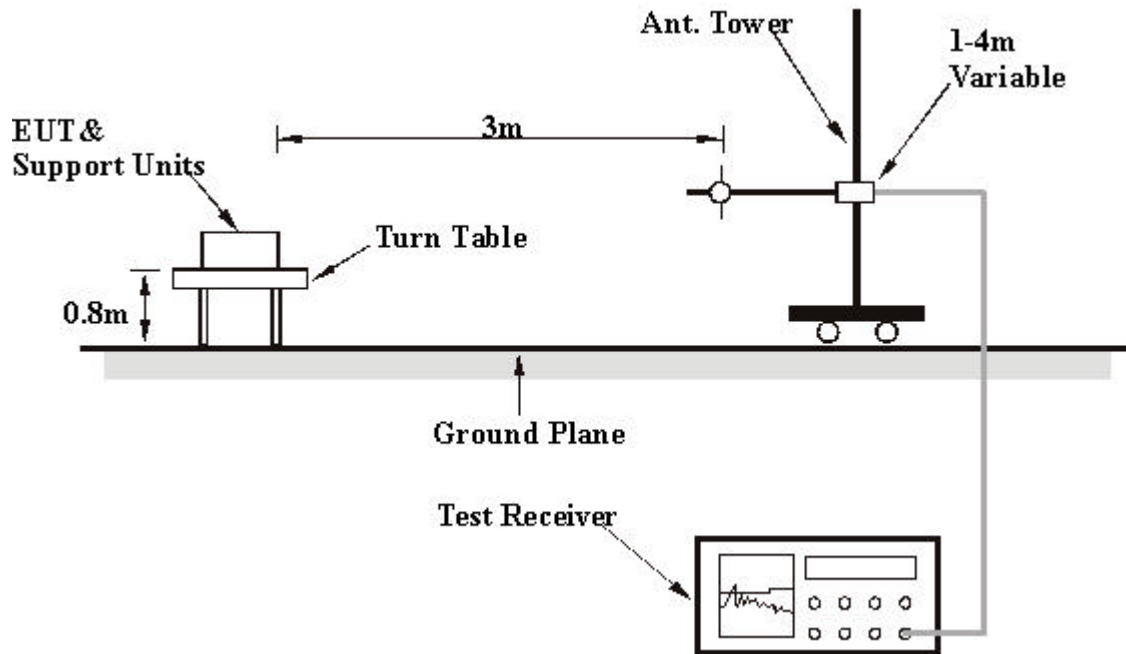

For the actual test configuration, please refer to the related item – Photographs of the Test Configuration.

4.2.6 EUT OPERATING CONDITIONS

Same as 4.1.6



4.2.7 TEST RESULTS

EUT	WLAN Access Point 2220	MODEL	WLAN Access Point 2220
MODE	With Adapter, Channel 11	FREQUENCY RANGE	Below 1000 MHz
INPUT POWER (SYSTEM)	120Vac, 60Hz	DETECTOR FUNCTION	Quasi-Peak
ENVIRONMENTAL CONDITIONS	19deg. C, 78%RH, 976 hPa	TESTED BY	Eric Lee

ANTENNA POLARITY & TEST DISTANCE: HORIZONTAL AT 3 M

No.	Freq. (MHz)	Emission Level (dBuV/m)	Limit (dBuV/m)	Margin (dB)	Antenna Height (m)	Table Angle (Degree)	Raw Value (dBuV)	Correction Factor (dB/m)
1	125.10	25.6 QP	43.50	-17.90	1.25 H	0	13.40	12.10
2	250.02	36.3 QP	46.00	-9.70	1.00 H	73	23.10	13.20
3	350.03	28.0 QP	46.00	-18.00	1.00 H	23	12.40	15.60
4	352.00	31.2 QP	46.00	-14.80	1.04 H	14	15.60	15.60
5	374.99	28.1 QP	46.00	-17.90	1.04 H	14	11.90	16.20
6	400.03	32.8 QP	46.00	-13.20	1.17 H	0	15.80	17.00
7	500.00	30.1 QP	46.00	-15.90	1.38 H	23	10.80	19.30
8	800.06	33.1 QP	46.00	-12.90	1.41 H	97	9.60	23.50
9	850.07	31.2 QP	46.00	-14.80	1.43 H	37	6.10	25.10

ANTENNA POLARITY & TEST DISTANCE: VERTICAL AT 3 M

No.	Freq. (MHz)	Emission Level (dBuV/m)	Limit (dBuV/m)	Margin (dB)	Antenna Height (m)	Table Angle (Degree)	Raw Value (dBuV)	Correction Factor (dB/m)
1	125.01	30.0 QP	43.50	-13.50	1.00 V	337	17.80	12.10
2	250.02	28.9 QP	46.00	-17.10	1.00 V	0	15.70	13.20
3	350.03	25.2 QP	46.00	-20.80	1.66 V	252	9.70	15.60
4	352.00	32.7 QP	46.00	-13.30	1.26 V	51	17.10	15.60
5	400.03	33.9 QP	46.00	-12.10	1.11 V	345	16.90	17.00
6	475.01	29.8 QP	46.00	-16.20	1.00 V	0	11.00	18.80
7	500.03	31.1 QP	46.00	-14.90	1.17 V	17	11.80	19.30
8	600.04	30.8 QP	46.00	-15.20	1.00 V	29	9.90	20.90
9	800.06	32.0 QP	46.00	-14.00	1.22 V	0	8.50	23.50
10	850.06	31.3 QP	46.00	-14.70	1.00 V	93	6.20	25.10

- REMARKS:**
1. Emission level(dBuV/m)=Raw Value(dBuV) + Correction Factor(dB)
 2. Correction Factor(dB/m) = Antenna Factor (dB/m) + Cable Factor (dB)
 3. The other emission levels were very low against the limit.
 4. Margin value = Emission level – Limit value.
 5. The limit value is defined as per 15.247



EUT	WLAN Access Point 2220	MODEL	WLAN Access Point 2220
MODE	With POE, Channel 11	FREQUENCY RANGE	Below 1000 MHz
INPUT POWER (SYSTEM)	120Vac, 60Hz	DETECTOR FUNCTION	Quasi-Peak
ENVIRONMENTAL CONDITIONS	19deg. C, 78%RH, 976 hPa	TESTED BY	Eric Lee

ANTENNA POLARITY & TEST DISTANCE: HORIZONTAL AT 3 M

No.	Freq. (MHz)	Emission Level (dBuV/m)	Limit (dBuV/m)	Margin (dB)	Antenna Height (m)	Table Angle (Degree)	Raw Value (dBuV)	Correction Factor (dB/m)
1	64.78	27.7 QP	40.00	-12.30	2.86 H	142	22.50	5.20
2	250.01	25.7 QP	46.00	-20.30	1.72 H	184	12.70	13.00
3	320.00	23.0 QP	46.00	-23.00	1.70 H	208	8.50	14.60
4	500.00	26.2 QP	46.00	-19.80	2.08 H	237	6.90	19.30
5	512.00	26.3 QP	46.00	-19.70	1.00 H	216	6.90	19.40
6	544.00	29.2 QP	46.00	-16.80	1.00 H	258	8.40	20.80
7	640.00	33.2 QP	46.00	-12.80	1.66 H	245	11.40	21.90
8	704.00	31.6 QP	46.00	-14.40	1.69 H	219	9.00	22.60
9	768.00	34.5 QP	46.00	-11.50	1.47 H	226	10.60	23.90
10	800.00	33.0 QP	46.00	-13.00	1.35 H	218	9.30	23.70

ANTENNA POLARITY & TEST DISTANCE: VERTICAL AT 3 M

No.	Freq. (MHz)	Emission Level (dBuV/m)	Limit (dBuV/m)	Margin (dB)	Antenna Height (m)	Table Angle (Degree)	Raw Value (dBuV)	Correction Factor (dB/m)
1	32.60	34.9 QP	40.00	-5.10	1.75 V	172	17.10	17.80
2	43.77	35.2 QP	40.00	-4.80	1.43 V	122	23.40	11.90
3	49.06	32.2 QP	40.00	-7.80	1.06 V	253	23.20	9.00
4	111.59	29.8 QP	43.50	-13.70	1.23 V	252	18.70	11.10
5	250.01	29.3 QP	46.00	-16.70	1.10 V	195	16.30	13.00
6	500.00	30.8 QP	46.00	-15.20	1.00 V	277	11.50	19.30
7	640.00	33.4 QP	46.00	-12.60	1.90 V	160	11.50	21.90
8	704.00	31.6 QP	46.00	-14.40	1.99 V	149	9.00	22.60
9	768.00	33.3 QP	46.00	-12.70	2.10 V	150	9.50	23.90
10	800.00	32.4 QP	46.00	-13.60	1.66 V	151	8.70	23.70

- REMARKS:**
1. Emission level(dBuV/m)=Raw Value(dBuV) + Correction Factor(dB)
 2. Correction Factor(dB/m) = Antenna Factor (dB/m) + Cable Factor (dB)
 3. The other emission levels were very low against the limit.
 4. Margin value = Emission level – Limit value.
 5. The limit value is defined as per 15.247



EUT	WLAN Access Point 2220	MODEL	WLAN Access Point 2220
MODE	Channel 1	FREQUENCY RANGE	Above 1000 MHz
INPUT POWER (SYSTEM)	120Vac, 60Hz	DETECTOR FUNCTION	Peak(PK) Average (AV)
ENVIRONMENTAL CONDITIONS	17deg. C, 68%RH, 976 hPa	TESTED BY	Eric Lee

ANTENNA POLARITY & TEST DISTANCE: HORIZONTAL AT 3 M								
No.	Freq. (MHz)	Emission Level (dBuV/m)	Limit (dBuV/m)	Margin (dB)	Antenna Height (m)	Table Angle (Degree)	Raw Value (dBuV)	Correction Factor (dB/m)
1	2038.00	45.6 PK	74.00	-28.40	1.71 H	165	16.80	28.80
2	2376.00	42.3 PK	74.00	-31.70	1.62 H	300	12.60	29.70
3	*2412.00	100.6 PK			1.51 H	108	70.70	29.90
3	*2412.00	92.7 AV			1.51 H	108	62.80	28.80
4	4076.00	37.0 PK	74.00	-37.00	1.58 H	245	3.00	34.00
5	4824.00	34.2 PK	74.00	-39.80	1.69 H	25	-2.00	36.20

ANTENNA POLARITY & TEST DISTANCE: VERTICAL AT 3 M								
No.	Freq. (MHz)	Emission Level (dBuV/m)	Limit (dBuV/m)	Margin (dB)	Antenna Height (m)	Table Angle (Degree)	Raw Value (dBuV)	Correction Factor (dB/m)
1	2038.00	48.2 PK	74.00	-25.80	1.60 V	162	19.40	28.80
2	2376.00	42.9 PK	74.00	-31.10	1.00 V	20	13.20	29.70
3	*2412.00	111.0 PK			1.31 V	349	81.10	29.90
3	*2412.00	102.9 AV			1.31 V	349	73.00	28.80
4	4076.00	48.0 PK	74.00	-26.00	1.35 V	238	14.00	34.00
5	4824.00	35.2 PK	74.00	-38.80	1.20 V	360	-1.00	36.20

- NOTE:**
1. Emission level = Raw Value - Correction Factor
 2. Correction Factor = External Preamp. Gain - Ant. Factor - Cable loss
(External Preamp. Gain = 0, when the test receiver is used for the test.)
 3. The other emission levels were very low against the limit.
 4. Margin value = Emission level - Limit value
 5. The limit value is defined as per 15.247
 6. " * " : Fundamental frequency



EUT	WLAN Access Point 2220	MODEL	WLAN Access Point 2220
MODE	Channel 6	FREQUENCY RANGE	Above 1000 MHz
INPUT POWER (SYSTEM)	120Vac, 60Hz	DETECTOR FUNCTION	Peak(PK) Average (AV)
ENVIRONMENTAL CONDITIONS	17deg. C, 68%RH, 976 hPa	TESTED BY	Eric Lee

ANTENNA POLARITY & TEST DISTANCE: HORIZONTAL AT 3 M								
No.	Freq. (MHz)	Emission Level (dBuV/m)	Limit (dBuV/m)	Margin (dB)	Antenna Height (m)	Table Angle (Degree)	Raw Value (dBuV)	Correction Factor (dB/m)
1	2063.00	45.4 PK	74.00	-28.60	1.46 H	359	16.50	28.90
2	2380.00	43.8 PK	74.00	-30.20	1.62 H	77	14.10	29.70
3	*2437.00	103.1 PK			1.22 H	314	73.10	30.00
3	*2437.00	95.3 AV			1.22 H	314	65.30	28.90
4	4126.00	39.1 PK	74.00	-34.90	1.65 H	269	5.00	34.10
5	4874.00	33.9 PK	74.00	-40.10	1.47 H	24	-2.60	36.50

ANTENNA POLARITY & TEST DISTANCE: VERTICAL AT 3 M								
No.	Freq. (MHz)	Emission Level (dBuV/m)	Limit (dBuV/m)	Margin (dB)	Antenna Height (m)	Table Angle (Degree)	Raw Value (dBuV)	Correction Factor (dB/m)
1	2063.00	53.1 PK	74.00	-20.90	1.08 V	36	24.20	28.90
1	2063.00	44.0 AV	54.00	-10.00	1.08 V	36	15.10	28.90
2	2377.00	43.1 PK	74.00	-30.90	1.32 V	46	13.40	29.70
3	*2437.00	109.9 PK			1.73 V	26	79.90	30.00
3	*2437.00	102.2 AV			1.73 V	26	72.20	29.70
4	4126.00	50.9 PK	74.00	-23.10	1.46 V	321	16.80	34.10
5	4874.00	35.5 PK	74.00	-38.50	1.22 V	357	-1.00	36.50

- NOTE:**
1. Emission level = Raw Value - Correction Factor
 2. Correction Factor = External Preamp. Gain - Ant. Factor - Cable loss
(External Preamp. Gain = 0, when the test receiver is used for the test.)
 3. The other emission levels were very low against the limit.
 4. Margin value = Emission level - Limit value
 5. The limit value is defined as per 15.247
 6. " * " : Fundamental frequency



EUT	WLAN Access Point 2220	MODEL	WLAN Access Point 2220
MODE	Channel 11	FREQUENCY RANGE	Above 1000 MHz
INPUT POWER (SYSTEM)	120Vac, 60Hz	DETECTOR FUNCTION	Peak(PK) Average (AV)
ENVIRONMENTAL CONDITIONS	17deg. C, 68%RH, 976 hPa	TESTED BY	Eric Lee

ANTENNA POLARITY & TEST DISTANCE: HORIZONTAL AT 3M								
No.	Freq. (MHz)	Emission Level (dBuV/m)	Limit (dBuV/m)	Margin (dB)	Antenna Height (m)	Table Angle (Degree)	Raw Value (dBuV)	Correction Factor (dB/m)
1	2088.00	44.9 PK	74.00	-29.10	1.17 H	38	15.90	29.00
2	*2462.00	103.2 PK			1.26 H	311	73.20	30.10
2	*2462.00	96.2 AV			1.26 H	311	66.20	29.00
3	2488.00	43.1 PK	74.00	-30.90	1.49 H	50	13.00	30.10
4	4176.00	37.5 PK	74.00	-36.50	1.65 H	24	3.30	34.20
5	4924.00	34.2 PK	74.00	-39.80	1.22 H	54	-2.50	36.70

ANTENNA POLARITY & TEST DISTANCE: VERTICAL AT 3M								
No.	Freq. (MHz)	Emission Level (dBuV/m)	Limit (dBuV/m)	Margin (dB)	Antenna Height (m)	Table Angle (Degree)	Raw Value (dBuV)	Correction Factor (dB/m)
1	2088.00	48.1 PK	74.00	-25.90	1.07 V	142	19.10	29.00
2	*2462.00	111.1 PK			1.05 V	59	81.00	30.10
2	*2462.00	103.1 AV			1.05 V	59	73.00	29.00
3	2488.00	44.7 PK	74.00	-29.30	1.62 V	300	14.60	30.10
4	4176.00	49.3 PK	74.00	-24.70	1.73 V	60	15.10	34.20
5	4924.00	35.2 PK	74.00	-38.80	1.33 V	265	-1.50	36.70

- NOTE:**
1. Emission level= Raw Value - Correction Factor
 2. Correction Factor = External Preamp. Gain - Ant. Factor - Cable loss
(External Preamp. Gain = 0, when the test receiver is used for the test.)
 3. The other emission levels were very low against the limit.
 4. Margin value = Emission level - Limit value
 5. The limit value is defined as per 15.247
 6. " * " : Fundamental frequency



4.3 6dB BANDWIDTH MEASUREMENT

4.3.1 LIMITS OF 6dB BANDWIDTH MEASUREMENT

The minimum of 6dB Bandwidth Measurement is 0.5 MHz.

4.3.2 TEST INSTRUMENTS

Description & Manufacturer	Model No.	Serial No.	Calibrated Until
R&S SPECTRUM ANALYZER	FSP	1093.4495.30	Dec. 19, 2003

NOTE:

- 1.The measurement uncertainty is less than +/- 2.6dB, which is calculated as per the NAMAS document NIS81.
- 2.The calibration interval of the above test instruments is 12 months and the calibrations are traceable to NML/ROC and NIST/USA.

4.3.3 TEST PROCEDURE

The transmitter output was connected to the spectrum analyzer through an attenuator. The bandwidth of the fundamental frequency was measured by spectrum analyzer with 100kHz RBW and 100kHz VBW. The 6dB bandwidth is defined as the total spectrum the power of which is higher than peak power minus 6 dB.

4.3.4 DEVIATION FROM TEST STANDARD

No deviation

4.3.5 TEST SETUP

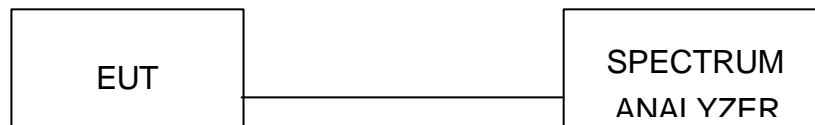

4.3.6 EUT OPERATING CONDITIONS

The software provided by client to enable the EUT under transmission condition continuously at lowest, middle and highest channel frequencies individually.



4.3.7 TEST RESULTS

EUT	WLAN Access Point 2220	MODEL	WLAN Access Point 2220
INPUT POWER (SYSTEM)	120Vac, 60Hz	ENVIRONMENTAL CONDITIONS	19deg. C, 64%RH, 976 hPa
TESTED BY	Hank Chung		

CHANNEL	CHANNEL FREQUENCY (MHz)	6dB BANDWIDTH (MHz)	MINIMUM LIMIT (MHz)	PASS/FAIL
1	2412	10.32	0.5	PASS
6	2437	10.76	0.5	PASS
11	2462	10.16	0.5	PASS



CH1

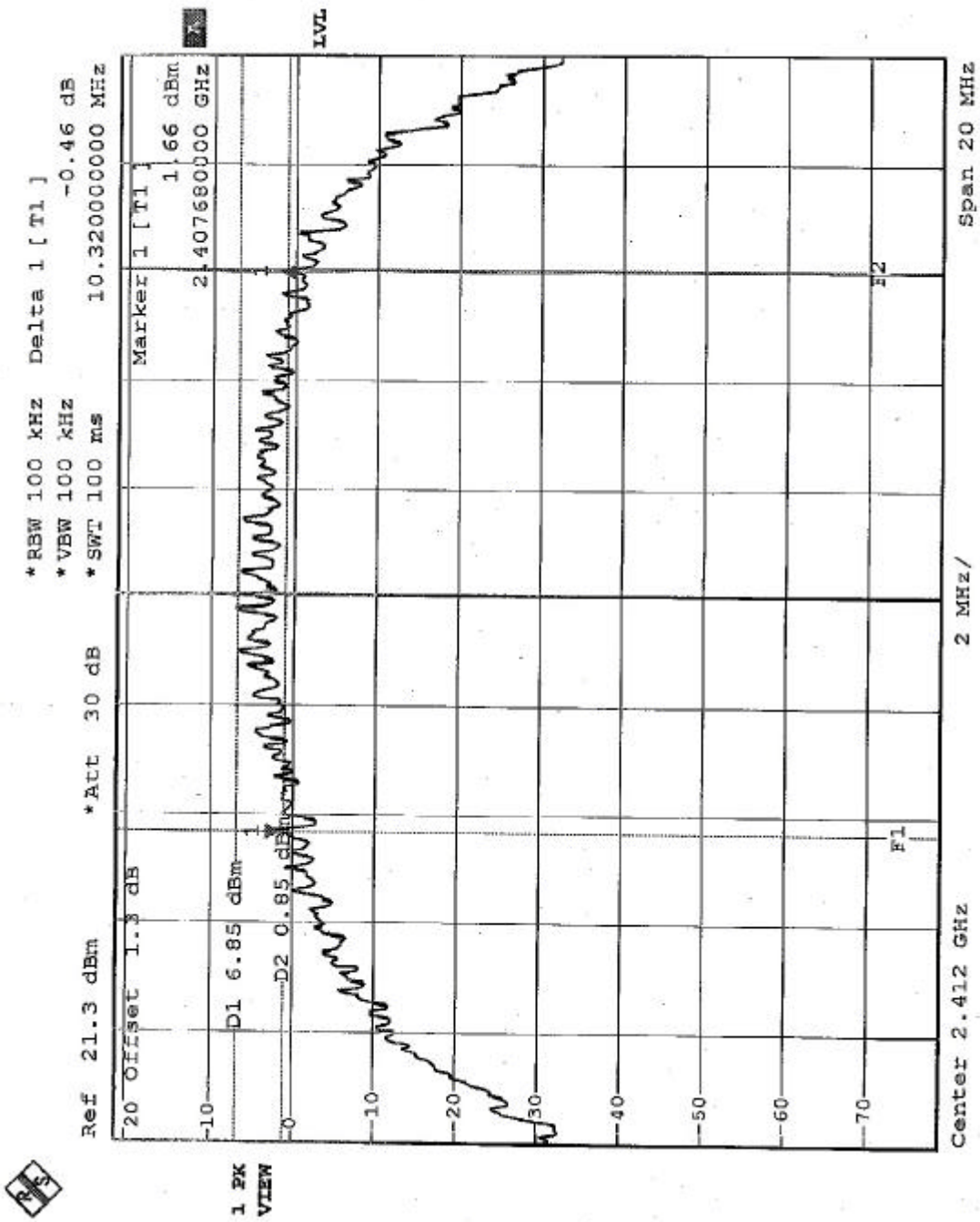



CH6

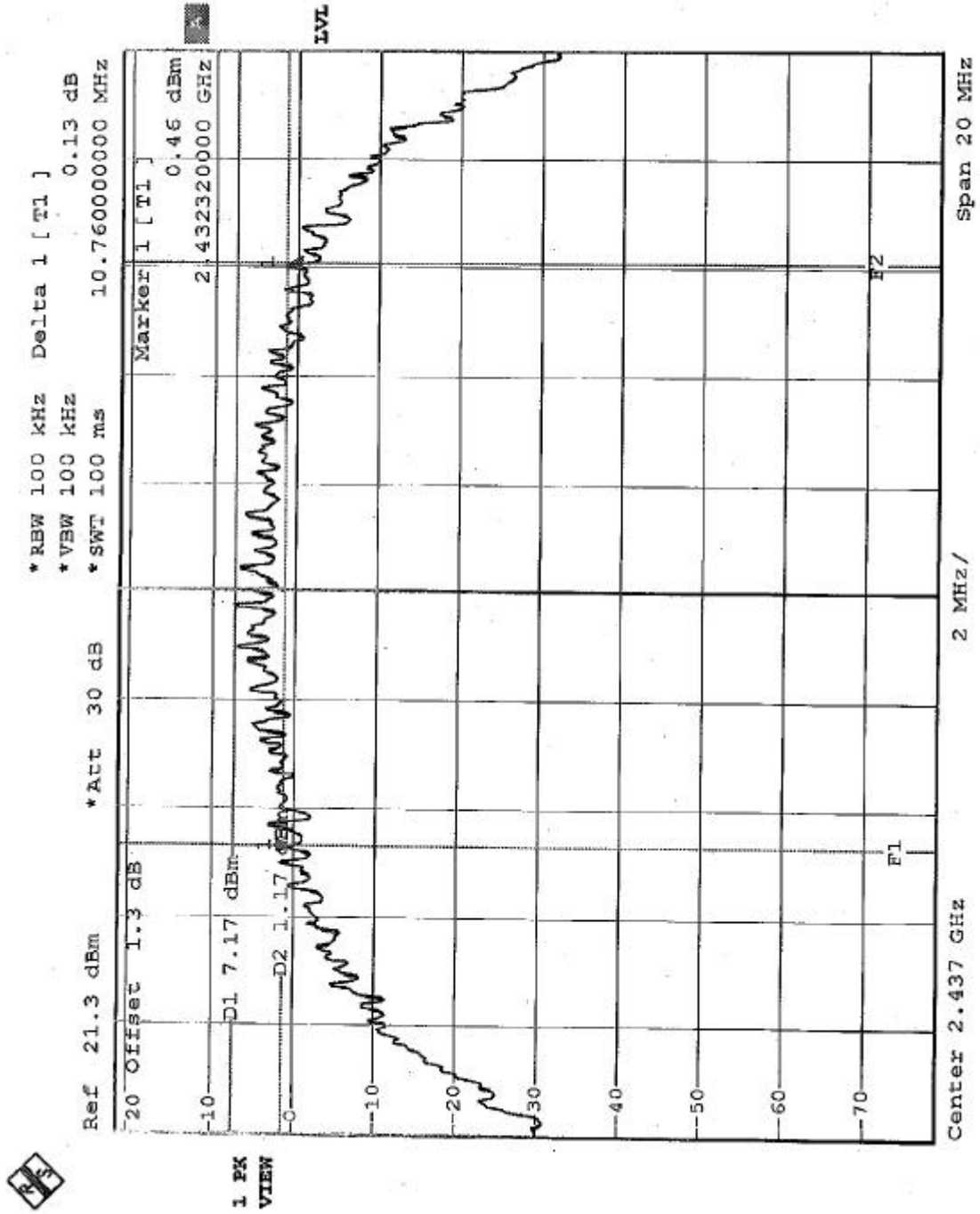



CH11

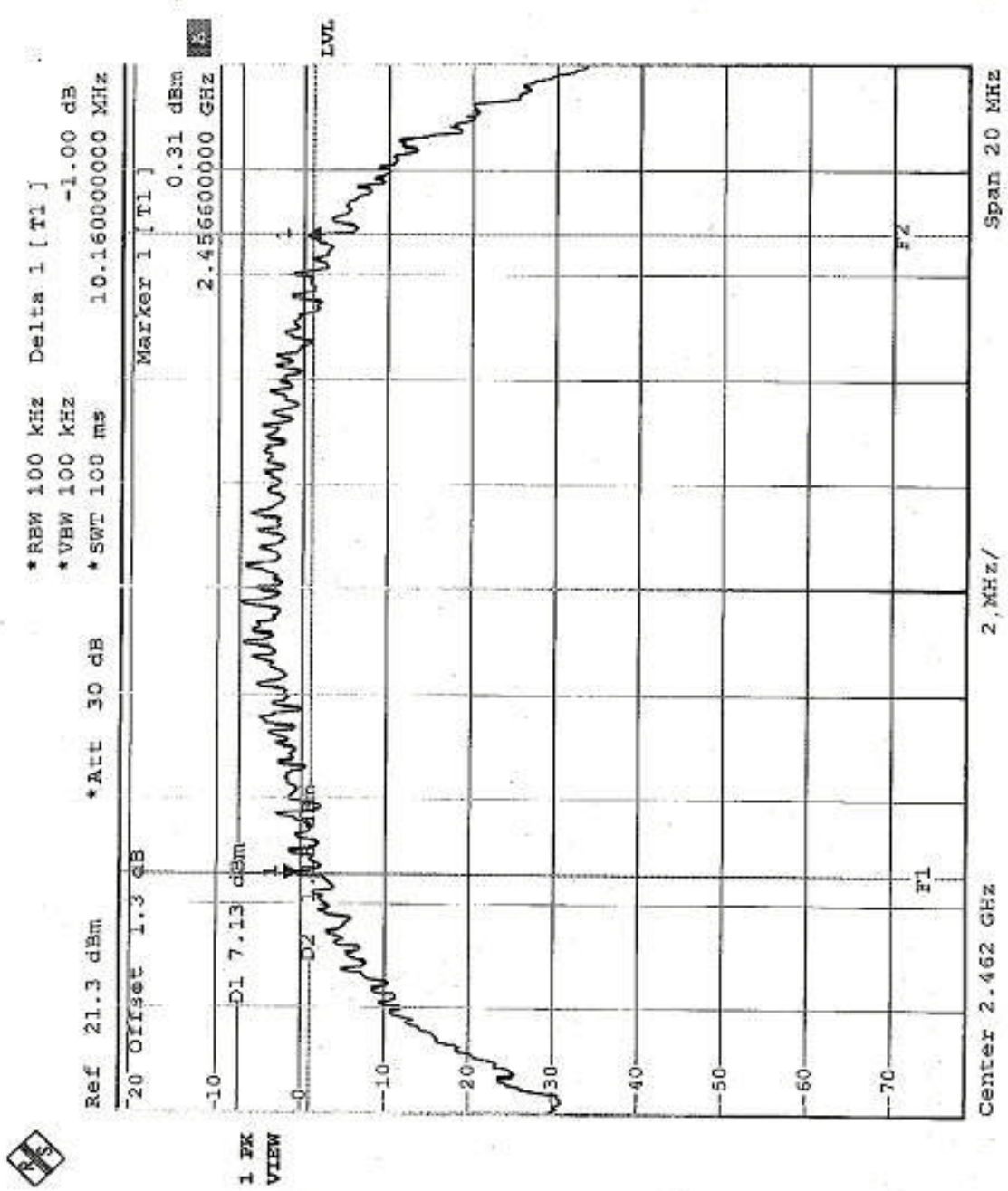



4.4 MAXIMUM PEAK OUTPUT POWER

4.4.1 LIMITS OF MAXIMUM PEAK OUTPUT POWER MEASUREMENT

The Maximum Peak Output Power Measurement is 30dBm.

4.4.2 INSTRUMENTS

Description & Manufacturer	Model No.	Serial No.	Calibrated Until
POWER METER	E4416A	GB41291118	July 30, 2003
PEAK POWER SENSOR	E9327A	US40440722	July 30, 2003

NOTE:

1. The measurement uncertainty is less than +/- 2.6dB, which is calculated as per the NAMAS document NIS81.
2. The calibration interval of the above test instruments is 12 months and the calibrations are traceable to NML/ROC and NIST/USA.

4.4.3 TEST PROCEDURES

The transmitter output was connected to the peak power meter.

4.4.4 DEVIATION FROM TEST STANDARD

No deviation

4.4.5 TEST SETUP

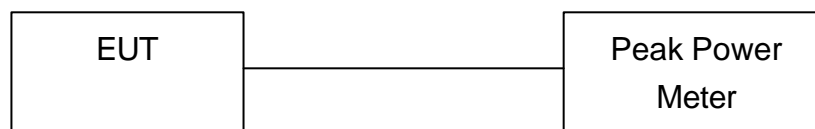

4.4.6 EUT OPERATING CONDITIONS

Same as Item 4.3.6



4.4.7 TEST RESULTS

EUT	WLAN Access Point 2220	MODEL	WLAN Access Point 2220
INPUT POWER (SYSTEM)	120Vac, 60Hz	ENVIRONMENTAL CONDITIONS	19deg. C, 64%RH, 976 hPa
TESTED BY	Hank Chung		

CHANNEL	CHANNEL FREQUENCY (MHz)	PEAK POWER OUTPUT (dBm)	PEAK POWER LIMIT (dBm)	PASS/FAIL
1	2412	14.94	30	PASS
6	2437	15.12	30	PASS
11	2462	14.61	30	PASS



4.5 POWER SPECTRAL DENSITY MEASUREMENT

4.5.1 LIMITS OF POWER SPECTRAL DENSITY MEASUREMENT

The Maximum of Power Spectral Density Measurement is 8dBm.

4.5.2 TEST INSTRUMENTS

Description & Manufacturer	Model No.	Serial No.	Calibrated Until
R&S SPECTRUM ANALYZER	FSP	1093.4495.30	Dec. 19, 2003

NOTE:

- 1.The measurement uncertainty is less than +/- 2.6dB, which is calculated as per the NAMAS document NIS81.
- 2.The calibration interval of the above test instruments is 12 months and the calibrations are traceable to NML/ROC and NIST/USA.

4.5.3 TEST PROCEDURE

The transmitter output was connected to the spectrum analyzer through an attenuator, the bandwidth of the fundamental frequency was measured with the spectrum analyzer using 3 kHz RBW and 30 kHz VBW, set sweep time = span/3 kHz. The power spectral density was measured and recorded.

The sweep time is allowed to be longer than span/3 kHz for a full response of the mixer in the spectrum analyzer.

4.5.4 DEVIATION FROM TEST STANDARD

No deviation

4.5.5 TEST SETUP

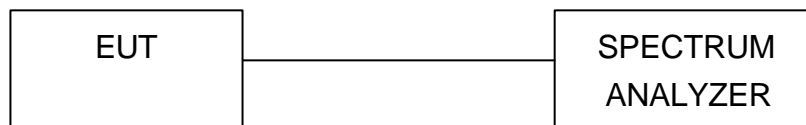

4.5.6 EUT OPERATING CONDITION

Same as Item 4.3.6



4.5.7 TEST RESULTS

EUT	WLAN Access Point 2220	MODEL	WLAN Access Point 2220
INPUT POWER (SYSTEM)	120Vac, 60Hz	ENVIRONMENTAL CONDITIONS	18deg. C, 69RH, 976 hPa
TESTED BY	Hank Chung		

CHANNEL NUMBER	CHANNEL FREQUENCY (MHz)	RF POWER LEVEL IN 3 kHz BW (dBm)	MAXIMUM LIMIT (dBm)	PASS/FAIL
1	2412	-7.23	8	PASS
6	2437	-7.37	8	PASS
11	2462	-7.27	8	PASS



CH1

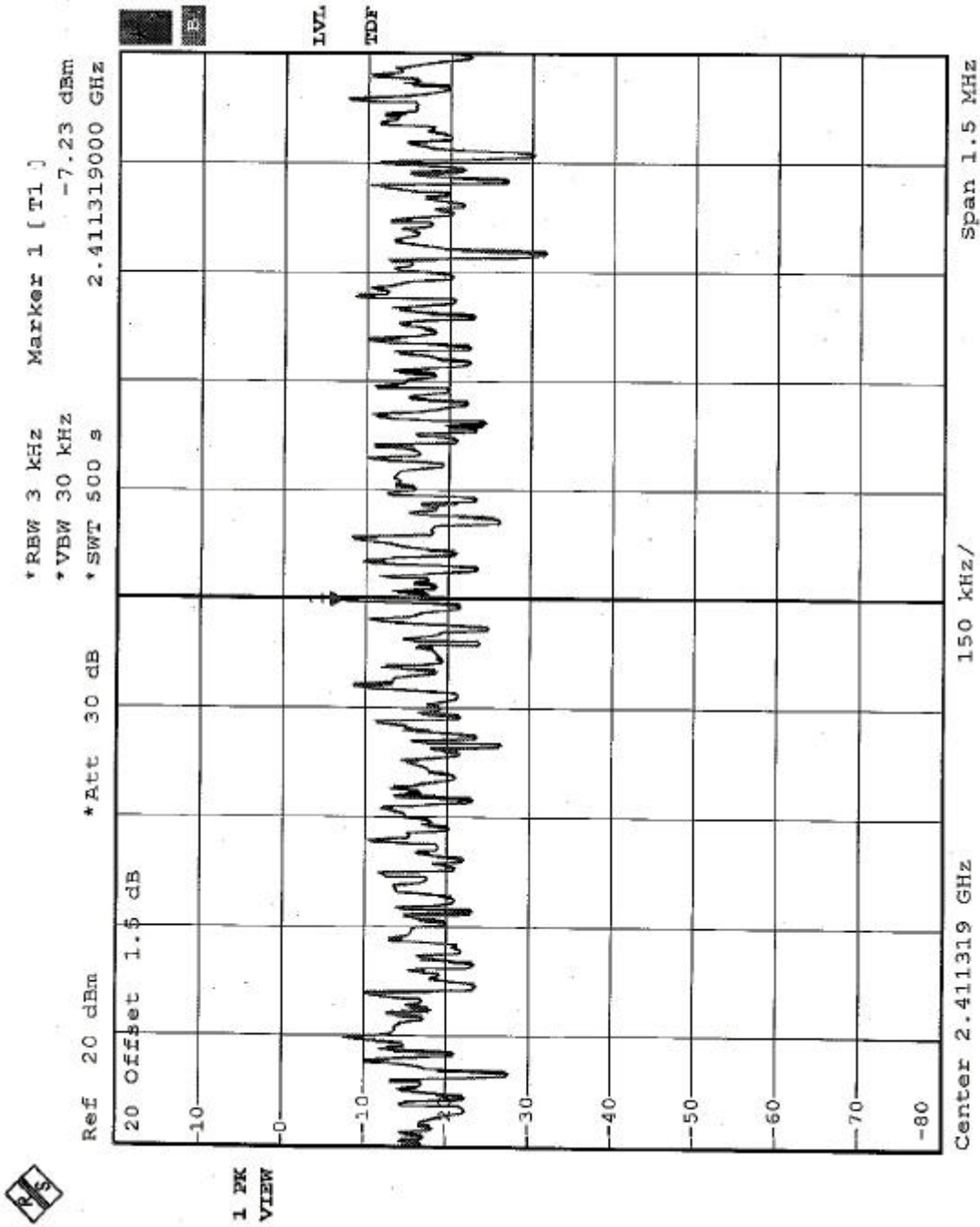



CH6

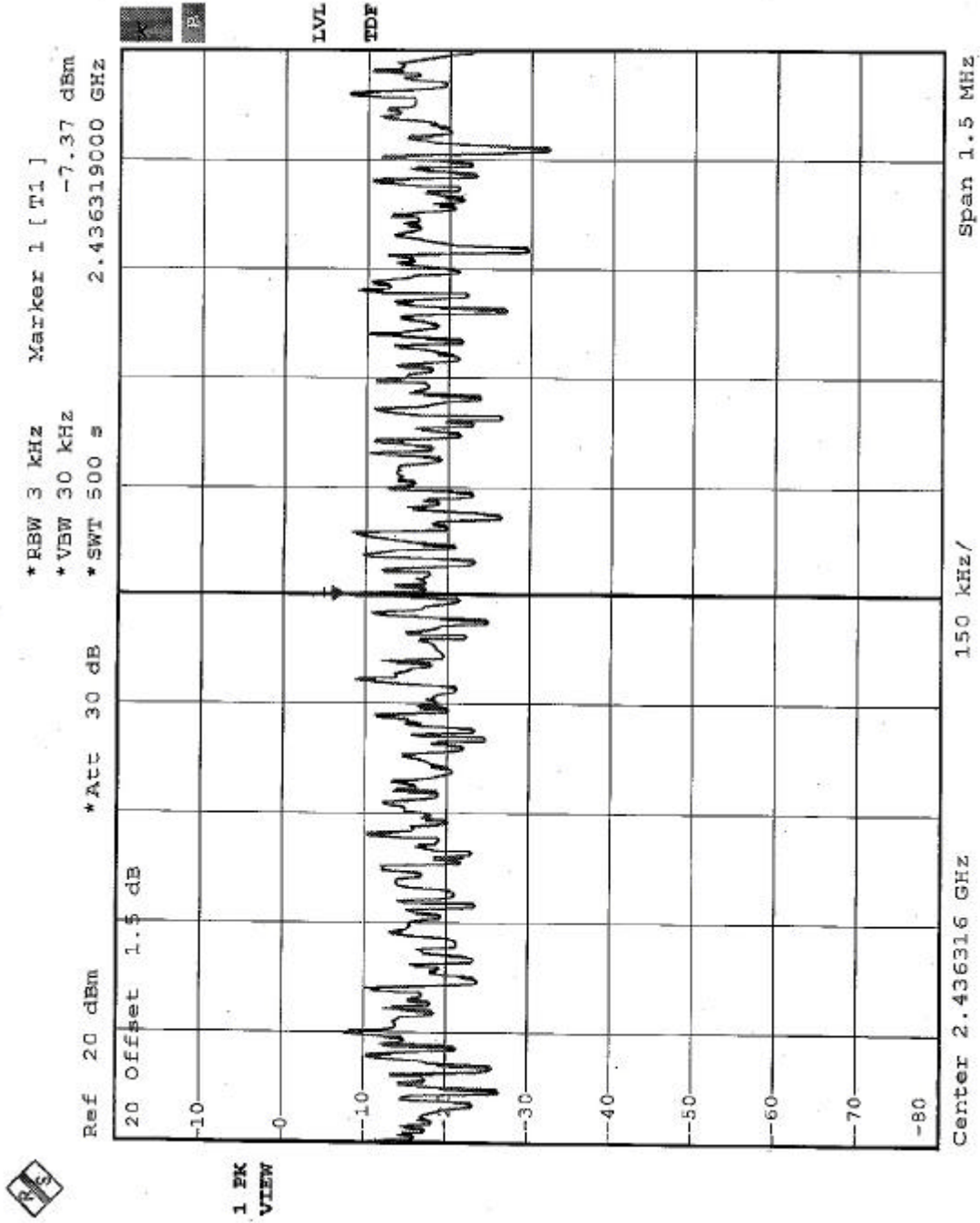



CH11

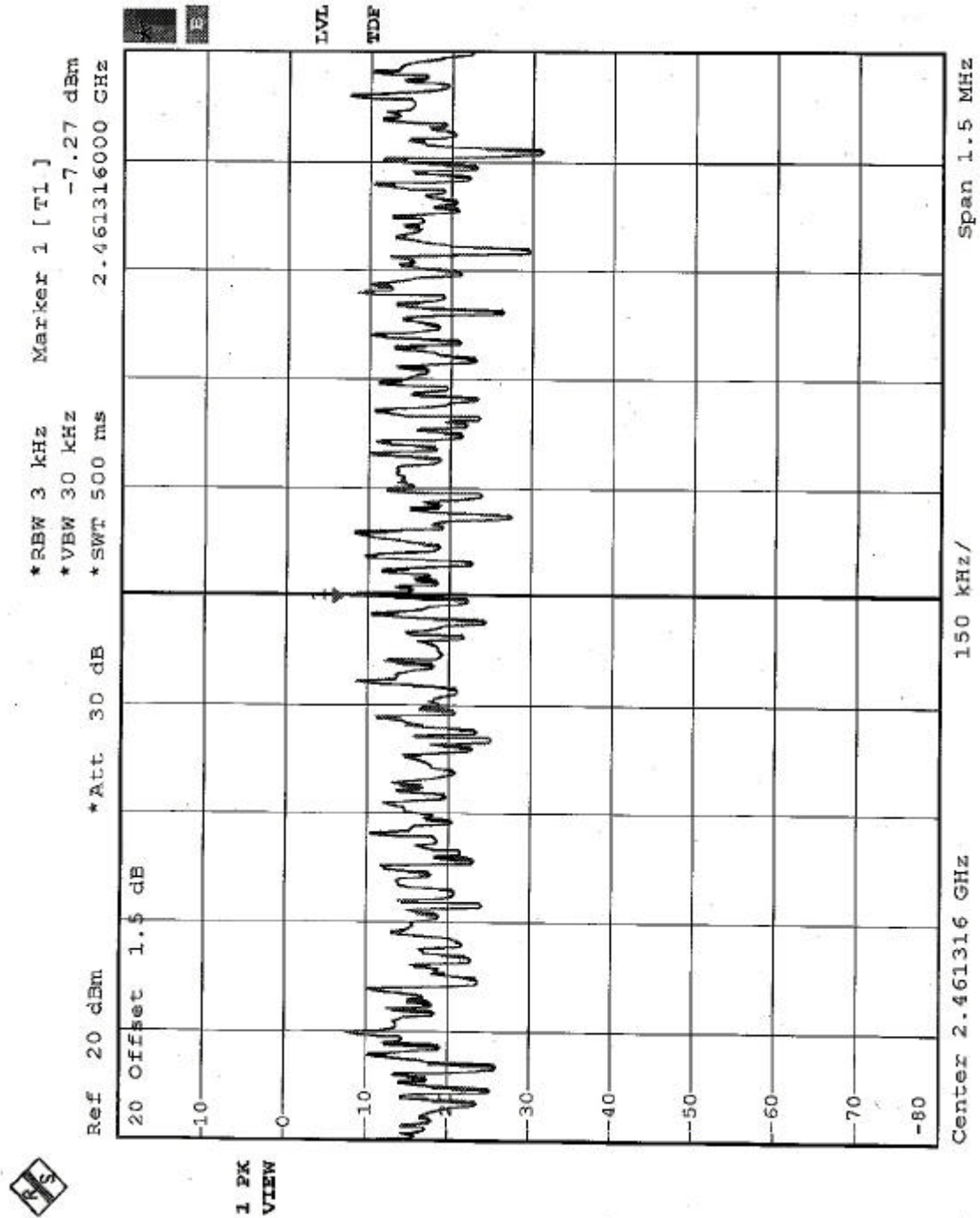



4.6 BAND EDGES MEASUREMENT

4.6.1 LIMITS OF BAND EDGES MEASUREMENT

Below -20dB of the highest emission level of operating band (in 100KHz Resolution Bandwidth).

4.6.2 TEST INSTRUMENTS

Description & Manufacturer	Model No.	Serial No.	Calibrated Until
R&S SPECTRUM ANALYZER	FSP	1093.4495.30	Dec. 19, 2003

NOTE:

- 1.The measurement uncertainty is less than +/- 2.6dB, which is calculated as per the NAMAS document NIS81.
- 2.The calibration interval of the above test instruments is 12 months and the calibrations are traceable to NML/ROC and NIST/USA.

4.6.3 TEST PROCEDURE

The transmitter output was connected to the spectrum analyzer via a low lose cable. Set both RBW and VBW of spectrum analyzer to 100 kHz with suitable frequency span including 100 kHz bandwidth from band edge. The band edges was measured and recorded.

4.6.4 DEVIATION FROM TEST STANDARD

No deviation



4.6.5 EUT OPERATING CONDITION

Same as Item 4.3.6

4.6.6 TEST RESULTS

The spectrum plots are attached on the following 2 pages. D2 line indicates the highest level, and D1 line indicates the 20dB offset below D2. It shows compliance with the requirement in part 15.247(C).

NOTE:

The band edge emission plot on the following two pages shows 52.87 / 52.74 dB delta between carrier maximum power and local maximum emission in restrict band (2.3874 GHz / 2.4860 GHz). The emission of carrier strength list in the test result of channel 11 at the item 4.2.7 (Page 32) is 103.1dBuV/m, so the maximum field strength in restrict band is $103.1 - 52.74 = 50.36$ dBuV/m which is under 54dBuV/m limit.



*RBW 100 kHz Marker 3 [T1]
 *VBW 100 kHz -47.34 dBm
 *SWT 100 ms 2.387400000 GHz

Ref 21.3 dBm *Att 30 dB
 20 Offset 1.3 dB

Marker 1 [T1]	Marker 2 [T1]
-49.38 dBm	2.390000000 GHz
D1 5.53 dBm	-32.34 dBm
	2.400000000 GHz

1 PK VIEW

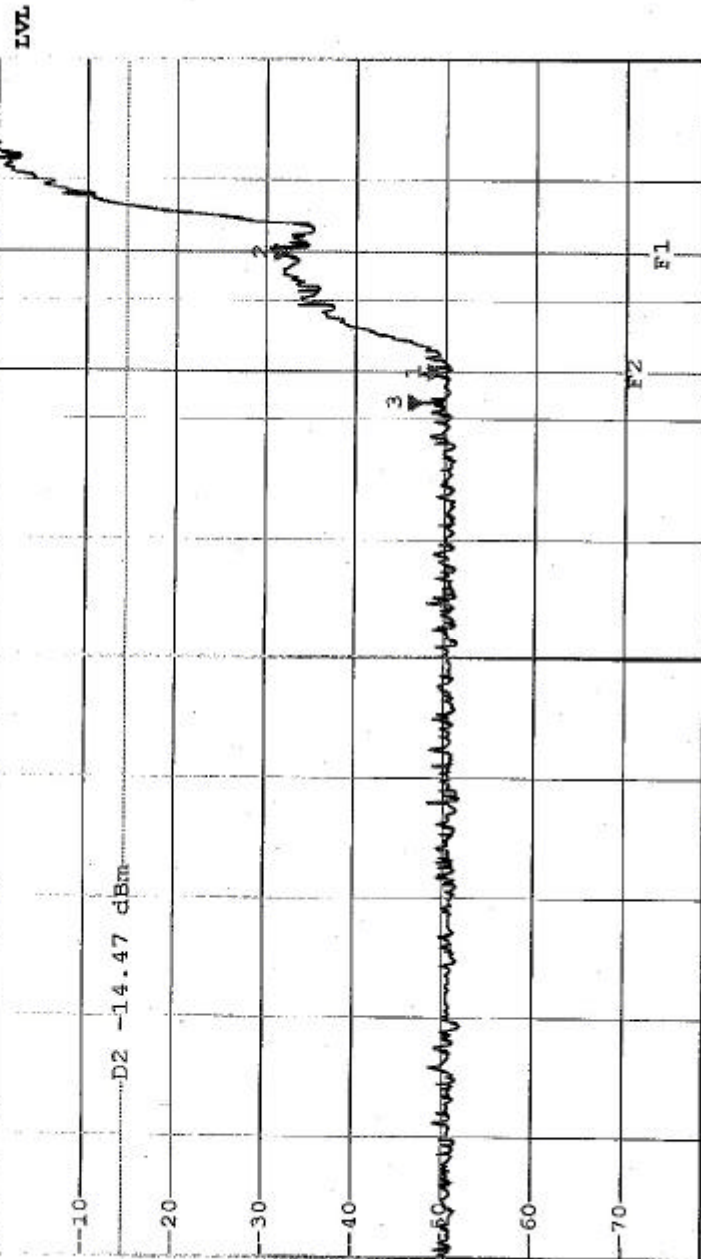

Center 2.366 GHz 10 MHz/ Span 100 MHz

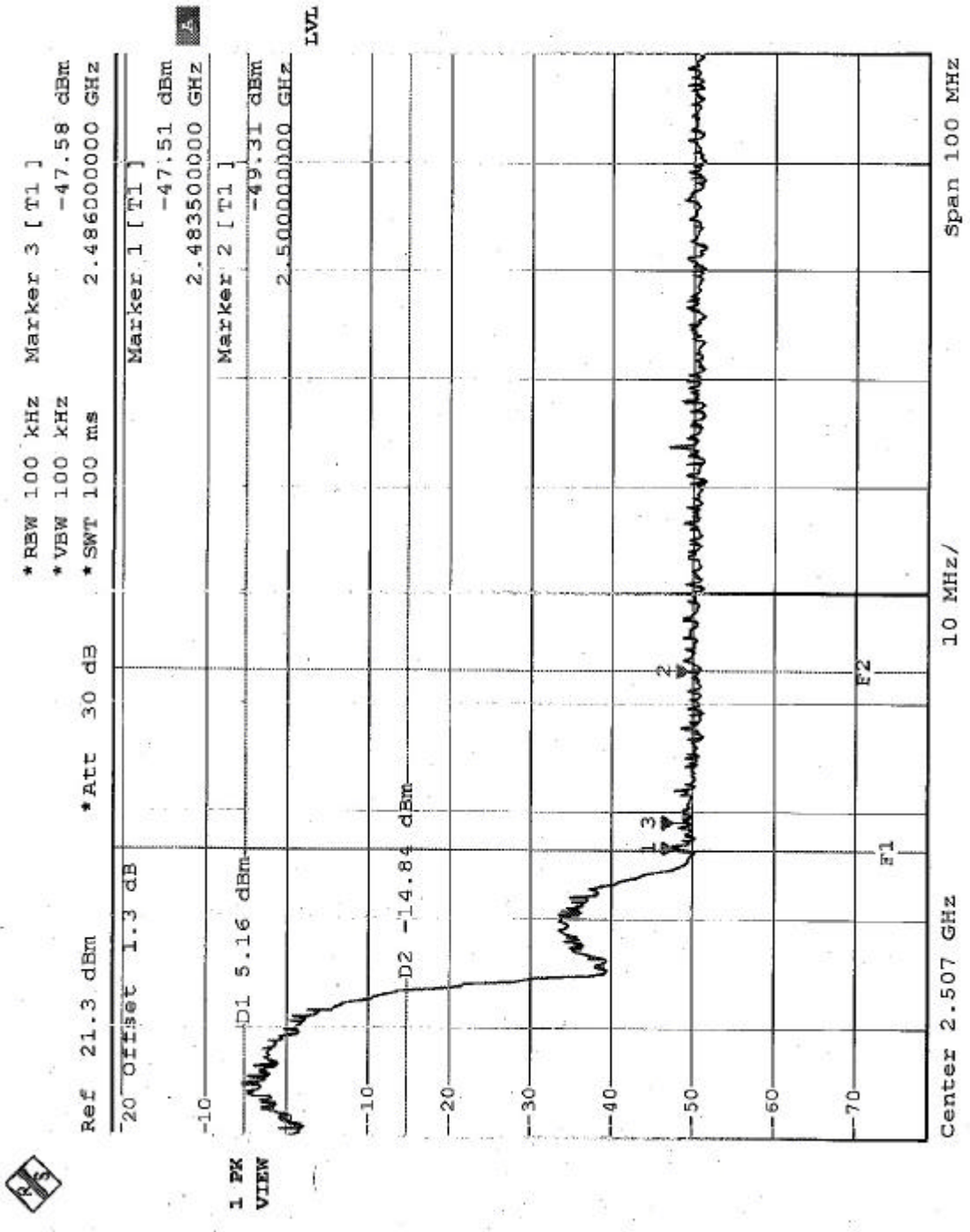



4.7 ANTENNA REQUIREMENT

4.7.1 STANDARD APPLICABLE

For intentional device, according to FCC 47 CFR Section 15.203, an intentional radiator shall be designed to ensure that no antenna other than that furnished by the responsible party shall be used with the device. And according to FCC 47 CFR Section 15.247 (b), if transmitting antennas of directional gain greater than 6dBi are used, the power shall be reduced by the amount in dB that the directional gain of the antenna exceeds 6dBi.

4.7.2 ANTENNA CONNECTED CONSTRUCTION

The antenna used in this product is Integral Antenna with UFL connector. The maximum Gain of the antenna is 1.5dBi.



5. TEST TYPES AND RESULTS (FOR PART 802.11a)

5.1 CONDUCTED EMISSION MEASUREMENT

5.1.1 LIMITS OF CONDUCTED EMISSION MEASUREMENT

FREQUENCY OF EMISSION (MHz)	CONDUCTED LIMIT (dB μ V)	
	Quasi-peak	Average
0.15-0.5	66 to 56	56 to 46
0.5-5	56	46
5-30	60	50

- NOTE:**
1. The lower limit shall apply at the transition frequencies.
 2. The limit decreases in line with the logarithm of the frequency in the range of 0.15 to 0.50 MHz.
 3. All emanations from a class A/B digital device or system, including any network of conductors and apparatus connected thereto, shall not exceed the level of field strengths specified above.

5.1.2 TEST INSTRUMENTS

DESCRIPTION & MANUFACTURER	MODEL NO.	SERIAL NO.	CALIBRATED UNTIL
ROHDE & SCHWARZ Test Receiver	ESCS 30	847124/029	Nov. 17, 2003
ROHDE & SCHWARZ LISN (for EUT)	ESHS-Z5	848773/004	Nov. 13, 2003
KYORITSU LISN (for peripheral)	KNW-407	8/1395/12	Jul. 23, 2003
RF Cable (JETBAO)	RG233/U	Cable_CA_01	Jul. 03, 2003
Terminator(for KYORITSU)	50	3	Apr. 11, 2003
Software	Cond-V2e	NA	NA

- NOTE: 1. The calibration interval of the above test instruments is 12 months and the calibrations are traceable to NML/ROC and NIST/USA.
3. The test was performed in ADT Shielded Room No. A.
3. The VCCI Con A Registration No. is C-817.



5.1.3 TEST PROCEDURES

- a. The EUT was placed 0.4 meters from the conducting wall of the shielded room with EUT being connected to the power mains through a line impedance stabilization network (LISN). Other support units were connected to the power mains through another LISN. The two LISNs provide 50 ohm/ 50uH of coupling impedance for the measuring instrument.
- b. Both lines of the power mains connected to the EUT were checked for maximum conducted interference.
- c. The frequency range from 150 kHz to 30 MHz was searched. Emission levels over 10dB under the prescribed limits could not be reported

5.1.4 DEVIATION FROM TEST STANDARD

No deviation

5.1.5 TEST SETUP

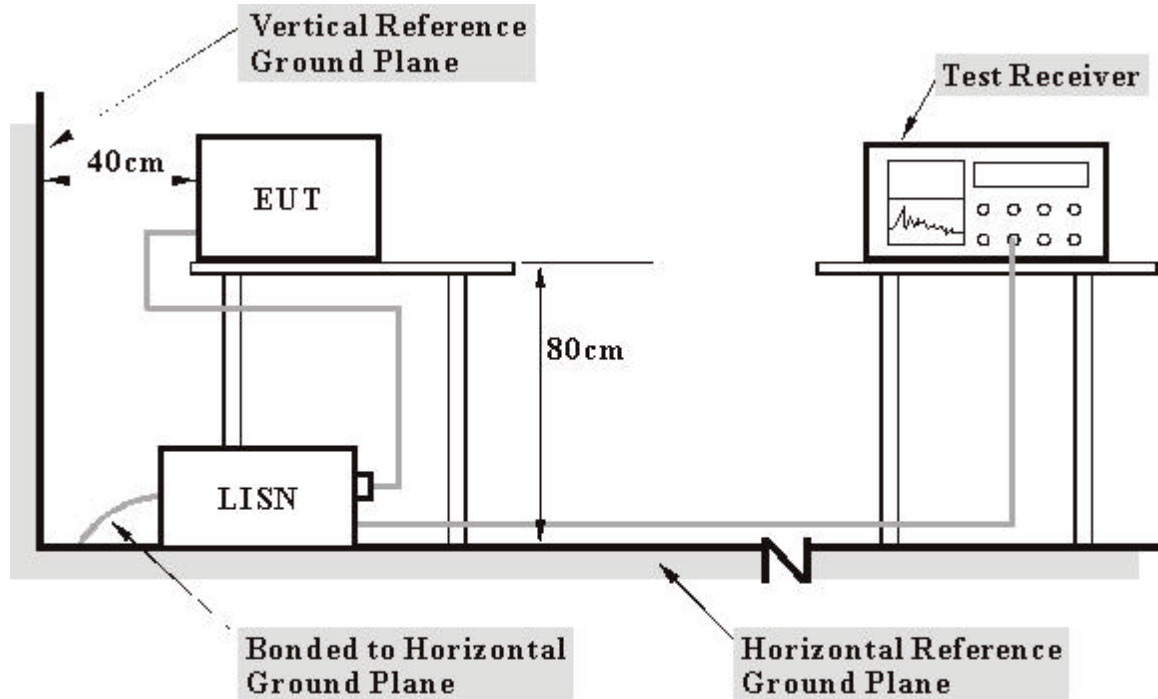

- Note:**
1. Support units were connected to second LISN.
 2. Both of LISNs (AMN) 80 cm from EUT and at the least 80 cm from other units and other metal planes support units.

For the actual test configuration, please refer to the related item – Photographs of the Test Configuration.

5.1.6 EUT OPERATING CONDITIONS

Same as 4.1.6.



5.1.7 TEST RESULTS

EUT	WLAN Access Point 2220	MODEL	WLAN Access Point 2220
		6dB BANDWIDTH	9 kHz
INPUT POWER (SYSTEM)	120Vac, 60 Hz	PHASE	Line (L)
ENVIRONMENTAL CONDITIONS	25deg. C, 60RH, 976 hPa	TESTED BY	Mike Hsieh

No	Freq. [MHz]	Corr. Factor (dB)	Reading Value [dB (uV)]		Emission Level [dB (uV)]		Limit [dB (uV)]		Margin (dB)	
			Q.P.	AV.	Q.P.	AV.	Q.P.	AV.	Q.P.	AV.
			1	0.197	0.10	46.02	-	46.12	-	63.74
2	0.295	0.10	30.96	-	31.06	-	60.40	50.40	-29.34	-
3	1.150	0.10	31.01	-	31.11	-	56.00	46.00	-24.89	-
4	2.466	0.12	26.56	-	26.68	-	56.00	46.00	-29.32	-
5	15.469	0.82	30.11	-	30.93	-	60.00	50.00	-29.07	-
6	28.688	1.20	29.61	-	30.81	-	60.00	50.00	-29.19	-

- NOTES: (1) "***": Undetectable
 (2) Q.P. and AV. are abbreviations of quasi-peak and average.
 (3) "-": The Quasi-peak reading value also meets an average limit, thus measurement with the average detector is unnecessary.
 (4) The emission levels of other frequencies were very low against the limit.
 (5) Correction Factor = Insertion loss + Cable loss
 (6) Margin value = Emission level - Limit value

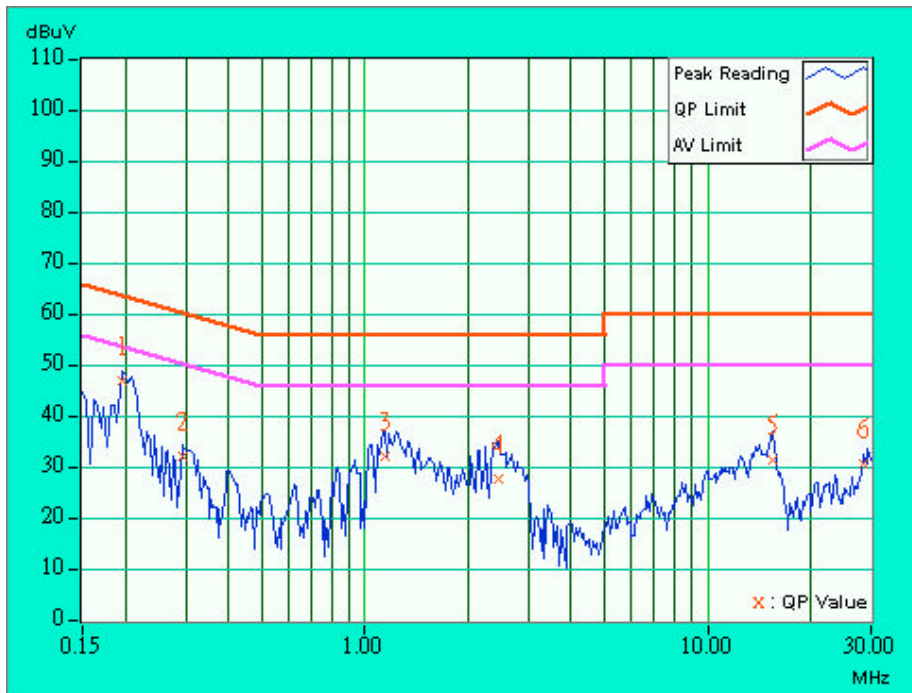



EUT	WLAN Access Point 2220	MODEL	WLAN Access Point 2220
		6dB BANDWIDTH	9 kHz
INPUT POWER (SYSTEM)	120Vac, 60 Hz	PHASE	Neutral (N)
ENVIRONMENTAL CONDITIONS	25deg. C, 60RH, 976 hPa	TESTED BY	Mike Hsieh

No	Freq. [MHz]	Corr. Factor (dB)	Reading Value [dB (uV)]		Emission Level [dB (uV)]		Limit [dB (uV)]		Margin (dB)	
			Q.P.	AV.	Q.P.	AV.	Q.P.	AV.	Q.P.	AV.
			1	0.197	0.10	45.86	-	45.96	-	63.74
2	0.314	0.10	31.52	-	31.62	-	59.86	49.86	-28.24	-
3	1.228	0.10	33.83	-	33.93	-	56.00	46.00	-22.07	-
4	2.463	0.12	26.18	-	26.30	-	56.00	46.00	-29.70	-
5	15.488	0.61	30.13	-	30.74	-	60.00	50.00	-29.26	-
6	28.688	0.90	30.51	-	31.41	-	60.00	50.00	-28.59	-

- NOTES: (1) "": Undetectable
 (2) Q.P. and AV. are abbreviations of quasi-peak and average.
 (3) "-": The Quasi-peak reading value also meets an average limit, thus measurement with the average detector is unnecessary.
 (4) The emission levels of other frequencies were very low against the limit.
 (5) Correction Factor = Insertion loss + Cable loss
 (6) Margin value = Emission level - Limit value

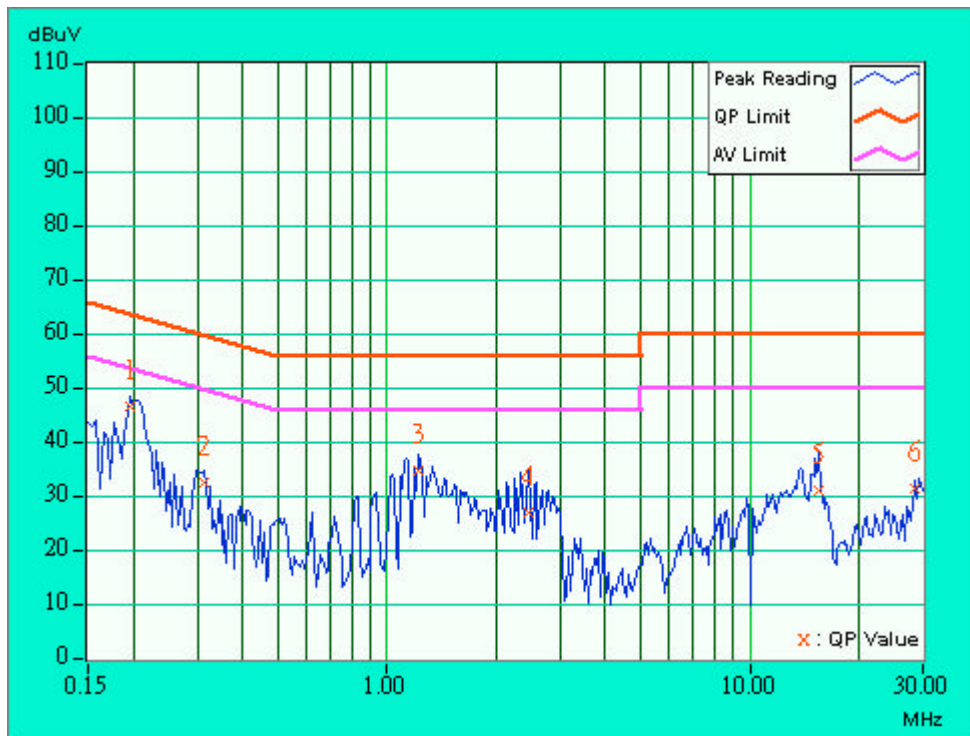



5.2 RADIATED EMISSION MEASUREMENT

5.2.1 LIMITS OF RADIATED EMISSION MEASUREMENT

Emissions radiated outside of the specified bands, shall be according to the general radiated limits in 15.209 as following:

Frequencies (MHz)	Field strength (microvolts/meter)	Measurement distance (meters)
0.009-0.490	2400/F(kHz)	300
0.490-1.705	24000/F(kHz)	30
1.705-30.0	30	30
30-88	100	3
88-216	150	3
216-960	200	3
Above 960	500	3

NOTE:

1. The lower limit shall apply at the transition frequencies.
2. Emission level (dBuV/m) = 20 log Emission level (uV/m).
3. As shown in 15.35(b), for frequencies above 1000MHz, the field strength limits are based on average detector, however, the peak field strength of any emission shall not exceed the maximum permitted average limits, specified above by more than 20dB under any condition of modulation.



5.2.2 LIMITS OF UNWANTED EMISSION OUT OF THE RESTRICTED BANDS

Frequencies (MHz)	EIRP Limit (dBm)	Equivalent Field Strength at 3m (dB μ V/m) *note 3
5150~5250	-27	68.3
5250~5350	-27	68.3
5725~5825	-27 *note 1	68.3
	-17 *note 2	78.3

NOTE:

1. For frequencies 10MHz or greater above or below the band edge.
2. All emissions within the frequency range from the band edge to 10MHz above or below the band edge.
3. The following formula is used to convert the equipment isotropic radiated power (eirp) to field strength

$$E = \frac{1000000 \sqrt{30P}}{3} \quad \mu\text{V/m, where P is the eirp (Watts)}$$



5.2.3 TEST INSTRUMENTS

DESCRIPTION & MANUFACTURER	MODEL NO.	SERIAL NO.	CALIBRATED UNTIL
HP Spectrum Analyzer	8594ER	3829U04676	Jul. 14, 2003
ADVANTEST Spectrum Analyzer	R3271A	85060311	May 21, 2003
CHASE RF Pre_Amplifier	CPA9232	1057	Apr. 24, 2003
HP Pre_Amplifier	8449B	3008A01281	June 27, 2003
ROHDE & SCHWARZ Test Receiver	ESVS 10	849231 /019	Nov. 03, 2003
CHASE Broadband Antenna	CBL6111c	2730	Jul 17, 2003
Schwarzbeck Horn_Antenna	BBHA9120-D1	D123	Jul. 31, 2003
SCHWARZBECK Tunable Dipole Antenna	UHAP	897	Mar. 07, 2005
SCHWARZBECK Tunable Dipole Antenna	VHAP	880	Mar. 07, 2005
RF Switches (ARNITSU)	CS-201	1565157	Jul. 29, 2003
RF CABLE (Chaintek) 1GHz-20GHz	Ak 9515-D	001	Aug. 20.2003
RF Cable(RICHTEC)	9913-30M	STCCAB-30M- 1GHz-021	Nov. 5, 2003
Software	AS60P8	NA	NA
CHANCE MOST Antenna Tower	AT-100	0203	NA
CHANCE MOST Turn Table	TT-100	0203	NA

Note: 1. The calibration interval of the above test instruments is 12 months and the calibrations are traceable to NML/ROC and NIST/USA.

2. * = These equipment are used for the final measurement.
3. The horn antenna and HP preamplifier (model: 8449B) are used only for the measurement of emission frequency above 1GHz if tested.
4. The test was performed in ADT Open Site No. C.
5. The FCC Site Registration No. is 656396.
6. The VCCI Site Registration No. is R-1626.